SHARP®

Carousel
MICROWAVE OVEN

OPERATION MANUAL

MODELS

R-9H94B
R-9H84B
R-9H76
R-9H66

Read all instructions carefully before using these ovens.



PRECAUTIONS TO AVOID POSSIBLE EXPOSURE TO EXCESSIVE MICROWAVE ENERGY

- (a) Do not attempt to operate this oven with the door open since open-door operation can result in harmful exposure to microwave energy. It is important not to defeat or tamper with the safety interlocks.
- (b) Do not place any object between the oven front face and the door or allow soil or cleaner residue to accumulate on sealing surfaces.
- (c) Do not operate the oven if it is damaged. It is particularly important that the oven door close properly and that there is no damage to the: (1) door (bent), (2) hinges and latches (broken or loosened), (3) door seals and sealing surfaces.
- (d) The oven should not be adjusted or repaired by anyone except properly qualified service personnel.

FOR CUSTOMER ASSISTANCE

To aid in reporting this microwave oven in case of loss or theft, please record below the model number and serial number located on the unit. We also suggest you record all the information listed and retain for future reference.

MODEL NUMBER _____ SERIAL NUMBER _____
DATE OF PURCHASE _____
Dealer _____ Telephone _____
Servicer _____ Telephone _____

TO PHONE: DIAL 1 - 800 - BE - SHARP (23 - 74277) for :

SERVICE (for your nearest Sharp Authorized Servicer)
PARTS (for your authorized parts distributor)
ACCESSORIES
ADDITIONAL
CUSTOMER INFORMATION

DIAL 201 529 - 8703 for :

COOKING ASSISTANCE

TO WRITE:

For cooking and operation questions:

Susan Edwards/Test Kitchen
Sharp Electronics Corporation
Sharp Plaza, Box 650
Mahwah, NJ 07430-2135

For service problems, warranty information, missing items and other assistance:

Sharp Electronics Corporation
Customer Information Center
Sharp Plaza, Box 650
Mahwah, NJ 07430-2135

Please provide the following information when you write or call: model number, serial number, date of purchase, your complete mailing address (including zip code), your daytime telephone number (including area code) and description of the problem.

CONTENTS

Precautions to Avoid Possible	
Exposure to Excessive	
Microwave Energy Inside front cover	
For Customer Assistance Inside front cover	
Contents 1	
Limited Warranty 2	
Product Information Card 2	
Important Safety Instructions 3	
Unpacking and Installation Instructions 4	
Grounding Instructions 5	
Information You Need to Know 6	
About Your Oven 6	
About Food 6	
About Utensils and Coverings 7	
About Microwave cooking 8	
About Safety 8	
About Children and the Microwave 8	
Part Names 9	
Before Operating 10	
To Set the Clock 10	
Stop/Clear 10	
Manual Operation 10	
Microwave Cooking 10	
Time Cooking 10	
Convection and Automatic Mix Cooking 11	
Convection Cooking 11	
Automatic Mix Cooking 11	
To Preheat and then Cook with Convection 12	
To Preheat with Automatic Mix 12	
Broil Cooking 13	
Slow Cook 13	
Special Features 14	
CompuDefrost 14	
CompuDefrost Chart 14	
Manual Defrost 15	
Beverage Reheat 15	
Sensor Cooking 15	
Instant Sensor 16	
Dinner Plate 16	
Popcorn 16	
Sensor Reheat 16	
Instant Sensor Chart 16	
Sensor Cook 17	
Sensor Cook Chart 17	
Sensor Cook Recipes 18	
CompuCook 20	
CompuCook Chart 20	
Cook & Simmer 21	
Other Convenient Features 21	
Multiple Sequence Cooking 21	
More or Less Time Adjustment 21	
Minute Timer/Pause/Minute Plus/Auto Start 22	
Memory Plus/ Safety Lock 23	
Audible Signal Elimination/ Demonstration Mode 23	
Service Call Check 23	
Cleaning and Care 24	
Specifications 24	
Auto-Touch Guide 25, 26	

LIMITED WARRANTY

SHARP ELECTRONICS CORPORATION warrants to the first consumer purchaser that this Sharp brand product (the "Product"), when shipped in its original container, will be free from defective workmanship and materials and agrees that it will, at its option, either repair the defect or replace the defective Product or part thereof at no charge to the purchaser for parts or labor for the time period(s) set forth below.

This warranty does not apply to any appearance items of the Product nor to the additional excluded item(s) set forth below nor to any Product the exterior of which has been damaged or defaced, which has been subjected to misuse, abnormal service or handling or which has been altered or modified in design or construction.

In order to enforce the right under this limited warranty, the purchaser should follow the steps set forth below and provide proof of purchase to the servicer.

The limited warranty described herein is in addition to whatever implied warranties may be granted to purchasers by law. ALL IMPLIED WARRANTIES INCLUDING THE WARRANTIES OF MERCHANTABILITY AND FITNESS FOR USE ARE LIMITED TO THE PERIOD(S) FROM THE DATE OF PURCHASE SET FORTH BELOW. Some states do not allow limitations on how long an implied warranty lasts, so the above limitation may not apply to you.

Neither the sales personnel of the seller nor any other person is authorized to make any warranties other than those described herein or to extend the duration of any warranties beyond the time period described herein on behalf of Sharp.

The warranties described herein shall be the sole and exclusive warranties granted by Sharp and shall be the sole and exclusive remedy available to the purchaser. Correction of defects, in the manner and for the period of time described herein, shall constitute complete fulfillment of all liabilities and responsibilities of Sharp to the purchaser with respect to the Product and shall constitute full satisfaction of all claims, whether based on contract, negligence, strict liability or otherwise. In no event shall Sharp be liable, or in any way responsible, for any damages or defects in the Product which were caused by repairs or attempted repairs performed by anyone other than an authorized servicer. Nor shall Sharp be liable, or in any way responsible, for any incidental or consequential economic or property damage. Some states do not allow the exclusion of incidental or consequential damages, so the above exclusion may not apply to you.

THE WARRANTY GIVES YOU SPECIFIC LEGAL RIGHTS. YOU MAY ALSO HAVE OTHER RIGHTS WHICH VARY FROM STATE TO STATE.

Your Product model number: R-9H94B, R-9H84B, R-9H76 and R-9H66 Home Use Carousel Microwave Oven

(Be sure to have this information available when you need service for your Product.)

Warranty period for this Product: one (1) year parts and labor. The warranty period continues for an additional four (4) years, for a total of five (5) years, with respect to the magnetron tube in the Product for parts only. Labor is not provided free of charge for this additional period.

Additional items excluded from warranty coverage: accessories, rubber or plastic parts, the turntable, light bulbs, glass parts or any printed materials.

Where to obtain service: at a Sharp Authorized Servicer or Sharp Authorized Service Dealer located in the United States. To find out the location of the nearest Sharp Authorized Servicer or Dealer, call Sharp toll free at 1-800-BE-SHARP.

What to do to obtain service: ship (prepaid) or carry in your Product to a Sharp Authorized Servicer or Dealer. If you ship or mail the product, be sure it is packaged carefully. If your product is built-in, you may obtain in-home service during the initial one-year warranty period by contacting your Servicer or Dealer. The servicer will come to your home and if it is necessary to remove the product, the servicer will reinstall it. Be sure to have proof of purchase available.

PRODUCT INFORMATION CARD

The product information card which is on the inside of the microwave oven carton should be completed within ten days of purchase and returned. We will keep it on file and help you access the information in case of loss, damage or theft. This will also enable us to contact you in the unlikely event that any adjustments or modifications are ever required for your oven.

IMPORTANT SAFETY INSTRUCTIONS

When using electrical appliances basic safety precautions should be followed, including the following:

WARNING - To reduce the risk of burns, electric shock, fire, injury to persons or exposure to excessive microwave energy:

1. Read all instructions before using the appliance.
2. Read and follow the specific "PRECAUTIONS TO AVOID POSSIBLE EXPOSURE TO EXCESSIVE MICROWAVE ENERGY" on inside front cover.
3. This appliance must be grounded. Connect only to properly grounded outlet. See "GROUNDING INSTRUCTIONS" on page 5.
4. Install or locate this appliance only in accordance with the provided installation instructions.
5. Some products such as whole eggs and sealed containers -- for example, closed glass jars -- may explode and should not be heated in this oven.
6. Use this appliance only for its intended use as described in this manual. Do not use corrosive chemicals or vapors in this appliance. This type of oven is specifically designed to heat, cook or dry food. It is not designed for industrial or laboratory use.
7. As with any appliance, close supervision is necessary when used by children.
8. Do not operate this appliance if it has a damaged cord or plug, if it is not working properly or if it has been damaged or dropped.
9. This appliance should be serviced only by qualified service personnel. Contact nearest Sharp Authorized Servicer or Dealer for examination, repair or adjustment.
10. Do not cover or block any openings on the appliance.
11. Do not store or use this appliance outdoors. Do not use this product near water--for example, near a kitchen sink, in a wet basement or near a swimming pool, and the like.
12. Do not immerse cord or plug in water.
13. Keep cord away from heated surfaces.
14. Do not let cord hang over edge of table or counter.
15. See door surface cleaning instructions on page 24.
16. To reduce the risk of fire in the oven cavity:
 - a. Do not overcook food. Carefully attend appliance if paper, plastic or other combustible materials are placed inside the oven to facilitate cooking.
 - b. Remove wire twist-ties from paper or plastic bags before placing bag in oven.
 - c. **If materials inside the oven should ignite, keep oven door closed, turn oven off and disconnect the power cord or shut off power at the fuse or circuit breaker panel.**
 - d. Do not use the cavity for storage purposes. Do not leave paper products, cooking utensils or food in the cavity when not in use.
17. Do not operate any heating or cooking appliance beneath this appliance.
18. Do not mount unit over or near any portion of a heating or cooking appliance.
19. Do not mount over a sink.
20. Do not store anything directly on top of the appliance surface when the appliance is in operation.
21. Models R-9H76 and R-9H66 are suitable for built-in installation over only General Electric's wall oven models ZEK734GP and ZEK735WP.

SAVE THESE INSTRUCTIONS

UNPACKING AND INSTALLATION INSTRUCTIONS

Unpacking and Examining Your Oven

Remove:

1. all packing materials from inside the oven cavity. Read enclosures and **SAVE** the Operation Manual.
2. the feature sticker from the outside of the door, if there is one.

Check the oven for any damage, such as misaligned or bent door, damaged door seals and sealing surfaces, broken or loose door hinges and latches and dents inside the cavity or on the door. If there is any damage, do not operate the oven and contact your dealer or SHARP AUTHORIZED SERVICER.

Choosing a Location for Your Oven

You will use your oven frequently so plan its location for ease of use. The oven must be placed on a countertop which is a minimum of 36 inches from the floor. Allow at least 2 inches on the sides, top and at the rear of the oven for air circulation. Be sure to position oven so that the rear cannot be touched inadvertently.

R-9H84B/-9H94B

Do not place or install the oven in any area where heat and steam are generated; for example, next to or above a conventional gas or electric range or above any wall oven. Heat and steam may damage the electronics or the mechanical parts of the oven.

Your oven can be built into a cabinet or wall - not near or above a heat source-using Sharp's Built-in Kit, Model RK-90W for the R-9H94B oven and Model RK-90 for the R-9H84B oven.

R-9H66/-9H76

Your oven can be built into a cabinet or wall by itself or above applicable General Electric brand wall ovens using Sharp's Built-in Kits RK-66A for R-9H76 or RK-66W for R-9H66. It cannot be built in above conventional gas or electric ranges or any other wall ovens.

Applicable General Electric brand wall ovens

ZEK734GP ZEK735WP

See Sketch 1 for proper location when building in above the specified G.E. wall ovens. Carefully follow both the G.E. wall oven installation instructions and Sharp's Built-in Kit instructions. Be sure that the clearance of the floor between the wall oven and the microwave oven is min. 1-1/2 inches.

Ordering the Built-in Kits.

If your dealer does not stock the kit, it can be ordered directly from the Sharp Accessories and Supplies Center. Have your credit card number available and call toll-free: 1-800-BE-SHARP for ordering the kit or be sent to your address.

The kit includes ducts and finish trim strips and easy-to-follow instructions for installation as well as the location of the power supply.

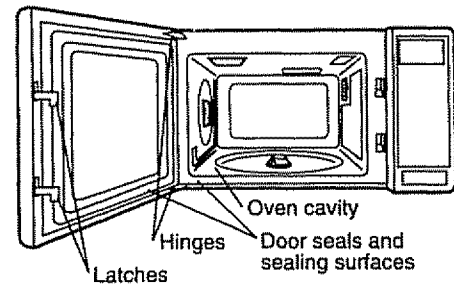

(R-9H76, R-9H66)

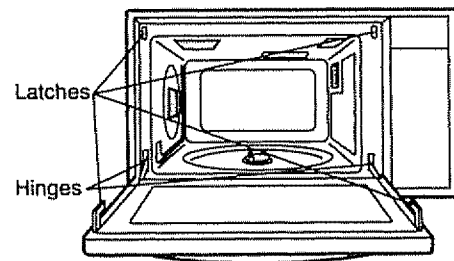

(R-9H94B, R-9H84B)

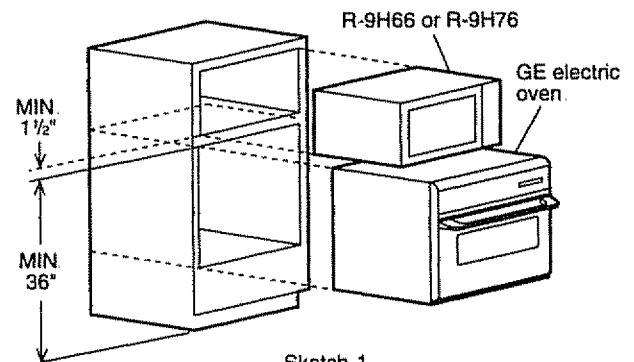

GROUNDING INSTRUCTIONS

It is important that all instructions for electrical connection and grounding be followed to eliminate any hazard or chance of electrical short circuit. Grounding reduces the risk of electric shock by providing an escape wire for the electric current.

All electrical work must be in accordance with the National Electrical Code and all local codes and ordinances.

WARNING – Improper use of the grounding plug can result in a risk of electric shock.

Electrical Requirements

The electrical requirements are a 120 volt 60 Hz, AC only, 15 amp. or more fused electrical supply. It is recommended that a separate circuit serving only the oven be provided.

The oven is equipped with a 3-prong grounding plug. It must be plugged into a wall receptacle that is properly installed and grounded. Should you only have a 2-prong outlet, have a qualified electrician install a correct wall receptacle.

A 3-prong adapter may be purchased and used temporarily if local codes allow. Follow package directions.

A short power-supply cord is provided to reduce risk of becoming entangled in or tripping over a longer cord.

Extension Cord

If it is necessary to use an extension cord, use only a 3-wire extension cord that has a 3-blade grounding plug and a 3-slot receptacle that will accept the plug on the microwave oven. The marked rating of the extension cord should be AC 115-120 volt, 15 amp. or more.

Be careful not to drape the cord over the countertop or table where it can be pulled on by children or tripped over accidentally.

Note:

1. If you have any questions about the grounding or electrical instructions, consult a qualified electrician or serviceman.
2. Neither Sharp nor the dealer can accept any liability for damage to the oven or personal injury resulting from failure to observe the correct electrical connection procedures.

Radio or TV Interference

Should there be any interference caused by the microwave oven to your radio or TV, check that the microwave oven is on a different electrical circuit, relocate the radio or TV as far away from the oven as feasible or check position and signal of receiving antenna.

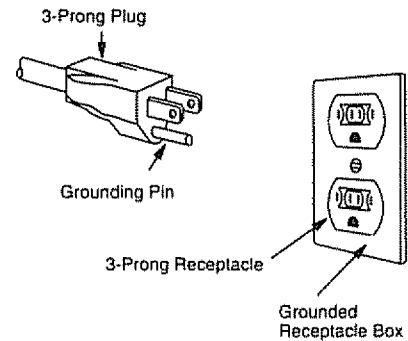

Permanent and Correct Installation

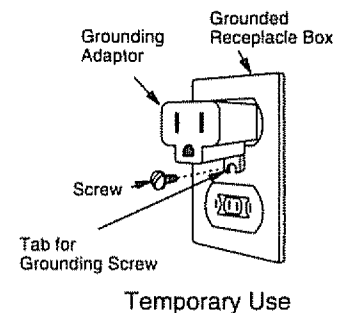

INFORMATION YOU NEED TO KNOW

About Your Oven

This Operation Manual is valuable; read it carefully and always save it for reference.

The Sharp Carousel II Convection Microwave Cookbook is a valuable asset. Check it frequently for cooking principles, techniques, hints and recipes.

NEVER use the oven without the turntable and support nor turn the turntable over so that a large dish could be placed in the oven. The turntable will turn both clockwise and counterclockwise.

ALWAYS have food in the oven when it is on to absorb the microwave energy.

When using the oven at power levels below 100%, you may hear the magnetron cycling on and off.

Condensation is a normal part of microwave cooking. Room humidity and the moisture in food will influence the amount of moisture that condenses in the oven. Generally, covered foods will not cause as much condensation as uncovered ones. Vents on the oven back must not be blocked.

After using **convection, automatic mix or broil**, you will hear the sound of the cooling fan. The fan may operate as long as 5 minutes, depending on the oven temperature.

Be aware that, unlike microwave-only ovens, convection microwave ovens have a tendency to become hot during **convection, automatic mix and broil** cooking.

The oven is for food preparation only. It should not be used to dry clothes or newspapers.

Your oven is rated 900 watts using the IEC 705-1988 method. In using recipes or package directions, check food at the minimum time and add time accordingly.

About Food

	DO	DON'T
Eggs, sausages, fruits & vegetables	<ul style="list-style-type: none"> * Puncture egg yolks before cooking to prevent "explosion". * Pierce skins of potatoes, apples, squash, hot dogs and sausages so that steam escapes. 	<ul style="list-style-type: none"> * Cook eggs in shells. * Reheat whole eggs.
Popcorn	<ul style="list-style-type: none"> * Use specially bagged popcorn for the microwave oven. * Listen while popping corn for the popping to slow to 1 or 2 seconds or use Sensor POPCORN pad for "no-guess" popping. * Use an overturned 9 or 10 inch oven proof glass pie plate on top of the turntable when popping bagged microwave popcorn. 	<ul style="list-style-type: none"> * Pop popcorn in regular brown bags or glass bowls. * Exceed maximum time on popcorn package.
Baby food	<ul style="list-style-type: none"> * Transfer baby food to small dish and heat carefully, stirring often. Check temperature before serving. * Put nipples on bottles after heating and shake thoroughly. "Wrist" test before feeding. 	<ul style="list-style-type: none"> * Heat disposable bottles. * Heat bottles with nipples on. * Heat baby food in original jars.
General	<ul style="list-style-type: none"> * Cut baked goods with filling after heating to release steam and avoid burns. * Stir liquid briskly before and after heating to avoid "eruption". * Use deep bowl when cooking liquid or cereal to prevent boilovers. 	<ul style="list-style-type: none"> * Heat or cook in closed glass jars or air tight containers. * Can in the microwave as harmful bacteria may not be destroyed. * Deep fat fry. * Dry wood, gourds, herbs or wet papers.

About Utensils and Coverings

It is not necessary to buy all new cookware. Many pieces already in your kitchen can be used successfully in your new microwave convection oven. The chart below will help you decide what utensils and coverings should be used in each mode.

Utensils and Coverings	Microwave Only	Convection Broil, Slow Cook	High Mix/Roast Low Mix/Bake
Aluminum foil	Yes Small flat pieces of aluminum foil placed smoothly on food can be used to shield areas from cooking or defrosting too quickly. Keep foil at least 1 inch from walls of oven.	Yes For shielding	Yes For shielding
Aluminum containers	Yes Can be used if 3/4 filled with food. Keep 1 inch away from walls and do not cover with foil.	Yes Broil-No cover	Yes Can be used if 3/4 filled with food. Keep 1 inch away from walls and do not cover with foil.
Browning dish	Yes Do not exceed recommended preheating time. Follow manufacturer's directions.	No	No
Glass ceramic (Pyroceram.®)	Yes Excellent	Yes Excellent	Yes Excellent
Glass, heat-resistant	Yes Excellent. Overturnd pie plate necessary for popping popcorn.	Yes Excellent	Yes Excellent
Glass, non-heat-resistant	No	No	No
Lids, glass	Yes	Yes Broil-No cover	Yes
Lids, metal	No	Yes Broil-No cover	No
Metal cookware	No	Yes	Yes Do not use metal covering.
Metal, misc: dishes with metallic trim, screws, bands, handles. Metal twist ties	No	No	No
Oven cooking bags	Yes Good for large meats or foods that need tenderizing. DO NOT use metal twist ties	Yes Broil-No	Yes DO NOT use metal twist ties
Paper plates	Yes For reheating	No	No
Paper towels	Yes To cover for reheating and cooking. Do not use recycled paper towels which may contain metal filings.	No	No
Paper, ovenable	Yes	Yes For temperatures up to 400°. Do not use for broiling.	Yes For temperatures up to 400°.
Microwave-safe plastic containers	Yes Use for reheating and defrosting. Follow manufacturer's directions.	No	No
Plastic, Thermoset®	Yes	Yes Are heat resistant up to 425°. Do not use for broiling.	Yes
Plastic wrap	Yes Use brands specially marked for microwave use. DO NOT allow plastic wrap to touch food. Vent so steam can escape.	No	No
Pottery, porcelain stoneware	Yes Check manufacturer's recommendation for being microwave safe	Yes	Yes Must be microwave safe AND ovenable.
Styrofoam	Yes For reheating	No	No
Wax paper	Yes Good covering for cooking and reheating	No	No
Wicker, wood, straw	Yes May be used for short periods of time. Do not use with high fat or high sugar content foods. Could char.	No	No

DISH CHECK. If you wish to check if a dish is safe for microwaving, place the empty dish in the oven and microwave on HIGH for 30 seconds. If the dish becomes very hot, do NOT use it for microwaving.

ACCESSORIES. There are many microwave accessories available for purchase such as popcorn poppers and thermometers. Evaluate carefully before purchasing. A microwave safe or dual safe microwave/conventional thermometer will assist you in determining doneness and assure you that foods have been cooked to a safe temperature. The dual safe thermometer can be used with mix cooking.

About Microwave Cooking

- * Arrange food carefully. Place thickest areas toward outside of dish.
- * Watch cooking time. Cook for the shortest amount of time indicated and add more as needed. Foods severely overcooked can smoke or ignite.
- * Cover foods while cooking. Check recipe for suggestions: paper towels, wax paper, microwave plastic wrap or a lid. Covers prevent spattering and help foods to cook evenly.
- * Shield with small flat pieces of aluminum foil any areas of meat or poultry to prevent overcooking or over defrosting.
- * Stir foods from outside to center of dish once or twice during cooking, if possible.
- * Turn foods over once during microwaving to speed cooking of such foods as chicken and hamburgers. Large items like roasts or turkey breasts must be turned over at least once.
- * Rearrange foods like meatballs halfway through cooking both from top to bottom and from the center of the dish to the outside.
- * Add standing time. Remove food from oven and stir, if possible. Cover for standing time which allows the food to finish cooking without overcooking.
- * Check for doneness. Look for signs indicating that cooking temperatures have been reached.
Doneness signs include:
 - Food steams throughout, not just at edge.
 - Center bottom of dish is very hot to the touch.
 - Poultry thigh joints move easily.
 - Meat and poultry show no pinkness.
 - Fish is opaque and flakes easily with a fork.

About Children and the Microwave

Children below the age of 7 should use the microwave oven with a supervising person very near to them. Between the ages of 7 and 12, the supervising person should be in the same room.

The child must be able to reach the oven comfortably; if not, he/she should stand on a sturdy stool.

At no time should anyone be allowed to lean or swing on the oven door.

Children should be taught all safety precautions: use potholders, remove coverings carefully, pay special attention to packages that crisp food because they may be extra hot.

Don't assume that because a child has mastered one cooking skill he/she can cook everything.

About Safety

- * Check foods to see that they are cooked to the United States Department of Agriculture's recommended temperatures:

- 160°F. for fresh pork, boneless white poultry, fish, seafood, egg dishes and frozen prepared food.
- 165°F. for leftover, ready-to-heat refrigerated, and deli and carry-out "fresh" food.
- 170°F. white meat of poultry.
- 180°F. dark meat of poultry.

To test for doneness, insert a meat thermometer in a thick or dense area away from fat or bone. NEVER leave the thermometer in food during cooking, unless it is approved for both microwave and conventional use.

- * Always use potholders to prevent burns when handling utensils that are in contact with hot food.
Enough heat from the food can transfer through utensils to cause skin burns.
- * Avoid steam burns by directing steam away from the face and hands. Slowly lift the farthest edge of a dish's covering and carefully open popcorn and oven cooking bags away from the face.
- * Stay near the oven while it's in use and check cooking progress frequently so that there is no chance of overcooking food.
- * NEVER use the cavity for storing cookbooks or other items.
- * Select, store and handle food carefully to preserve its high quality and minimize the spread of foodborne bacteria.
- * Keep wave guide cover clean. Food residue can cause arcing and/or fires.
- * Keep aluminum foil used for shielding at least 1 inch away from walls, ceiling and door.
- * Use potholders and be careful when using convection, mix or broil cooking as cabinet, interior and door may be too hot to touch.
- * The pull down door can be used briefly to help as you remove foods from the oven.
(only R-9H94B, R-9H84B)

PART NAMES

- Ventilation openings. (Rear side)
- Oven door with see-through window.
- Oven lamp.
It will light when the door is opened or when oven is in operation.
- Turntable support.
- Removable turntable.
The turntable will rotate clockwise or counterclockwise.
- Safety door latches.
The oven will not operate unless the door is securely closed.

- Wave guide cover.
- Door open button (only R-9H76, R-9H66)
- Auto-Touch control panel.
- Lighted digital display.
- Convection air openings.
- Broiling trivet.
- Baking rack.
- Turntable motor shaft.

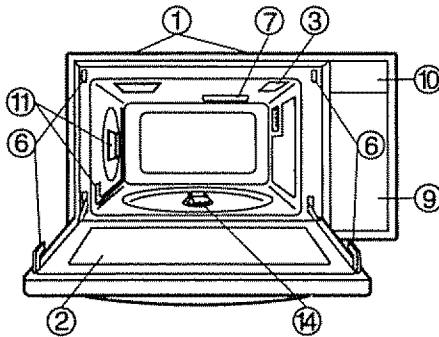

(R-9H94B R-9H84B)

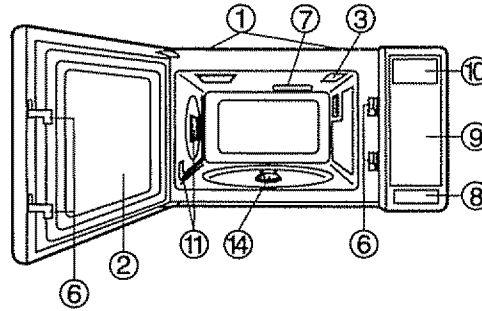

(R-9H76 R-9H66)

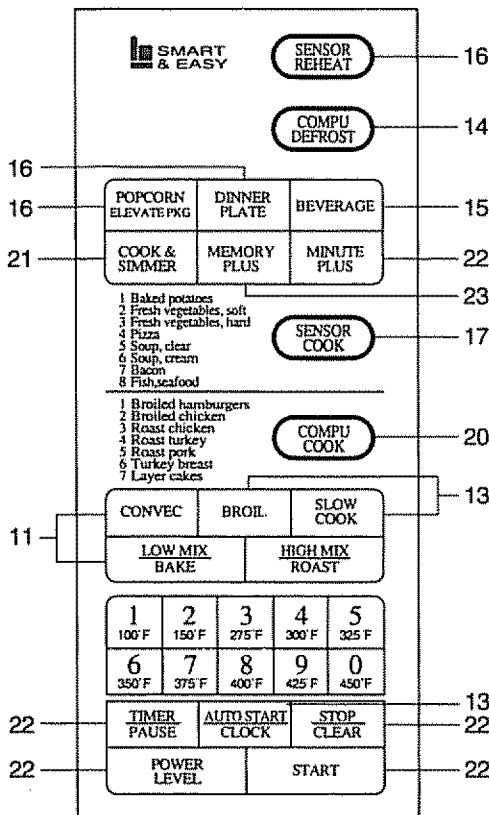
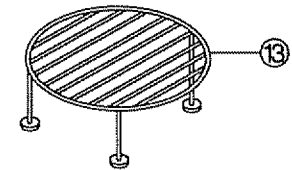
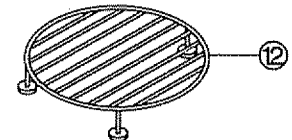
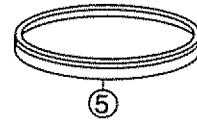
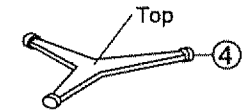

R-9H94B R-9H84B
R-9H76 R-9H66

ACCESSORIES

The following accessories are designed especially for use in this oven only for convection, mix or broil cooking. **DO NOT USE FOR MICROWAVE ONLY COOKING.** Do not substitute similar types of racks for these specially designed ones.

Baking Rack—for convection and low mix.

—This rack is placed on the turntable for two-level cooking, such as layer cakes, muffins, etc.

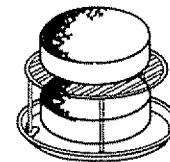

Broiling Trivet—for convection, broiling or high mix.

—Place on the turntable and use for roasting or broiling to allow juices to drain away from food.







Numbers indicate pages on which there are a feature description and usage information.

BEFORE OPERATING

- * Before operating your new microwave oven make sure you read and understand this operation manual completely.
 - * Before the oven can be used follow these procedures.
- 1) Plug in the oven. Close the door.
The oven display will then begin flashing **88:88**.
 - 2) Touch the STOP/CLEAR pad.
00:00 will appear.
 - 3) Set clock.

To Set the Clock

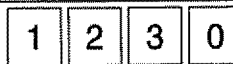
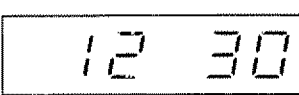
- * Suppose you want to enter the correct time of day 12:30 (A.M. or P.M.)

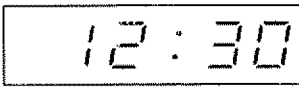
Procedure	Display
1  Touch AUTO START/CLOCK pad.	
2  Enter the correct time of day by touching the numbers in sequence.	
3  Touch AUTO START/CLOCK pad again.	

This is a 12 hour clock. If you attempt to enter an incorrect clock time, **ERROR** will appear in the display. Touch the STOP/CLEAR pad and re-enter the time.

- * If the electrical power supply to your microwave oven should be interrupted, the display will intermittently show **88:88** after the power is reinstated. If this occurs during cooking, the program will be erased. The time of day will be also erased. Simply reset the clock for the correct time of day.

NOTE: Your oven can be programmed with the door open except for START, COMPUDEFROST, MINUTE PLUS, SENSOR REHEAT, POPCORN, DINNER PLATE and BEVERAGE.

Stop/Clear

Use the STOP/CLEAR pad to:

1. Erase if you make a mistake during programming.
2. Cancel minute timer.
3. Stop the oven temporarily during cooking.
4. Return the time of day to the display.
5. Cancel a program during cooking, touch twice.



MANUAL OPERATION

Microwave Cooking

Time Cooking

Your oven can be programmed for 99 minutes 99 seconds (99.99). Always enter the seconds after the minutes, even if they are both zeros.

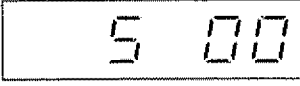
- * Suppose you want to cook for 5 minutes at 100%.





Procedure	Display
1  Enter cooking time.	
2  Touch START pad.	

There are eleven preset power levels.

Using lower power levels increases the cooking time which is recommended for foods such as cheese, milk and long slow cooking of meats. Consult cookbook or recipes for specific recommendations.

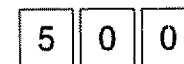
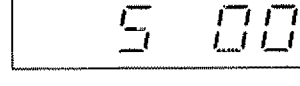
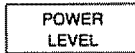
Touch Power Level Pad, Then	Approximate Percentage of Power	Approximate Power Level for commonly used words
POWER LEVEL	100%	High
9	90%	
8	80%	Medium High
7	70%	
6	60%	Medium
5	50%	
4	40%	Med. Low/Defrost
3	30%	
2	20%	Low
1	10%	
0	0%	

- * Suppose you want to cook for 5 minutes at 30%.

Procedure	Display
1  Enter cooking time.	
2   Enter power level.	
3  Touch START pad.	

MANUAL OPERATION

Convection and Automatic Mix Cooking

Convection Cooking

There are ten preset temperature settings.

* Suppose you want to cook at 350°F for 20 minutes.

Procedure	Display
1 Enter cooking time.	20 00
2 Touch CONVEC pad.	F
3 Touch temperature pad.	350F
4 Touch START pad.	20.00
5 After cooking, End will be displayed.	

NOTE: If you wish to know programmed oven temperature, simply touch the CONVEC pad. As long as your finger is touching the CONVEC pad, programmed oven temperature will be displayed.

Automatic Mix Cooking

There are two preprogrammed settings.

	Oven temperature	Microwave power
HIGH MIX/ROAST	300°F	30%
LOW MIX/BAKE	350°F	10%

* Suppose you want to bake a cake for 25 minutes on LOW MIX/BAKE.

Procedure	Display
1 Enter cooking time.	25 00
2 Touch LOW MIX/BAKE pad.	350F
3 Touch START pad.	25.00
4 After cooking, End will be displayed.	

To program a second sequence, for example 15 minutes on LOW MIX, 300°F, touch:

Procedure	Display
3 After Step 2, enter temperature for first stage.	350F
4 Enter time for second stage.	15 00
5 Touch LOW MIX/BAKE pad.	350F
6 Enter temperature.	300F
7 Touch START pad.	25.00

NOTE: The preprogrammed temperature on either HIGH or LOW MIX can be changed to any temperature listed on the number selection pads. Simply touch the desired temperature after touching either HIGH or LOW MIX.

MANUAL OPERATION

To Preheat and then Cook with Convection

Your oven can be programmed to combine preheating and convection cooking or preheating and automatic mix cooking.

* Suppose you want to preheat the oven to 300°F then cook for 20 minutes at 300°F.

Procedure	Display
1 <input type="button" value="CONVEC"/> Touch CONVEC pad.	
2 <input type="button" value="4"/> <input type="button" value="300°F"/> Touch preheat temperature pad.	
3 <input type="button" value="2"/> <input type="button" value="0"/> <input type="button" value="0"/> <input type="button" value="0"/> Enter cooking time.	
4 <input type="button" value="START"/> Touch START pad.	
5 Open door. Place food in oven. Close door.	
6 <input type="button" value="START"/> Touch START pad.	

* If the oven door is not opened, the oven will automatically hold at the preheat temperature for 30 minutes. After this time has elapsed, an audible signal will sound and the oven will turn off.

NOTE: If you wish to preheat and cook at a different convection temperature, follow Steps 1 through 3 above, then touch the CONVEC pad and the desired cooking temperature pad. The cooking temperature will appear on the display. Continue with Step 4.

To Preheat with Automatic Mix

* Suppose you want to preheat the oven to 300°F and bake a pie for 20 minutes on HIGH MIX.

See "To preheat with Convection" above. Touch HIGH MIX/ROAST pad after step 3. Continue with step 4.

NOTE: If you wish to preheat and cook at a different automatic mix cooking temperature, follow "To Preheat with Automatic Mix", after touching HIGH MIX/ROAST pad, touch the desired cooking temperature pad. The cooking temperature will appear on the display. Continue with Step 4.

Helpful Hints for Convection and Automatic Mix Cooking

Your Sharp Convection Microwave Oven can cook any food perfectly because of the number of ways it can cook: microwave only, automatic mix, convection only or broil. The cookbook that comes with your oven has excellent instructions, guidelines, hints, charts and recipes to help you get the best use of your oven. Consult it often until you are familiar with it. This Operation Manual tells you how to program the oven.

The oven cannot be used without the turntable in place. Never restrict the movement of the turntable.

Convection Cooking:

- When preheating, the turntable can be left in or removed. When using the baking rack for 2 shelf cooking in a preheated oven, it is easier to remove the turntable for preheat. Place baking rack on turntable along with foods, and when preheat is over, open oven door and quickly place turntable, baking rack and foods to be baked inside.
- Do not cover turntable, broiling trivet or baking rack with aluminum foil. It interferes with air flow that cooks food.
- Round pizza pans are excellent cooking utensils for many convection-only items. Choose pans that do not have extended handles.
- Using a preheated broiling rack can give a grilled appearance to steaks, hot dogs etc.

Automatic Mix Cooking:

- Meats are best when roasted directly on the broiling trivet. A dish can be placed below the meat if gravy is to be made from the drippings.
- Less tender cuts of meat can be roasted and tenderized using oven cooking bags.
- When baking, check for doneness after time has elapsed. If not completely done, let stand in oven a few minutes to complete cooking.

NOTE:

During mix baking some metal baking utensils may cause arcing when they come in contact with the turntable, oven walls or accessory racks. Arcing is a discharge of electricity that occurs when microwaves come in contact with metal.

If arcing occurs, place a heat resistant dish (Pyrex® pie plate, glass pizza dish or dinner plate) between the pan and the turntable or trivet. If arcing occurs with other metal baking utensils, discontinue their use for mix cooking.

MANUAL OPERATION

Broil Cooking

Preheating is automatic when the BROIL setting is used. Only actual cooking time is entered; the oven signals when it is preheated to 450°F. Use BROIL setting for steaks, chops, chicken pieces and many other foods. See Broiling Chart in cookbook.

* Suppose you want to broil a steak for 15 minutes.

Procedure	Display
1 Enter cooking time.	15 00
2 Touch BROIL pad.	450F
3 Touch START pad. No food in oven.	PRE- HEAT
When the oven reaches the programmed temperature, signal will sound 4 times.	PRE- HEAT OVER
4 Open door. Place food in oven. Close door.	PRESS START
5 Touch START pad.	15:00
6 After cooking, End will be displayed.	End

* If the oven door is not opened, the oven will automatically hold at the preheat temperature for 30 minutes. After this time has elapsed, an audible signal will sound and the oven will turn off.

Preheating for broil may take from 7 to 10 minutes depending on temperature of room and available power.

NOTE: Although time is set for the maximum broiling time as directed in Step 1, check food at minimum time recommended in the chart of Cookbook. This will eliminate the need to completely reprogram the oven if additional cooking time is needed. Simply close the oven door and touch START to continue.

Slow Cook

Slow Cook is preset for 300°F for 4 hours. The temperature can be changed to below 300°F. This feature be used for foods such as baked beans or marinated chuck steak.

* Suppose you want to change oven temperature from 300°F to 275°F.

Procedure	Display
1 Touch SLOW COOK pad.	300F
2 Touch desired temperature pad if you want to change from 300°F.	275F
3 Touch START pad.	275F
4 After cooking, End will be displayed.	End



NOTE: If the oven door is opened or STOP/CLEAR pad is touched during the SLOW COOK cycle, the program will be cancelled and the oven will turn off. If you need to continue, touch the SLOW COOK pad and note time as oven is set again for 4 hours. When changing SLOW COOK temperature, temperatures above 300°F cannot be entered.



SPECIAL FEATURES

CompuDefrost

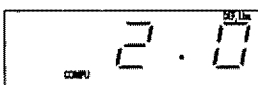
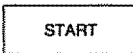
CompuDefrost automatically defrosts ground meat, chicken pieces, steaks, chops, whole chicken and roasts.

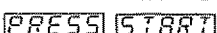
* Suppose you want to defrost a 2.0 lb. steak.

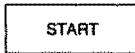
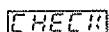
Procedure	Display
<p>Round the weight to the nearest half pound. (Ex. if the steak's actual weight is 2.2 lbs. round to 2.0 lbs. If the steak's weight is 2.4 lbs. round to 2.5 lbs.) To enter weight, touch the COMPU DEFROST pad for a .5 lb. increase per touch. (Ex. touch four times for 2.0 lbs.)</p>	
<p>1  x 4</p> <p>Quickly touch COMPU DEFROST 4 times for 2.0 lbs. because the oven starts automatically.</p>	
<p>The oven will stop and directions will be displayed. Follow the indicated message.</p>	
<p>After the 1st stage, open the door. Turn steak over and shield any warm portions. Close the door.</p> <p>2 </p> <p>Touch START pad.</p>	  

<p>After the 2nd stage, open the door. Shield any warm portions. Close the door.</p> <p>3 </p> <p>Touch START pad.</p>	 
<p>After cooking.</p> <p>4</p>	

If you attempt to enter more or less than the allowed amount (0.5–6.0 lbs.) **ERROR** will appear in the display. CompuDefrost can be programmed with More or Less Time Adjustment. See page 21.

NOTE:

- You may choose to enter the weight in tenths of pounds. This procedure may be easier with larger weights such as 4 pounds because it requires fewer touches. To program, touch COMPU DEFROST and enter weight by touching the number pads. Example: touch COMPU DEFROST then 4 and 0 for a weight of four pounds.
- When weight is less than 0.6 pounds, the oven will stop only once for checking.
- To defrost other foods or foods above or below the weights allowed on CompuDefrost Chart, use time and 30% power. See Manual Defrost on page 15.

COMPU DEFROST CHART

Food	Amount	Procedure
Roast beef Pork	2.5–6.0 lbs.	Start with fat side up. After each stage of defrost cycle, turn over and shield the warm portions with aluminum foil. Stand, covered 30–60 minutes.
Steaks Chops Fish	0.5–4.0 lbs.	After each stage of defrost cycle, rearrange and if there are warm or thawed portions, shield with small flat pieces of aluminum foil. Remove any that are nearly defrosted. Stand, covered 10–15 minutes.
Ground meat	0.5–3.0 lbs.	Remove any thawed pieces after each stage. Stand, 5–10 minutes.
Chicken, whole	2.5–6.0 lbs.	Remove giblets before freezing poultry. Start with breast side down. After the 1st stage, turn over and shield the warm portions with aluminum foil. After the 2nd stage, if there are warm portions, shield with aluminum foil. Stand, covered 30–60 minutes.
Chicken pieces	0.5–3.0 lbs.	After each stage of defrost cycle, if there are warm or thawed portions, rearrange or remove, or shield with small flat pieces of aluminum foil. Stand, 10–15 minutes.

NOTE: Check foods when oven signals. After final stage, small sections may still be icy. Let stand to continue thawing. Do not defrost until all ice crystals are thawed.

Shielding roasts and steaks prevents cooking from occurring before the center of the food is defrosted. Use small smooth strips of aluminum foil to cover edges and thinner sections of the food.

SPECIAL FEATURES

Manual Defrost

If the food that you wish to defrost is not listed on the DEFROST CHART or is above or below the limits in the "Amount" column on the DEFROST CHART, you need to defrost manually.

You can defrost any frozen food, either raw or previously cooked, by using Power Level 3. Follow the exact 3 -step procedure found under Time Cooking on page 10. Estimate defrosting time and press 3 for 30% when you select the power level.

For either raw or previously cooked frozen food the rule of thumb is approximately 5 minutes per pound. For example, defrost 5 minutes for 2-3 cups of casserole or 1 pound of frozen spaghetti sauce.

Always stop the oven periodically to remove or separate the portions that are defrosted. If food is not defrosted at the end of the estimated defrosting time, program the oven in 1 minute increments on Power Level 3 until totally defrosted.

When using plastic containers from the freezer defrost only long enough to remove from the plastic in order to place in a microwave safe dish.

Beverage

Touch to restore beverage to a more suitable drinking temperature.

- * Suppose you want to reheat 1/2 mug of coffee.

Procedure	Display
1 <input type="text" value="BEVERAGE"/> once Touch BEVERAGE once for 1/2 mug.	 <input type="text" value="REHEAT"/>
2 After cooking, <input type="text" value="STIR"/> will be displayed repeatedly.	

Beverage can only be entered within 1 minute after cooking, opening and closing the door or touching the STOP/CLEAR pad.

To increase quantity of beverage, touch 1-4 times for multiples of 1/2 mug. For example, touch BEVERAGE 3 times for 1 1/2 full mugs or 3 half full mugs.

Sensor Cooking

Sharp's Sensor is a semi-conductor device that detects the vapor (moisture and humidity) emitted from food as it heats. The sensor adjusts the cooking times and power level for various foods and quantities. It takes the guess work out of microwave cooking.

Using Sensor Settings:

1. Room temperature should not exceed 95°F.
2. Exhaust vents are provided on the back of the unit for proper cooling and air flow in the cavity. To permit adequate ventilation, be sure to install the unit so as not to block these vents. There should be some space for air circulation.
3. Be sure the exterior of the cooking container and the interior of the oven are dry. Wipe off any moisture with a dry cloth or paper towel.
4. During the first part of sensor cooking, , or and the sensor setting number will appear in the display. Do not open the oven door or touch STOP/CLEAR during this part of the cooking cycle. The measurement of vapor will be interrupted. If this occurs, will appear and sensor cooking will be interrupted. To continue cooking, touch the STOP/CLEAR pad and select cooking time and variable power. Door may be opened when remaining cooking time appears on display. At this time, you may stir or season food, as desired.
5. Check food for doneness after cooking with sensor settings. If additional time is needed, continue to cook with variable power and time.
6. If the sensor does not detect vapor properly with popcorn and bacon, the oven will turn off, and the correct time of day will appear in the display. will flash at the end of properly popped corn, pizza and bacon. With the other sensor settings, if the sensor has not detected the vapor of the food, will appear, and the oven will shut off.

Selecting Foods:

1. The sensor works with foods at normal storage temperature. For example, bacon would be at refrigerator temperature and canned soup at room temperature.
2. Foods weighing less than 3 ounces should be cooked by time and variable power.

Covering Foods:

Some foods work best when covered. Use the cover recommended in the chart or recipe for these foods.

1. Casserole lid
2. Plastic wrap: Use plastic wrap recommended for microwave cooking. Cover dish loosely; allow approximately 1/2 inch to remain uncovered to allow steam to escape. Plastic wrap should not touch food.
3. Paper towel: Use paper towels to absorb excess fat when cooking bacon. Line paper plate with paper towels and cover bacon with additional paper towels.
4. Wax paper: Cover dish completely; fold excess wrap under dish to secure. If dish is wider than paper, overlap two pieces at least one inch to cover.

Be careful when removing any covering to allow steam to escape away from you.



1. Casserole lid



2. Plastic wrap



3. Paper towel



4. Wax paper

SPECIAL FEATURES

Instant Sensor

– Dinner Plate

* Suppose you want to reheat a dinner plate of food.

Procedure	Display
<p>1 Touch DINNER PLATE pad.</p> <p>When sensor detects the vapor emitted from the food, remainder of cooking time will appear (ex. remainder of cooking time is 30 sec.)</p> <p>After cooking, COVER STAND.</p>	<p>REHEAT</p> 

– Popcorn

* Suppose you want to pop one regular size bag of microwave popcorn.

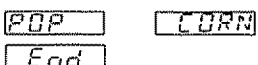
Procedure	Display
<p>1 Place bag on over turned 9" glass pie plate.</p>	
<p>2 Touch POPCORN pad.</p> <p>After cooking, POP CORN End</p>	

NOTE: Touch POPCORN pad twice for single size bags.

– Sensor Reheat

You can reheat many foods by touching just one pad. You don't need to calculate cooking time or power level.

* Suppose you want to reheat canned chili.

Procedure	Display
<p>Touch SENSOR REHEAT pad.</p> <p>1 When sensor detects the vapor emitted from the food, remainder of cooking time will appear (ex. remainder of cooking time is 1 min. 30 sec.)</p>	<p>REHEAT will be displayed repeatedly.</p>  <p>After cooking, COVER and STAND will be displayed repeatedly.</p>

Open oven door or touch STOP/CLEAR pad. The time of day will reappear on the display.

- NOTE:
1. Popcorn, Dinner Plate and Sensor Reheat can only be programmed within 1 minute after cooking, closing the door or touching the STOP/CLEAR pad.
 2. Dinner plate, Popcorn and Sensor Reheat can be programmed with More or Less time Adjustment. See page 21.

Instant Sensor Chart

Food	Amount	Procedure
Sensor Reheat		
Leftovers such as rice, potatoes, vegetables, casserole	4–32 oz.	Place in dish or casserole slightly larger than amount to be reheated. Flatten, if possible. Cover with lid, plastic wrap or wax paper. Use covers such as plastic wrap or lids with larger quantities of more dense foods such as stews. After reheating, stir well, if possible. Foods should be very hot. If not, continue to heat with variable power and time. After stirring, recover and allow to stand 5 minutes.
Canned entrees and vegetables	4–16 oz.	Use Less Time Adjustment by touching Power Level pad twice for small quantities of canned vegetables.
Popcorn	Only 1 package at a time	Use only popcorn packaged for microwave oven use. Do not try to pop unpopped kernels. Place an overturned 9" oven glass pie plate in center of turntable. Place unfolded popcorn bag in center of overturned pie plate.
	3.0 - 3.5 oz. bag	Touch POPCORN pad once. This setting works well with most 3.5 oz. or regular size bags of microwave popcorn.
	1.5 -1.75 oz. bag	Try several brands to decide which is most acceptable for your taste. Touch POPCORN pad twice within 2 seconds and note SINGLE in the display.
Dinner Plate 1 plate	(3–6 oz. meat plus vegetables and/or potato/rice)	Use this pad to reheat precooked foods from the refrigerator. Place meaty portions and bulky vegetables to outside of plate. Cut large items like baked potatoes in smaller pieces. Flatten foods such as mashed potatoes and other dense foods. Cover with wax paper or plastic wrap. ONE PLATE ONLY. After cooking, check that food is very hot throughout and that the bottom center of the plate is very hot. If not, continue heating using time and power level. Allow to stand, covered, 2 to 3 minutes.

SPECIAL FEATURES

Sensor Cook

There are 8 different sensor settings to cook your favorite foods.

* Suppose you want to cook baked potatoes.

Procedure	Display
1 Touch SENSOR COOK pad.	
2 Select desired sensor setting. Touch 1 to cook baked potatoes.	

START

SC-1

Touch START pad

3

3.20

When sensor detects the vapor emitted from the food, remainder of cooking time is 3 min. 20 sec)

After cooking, **COVER** and **STAND** will be displayed repeatedly.

Open oven door or touch STOP/CLEAR pad. The time of day will reappear on the display. Sensor Cook can be programmed with More or Less Time Adjustment. See page 21.

NOTE: If you touch the wrong sensor setting at Step. 2, retouch the correct setting before touching start pad. Selected setting will appear on the display.

Sensor Cook Chart

Setting	Food	Amount	Procedure
1	Baked potatoes		
	White potatoes	1-6 med.	<ul style="list-style-type: none"> Prick; place on turntable lined with paper towel. Stand, covered in foil, 5-10 min.
	Sweet potatoes	1-6 med.	<ul style="list-style-type: none"> Prick, place on turntable lined with paper towel. Stand, covered in foil, 3 min.
2	Fresh vegetables, soft		
	Broccoli	1/4-2 lbs.	<ul style="list-style-type: none"> Wash and place in casserole. If freshly washed, no water is needed. If not freshly washed, add 2 tablespoons of water. Cover with lid for tender vegetables. Use plastic wrap for tender crisp vegetables. Stir before standing if possible. Stand, covered 3-5 min.
	Brussel sprouts	1/4-2 lbs.	
	Cabbage	1/4-3 lbs.	
	Cauliflower (flowerets)	1/4-2 cups	
	Cauliflower (whole)	1 med.	
	Mushrooms	1/2-2 cups	
	Spinach	1/4-1 lb.	
	Zucchini	1/4-2 cups	
	Baked apples	2-4 med.	
3	Fresh vegetables, hard		
	Carrots, sliced	1/2-4 cups	<ul style="list-style-type: none"> Place in casserole. Add 1/4 to 1/2 cup of water. Cover with lid for tender vegetables. Use plastic wrap cover for tender crisp vegetables. Stir before standing, if possible. Stand, covered, 5 min.
	Celery, diced	1/2-1 cup	
	Corn on cob	2-4 ears	
	Green beans	1/2-4 cups	
	Winter squash, diced halves	1/2-2 cups	
	2		
4	Pizza	Only 1 pizza at a time	<ul style="list-style-type: none"> Use only pizza packaged for microwave heating. Follow package directions on how to place in oven. Use less time adjustment by touching power level pad twice for extra cheese pizza.
5	Soup, clear	8-20 oz.	<ul style="list-style-type: none"> Use mug, bowl or casserole. Cover with wax paper or plastic wrap. Stir before standing. Stand, covered, 3-5 min.
6	Soup, cream	8-20 oz.	<ul style="list-style-type: none"> Use mug, bowl or casserole. Cover with wax paper or plastic wrap. Stir before standing. Stand, covered, 3-5 min.
7	Bacon	2-6 slices	<ul style="list-style-type: none"> Place bacon on paper plate, lined with paper towel. Bacon should not extend over rim of plate. Cover with paper towel. Put another paper plate upside down on turntable. Place plate of bacon on top of overturned plate.
8	Fish, Seafood		
	Fillet, Steak, Shrimp, Scallops, fresh or frozen, thawed	1/4-1 lb.	<ul style="list-style-type: none"> Arrange in ring around shallow glass dish (Roll fillet with edges underneath). Cover with plastic wrap. Stand, covered, 3 min.
	Clams, fresh	1/4-1 lb.	<ul style="list-style-type: none"> Place in plastic bag. Secure end. Slit bag with knife. Stand, covered, 3 min.

SPECIAL FEATURES

SENSOR COOK RECIPES

Cranberry Fluff

- 2 cups fresh cranberries
 - 1 cup water
 - $\frac{3}{4}$ cup sugar
 - 1 package (3 ounces) orange-flavored gelatin
 - $\frac{1}{2}$ pint whipping cream, whipped or
 - 1 package (8 ounces) non-dairy whipped topping
- Makes 6 to 8 servings

1. Combine cranberries, water and sugar in a 2-quart casserole. Cover with wax paper. Microwave using Sensor Cook for Soup, Clear. Drain cranberries and reserve liquid.
2. Add enough hot water to reserved liquid to make 2 cups. Stir the gelatin into hot liquid until it dissolves. Cover with wax paper. Microwave using Sensor Cook for Soup, Clear.
3. Add berries and cool. Refrigerate until thickened. Fold whipped cream into cooled cranberry mixture. Spoon into serving dishes and garnish with extra whipped cream. Refrigerate until ready to serve.

Curry Vegetable Chowder

- 6 slices bacon
 - 1 can (10 $\frac{3}{4}$ ounces) chicken broth
 - 3 medium potatoes, finely diced (about 2 cups)
 - 2 carrots, shredded (about 1 cup)
 - 1 small onion, chopped (about $\frac{1}{2}$ cup)
 - $\frac{3}{4}$ teaspoon salt
 - $\frac{1}{2}$ teaspoon curry powder
 - $\frac{1}{8}$ teaspoon pepper
 - 1 can (12 ounces) evaporated milk
 - 2 tablespoons chopped fresh parsley
- Makes 4 servings

1. Layer 2 paper towels on a microwave safe paper plate. Arrange bacon on the towels. Cover with another paper towel. Place an overturned paper plate on turntable and put plate of bacon on top of it. Microwave using Sensor Cook for Bacon. Crumble and reserve bacon.
2. Combine chicken broth, vegetables and seasonings in 4-quart casserole. Cover with vented plastic wrap. Microwave using Sensor Cook for Baked Potatoes. Vegetables should be tender.
3. Stir in evaporated milk. Recover with vented plastic wrap. Microwave using Sensor Cook for Soup, Cream. Stir in parsley. Let stand covered, 5 minutes.
4. Top each serving with crumbled bacon.

Flounder Fillet with Vegetables

- $\frac{1}{2}$ green pepper, diced
 - 1 small onion
 - 1 medium potato, peeled and diced
 - 1 clove garlic, minced
 - 2 tablespoons margarine or butter
 - 1 medium tomato, chopped
 - 1 pound flounder fillet, fresh or frozen, thawed
 - $\frac{1}{8}$ teaspoon pepper
 - $\frac{1}{8}$ teaspoon paprika
 - $\frac{1}{4}$ teaspoon salt
 - $\frac{1}{4}$ teaspoon thyme leaves
 - parsley flakes
- Makes 4 servings

1. Combine green pepper, onion, potato, garlic and margarine in 2-cup measuring cup. Cover with vented plastic wrap. Microwave using Sensor Cook for Fresh Vegetables, Soft. Stir in tomato.
2. Arrange fish in a ring around the outside of a 12-inch round glass utility dish. Pour vegetables over fish. Sprinkle with pepper, paprika, salt and thyme. Cover well with vented plastic wrap. Microwave using Sensor Cook for Fish and Seafood. Let stand 2 minutes. Top with parsley and serve.

Glazed Apple Slices

- $\frac{1}{4}$ cup packed brown sugar
 - 3 tablespoons margarine or butter
 - 2 tablespoons apricot preserves
 - $\frac{1}{2}$ teaspoon ground nutmeg
 - $\frac{1}{4}$ teaspoon salt
 - $\frac{1}{2}$ cup sugar
 - $\frac{3}{4}$ cup orange juice
 - 1 tablespoon cornstarch
 - 4 baking apples (about 1 $\frac{1}{2}$ pounds), peeled and sliced into 8 pieces each
 - 3 tablespoons chopped green pistachios
- Makes 6 to 8 servings

1. Combine brown sugar, margarine and apricot preserves in a small bowl. Microwave at HIGH (100%) until margarine melts and preserves soften, 45 seconds to 1 minutes. Stir in nutmeg, salt, sugar, orange juice and cornstarch. Microwave at HIGH (100%) until thickened, 4 to 6 minutes, stirring several times.
2. Arrange apple slices in a large microwave serving dish. Spread hot sauce over apples. Cover well with vented plastic wrap. Microwave using Sensor Cook for Fresh Vegetables, Soft. Allow to cool 5 minutes before serving.
3. Sprinkle with pistachios. Serve alone or over vanilla ice cream or sponge cake.

SPECIAL FEATURES

Mexican Seasoned Potatoes

- | | |
|--|-----------------------------|
| 4 medium baking potatoes (8 ounces each) | 1/2 teaspoon oregano leaves |
| 1/4 cup olive oil | 1/4 teaspoon ground cumin |
| 1 tablespoon instant minced onion | 1/2 teaspoon salt |
| 1/2 teaspoon chili powder | |

Makes 6 to 8 servings

1. Cut each potato lengthwise into 4 equal wedges. Place potato wedges into 10-inch square casserole. Toss potatoes with oil to coat well.
2. In small bowl, combine remaining ingredients. Sprinkle over potatoes.
3. Cover potatoes with wax paper. Microwave using Sensor Cook for Baked Potatoes. Rearrange potatoes when time appears on display. Let stand covered 5 minutes.

Microwaved Fresh Pumpkin

- 1 Pie Pumpkin or Sugar Pumpkin

1. Wash and cut pumpkin into quarters. Remove seeds and strings. Place in a glass pie plate. Cover well with vented plastic wrap.
2. Microwave using Sensor Cook for Fresh Vegetables, Hard. Allow to stand covered 5 minutes.
3. Scrape the pulp from the shell. Strain off excess liquid from cooked pumpkin. Place pumpkin into food processor or blender and process until smooth. Use in your favorite recipes.

Shrimp Scampi

- | | |
|------------------------------------|--|
| 1/2 cup margarine or butter | 1/2 teaspoon salt |
| 1 tablespoon snipped fresh parsley | 1 pound large raw shrimp, shelled and deveined |
| 2 tablespoons lemon juice | paprika |
| 1 large clove garlic, minced | |

Makes 4 servings

1. Place margarine in 2-cup measuring cup. Microwave at HIGH (100%) until melted, 1 to 1 1/2 minutes. Stir in parsley, lemon juice, garlic and salt.
2. Arrange shrimp in a large glass pie plate. Pour seasoned butter over shrimp. Cover well with vented plastic wrap. Microwave using Sensor Cook for Fish and Seafood. Shrimp should be pink and opaque.
3. Sprinkle with paprika and serve over hot cooked rice.

Spiced Carrots

- | | |
|---|-------------------------------|
| 3 cups sliced carrots, 1/4 inch thick | 2 teaspoons vinegar |
| 1/2 cup chopped green pepper, 1 inch cubes | 1 teaspoon soy sauce |
| 1/4 cup finely chopped onion | 1/2 teaspoon salt |
| 3 tablespoons water | 1/2 teaspoon prepared mustard |
| 1 can (7 3/4 ounces) semi-condensed tomato soup | 1/8 teaspoon pepper |
| 1/2 cup sugar | |

Makes 6 to 8 servings

1. In a 1 1/2-quart casserole, combine carrots, green pepper, onion and water. Cover with lid. Microwave using Sensor Cook for Fresh Vegetables, Hard. Carrots should be tender crisp. Drain.
2. Stir in remaining ingredients. Cover and microwave using Sensor Reheat.

Spaghetti Squash

- | | |
|--------------------------------|------------------------------|
| 1 spaghetti squash | |
| Option A | Option B |
| 3 tablespoons butter, melted | 3 tablespoons butter, melted |
| 1/4 cup grated Parmesan cheese | 1 to 2 tablespoons honey |
| 2 tablespoons chopped parsley | |







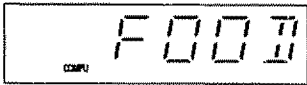

1. Prick squash deeply several times with knife or carving fork.
2. Place squash on paper towel on turntable. Touch Sensor Cook for Vegetables, Hard. When oven sounds, remove squash and let stand 10 minutes.
3. While squash is standing, mix together ingredients for Option A or B. Cut squash in half and remove seeds. Unwind squash with fork into spaghetti-like strands.
4. Toss squash with desired mixture. Serve immediately.

SPECIAL FEATURES

CompuCook

CompuCook will automatically compute the oven temperature, microwave power and cooking time for foods shown in chart.

* Suppose you want to use CompuCook to roast a 5.0 pound turkey breast.

Procedure	Display
1  Touch COMPU COOK pad.	
2  Select CompuCook setting. Touch 6 to turkey breast.	 Lbs. indicator will flash.
3   Touch number pads to enter weight.	
4  Touch START pad.	

After cooking, **COVER** and **STAND** will be displayed repeatedly.

If you attempt to enter unacceptable data, **ERROR** will appear in the display.

CompuCook can be programmed with More or Less Time Adjustment.

NOTE:

1. CompuCook works with foods at normal storage temperature. For example, chicken would be at refrigerator temperature and cakes would be at room temperature.
2. The weight or quantity of food can be entered for each CompuCook Setting. The unit, pound (Lbs.) or quantity (NO.), will appear on display. For example, turkey would be calculated in pounds and hamburger patties would be quantity.
3. Pounds must be rounded off to the nearest tenth of a pound (Example: 5.45 lbs. should be rounded off to 5.5 lbs.)
4. Preheat is automatic with CC-1 (Hamburgers, broiled) and CC-2 (Chicken, broiled). When the oven reaches the desired temperature, an audible signal will sound four times; place the food in the oven and touch START.
5. All foods can be seasoned, as desired, before cooking begins.
6. If door is opened during CompuCook, shut door and touch the START pad to resume cooking.

COMPU COOK CHART

Setting	Food	Amount	Procedure	Comments
1	Hamburgers broiled*	1-8 pieces	Season, as desired. Place on broiling trivet.	Patties should be 1/4 lb. each, 1/2-inch thick. Patties will be medium doneness.
2	Chicken broiled*	0.5-3.5 lbs.	Season, as desired. Place on broiling trivet.	Trim off excess fat. If smoking should occur, 1/2 cup of hot water may be added to the turntable. Chicken next to bone should no longer be pink. If additional time is needed, continue broiling.
3	Chicken roast	2.5-7.5 lbs.	Season, as desired. Place on broiling trivet.	Let stand, covered with foil, 10 to 15 minutes.
4	Turkey roast	6.5-15.9 lbs.	Season, as desired. Place on broiling trivet.	Let stand, covered with foil, 10 to 15 minutes.
5	Pork roast	2-3.5 lbs. boneless pork loin	Season, as desired. Place on broiling trivet.	Let stand, covered with foil, 10 to 15 minutes.
6	Turkey breast	3.0-6.0 lbs.	Season, as desired. Place on broiling trivet.	Let stand, covered with foil, 10 to 15 minutes.
7	Cake layers	1-2 layers	One or two 9-inch round metal cake pans, greased.	Cool 10 minutes in pan on wire rack; remove from pan. Complete cooling on wire rack.





* Program oven without food inside. When audible signal sounds 4 times after preheating, open door, put food in oven on broiling trivet and press START pad.

SPECIAL FEATURES

Cook & Simmer

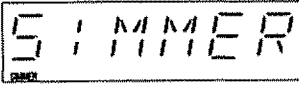
Cook & Simmer automatically brings your favorite recipes for foods that have liquids to a boil and reduces the power level to allow the food to simmer for the exact amount of time you enter. Cook & Simmer is ideal for 1 to 6 cups of liquid in a recipe.

- * Suppose you want to cook soup with less than 6 cups of liquid and simmer it for 30 minutes.

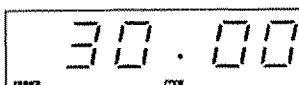
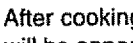
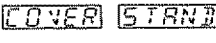
Procedure	Display
1  Touch COOK & SIMMER pad.	
2  Enter simmer time.	
3  Touch START pad.	
4 At audible signal,  will appear. Open door and stir soup. Press START.	
5 After cooking,  and  will be appeared repeatedly.	

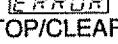
- * Liquid refers to water, vegetable juice, broth or bouillon, not milk or cream.
- * Lid is recommended. Should you use plastic wrap, vent should be small-1/4 inch.
- * For recipes that have a large proportion of vegetables, meat etc., touch Power Level for More after setting the oven.
- * When  is displayed, do not open the door or touch STOP/CLEAR. If this occurs,  will appear. To continue cooking, touch the STOP/CLEAR pad and select cooking time and variable power.
- * COOK & SIMMER can be programmed with More or Less Time Adjustment. See page 21.







OTHER CONVENIENT FEATURES

Multiple Sequence Cooking

The oven can be programmed for up to 4 microwave cooking sequences, switching from one power level setting to another automatically. The oven can be programmed for up to 3 convection or mix settings or a combination of microwave and convection settings.

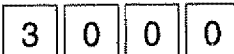
Sometimes cooking directions tell you to start on one power level and then change to a different power level. Your oven can do this automatically.

- * Suppose you want to cook roast beef for 5 minutes at 100% and then continue to cook for 30 minutes at 50%.

Procedure	
1   X 2	First enter cooking time. Then touch POWER LEVEL pad twice for 100% power.
2   	Then enter second cooking time and touch POWER LEVEL pad. Touch number pad 5 for 50% power.
3 	Touch START pad.

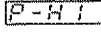
- NOTE: 1. If POWER LEVEL pad is touched twice,  will be displayed.
2. If 100% is selected as the final sequence, it is not necessary to touch the POWER LEVEL pad.
3. If you wish to know power level, simply touch the POWER LEVEL pad. As long as your finger is touching the POWER LEVEL pad, the power level will be displayed.

More or Less Time Adjustment

More

Should you discover that you like any of the Beverage, CompuCook, CompuDefrost, Cook & Simmer, Instant Sensor or Sensor Cook settings slightly **more** done, touch the **POWER LEVEL** pad **once** after touching your choice of pads.

Less

Should you discover that you like any of the Beverage, CompuCook, CompuDefrost, Cook & Simmer, Instant Sensor or Sensor Cook settings slightly **less** done, touch the **POWER LEVEL** pad **twice** after touching your choice of pads.

The POWER LEVEL pad must be touched within 1 second of touching your choice of pads.

OTHER CONVENIENT FEATURES

Minute Timer

- * Suppose you want to time a 3 minute long distance phone call.

Procedure	
1	<input type="text" value="3"/> <input type="text" value="0"/> <input type="text" value="0"/> Enter time.
2	<input type="text" value="TIMER PAUSE"/> Touch TIMER/PAUSE pad.

Pause

Pause allows you to stop the oven between cooking stages to stir, turn food over or add ingredients during the cooking process.

- * Suppose you want to cook for 5 minutes at 100%, stir and continue to cook for 3 minutes at 50%.

Procedure	
1	<input type="text" value="5"/> <input type="text" value="0"/> <input type="text" value="0"/> Enter cooking time for first stage. <input type="text" value="POWER LEVEL"/> x 2 Touch POWER LEVEL pad twice for 100% power.
2	<input type="text" value="TIMER PAUSE"/> Touch TIMER/PAUSE pad.
3	<input type="text" value="3"/> <input type="text" value="0"/> <input type="text" value="0"/> Enter cooking program for second stage. <input type="text" value="POWER LEVEL"/> Touch POWER LEVEL pad. <input type="text" value="5"/> Touch number pad 5 for 50% power.
4	<input type="text" value="START"/> Touch START pad.
5	After the 1st stage, open door and stir soup. Close door.
6	<input type="text" value="START"/> Touch START pad.

Minute Plus

Minute Plus allows you to cook for a minute at 100% by simply touching the MINUTE PLUS pad. You can also extend cooking time in multiples of 1 minute by repeatedly touching the MINUTE PLUS pad during manual cooking.

- * Suppose you want to heat a cup of soup for one minute.

Procedure	
1	<input type="text" value="MINUTE PLUS"/> Touch MINUTE PLUS pad.

- NOTE: 1. To use MINUTE PLUS, touch pad within 1 minute after cooking, closing the door, touching the STOP/CLEAR pad or during cooking. Minute Plus cannot be used to start the oven if any program is on display.
2. Minute Plus cannot be used with SPECIAL FEATURES.

Auto Start

If you wish to program your oven to begin cooking automatically at a designated time of day, follow this procedure:

- * Suppose you want to start cooking a stew for 20 minutes on 50% at 4:30. Before setting, check to make sure the clock is showing the correct time of day.

Procedure	
1	<input type="text" value="4"/> <input type="text" value="3"/> <input type="text" value="0"/> Enter the start time.
2	<input type="text" value="AUTO START CLOCK"/> Touch AUTO START/CLOCK pad.
3	<input type="text" value="2"/> <input type="text" value="0"/> <input type="text" value="0"/> <input type="text" value="0"/> Enter cooking program. <input type="text" value="POWER LEVEL"/> Touch POWER LEVEL pad. <input type="text" value="5"/> Touch number pad 5 for 50% power.
4	<input type="text" value="START"/> Touch START pad.

- NOTE: 1. Auto Start can be used for manual cooking, CompuCook and Memory Plus, if clock is set.
2. If the oven door is opened after programming Auto Start, it is necessary to touch the START pad for the time of day to appear in the readout so that the oven will automatically begin programmed cooking at the chosen Auto Start time.
3. Be sure to choose foods that can be left in the oven safely until the Auto Start time. Baked potatoes are often a good choice.

OTHER CONVENIENT FEATURES







Memory Plus

MEMORY PLUS allows you to recall one cooking instruction previously placed in memory and begin cooking quickly.

- * Suppose you like to heat a frozen breakfast roll every morning for 20 seconds at 50% power.

Memory Entry

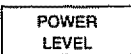

- * Suppose you want to enter instructions (20 sec. at 50%) into the memory bank.

Procedure	
1	 Touch MEMORY PLUS pad.
2	 Touch MEMORY PLUS pad.
3	  Enter cooking time.
4	  Touch POWER LEVEL pad and then 5 for 50% power.
5	 Touch MEMORY PLUS pad. Memory plus is now programmed. After that, time of day will reappear.

NOTE: 1. This information will remain in memory indefinitely unless power to the unit is interrupted or you change the program. You can erase this information simply by programming over it using the procedure outlined above.

Cook by Memory

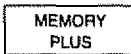
- * Suppose you want to use the memorized cooking program. (20 sec. at 50% power)

Procedure	
1	 Touch MEMORY PLUS pad.
2	 Touch START pad.

NOTE: To check the memorized information, touch the MEMORY PLUS pad. The memorized cooking program will appear on display. To return the time of day, touch the STOP/CLEAR pad.

Safety Lock

The Safety Lock prevents unwanted oven operation such as by small children.

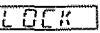
The oven can be set so that the control panel is deactivated or locked. To set, touch **AUTO START/CLOCK**, the number 1 and START. Should a pad be touched,  will appear in the display.

To cancel, touch **AUTO START/CLOCK**, the number 1 and STOP/CLEAR.

Audible Signal Elimination

If you wish to have the oven operate with no audible signals, touch **AUTO START/CLOCK**, the number 5 and START.

To cancel and restore the audible signal, touch **AUTO START/CLOCK**, the number 5 and STOP/CLEAR.

Demonstration Mode

To demonstrate, touch **AUTO START/CLOCK**, 0 and START.

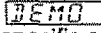
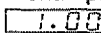
 will appear in the display. Cooking operations and specific special features can now be demonstrated with no power in the oven. For example, touch MINUTE PLUS and the display will show  and count down quickly to 0 and the "End".

To cancel, touch **AUTO START/CLOCK**, then 0 and STOP/CLEAR.

SERVICE CALL CHECK

Please check the following before calling for service:

- Place one cup of water in a glass measuring cup in the oven and close the door securely. Operate the oven for two minutes at HIGH 100%.
 - Does the oven light come on? YES _____ NO _____
 - Does the cooling fan work? YES _____ NO _____
(Put your hand over the rear ventilating openings.)
 - Does the turntable rotate? YES _____ NO _____
It is normal for the turntable to turn in either direction.
 - Is the water in the oven hot? YES _____ NO _____
- Remove water from the oven and operate the oven for 5 minutes at CONV 450°F.
 - Do CONV and COOK indicators light? YES _____ NO _____
 - After the oven shuts off, is inside of the oven hot? YES _____ NO _____

If "NO" is the answer to any of the above questions, please check electrical outlet, fuse and/or circuit breaker.

If both are functioning properly, CONTACT YOUR NEAREST SHARP AUTHORIZED SERVICER. A microwave oven should never be serviced by a "do-it-yourself" repair person.

NOTE: If time appearing in the display is counting down very rapidly, check Demonstration Mode above and cancel.

CLEANING AND CARE

Exterior

The outside surface is precoated metal and plastic. Clean the outside with mild soap and water; rinse and dry with a soft cloth. Do not use any type of household or abrasive cleaner.

Door

Wipe the window on both sides with a damp cloth to remove any spills or splatters. Metal parts will be easier to maintain if wiped frequently with a damp cloth. Avoid the use of harsh abrasives.

Touch Control Panel

Care should be taken in cleaning the touch control panel. If the control panel becomes soiled, open the oven door before cleaning. Wipe the panel with a cloth dampened slightly with water only. Dry with a soft cloth. Do not scrub or use any sort of chemical cleaners. Close door and touch STOP/CLEAR.

Interior - after microwave cooking.

Cleaning is easy because no heat is generated to the interior surfaces; therefore, there is no baking and setting of spills or splattering. To clean the interior surfaces, wipe with a soft cloth and warm water. **DO NOT USE ABRASIVE OR HARSH CLEANERS OR SCOURING PADS.** For heavier soil, use mild soap; rinse thoroughly with hot water.

Interior - after convection, mix or broil cooking.

Splatters may occur because of moisture and grease. Wash immediately after use with hot, soapy water. Rinse and polish dry. Harder to remove splatters may occur if oven is not thoroughly cleaned or if there is long time/high temperature cooking. If so, you may wish to purchase an oven cleaner pad with liquid cleaner within it--not a soap filled steel pad--for use on stainless or porcelain surfaces.

Follow manufacturer's directions carefully and be especially cautious not to get any of the liquid cleaner in the perforations on the wall or ceiling or any door surfaces.

Rinse thoroughly and polish dry.

Wave Guide Cover

Carefully wash any food particles from the wave guide cover located on the ceiling in the oven cavity.

Odor Removal

Occasionally, a cooking odor may remain in the oven. To remove, combine 1 cup water, grated peel and juice of 1 lemon, and several whole cloves in a 2 cup glass measuring cup. Boil for several minutes using 100% power. Allow to set in oven until cool. Wipe interior with a soft cloth.

Turntable/Turntable Support

The turntable and turntable support can be removed for easy cleaning. Wash them in mild, sudsy water; for stubborn stains use a mild cleanser and scouring sponge as described above. They are also dishwasher-proof.

Foods with high acidity, such as tomatoes or lemons, will cause the porcelain enamel turntable to discolor. Do not cook highly acidic foods directly on the turntable; if spills occur, wipe up immediately.

The turntable motor shaft is not sealed, so excess water or spills should not be allowed to stand in this area.

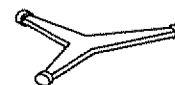
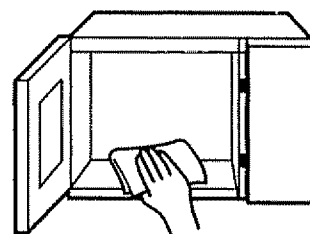
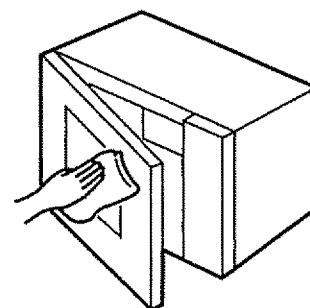

SPECIFICATIONS

AC Line Voltage:	Single phase 120V, 60Hz, AC only
AC Power Required:	1.55 kW 13.0A (Microwave) 1.55 kW 13.0A (Convection)
Output Power:	
Microwave	900W*(IEC-705-1988 Test Procedure)
Convection Heater	1450W
Frequency:	2450 MHz
Outside Dimensions:	24 5/8"(W) x 14 7/8"(H) x 20 5/8"(D) (R-9H94B, R-9H84B) 24 5/8"(W) x 14 7/8"(H) x 18 3/4"(D) (R-9H76, R-9H66)
Cavity Dimensions:	16 1/8"(W) x 9 5/8"(H) x 16 1/8"(D)
Oven Capacity:	1.5 cft
Cooking Uniformity:	Turntable system
Weight:	Approx. 62 lbs.(R-9H94B, R-9H84B) Approx. 60 lbs.(R-9H76, R-9H66)

* the International Electrotechnical Commission's standardized method for measuring output wattage. This test method is widely recognized.

BEVERAGE 1. Touch BEVERAGE pad.	<div style="border: 1px solid black; padding: 5px; width: fit-content; margin: 0 auto;">BEVERAGE</div>	COOK & SIMMER 1. Touch COOK & SIMMER pad. 2. Enter simmer time. (Ex: Simmer soup for 10 minutes after it has reached boiling.) 3. Touch START.	<div style="border: 1px solid black; padding: 5px; width: fit-content; margin: 0 auto;">COOK & SIMMER</div> <div style="display: flex; justify-content: space-around; margin: 5px 0;"> <div style="border: 1px solid black; padding: 2px 5px;">1</div> <div style="border: 1px solid black; padding: 2px 5px;">0</div> <div style="border: 1px solid black; padding: 2px 5px;">0</div> <div style="border: 1px solid black; padding: 2px 5px;">0</div> </div> <div style="border: 1px solid black; padding: 5px; width: fit-content; margin: 0 auto;">START</div>
---	--	---	---

INSTANT SENSOR

-SENSOR REHEAT 1. Touch SENSOR REHEAT pad. NOTE: Touch Power Level pad twice for small quantities of canned vegetables.	<div style="border: 1px solid black; padding: 5px; width: fit-content; margin: 0 auto;">SENSOR REHEAT</div>	-POPCORN Place bag on overturned 9" glass pie plate. 1. Touch POPCORN pad.	<div style="border: 1px solid black; padding: 5px; width: fit-content; margin: 0 auto;">POPCORN</div>
--	---	---	---

Food	Amount	Procedure
Sensor Reheat Leftovers	4-32 oz.	Cover with lid, plastic wrap or wax paper. After reheating, stir well. Recover and allow to stand 2-3 min.
Canned entrees and vegetables	4-16 oz.	
Popcorn	Only 1 package 3.0 - 3.5 oz.bag 1.50 - 1.75 oz.bag	Use only popcorn packaged for microwave oven use. Touch once. Touch twice.
Dinner plate	1 plate (3-6 oz. meat plus vegetables etc)	Cover with wax paper or plastic wrap. Stand, covered 2-3 min.

SENSOR COOK 1. Touch SENSOR COOK. 2. Enter desired sensor setting. (Ex Touch 1 to cook baked potatoes.) 3. Touch START.	<div style="border: 1px solid black; padding: 5px; width: fit-content; margin: 0 auto;">SENSOR COOK</div> <div style="border: 1px solid black; padding: 5px; width: fit-content; margin: 5px auto; text-align: center;">1</div> <div style="border: 1px solid black; padding: 5px; width: fit-content; margin: 0 auto;">START</div>	
---	---	--

Setting	Food	Procedure	Comments
1	Baked potatoes	Prick with fork. Place directly on turntable.	Stand, covered with foil, 5-10 min.
2	Fresh vegetables, soft	Casserole with lid or plastic wrap.	Stand, covered, 3-5 min.
3	Fresh vegetables, hard	Casserole with lid or plastic wrap. Add water.	Stand, covered, 5 min.
4	Pizza	Microwave only type. See package for placing directions.	Remove carefully.
5	Soup, clear	Mug, bowl or casserole with wax paper or plastic wrap.	Stand, covered, 3-5 min.
6	Soup, cream	Mug, bowl or casserole with wax paper or plastic wrap.	Stand, covered, 3-5 min.
7	Bacon	Place on paper plate, lined with paper towel. Cover with paper towel. Elevate paper plate on inverted paper plate.	
8	Fish, Seafood Fillet, Steak, Shrimp Scallops Clams	Arrange in ring around shallow glass dish. Cover with plastic wrap. Place in plastic bag. Secure end. Slit bag with knife.	Stand, covered, 3 min. Stand, covered, 3 min.

AUTO-TOUCH® GUIDE

For more complete information, refer to your Operation Manual.

<p>SET CLOCK</p> <ol style="list-style-type: none"> 1. Touch STOP/CLEAR. 2. Touch AUTO START/CLOCK. 3. Enter time of day by touching numbers. (Ex. 4:30) 4. Touch AUTO START/CLOCK. 	<p>STOP CLEAR</p> <p>AUTO START CLOCK</p> <p>4 3 0</p> <p>AUTO START CLOCK</p>	<p>PREHEAT AND COOK WITH CONVECTION</p> <ol style="list-style-type: none"> 1. Touch CONVEC pad. 2. Enter desired preheat temperature. (Ex. 325°F) 3. Enter cooking time by touching number pads. (Ex. 20 min.) 4. Touch START. 	<p>CONVEC</p> <p>325°F</p> <p>2 0 0 0</p> <p>START</p>																								
<p>MICROWAVE COOKING</p> <ol style="list-style-type: none"> 1. Enter cooking time by touching number pads. (Ex. 1 min. 30 sec.) 2. Touch POWER LEVEL pad. Omit if high or 100% power is desired. 3. Select power level. (Ex. 50%) 4. Touch START. 	<p>1 3 0</p> <p>POWER LEVEL</p> <p>5</p> <p>START</p>	<p>AUTOMATIC MIX</p> <ol style="list-style-type: none"> 1. Enter cooking time by touching number pads. (Ex. 25 min.) 2. Touch LOW MIX/BAKE or HIGH MIX/ROAST. 3. Touch START. <p>NOTE: If you want to change temperature, enter desired temperature after step 2.</p>	<p>2 5 0 0</p> <p>LOW MIX BAKE</p> <p>START</p>																								
<p>MINUTE PLUS</p> <ol style="list-style-type: none"> 1. Touch MINUTE PLUS for one minute at 100% power or to add minute to cooking. Continue to touch for additional minutes. 	<p>MINUTE PLUS</p>																										
<p>COMPU COOK</p> <ol style="list-style-type: none"> 1. Touch COMPU COOK. 2. Select desired COMPU COOK setting. (Ex. Touch 1 to broil hamburgers.) 3. Touch number pads to enter desired quantity or weight. (Ex. 4 patties) 4. Touch START. <p>Oven will preheat to 450°F, then signal 4 times. Put food in the oven and touch START again.</p>	<p>COMPU COOK</p> <p>1</p> <p>4</p> <p>START</p>	<p>BROILING</p> <ol style="list-style-type: none"> 1. Enter desired time by touching number pads. (Ex. 14 min.) 2. Touch BROIL. No food in oven. 3. Touch START. When oven signals, put food in oven. 	<p>1 4 0 0</p> <p>BROIL</p> <p>START</p>																								
<table border="1"> <tbody> <tr> <td>Broiled hamburgers</td> <td>1 to 8 pieces</td> </tr> <tr> <td>Broiled chicken</td> <td>0.5 to 3.5 lbs.</td> </tr> <tr> <td>Roast chicken</td> <td>2.5 to 7.5 lbs.</td> </tr> <tr> <td>Roast turkey</td> <td>6.5 to 15.9 lbs.</td> </tr> <tr> <td>Roast pork</td> <td>2.0 to 3.5 lbs.</td> </tr> <tr> <td>Turkey breast</td> <td>3.0 to 6.0 lbs.</td> </tr> <tr> <td>Layer cakes</td> <td>1 to 2 layers</td> </tr> </tbody> </table>	Broiled hamburgers	1 to 8 pieces	Broiled chicken	0.5 to 3.5 lbs.	Roast chicken	2.5 to 7.5 lbs.	Roast turkey	6.5 to 15.9 lbs.	Roast pork	2.0 to 3.5 lbs.	Turkey breast	3.0 to 6.0 lbs.	Layer cakes	1 to 2 layers	<p>COMPU DEFROST</p> <ol style="list-style-type: none"> 1. Touch COMPU DEFROST pad for a .5lb increase (Ex: 2.5 lbs. steak) per touch. 2. Touch START. <p>During defrosting, oven will stop, check food. Touch START to continue defrosting.</p>		<p>COMPU DEFROST x 5</p> <p>START</p> <table border="1"> <tbody> <tr> <td>Ground meat</td> <td>0.5 to 3.0 lbs.</td> </tr> <tr> <td>Chicken pieces</td> <td>0.5 to 3.0 lbs.</td> </tr> <tr> <td>Steaks, chops</td> <td>0.5 to 4.0 lbs.</td> </tr> <tr> <td>Chicken, whole</td> <td>2.5 to 6.0 lbs.</td> </tr> <tr> <td>Roasts</td> <td>2.5 to 6.0 lbs.</td> </tr> </tbody> </table>	Ground meat	0.5 to 3.0 lbs.	Chicken pieces	0.5 to 3.0 lbs.	Steaks, chops	0.5 to 4.0 lbs.	Chicken, whole	2.5 to 6.0 lbs.	Roasts	2.5 to 6.0 lbs.
Broiled hamburgers	1 to 8 pieces																										
Broiled chicken	0.5 to 3.5 lbs.																										
Roast chicken	2.5 to 7.5 lbs.																										
Roast turkey	6.5 to 15.9 lbs.																										
Roast pork	2.0 to 3.5 lbs.																										
Turkey breast	3.0 to 6.0 lbs.																										
Layer cakes	1 to 2 layers																										
Ground meat	0.5 to 3.0 lbs.																										
Chicken pieces	0.5 to 3.0 lbs.																										
Steaks, chops	0.5 to 4.0 lbs.																										
Chicken, whole	2.5 to 6.0 lbs.																										
Roasts	2.5 to 6.0 lbs.																										

Carousel and Auto-Touch are registered trademarks of Sharp Electronics Corporation.

SHARP ELECTRONICS CORPORATION
 Sharp Plaza, Mahwah New Jersey 07430-2135
 Osaka, Japan

TINSEA622WRR0-D41 Printed in Thailand