

Use & Care Manual

Visit the Frigidaire Web Site at: <http://www.frigidaire.com>

Electric Range

ES530 Control, Self-Cleaning Oven
with Ceramic Cooktop &
Warming Drawer

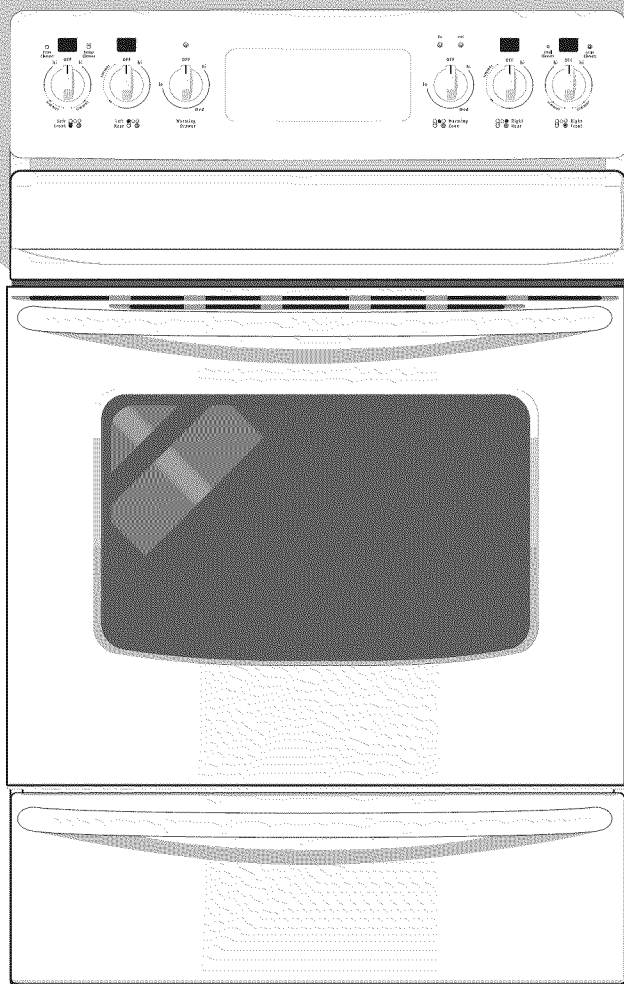

Questions or for Service Call:

1-800-944-9044 (U.S.)

1-800-668-4606 (Canada)

Welcome..... 2

Important Safety Instructions 3-4

Features at a Glance 5

Before Setting Oven Controls 6

Setting Surface Controls 7-12

Surface Cooking..... 13

Warming Drawer Controls 14

Control Pad Features 15

Setting Oven Controls 16-29

Self Cleaning 30-32

Adjusting Oven Temperature. 32-33

Care & Cleaning 33-36

Before You Call
Solutions to Common Problems 37

Warranty Back Page





Welcome & Congratulations

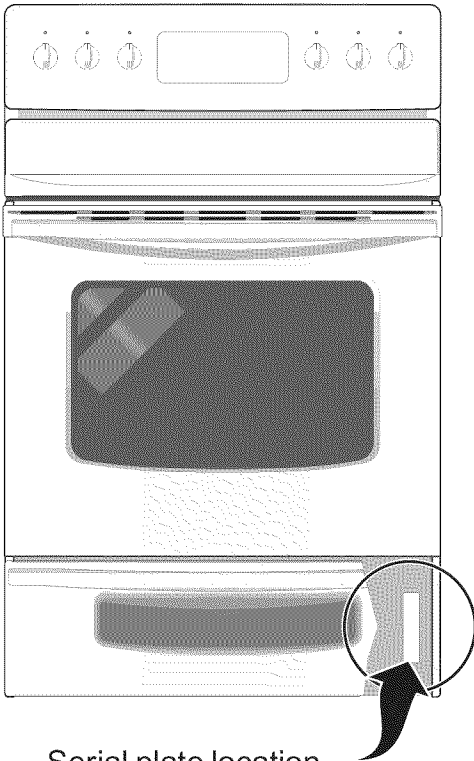

Serial plate location
Open Bake-n-Warm™ Double
Oven or Warmer Drawer.

Congratulations on your purchase of a new range! At **Electrolux Home Products**, we are very proud of our product and are completely committed to providing you with the best service possible. Your satisfaction is our number one priority.

We know you'll enjoy your new range and **Thank You** for choosing our product. We hope you consider us for future purchases.

PLEASE CAREFULLY READ AND SAVE THESE INSTRUCTIONS

This Use & Care Manual provides specific operating instructions for your model. Use your range only as instructed in this manual. These instructions are not meant to cover every possible condition and situation that may occur. Common sense and caution must be practiced when installing, operating and maintaining any appliance.

Please record your model and serial numbers below for future reference.

Model Number: _____
Serial Number: _____
Purchase Date: _____

This Use & Care Manual contains general operating instructions for your range and feature information for several models. Your range **may not** have all the described features. The graphics shown are representational. The graphics on your range may not look exactly like those shown.

Product Registration

Register Your Product

The self-addressed **PRODUCT REGISTRATION CARD** should be filled in completely, signed and returned to Electrolux Home Products.

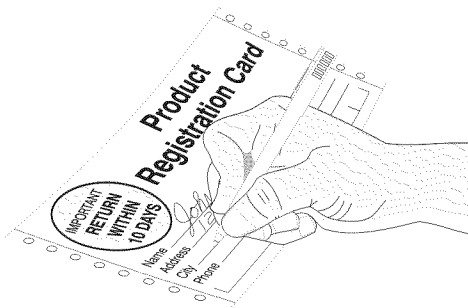

Important Safety Instructions



Read all instructions before using this appliance. Save these instructions for future reference.

This manual contains important safety symbols and instructions. Please pay attention to these symbols and follow all instructions given.

⚠ WARNING This symbol will help alert you to situations that may cause serious bodily harm, death or property damage.

⚠ CAUTION This symbol will help alert you to situations that may cause bodily injury or property damage.

- **Remove all tape and packaging before using the range.** Destroy the carton and plastic bags after unpacking the range. Never allow children to play with packaging material.
- **Proper Installation—Be sure your appliance is properly installed and grounded by a qualified technician in accordance with the National Electrical Code ANSI/NFPA No. 70 latest edition and local electrical code requirements.** Install only per installation instructions provided in the literature package for this range.
Ask your dealer to recommend a qualified technician and an authorized repair service. Know how to disconnect the power to the range at the circuit breaker or fuse box in case of an emergency.
- **User servicing—Do not repair or replace any part of the appliance unless specifically recommended in the manuals.** All other servicing should be done only by a qualified technician. This may reduce the risk of personal injury and damage to the range.
- **Never modify or alter the construction of a range by removing leveling legs, panels, wire covers, anti-tip brackets/screws, or any other part of the product.**

⚠ WARNING

- All ranges can tip.
- Injury to persons could result.
- Install anti-tip device packed with range.
- See Installation Instructions.



⚠ WARNING To reduce the risk of tipping, the range must be secured by properly installed anti-tip bracket provided with the range. To check if the bracket is installed properly, visually check that rear leveling leg is inserted into and fully secured by the anti-tip bracket by removing lower panel or storage drawer. For models with a Warmer Drawer or Bake-n-Warm™ Double Oven, grasp the top rear edge of the range and carefully attempt to tilt it forward. Refer to the installation instructions for proper anti-tip bracket

⚠ WARNING Stepping, leaning or sitting on the doors or drawers of this range can result in serious injuries and also cause damage to the range. Do not allow children to climb or play around the range. The weight of a child on an open door may cause the range to tip, resulting in serious burns or other injury.

⚠ CAUTION Do not store items of interest to children in the cabinets above a range or on the backguard of a range. Children climbing on the range to reach items could be seriously injured.

⚠ WARNING Do not use the oven or Warmer Drawer/ Bake-n-Warm™ Double Oven (if equipped) for storage.

⚠ WARNING Never Use Your Appliance for Warming or Heating the Room.

- **Storage in or on Appliance—Flammable materials should not be stored in an oven, Warmer Drawer/Bake-n-Warm™ Double Oven, near surface units or in the storage drawer.** This includes paper, plastic and cloth items, such as cookbooks, plasticware and towels, as well as flammable liquids. Do not store explosives, such as aerosol cans, on or near the range.
- **Do Not Leave Children Alone—Children should not be left alone or unattended in the area where appliance is in use.** They should never be allowed to sit or stand on any part of the appliance.
- **DO NOT TOUCH SURFACE UNITS, AREAS NEAR THESE UNITS, HEATING ELEMENTS OR INTERIOR SURFACES OF THE OVENS.** ALL surface units and oven heating elements may be hot even though they are dark in color. Areas near surface units may become hot enough to cause burns. During and after use, do not touch, or let clothing or other flammable materials touch these areas until they have had sufficient time to cool. Among these areas are the cook top, surfaces facing the cook top, the oven vent openings and surfaces near these openings, oven door and window.
- **Wear Proper Apparel—Loose-fitting or hanging garments should never be worn while using the appliance.** Do not let clothing or other flammable materials contact hot surfaces.
- **Do Not Use Water or Flour on Grease Fires—Smother the fire with a pan lid, or use baking soda, a dry chemical or foam-type extinguisher.**
- **When heating fat or grease, watch it closely.** Fat or grease may catch fire if allowed to become too hot.
- **Use Only Dry Potholders - Moist or damp potholders on hot surfaces may result in burns from steam.** Do not let potholders touch hot heating elements. Do not use a towel or other bulky cloth instead of a potholder.
- **Do Not Heat Unopened Food Containers - Buildup of pressure may cause container to burst and result in injury.**
- **Remove the oven door from any unused range if it is to be stored or discarded.**

IMPORTANT—Do not attempt to operate the range during a power failure. If the power fails, always turn off the range. If the range is not turned off and the power resumes, the range will begin to operate again. Once the power resumes, reset the clock and oven function.



Important Safety Instructions

IMPORTANT INSTRUCTIONS FOR USING YOUR COOKTOP

- **Know which knob controls each surface heating unit.** Place a pan of food on the unit before turning it on, and turn the unit off before removing the pan.
- **Use Proper Pan Size**—This appliance is equipped with one or more surface units of different sizes. Select utensils having flat bottoms large enough to cover the surface unit heating element. The use of undersized utensils will expose a portion of the heating element to direct contact and may result in ignition of clothing. Proper relationship of utensil to element will also improve efficiency.
- **Utensil Handles Should Be Turned Inward and Not Extend Over Adjacent Surface Elements**—To reduce the risk of burns, ignition of flammable materials, and spillage due to unintentional contact with the utensil, the handle of the utensil should be positioned so that it is turned inward, and does not extend over adjacent surface units.
- **Never Leave Surface Elements Unattended at High Heat Settings**—Boilovers cause smoking and greasy spillovers that may ignite, or a pan that has boiled dry may melt.
- **Do Not Immerse or Soak Removable Heating Elements**—Heating elements should never be immersed in water. Heating elements clean themselves during normal operation.
- **Glazed Cooking Utensils**—Only certain types of glass, glass/ceramic, ceramic, earthenware, or other glazed utensils are suitable for cook top service without breaking due to the sudden change in temperature. Check the manufacturer's recommendations for cook top use.
- **When flaming foods under a ventilating hood, turn the fan on.**

SELF CLEANING OVENS

- **Clean in the self-cleaning cycle only the parts listed in this Use & Care Manual.** Before self cleaning the oven, remove the broiler pan and any utensils or foods from the oven.
- **Do Not Use Oven Cleaners**—No commercial oven cleaner or oven liner protective coating of any kind should be used in or around any part of the oven.
- **Do Not Clean Door Gasket**—The door gasket is essential for a good seal. Care should be taken not to rub, damage or move the gasket.
- The health of some birds is extremely sensitive to the fumes given off during the self-cleaning cycle of any range. Move birds to another well-ventilated room.

IMPORTANT INSTRUCTIONS FOR CLEANING YOUR RANGE

- **Clean the range regularly to keep all parts free of grease that could catch fire.** Pay particular attention to the area underneath each surface element. Do not allow grease to accumulate.
- **Kitchen cleaners and aerosols**—Always follow the manufacturer's recommended directions for use. Be aware that excess residue from cleaners and aerosols may ignite causing damage and injury.
- **Clean Ventilating Hoods Frequently**—Grease should not be allowed to accumulate on the hood or filter. Follow manufacturer's instructions for cleaning.

FOR CERAMIC-GLASS COOK TOP MODELS

- **Do Not Cook on Broken Cook Top**—If cook top should break, cleaning solutions and spillovers may penetrate the broken cook top and create a risk of electric shock. Contact a qualified technician immediately.
- **Clean Cook Top with Caution**—If a wet sponge or cloth is used to wipe spills on a hot cooking area, be careful to avoid a steam burn. Some cleaners can produce noxious fumes if applied to a hot surface.

Important Safety Notice

The California Safe Drinking Water and Toxic Enforcement Act requires the Governor of California to publish a list of substances known to the state to cause cancer, birth defects or other reproductive harm, and requires businesses to warn customers of potential exposure to such substances.

Features At A Glance

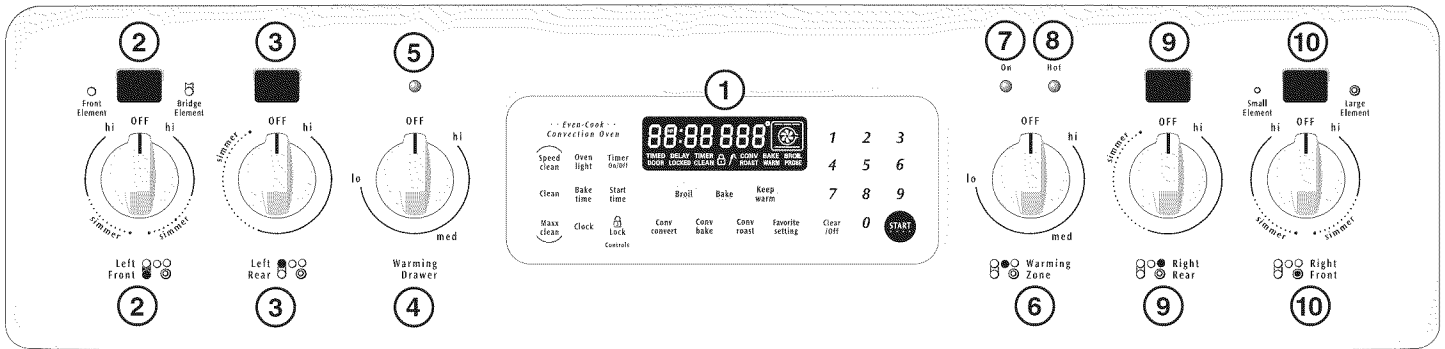

Your Electric Range Features Include:

1. Electronic Oven Control with Kitchen Timer.
2. Left Front & Bridge Element Control & Digital Display (some models) or Dual Element Control (some models).
3. Left Rear Single Element Control & Digital Display or Dual Element Control (some models).
4. Warming Drawer Control (some models).
5. Warming Drawer Indicator Light (some models).
6. Warming Zone Element Control (some models).
7. Warming Zone Indicator Light (some models).
8. Warming Zone HOT SURFACE Indicator Light (some models).
9. Right Rear Single Element Control & Digital Display or Dual Element Control (some models).
10. Right Front Dual Element Control & Digital Display.
11. Oven Interior Light with removable Cover.
12. Automatic Oven Door Light Switch (some models).
13. Self-Cleaning Oven interior.
14. Self-Clean Door Latch.
15. Convection Fan & Cover.
16. Adjustable Interior Oven Rack(s).
17. Large 1 piece Oven Door Handle (styles & colors vary).
18. Full width Oven Door with Window (styles & colors vary).
19. Storage Drawer with Integrated Handle (some models) or Warming Drawer with Handle (some models).
20. Easy to clean upswept Cooktop.
21. Ceramic Smoothtop (elements, styles & color will vary).
22. Left Front Single (some models) or Dual Element (some models).
23. Bridge Element (some models).
24. Left Rear Single (some models) or Dual Element (some models).
25. Warming Zone Element (some models).
26. Right Rear Single (some models) or Dual Element (some models).
27. Right Front Single or Dual Element.
28. Broil Pan (some models).
29. Broil Pan Insert (some models).
30. Roasting Rack (some models).
31. Leveling Legs and Anti-tip Bracket (included).

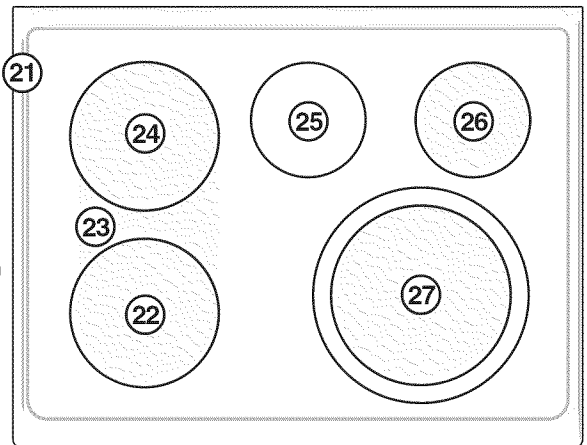
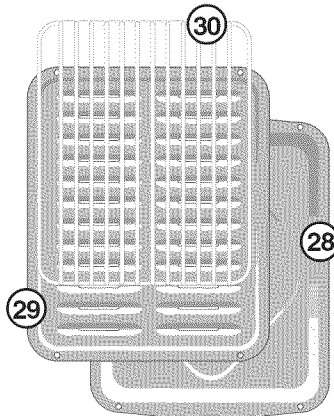
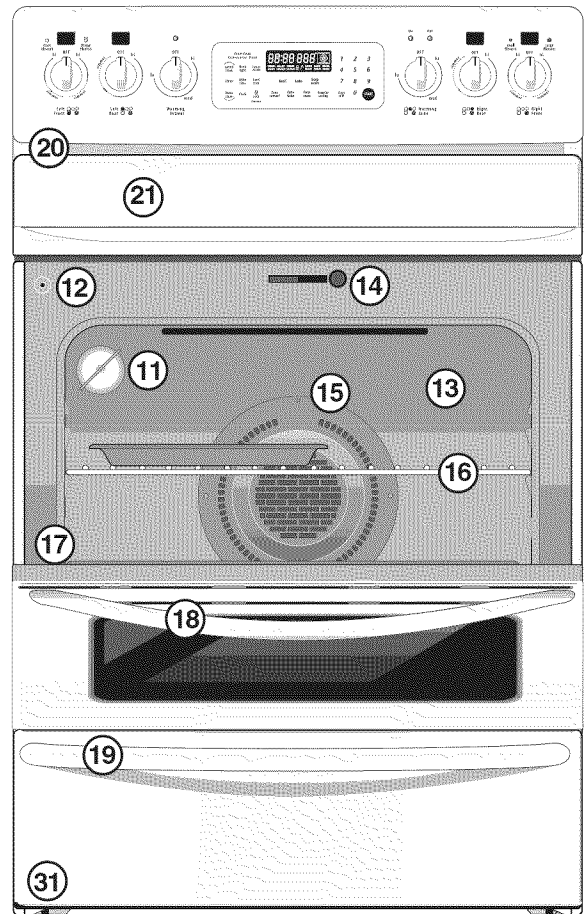

NOTE: The features of your range may vary according to model type & color.



Before Setting Oven Controls

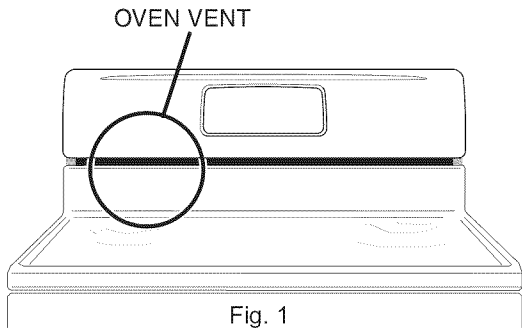

Fig. 1

Oven Vent Location

The oven vent is located **under the left side of the control panel** (See Fig. 1). When the oven is on, warm air passes through the vent. This venting is necessary for proper air circulation in the oven and good baking results. **DO NOT BLOCK OVEN VENT.**

Removing & Replacing Oven Racks

To remove, pull the rack forward until it stops. Lift up front of rack and slide out. **To replace**, fit the rack onto the guides on the oven walls. Tilt the front of the rack upward and slide the rack back into place.

Arranging Oven Racks & Roasting Shelf

ALWAYS ARRANGE OVEN RACKS WHEN THE OVEN IS COOL (PRIOR TO OPERATING THE OVEN). Always use oven mitts when using the oven.

Recommended Rack Positions for Broiling, Baking & Roasting:

Food	Rack Position
Broiling hamburgers & steaks	See Broil
Broiling meats, chicken or fish	See Broil
Cookies, cakes, pies, biscuits & Muffins	3 or 4
Frozen pies, angel food cake, yeast, bread, casseroles, small cuts of meat or poultry	1
Turkey, roast or ham	1 or Roasting Shelf



Fig. 2



Roasting Shelf positioned incorrectly Fig. 3

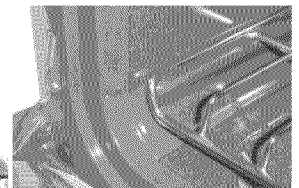

Correct Roasting Shelf position Fig. 4

Types of Oven Racks & Roasting Shelf

Your range may be equipped with one or more of the oven rack types shown; **Flat Oven Rack** (Fig. 5) and **Roasting Shelf** (Fig. 6; some models). To maximize cooking space the Roasting Shelf should be used in the lowest rack position to roast large cuts of meat and poultry (See Fig. 2).

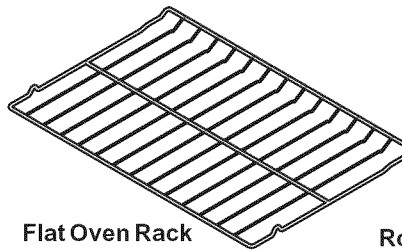

Flat Oven Rack Fig. 5

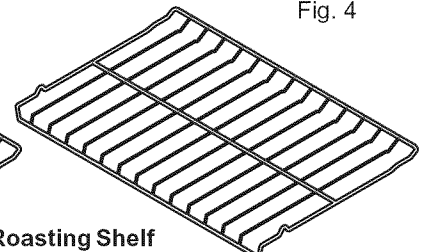

Roasting Shelf Fig. 6

Place **Roasting Shelf** with care (some models; See Fig. 2). Be sure the Roasting Shelf is level and the front end of the shelf rests over the front ends of the oven rack glides on both sides of the oven interior (See Figs. 3 & 4).

Baking Layer Cakes with 1 or 2 Oven Racks

For best results when baking cakes using 2 oven racks, place cookware on rack positions 1 & 4 (See Fig. 7). For best results when using a single Flat Oven Rack, place cookware on rack position 2 or 3 (See Fig. 8).

Air Circulation in the Oven

For best air circulation and baking results allow 2-4" (5-10 cm) around the cookware for proper air circulation and be sure pans and cookware do not touch each other, the oven door, sides or back of the oven cavity. The hot air must be able to circulate around the pans and cookware in the oven for even heat to reach around the food.

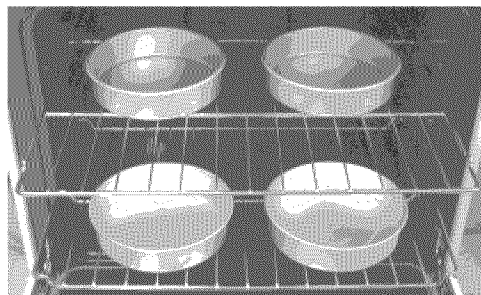

Fig. 7



Fig. 8

Setting Surface Controls



Cooktop radiant areas that heat

Models with a Bridge Element

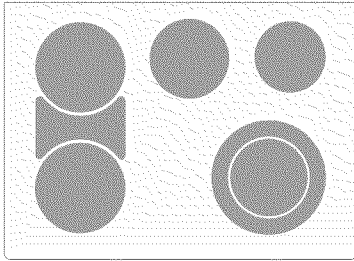

Models with 4 Dual Elements

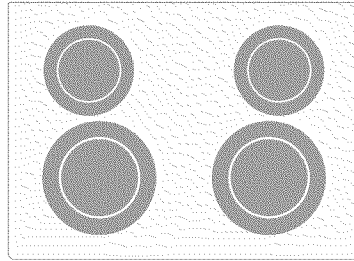

Fig. 1

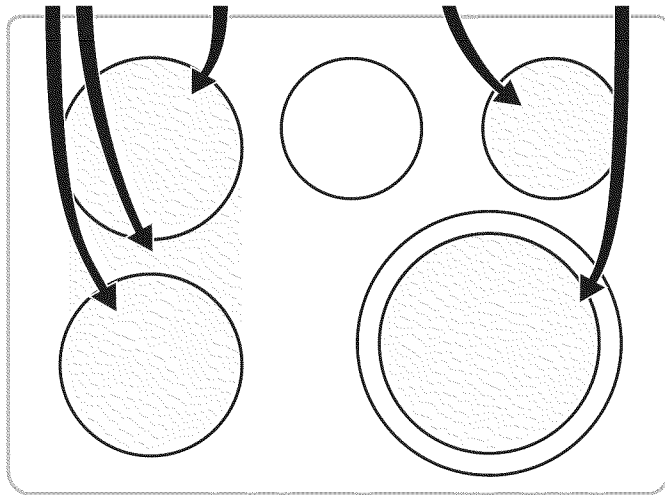
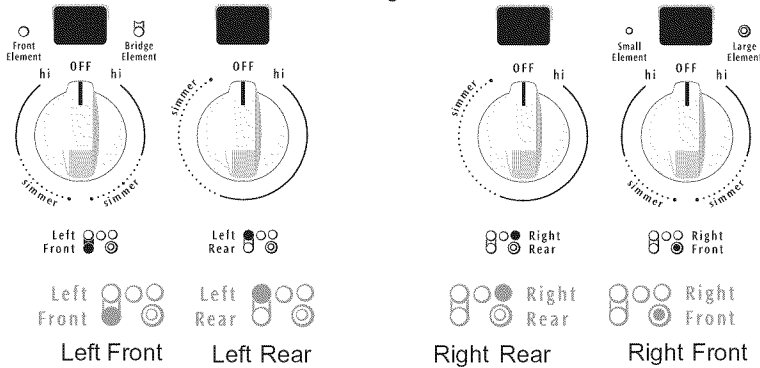

Fig. 2 (Bridge Element on some models)

About the Ceramic Glass Cooktop

The ceramic cooktop has radiant surface elements located below the surface of the glass. The design of the ceramic cooktop outlines the area of the surface element underneath. **Make sure** the diameter of the pan matches the diameter of the element outline on the cooktop (See Fig 1). Heat is transferred up through the surface of the cooktop to the cookware. Only flat-bottom cookware should be used. The type and size of cookware, the number of surface elements in use and the settings, are all factors that will affect the amount of heat that will spread to areas beyond the surface elements. The areas surrounding the elements may become **hot enough to cause burns**.

About the Radiant Surface Elements

The element temperature rises gradually and evenly. As the temperature rises, the element will glow red. To maintain the selected setting, the element will cycle on and off. The heating element retains enough heat to provide a uniform and consistent heat during the off cycle. For efficient cooking, turn off the element several minutes before cooking is complete. This will allow residual heat to complete the cooking process.

Your range is equipped with radiant surface burners with different wattage ratings. The ability to heat food quicker and in larger volumes increases as the element wattage increases.

NOTE: Please read detailed instructions for ceramic glass cooktop cleaning in the **Care & Cleaning** section and **Before You Call** checklist sections of this Use and Care Manual.

NOTE: Radiant elements have a limiter that allows the element to cycle ON and OFF, even at the HI setting. This helps to prevent damage to the ceramic cooktop. Cycling at the HI setting is normal and can occur if the cookware is too small for the radiant element or if the cookware bottom is not flat (Refer to page 13 for using correct cookware instructions with the cooktop).



Setting Surface Controls

The Electronic Surface Element Control (ESEC)

The Electronic Surface Element Control (“ESEC”) feature includes 4 digital display windows. The ESEC feature provides a numeric digital setting for 4 of the radiant surface element positions on the cooktop. These settings work the same way as normal knob setting indicators work except the settings are displayed in digital windows (Figs. 1 thru 4).

The available ESEC Display Settings

The ESEC control provides various heat levels from **Hi** (Fig. 2) to **Lo** (Fig. 4) and **OFF** (Fig. 1).

Use the chart (Fig. 5) to determine the correct setting for the kind of food you are preparing. The Simmer settings are used to simmer and keep larger quantities of foods warm such as stews and soups. The lower Simmer settings are ideal for delicate foods and melting chocolate or butter.

Note: The size and type of cookware used will influence the setting needed for best cooking results.

CAUTION Radiant surface elements may appear to have cooled after they have been turned off. **The glass surface may still be hot** and burns may occur if the glass surface is touched before it has cooled sufficiently.

CAUTION Do not place plastic items such as salt and pepper shakers, spoon holders or plastic wrappings on top of the range when it is in use. These items could melt or ignite. Potholders, towels or wooden spoons could catch fire if placed too close to the surface elements.

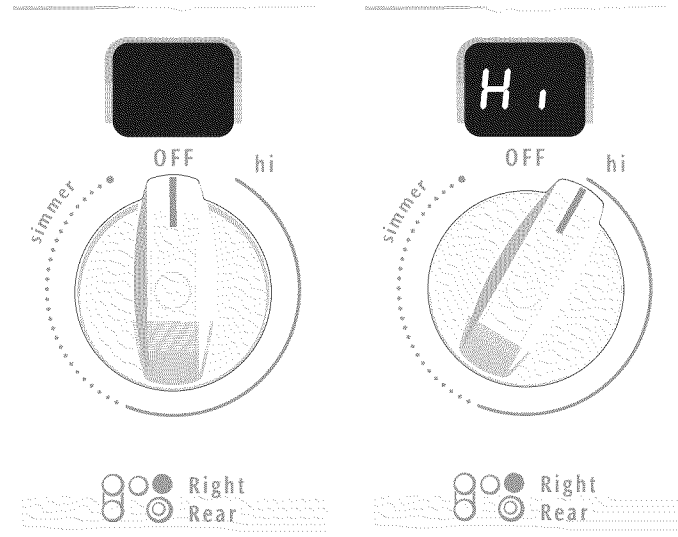

Fig. 1

Fig. 2

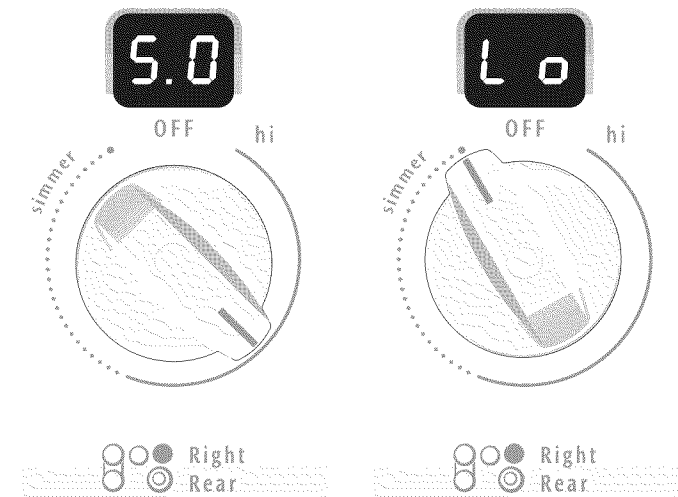

Fig. 3

Fig. 4

Recommended Surface Cooking Settings

RECOMMENDED SETTINGS FOR SINGLE, BRIDGE & DUAL ELEMENTS

Setting	Type of Cooking
HIGH (8 - Hi)	Start most foods, bring water to a boil, pan broiling
MEDIUM HIGH (5 - 8)	Continue a rapid boil, fry, deep fat fry
MEDIUM (3 - 5)	Maintain a slow boil, thicken sauces and gravies, steam vegetables
MEDIUM LOW (2 - 3)	Keep foods cooking, poach, stew
LOW (Lo - 2)	Keep warm, melt, simmer

Fig. 5

Setting Surface Controls



ESEC Hot Element Indicator Message (HE)

After using any of the single, dual or Bridge radiant element positions the cooktop will become very hot. Even after turning the control knob to OFF, the cooktop will remain hot for some time. The ESEC control monitors the temperature of the cooktop and displays the message "HE" (hot element) warning when the cooktop is still too hot to touch (See Fig. 1). If the HE message appears in the window, the control can still be turned on again for use.

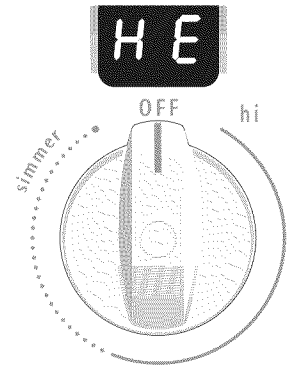

ESEC Error Indicator Message (Er)

An error message will be displayed (flashing "Er") at power up (or after a power failure) if ANY of the surface control knobs were left in the ON positions. If a power failure should occur, be sure to set all of the 4 surface control knobs to the OFF position (See Fig. 2). This will reset the surface controls.



Fig. 1

Be sure to reset the clock (See page 15). Once the surface controls have been set to the OFF positions and the clock has been set with the correct time of day, the surface controls should return to normal operation. If the surface controls do not function and the "Er" message remains in any display after following these procedures, contact an authorized servicer for assistance.

ESEC Lockout Feature (- -)

The Self-Clean feature will not operate whenever a radiant surface element is ON. Conversely the ESEC feature will not operate during the Self-Clean cycle. Whenever the ESEC Lockout feature is active, " - - " may appear in any display window (See Fig. 3). If any of the surface elements are still hot during active Lockout, "HE" will appear in the window instead of the " - - " message.

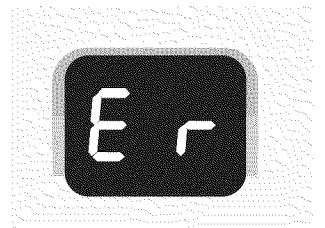

Fig. 2

The Single Radiant Elements (some models)

Some models have single radiant surface elements at 2 locations; the right rear (Fig. 5) and left rear (Fig. 6) element positions. The BRIDGE (some models) element position can also be used as a single element (See Bridge Element Operating Instructions on pages 10-11).

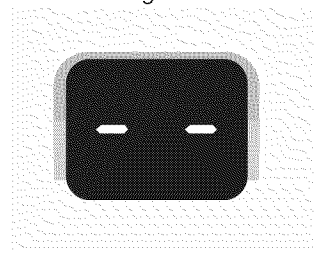

Fig. 3

To Operate the Single Elements (some models):

1. Place correctly sized cookware on the radiant surface element.
2. Push in and turn the surface control knob in either direction to the desired setting using the ESEC digital display window for the desired setting (Fig. 4). Turn (do not push) the knob to adjust the setting if desired. Start most cooking operations on a higher setting and then turn to a lower setting to finish cooking. Each surface element provides a constant amount of heat at each setting. A glowing red surface heating area extending beyond the bottom edge of the cookware indicates the cookware is **too small** for the surface heating area.
3. When cooking has completed, turn the surface control knob to OFF before removing the cookware. Note: The HE message will appear after turning the control knob to OFF if the cooktop is still hot and will remain on until the heating surface area has cooled sufficiently.

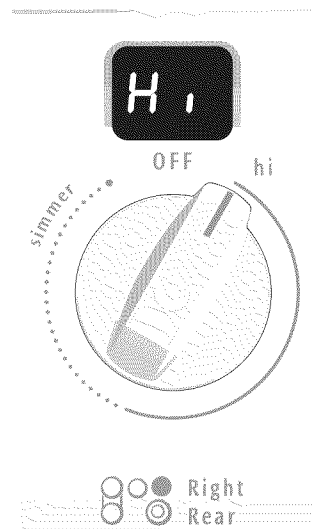

Fig. 4

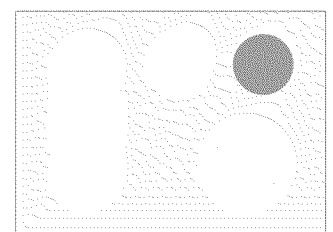

Fig. 5
Right Rear Element
(some models).

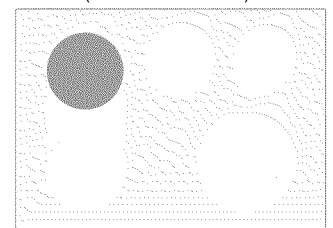

Fig. 6
Left Rear Element
(some models).

Note: See page 8, Fig. 5 for recommended control settings.

CAUTION Radiant surface elements may appear to have cooled after they have been turned off. **The glass surface may still be hot** and burns may occur if the glass surface is touched before it has cooled sufficiently.



Setting Surface Controls

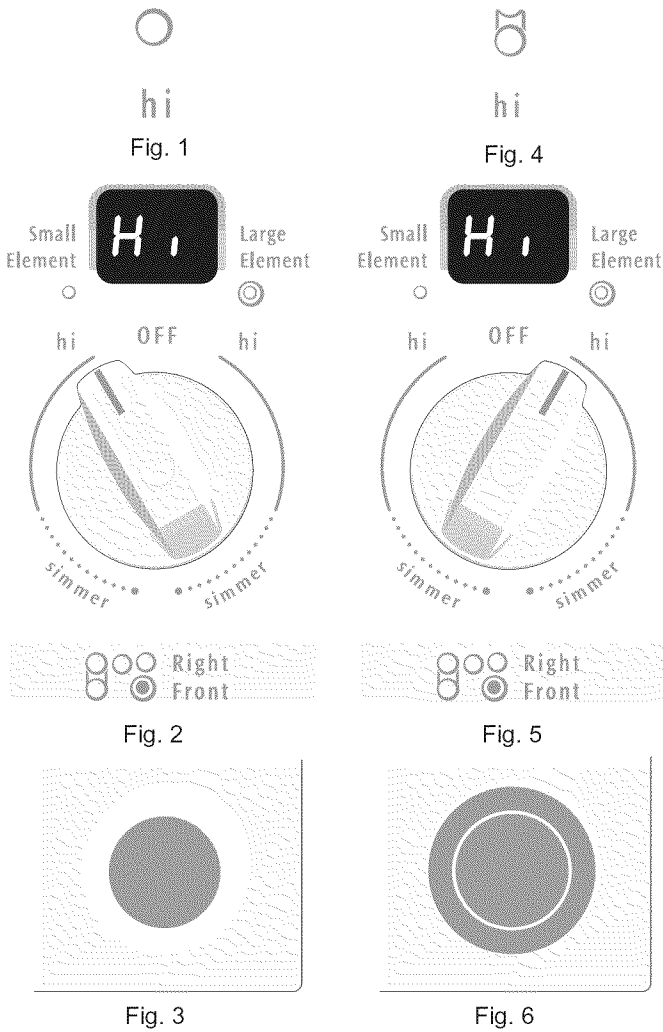

The Dual Radiant Elements (all models)

The cooktop is equipped with one or more dual radiant surface elements. Symbols on the control panel are used to indicate which coil of the dual radiant element will heat. The symbol shown in Fig. 1 indicates that only the inner coil will heat. The symbol shown in Fig. 4 indicates that both inner and outer coils will heat. You may switch from either coil setting at any time during cooking.

To Operate the Dual Element(s):

1. Place correctly sized cookware on the dual surface element.
2. Push in and turn the control knob counterclockwise (See Fig. 2) for smaller cookware or clockwise (See Fig. 5) for larger cookware.
3. Use the ESEC digital display window for the desired setting. Turn (do not push) the knob to adjust the setting if needed. Start most cooking operations on a higher setting and then turn to a lower setting to finish cooking. Each surface element provides a constant amount of heat at each setting. A glowing red surface heating area extending beyond the bottom edge of the cookware indicates the cookware is **too small** for the surface heating area.
4. When cooking has completed, turn the surface control knob to OFF before removing the cookware. Note: The **HE** message will appear after turning the control knob to **OFF** if the cooktop is still hot and will remain on until the radiant heating surface area has cooled sufficiently. **Note:** See page 8, Fig. 5 for recommended control settings.

CAUTION Radiant surface elements may appear to have cooled after they have been turned off. **The glass surface may still be hot** and burns may occur if the glass surface is touched before it has cooled sufficiently.

The Bridge Radiant Element (some models)

Some ceramic cooktops are equipped with a "BRIDGE" surface element located at the left front and middle (See Fig. 10) positions. The Bridge can be used when cooking with rectangular (like a griddle) or oval shaped cookware (Fig. 10). The element will maintain an even temperature setting across both portions of the Bridge. If needed for normal cookware, the Bridge element can work like a single element without the Bridge (See Fig. 8).

Bridge element operation symbols are located on the control panel on each side of the Bridge element control knob. These symbols indicate the direction to turn the control knob when operating the Bridge element. The symbol in Fig. 7 indicates that only the single portion of the Bridge element will heat (See Fig. 8). The symbol in Fig. 9 indicates that both the single and Bridge portions of the element will heat together (Fig. 10). You may switch from either of these settings at any time during cooking with the Bridge element.

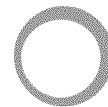

Fig. 7



Fig. 9

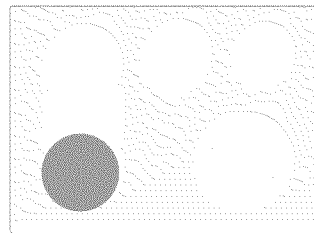

Fig. 8

Bridge element without Bridge portion (some models).

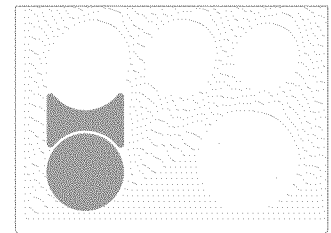

Fig. 10

Bridge element with Bridge portion (some models).

Setting Surface Controls

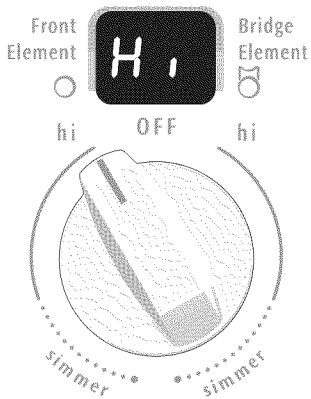

Fig. 1

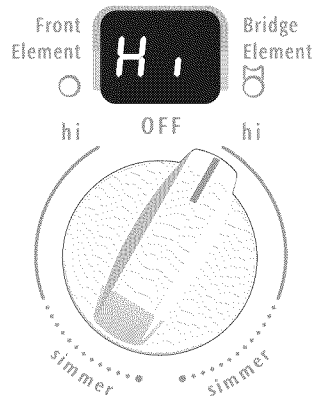

Fig. 3



Fig. 2



Fig. 4

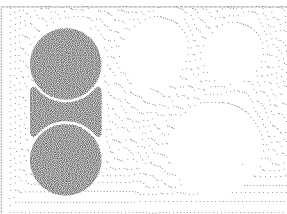

Fig. 5

To Operate the Bridge Element (some models):

1. Place correctly sized cookware on the Bridge surface element.
2. Push in and turn the control knob counterclockwise (See Figs. 1 & 2) to heat the portion of the Bridge element for normal shaped cookware or clockwise (See Figs. 3 & 4) for larger or rectangular shaped cookware.
3. Use the ESEC digital display window for the desired setting. Turn (do not push) the knob to adjust the setting if needed. Start most cooking operations on a higher setting and then turn to a lower setting to finish cooking. Each surface element provides a constant amount of heat at each setting. A glowing red surface heating area extending beyond the bottom edge of the cookware indicates the cookware is **too small**. Please note that not all cookware will fit the Bridge element correctly.
4. When cooking has completed, turn the surface control knob to OFF before removing the cookware. The **HE** message will appear in the display after turning the control knob to **OFF** if the cooktop is still hot and will remain on until the radiant heating surface area has cooled sufficiently. **Note:** See page 8, Fig. 5 for recommended control settings.

The BRIDGE element may also be used in combination with the left rear single element. Because these elements have 2 different controls, one element can be used to cook while the other element may be used to keep food warm (See Fig. 5).

CAUTION Radiant surface elements may appear to have cooled after they have been turned off. **The glass surface may still be hot** and burns may occur if the glass surface is touched before it has cooled sufficiently.



Setting Surface Controls

Operating the Warming Zone (some models)

The purpose of the Warming Zone is to keep hot cooked foods at serving temperature. Use the Warming Zone to keep cooked foods hot such as; vegetables, gravies, casseroles, soups, stews, breads, pastries and oven-safe dinner plates. Always start with hot food. It is not recommended to heat cold food on the Warming Zone.

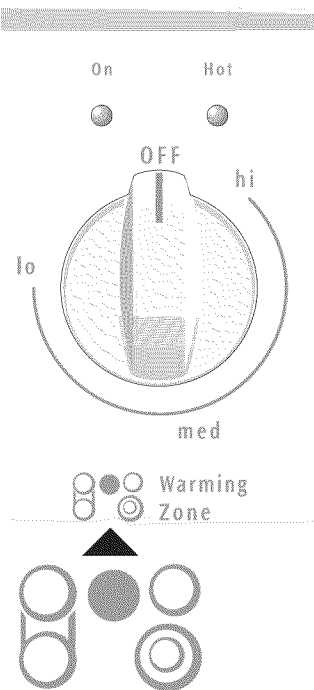

Fig. 1

All food placed on the Warming Zone should be covered with a lid or aluminum foil to maintain quality. For best results, when warming pastries or breads, the cover should have an opening to allow moisture to escape. **Do not use plastic wrap to cover food. Plastic may melt onto the surface and be very difficult to clean.** Use only plates, utensils and cookware recommended for oven and cooktop use on the Warming Zone.

CAUTION Always use pot holders or oven mitts when removing food from the Warming Zone as cookware and plates will be hot.

To Set the Warming Zone Control (some models):

1. To set the control, push in and turn the knob. The **On** indicator light will come on (See Figs. 1 and 2). The temperatures are approximate, and are designated by HI, MED and LO. However, the control can be set at any position between HI and LO for different levels of heating (Fig. 1).
2. When done, turn the control to OFF. The **Warming Zone Hot surface indicator light** will remain on until the **Warming Zone** cools to a moderate level (See Figs. 1 & 2).

Temperature Selection

Refer to the table for recommended Warming Zone food settings (Fig. 3). If a particular food is not listed, start with the medium level, and adjust as needed. Most foods can be kept at serving temperatures by using the medium level.

CAUTION The Warming Zone will not glow red when it is hot, but becomes hot enough to cause burns. Avoid placing hands on or near the Warming Zone until the Warming Zone Hot surface indicator light is off.

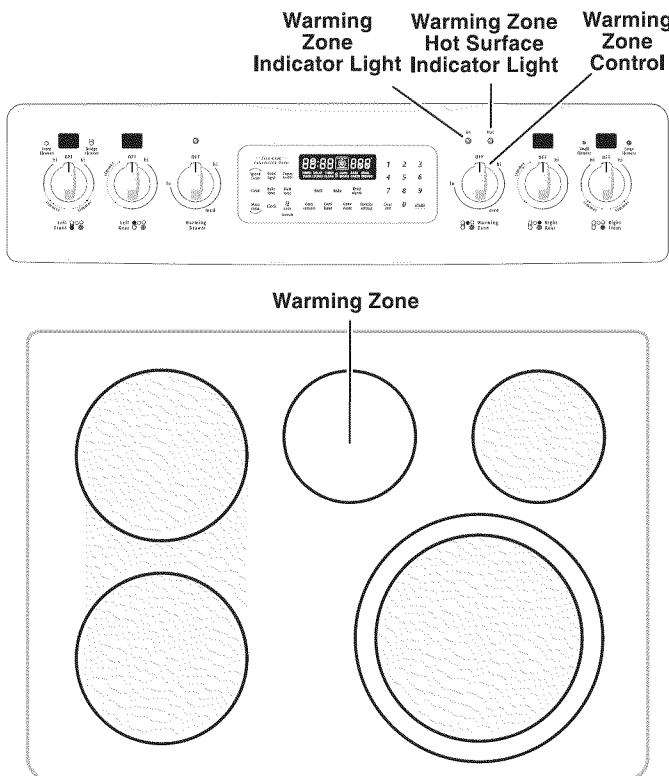

Fig. 2 (some models)

Warming Zone Recommended Food Settings Table	
Food Item	Heating Level
Hot Beverages	HI
Fried Foods	HI
Vegetables	MED
Soups (Cream)	MED
Stews	MED
Sauces	MED
Meats	MED
Gravies	LO
Eggs	LO
Dinner Plates with Food	LO
Casseroles	LO
Breads/Pasteries	LO

Fig. 3

Surface Cooking



Using proper cookware

The size and type of cookware used will influence the setting needed for best cooking results. Cookware should have flat bottoms that make good contact with the entire surface heating element (See Fig. 2). Check for flatness by rotating a ruler across the bottom of the cookware (See Fig. 1).

Be sure to follow the recommendations for using proper cookware as illustrated.

For more information about the ceramic cooktop see "Cooktop Cleaning & Maintenance" in the **General Care & Cleaning** section.

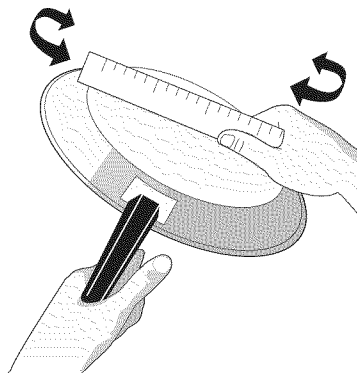
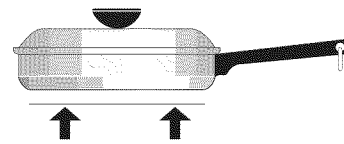

Fig. 1

*CORRECT



- Flat bottom and straight sides.
- Tight fitting lids.
- Weight of handle does not tilt pan. Pan is well balanced.
- Pan sizes match the amount of food to be prepared and the size of the surface element.
- Made of a material that conducts heat well.
- Easy to clean.
- Always match pot diameter to element surface diameter.

INCORRECT

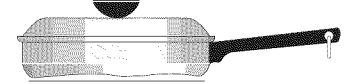

- Curved and warped pan bottoms.

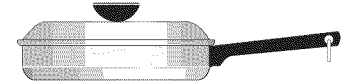

- Pan overhangs element by more than one-half inch.

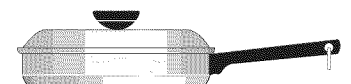

- Pan is smaller than element.

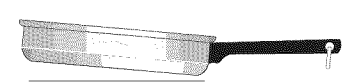

- Heavy handle tilts pan.

Fig. 2

Cookware Material Types

The cookware material determines how evenly and quickly heat is transferred from the surface element to the pan bottom. The most popular materials available are:

ALUMINUM - Excellent heat conductor. Some types of food will cause it to darken (Anodized aluminum cookware resists staining & pitting). If aluminum pans slide across the ceramic cooktop, they may leave metal marks which will resemble scratches. Remove these marks immediately.

COPPER - Excellent heat conductor but discolors easily. May leave metal marks on ceramic glass (see Aluminum above).

STAINLESS STEEL - Slow heat conductor with uneven cooking results. Is durable, easy to clean and resists staining.

CAST IRON - A poor heat conductor however will retain heat very well. Cooks evenly once cooking temperature is reached. Not recommended for use on ceramic cooktops.

PORCELAIN-ENAMEL on METAL - Heating characteristics will vary depending on base material. Porcelain-enamel coating must be smooth to avoid scratching ceramic cooktops.

GLASS - Slow heat conductor. Not recommended for ceramic cooktop surfaces because it may scratch the glass.

Important Note: DO NOT place EMPTY aluminum, glass or porcelain-enamel coated cookware on the ceramic cooktop!

The melting point of cookware made with these materials may be reached quickly especially if left empty & they may bond to the ceramic cooktop. If the cookware melts it WILL damage the cooktop! BE SURE to follow ALL the cookware manufacturer's suggestions when using ANY type of cookware on the ceramic cooktop.



Setting Warming Drawer Controls

(some models)

Arranging Warming Drawer Rack Positions

The rack can be used in 2 ways:

- In the **upright position** to allow low profile food items to be placed both under and on top of the rack (for example, rolls or biscuits on top of the rack and a casserole dish underneath).
- In the **downward position** to allow you to place light weight food items and empty cookware (for example, rolls or pastries and dinner plates) on the rack.

Set the Warming Drawer rack in either position as shown below (Fig. 1).

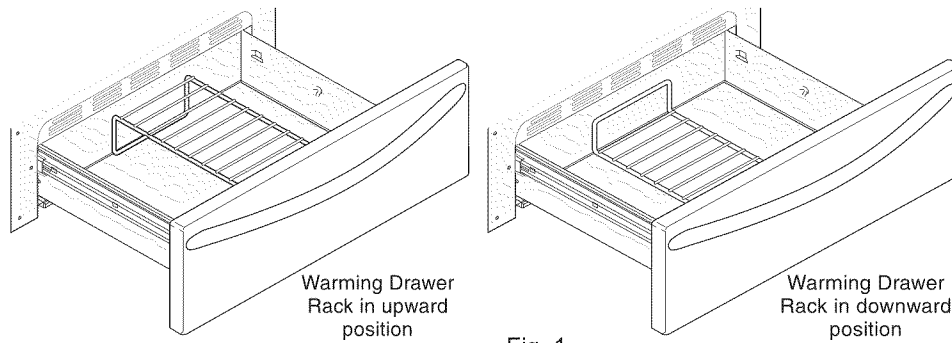
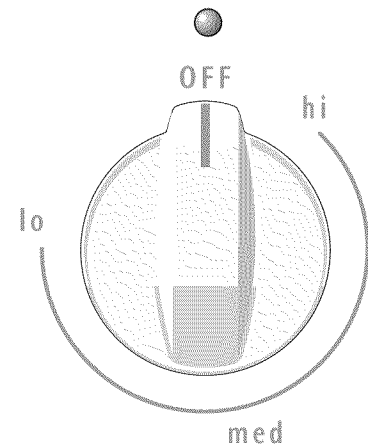

Fig. 1

CAUTION Always use pot holders or oven mitts when removing food from the Warming Drawer as cookware and plates will be hot and you can be burned.



Warming Drawer

Fig. 2

To Operate the Warming Drawer

The purpose of the Warming Drawer is to keep hot cooked foods at serving temperature. Always start with hot food. It is not recommended to heat cold food in the Warming Drawer.

All food placed in the Warming Drawer should be covered with a lid or aluminum foil to maintain quality. **Do not use plastic wrap to cover food. Plastic may melt onto the drawer and be very difficult to clean.** Use only utensils and cookware recommended for oven use in the Warming Drawer.

To Set the Warming Drawer Control

The control is used to select the temperature of the Warming Drawer. It is located on the control panel. To set the control, push in and turn the knob to the desired setting. The temperatures are approximate, and are designated by **HI** (high), **MED** (medium) and **LO** (low). To set the Warming Drawer control:

1. Turn the knob to select the desired temperature setting.
2. For best results, preheat the drawer before adding food. An empty drawer will preheat in approximately 15 minutes.
3. When done, turn the control to **OFF**.

Warming Drawer Temperature Selection

Recommended Warming Drawer food settings are shown in Fig. 3. If a particular food is not listed, start with the MED setting. If more crispness is desired, remove the lid or aluminum foil from the food. Most foods can be kept at serving temperatures on the MED setting. When a combination of foods are to be kept warm (for example, a meat with 2 vegetables and rolls) use the HI setting. To avoid heat loss, do not open the Warming Drawer while in use.

Warming Drawer Indicator Light

The Warming Drawer indicator light is located above the Warming Drawer control knob (See Fig. 2). It turns on when the control is set, and stays on until the control is turned off. **The Warming Drawer will not operate during the Self-Clean cycle.**

Warming Drawer Recommended Food Settings Table

Food Item	Setting
Bacon	HI
Hamburger Patties	HI
Poultry	HI
Pork Chops	HI
Fried Foods	HI
Pizza	HI
Gravies	MED
Casseroles	MED
Eggs	MED
Roasts (Beef, Pork, Lamb)	MED
Vegetables	MED
Biscuits	MED
Rolls, hard	MED
Pastries	MED
Rolls (soft)	LO
Empty Dinner Plates	LO

Fig. 3

Control Pad Features



READ THE INSTRUCTIONS CAREFULLY BEFORE USING THE OVEN. For satisfactory use of your oven, become familiar with the various features and functions of the oven as described below. **Detailed instructions for each feature and function follow later in this Use & Care Guide.**

OVEN LIGHT—Use to turn the oven light ON and OFF.

TIMER ON/OFF—Use to set or cancel the Kitchen Timer.

BROIL—Use to select variable Broil feature.

BAKE—Use to enter the normal Bake feature.

KEEP WARM—Use to select the Keep Warm feature.

0 THRU 9 NUMBER PADS—Use to enter temperature and times.

BAKE TIME—Use to enter the length of the baking time.

CLEAN—Use to select a 3 hour Self-Cleaning cycle.

START TIME—Use with **BAKE, BAKE TIME,** and **CLEAN PADS** to program a Delayed Timed Bake or Delay Self-Cleaning cycle.

MAXX CLEAN—Use to select a 4 hour Self-Cleaning cycle.

CLOCK—Use to set the time of day.

LOCK CONTROLS—Use to enable or disable all oven features.

CONV CONVERT—Use to select the Convection Convert feature.

CONV BAKE—Use to select the Convection Bake feature.

CONV ROAST—Use to select the Convection Roast feature.

FAVORITE SETTING—Use to recall stored recipes.

CLEAR/OFF—Use to cancel any oven mode previously entered except the Oven Lockout, Time of Day & Minute Timer. Press **CLEAR/OFF** to stop cooking.

START—Use to start all oven features (not used with Oven Light).

Minimum & Maximum Control Pad Settings

All of the features listed have minimum and maximum time or temperature settings that may be entered into the control. An ENTRY acceptance beep will sound each time a control pad is touched (the Oven Lockout pad is delayed by 3 seconds).

An ENTRY ERROR tone (3 short beeps) will sound if the entry of the temperature or time is below the minimum or above the maximum settings for the feature.

FEATURE		MIN. TEMP. /TIME	MAX. TEMP. /TIME
PREHEAT TEMP.		170°F / 77°C	550°F / 288°C
BAKE TEMP.		170°F / 77°C	550°F / 288°C
BROIL TEMP.		400°F / 205°C	550°F / 288°C
KITCHEN TIMER	12 Hr.	0:01 Min.	11:59 Hr./ Min.
	24 Hr.	0:01 Min.	11:59 Hr./ Min.
CLOCK TIME	12 Hr.	1:00 Hr./ Min.	12:59 Hr./ Min.
	24 Hr.	0:00 Hr./ Min.	23:59 Hr./ Min.
COOK TIME	12 Hr.	0:01 Min.	11:59 Hr./ Min.
	24 Hr.	0:01 Min.	23:59 Hr./ Min.
START TIME	12 Hr.	1:00 Hr./ Min.	12:59 Hr./ Min.
	24 Hr.	0:00 Hr./ Min.	23:59 Hr./ Min.
CLEAN TIME		2 hours	4 hours
CONVECTION BAKE		170°F / 77°C	550°F / 288°C



Setting Oven Controls



Setting the Clock

The **CLOCK** (Clock) pad is used to set the clock. The clock may be set for 12 or 24 hour time of day operation. The clock has been preset at the factory for the 12 hour operation. When the range is first plugged in, or when the power supply to the range has been interrupted, the timer in the display will flash the time of day (Fig. 1).



Fig. 1

INSTRUCTIONS

To set the clock (example below for 1:30):

1. Press (Clock) . (Fig. 2).
2. Press (1) (3) (0) pads to set the time of day to 1:30 (Fig. 3).
Press (START) . (Fig. 4).

PRESS

DISPLAY

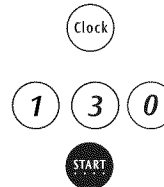

Fig. 2



Fig. 3

Changing between 12 or 24 hour time of day display:

1. Press and hold (Clock) for 6 seconds (Fig. 3). CONTINUE holding the pad until a beep is heard.
2. The display will show either "12h"(Fig. 5) or "24h"(Fig. 6).
3. Press (Clean) to switch between the 12 and 24 hour time of day display. The display will show either "12h" (Fig. 5) or "24Hrhh" (Fig. 6).
4. Press (START) to accept the desired change or press (Clear /off) to reject the change.
5. Reset the correct time as described in **To set the Clock** above. Please note that if the 24 hour time of day mode was chosen, the clock will now display time from 0:00 through 23:59 hours.

(Clock) for 6 seconds



Fig. 4

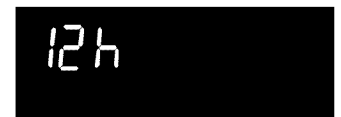

Fig. 5





Fig. 6

Setting Oven Controls







Setting Continuous Bake or 12 Hour Energy Saving

The **TIMER ON/OFF**  and **CLEAN**  pads control the Continuous Bake or 12 Hour Energy Saving features. The oven control has a factory preset built-in 12 Hour Energy Saving feature that will shut off the oven if the oven control is left on for more than 11 hours and 59 minutes. The oven can be programmed to override this feature for Continuous Baking.

INSTRUCTIONS

To set the control for Continuous Bake or 12 Hour Energy Saving features:

1. Press and hold  for 6 seconds (Fig. 1)
2. Press  to switch between the 12 Hour Energy Saving and continuous bake features. Note: "12 hr" (Fig. 2) in the display indicates the control is set for 12 Hour Energy Saving feature and "- - hr" (Fig. 3) indicates the control is set for the Continuous Bake feature.
3. Press  to accept the change (Fig. 4) display will return to time of day) or press  to reject the change.

PRESS

 for 6 seconds



DISPLAY



Fig. 1



Fig. 2



Fig. 3







Fig. 4

Setting Kitchen Timer

The **TIMER ON/OFF**  pad controls the Kitchen Timer feature. The Kitchen Timer serves as an extra timer in the kitchen that will beep when the set time has run out. It does not start or stop cooking. The Kitchen Timer feature can be used during any of the other oven control functions. Refer to "Minimum & Maximum Control Pad Settings" on page 15 for time amount settings.

INSTRUCTIONS

To set the Kitchen Timer (example for 5 minutes):

1. Press . (Fig. 5).
2. Press the number pads to set the desired time in the display (example ). Press . (Fig. 6).
Note: If  is not pressed the timer will return to the time of day.
3. When the set time has run out, "End" and "TIMER" will show in the display (Fig. 7). The clock will sound with 3 beeps every 15 seconds until  is pressed.

PRESS



DISPLAY



Fig. 5



Fig. 6



Fig. 7

To cancel the Kitchen Timer before the set time has run out:

Press . The display will return to the time of day.





Setting Oven Controls

Setting Oven Lockout Feature

The  pad controls the Oven Lockout feature. The Oven Lockout feature automatically locks the oven door, prevents the Warmer Drawer and most oven controls from being turned ON. It does not disable the clock, Kitchen Timer or the interior oven light.

INSTRUCTIONS

1. Press and hold  for 3 seconds (Fig. 1).
2. After 3 seconds a beep will sound, **LOC** & "**DOOR LOCKED**" will flash in the display. Once the oven door is locked the "**DOOR LOCKED**" indicator will stop flashing.

PRESS

 for 3 seconds

DISPLAY



Fig. 1

To reactivate normal oven operation:

1. Press and hold  for 3 seconds. A beep will sound. **LOC** will clear. The "**DOOR LOCKED**" will continue to flash until the oven door has completely unlocked (See Fig. 2).
2. The oven is again fully operational.



 for 3 seconds







Fig. 2

Setting Temperature Display — Fahrenheit or Celsius

The **BROIL**  and **CLEAN**  pads control the Fahrenheit or Celsius temperature display modes. The oven control can be programmed to display temperatures in Fahrenheit or Celsius. The oven has been preset at the factory to display in Fahrenheit.

INSTRUCTIONS

To change display from Fahrenheit to Celsius or Celsius to Fahrenheit:

1. To tell if the display is set for Fahrenheit or Celsius press  (Fig. 3) and hold for 7 seconds; "**550°**" will first appear in the display and then a beep will sound. If "**F**" appears, the display is set to show temperatures in Fahrenheit (Fig. 4). If "**C**" appears, the display is set to show temperatures in Celsius (Fig. 5).
2. Press  to switch between Fahrenheit or Celsius display modes. The display will show either "**F**" (Fig. 4) or "**C**" (Fig. 5).
3. Press  to accept the change or press  to reject the change.

PRESS

 for 7 seconds

DISPLAY



Fig. 3



Fig. 4



Fig. 5



 or 

Setting Oven Controls



Setting Silent Control Operation

The **START TIME** (Start time) and **CLEAN** (Clean) pads control the Silent Control operation feature. The Silent Control operation feature allows the oven control to be operated without sounds or beeps whenever necessary. If desired the control can be programmed for silent operation and later returned to operating with all the normal sounds and beeps.

INSTRUCTIONS

PRESS

DISPLAY

To change control from normal sound operation to silent control operation:

1. To tell if your range is set for normal or silent operation press and hold (Start time) for 7 seconds. (Fig. 1).
2. Press (Clean) to switch between normal sound operation and silent operation mode. The display will show either "SP" (Fig. 2) or "--" (Fig. 3).

If "SP" appears (Fig. 2), the control will operate with normal sounds and beeps. If "--" appears (Fig.3), the control is in the silent operation mode.

3. Press (START) to accept the change or press (Clear /off) to reject the change.

(Start time) for 7seconds

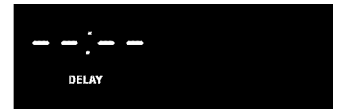

Fig. 1



Fig. 2



Fig. 3

(START) or (Clear /off)



Setting Oven Controls





Setting Bake

The **BAKE**  pad controls normal baking. The oven can be programmed to bake at any temperature from 170°F to 550°F (The sample shown below is for 350°F).

INSTRUCTIONS

To set the Bake Temperature to 350°F:

1. Arrange interior oven racks and place food in oven.
2. Press  (See Fig. 1).
3. Press . A long beep will sound once the oven set temperature reaches 350° F (See Fig. 2).

Note: Pressing  will cancel the Bake feature at any time.

PRESS



DISPLAY







Fig. 1



Fig. 2

To change the Bake Temperature (example changing from 350° to 425°F):

1. After the oven has already been set to bake at 350°F and the oven set temperature needs to be changed to 425°F, press  (See Fig. 2).
2. Press   . 425° will appear in the display.
3. Press  (See Fig. 3).
4. The oven is now set for 425°F.

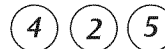



Fig. 3

Setting Oven Controls



Setting Timed Bake

The **BAKE**  and **BAKE TIME**  pads control the Timed Bake feature. The automatic timer of the Timed Bake feature will turn the oven OFF after cooking for the desired amount of time you selected.

INSTRUCTIONS



To program the oven to begin baking immediately and to shut off automatically: (example below to bake at 350°F for 50 minutes):

1. Arrange interior oven rack(s) and place the food in the oven.

2. Press  (See Fig.1).

3. Press  (See Fig. 2).

4. Press  (See Fig.3).

5. Enter the desired baking time by pressing  .

Note: Baking time can be set for any amount of time between 1 minute to 11 hours and 59 minutes. (See Fig. 4)

6. Press  (See Fig. 5)

Note: After the **Timed Bake** feature has activated, press  to display the bake time remaining in the **Timed Bake** mode. Once **Timed Bake** has started baking, a long beep will sound when the oven temperature reaches the set temperature.

Press  when baking has finished or at any time to cancel the **Timed Bake** feature.

When the Timed Bake finishes:

1. "End" and the time of day will show in the display. The oven will shut off automatically (See Fig. 6).
2. The control will beep 3 times. The control will continue to beep 3 times every 30 seconds until  is pressed.

PRESS

DISPLAY



Fig. 1



Fig. 2



Fig. 3



Fig. 4



Fig. 5



Fig. 6

CAUTION Use caution with the **TIMED BAKE** or **DELAYED TIMED BAKE** features. Use the automatic timer when cooking cured or frozen meats and most fruits and vegetables. Foods that can easily spoil such as milk, eggs, fish, meat or poultry, should be chilled in the refrigerator first. Even when chilled, they should not stand in the oven for more than 1 hour before cooking begins, and should be removed promptly when cooking is completed. Eating spoiled food can result in sickness from food poisoning.

















Setting Oven Controls

Setting Delayed Start

The **BAKE** , **BAKE TIME**  and **START TIME**  pads control the Delayed Start. The automatic timer of the Delayed Start will turn the oven ON and OFF at the time you select in advance.

INSTRUCTIONS

To program the oven for a Delay Start and to shut off automatically (example for baking at 375°F for 50 minutes and starting at 5:30):

1. Be sure that the clock is set with the correct time of day.
2. Arrange interior oven rack(s) and place the food in the oven.
3. Press . (See Fig. 1).
4. Enter the desired baking time using the number key pads by pressing   (See Fig. 2). Note: Baking time may be set for any amount of time from 1 minute to 11 hours and 59 minutes.
5. Press . (See Fig. 3).
6. Press  (See Fig.4).
7. Enter the desired start time using the number key pads    (See Fig. 5).
8. Press  (See Fig. 6).
9. Press  (See Fig. 7).
10. Press   .
11. Press  (See Fig. 8).

Note: A long beep will sound when the oven temperature reaches the set temperature once the Delayed Start has started baking,

Press  to display the bake time remaining.

Press  when baking has finished or at any time to cancel the Delay Start feature.

When the set bake time runs out:

1. "End" and the time of day will show in the display. The oven will shut off automatically (Fig. 9).
2. The control will beep 3 times. The control will continue to beep 3 times every 30 seconds until  is pressed.

NOTE: If your clock is set for normal 12 hour display mode the Delayed Start feature can never be set to start more than 12 hours in advance. To set the Delayed Start feature 12-24 hours in advance see page 15 for instructions to set the control for the 24 hour time of day display mode.

PRESS

DISPLAY



Fig. 1



Fig. 2



Fig. 3

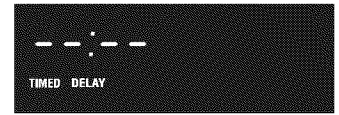

Fig. 4



Fig. 5



Fig. 6

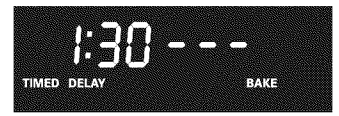

Fig. 7



Fig. 8



Fig. 9



Setting Oven Controls



Setting Broil

The **Broil** pad controls the Broil feature. When broiling, heat radiates downward from the oven broiler for even coverage. The Broil feature is preset to start broiling at 550°F however, the Broil feature temperature may be set at any temperature between 400°F and 550°F.

The broil pan and broil pan insert used together allows dripping grease to drain and be kept away from the high heat of the oven broiler. **DO NOT** use the broil pan without the insert (See Fig. 6; some models). **DO NOT cover the broil pan insert with foil.** The exposed grease could catch fire.

⚠ WARNING Should an oven fire occur, leave the oven door closed and turn the oven OFF. If the fire continues, throw baking soda on the fire or use a fire extinguisher. **DO NOT** put water or flour on the fire. Flour may be explosive and water can cause a grease fire to spread and cause personal injury.

⚠ CAUTION To insure proper results when broiling use **ONLY** Electrolux Home Products, Inc. approved Broil Pan & Insert.

INSTRUCTIONS

To set the oven to broil at the default setting (550°F):

1. Place the broiler pan insert on the broiler pan. Then place the food on the broiler pan insert (some models). **DO NOT** use the broiler pan without the insert. **DO NOT** cover the broiler insert with foil. The exposed grease could ignite.
2. Arrange the interior oven rack and place the broiler pan on the rack. Be sure to center the broiler pan directly under the broiler element. **Make sure the oven door is in the broil stop position** (See Fig. 5).
3. Press **Broil**. (Fig. 1)
4. If a lower broil temperature is desired (minimum broil temperature setting is 400°F), press the desired temperature before continuing to step 5.
5. Press **START**. The oven will begin to broil. (Fig. 2).
6. Broil on one side until food is browned; turn and cook on the second side. Season and serve. **Note:** Always pull the rack out to the stop position before turning or removing food.
7. To cancel broiling or if finished broiling press **Clear/Off** (Fig. 3).

PRESS

DISPLAY



Fig. 1



Fig. 2



Fig. 3

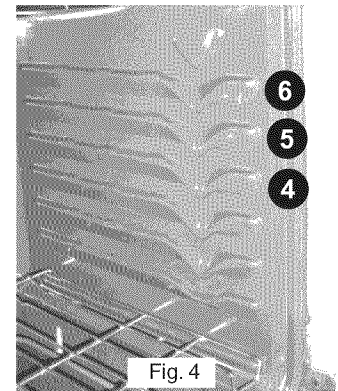

Fig. 4

Recommended Broiling Times

Use the following table for approximate broiling times. Increase or decrease broiling times, or move the broiling pan to a different rack position to suit for doneness. If the food you are broiling is not listed in the table, follow the instructions provided in your cookbook and watch the item closely.

Broiling Table (Refer to Fig. 4)

Food Item	Rack Position	Temp Setting	Cook Time		Doneness
			1st side	2nd side	
Steak 1" thick	5th or 6th	550° F	7:00	5:00	Medium
	5th or 6th	550° F	8:00	6:00	Medium-Well
Pork Chops 3/4" thick	5th	550° F	8:00	6:00	Well
Chicken - Bone In	4th	450° F	20:00	10:00	Well
Chicken - Boneless	5th	450° F	8:00	6:00	Well
Fish	5th	500° F	13:00	n/a	Well
Shrimp	4th	550° F	5:00	n/a	Well
Hamburger 1" thick	6th	550° F	9:00	7:00	Medium
	5th	550° F	10:00	8:00	Well

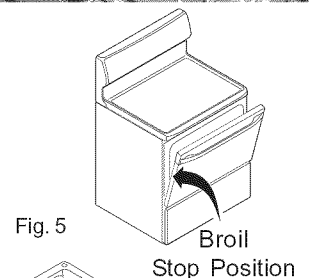

Fig. 5

Broil Stop Position

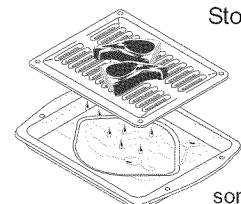

Fig. 6 some models



Setting Oven Controls

Benefits of Convection Bake:

- Some foods may cook up to 25 to 30% faster, saving time and energy.
- Multiple rack baking.
- No special pans or bakeware needed.

Setting Convection Bake

The **CONV BAKE**  pad controls the Convection Bake feature. Use the Convection Bake feature when cooking speed is desired. The oven can be programmed for Convection Bake at any temperature between 170° F (77° C) to 550° F (288° C).

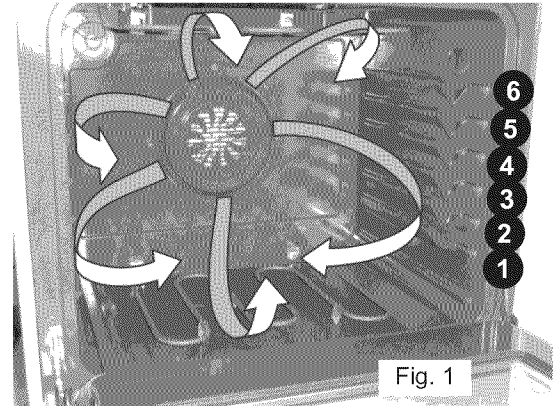



Fig. 1 - Air circulation of Convection Cooking

Convection baking uses a fan to circulate the oven's heat evenly and continuously within the oven (See Fig. 1). This improved heat distribution allows for even cooking and excellent results using multiple racks at the same time. Foods cooked on a single oven rack will generally cook faster and more evenly with Convection Bake. Multiple oven rack cooking may slightly increase cook times for some foods, but the overall result is time saved. Breads and pastries brown more evenly.

Tips for Convection Bake



1. Time reductions will vary depending on the amount and type of food to be cooked. Cookies and biscuits should be baked on pans with no sides or very low sides to allow heated air to circulate around the food. Food baked on pans with a dark finish will cook faster.
2. Preheating is not necessary when cooking casseroles with Convection Bake.
3. When using Convection Bake with a single rack, place oven rack in position 3 or 4. If cooking on multiple racks, place the oven racks in positions 1, 3 and 6 (for 3 racks) and positions 2 and 5 (See Fig. 1).
4. Cakes have better results when baked using the **BAKE**  pad.

INSTRUCTIONS

PRESS

DISPLAY

To set the oven for Convection Bake and temperature to 350°F:

1. Arrange interior oven racks and place food in oven (See Fig. 1).
2. Press . (Fig. 2)
3. Press . A beep will sound once the **adjusted** oven temperature is reached. (Fig. 3).

Note: The oven icon will show a rotating fan within the square. This rotating fan icon indicates when the Convection Fan is operating (See rotating fan in Fig. 3).

Press  to stop Convection Bake or cancel Convection Bake at any time.



Fig. 2



Fig. 3

Setting Oven Controls





Setting Convection Roast

The **CONV ROAST**  pad is designed to give optimum cooking performance for this feature. The Convection Roast pad combines a cook cycle with the convection fan and element to roast meats and poultry. Preheating is not necessary for meats and poultry. Heated air circulates around the food from all sides, sealing in juices and flavors. Foods are crispy brown on the outside while staying moist on the inside.

INSTRUCTIONS

To set the Convection Roast feature (example for Meats to cook at 350°F):

1. Arrange interior oven racks and place food in oven.
2. Press . (See Fig. 1)
3. Press . (See Fig. 2) The convection fan icon will come on.
Press  to stop Convection Roast at any time.

PRESS



DISPLAY



Fig. 1



Fig. 2

Roasting Rack Instructions (some models)

When preparing meats for convection roasting, use the broiler pan and insert along with the roasting rack (if equipped). The broiler pan will catch grease spills and the insert will help prevent grease splatters. The roasting rack will allow the heat to circulate around the meat.

WARNING To prevent food from contacting the broil element and to prevent grease splattering, **DO NOT** use the roasting rack when broiling.

1. Place oven rack on bottom or next to the bottom rack position. See Arranging Oven Racks in the **Before Setting Oven Controls** section.
2. Place the insert in the broiler pan. The roasting rack fits on the insert allowing the heated air to circulate under the food for even cooking and helps to increase browning on the underside. Make sure the roasting rack is securely seated on the insert in the broiler pan. **DO NOT** use the broiler pan without the insert. **DO NOT** cover the insert with aluminum foil.
3. Position food (fat side up) on the roasting rack (See Fig. 4).
4. Place the broiler pan on the oven rack.

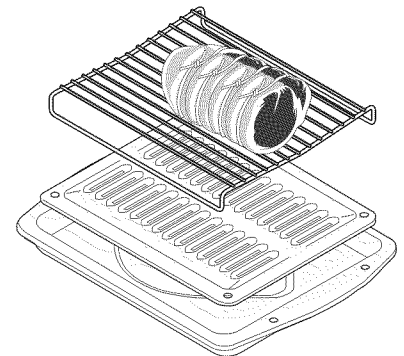



Fig. 4



Setting Oven Controls



To set the Convection Convert Feature

The  **CONV CONVERT** pad is used to automatically convert a standard **baking** recipe for convection baking. When set properly, this feature is designed to display the actual converted (reduced) temperature in display.

Convection Convert **MUST** be used with a **Convection Bake** keypad. When used with a Timed Bake or a Delayed Timed Bake setting, the Convection Convert feature will display a "CF" for check food when the bake time is 75% complete (See Fig. 4). At this time the oven control will sound 3 long beeps at regular intervals until baking has finished. When the bake time has completely finished the control will display "End" and will sound 3 long beeps every 30 seconds until the  pad is pressed (See Fig. 5).

INSTRUCTIONS

Using Convection Convert feature to adjust oven temperature from a Bake recipe (example below when setting oven for 350°F):

1. Arrange interior oven racks and place food in oven.
2. Press  , (See Fig. 1). If a **Cook Time** or a **Delay Start** is desired, enter the times now.
3. Press  . A beep will sound once the **adjusted** oven set temperature is reached. (See Fig. 2).

Notes: When used with a **Cook Time** or a **Delay Start** setting, the **Convection Convert** feature will display a "CF" for check food when the bake time is 75% complete (See Fig. 3). At this time the oven control will sound 3 long beeps at regular intervals until baking has finished. When the bake time has completely finished the control will display "End" and will sound 3 long beeps every 30 seconds until the  pad is pressed (See Fig. 4).

The oven icon will show a rotating fan within the square. This rotating fan icon indicates when the Convection Fan is operating (See Figs 2 or 3)

Press  to cancel Convection feature at any time.

Note: The minimum amount of cook time using the Convection Convert feature with a **Cook Time** or a **Delay Start** function is 20 minutes.

PRESS

DISPLAY



Fig. 1



Fig. 2



Fig. 3



Fig. 4



Setting Oven Controls



Using the Favorite Settings Feature

The **Favorite Setting** pad is used to record and recall your favorite recipe settings. This feature may store and recall from 1 to 3 different settings. The Favorite Setting feature may be used with **Bake** or a **Timed Bake**. This feature will not work with any other function including a **Delay Start** (Delayed Timed Bake) setting..

INSTRUCTIONS

To Program the Oven to record a recipe setting and begin baking (sample shown is for bake at 350°F):

1. Place the food in the oven.
2. Press **Favorite setting**. "BAKE". (See Fig. 1)
3. Within 5 seconds, press **1**. (Note: **2** or **3** may also be used to store a recipe setting. (See Fig. 2).
4. Press **3** **5** **0** (See Fig. 3).
5. Press and hold **START** pad for at least 3 seconds or until a beep sounds. The beep indicates that the recipe setting has been recorded for future recall. (See Fig. 4)

NOTE: The oven will continue to bake unless **Clear/Off** is pressed.

To Begin Baking recalled setting (example below recalling from the number 1 pad) :

1. Place the food in the oven.
2. Press **Favorite setting**. (See Fig. 5).
3. Within 5 seconds, press **1** (See Fig. 3).
4. Press **START**. The oven will begin to immediately cook with the previously recorded recipe (See Fig. 4). The Temperature is recalled and if a Timed Bake was recorded this feature will also recall the cooking time.

Note: If you desire to keep a stored recipe but remove the cook time, press **Favorite setting**, the **1** or **2** or **3** pad (the pad the recipe is stored with). Then press **Bake time**, press **0** and then press and hold the **START** pad for 3 seconds.

PRESS

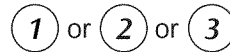

hold **START** for 3 seconds



DISPLAY



Fig. 1

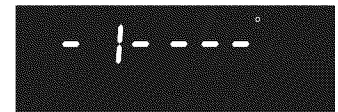

Fig. 2



Fig. 3



Fig. 4



Fig. 5



Setting Oven Controls



To Set the Sabbath Feature (for use on the Jewish Sabbath & Holidays)

The **BAKE TIME** and **START TIME** pads are used to set the Sabbath feature. The Sabbath feature may only be used with the pad. The oven temperature may be set higher or lower after setting the Sabbath feature (the oven temperature adjustment feature should be used only during Jewish Holidays), however the display will not visibly show and no audible tones will be provided when a change occurs. Once the oven is properly set using Bake with the Sabbath feature active, the oven will remain continuously ON until cancelled. This will override the factory preset 12-Hour Energy Saving feature. If the oven light is needed during the Sabbath, press before activating the Sabbath feature. Once the oven light is turned ON and the Sabbath feature is active, the oven light will remain ON until the Sabbath feature is turned OFF. If the oven light needs to be OFF, be sure to turn the oven light OFF before activating the Sabbath feature.

IMPORTANT NOTES: It is not advised to attempt to activate any other program feature except **BAKE** while the Sabbath feature is active. ONLY the following key pads will function correctly with the Sabbath feature: **0-9 number pads**, , & . **ALL OTHER KEYPADS** should not be used once the Sabbath feature is activated.

INSTRUCTIONS

To Program the Oven for 350°F, Begin Baking Immediately and activate the Sabbath feature:

1. Be sure that the clock is set with the correct time of day.
2. Arrange the oven racks and place the food in the oven.
3. Press . (Fig. 1).
4. Press . (See Fig. 3).
5. If a **Timed Bake** or **Delay Start** (Delayed Timed Bake) is needed then enter the time in this step. If not, skip this step and continue to step 6. Refer to the **Timed Bake** or **Delay Start** instructions on pages 21-22. Remember the oven will shut down after completing a **Timed Bake** or **Delay Start** and therefore may only be used once during the Sabbath/Jewish Holidays. The maximum **Delay Start** time is 11 hours & 59 minutes.
6. At the same time press and hold both the and pads for at least 3 seconds. The control will beep and **SAb** will appear in the display (See Fig. 4). Once **SAb** appears in the display the oven control will no longer beep or display any further changes and the oven is properly set for the Sabbath feature.
Note: You may change the oven temperature once baking has started. Press , enter the oven temperature change (170 to 550F°) and press (for Jewish Holidays only). Remember that **the oven control will no longer beep or display any further changes** once the oven is set for the Sabbath feature.
7. The oven may be turned OFF at any time by pressing pad (this will turn the oven OFF only). To turn OFF the Sabbath feature press and hold at the same time both the and pads for at least 3 seconds. **SAb** will disappear from the display.

PRESS

DISPLAY



Fig. 1



Fig. 2



Fig. 3

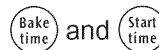



Setting Oven Controls



Setting the Sabbath Feature (cont'd)

It is recommended that any oven temperature change with the Sabbath feature activated be followed with 2 presses of the **START** pad. This will insure the oven remains ON even if the attempt to set the oven temperature was lower or higher than the oven control can accept. If the oven temperature is set incorrectly, the oven temperature will default to 170°F or 550°F. Try to set the desired oven temperature again.

Should you experience a power failure or interruption, the oven will shut off. When power is returned the oven will not turn back on automatically. The oven will remember that it is set for the Sabbath and the food may be safely removed from the oven while still in the Sabbath feature, however the oven cannot be turned back on until after the Sabbath/Holidays. After the Sabbath observance turn OFF the Sabbath feature. At the same time press and hold both the  and  pads for at least 3 seconds. **SAb** will disappear from the display and the oven may be used with all normal functions. For further assistance, guidelines for proper usage, and a complete list of models with the Sabbath feature, please visit the web at <http://www.star-k.org>.

Setting the Keep Warm Feature





The  pad turns ON the Keep Warm feature and will maintain an oven temperature of 170° F. The **Keep Warm** feature will keep oven baked foods warm for serving up to 3 hours after cooking has finished. After 3 hours the Keep Warm feature will shut the oven OFF automatically. The Keep Warm feature may be used without any other cooking operations or can be used after cooking has finished using **TIMED BAKE** or **DELAY START** (Delayed Timed Bake).

INSTRUCTIONS

PRESS

DISPLAY

To set Keep Warm:

1. Arrange interior oven racks and place baked food in oven. If the food is already in the oven go to step 2.
2. Press . (See Fig. 1).
Note: If no further pads are touched within 25 seconds the request to turn ON Keep Warm will be cleared.
3. Press . (See Fig. 2).
4. To turn Keep Warm OFF at any time press  or .

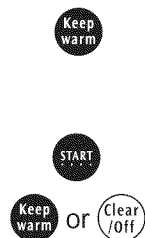





Fig. 1



Fig. 2

To set Keep Warm to turn ON automatically:

1. Arrange interior oven racks and place food in oven. Set the oven properly and start a **Timed Bake** or **Delay Start** (Delayed Timed Bake).
2. Press .
3. Press . "Hld" shows and the oven icon will appear in the display. Keep Warm is set to turn ON automatically after completing a **Timed Bake** or **Delay Start** (Delayed Timed Bake).
4. To turn Keep Warm OFF at any time press  or .



Note: The Keep Warm feature can be turned ON or OFF at anytime without canceling Bake or any other cooking functions by pressing .

To turn ON/OFF the Oven Light

The oven light automatically turns ON when the door is opened. The oven light may also be manually turned ON or OFF by pressing the  pad.



Self-Cleaning

CAUTION During the Self-Cleaning cycle, the outside of the range can become very hot to the touch. **DO NOT** leave small children unattended near the appliance.

CAUTION The health of some birds is extremely sensitive to the fumes given off during the Self-Cleaning cycle of any range. Move birds to another well-ventilated room.

CAUTION DO NOT line the oven walls, racks, bottom or any other part of the range with **aluminum foil**. Doing so will destroy heat distribution, produce poor baking results and cause permanent damage to the oven interior (aluminum foil will melt to the interior surface of the oven).

CAUTION DO NOT force the oven door open. This can damage the automatic door locking system. Use caution when opening the door after the Self-Cleaning cycle is completed. The oven may still be **VERY HOT**.

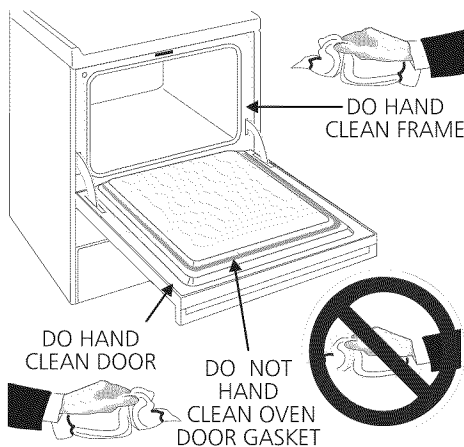

Self-Cleaning Oven

A Self-Cleaning oven cleans itself with high temperatures (well above cooking temperatures) which eliminate soils completely or reduces them to a fine powdered ash you can wipe away with a damp cloth.

Adhere to the following cleaning precautions:

- **DO NOT** use oven cleaners or oven protective coatings in or around any part of the Self-Cleaning oven.
- **DO NOT** clean the oven door gasket. The woven material of the oven door gasket is essential for a good seal. Care should be taken not to rub, damage or remove the gasket.
- **DO NOT** use any cleaning materials on the oven door gasket. Doing so could cause damage.
- **Remove the broiler pan and insert, all utensils and any aluminum foil. These items cannot withstand high cleaning temperatures.**
- Remove oven racks. See "Removing & Replacing Oven Racks" under Before Setting Oven Controls. If they are not removed during the Self-Clean cycle their color will turn slightly blue & the finish will be dull. After the cycle is complete & the oven has cooled, rub the sides of the oven racks with wax paper or a cloth containing a small amount of salad oil (this will make the racks glide easier into the rack positions).
- **Remove any excessive spillovers** in the oven cavity **before** starting the Self-Cleaning cycle. To clean, use hot, soapy water and a cloth. Large spillovers can cause heavy smoke or fire when subjected to high temperatures. **DO NOT** allow food spills with a high sugar or acid content (such as milk, tomatoes, sauerkraut, fruit juices or pie filling) to remain on the surface as they may leave a dull spot even after cleaning.
- Clean any soil from the oven frame, the door liner outside the oven door gasket and the small area at the front center of the oven bottom. These areas heat sufficiently to burn soil on. Clean with soap and water.

CAUTION The oven bake and broil elements may appear to have cooled after they have been turned OFF. The elements may still be hot and burn may occur if these elements are touched before they have cooled sufficiently.

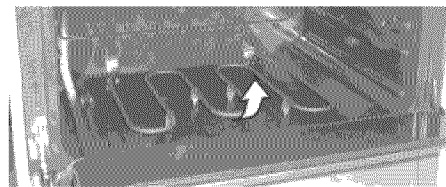

The bake element is designed to be tilted up using your hand from the front of the bake element. This will allow easier access to the oven bottom for cleaning. Be careful not to raise the element more than 4 or 5 inches from the resting position.

NOTES: Prior to setting the Self-Clean cycle, any spills remaining on the oven bottom should be removed. See additional cleaning information for the oven door in the **General Care & Cleaning** section.

Self-Cleaning

Clean

The **SPEED CLEAN** (Speed clean), **CLEAN** (Clean) and **MAXX CLEAN** (Maxx clean) pads are used to start a Self-Cleaning cycle. When used with **START TIME** (Start time) pad, a delayed Self-Cleaning cycle may also be programmed. This feature allows for any Self-Cleaning cycle times from 2 hours (using Speed Clean), 3 hours (using Clean) to 4 hours (using Maxx Clean).

⚠ WARNING During the Self-Cleaning cycle, the outside of the range can become very hot to the touch. **DO NOT** leave small children unattended near the appliance.

⚠ CAUTION **DO NOT** force the oven door open. This can damage the automatic door locking system. Use care when opening the oven door after the Self-Cleaning cycle. Stand to the side of the oven when opening the door to allow hot air or steam to escape. The oven may still be **VERY HOT**.

INSTRUCTIONS

To start an immediate Self-Cleaning cycle or to set a delay start time of 9:00 o'clock and shut off automatically (example provided is a default 3 hour Self-Clean cycle):

1. Be sure the clock is set with the correct time of day, the oven is empty and the oven door is closed.
2. Press (Clean). "CLEAN" will flash, "3:00" (hours) and the Cooktop locked icon will show in the display (See Fig. 1). Note: 2 hours of Self-Cleaning time may be chosen by pressing (Speed clean) or 4 hours by pressing the (Maxx clean) at this time.
3. Press (START). The "DOOR LOCKED" icon will flash; "CLEAN", Cooktop Lockout icon and the letters "CLn" will remain on in the display (Fig. 2).
4. As soon as the control is set, the motor driven oven door lock will begin to close automatically. Once the door has been locked the "DOOR LOCKED" indicator light will quit flashing and remain on. The Cooktop locked icon will remain on (Fig. 3).

PRESS

DISPLAY

(Clean) or
(Speed clean), (Maxx clean) optional.



Fig. 1



Fig. 2



Fig. 3

NOTE: If the optional delay Self-Clean feature is needed, finish steps 5-7. If Self-Clean is started immediately skip the remaining steps and continue with "When the Self-Clean cycle is done" on the following page.

5. Press (Start time) (See Fig. 4). Enter the desired Self-Clean starting time using the number pads (9) (0) (0) (See Fig. 5).
6. Press (START). "CLn" icon will turn off; "DELAY", "DOOR LOCKED", "CLEAN" and Cooktop locked icons will remain on.
7. The control will calculate forward from the set start time to determine when the Self-Cleaning cycle should end. The Self-Cleaning cycle will turn on automatically at the set time. At that time the icon "DELAY" will go out; the oven icon will come on, the start time, Cooktop locked icon, "CLEAN" and "CLn" will remain in the display (See Fig. 6).

(Start time)
(9) (0) (0)



Fig. 4



Fig. 5



Fig. 6



Self-Cleaning

INSTRUCTIONS

When the Self-Clean cycle is done:

1. The time of day, "Hot, DOOR LOCKED" and "CLEAN" icon will remain in the display (See Fig. 7).
2. Once the oven has cooled down for approximately 1 HOUR, and the "DOOR LOCKED" icon is no longer displayed, the oven door can then be opened.

PRESS

DISPLAY



Fig.7

Stopping or Interrupting a Self-Cleaning cycle:

If it becomes necessary to stop or interrupt a Self-Cleaning cycle due to excessive smoke or fire in the oven:



1. Press .
2. Once the oven has cooled down for approximately 1 HOUR and the "DOOR LOCKED" icon is no longer displayed, the oven door can then be opened (Fig. 8).



Fig.8

IMPORTANT NOTES when using the Self-Clean feature:

1. The Self-Clean feature will not operate whenever a radiant surface remains ON.
2. A Self-Clean cycle cannot be started if **Oven Lockout** feature is active.
3. If a Self-Cleaning-Cycle has started but not finished and a power failure occurs, the appliance may not have thoroughly cleaned. Once power is restored, the Cooktop will remain locked. To unlock the cooktop press and hold the  pad for 3 seconds. The red cooktop lock icon will disappear from the display. Then set for another Self-Clean cycle to finish.
4. If your clock is set for normal 12 hour display mode the Delay Self-Clean cycle can never be set to start more than 12 hours in advance. To set for a delayed Self-Cleaning cycle 12-24 hours in advance see page 16 for instructions to set the control for the 24 hour time of day display mode.



Adjusting Your Oven Temperature

The temperature in the oven has been pre-set at the factory. When first using the oven, be sure to follow recipe times and temperatures. If you think the oven is too hot or too cool, the temperature in the oven can be adjusted. Before adjusting, test a recipe by using a temperature setting that is higher or lower than the recommended temperature. The baking results should help you to decide how much of an adjustment is needed.

Note: The oven temperature adjustments made with this feature will not change the Self-Clean cycle temperature.

INSTRUCTIONS

PRESS

DISPLAY

To adjust the oven temperature higher:



1. Press  for 6 seconds (Fig. 1).
2. To increase the temperature use the number pads to enter the desired change. (Example 30°F)   (Fig. 2). The temperature may be increased as much as 35°F (19°C).



Fig. 1

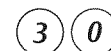

Fig. 2

Adjusting Your Oven Temperature (cont'd)



INSTRUCTIONS

3. Press **START** to accept the temperature change and the display will return to the time of day (Fig. 3). Press **Clear/Off** to reject the change if necessary.

To adjust the oven temperature lower:

1. Press **Bake** for 6 seconds (Fig. 4).
2. To decrease the temperature use the number pads to enter the desired change. (Example -30°F) **3** **0** and then press **Clean** (Fig. 5). The temperature may be decreased as much as 35°F (19°C).
3. Press **START** to accept the temperature change and the display will return to the time of day (Fig. 6). Press **Clear/Off** to reject the change if necessary.

PRESS



DISPLAY



Fig. 3



Fig. 4

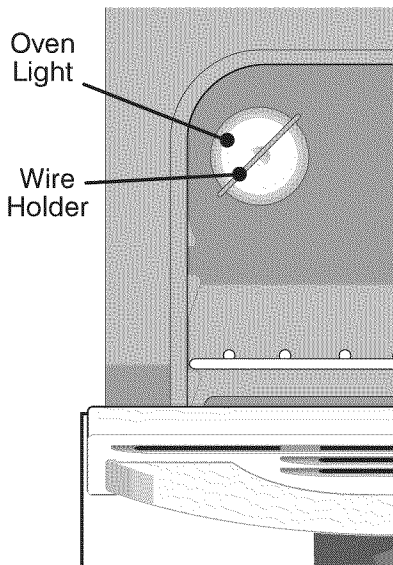

Fig. 5



Fig. 6

Care & Cleaning



Changing the Oven Light

The oven light bulb is located at the rear of the oven and is covered with a glass shield held by a wire holder. The glass shield must be in place whenever the oven is in use.

To replace the oven light bulb:

1. Turn electrical power off at the main source or unplug the range.
2. Press wire holder to one side to release the glass shield.
3. Replace bulb with a new 40 watt appliance bulb.
4. Replace glass shield over bulb and snap wire holder into place.
5. Turn power back on again at the main source (or plug the range back in).
6. The clock will then need to be reset. To reset, see **Setting the Clock and Minute Timer**.

CAUTION Be sure the range is unplugged and all parts are COOL before replacing oven light. Wear a leather-faced glove for protection against possible broken glass.



Care & Cleaning

(Cleaning Table)

Surfaces	How to Clean
Glass, Painted Plastic Body Parts & Control Knobs	<i>For general cleaning</i> , use a soft cloth, clean with mild dish detergent & water or a 50/50 solution of vinegar & water. Follow by rinsing the area with clean water; dry & polish with a soft cloth. Glass cleaners may be used if sprayed on a soft cloth 1st. DO NOT spray liquids directly on the control pad and display areas. DO NOT use large amounts of water on the control panel - excess water on the control area may cause damage to the appliance. DO NOT use other liquid cleaners, abrasive cleaners, scouring pads, or some paper towels - they will damage the finish.
Painted Control Panels & Display areas	<i>Before cleaning the control panel</i> , turn all controls to OFF & remove the control knobs. To remove, pull each knob straight off the shaft. Use the <i>general cleaning</i> instructions provided in the paragraph above.
Porcelain Cooktop Surface, Porcelain Enamel Broiler Pan & Insert (if equipped), Door Liner & Body Parts. For Warmer Drawer cleaning instructions see the Warmer Drawer section.	Gentle scouring with a soapy scouring pad will remove most spots. Rinse with a 1:1 solution of clean water & ammonia. <i>If necessary</i> , cover difficult spots with an ammonia-soaked paper towel for 30 to 40 minutes. Rinse with clean water and a damp cloth, then scrub with a soap-filled scouring pad. Rinse & wipe dry with a clean cloth. Remove all cleaners or the porcelain may become damaged during future heating. DO NOT use spray oven cleaners on the range top. For Warmer Drawer cleaning instructions see the Warmer Drawer section.
Oven Racks	Remove oven racks. See "Removing & Replacing Oven Racks" under Before Setting Oven Controls . Use a mild, abrasive cleaner, following the cleaner's recommendations. Rinse with clean water & let dry. After cleaning the racks, rub the sides of the racks with wax paper or a cloth containing a small amount of salad oil (this will make the racks glide easier into the oven rack positions).
Oven Door	Use soap & water to thoroughly clean the top, sides & front of the oven door. Rinse well. You may use a glass cleaner on the outside glass of the oven door. DO NOT immerse the door in water. DO NOT spray or allow water or the glass cleaner to enter the door vents. DO NOT use oven cleaners, cleaning powders or any harsh abrasive cleaning materials on the outside of the oven door. DO NOT clean the oven door gasket. The oven door gasket is made of a woven material, on Self-Cleaning models, which is essential for a good seal. Care should be taken not to rub, damage or remove this gasket.
Easy Care™ Stainless Steel (some models)	Your range finish may be made with Easy Care™ Stainless Steel (some models). Clean the stainless with warm soapy water using a clean sponge or cloth. Rinse with clean water and dry with a soft clean cloth. DO NOT use ANY store bought cleaners like Stainless Steel cleaners or any other types of cleaners containing any abrasive, chlorides, chlorines or ammonia. It is recommended to use mild dish soap and water or a 50/50 solution of water and vinegar.
Ceramic Cooktop	See Cooktop Cleaning and Maintenance in the General Care & Cleaning section.

Care & Cleaning



Cooktop Cleaning & Maintenance

Consistent and proper cleaning is essential to maintaining your ceramic glass cooktop.

Prior to using your cooktop for the first time, apply the recommended cooktop cleaning creme to the ceramic surface (visit www.frigidaire.com for replacement cleaner). Buff with a **non-abrasive** cloth or no-scratch cleaning pad. This will make cleaning easier when soiled from cooking. The special cooktop cleaning cream leaves a protective finish on the glass to help prevent scratches and abrasions.

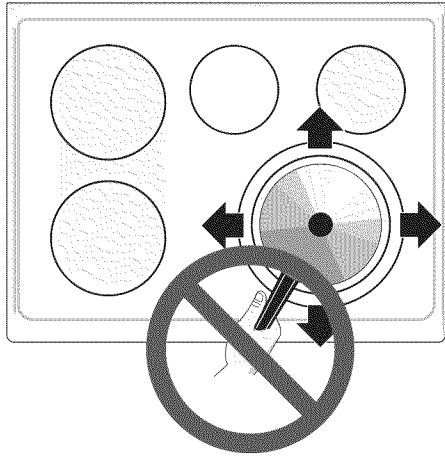

Sliding aluminum or copper clad bottom pans on the cooktop can cause metal markings on the cooktop surface. These marks should be removed **immediately** after the cooktop has cooled using the cooktop cleaning cream. Metal marks can become permanent if not removed prior to future use.

Cookware (cast iron, metal, ceramic or glass) with rough or dirty bottoms can mark or scratch the cooktop surface. **Do not slide anything metal or glass** across the cooktop. **Do not use cookware with dirt or dirt build up on bottom**; replace with clean cookware before using. **Do not** use your cooktop as a cutting board or work surface in the kitchen. **Do not** cook foods directly on the cooktop surface without a pan. **Do not** drop heavy or hard objects on the ceramic glass cooktop, they may cause it to crack.

CAUTION Before cleaning the cooktop, be sure the controls are turned to **OFF** and the cooktop is **COOL**.

WARNING **DO NOT** use a cooktop cleaner on a hot cooktop. The fumes can be hazardous to your health, and can chemically damage the ceramic-glass surface.

Cleaning Recommendations for the Ceramic Glass Cooktop

For light to moderate soil:

Apply a few drops of CookTop® Cleaning Creme directly to the cooktop. Use a paper towel or use a **non-abrasive** plastic type no-scratch cleaning pad to clean the entire cooktop surface. Make sure the cooktop is cleaned thoroughly, leaving no residue.

For heavy, burned on soil:

Apply a few drops of CookTop® Cleaning Creme directly to the soiled area. Rub the soiled area using a **non-abrasive** plastic type no-scratch cleaning pad, applying pressure as needed. Do not use the pad you use to clean the cooktop for any other purpose.

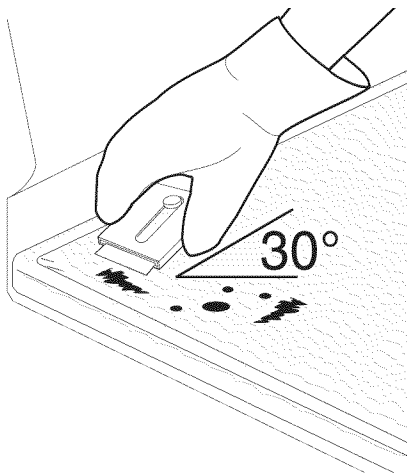

If soils remain, carefully scrape soils with a metal razor blade scraper, holding scraper at a 30 degree angle to the surface. Remove loosened soils with cooktop cleaning cream and buff surface clean.

IMPORTANT NOTE: Damage to the ceramic glass cooktop may occur if you use an abrasive type cleaning pad. Only use cleaning products that have been specifically designed for ceramic glass cooktops.

Plastic or foods with a high sugar content:

These types of soils need be removed immediately if spilled or melted onto the ceramic cooktop surface. Permanent damage (such as pitting of the cooktop surface) may occur if not removed **immediately**. After turning the surface elements **OFF**, use a razor blade scraper or a metal spatula with a mitt and scrape the soil from the hot surface (as illustrated). Allow the cooktop to cool, and use the same method for heavy or burned on soils.



Care & Cleaning



Do not use the following on the ceramic glass cooktop:

- Do not use abrasive cleaners and scouring pads, such as metal and some nylon pads. They may scratch the cooktop, making it more difficult to clean.
- Do not use harsh cleaners, such as chlorine bleach, ammonia or oven cleaners, as they may etch or discolor the cooktop.
- Do not use dirty sponges, cloths or paper towels, as they can leave soil or lint on the cooktop which can burn and cause discoloration.

Special Caution for Aluminum Use on the Ceramic Cooktop:

- **Aluminum Foil** - Use of aluminum foil on a hot cooktop will damage the ceramic cooktop. Do not use thin aluminum cooking utensils or allow aluminum foil to touch the ceramic cooktop under ANY circumstances.
- **Aluminum utensils** - The melting point of aluminum is much lower than that of other metals. Care must be taken when aluminum pots or pans are used on the cooktop. If allowed to boil dry, not only will the utensil be destroyed, but it may fuse to, break or mark the ceramic glass surface, permanently damaging the cooktop surface.

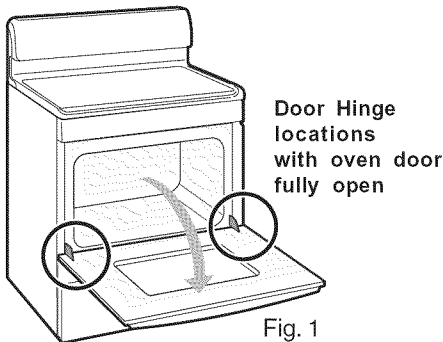

Fig. 1

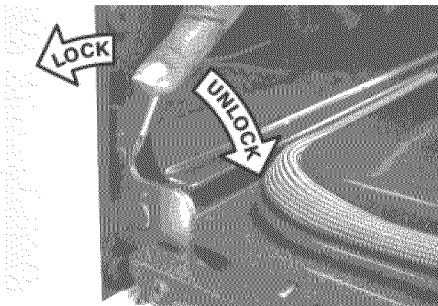

Fig. 2

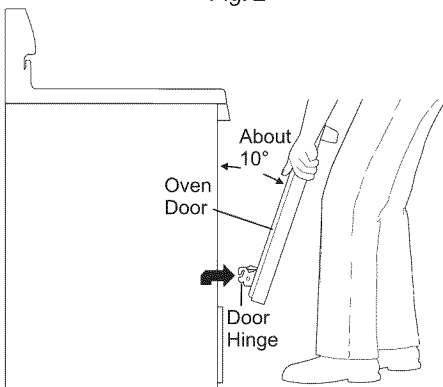

Fig. 3

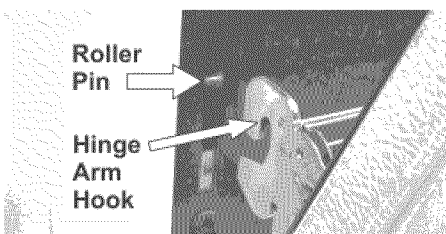

Fig. 4

Removing & Replacing the Lift-Off Oven Door

⚠ CAUTION The door is heavy. For safe, temporary storage, lay the door flat with the inside of the door facing down.

To Remove Oven Door:

1. Open oven door completely (horizontal with floor - See Fig. 1).
2. Pull the door hinge locks on both left and right door hinges down from the oven frame completely towards the oven door (See Fig. 2). A tool such as a small flat-blade screwdriver may be required.
3. Firmly grasp both sides of oven door along the door sides (Do not use the oven door handle - See Fig. 3).
4. Close the door to the broil stop position (the oven door will stop into this position just before fully closing).
5. With the oven door in the broil stop position, lift the oven door hinge arms over the roller pins located on each side of the oven frame (See Fig. 4).

To Replace Oven Door:

1. Firmly grasp both sides of oven door along the door sides (Do not use the oven door handle - See Fig. 3).
2. Holding the oven door at the same angle as the removal position, seat the hook of the hinge arm over the roller pins located on each side of the oven door frame (See Fig. 4). The hook of the hinge arms must be fully seated onto the roller pins.
3. Fully open the oven door (horizontal with floor - See Fig. 1).
4. Push the door hinge locks up towards and into the oven frame on both left and right oven door hinges (See Fig. 2) to the locked position.
5. Close the oven door.

Door Care Instructions - Most oven doors contain glass that can break. Read the following recommendations:

1. Do not close the oven door until all the oven racks are fully in place.
2. Do not hit the glass with pots, pans, or any other object.
3. Scratching, hitting, jarring or stressing the glass may weaken its structure causing an increased risk of breakage at a later time.

Before You Call

Solutions to Common Problems



Before you call for service, review the following list. It may save you time & expense. The list includes common occurrences (shown in bold) that are not the result of defective workmanship or materials in this appliance. The possible corrections to these problems are provided with the problem listed:

Range is not level - (1) Poor installation. Place oven rack in center of oven. Place a level on the oven rack. Adjust leveling legs at base of range until the oven rack is level. (2) Be sure floor is level, strong & stable enough to adequately support range. (3) If floor is sagging or sloping, contact a carpenter to correct the situation. (4) Kitchen cabinet alignment may make range appear not level. Be sure cabinets are square & have sufficient room for range clearance.

Cannot move appliance easily. Appliance must be accessible for service - (1) Cabinets not square or are built in too tightly. Contact builder or installer to make appliance accessible. (2) Carpet interferes with range. Provide sufficient space so range can be lifted over carpet.

Surface element too hot or not hot enough - Incorrect control setting. Be sure the correct control is ON.

Surface element does not heat - (1) Lightweight or warped pans used. Use only flat, evenly balanced, medium or heavyweight cookware. Flat pans heat better than warped pans. Cookware materials and weight of the material affect heating. Heavy & medium-weight pans heat evenly. Because lightweight pans heat unevenly, foods may burn easily. (2) No power to the appliance. Check steps under "**Entire Appliance Does Not Operate**" in this checklist. (3) Incorrect control setting. Make sure the correct control is ON.

Entire appliance does not operate - (1) The time of day is not set. The time of day **must** first be set in order to operate the oven. See "To Set the Clock" in the **Setting Oven Controls** section. (2) Make sure cord/plug is plugged correctly into outlet. (3) Service wiring is not complete. Contact your authorized service agent. (4) Electrical power outage. Check house lights to be sure. Call your local electric company for service.

Oven does not operate - Be sure the oven controls are set properly for the desired function. See **Setting Oven Controls** in this Use & Care Manual or read the instructions "**Entire appliance does not operate**" in this checklist.

Oven light does not work (some models) - Replace or tighten bulb. See **Changing Oven Light** in the Use & Care Manual.

Oven control beeps & displays any F code error (for example F11) - Electronic control has detected a fault condition. Press **CLEAR/OFF** to clear the display & stop beeping. Reprogram oven. If fault recurs, record fault number. Press **CLEAR/OFF** & contact an authorized service agent.

Oven smokes excessively during broiling - (1) Control(s) not set properly. Follow Broil instructions under **Setting Oven Controls**. (2) Make sure oven door is opened to **broil stop** position. (3) Meat too close to the broil element. Reposition the broil rack to provide proper clearance between the meat & the element. Preheat the broil element for searing. (4) Meat not properly prepared. Remove excess fat from meat. Cut fatty edges to prevent curling, but do not cut into lean. (5) Insert on broiler pan wrong side up & grease not draining. Always place grid on the broiler pan with ribs up & slots down to allow grease to drip into pan (some models). (6) Grease has built up on oven surfaces. Regular cleaning is necessary when broiling frequently. Old grease or food spatters cause excessive smoking.

Flames inside oven or smoking from oven vent - Excessive spillovers in oven. For example this will happen for pie spillovers or large amounts of grease left on the oven bottom. Wipe up excessive spillovers before starting oven. If flames or excessive smoke are present see "Broiling" in the **Setting Oven Controls** section.

Poor baking results - Many factors affect baking results. Make sure the proper oven rack position is used. Center food in the oven & space pans to allow air to circulate. Allow the oven to preheat to the set temperature before placing food in the oven. Try adjusting the recipe's recommended temperature or baking time. If you feel the oven is too hot or cool, see **Adjusting Your Oven Temperature** in this Use & Care Manual.

Soil not completely removed after Self-Cleaning cycle - Failure to clean bottom, front top of oven, frame of oven or door area outside oven seal. These areas are not in the Self-Cleaning area, but get hot enough to burn on residue. Clean these areas before the Self-Cleaning cycle is started. Burned-on residue can be cleaned with a stiff nylon brush and water or a nylon scrubber. Be careful not to damage the oven gasket.

Self-Cleaning cycle does not work - (1) Oven control not set properly. Follow instructions under **Self-Cleaning**. (2) Self-Cleaning cycle was interrupted. Follow steps under "Stopping or Interrupting a Self-Cleaning Cycle" under **Self-Cleaning**.

Metal marks (Ceramic Cooktop) - Sliding or scraping of metal utensils on cooktop surface. Do not slide metal utensils on cooktop surface. Use a ceramic-glass cooktop cleaning creme to remove the marks. See "Cooktop Cleaning and Maintenance" in the **Care & Cleaning** section.

Scratches or abrasions on cooktop surface (Ceramic Cooktop) - (1) Coarse particles such as salt or sand between cooktop and utensils can cause scratches. Be sure cooktop surface and bottoms of utensils are clean before usage. Small scratches do not affect cooking and will become less visible with time. (2) Cleaning materials not recommended for ceramic-glass cooktop have been used. See "**Cooktop Cleaning & Maintenance**." (3) Cookware with rough bottom has been used. Use smooth, flat-bottomed cookware.

Brown streaks or specks on cooktop surface (Ceramic Cooktop) - Boilovers are cooked onto surface. Use razor blade scraper to remove soil. See "Cooktop Cleaning and Maintenance" in the **Care & Cleaning** section.

Areas of discoloration with metallic sheen (Ceramic Cooktop) - Mineral deposits from water and food. Remove using a ceramic-glass cooktop cleaning creme. Use cookware with clean, dry bottoms.



Major Appliance Warranty Information

Your appliance is covered by a one year limited warranty. For one year from your original date of purchase, Electrolux will pay all costs for repairing or replacing any parts of this appliance that prove to be defective in materials or workmanship when such appliance is installed, used and maintained in accordance with the provided instructions.

Exclusions **This warranty does not cover the following:**

1. Products with original serial numbers that have been removed, altered or cannot be readily determined.
2. Product that has been transferred from its original owner to another party or removed outside the USA or Canada.
3. Rust on the interior or exterior of the unit.
4. Products purchased "as-is" are not covered by this warranty.
5. Food loss due to any refrigerator or freezer failures.
6. Products used in a commercial setting.
7. Service calls which do not involve malfunction or defects in materials or workmanship, or for appliances not in ordinary household use or used other than in accordance with the provided instructions.
8. Service calls to correct the installation of your appliance or to instruct you how to use your appliance.
9. Expenses for making the appliance accessible for servicing, such as removal of trim, cupboards, shelves, etc., which are not a part of the appliance when it is shipped from the factory.
10. Service calls to repair or replace appliance light bulbs, air filters, water filters, other consumables, or knobs, handles, or other cosmetic parts.
11. Surcharges including, but not limited to, any after hour, weekend, or holiday service calls, tolls, ferry trip charges, or mileage expense for service calls to remote areas, including the state of Alaska.
12. Damages to the finish of appliance or home incurred during installation, including but not limited to floors, cabinets, walls, etc.
13. Damages caused by: services performed by unauthorized service companies; use of parts other than genuine Electrolux parts or parts obtained from persons other than authorized service companies; or external causes such as abuse, misuse, inadequate power supply, accidents, fires, or acts of God.

DISCLAIMER OF IMPLIED WARRANTIES; LIMITATION OF REMEDIES

CUSTOMER'S SOLE AND EXCLUSIVE REMEDY UNDER THIS LIMITED WARRANTY SHALL BE PRODUCT REPAIR OR REPLACEMENT AS PROVIDED HEREIN. CLAIMS BASED ON IMPLIED WARRANTIES, INCLUDING WARRANTIES OF MERCHANTABILITY OR FITNESS FOR A PARTICULAR PURPOSE, ARE LIMITED TO ONE YEAR OR THE SHORTEST PERIOD ALLOWED BY LAW, BUT NOT LESS THAN ONE YEAR. ELECTROLUX SHALL NOT BE LIABLE FOR CONSEQUENTIAL OR INCIDENTAL DAMAGES SUCH AS PROPERTY DAMAGE AND INCIDENTAL EXPENSES RESULTING FROM ANY BREACH OF THIS WRITTEN LIMITED WARRANTY OR ANY IMPLIED WARRANTY. SOME STATES AND PROVINCES DO NOT ALLOW THE EXCLUSION OR LIMITATION OF INCIDENTAL OR CONSEQUENTIAL DAMAGES, OR LIMITATIONS ON THE DURATION OF IMPLIED WARRANTIES, SO THESE LIMITATIONS OR EXCLUSIONS MAY NOT APPLY TO YOU. THIS WRITTEN WARRANTY GIVES YOU SPECIFIC LEGAL RIGHTS. YOU MAY ALSO HAVE OTHER RIGHTS THAT VARY FROM STATE TO STATE.

If You Need Service

Keep your receipt, delivery slip, or some other appropriate payment record to establish the warranty period should service be required. If service is performed, it is in your best interest to obtain and keep all receipts. Service under this warranty must be obtained by contacting Electrolux at the addresses or phone numbers below.

This warranty only applies in the USA and Canada. In the USA, your appliance is warranted by Electrolux Major Appliances North America, a division of Electrolux Home Products, Inc. In Canada, your appliance is warranted by Electrolux Canada Corp. Electrolux authorizes no person to change or add to any obligations under this warranty. Obligations for service and parts under this warranty must be performed by Electrolux or an authorized service company. Product features or specifications as described or illustrated are subject to change without notice.

USA
1.800.944.9044
Electrolux Major Appliances
North America
P.O. Box 212378
Augusta, GA 30907



Canada
1.800.668.4606
Electrolux Canada Corp.
5855 Terry Fox Way
Mississauga, Ontario, Canada
L5V 3E4