

quick start guide

- 1 disc playback
- 2 remote control functions
- 3 connecting the speakers
- 4 connecting the video out to your tv
- 5 connecting audio from external components
- 6 listening to radio

5.1CH Blu-ray Home Theater System HT-BD2E

1 disc playback

1. Insert a disc into the disc slot.
 - Insert a disc so that the label side faces upward.
 - Playback starts automatically.
2. To eject the disc, press the **EJECT** button.
 - When you stop disc play, the player remembers where you stopped, so when you press **PLAY/PAUSE** (⏮) button again, it will pick up where you left off.
 - Press the **STOP** (⏹) button twice during playback to disable the Resume function.
 - To pause the playback, press the **PLAY/PAUSE** (⏮) button during playback. To resume, press the **PLAY/PAUSE** (⏮) button once again.

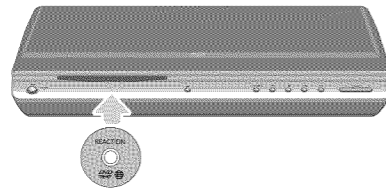

Thank you for purchasing this Samsung 5.1CH Blu-ray Home Theater System. We have manufactured this product to provide you with many hours of Audio/Video Entertainment. This "QUICK START GUIDE" guide has been included to get you up and running in the least amount of time as possible.

If you have any questions or comments relating to Samsung products, please contact the SAMSUNG customer care center.

Samsung Electronics America, Inc.
1-800-SAMSUNG (7267864)
www.samsung.com/us

2 remote control functions

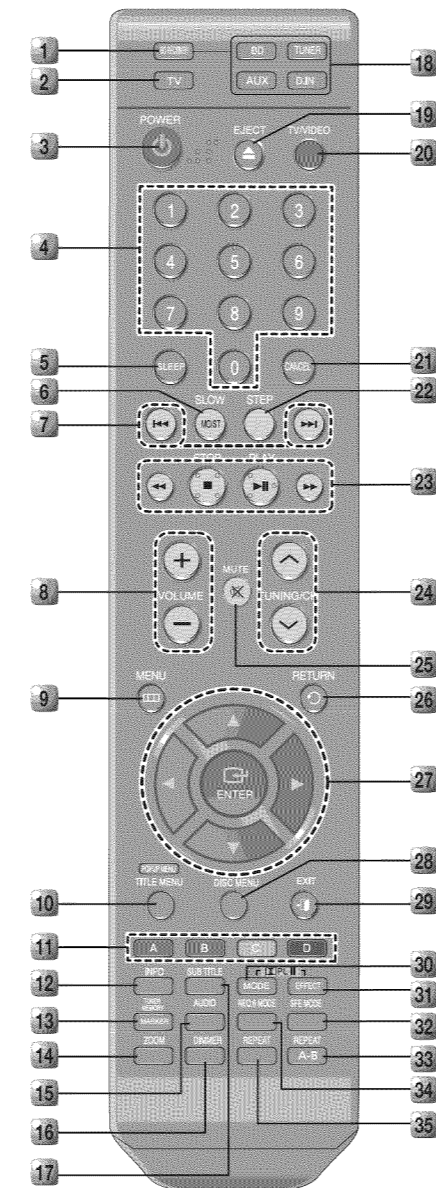

- | | |
|---|--|
| <p>1 BD RECEIVER button
You can operate your BD receiver(Blu-ray Home Theater) with the remote control.</p> <p>2 TV button
You can operate your Samsung TV with the remote control.</p> <p>3 POWER button
Press to turn the Blu-ray Home Theater or your Samsung TV On/Off.</p> <p>4 Number (0-9) buttons</p> <p>5 SLEEP button
Press to set the sleep off time.</p> <p>6 SLOW button
Selects three different slow motion playback speeds.</p> <p>7 MO/ST button
You can listen to radio broadcasts in MONO or STEREO.</p> <p>8 Tuning Preset/CD Skip buttons
Tune in radio broadcasting, skip the song/scene.</p> <p>9 VOLUME button
Press + to raise the volume and - to lower it.</p> <p>10 MENU button
Press to see the menu.</p> <p>11 POPUP MENU, TITLE Menu button
Use this to enter the popup menu/title menu.</p> <p>12 Color buttons
Allow access to common functions of the Blu-ray Home Theater such as the Music or Photo List.</p> <p>13 INFO button
View or change disc playback information on screen.</p> <p>14 TUNER MEMORY, MARKER button
Press to memorize radio frequencies.</p> <p>15 ZOOM button
Enlarges the picture during disc playback.</p> <p>16 AUDIO button
Selects the disc Audio language.</p> <p>17 DIMMER button
The front display brightness will be adjusted.</p> <p>18 SUBTITLE button
Selects the disc subtitle language.</p> <p>BD BD button
Press to select the BD/DVD mode.</p> <p>TUNER TUNER button
Press to listen to radio broadcasting.</p> <p>AUX AUX button
Press to select external audio input.</p> <p>D.IN D.IN button
Press to select external digital input.</p> | <p>19 EJECT button
Press to eject the disc.</p> <p>20 TV/VIDEO button
Press to select TV in VIDEO mode.</p> <p>21 CANCEL button
Used to cancel a wrong entry.</p> <p>22 STEP button
The picture moves forward one frame each time the button is pressed during playback.</p> <p>23 PLAY/PAUSE button
Press to play or pause.</p> <p>24 STOP button
Press to stop.</p> <p>25 SEARCH buttons
Fast backward or forward through a song/scene.</p> <p>26 TUNING/CH button
Press to select the channel or to tune in radio broadcasting.</p> <p>27 MUTE button
Press to mute the sound.</p> <p>28 RETURN button
Press to return to the previous menu.</p> <p>29 Cursor/ENTER button
Used to select or move up/down, left/right when setting the menu function.</p> <p>30 DISC MENU button
Use this to enter the disc menu.</p> <p>31 EXIT button
Press to exit the setup screen.</p> <p>32 DOLBY II MODE button
Allows you to select six different Dolby Pro Logic II audio modes.</p> <p>33 DOLBY II EFFECT button
Adjusts the Dolby Pro Logic II audio effect.</p> <p>34 SFE (Sound Field Effect) MODE button
You can select a sound mode suited for the type of music you're listening to.</p> <p>35 REPEAT A-B button
Allows you to repeat playback of a certain section.</p> <p>36 NEO:6 MODE button
You can enjoy 2 channel or DTS audio signals over 5.1 channels.</p> <p>37 REPEAT button
Repeat playback of a chapter, title, group or track.</p> |
|---|--|

3 connecting the speakers

1. Press down the terminal tab on the back of the speaker.
2. Insert the black wire into the black terminal (-) and the red wire into the red (+) terminal, and then release the tab.
3. Connect the connecting plugs to the back of the Blu-ray Home Theater by matching the colors of the speaker plugs to the speaker jacks.

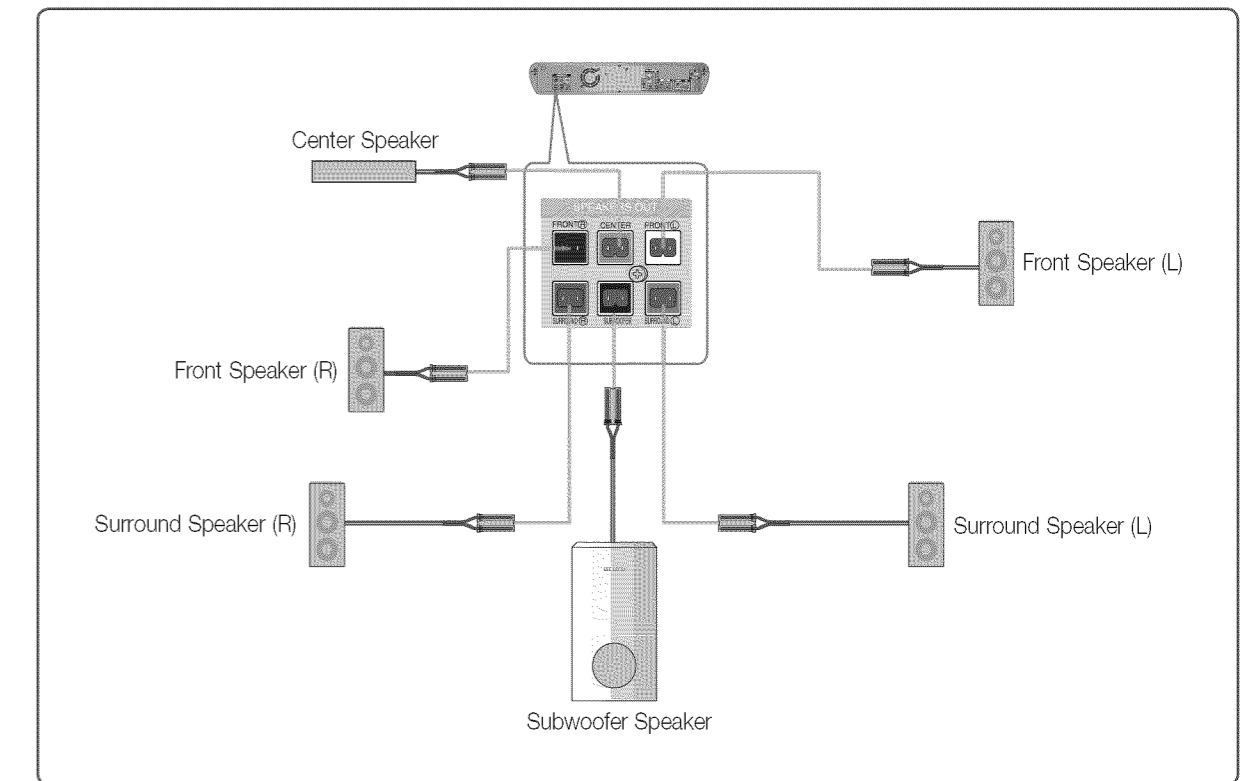
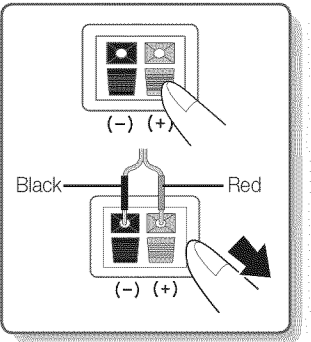

- ! Do not let children play with or near the speakers. They could get hurt if a speaker falls.
 - When connecting the speaker wires to the speakers, make sure that the polarity (+/-) is correct.
 - Keep the subwoofer speaker out of reach of children so as to prevent children from inserting their hands or alien substances into the duct (hole) of the subwoofer speaker.
 - Do not hang the subwoofer on the wall through the duct (hole).
- ✍ If you place a speaker near your TV set, screen color may be distorted because of the magnetic field generated by the speaker. If this occurs, place the speaker away from your TV set.

4 connecting the video out to your tv

Choose one of the three methods for connecting to a TV.

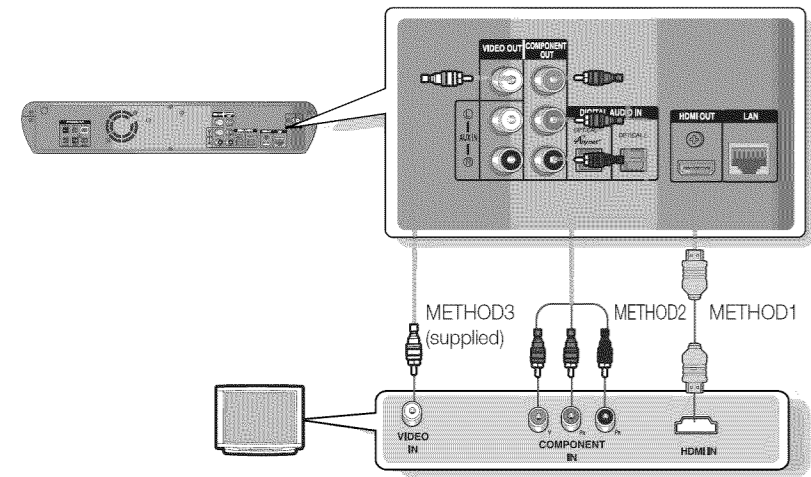

METHOD 1 : HDMI

Connect the HDMI cable(not supplied) from the HDMI OUT jack on the back of the Blu-ray Home Theater to the HDMI IN jack on your TV.

METHOD 2 : Component Video

If your television is equipped with Component Video inputs, connect a Component video cable(not supplied) from the Component Video Output (Pr, Pb and Y) Jacks on the back of the Blu-ray Home Theater to the Component Video Input Jacks on your TV.

METHOD 3 : Composite Video

Connect the supplied Video cable from the VIDEO OUT jack on the back of the Blu-ray Home Theater to the VIDEO IN jack on your TV.

- Depending on your TV, certain HDMI output resolutions may not work.
- If an HDMI cable is connected from the player to a TV, the Blu-ray Home Theater's output is set to HDMI automatically within 10 seconds.
- If Component and HDMI are both connected, HDMI mode is automatically selected.
- When you connect the player to the TV using the HDMI cable for the first time or to a new TV, the HDMI output resolution will be automatically set to the highest provided by the TV.
- If you connect a Samsung TV to the Blu-ray Home Theater using an HDMI cable, the player can be easily operated using the TV remote control. (This is only available with Samsung TVs that support the Anynet+ feature.)
- If the HDMI cable is connected or removed during playback of a CDDA, MP3 or JPEG file, the player will stop playing.
- After making the video connection, set the Video input source on your TV to match the Corresponding Video output (HDMI, Component or Composite) on your Home theater. See your TV owner's manual for more information on how to select the TV's Video Input source.
- The actual resolution may differ from the setting in the SETUP menu if both Component and HDMI cables are connected. The resolution may also be different depending on the disc.
- If the resolution is set to 'i' (ex: 480i or 1080i), the output is displayed in 30 frames per second and if set to 'p' (ex: 480p, 720p, 1080p), it will be displayed in 60 frames per second.
i : interlaced mode (30 frames) p : progressive mode (60 frames)

Resolution according to the output mode

• BD playback

Setup	Output	HDMI	Component	VIDEO
1080p, Movie Frame(24Fs) off		1080p@60F	1080i	480i
1080p/1080i, Movie Frame (24Fs) on		1080p@24F	1080i	480i
1080i, Movie Frame (24Fs) off		1080i	1080i	480i
720p		720p	720p	480i
480p		480p	480p	480i
480i		480P	480i	480i

• DVD playback

Setup	Output	HDMI	Component	VIDEO
1080p		1080p@60F	480p	480i
1080i		1080i	480p	480i
720p		720p	480p	480i
480p		480p	480p	480i
480i		480P	480i	480i

- Please refer to user guide for more detail.

5 connecting audio from external components

OPTICAL : Connecting an External Digital Component

Digital signal components such as a Cable Box/Satellite receiver (Set-Top Box).

- Connect the Digital Input (OPTICAL 1 or OPTICAL 2) on the Blu-ray Home Theater to the Digital Output of the external digital component.
- Press the **D.IN** button on the remote control to select **D.IN 1** or **D.IN 2** input.
 - You can also use the **FUNCTION** button on the main unit.

The mode switches as follows :
BD/DVD → D.IN 1 → D.IN 2 → AUX → FM

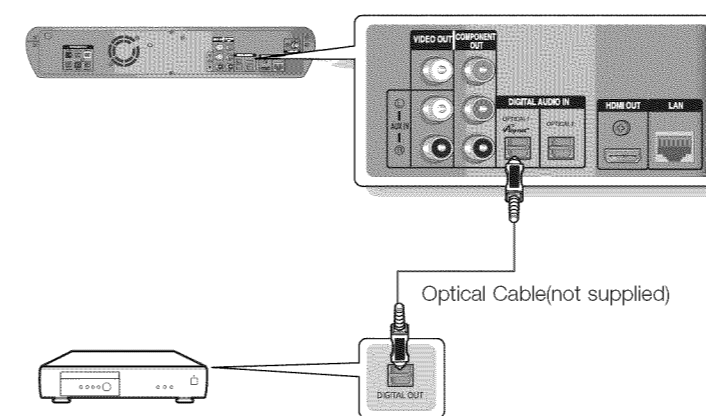

- To see video from your Cable Box/Satellite receiver, you must connect it's video output to a TV.

6 listening to radio

Connecting the FM Antenna

- Connect the FM antenna supplied to the FM 75Ω COAXIAL Jack.
- Slowly move the antenna wire around until you find a location where reception is good, then fasten it to a wall or other rigid surface.

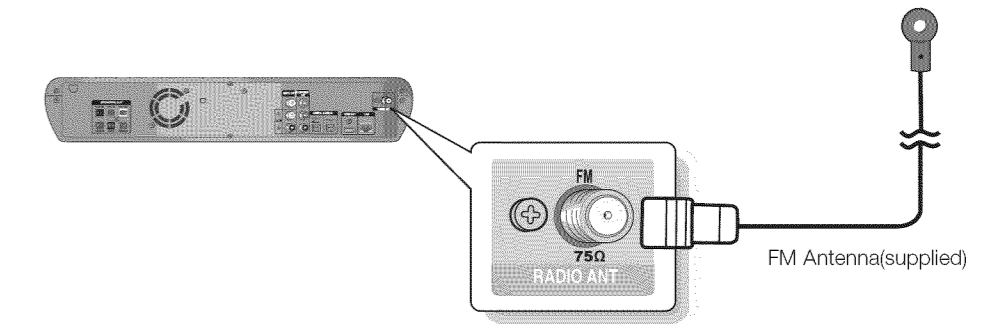

- This unit does not receive AM broadcasts.

Listening to Radio

Remote Control

- Press the **TUNER** button to select the FM band.
- Tune in to the desired station.
 - Automatic Tuning 1 : When the **SKIP** (⊖ ⊖) button is pressed, a preset broadcast station is selected.
 - Automatic Tuning 2 : Press and hold the **TUNING/CH** (⊕ ⊕) button to automatically search for active broadcasting stations.
 - Manual Tuning : Briefly press the **TUNING/CH** (⊕ ⊕) button to increase or decrease the frequency incrementally.

Main Unit

- Press the **FUNCTION** button to select the FM band.
- Select a broadcast station.
 - Automatic Tuning 1 : Press the **STOP** (⊙) button to select **PRESET** and then press the **SKIP** (⊖ ⊖) button to select the preset station.
 - Automatic Tuning 2 : Press the **STOP** (⊙) button to select **MANUAL** and then press and hold the **SKIP** (⊕ ⊕) button to automatically search the band.
 - Manual Tuning : Press the **STOP** (⊙) button to select **MANUAL** and then briefly press the **SKIP** (⊖ ⊖) button to tune in to a lower or higher frequency.