

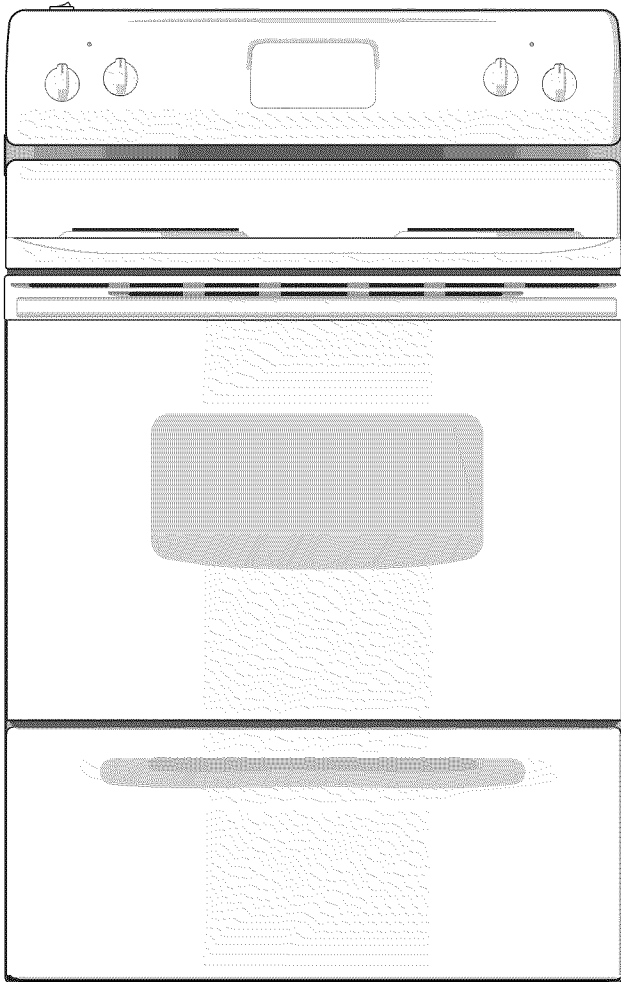











Use & Care Manual



Electric Range

ES100 Control with Coil Surface Elements

Welcome	2	
Important Safety Instructions	2-4	
Before Setting Oven Controls	4-5	
Oven Control Functions	5-6	
Setting Surface Controls	6	
Setting Oven Controls	7	
Adjusting Your Oven Temperature (some models)	8	
General Care & Cleaning	8-10	
Before You Call Solutions to Common Problems	11	
Warranty	Back Page	



Welcome & Congratulations

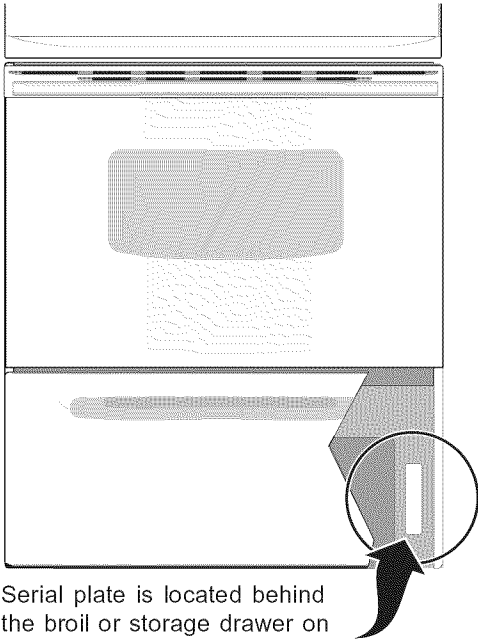

Serial plate is located behind the broil or storage drawer on the lower right side of the appliance frame.

Congratulations on your purchase of a new range! At **Crosley Corporation**, we are very proud of our product and are completely committed to providing you with the best service possible. Your satisfaction is our number one priority.

We know you'll enjoy your new range and **Thank You** for choosing our product. We hope you consider us for future purchases.

PLEASE CAREFULLY READ AND SAVE THESE INSTRUCTIONS

This Use & Care Manual provides specific operating instructions for your model. Use your appliance only as instructed in this manual. These instructions are not meant to cover every possible condition or situation that may occur. Common sense & caution must be practiced when installing, operating & maintaining any appliance.

Please record your model and serial numbers below for future reference.

Model Number: _____

Serial Number: _____

Purchase Date: _____

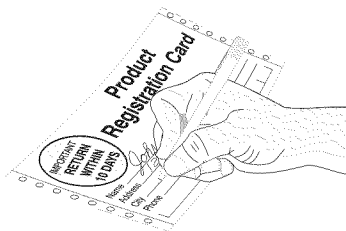

This Use & Care Manual contains general operating instructions for your appliance and feature information for several models. Your range **may not** have all the described features. The graphics shown are representative. The graphics on your range may not look exactly like those shown.

Product Registration

Be sure to register your product. The self-addressed **PRODUCT REGISTRATION CARD** should be filled in completely, signed and returned to Crosley Corporation.



Important Safety Instructions

**Read all instructions before using this appliance.
Save these instructions for future reference.**

This manual contains important safety symbols and instructions. Please pay attention to these symbols and follow all instructions given.

WARNING This symbol will help alert you to situations that may cause serious bodily harm, death or property damage.

CAUTION This symbol will help alert you to situations that may cause bodily injury or property damage.

- **Remove all tape and packaging before using the range.** Destroy the carton and plastic bags after unpacking the range. Never allow children to play with packaging material.
- **Proper Installation—Be sure your appliance is properly installed and grounded by a qualified technician in accordance with the National Electrical Code ANSI/NFPA No. 70 latest edition and local electrical code requirements.** Install only per installation instructions provided in the literature package for this range. Ask your dealer to recommend a qualified technician and an authorized repair service. Know how to disconnect the power to the range at the circuit breaker or fuse box in case of an emergency.
- **User servicing—Do not repair or replace any part of the appliance unless specifically recommended in the manuals.** All other servicing should be done only by a qualified technician. This may reduce the risk of personal injury and damage to the range.
- **Never modify or alter the construction of a range by removing leveling legs, panels, wire covers, anti-tip brackets/screws, or any other part of the product.**

Important Safety Instructions



⚠️ WARNING

- All ranges can tip.
- Injury to persons could result.
- Install anti-tip device packed with range.
- See Installation Instructions.



⚠️ WARNING To reduce the risk of tipping, the range must be secured by properly installed anti-tip bracket provided with the range. To check if the bracket is installed properly, visually check that rear leveling leg is inserted into and fully secured by the anti-tip bracket by removing lower panel or storage drawer. For models with a warmer drawer, grasp the top rear edge of the range and carefully attempt to tilt it forward. Refer to the installation instructions for proper anti-tip bracket installation.



⚠️ WARNING Stepping, leaning or sitting on the doors or drawers of this range can result in serious injuries and also cause damage to the range. Do not allow children to climb or play around the range. The weight of a child on an open door may cause the range to tip, resulting in serious burns or other injury.

⚠️ WARNING Do not use the oven or warmer drawer (if equipped) for storage.

⚠️ CAUTION Do not store items of interest to children in the cabinets above a range or on the backguard of a range. Children climbing on the range to reach items could be seriously injured.

⚠️ WARNING Never Use Your Appliance for Warming or Heating the Room.

- **Storage in or on Appliance—Flammable materials should not be stored in an oven, warmer drawer, near surface units or in the storage drawer.** This includes paper, plastic and cloth items, such as cookbooks, plasticware and towels, as well as flammable liquids. Do not store explosives, such as aerosol cans, on or near the range.
- **Do Not Leave Children Alone—Children should not be left alone or unattended in the area where appliance is in use.** They should never be allowed to sit or stand on any part of the appliance.
- **DO NOT TOUCH SURFACE UNITS, AREAS NEAR THESE UNITS, HEATING ELEMENTS OR INTERIOR SURFACES OF THE OVEN.** Both surface units and oven heating elements may be hot even though they are dark in color. Areas near surface units may become hot enough to cause burns. During and after use, do not touch, or let clothing or other flammable materials touch these areas until they have had sufficient time to cool. Among these areas are the cook top, surfaces facing the cook top, the oven vent openings and surfaces near these openings, oven door and window.

- **Wear Proper Apparel—Loose-fitting or hanging garments should never be worn while using the appliance.** Do not let clothing or other flammable materials contact hot surfaces.
- **Do Not Use Water or Flour on Grease Fires—Smother the fire with a pan lid, or use baking soda, a dry chemical or foam-type extinguisher.**
- **When heating fat or grease, watch it closely.** Fat or grease may catch fire if allowed to become too hot.
- **Use Only Dry Potholders—Moist or damp potholders on hot surfaces may result in burns from steam.** Do not let potholders touch hot heating elements. Do not use a towel or other bulky cloth instead of a potholder.
- **Do Not Heat Unopened Food Containers—Buildup of pressure may cause container to burst and result in injury.**
- **Remove the oven door from any unused range if it is to be stored or discarded.**

IMPORTANT—Do not attempt to operate the range during a power failure. If the power fails, always turn off the range. If the range is not turned off and the power resumes, the range will begin to operate again. Once the power resumes, reset the clock and oven function.

IMPORTANT INSTRUCTIONS FOR USING YOUR COOKTOP

- **Know which knob controls each surface heating unit.** Place a pan of food on the unit before turning it on, and turn the unit off before removing the pan.
- **Use Proper Pan Size—**This appliance is equipped with one or more surface units of different sizes. Select utensils having flat bottoms large enough to cover the surface unit heating element. The use of undersized utensils will expose a portion of the heating element to direct contact and may result in ignition of clothing. Proper relationship of utensil to element will also improve efficiency.
- **Utensil Handles Should Be Turned Inward and Not Extend Over Adjacent Surface Elements—**To reduce the risk of burns, ignition of flammable materials, and spillage due to unintentional contact with the utensil, the handle of the utensil should be positioned so that it is turned inward, and does not extend over adjacent surface units.
- **Never Leave Surface Elements Unattended at High Heat Settings—**Boilovers cause smoking and greasy spillovers that may ignite, or a pan that has boiled dry may melt.
- **Do Not Immerse or Soak Removable Heating Elements—**Heating elements should never be immersed in water. Heating elements clean themselves during normal operation.
- **Glazed Cooking Utensils—**Only certain types of glass, glass/ceramic, ceramic, earthenware, or other glazed utensils are suitable for cook top service without breaking due to the sudden change in temperature. Check the manufacturer's recommendations for cook top use.
- **When flaming foods under a ventilating hood, turn the fan on.**



Important Safety Instructions

IMPORTANT INSTRUCTIONS FOR USING YOUR OVEN

- **Use Care When Opening Oven Door or Warmer Drawer (if equipped)**—Stand to the side of the range when opening the door of a hot oven. Let hot air or steam escape before you remove or replace food in the oven.
- **Keep Oven Vent Ducts Unobstructed.** The oven vent is located under the left rear surface element if your model is equipped with coil elements. The oven vent is located below the backguard for models equipped with ceramic-glass cook tops. Touching the surfaces in this area when the oven is operating may cause severe burns. Also, do not place plastic or heat-sensitive items on or near the oven vent. These items could melt or ignite.
- **Placement of Oven Racks.** Always place oven racks in desired location while oven is cool. If rack must be moved while oven is hot use extreme caution. Use potholders and grasp the rack with both hands to reposition. Do not let potholders contact the hot heating elements in the oven. Remove all utensils from the rack before moving.
- **Do not use the broiler pan without its insert.** The broiler pan and its insert allow dripping fat to drain and be kept away from the high heat of the broiler.
- **Do not cover the broiler insert with aluminum foil. Exposed fat and grease could ignite.**
- **Protective Liners**—Do not use aluminum foil to line the oven bottom. Only use aluminum foil as recommended in this manual. Improper installation of these liners may result in risk of electric shock, or fire.

IMPORTANT INSTRUCTIONS FOR CLEANING YOUR RANGE

- **Clean the range regularly to keep all parts free of grease that could catch fire.** Pay particular attention to the area underneath each surface element. Do not allow grease to accumulate.
- **Kitchen cleaners and aerosols**—Always follow the manufacturer's recommended directions for use. Be aware that excess residue from cleaners and aerosols may ignite causing damage and injury.
- **Clean Ventilating Hoods Frequently**—Grease should not be allowed to accumulate on the hood or filter. Follow manufacturer's instructions for cleaning.

COIL COOK TOP MODELS

- **Make Sure Reflector Pans or Drip Bowls Are in Place**—Absence of these pans or bowls during cooking may subject wiring or components underneath to damage.
- **Protective Liners**—Do not use aluminum foil to line surface unit drip bowls, or reflector pans. Only use aluminum foil as recommended in this manual. Improper installation of these liners may result in risk of electric shock, or fire. Improper installation of these liners may result in risk of electric shock, or fire.

IMPORTANT SAFETY NOTICE

The California Safe Drinking Water and Toxic Enforcement Act requires the Governor of California to publish a list of substances known to the state to cause cancer, birth defects or other reproductive harm, and requires businesses to warn customers of potential exposure to such substances.



Before Setting Oven Controls

Element On



The Element ON Indicator Light

The Coil Cook Top range is equipped with a surface control light that will glow on your range—the **Element ON** indicator light. The **Element ON** indicator light (all models) located on the control panel, will glow when any surface element is turned ON. A quick glance at this light after cooking is an easy check to be sure all surface controls are turned OFF.

Oven Vent Location

For models equipped with coil surface elements, the oven vent is located **under the left rear surface element**. When the oven is on, warm air flows through the left rear element. This venting is necessary for proper air circulation in the oven and good baking results. **DO NOT BLOCK THE OVEN VENT.**

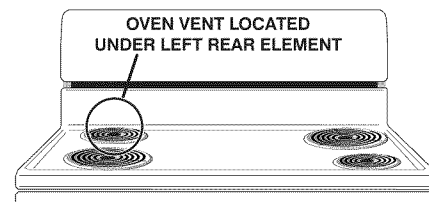

Arranging Oven Racks

ALWAYS ARRANGE OVEN RACKS WHEN THE OVEN IS COOL (PRIOR TO OPERATING THE OVEN). Always use oven mitts when using the oven.

Removing & Replacing Oven Racks

To remove, pull the rack forward until it stops. Lift up front of rack and slide out. **To replace**, fit the rack onto the guides on the oven walls. Tilt the front of the rack upward and slide the rack back into place.

Before Setting Oven Controls

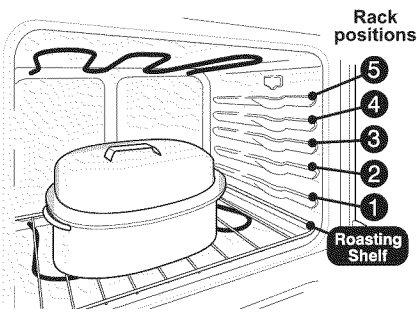

Arranging Oven Racks

To bake on a single rack, place the rack on position 2 or 3. To bake on 2 racks, place the racks on positions 1 & 3.

Recommended Rack Positions for Broiling, Baking & Roasting:

Food	Rack Position
Broiling meats, chicken or fish.	(See Broiling section)
Cookies, cakes, pies, biscuits & muffins.	2 or 3
Frozen pies, angel food cake, yeast, bread, casseroles, small cuts of meat or poultry.	1
Turkey, roast or ham.	1 or Roasting Shelf

Oven Control Functions



Note: The time of day must first be set in order to operate the oven.

BAKE PAD—Used to select the bake function.

UP & DOWN ARROW PADS—Used along with the function pads to select oven temperature, time of day, clean time & minute timer.

BROIL PAD—Used to select the variable broil function.

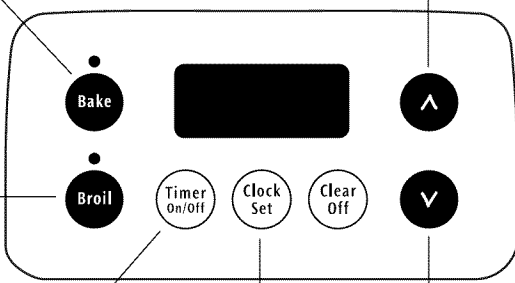

TIMER ON/OFF PAD—Used to set or cancel the minute timer. The minute timer does not start or stop cooking.

CLOCK SET PAD—Used to set the time of day.

CLEAR/OFF—Used to clear any function previously entered except the time of day and minute timer. Press **CLEAR/OFF** to stop cooking.

READ THE INSTRUCTIONS CAREFULLY BEFORE USING THE OVEN. For satisfactory use of your oven, become familiar with the various functions of the oven as described below.

To Set the Clock

When the range is first plugged in, or when the power supply to the range has been interrupted, the display will flash "12:00".

1. Press .
2. Within 5 seconds, press and hold the or until the correct time of day appears in the display.

To Set the Minute Timer:

1. Press .
2. Press the to increase the time in one minute increments. Press and hold the to increase the

To Set the Minute Timer (cont'd):

time in 10 minute increments. The timer can be set for any amount of time from 1 minute to 11 hours and 59 minutes.

Note: If you press the first, the timer will advance to 11 hours and 59 minutes.

3. The display shows the timer count down in minutes until one minute remains. Then the display will count down in seconds.
4. When the set time has run out, the timer will sound a 3 second beep. 0:00 will appear in the display until is pressed.

Note: While the minute timer is counting down, the ":" will flash. The minute timer does not start or stop cooking. It serves as an extra timer in the kitchen that will beep when the set time has run out. The minute timer can be used alone or during any of the other oven functions. When the minute timer is in use with any other function, the minute timer will be shown in the display. To view other functions, press the pad for that function.

To Change the Minute Timer while it is in use:

While the timer is active and shows in the display, press and hold the or to increase or decrease the time.

To Cancel the Minute Timer before the set time has

run out: Press .







Oven Control Functions

Note: The time of day **must** first be set in order to operate the oven.

Changing the Temperature Display Mode (some models)

The electronic oven control temperature display mode was factory preset to display (Fahrenheit) °F oven temperatures. Note: Oven cooking temperatures may be set from 170°F to 550°F (77°C to 287°C).

To change the Temperature Display Mode to °C (Celsius) or from °C to °F (do not use Bake or Broil while changing the Temperature Display Mode):

1. Press & hold the  key pad for 6-8 seconds until **F** or **C** appears in the display. **Note:** At this time the display will show the current Temperature Display Mode whether set for **F** or **C**.
2. Press the  key pad once to choose the (Fahrenheit) °F mode; or press the  key pad once to choose the (Celsius) °C mode.
3. After 5 seconds, the display will flash. To accept the change, wait 5 more seconds until the oven control beeps once. To complete the change skip step 4 below, **OR**:
4. If at any time during the process of changing the Temperature Display Mode (**F** or **C**) you decide the change is not desired, press the  key pad before the oven control beeps once to **cancel** the process.
5. The control will beep once. The display will then return to the time of day with any temperature display mode change you may have requested.



Setting Surface Controls

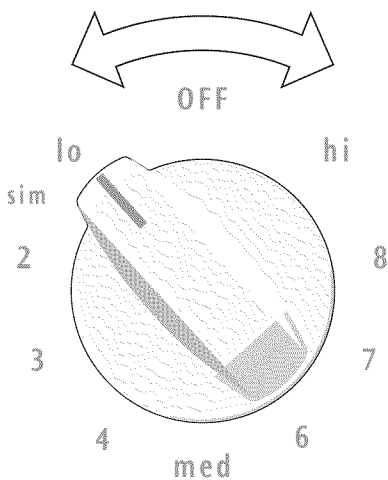

Fig. 1

To Operate the Surface Elements

1. Place cooking utensil on the surface element.
2. Push in and turn the surface control knob in either direction to the desired setting (See Fig. 1). Start most cooking operations on a higher setting and then turn to a lower setting to finish cooking. The control knobs do not have to be set exactly on a particular setting. Use the settings as a guide and adjust the control knob as needed.
3. When cooking is completed, turn the surface element off before removing the pan. Note: The surface “**Element On**” indicator light(s) will glow when one or more elements are turned ON. A quick glance at these indicator light(s) when cooking is finished is an easy check to be sure all surface elements are turned OFF.

Suggested Surface Control Settings

The suggested settings found in the chart below are based on cooking in medium-weight metal pans with lids. Settings may vary when using other types of pans. **Note:** The size and type of utensil used, and the amount and type of food being cooked will influence the setting needed for best cooking results.

Surface Control Settings

Setting	Type of Cooking
HIGH (HI - 9)	Start most foods, bring water to a boil, pan broiling
MEDIUM HIGH (7 - 8)	Continue a rapid boil, fry, deep fat fry
MEDIUM (5 - 6)	Maintain a slow boil, thicken sauces & gravies, steam vegetables
MEDIUM LOW (2 - 4)	Keep foods cooking, poach, stew
LOW (LO - 1)	Keep warm, melt, simmer.

CAUTION Do not place plastic items such as salt and pepper shakers, spoon holders or plastic wrappings on top of the range when it is in use. These items could melt or ignite. Potholders, towels or wooden spoons could catch fire if placed too close to the element.

Setting Oven Controls



Note: The time of day must first be set in order to operate the oven.

To Set or Change the Temperature for Baking

The oven can be programmed to bake at any temperature from 170°F to 500°F.

To Set the Controls for Baking:

1. Press **Bake**. "— — — °" appears in the display.
2. Within 5 seconds, press the **▲** or **▼**. The display will show "350°F." By pressing and holding the **▲** or **▼**, the temperature can then be adjusted in 5°F increments.
3. When the **▲** or **▼** is released, the oven will begin

heating to the selected temperature. When the displayed temperature reaches the desired baking temperature, the control will beep once (1 time).

4. To cancel the baking function, press **Clear Off**.

To Change the Oven Temperature after Baking has Started:

1. Press **Bake** and make sure the bake temperature is displayed.
2. Press the **▲** or **▼** to increase or decrease the set temperature.

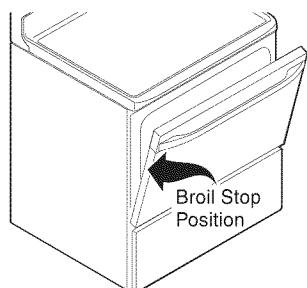

CAUTION To insure proper results when broiling use approved Broil Pan & Insert (some models).

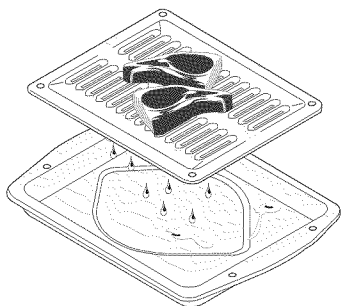

The broiler pan & the insert (some models) allows grease to drain and be kept away from the high heat of the broiler. **DO NOT** use the pan without the insert. **DO NOT** cover the insert with foil; the exposed grease could ignite.

Broiling

1. Arrange oven rack while oven is still cool. Position the rack as suggested in the chart below. See "Arranging Oven Racks" in **Before Setting Oven Controls**.

Rack Position	Food
3 or 4	Medium-rare steaks
3	Fish, medium-well done hamburgers & chops
1 or 2	Well-done foods such as chicken & lobster

2. Press **Broil**.
3. Press and hold the **▲** or **▼** until the desired broil setting level appears in the display. Press the **▲** for **HI** broil or the **▼** for **LO** broil. Most foods can be broiled at the **HI** broil setting. Select the **LO** broil setting to avoid excess browning or drying of foods that should be broiled to the well-done stage.
4. Place the insert on the broiler pan (some models), then place the food on the insert. **DO NOT** use the broiler pan without the insert or cover the insert with aluminum foil. The exposed grease could ignite.
5. Place the pan on the oven rack. **Open the oven door to the broil stop position when broiling** (see illustration).
6. Broil on one side until food is browned; turn and cook on the second side. **Note:** Always pull the rack out to the stop position before turning or removing food.
7. When broiling is finished, press **Clear Off**.

CAUTION Should an oven fire occur, close the oven door and turn off the oven. If the fire continues, use a fire extinguisher. **DO NOT** put water or flour on the fire. Flour may be explosive.









Adjusting Your Oven Temperature (some models)

Your new oven has been factory calibrated and tested to ensure an accurate baking temperature. For the first few uses, follow your recipe times and temperature recommendations carefully. If you feel your oven is too hot or too cool from your baking experience, the oven temperature may be adjusted to your liking.

Note: DO NOT adjust your oven temperature based on oven thermometers, such as those found in grocery stores, they may not be accurate.

To Adjust the Oven Temperature (do not use Bake or Broil while adjusting the oven temperature):

1. Press & hold the  key pad and release after the display begins flashing the factory temperature setting of **00**.
Note: If the oven temperature has been previously adjusted from the factory setting, the current temperature adjusted value will flash in the display instead.
2. You may increase the oven temperature in 5°F increments with each press of the  key pad to a maximum oven adjustment of +35°F. You may also adjust the oven temperature downward in 5°F increments with each press of the  key pad (total adjustment range of -35 to +35°F. **Note:** Your oven control was factory set in the (Fahrenheit) °F Temperature Display Mode. To change for (Celsius) °C, see **Changing the Temperature Display Mode** in the Oven Control Functions section of this Use & Care Manual.
3. If no other key pad is pressed after 5 seconds the display will begin to flash.
4. If you **do not want** to keep the display adjustment, press the  key pad before the oven control beeps. This will cancel the temperature adjustment procedure. To start this procedure over again begin with step 1 above **OR**;
5. If **you want** to keep the adjustment, wait until the display quits flashing and the oven control beeps once.
6. The oven temperature adjustment has been accepted by the oven control and the display will return to the time of day.

Notes: The oven temperature adjustment may be made if your oven control has been set to operate in the (Celsius) °C **Temperature Display Mode**. In this case each press of the  or  key will adjust in 1°C increments upward (maximum +18°C) or downward (maximum -18°C), depending on which arrow key pad is pressed.



General Care & Cleaning (Cleaning Chart)

Surfaces	How to Clean
Glass, Painted Plastic Body Parts & Control Knobs	For general cleaning, use a soft cloth, clean with mild dish detergent & water or a 50/50 solution of vinegar & water. Follow by rinsing the area with clean water; dry & polish with a soft cloth. Glass cleaners may be used if sprayed on a soft cloth 1st. DO NOT spray liquids directly on the control pad and display areas. DO NOT use large amounts of water on the control panel - excess water on the control area may cause damage to the appliance. DO NOT use other liquid cleaners, abrasive cleaners, scouring pads, or some paper towels - they will damage the finish.
Painted Control Panels & Display areas	Before cleaning the control panel, turn all controls to OFF & remove the control knobs. To remove, pull each knob straight off the shaft. Use the <i>general cleaning</i> instructions provided in the paragraph above.
Porcelain Enamel Burner Grates, Cooktop Surface, Below Cooktop, Broiler Pan & Insert, Broiler Drawer, Door Liner & Oven Bottom	Clean burner grates, broiler pan & insert in the dishwasher and dry upon removal. If soils are not removed, follow the cooktop cleaning instructions below. Gentle scouring with a soapy scouring pad will remove most spots. Rinse with a 1:1 solution of clean water & ammonia. <i>If necessary</i> , cover difficult spots with an ammonia-soaked paper towel for 30 to 40 minutes. Rinse with clean water and a damp cloth, then scrub with a soap-filled scouring pad. Rinse & wipe dry with a clean cloth. Remove all cleaners or the porcelain may become damaged during future heating. DO NOT use spray oven cleaners on the range top.

General Care & Cleaning

(Cleaning Chart cont'd)



Surfaces	How to Clean
Oven Racks	Remove racks. See "Removing & Replacing Oven Racks" under Before Setting Oven Controls . Use a mild, abrasive cleaner, following the cleaner's recommendations. Rinse with clean water & let dry. After cleaning the racks, rub the sides of the racks with wax paper or a cloth containing a small amount of baby oil or salad oil (this will make the racks glide easier into the oven rack positions).
Oven Door	Use soap & water to thoroughly clean the top, sides & front of the oven door. Rinse well. You may use a glass cleaner on the outside glass of the oven door. DO NOT immerse the door in water. DO NOT spray or allow water or the glass cleaner to enter the door vents . DO NOT use oven cleaners, cleaning powders or any harsh abrasive cleaning materials on the outside of the oven door. DO NOT clean the oven door gasket. The oven door gasket is made of a woven material, on Self-Cleaning models, which is essential for a good seal. Care should be taken not to rub, damage or remove this gasket.
Stainless Steel	Clean stainless steel with hot soapy water & a dishcloth. Rinse with clean water and a cloth. DO NOT use cleaners with high concentrations of chlorides or chlorines. DO NOT use harsh scrubbing cleaners. Only use kitchen cleaners that are especially made for cleaning stainless steel. Always be sure to rinse the cleaners from the surface as bluish stains may occur during heating that cannot be removed.

Cleaning Recommendations for Coil Element Cooktop

Surface elements can be unplugged and removed to make cleaning the drip pans easier. The surface elements clean themselves when they are turned on. Food spilled on a hot element will burn off. Food spilled on a cool element may be cleaned with a damp cloth—any remaining soil will burn off the next time the element is used.

CAUTION Never immerse a surface element in water.

CAUTION Be sure the range is cool before removing elements or drip bowls. Be careful not to bend terminal ends when replacing elements after cleaning.

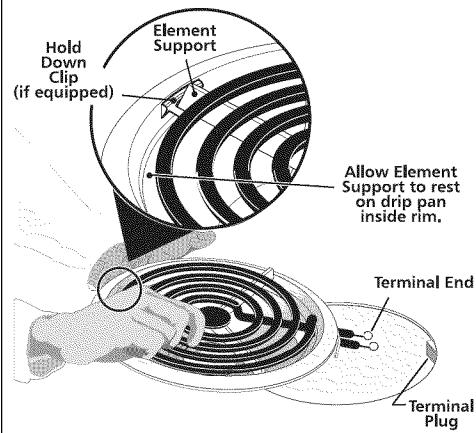

Removing the Surface Elements & Drip Bowls

1. Lift the edge of the drip bowl across from the terminal end. **Lift the surface element & drip bowl together** just enough to clear the cooktop.
2. While holding the drip bowl and surface element, gently pull the terminal end out from the terminal plug. If equipped, **DO NOT** remove the hold down clip from the drip bowl.

Cleaning the Drip Bowls

Wash in hot soapy water or in the dishwasher. Rinse & dry while still warm. Hard to remove or burned on soil can be removed by soaking the drip bowls for about 20 minutes in a lightly diluted liquid cleanser or a solution of ammonia & water (1/2 cup ammonia to 1 gallon of water). A nylon scrubber may be used after soaking. **DO NOT** use abrasive cleaners or steel wool, as they will scratch the surface. Always rinse with clean water & polish dry with a soft cloth.

Replacing Drip Bowls & Surface Elements

1. Slide the terminal end on the element through the opening in the drip bowl.
2. Align the element support to rest on the rim inside the drip bowl. If your drip bowl is equipped with a hold down clip, align the element support opposite the terminal end with the slot in the hold down clip & snap into place.
3. After the element is positioned in the drip bowl, line up the terminal end with the terminal plug as shown.
4. Hold the surface element & drip bowl together as level as possible & firmly push the terminal end into the terminal plug. Make sure element terminal is seated properly into terminal plug. Make sure the surface element is level to reduce the hazard of pans sliding off the element.

Raising the Top for Cleaning

1. Grasp the sides & lift from the front. Lift-up rods will support the top in a raised position. Only lift the top far enough to allow the support rods to snap into place.
2. Clean underneath using a clean cloth & hot soapy water.
3. To lower the top, gently push back on each rod to release the notched support. Hold the range top and slide the lift rods down into the range frame.

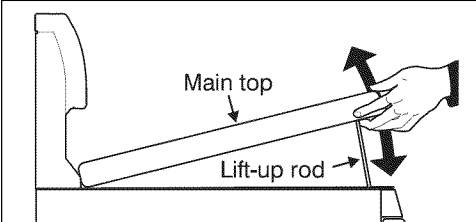

CAUTION When lowering the lift-up range top, grasp the sides with finger-tips only. Be careful not to pinch fingers. **DO NOT** drop or bend the range top when raising or lowering. This could damage the surface.



General Care & Cleaning

Cleaning the Oven Bottom

The bake element is designed to be gently tilted up using your hand from the front of the bake element. This will allow easier access to the oven bottom for cleaning. Be careful not to raise the element more than 4 or 5 inches from the resting position.

Care & Cleaning of Stainless Steel

Some models are equipped with stainless steel exterior parts. Special care and cleaning are **required** for maintaining the appearance of stainless parts. Please refer to the Cleaning Chart provided at the beginning of the **General Care & Cleaning** section in this Use & Care Manual.

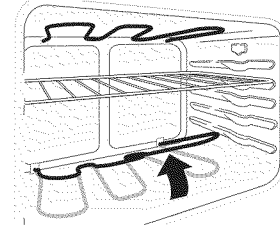

The baking element may be tilted about 4 or 5 inches to clean the oven bottom.

Changing the Interior Oven Light (some models)

On some models, the oven light automatically turns on when the door is opened. Some models have a switch located on the control panel to turn on the light. The oven light is located at the rear of the oven.

To replace the oven light:

1. Turn electrical power off at the main source or unplug the range.
2. Replace bulb with a new 40 watt appliance bulb.
3. Turn power back on again at the main source (or plug the range back in).
4. The clock will then need to be reset. To reset, see **Setting Oven Controls** in this Use & Care Manual.

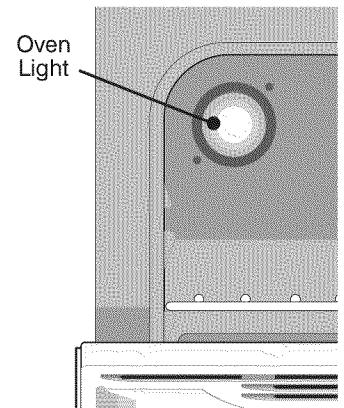

CAUTION Be sure the range is unplugged and all parts are COOL before replacing oven light. Wear a leather-faced glove for protection against possible broken glass.

Removing & Replacing the Oven Door

CAUTION The door is heavy. For safe, temporary storage, lay the door flat with the inside of the door facing down.

To Remove Oven Door:

1. Open oven door completely (horizontal with floor - See Fig. 1).
2. Remove 2 screws located on the inside of the oven door liner (See **A** Fig. 2)
3. Insert the 2 screws into the door hinge holes located on the side of the hinge arm, one into each hinge (See **B** Fig. 2).
4. Close oven door until the door stops, (Do not force the door to close any further). The placement of these screws should keep door open in about a 45 degree position.
5. Grasp oven door firmly on both sides and slide door up and off hinges at the same angle. (See Fig. 3)
6. To clean oven door, follow the instructions provided in the Cleaning Chart at the beginning of the **Care & Cleaning** section (See Door Liner).

To Replace Oven Door:

1. Be sure the hinge arms remain at the 45 degree angle position. Be sure the screws are still locking the hinge arms from moving. If the screws fall out of the hinge holes, the hinge(s) may snap back against the oven frame and could pinch fingers or chip the porcelain finish on the oven front frame.
2. Hold door at the sides near the top while resting the lower front of door on your knee. Insert the door channels at the bottom of door over the door hinges, (See Fig. 3).
3. Allow the door to slide down into the door hinges evenly at the same 45 degree angle. The hinge arms should be inserted into the bottom corners as far as they can go.
4. Open door completely (horizontal with floor) and remove both screws from holes in door hinges.
5. Reinstall the 2 screws into the door liner (See **C** Fig. 2).
6. If the door is not in alignment with the oven frame, remove door & repeat the above steps.

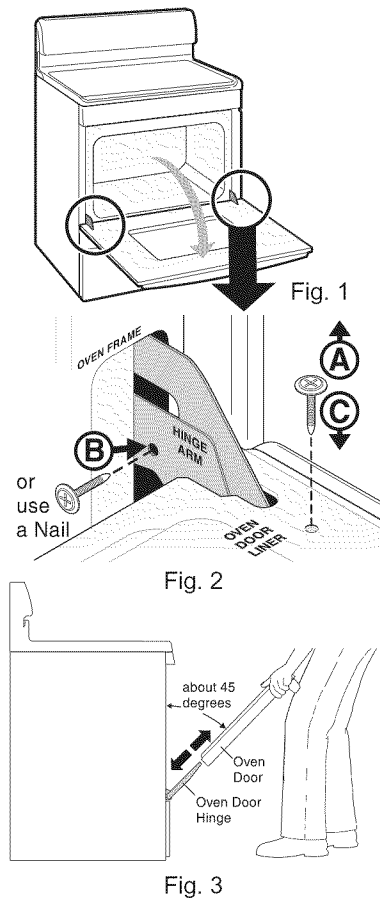

Before You Call

Solutions to Common Problems



Before you call for service, review the following list. It may save you time & expense. The list includes common occurrences (shown in bold) that are not the result of defective workmanship or materials in this appliance. The possible corrections to these problems are provided with the problem listed:

Range is not level - (1) Poor installation. Place oven rack in center of oven. Place a level on the oven rack. Adjust leveling legs at base of range until the oven rack is level. (2) Be sure floor is level, strong & stable enough to adequately support range. (3) If floor is sagging or sloping, contact a carpenter to correct the situation. (4) Kitchen cabinet alignment may make range appear not level. Be sure cabinets are square & have sufficient room for range clearance.

Cannot move appliance easily. Appliance must be accessible for service - (1) Cabinets not square or are built in too tightly. Contact builder or installer to make appliance accessible. (2) Carpet interferes with range. Provide sufficient space so range can be lifted over carpet.

Surface element too hot or not hot enough - Incorrect control setting. Be sure the correct control is ON for the element to be used.

Surface element does not heat - (1) Lightweight or warped pans used. Use only flat, evenly balanced, medium or heavyweight cookware. Flat pans heat better than warped pans. Cookware materials and weight of the material affect heating. Heavy & medium-weight pans heat evenly. Because lightweight pans heat unevenly, foods may burn easily. (2) No power to the appliance. Check steps under "**Entire Appliance Does Not Operate**" in this checklist. (3) Incorrect control setting. Make sure the correct control is ON for the surface element to be used.

Entire appliance does not operate - (1) The time of day is not set. The time of day **must** first be set in order to operate the oven. See "To Set the Clock" in the **Setting Oven Controls** section. (2) Make sure cord/plug is plugged correctly into outlet. (3) Service wiring is not complete. Contact your dealer, installing agent or authorized service agent. (4) Electrical power outage. Check house lights to be sure. Call your local electric company for service.

Oven does not operate - Be sure the oven controls are set properly for the desired function. See **Setting Oven Controls** in this Use & Care Manual or read the instructions "**Entire appliance does not operate**" in this checklist.

Oven light does not work (some models) - Replace or tighten bulb. See **Changing Oven Light** section in this Use & Care Manual.

Oven smokes excessively during broiling - (1) Control(s) not set properly. Follow Broil instructions under **Setting Oven Controls**. (2) Make sure oven door is opened to **broil stop position**. (3) Meat too close to the broil element. Reposition the broil rack to provide proper clearance between the meat & the element. Preheat the broil element for searing. (4) Meat not properly prepared. Remove excess fat from meat. Cut remaining fatty edges to prevent curling, but do not cut into lean. (5) Insert on broiler pan wrong side up & grease not draining. Always place grid on the broiler pan with ribs up & slots down to allow grease to drip into pan (some models). (6) Grease has built up on oven surfaces. Regular cleaning is necessary when broiling frequently. Old grease or food spatters cause excessive smoking.

Flames inside oven or smoking from oven vent - Excessive spillovers in oven. For example this will happen for pie spillovers or large amounts of grease left on the oven bottom. Wipe up excessive spillovers before starting oven. If flames or excessive smoke are present see "Broiling" in the **Setting Oven Controls** section.

Oven control beeps & displays any F code error (for example F11) - Electronic control has detected a fault condition. Press **CLEAR/OFF** to clear the display & stop beeping. Try the Bake or Broil function again. If the F code error repeats, remove power supply to appliance, wait 5 minutes and then repower the appliance and set clock time of day. Try the Bake or Broil function again. If the fault recurs, record fault number, press **CLEAR/OFF** & contact an authorized service agent.

Poor baking results - Many factors affect baking results. Make sure the proper oven rack position is used. Center food in the oven & space pans to allow air to circulate. Allow the oven to preheat to the set temperature before placing food in the oven. Try adjusting the recipe's recommended temperature or baking time. If you feel the oven is too hot or cool, see **Adjusting Your Oven Temperature** in this Use & Care Manual.

Drip bowls are pitting or rusting (Coil element models) - (1) Foods with acids, such as tomatoes if allowed to stand in or on drip bowls will cause corrosion. Remove & wash drip bowls as soon as possible after a spillover. (2) Normal environment. Houses along coastal areas are exposed to salt air. Protect bowls as much as possible from direct exposure to salt air.

Drip bowls turning color or distorted (Coil element models) - Bottom surface of cookware extends beyond surface elements and touches cooktop surface. This can cause high enough temperatures to discolor the drip bowls. **DO NOT** use cookware of this type. Pan sizes should be matched to the size of the element. Replacement drip bowls may be purchased from your appliance dealer.



Major Appliance Warranty Information

Your appliance is covered by a one year limited warranty. For one year from your original date of purchase, Crosley Corporation will pay all costs for repairing or replacing any parts of this appliance that prove to be defective in materials or workmanship when such appliance is installed, used and maintained in accordance with the provided instructions.

In addition to the warranty shown above, ask your dealer about Crosley Extended Limited Warranty that comes to you at no extra charge for the 2nd through the 10th years.

Exclusions This warranty does not cover the following:

1. Products with original serial numbers that have been removed, altered or cannot be readily determined.
2. Product that has been transferred from its original owner to another party or removed outside the USA or Canada.
3. Rust on the interior or exterior of the unit.
4. Products purchased "as-is" are not covered by this warranty.
5. Food loss due to any refrigerator or freezer failures.
6. Products used in a commercial setting.
7. Service calls which do not involve malfunction or defects in materials or workmanship, or for appliances not in ordinary household use or used other than in accordance with the provided instructions.
8. Service calls to correct the installation of your appliance or to instruct you how to use your appliance.
9. Expenses for making the appliance accessible for servicing, such as removal of trim, cupboards, shelves, etc., which are not a part of the appliance when it is shipped from the factory.
10. Service calls to repair or replace appliance light bulbs, air filters, water filters, other consumables, or knobs, handles, or other cosmetic parts.
11. Surcharges including, but not limited to, any after hour, weekend, or holiday service calls, tolls, ferry trip charges, or mileage expense for service calls to remote areas, including the state of Alaska.
12. Damages to the finish of appliance or home incurred during installation, including but not limited to floors, cabinets, walls, etc.
13. Damages caused by: services performed by unauthorized service companies; use of parts other than genuine Crosley Corporation parts or parts obtained from persons other than authorized service companies; or external causes such as abuse, misuse, inadequate power supply, accidents, fires, or acts of God.

DISCLAIMER OF IMPLIED WARRANTIES; LIMITATION OF REMEDIES

CUSTOMER'S SOLE AND EXCLUSIVE REMEDY UNDER THIS LIMITED WARRANTY SHALL BE PRODUCT REPAIR OR REPLACEMENT AS PROVIDED HEREIN. CLAIMS BASED ON IMPLIED WARRANTIES, INCLUDING WARRANTIES OF MERCHANTABILITY OR FITNESS FOR A PARTICULAR PURPOSE, ARE LIMITED TO ONE YEAR OR THE SHORTEST PERIOD ALLOWED BY LAW, BUT NOT LESS THAN ONE YEAR. ELECTROLUX SHALL NOT BE LIABLE FOR CONSEQUENTIAL OR INCIDENTAL DAMAGES SUCH AS PROPERTY DAMAGE AND INCIDENTAL EXPENSES RESULTING FROM ANY BREACH OF THIS WRITTEN LIMITED WARRANTY OR ANY IMPLIED WARRANTY. SOME STATES AND PROVINCES DO NOT ALLOW THE EXCLUSION OR LIMITATION OF INCIDENTAL OR CONSEQUENTIAL DAMAGES, OR LIMITATIONS ON THE DURATION OF IMPLIED WARRANTIES, SO THESE LIMITATIONS OR EXCLUSIONS MAY NOT APPLY TO YOU. THIS WRITTEN WARRANTY GIVES YOU SPECIFIC LEGAL RIGHTS. YOU MAY ALSO HAVE OTHER RIGHTS THAT VARY FROM STATE TO STATE.

If You Need Service Keep your receipt, delivery slip, or some other appropriate payment record to establish the warranty period should service be required. If service is performed, it is in your best interest to obtain and keep all receipts. Service under this warranty must be obtained by contacting Crosley Corporation at the addresses or phone numbers below.

This warranty only applies in the USA and Canada. In the USA, your appliance is warranted by Crosley Corporation. In Canada, your appliance is warranted by Crosley Canada Corp. Crosley Corporation authorizes no person to change or add to any obligations under this warranty. Obligations for service and parts under this warranty must be performed by Crosley Corporation or an authorized service company. Product features or specifications as described or illustrated are subject to change without notice.

**FOR WARRANTY
INFORMATION CONTACT:**
USA 800-944-9044
Canada 800-668-4606



**FOR PRODUCT INFORMATION
CONTACT:**
336-761-1212
Crosley Corporation
111 Cloverleaf Dr.
Winston-Salem, NC 27103
www.crosley.com