



SC-MX20
SC-MX20B
SC-MX20H
SC-MX20L
SC-MX20R
SC-MX20C
SC-MX20CH
SC-MX20E
SC-MX20EL
SC-MX20ER

Memory Camcorder user manual

imagine the possibilities

Thank you for purchasing this Samsung product.
To receive more complete service, please
register your product at
www.samsung.com/global/register

SAMSUNG

key features of your memory camcorder

High-resolution Colour Widescreen LCD (2.7" WIDE TFT LCD)

Samsung memory camcorder adopts 2.7-inch Widescreen LCD of 112k pixels which allows bright and clear monitoring. In addition, reinforced LCD Enhancer adjusting color and brightness to the screen lighting conditions allows better monitoring under the strong sunlight.

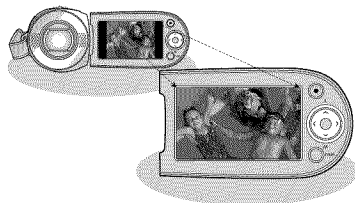

H.264 (MPEG4 part 10/Advanced Video Coding) Encoding

The latest video compression technology, H.264 uses a high compression rate to sharply increase the recordable time with the same size storage.

Simple & Easy User Interface

Designed to provide optimized and easy use with ergonomic design including customizable button layout for recording/playback functions and frequently used functions.

And, improved Graphics User Interface offers new and fresh look as well as easy operation.

High-capacity embedded Flash Memory (Built-in memory supported model only)

The camcorder has built-in high capacity flash memory that allows you to record directly.

User-friendly Functions

User-friendly EASY Q optimizes your memory camcorder to the recording conditions automatically, which provides beginners with the best performance.

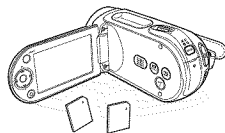

Twice the memory options (SC-MX20C/MX20CH/MX20E/MX20EL/MX20ER only)

The memory camcorder's external memory slot accepts both high capacity SDHC and MMCplus. Play and transfer videos, quickly and easily using the memory type of your choice. In addition to this slot the memory camcorder has the built-in flash memory.

High-resolution LCD Display through DNIe Engine

Samsung memory camcorder has features of 3DNR (3-dimensional noise reduction), high-sensitivity color expression (intelligent color expression), High performance Anti-Shake (Hyper DIS), and automatic face detection (Face Detection) etc.

Capture Visions farther than the eye can see (34x Optical/1200x Digital Zoom)

Samsung's powerful optical zoom lenses bring the world closer without losing image quality. In addition, Digital Zoom Interpolation provides clearer extreme digital zooming, with less distortion than previous types of digital zooms.

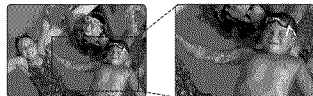

Various Recording Features

The memory camcorder supports Anti-Shake (HDIS), Digital Effect and a wide range of other functions that you can select according to the scene you are recording. ➡pages 52~67

Easy Upload to YouTube

You can upload recorded movie to YouTube using the CyberLink MediaShow4.

➡page 92

Enjoying Various Playback Features

Unlike tape operation, playback is simple and easy in this memory camcorder since rewinding and fast forwarding is less time consuming. Various functions are available for enjoying many different types of playback. ➡pages 68-73

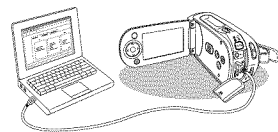

Play back on your PC

USB 2.0 enables the smooth transfer of movies to your computer. With the bundled software you can easily transfer and play back your own movies on your PC. ➡page 91

Swivel handle for free style shooting (max 180 degree rotate)

No need to stand up and crouch to shoot your videos. This memory camcorder from Samsung has a new swivel handgrip. You can adjust the swivel handle's angle up to 180° to suit the recording situation. You can now shoot videos freely from high angles to low angles while standing.

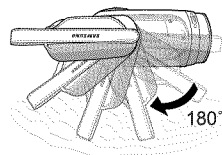



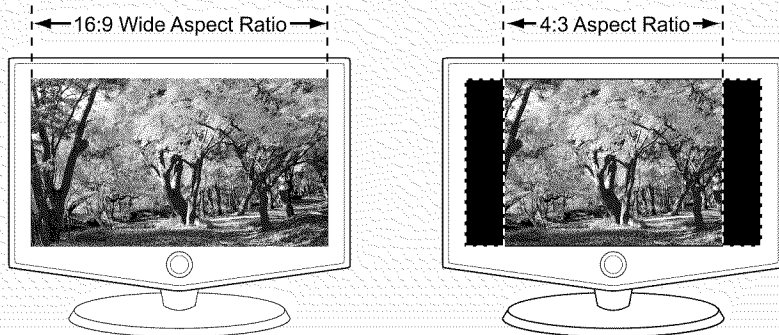

Flexible 4:3 & 16:9 recording and viewing

By offering a choice of recording in two different aspect ratios - 4:3 and 16:9, SAMSUNG ensures the entire image is captured for playback on everything from older TVs to your newest, wide-format TV screen.







safety warnings

What the icons and signs in this user manual mean :

 WARNING	Means that death or serious personal injury is a risk.
 CAUTION	Means that there is a potential risk for personal injury or material damage.
 CAUTION	To reduce the risk of fire, explosion, electric shock, or personal injury when using your camcorder, follow these basic safety precautions:
	Means hints or referential pages that may be helpful when operating the camcorder.

These warning signs are here to prevent injury to you and others.
Please follow them explicitly. After reading this section, keep it in a safe place for future reference.

important safety instructions

 CAUTION RISK OF ELECTRIC SHOCK DO NOT OPEN	 	This symbol indicates that dangerous voltage consisting a risk of electric shock is present within this unit.
CAUTION: TO REDUCE THE RISK OF ELECTRIC SHOCK, DO NOT REMOVE COVER (OR BACK). NO USER-SERVICEABLE PARTS INSIDE. REFER SERVICING TO QUALIFIED SERVICE PERSONNEL.		This symbol indicates that there are important operating and maintenance instructions in the literature accompanying this unit.

Warning

To Reduce The Risk Of Fire Or Electric Shock, Do Not Expose This Apparatus To Rain Or Moisture.”

Caution

Apparatus shall not be exposed to dripping or splashing and no objects filled with liquids, such as vases, shall be placed on the apparatus. To disconnect the apparatus from the mains, the plug must be pulled out from the mains socket, therefore the mains plug shall be readily operable.

important safety instructions

1. Read these instructions.
2. Keep these instructions.
3. Heed all warnings.
4. Follow all instructions.
5. Do not use this apparatus near water.
6. Clean only with dry cloth.
7. Do not block any ventilation openings. Install in accordance with the manufacturer's instructions.
8. Do not install near any heat sources such as radiators, heat registers, stoves, or other apparatus (including amplifiers) that produce heat.
9. Do not defeat the safety purpose of the polarized or grounding-type plug. A polarized plug has two blades with one wider than the other. A grounding type plug has two blades and a third grounding prong. The wide blade or the third prong are provided for your safety. If the provided plug does not fit into your outlet, consult an electrician for replacement of the obsolete outlet.
10. Protect the power cord from being walked on or pinched particularly at plugs, convenience receptacles, and the point where they exit from the apparatus.
11. Only use attachment/accessories specified by the manufacturer.
12. Use only with the cart, stand, tripod, bracket, or table specified by the manufacturer, or sold with the apparatus. When a cart is used, use caution when moving the cart/apparatus combination to avoid injury from tip-over.
13. Unplug this apparatus during lightning storms or when unused for long periods of time.
14. Refer all servicing to qualified service personnel. Servicing is required when the apparatus has been damaged in any way, such as power-supply cord or plug is damaged, liquid has been spilled or objects have fallen into the apparatus, the apparatus has been exposed to rain or moisture, does not operate normally, or has been dropped.
15. Apparatus shall not be exposed to dripping or splashing and no objects filled with liquids, such as vases, shall be placed on the apparatus.
16. VENTILATION:
Slots and openings in the cabinet are provided for ventilation to ensure reliable operation of the CAMCORDER and to protect it from overheating. These openings must not be blocked or covered. Never place your CAMCORDER on a bed, sofa, rug, or other similar surface: on or near a radiator or heat register. This CAMCORDER should not be placed in a built-in installation such as a bookcase or rack unless proper ventilation is provided or the manufacturer's instructions have been adhered to.



17. POWER SOURCES:

The CAMCORDER should be operated only from the type of power source indicated on the label. If you are not sure of the type of power supply at your home, consult your appliance dealer or local power company. A CAMCORDER is intended to be operated from battery power, or other sources, refer to the operating instructions.

18. GROUNDING OR POLARIZATION:

This CAMCORDER may be equipped with either a polarized 2-wire AC line plug (a plug having one blade wider than the other) or a 3-wire grounding type plug, a plug having a third (grounding) pin. If you are unable to insert the plug fully into the outlet, try reversing the plug. If the plug still fails to fit, contact your electrician to replace your outlet. Do not defeat the safety purpose of the polarized plug.

19. POWER-CORD PROTECTION:

Power-supply cords should be routed so that they are not likely to be walked on or pinched by items placed upon or against them, paying particular attention to cords or plugs, convenient receptacles, and the point where they exit from the unit.

20. OUTDOOR ANTENNA GROUNDING:

CAMCORDER, be sure the antenna or cable system is grounded to provide some protection against voltage surges and built-up static charges, Section 810 of the National Electrical Code, ANSI/NFPA No.

70-1984, provides information with respect to proper grounding of the mast and supporting structure, grounding of the lead-in wire and supporting structure, grounding of the mast and supporting structure, grounding of the lead-in wire to an antenna discharge unit, size of grounding to conductors, location of antenna-discharge unit, connection to grounding electrodes and requirements for the grounding electrode.

See figure below.

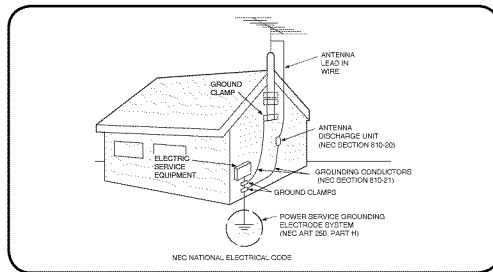

21. LIGHTNING:

For added protection of this CAMCORDER during a lightning storm or when it is left unattended and unused for long periods of time, unplug it from the wall outlet and disconnect the antenna or cable system. This will prevent damage to the CAMCORDER due to lightning and powerline surges.

important safety instructions

22. POWER LINES:

An outside antenna system should not be located in the vicinity of overhead power lines or other electric light or power circuits where it can fall into such power lines or circuits. When installing an outside antenna system, extreme care should be taken to keep from touching such power lines or circuits as contact with them might be fatal.

23. OVERLOADING:

Do not overload wall outlets and extension cords as this can result in a risk of fire or electric shock.

24. OBJECTS AND LIQUIDS:

Never push objects of any kind into this CAMCORDER through openings as they may touch dangerous voltage points or short out a part that could result in a fire or electric shock. Never spill liquids of any kind onto the CAMCORDER. Should spillage occur, unplug unit and have it checked by a technician before use.

25. SERVICING:

Do not attempt to service this CAMCORDER yourself. Opening or removing covers may expose you to dangerous voltage or other hazards. Refer all servicing to qualified service personnel.

26. DAMAGE REQUIRING SERVICE:

Unplug this CAMCORDER from the wall outlet and refer servicing to qualified service personnel under the following conditions:

- a.** When the power-supply cord or plug is damaged.
- b.** If any liquid has been spilled onto, or objects have fallen into the CAMCORDER.
- c.** If the CAMCORDER has been exposed to rain or water.
- d.** If the CAMCORDER does not operate normally by following the operating instructions, adjust only those controls that are covered by the operating instructions. Improper adjustment of other controls may result in damage and will often require extensive work by a qualified technician to restore the CAMCORDER to its normal operation.
- e.** If the CAMCORDER has been dropped or the cabinet has been damaged.
- f.** When the CAMCORDER exhibits a distinct change in performance, this indicates a need for service.

27. REPLACEMENT PARTS:

When replacement parts are required, be sure the service technician has used replacement parts specified by the manufacturer and having the same characteristics as the original part. Unauthorized substitutions may result in fire, electric shock or other hazards.

28. SAFETY CHECK:

Upon completion of any service or repairs to this CAMCORDER, ask the service technician to perform safety checks to determine that the CAMCORDER is in safe operating order.

29. To prevent damage which may result in fire or shock hazard, do not expose this appliance to rain or moisture.
30. If this power supply is used at 240V ac, a suitable plug adaptor should be used.
31. This product is covered by one or more of the following U.S. patents:
 5,060,220 5,457,669 5,561,649 5,705,762 5,987,417
 6,043,912 6,222,983 6,272,096 6,377,524 6,377,531
 6,385,587 6,389,570 6,408,408 6,466,532 6,473,736
 6,477,501 6,480,829 6,556,520 6,556,521 6,556,522
 6,578,163 6,594,208 6,631,110 6,658,588 6,674,697
 6,674,957 6,687,455 6,697,307 6,707,985 6,721,243
 6,721,493 6,728,474 6,741,535 6,744,713 6,744,972
 6,765,853 6,765,853 6,771,890 6,771,891 6,775,465
 6,778,755 6,788,629 6,788,630 6,795,637 6,810,201
 6,862,256 6,868,054 6,894,963 6,937,552

USER INSTALLER CAUTION:

Your authority to operate this FCC certified equipment could be voided if you make changes or modifications not expressly approved by this party responsible for compliance to part 15 FCC rules.

NOTE:

 LAMP(S) INSIDE THIS PRODUCT CONTAIN MERCURY AND MUST BE RECYCLED OR DISPOSED OF ACCORDING TO LOCAL, STATE OR FEDERAL LAWS. For details see lamprecycle.org, eiaa.org, or call 1-800-Samsung (7267864)

CALIFORNIA USA ONLY

This Perchlorate warning applies only to primary CR (Manganese Dioxide) Lithium coin cells in the product sold or distributed ONLY in California USA

“ Perchlorate Material - special handling may apply, See [NOTE: This equipment has been tested and found to comply with the limits for a Class B digital device, pursuant to part 15 of the FCC Rules.](http://www.dtsc.ca.gov/hazardouswaste/perchlorate.””</p>
</div>
<div data-bbox=)

These limits are designed to provide reasonable protection against harmful interference in a residential installation. This equipment generates, uses and can radiate radio frequency energy and, if not installed and used in accordance with the instructions, may cause harmful interference to radio communications. However, there is no guarantee that interference will not occur in a particular installation. If this equipment does cause harmful interference to radio or television reception, which can be determined by turning the equipment off and on, the user is encouraged to try to correct the interference by one or more of the following measures:

- Reorient or relocate the receiving antenna.
- Increase the separation between the equipment and receiver.
- Connect the equipment into an outlet on a circuit different from that to which the receiver is connected.
- Consult the dealer or an experienced radio/TV technician for help and for additional suggestions. The user may find the following booklet prepared by the Federal Communications Commission helpful: “How to Identify and Resolve Radio-TV Interference Problems.” This Booklet is available from the U.S. Government Printing Office, Washington, D.C. 20402, Stock No. 004-000-00345-4.

FCC Warning

The user is cautioned that changes or modifications not expressly approved by the manufacturer could void the user's authority to operate the equipment.

This device complies with Part 15 of FCC Rules.

Operation is subject to the following two conditions;

- (1) This device may not cause harmful interference, and
- (2) This device must accept any interference received, including interference that may cause undesired operation.

precautions

Warning!

- This camcorder should always be connected to an AC outlet with a protective grounding connection.
- Batteries shall not be exposed to excessive heat such as sunshine, fire or the like.

Caution

Danger of explosion if battery is incorrectly replaced.
Replace only with the same or equivalent type.

If this power supply is used at 240V ac, a suitable plug adaptor should be used.

BEFORE USING THIS CAMCORDER

- **This memory camcorder is designed exclusively for high-capacity built-in flash memory and external memory card.**
- **This memory camcorder records video in H.264/AVC (MPEG4 part 10/Advanced Video Coding) format compliant with Standard resolution (SD-VIDEO) format.**
- **Please be noted that this memory camcorder is not compatible with other digital video formats.**
- **Before recording important video, make a trial recording.**
 - Play back your trial recording to make sure the video and audio have been recorded properly.
- **The recorded contents cannot be compensated for:**
 - Samsung cannot compensate for any damages caused when recording is not made normally or recorded contents cannot be played back because of a defect in the memory camcorder or card.
Also, Samsung cannot be responsible for your recorded video and audio.
 - Recorded contents may be lost due to a mistake when handling this memory camcorder or memory card, etc.
Samsung shall not be responsible for the compensation for damages due to the loss of recorded contents.

- **Make a backup of important recorded data**
 - Protect your important recorded data by copying the files to a PC. It is recommended to copy it from your PC to other recording media for storage. Refer to the software installation and USB connection guide.
- **Copyright: Please be noted that this memory camcorder is intended for an individual consumer's use only.**
 - Data recorded on the card in this memory camcorder using other digital/analog media or devices is protected by the copyright act and cannot be used without permission of the owner of copyright, except for personal enjoyment. Even if you record an event such as a show, performance or exhibition for personal enjoyment, it is strongly recommended that you obtain the permission beforehand.

precautions on use

IMPORTANT NOTE

- **Handle the liquid crystal display (LCD) with care:**
 - The LCD is a very delicate display device: Do not press its surface with excessive force, hit it or prick it with a sharp object.
 - If you push the LCD surface, unevenness in display may occur. If unevenness does not disappear, turn the camcorder off, wait for a few moments, and then turn it on again.
 - Do not place the camcorder with the open LCD screen down.
 - Close the LCD monitor when not using the camcorder.
- **Liquid crystal display:**
 - The LCD screen is a product of high precision technology. Out of the total pixels (approx. 112,000 pixels of an LCD monitor), 0.01% or less pixels may be out (black dots) or may remain lit as colored dots (red, blue, and green). This shows the limitations of the current technology, and does not indicate a fault that will interfere with recording.
 - The LCD screen will be slightly dimmer than usual when the camcorder is at low temperature, as in cold areas, or right after the power is turned on. Normal brightness will be restored when the temperature inside the camcorder rises. Note that the foregoing phenomena have no effect on the image in a storage media, so there is no cause for concern.
- **Hold the memory camcorder correctly:**
 - Do not hold the memory camcorder by the LCD monitor when lifting it: the LCD monitor could detach and the memory camcorder may fall.

- **Do not subject the memory camcorder to impact:**
 - This memory camcorder is a precision machine. Take great care that you do not strike it against a hard object or let it fall.
 - Do not use the memory camcorder on a tripod in a place where it is subject to severe vibrations or impact.
- **No sand or dust!**
 - Fine sand or dust entering the memory camcorder or AC power adaptor could cause malfunctions or defects.
- **No water or oil!**
 - Water or oil entering the memory camcorder or AC power adaptor could cause electric shock, malfunctions or defects.
- **Heat on surface of product:**
 - The surface of the memory camcorder will be slightly warm when using, but this does not indicate a fault.
- **Be careful of unusual ambient temperature:**
 - Using the memory camcorder in a place where the temperature is over 140°F (40°C) or lower than 32°F (0°C) may result in abnormal recording/playback.
 - Do not leave the memory camcorder on a beach or in a closed vehicle where the temperature is very high for a long time: This could cause malfunctions.
- **Do not point directly at the sun:**
 - If direct sunlight strikes the lens, the memory camcorder could malfunction or a fire could occur.
 - Do not leave the memory camcorder with the LCD screen exposed to direct sunlight: This could cause malfunction.
- **Do not use the memory camcorder near TV or radio:**
 - This could cause noise to appear on the TV screen or in radio broadcasts.
- **Do not use the memory camcorder near strong radio waves or magnetism:**
 - If the memory camcorder is used near strong radio waves or magnetism, such as near a radio wave tower or electric appliances, noise could enter video and audio that are being recorded. During playback of normally recorded video and audio, noise may also be present in picture and sound. At worst the memory camcorder could malfunction.
- **Do not expose the memory camcorder to soot or steam:**
 - Thick soot or steam could damage the memory camcorder case or cause malfunctions.
- **Do not use the memory camcorder near corrosive gas:**
 - If the memory camcorder is used in a place where there is dense exhaust gas generated by gasoline or diesel engines, or corrosive gas such as hydrogen sulfide, the external or internal terminals could corrode, disabling normal operation, or the battery connection terminals could corrode, so that power will not turn on.

precautions on use

- **Do not use the memory camcorder near ultrasonic humidifier:**
 - Calcium and other chemicals dissolved in water could scatter in the air, and white particles could adhere to the optical head of the memory camcorder, which could cause it to operate abnormally.
- **Do not clean the memory camcorder body with benzene or thinner:**
 - The coating of exterior could peel off or the case surface could deteriorate.
 - When using a chemical cleaning cloth, follow the instructions.
- **Keep the memory card out of reach of children to prevent swallowing.**
- **To disconnect the apparatus from the mains, the plug must be pulled out from the mains socket, therefore the mains plug shall be readily operable.**

ABOUT THIS USER MANUAL

- **This User Manual covers models SC-MX20, SC-MX20B, SC-MX20H, SC-MX20L, SC-MX20R, SC-MX20C, SC-MX20CH, SC-MX20E, SC-MX20EL and SC-MX20ER.**

The SC-MX20C, SC-MX20CH, and SC-MX20E, SC-MX20EL, SC-MX20ER have a 8GB, and 16GB built-in flash memory respectively but also use memory cards. The SC-MX20, SC-MX20B, SC-MX20H, SC-MX20L, SC-MX20R does not have built-in flash memory and uses memory cards exclusively.

Although some features of SC-MX20, SC-MX20B, SC-MX20H, SC-MX20L, SC-MX20R and SC-MX20C, SC-MX20CH, SC-MX20E, SC-MX20EL, SC-MX20ER are different, they are both operated in the same way.
- Illustrations of SC-MX20C model are used in this user manual.
- The displays in this user manual may not be exactly the same as those you see on the LCD screen.
- Designs and specifications of storage media and other accessories are subject to change without any notice.

NOTES REGARDING A TRADEMARK

- All the trade names and registered trademarks mentioned in this manual or other documentation provided with your Samsung product are trademarks or registered trademarks of their respective holders.
- Windows® is a registered trademark or trademark of Microsoft Corporation, registered in the United States and other countries.
- Macintosh is a trademark of Apple Inc.
- All the other product names mentioned here in may be the trademark or registered trademarks of their respective companies.
- Furthermore, “TM” and “R” are not mentioned in each case in this manual.

contents

INTRODUCTION TO BASIC FEATURES **07**

GETTING TO KNOW YOUR MEMORY CAMCORDER **09**

09

- 09** What's included with your memory camcorder
- 10 Front & left view
- 11 Side & bottom view

PREPARATION **12**

12

- 12** Using the accessories
- 14 Connecting a power source
- 22 Basic operation of your memory camcorder
- 23 LCD screen indicators
- 27 Turning the screen indicators on/off (**IC** / **iCHECK**)
- 28 Using the LCD enhancer
- 29 Adjusting the LCD screen
- 29 Using the MENU button
- 30 Using the Control buttons
- 32 Shortcut menu (OK Guide)
- 34 Initial setting : Time Zone, Date and Time & OSD Language

ABOUT THE STORAGE MEDIA **37**

37

- 37** Selecting the storage media
(SC-MX20C/MX20CH/MX20E/MX20EL/MX20ER only)
- 38 Inserting / ejecting the memory card
- 39 Selecting the suitable memory card
- 42 Recordable time and capacity

RECORDING

44

PLAYBACK

RECORDING OPTIONS

50

- 44 Recording movie images
- 45 Recording with ease for beginners (EASY Q mode)
- 46 Zooming In and out

- 47 Movie Images playback

- 50 Changing the menu settings
- 52 Menu items
- 53 Using the recording menu items
- 53 iSCENE
- 54 White Balance
- 55 Exposure
- 56 Shutter
- 57 Focus
- 59 Anti-Shake (HDIS)
- 60 Digital Effect
- 61 16:9 Wide
- 61 Resolution
- 62 Wind Cut
- 62 Voice Mute
- 63 Back Light
- 64 Interval REC
- 66 C.Nite
- 66 Fader
- 67 Guideline
- 67 Digital Zoom

contents

PLAYBACK OPTIONS

68

- 68 Menu items
- 69 Setting the play option
- 70 Deleting movie images
- 71 Protecting movie images
- 72 Copying movie images
(SC-MX20C/MX20CH/MX20E/MX20EL/MX20ER only)
- 73 File Information

SETTINGS OPTIONS

74

- 74 Changing the menu settings in "Settings"
- 75 Menu items
- 76 Using the settings menu items
- 76 Storage
- 76 Storage Info
- 77 Format
- 77 File No.
- 78 Time Zone
- 80 Date/Time Set
- 80 Date Format
- 80 Time Format
- 80 Date/Time
- 81 LCD Brightness
- 81 LCD Color
- 81 Beep Sound
- 82 Auto Power Off
- 82 TV Display
- 82 Default Set
- 83 Version
- 83 Menu Color
- 83 Transparency
- 83 Language
- 83 Demo

CONNECTING TO A PC

84

- 84** Transferring a Recorded File through a USB Connection
- 84 CyberLink MediaShow4
- 86 Installing the CyberLink MediaShow4
- 88 Connecting the USB cable
- 89 Viewing the contents of storage media
- 91 Transferring files from the memory camcorder to your PC
- 92 Uploading movie images in the memory camcorder to YouTube

CONNECTING TO OTHER DEVICES

- 93** Connecting to a TV
- 94 Viewing on a TV screen
- 95 Recording (dubbing) images on a VCR or DVD/HDD recorder

MAINTENANCE & ADDITIONAL INFORMATION

- 96** Maintenance
- 97 Additional information
- 99 Using your memory camcorder abroad

TROUBLESHOOTING

- 100** Troubleshooting

SPECIFICATIONS

- 113**

introduction to basic features

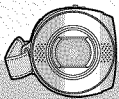

- ★ This chapter introduces you to the basic features of your memory camcorder. See the reference pages for more information.

Step1: Preparation

- Connecting a power source ➔page 14
- Check out the storage media ➔page 37
- Setting the Date/Time and OSD Language ➔pages 34, 36

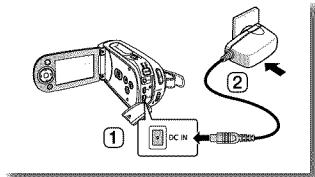

Step2: Recording

- Recording the movie images ➔page 44

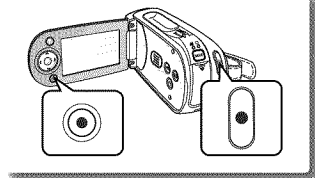

Step3: Playing back

- Selecting an image to play back from the thumbnail index views using **Control** button. ➔page 47
- Viewing playback from your memory camcorder on your PC or TV ➔pages 88-91, 93-94

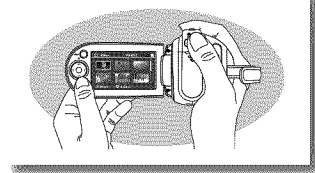

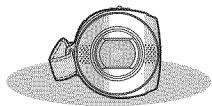

- ✦ This chapter introduces you to the basic features of your memory camcorder. See the reference pages for more information.

Step4: Connecting to a PC

- You can playback and edit recorded movies by using the CyberLink MediaShow4 application provided with the product. Also, using the CyberLink MediaShow4 allows easy upload of recorded movies file to YouTube ().

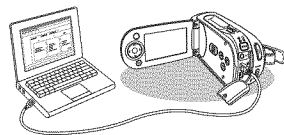

Step5: Easy Upload to YouTube

- You can upload recorded movie to YouTube using the CyberLink MediaShow4. ➔ page 92



getting to know your memory camcorder

WHAT'S INCLUDED WITH YOUR MEMORY CAMCORDER

Your new memory camcorder comes with the following accessories. If any of these items is missing from your box, call Samsung's Customer Care Center.

✦ **The exact shape of each item may vary by model.**



Battery pack
(IA-BP85ST)
AD43-00180A



AC power adaptor
(AA-E9 type)
AD44-00116B



Audio/Video Cable
AD39-00155A

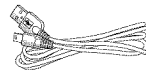

USB Cable
AD39-00153A



Software CD
AD46-00192A



User manual CD
AD46-00192B



Quick start guide
AD68-03076B

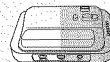

Cradle*
AD97-16073A



Pouch*
AD69-00932A



Carrying Case*
AD69-00929A



- The contents can vary depending on the sales region.
- Parts and accessories are available at your local Samsung dealer and service center.
- The memory card is not included. See page 39 for compatible memory cards for your memory camcorder.
- You have to connect the AC power adaptor to the cradle when connecting external devices using the cradle.
- Your camcorder includes user manual CD and quick start guide(printed). For more detailed instructions, refer to the user manual (PDF) on the provided CD.
- *(Option) : This is an optional accessory. To buy this one, contact your nearest Samsung dealer.

FRONT & LEFT VIEW

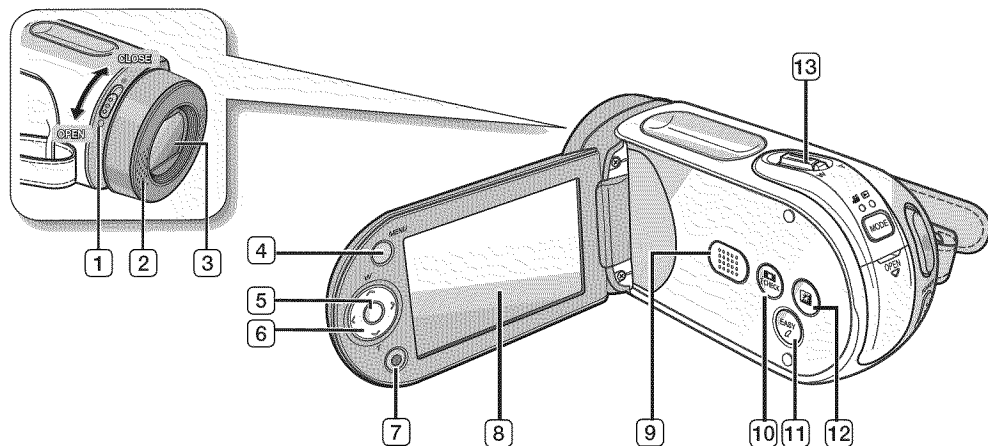

1 Lens open/close switch

2 Internal microphone

3 Lens

4 MENU button



5 OK button

6 Control button (^ / v / < / > / W / T)

7 Recording start/stop button

8 LCD screen

9 Built-in speaker

10  /  CHECK button

11 EASY Q button

12 LCD ENHANCER ( ) button

13 Zoom lever (W/T)



Be careful not to cover the internal microphone and lens during recording.

getting to know your memory camcorder

REAR & BOTTOM VIEW

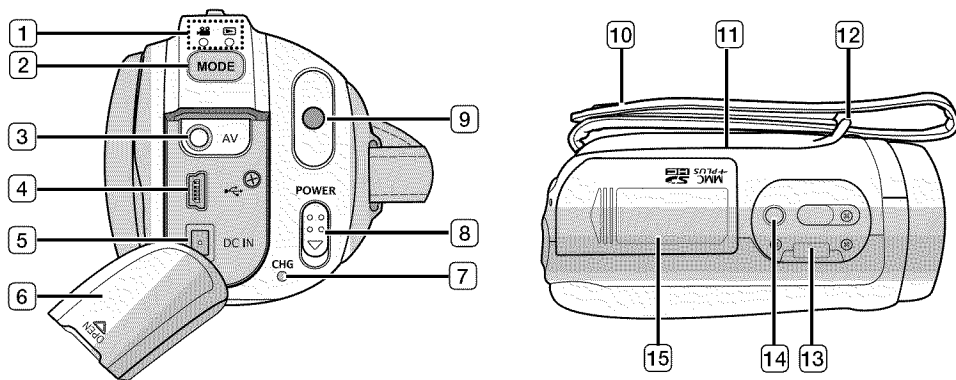

① MODE indicator
(Record (📹) / Player (▶))

② MODE button

③ AV cable jack (AV)

④ USB jack (🔌)

⑤ DC IN jack (DC IN)

⑥ Jack cover

⑦ Charging indicator (CHG)

⑧ POWER switch

⑨ Recording start/stop button

⑩ Grip belt

⑪ Swivel Hand-grip

⑫ Grip belt hook

⑬ Cradle receptacle
(SC-MX20C/MX20CH/MX20E/MX20EL/
MX20ER only)

⑭ Tripod receptacle

⑮ Memory card / Battery slot cover

Usable Memory Cards (16GB Max)

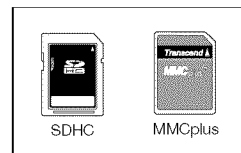

preparation

This section provides information that you should know before using this memory camcorder; such as how to use the provided accessories, how to charge the battery, how to setup the operation mode and initialize setup.

USING THE ACCESSORIES

Attaching a Grip Belt

- Insert your right hand from the bottom of memory camcorder up to the base of your thumb.
 - Put your hand in a position where you can easily operate the **Recording start/stop** button and the **Zoom** lever.
 - Adjust the length of grip belt so that the memory camcorder is stable when you press the **Recording start/stop** button with your thumb.
1. Detach the belt.
 2. Adjust the length of grip belt.
 3. Attach the belt.

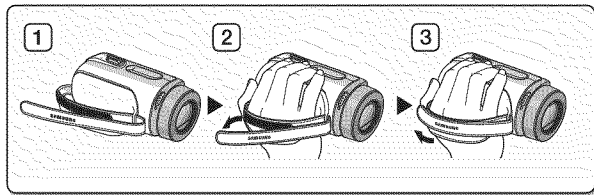

Angle Adjustment

This memory camcorder has a new swivel handgrip. Its handle turns along with the shooting angle. You can now shoot videos freely from high angles to low angles while standing.

- Rotate the swivel hand-grip to the most convenient angle.
- You can rotate it downward upto 180 degrees.

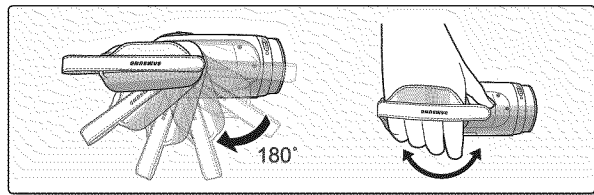

Please be noticed that using excessive force to insert your hand while the hand strap is adjusted too tight may damage the hand strap hook of the memory camcorder.





Please be careful not to turn the swivel handle backward as it may cause damage.

Using the Cradle

When recharging and connecting to external devices, use the cradle for better stability.

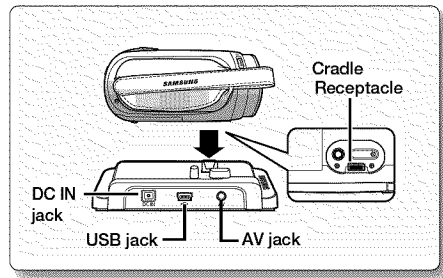
1. Put the memory camcorder onto the cradle, while making sure all terminals are well connected.
2. Connect the power supply or other external devices (such as TV, PC, etc.) to the cradle at your necessity.



-  If you connect your memory camcorder to the provided cradle using more than one type of output cable, the order of output signal is as follows: USB cable → AV cable.
- Do not connect the connection cables to the memory camcorder and cradle at the same time, it may cause conflict and may not work properly. If this occurs, remove all the connected cables and try the connection again.

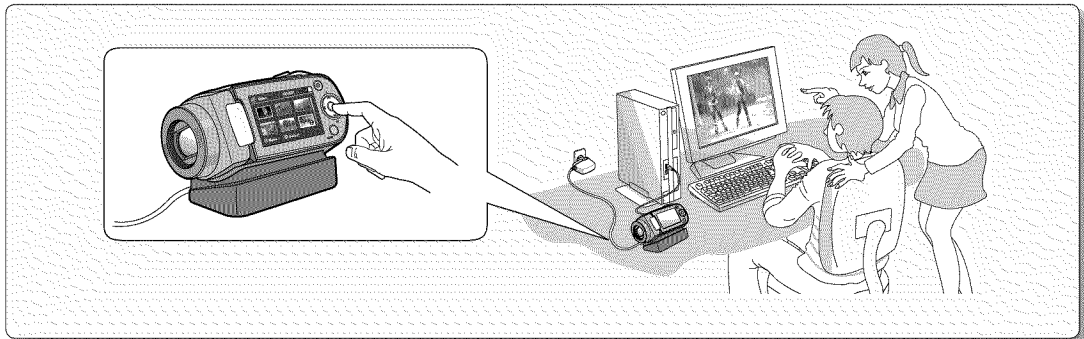

preparation

CONNECTING A POWER SOURCE

- There are two types of power source that can be connected to your memory camcorder.
- Do not use provided power supply units with other equipment.
 - The battery pack: used for outdoor recording.
 - The AC power adaptor : used for indoor recording and playing back. ➔page 21

Battery Pack installation / ejection

It is recommended you purchase one or more additional battery packs to allow continuous use of your memory camcorder.

Inserting the battery pack

1. Slide and open the battery slot cover as shown in the figure.
2. Insert the battery pack into the battery slot until it softly clicks.
 - Make sure that the SAMSUNG logo is facing up while the set is placed as shown in the figure.
3. Slide and close the battery slot cover.

Ejecting the battery pack

1. Slide and open the battery slot cover and push the battery lock.
 - Gently push the battery lock in the direction as shown in the figure to eject the battery out.
2. Pull the ejected battery out in the direction as shown in the figure.
3. Slide and close the battery slot cover.



- Store the battery pack separated from the memory camcorder while not in use.
- It is recommended to prepare an additional battery pack for prolonged outdoor use.
- Contact your nearest Samsung Electronics Service Centre for purchasing additional battery pack.

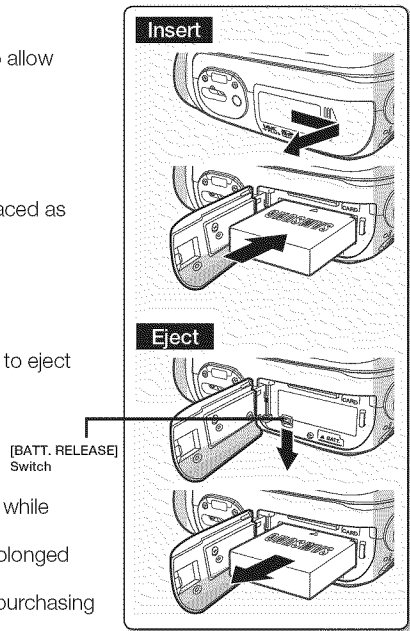

Charging the Battery Pack

- Be sure to charge the battery pack before you start using your memory camcorder.
- Use **IA-BP85ST** battery pack only.
- The battery pack may be charged a little at the time of purchase.

1. Slide the **POWER** switch downward to turn off the power.
2. Insert the battery pack to the memory camcorder. ➡page 14
3. Open the DC IN/USB/AV jack cover.
4. Connect the AC power adaptor to the DC IN jack of your memory camcorder.
5. Connect the AC power adaptor to a wall socket.
 - The CHG (charging) indicator lights up in orange and showing that the battery pack is charging.
 - The CHG (charging) indicator lights up in green when the battery is fully charged. ➡page 16

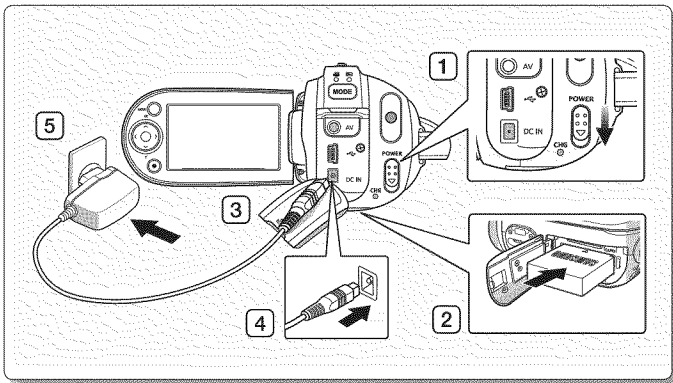

6. When the battery pack is fully charged, disconnect the AC power adaptor from the memory camcorder.
 - Even with the power switched off, the battery pack will still discharge if it is left attached to the memory camcorder. It is recommended that you remove the battery pack from the memory camcorder.



CAUTION

- Charging the battery pack in a low temperature circumstance may take longer time or fail to fully charge (green indicator will not turn on).
- Please make sure that there are no foreign substances in plug and socket when you connect AC power supply to the memory camcorder.
- Fully charge the battery pack before using.
- When using the AC power supply, place it close to the wall outlet. Found with malfunction while in use of memory camcorder, separate the AC power supply immediately from the wall outlet.
- Do not use the AC power supply in a narrow and small place, such as between furnishings.



- For recording indoors with available wall outlet, it is convenient to use the AC power supply instead of the battery pack.
- It is recommended to charge the battery pack in a place with ambient temperature of 10°C ~ 30°C.
- You can use the cradle for charging. ➡page 13

preparation

Charging indicator

Tips for battery identification

- ✦ The color of the LED indicates charging status.
 - If the battery has been fully charged, the charge indicator is green.
 - If you are charging the battery, the color of the charge indicator is orange.
 - If an error occurs while the battery pack is in charging, the charging indicator blinks red.

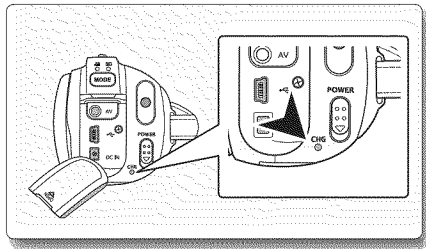

<Charging indicator>

Charging state	Power		Charge		
	On (Mode Select)	Off	Charging	Fully Charged	Error
LED color	Blue	-	Orange	Green	Red (Flicker)





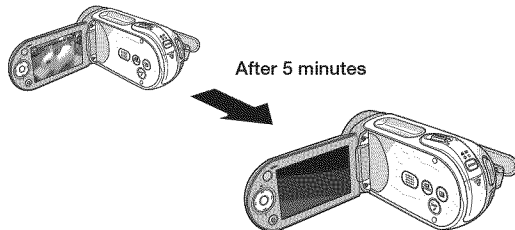

Auto Power Off Function

To save battery power, you can set the **"Auto Power Off"** function which turns off the memory camcorder if there is no operation for 5 minutes. To disable this option, change the setting of **"Auto Power Off"** to **"Off"**. ➔ page 82



Battery Level Display

The Battery Level Display shows the amount of battery power remaining in the battery pack.

Battery Level Indicator	State	Message
	Fully charged	-
	20~40% used	-
	40~60% used	-
	60~80% used	-
	80~99% used	-
	Exhausted (flickers): The device will soon turn off. Change the Battery Pack as soon as possible.	-
-	(flickers): The device will be forced to turn off after 5 seconds.	"Low battery"

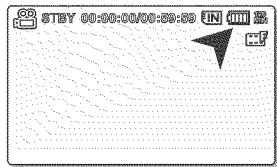

- Before using memory camcorder, charge the battery.
- Above figures are based on fully charged battery pack at a normal temperature. Low ambient temperature may affect the use time.

preparation

Charging, recording and playback times with fully charged battery pack (with no zoom operation, etc.)

- For your reference, the approximate time with fully charged battery pack:

Battery type			IA-BP85ST				
Charging time			approx. 2 hr.				
Movie resolution			720 x 480 (60i)			640 x 480	
			TV Super Fine	TV Fine	TV Normal	Web & Mobile	
Media	Built-in memory	Mode	Continuous recording time	approx. 180min.	approx. 180min.	approx. 180min.	approx. 180min.
			Playback time	approx. 300min.	approx. 300min.	approx. 300min.	approx. 300min.
	SD/SDHC/ MMCplus		Continuous recording time	approx. 180min.	approx. 180min.	approx. 180min.	approx. 180min.
			Playback time	approx. 300min.	approx. 300min.	approx. 300min.	approx. 300min.

- The time is only for reference. Figures show above are measured under Samsung's test environment, and may differ from users and conditions.
- We recommend using AC power adaptor when you are using the Interval REC Function.

Continuous Recording (without zoom)

The continuous recording time of memory camcorder in the table shows the available recording time when the memory camcorder is in the recording mode without using any other function after recording started. In actual recording, the battery pack may discharge 2-3 times faster than this reference since the record start/stop and zoom are being operated, and playback is performed. Assume that the recordable time with a fully charged battery pack is between 1/2 and 1/3 of the time in the table, and prepare additional charged battery pack(s) to allow the time you are planning to record on the memory camcorder. Note that the battery pack discharges faster in cold environment.



The charging time will vary depending on the remaining battery level.

About battery packs

- The benefits of battery pack: Battery pack is small but has a large power capacity. It should be recharged in any environment that is between 32°F (0°C) and 104°F (40°C).
However, when it is exposed to cold temperatures (below 32°F (0°C)), its usage time becomes reduced and it may cease to function. If this happens, place the battery pack in your pocket or other warm, protected place for a short time, then reattach it to the memory camcorder.
- The recording time shortens dramatically in a cold environment. The continuous recording times in the operating instructions are measured using a fully charged battery pack at 77 °F (25 °C). As the environmental temperature and conditions vary, the remaining battery time may differ from the approximate continuous recording times given in the instructions.

On handling a battery pack

- To preserve battery power, keep your memory camcorder turned off when you are not operating it.
- To save battery power, you can set the **"Auto Power Off"** function which turns off the memory camcorder if there is no operation for 5 minutes. To disable this option, change the setting of **"Auto Power Off"** to **"Off"** ➔ page 82
- Do not touch, or metallic objects to come into contact with the terminals.
- Make sure that the battery pack fits firmly into place. Do not drop the battery pack.
Dropping the battery pack may damage itself.
- Be careful to keep the battery pack out of the reach of children. There is danger that a child might swallow it.
- Frequent use of the LCD screen or using the fast forward or rewind buttons wears out the battery pack faster.
- Remove the battery pack from the camcorder for safekeeping after using your memory camcorder.
- Leaving the battery pack for extended period of time may discharge the battery pack completely.
 - A battery pack which is completely discharged may not turn on the recharging LED during the charging.
As it is designed to protect the battery pack, if the recharging LED turn on normally within 5 minutes, use the battery pack without a worry.

preparation

Maintaining the battery pack

- We recommend only using the original battery pack that is available from your Samsung retailer. When the battery reaches the end of its life, please contact your local dealer. The batteries have to be dealt with as chemical waste.
- Clean the terminals to remove any foreign substances before inserting the battery.
- Do not put the battery pack near any heat source (i.e. fire or a heater).
- Do not disassemble, apply pressure to, or heat the battery pack.
- Do not allow the + and - terminals of the battery pack to be short-circuited.
It may cause leakage, heat generation, induce overheating or fire.
- Do not expose the battery pack to water. The battery pack is not water resistant.
- When fully discharged, a battery pack damages the internal cells.
The battery pack may be prone to leakage when fully discharged.
- Remove from charger or powered unit when not in use. Even when the power is switched off, the battery pack will still discharge if it is left attached to the memory camcorder.
- When not using the memory camcorder for an extended period:
It is recommended that you fully charge the battery pack once per 6 months, attach it to memory camcorder and use it up: then remove the battery pack and store it in a cool place again.

About the battery life

- Battery capacity decreases over time and through repeated use. If decreased usage time between charges becomes significant, it is probably time to replace it with a new one.
- Each battery's life is governed by storage, operating and environmental conditions.

Use only approved battery packs. Do not use batteries from other manufacturers. Otherwise, there is a danger of overheating, fire or explosion. Samsung is not responsible for problems occurring due to using unapproved batteries.

Using a household power source

Make the same connections as you do when charging the battery pack. The battery pack will not lose its charge in this case.

Using memory camcorder with AC power adaptor

It is recommended that you use the AC power adaptor to power the memory camcorder from a household AC outlet when you perform settings on it, play back, or use it indoors.

- Make the same connections as you do when charging the battery pack. ➔page 15

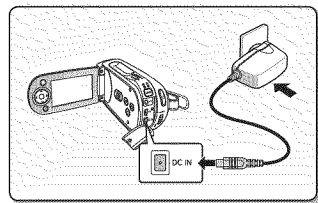

- Be sure to use the specified AC power adaptor to power the memory camcorder. Using other AC power adaptors could cause electric shock or result in fire.
- The AC power adaptor can be used around the world. An AC plug adaptor is required in some foreign countries. If you need one, purchase it from your distributor.



CAUTION

- Before detaching the power source, make sure that the memory camcorder's power is turned off. Failure to do so can result in memory camcorder malfunction.
- Use a nearby wall outlet when using the AC power adaptor. Disconnect the AC power adaptor from the wall outlet immediately if any malfunction occurs while using your memory camcorder.
- Do not use the AC power adaptor in a narrow space, such as between a wall and furniture.

preparation

BASIC OPERATION OF YOUR MEMORY CAMCORDER

This section explains the basic techniques of recording movies, and also basic settings on your memory camcorder. Set the appropriate operation mode according to your preference using **POWER** switch and **MODE** button.

Turning memory camcorder on or off

You can turn the power on or off by sliding the **POWER** switch down.

- Slide the **POWER** switch repeatedly to toggle the power on or off.

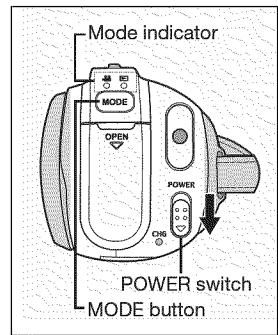

Setting the operating modes

- You can switch the operating mode in the following order each time you press the **MODE** button.
 - Movie Record mode (📹) → Movie Play mode (▶) → Movie Record mode (📹)
- Each time the operational mode changes, the respective mode indicator lights up.
 - Movie Record mode (📹): To record movie images.
 - Movie Play mode (▶): To play movie image.

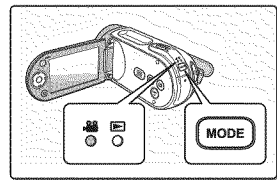

- When the memory camcorder is turned on, the self-diagnosis function operates and a message may appear. In this case, refer to "Warning indicators and messages" (on pages 100-102) and take corrective action.
- Movie Record is set by default with the power on.

LCD SCREEN INDICATORS

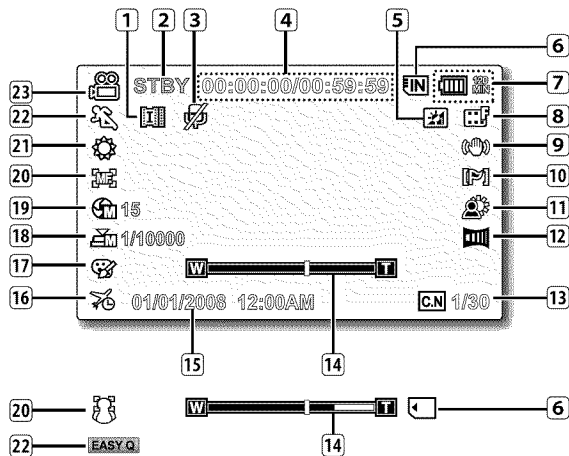

-  • The above screen is an example for explanation: It is different from the actual display.
- The OSD indicators are based on memory capacity of 2GB (SDHC memory card).
- Functions marked with * won't be kept when the memory camcorder is turned off and on again.
- For enhanced performance, the display indications and the order are subject to change without prior notice.

Movie Record mode

- | | |
|----|--|
| 1 | Interval REC * |
| 2 | Operating status
([STBY] (standby) or [●] (recording)) |
| 3 | Voice Mute * |
| 4 | Time counter
(movie recording time: remaining recordable time) |
| 5 | LCD Enhancer * |
| 6 | Storage media (Built-in memory (SC-MX20C/
MX20CH/MX20E/MX20EL/MX20ER only) or
memory card) |
| 7 | Battery info. (Remaining battery level/time) |
| 8 | Movie image resolution |
| 9 | Anti-Shake (HDIS) |
| 10 | Wind Cut |
| 11 | Back Light |
| 12 | Fader * |
| 13 | C.Nite * |
| 14 | Zoom (Optical zoom / Digital zoom) |
| 15 | Date/Time |
| 16 | Time Zone |
| 17 | Digital Effect |
| 18 | Manual Shutter * |
| 19 | Manual Exposure * |
| 20 | Manual Focus * / Face Detection * |
| 21 | White Balance |
| 22 | iSCENE / EASY Q * |
| 23 | Movie Record |

preparation

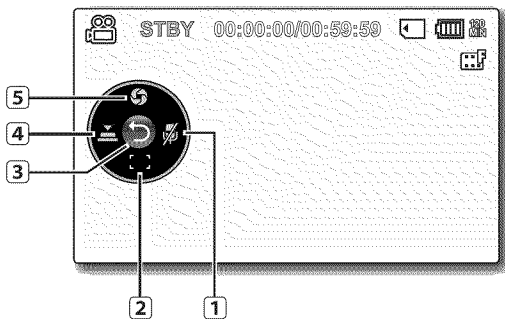

Movie Record mode: Shortcut menu (OK Guide)

- 1 Voice Mute* (On/Off)
- 2 Focus* (Auto Focus/Face Detection/Manual Focus)
- 3 Shortcut menu (OK Guide) / Return
- 4 Shutter* (Auto Shutter / Manual Shutter)
- 5 Exposure* (Auto Exposure / Manual Exposure)

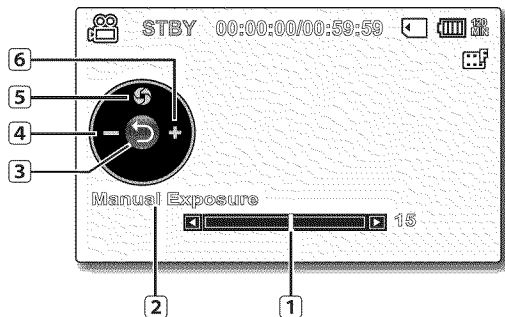

Movie Record mode: Shortcut menu (Manual)

- 1 Manual Control Bar/ Value
- 2 Menu name
- 3 Shortcut menu (OK Guide) / Return
- 4 Value adjust (down)
- 5 Manual Exposure
- 6 Value adjust (up)



- The illustration to the left shows the Manual Exposure screen.
- Functions marked with * won't be kept when the memory camcorder restarts.
- Shortcut menu (OK guide) represents the most frequently accessed functions according to the selected mode. Pressing the **OK** button will display shortcut menu of frequently used on the LCD screen.

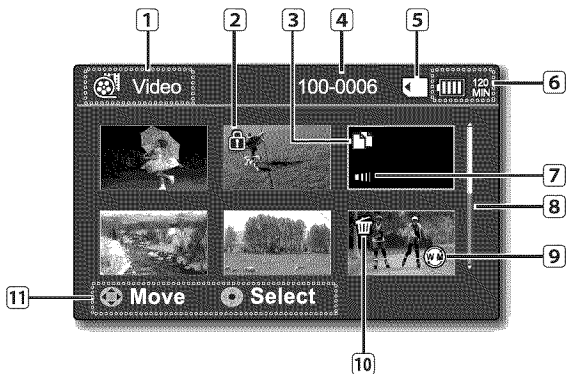

Movie Play mode : Thumbnail View

- 1 Movie Play mode
- 2 Protect
- 3 Copy Selected (SC-MX20C/MX20CH/MX20E/MX20EL/MX20ER only)
- 4 File Number
- 5 Storage media (Built-in memory (SC-MX20C/MX20CH/MX20E/MX20EL/MX20ER only) or memory card)
- 6 Battery info. (Remaining battery level/time)
- 7 Fader
- 8 Scroll bar
- 9 Web & Mobile
- 10 Delete Selected
- 11 Button Guide

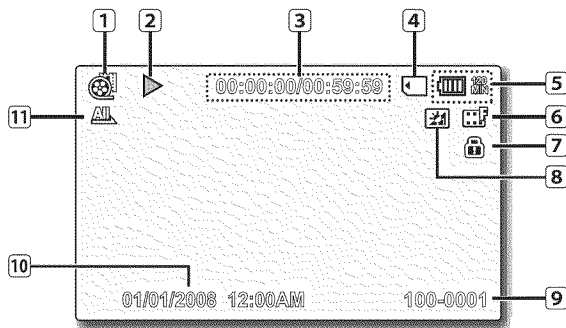

Movie Play mode : Single View

- 1 Movie Play mode
- 2 Play Status (Play (▶) / Pause (⏸))
- 3 Time code (Elapsed time / Recorded time)
- 4 Storage media (Built-in memory (SC-MX20C/MX20CH/MX20E/MX20EL/MX20ER only) or memory card)
- 5 Battery info. (Remaining battery level/time)
- 6 Movie image resolution
- 7 Protect
- 8 LCD Enhancer
- 9 File Name
- 10 Date/Time
- 11 Play Option

preparation

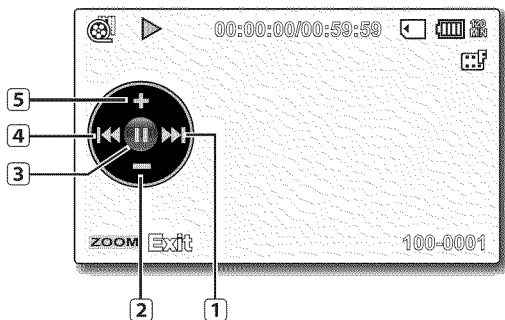

Movie Play mode : Shortcut menu (OK Guide)

- 1 Move to next file / FF (fast forward) ➡ page 49
- 2 Volume Down
- 3 Play Status (Play (▶) / Pause (⏸))
- 4 Move to previous file / REW (rewind) ➡ page 49
- 5 Volume Up

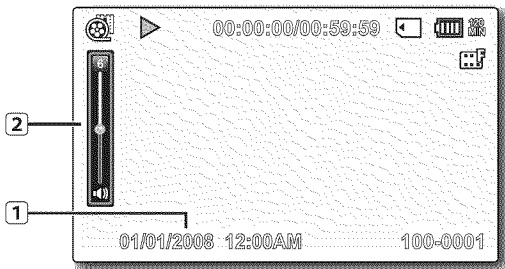

Movie Play mode : Single (Volume)

- 1 Date/Time
- 2 Volume Bar



- The illustration to the left shows the Manual Exposure screen.
- Functions marked with * won't be kept when the memory camcorder restarts.
- Shortcut menu (OK guide) represents the most frequently accessed functions according to the selected mode. Pressing the **OK** button will display shortcut menu of frequently used on the LCD screen.

TURNING THE SCREEN INDICATORS ON/OFF (/ *i*CHECK)

Switching the information display mode



- You can switch the display mode of on-screen information:
Press the  / *i*CHECK button while the camcorder is on.
The full and minimum display modes will alternate.
- Full display mode:** All types of information will appear.
Minimum display mode: Only the operating status indicator will appear.

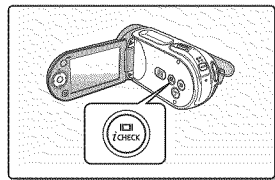

 If the memory camcorder has warning information, a warning message will appear.



Checking the remaining battery and memory capacity

Without turning the camcorder on, you can check the remaining battery time and memory capacity.

- When the camcorder is turned off (battery is installed) press and release the  / *i*CHECK button to display the remaining capacity of the battery.
- When the camcorder is turned on (battery is installed) press and hold the  / *i*CHECK button for more than 2-3 seconds to display the remaining battery capacity.
- The approximate recordable time in the selected storage and the battery information appear for about 10 seconds.
- Selected storage media is indicated in green, and **"No Card"** appears if there is no memory card inserted.
- Pressing the  / *i*CHECK button or any other button in battery information screen will return to the previous screen.

-  Battery information is only available if the battery is inserted. While connected to AC adaptor without battery inserted, **"No Battery"** message appears.
- It also displays cautions and notices according to the state.
 -  / *i*CHECK button does not operate in menu and quick menu screen.

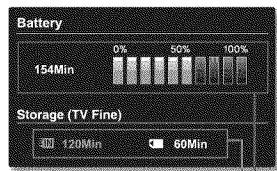



Recording capacity (approx.)

Remaining battery (approx.)



preparation

USING THE LCD ENHANCER FUNCTION

- Contrast is enhanced for a clear and bright image. This effect is also implemented outdoors in bright daylight.
- You can also adjust the screen brightness in two-level increments, which provides a brighter screen than using just one-level increment for your recording.

1. Press the **LCD ENHANCER** () button.
 - LCD adjust () indicator appears and the LCD brightens.
2. You can switch the LCD enhancer function in the following order each time you press the **LCD ENHANCER** () button.

Release → **LCD enhancer 1level** () → **LCD enhancer 2level** () → **Release**



- LCD enhancer 1level (): LCD enhancer is executed.
- LCD enhancer 2level (): You can make a brighter-screen than using just one-level adjustment.

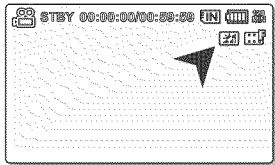
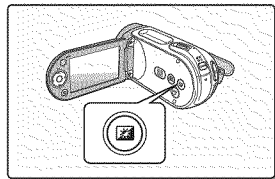

- LCD enhancer function does not affect the quality of the image being recorded.
- When LCD enhancer works at the low illumination, some stripes may occur on the LCD screen. It is not a malfunction.
- Using the LCD Enhancer function may cause color looks different on the display.



ADJUSTING THE LCD SCREEN

1. Open up the LCD screen 90 degrees with your finger.
 2. Rotate it to the best angle to record or play.
 - If you rotate the LCD screen 180 degrees to the lens side, you can close the LCD screen with it facing out. This is convenient during playback.
-  • See page 81 to adjust brightness and color of the LCD screen.
-  • Over-rotation may cause damage to the inside of the hinge that connects the LCD screen to the memory camcorder.



Do not lift the memory camcorder when holding the LCD screen.

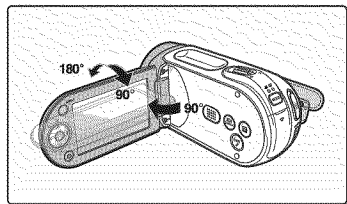

USING THE MENU BUTTON

1. Set the desired mode by pressing the **MODE** button.
2. Press the **MENU** button.
3. Move the cursor by pressing the **Control** button (**▲/▼/◀/▶**) to select the desired menu item, and then press **Control** button **OK** to confirm.
4. Press the **MENU** button to finish.

 The **MENU** button does not operate in the EASY Q mode.

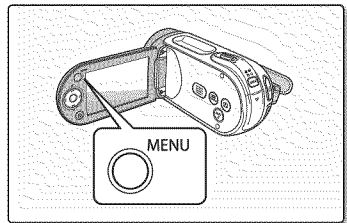

preparation

USING THE CONTROL BUTTONS

Used for playback, pausing, fast forwarding, and rewinding.
Also used as directional buttons (up, down, left, right) and to make a selection when selecting movie images or menus.







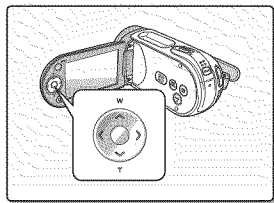

1. Press the **Control** button (< / >) to move left / right.
2. Press the **Control** button (^ / v) to move up / down.
 - Confirm your selection by pressing the **OK** button.



- **Control** button (**OK** / (< / >)) does not operate in the **EASY Q** mode.
- Using the **OK** button, you may directly access the shortcut menu. ➡page 32



Using the Control button

Button	Movie Record()mode	Movie Play() mode	Menu selection
 OK	<ul style="list-style-type: none"> - Access the shortcut menu - Confirm selection - Exit the shortcut menu 	<ul style="list-style-type: none"> - Shortcut menu (OK guide) is displayed - Playback / Pause 	Confirms selection
 UP	Zoom (wide)	Increases the volume	Moves the cursor up
 DOWN	Zoom (tele)	Decreases the volume	Moves the cursor down
 LEFT		<ul style="list-style-type: none"> - Search playback RPS (Reverse Playback Search) rate: x2→x4→x8→x16 - Previous Skip Playback 	Moves to the previous menu
 RIGHT		<ul style="list-style-type: none"> - Search playback FPS (Forward Playback Search) rate: x2→x4→x8→x16 - Next Skip Playback - Frame-by-frame playback - Slow motion playback (Slow Motion Playback Rate: x1/2→x1/4→x1/8→x1/16) 	Moves to the next menu

preparation

SHORTCUT MENU (OK GUIDE)







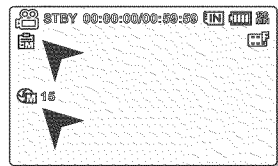
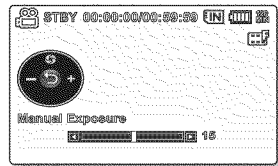
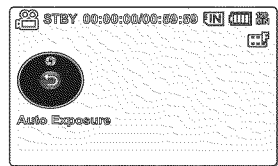
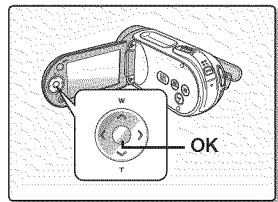





Shortcut menu (OK guide) represents the most frequently accessed functions according to the selected mode.

✦ For example: Setting the Exposure in Movie Record mode by the Shortcut menu (OK guide).

1. Press the **OK** button.
 - Shortcut menu (OK guide) is displayed.
 2. Press the **Control** button (▲) will display the Auto Exposure shortcut menu screen, where you can press **OK** button to set up Auto Exposure.
 3. Press the **Control** button (▲) once again will display the Manual Exposure shortcut menu screen with a manual control bar, where you can adjust the value press the **Control** button (◀/▶).
 4. Press the **OK** button to confirm your selection.
 - Manual Exposure indicator (Ⓜ 15) will display on the screen.
 - Press the **OK** button to exit the shortcut menu.
- ✎ • Shortcut menu (OK guide) cannot be used in EASY Q mode.
• Pressing the **Control** button in each menu will toggle between "Auto" or "Manual".



Shortcut function using the Control buttons

Button	Movie Record() mode	Movie Play() mode
 OK	<ul style="list-style-type: none"> - Access the shortcut menu - Confirm selection - Exit the shortcut menu 	<ul style="list-style-type: none"> - Shortcut menu (OK guide) is displayed - Playback / Pause 
 UP	Exposure <ul style="list-style-type: none"> - Auto - Manual 	Increases the volume
 DOWN	Focus <ul style="list-style-type: none"> - Auto - Face Detection - Manual 	Decreases the volume
 LEFT	Shutter <ul style="list-style-type: none"> - Auto - Manual 	<ul style="list-style-type: none"> - Search playback RPS (Reverse Playback Search) rate: x2→x4→x8→x16 - Previous Skip Playback
 RIGHT	Voice Mute <ul style="list-style-type: none"> - Off - On 	<ul style="list-style-type: none"> - Search playback FPS (Forward Playback Search) rate: x2→x4→x8→x16 - Next Skip Playback - Frame-by-frame playback - Slow motion playback (Slow Motion Playback Rate: x1/2→x1/4→x1/8→x1/16)

preparation

INITIAL SETTING : TIME ZONE, DATE AND TIME & OSD LANGUAGE

- Initial setting is available in all operating modes.
- To read the menus or messages in your desired language, set the OSD language.
- To store the date and time during recording, set the time zone and date/time.

Turning the power on and setting the date and time

Set the date and time when using this memory camcorder for the first time.
If you do not set date and time, the date and time (time zone) screen appears every time you turn on your memory camcorder.

1. Slide **POWER** switch downward to turn on the camcorder.
When you turn on your camcorder for the first time, the Time Zone screen appears based on Lisbon, London.
 - You can also set the Time Zone ("Home") from the "**Settings**" menu. ➔page 78
2. Select the your geographical area with **Control** button (< / >), then press **OK** button.
 - The Date/Time Set screen appears.
3. Set the month with **Control** button (^ / v), then move it next with **Control** button (< / >).
4. Set day, year, hour and minute (AM/PM) in the same way, then move it next with **Control** button (< / >).
5. Set DST set (⚙) with **Control** button (^ / v).
 - Set the icon (⚙) to on to move the time forward 1 hour.
(DST set: daylight saving time)
6. Make sure that the clock is correctly set, then press **OK** button.
 - The clock starts.
 - You can set any year up to the year 2037.

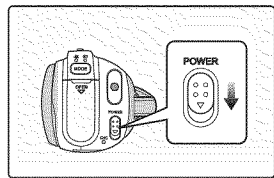



- **On charging the built-in rechargeable battery**

The built-in rechargeable battery is automatically charged while the camcorder is turned on. Use your camcorder after charging the built-in rechargeable battery. If the built-in rechargeable battery is not charged, settings will not be backed up and the date/time appears on the screen as **"01/01/ 2008 12:00 AM"** (when **"Date/Time"** display is set to **"On"**).

- After setting, the date and time are automatically recorded on a special data area of the storage media.

Turning the date and time display on/off

- To switch the date and time display on or off, access the menu and change the Date/Time mode. ➡page 80

Setting the clock to the local time zone while traveling

- While traveling, you can easily set the clock to the local time by selecting the time zone on the camcorder. Select **"Time Zone"** on the menu, then set **"Visit"**. ➡page 78

preparation

INITIAL SETTING : TIME ZONE, DATE AND TIME & OSD LANGUAGE

Selecting the OSD language

You can select the desired language to display the menu screen and the messages.

1. Set the **"Settings"** mode.
 - The settings menu screen appears.
 - Refer to "How to set the settings mode" to access the **"Settings"** mode.
↳ page 74
2. Press the **Control** button (^ / v) to select **"Language"**, and then press the **OK** button.
3. Press the **Control** button (^ / v) to select the desired OSD language, and then press the **OK** button.
 - English / 한국어 / Français / Deutsch / Italiano / Español / Português / Nederlands / Svenska / Suomi / Norsk / Dansk / Polski / Čeština / Slovensky / Magyar / Українська / Русский / 中文 / ไทย / Türkçe / العربية / فارسي / IsiZulu
4. Press the **MENU** button to exit the menu.
 - The OSD language is refreshed in the selected language.



- Even if the battery pack or AC power are removed, the language setting will be preserved.
- **"Language"** options may be changed without prior notice.

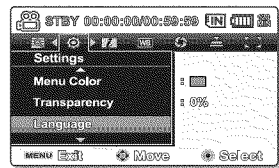

about the storage media

SELECTING THE STORAGE MEDIA (SC-MX20C/MX20CH/MX20E/MX20EL/MX20ER only)

- You can record on the built-in memory or a memory card, so you should select the desired storage media before starting recording or playback.
- You can use SDHC and MMCplus cards on your memory camcorder. (Some cards are not compatible depending on the memory card manufacturer and memory card type.)
- Before inserting or ejecting the memory card, turn the memory camcorder off.

Selecting the storage media

1. Press the **MENU** button.
 - The menu list will appear.
2. Press the **Control** button (< / >) to select "**Settings**".
3. Press the **Control** button (^ / v) to select "**Storage**", then press the **OK** button.
4. Press the **Control** button (^ / v) to select "**Memory**" or "**Card**", then press the **OK** button.
 - "**Memory**": When using the built-in memory.
 - "**Card**": When using the memory card.
5. Press the **MENU** button to exit.

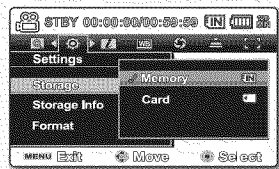
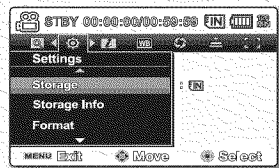

Using the built-in memory (SC-MX20C/MX20CH/MX20E/MX20EL/MX20ER only)

- Because this memory camcorder has an embedded memory, it is not necessary to buy extra storage media. So you can take or playback moving/recording conveniently.

Using a memory card (not supplied)

- This memory camcorder has multi card slot for access to SDHC (Secure Digital High Capacity) and MMCplus.
- You can use SDHC and MMC plus card on your memory camcorder.
 - Some cards are not compatible depending on the memory card manufacturer and memory card type.

- Never format the built-in memory or memory card using a PC.
- If you insert a memory card when the memory camcorder is on, a pop-up message will prompt you automatically to select the storage type.
- If there is no memory card inserted, only the built-in memory will be available.
- Do not eject a memory card while it is being used in the camcorder. The memory card and its data may be damaged.
- Do not remove the power (battery pack or AC power adaptor) when accessing storage media such as recording, playback, format, delete, etc. The storage media and its data may be damaged.

INSERTING / EJECTING THE MEMORY CARD

Inserting a memory card

1. Turn the memory camcorder off.
2. Slide the memory card slot cover to the right to open the cover.
3. Insert the memory card into the memory card slot in the direction of the arrow shown in the figure until it softly clicks.
4. Close the cover.

Ejecting a memory card

1. Turn the memory camcorder off.
2. Slide the memory card slot cover to the right to open the cover.
3. Slightly push the memory card inwards to pop it out.
4. Pull the memory card out of the memory card slot and close the cover.

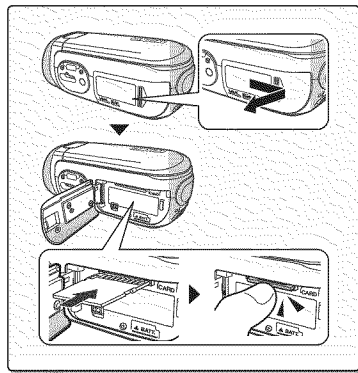

As shown in the figure, slide the memory card inwards with the label facing down.

If the memory card is inserted with the label facing up, the memory camcorder may not work, or the tip of the memory card can be damaged.

about the storage media

SELECTING A SUITABLE MEMORY CARD

A memory card is a compact portable storage media.

- **You can use a SDHC memory card and MMC plus.**
(If needed, buy a memory card separately.)
 - You can also use a SD memory card, but recommended that you use a SDHC memory card and MMC plus with your memory camcorder.
(SD memory cards over 2GB are not compatible with this memory camcorder.)
- **On this memory camcorder, you can use memory cards (SDHC or MMCplus) of the following capacity: 512MB ~ 16GB**

- **Compatible recording media**

- The following recording media have been guaranteed to work with this memory camcorder. Others are not guaranteed to work, so buy such products with caution.

SDHC or SD memory cards: By Panasonic, SanDisk, and TOSHIBA

MMC plus: By Transcend

- If other media are used, they may fail to record data correctly, or they may lose data that has already been recorded.
- For movie recording, use a memory card that support faster write speed (at least 2MB/sec).

SDHC (Secure Digital High Capacity) Memory Card

- SDHC memory card complies with new SD specification Ver.2.00.
This latest specification was established by SD Card Association to realize data capacity over 2GB.
- The SDHC memory card supports a mechanical write protection switch. Setting the switch prevents accidental erasure of files recorded on the SDHC memory card. To enable writing, move the switch up to the direction of terminals. To set write protection, move the switch down.
- Due to change In File Allocation System and physical specifications, SDHC memory card can not be used with current SD enabled host devices. SDHC memory card can be used with only SDHC enables host devices which carry SDHC logo on devices its self or on its operation manual.

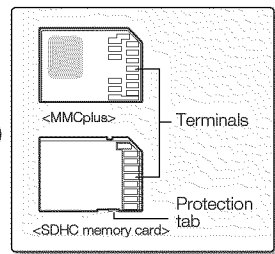

<Usable Memory Cards>
(512MB ~16GB)

MMCplus (Multi Media Card plus)

- In the case of MMCplus, they have no protection tab so please use the protect function in the menu.

Common cautions for memory card

- Damaged data may not be recovered. It is recommended you make a back-up of important data separately on the hard disk of your PC.
- Turning the power off or removing a memory card during operation such as formatting, deleting, recording, and playback may cause the data loss.
- After you modify the name of a file or folder stored in the memory card using your PC, your camcorder may not recognize the modified file.

Handling a memory card

- It is recommended that you power off before inserting or removing the memory card to avoid data loss.
- It is not guaranteed that you can use a memory card formatted by other devices. Be sure to format your memory card using this camcorder.
- You have to format newly-purchased memory cards, memory cards with data that your camcorder cannot recognize or are saved by other devices. Note that formatting erases all data on the memory card.
- If you cannot use a memory card that has been used with another device, format it with your memory camcorder. Note that formatting erases all information on the memory card.
- A memory card has a certain life span. If you cannot record new data, you have to purchase a new memory card.
- A memory card is a precision electronic media. Do not bend it, drop it, or cause a strong impact.
- Do not use or store in a place that has high temperature and humidity or dusty environment.
- Do not place foreign substances on the memory card terminals. Use a soft dry cloth to clean the terminals if required.
- Do not paste anything other than exclusive label on label pasting portion.
- Be careful to keep memory card out of the reach of children, who might swallow it.

about the storage media

The memory camcorder supports SDHC and MMCplus memory cards for data storage.

- The data storage speed may differ, according to the manufacturer and production system.
- The user using a lower write speed memory card for recording a movie may have difficulties storing the movie on the memory card. You can even lose your movie data during the recording.
- In an attempt to preserve any bit of the recorded movie, the memory camcorder forcibly stores the movie on the memory card and displays a warning: **"Low speed card. Please record a lower resolution."**

To facilitate movie recording, you are recommended to use a memory card that supports faster write speed.

- If you are unavoidably using a low speed memory card, resolution of the recording may be lower than the set value. ➡page 61
However, the higher the resolution, the more memory will be used.
- You can have four resolution options to record a movie with the memory camcorder :
"TV Super Fine", "TV Fine", "TV Normal", "Web&Mobile"
- **For optimal performance of the memory camcorder, ensure that you purchase a fast speed memory card.**

Actual formatted capacity may be less as the internal firmware uses a portion of the memory.







- Samsung is not responsible for data loss due to misuse.
- We recommend using a memory card case to avoid losing data from moving and static electricity.
- After a period of use, the memory card may get warm. This is normal and is not a malfunction.

RECORDABLE TIME AND CAPACITY

- The following shows the memory camcorder's maximum recording time according to the resolution / memory capacity.
- For recording movie images be noticed with the approximate maximum limits.

Recordable time for movie images

Media		built-in memory (SC-MX20C/MX20CH/ MX20E/MX20EL/ MX20ER only)	Memory Card					
			8GB	16GB	1GB	2GB	4GB	8GB
TV Super Fine ()	720x480(60i)	approx. 190min.	approx. 380min.	approx. 23min.	approx. 47min.	approx. 95min.	approx. 190min.	approx. 380min.
TV Fine ()	720x480(60i)	approx. 240min.	approx. 480min.	approx. 30min.	approx. 60min.	approx. 120min.	approx. 240min.	approx. 480min.
TV Normal ()	720x480(60i)	approx. 310min.	approx. 620min.	approx. 38min.	approx. 77min.	approx. 155min.	approx. 310min.	approx. 620min.
Web & Mobile ()	640x480	approx. 460min.	approx. 920min.	approx. 57min.	approx. 115min.	approx. 230min.	approx. 460min.	approx. 920min.

1GB= 1,000,000,000bytes : actual formatted capacity may be less as the internal firmware uses a portion of the memory.

about the storage media



- The previous figures are measured under Samsung's standard recording test conditions and may differ depending on the test or use condition.
- The memory camcorder provides four resolution options for movie recordings:
 - **"TV Super Fine", "TV Fine", "TV Normal", "Web&Mobile"**.
For a same scene, higher resolution setting will retain the better image with bigger data size in the order of **"TV Super Fine", "TV Fine", "TV Normal", "Web&Mobile"**.
- The compression rate increases while lowering the resolution (in the order of **"TV Super Fine", "TV Fine", "TV Normal", "Web&Mobile"**). The higher the compression rate is, the picture resolution is more deteriorated but the recording time will be increased.
- The compression rate automatically adjusts to the recording image, and the recording time may vary accordingly.
- **You can use a SDHC or MMCplus memory card on your memory camcorder.**
Some cards may not compatible depending on the memory card manufacturer and memory card type.
- Proper operation is not guaranteed for those memory cards that are not formatted by this memory camcorder.
Perform the formatting directly on the memory camcorder for formatting.
- To facilitate the movie recording, it is recommended to use a memory card that supports faster write speed. (Write speed: 2MB / sec or higher) If you use a low write-speed memory card, recording may stop with a message of **"Low speed card. Please record a lower resolution"**.
- It supports proper operation with up to **16GB** of memory card for movie recording / playback. Memory cards of bigger than **16GB** in capacity may not work properly.
- The memory card that is used to store a movie can cause unwritable area, which may result in reduced recording time and free memory space.
- The maximum size of a movie (H.264/AVC) file that can be recorded at one time is 1.8GB.
- You can store up to 9999 movie images on one memory card using the memory camcorder.
- The movie image files recorded by other equipment are not playable on this memory camcorder.
- Built-in memory is used in the SC-MX20C/MX20CH/MX20E/MX20EL/MX20ER only.

recording

Basic procedures to record a movie image are described below and on the following pages.

RECORDING MOVIE IMAGES

- The memory camcorder provides two **Recording start/stop** buttons. One is on the rear side of the camcorder and the other one is on the LCD panel. Select the **Recording start/ stop** button according to the use.

1. Turn the memory camcorder on.

- Connect a power source to the memory camcorder. ➔pages 14, 21 (A battery pack or an AC power adaptor)
- Slide the **POWER** switch downward to turn on the power. ➔page 22
- Set the appropriate storage media. ➔page 37 (SC-MX20C/MX20CH/MX20E/MX20EL/MX20ER only) (If you want to record on a memory card, insert the memory card.)
- Set the Lens open/close switch to open (○). ➔page 10

2. Check the subject on the LCD screen.

3. Press the **Recording start/stop** button.

- The recording indicator (●) will display and recording will start.
- Pressing the **Recording start/stop** button again during recording will set the memory camcorder to recording pause mode.

4. When recording is finished, turn the memory camcorder off.



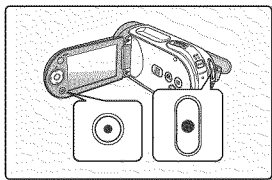

- For on-screen information display. ➔page 23
- Eject the battery pack when you have finished recording to prevent unnecessary battery power consumption.
- For approximate recording time. ➔page 42
- For various functions available when you record movie images. ➔pages 52-67
- If focusing is difficult, use the manual focus function. ➔page 58
- During recording, some button operations are unavailable. (**MODE** button, **MENU** button, etc.)
- Sound is recorded from the internal stereo microphone on the front of the memory camcorder. Take care that this microphone is not blocked.
- Before recording an important movie, make sure to test on the recording function to check if there is any problem with the audio and video recording.
- While recording, don't insert or eject the memory card as it may record noise.
- Do not operate the power switch or remove the memory card while accessing the storage media. Doing so may damage the storage media or the data on storage media.



-  You can not use a locked memory card for recording. You will see a message saying recording is disabled due to the lock.
- You can select the resolution of movie images to be recorded. ➔page 61
- Note that power failure during a recording such as disconnected DC power jack or exhausted battery may damage the file.

RECORDING WITH EASE FOR BEGINNERS (EASY Q MODE)

- With the EASY Q function, most of the memory camcorder settings are automatically adjusted, which frees you from detailed adjustments.
- Slide the **POWER** switch downward to turn on the memory camcorder.
 - Press the **MODE** button to set Movie Record mode (). ➔page 22
 - Press the **EASY Q** button.
 - When you press the **EASY Q** button, most functions turn off and the following functions are set to "Auto". (Exposure, Focus, Shutter, etc.)
 - The EASY Q and **Anti-Shake(HDIS)** () indicator appear on the screen at the same time.
 - To record movie images, press the **Recording start/stop** button.
 - Recording will begin using the basic automatic settings.

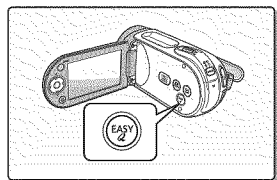

To cancel EASY Q mode

Press the **EASY Q** button again.

- The EASY Q and **Anti-Shake (HDIS)** () indicators disappear from the screen.
- Almost all the settings will return to the settings that were set prior to activating the EASY Q mode.

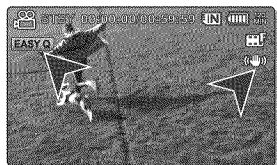

Unavailable buttons during EASY Q operation

- The following button and menu operations are unavailable because the items are automatically set. And the corresponding message "**Release the EASY Q**" may appear if unavailable operations are attempted.
 - **MENU** button / **OK** button / etc.
- Cancel EASY Q function if you want to add any effect or settings to the images.
- The EASY Q mode settings are released when the memory camcorder is turned off.
- EASY Q mode automatically sets the "**Anti-Shake(HDIS)**" to "**On**" while using EASY Q.
- You can directly select iSCENE mode pressing **EASY Q** button for 3 second. ➔page 53

recording

ZOOMING IN AND OUT

Use the zoom function for close-up or wide-angle recording.
This memory camcorder allows you to record using optical 34x power zoom and 1200x digital zoom.

- You can zoom with the zoom lever or the **Control** (W/T) button on the LCD panel.
- Zoom magnification over 34x is done through digital image processing, and is therefore called digital zoom. Digital zooming is possible up to 1200x.
Set "**Digital Zoom**" to "**On**". ➔page 67

To zoom in

- Slide the Zoom lever towards **T** (telephoto).
(Or press the **Control** button (▼) on the LCD panel.)

To zoom out

- Slide the Zoom lever towards **W** (wide-angle).
(Or press the **Control** button (▲) on the LCD panel.)





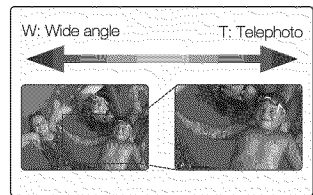
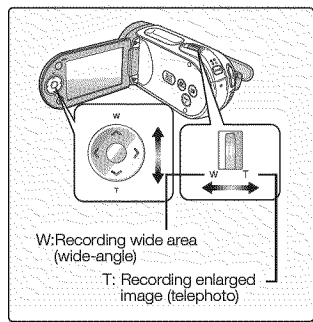

- If you operate the Zoom (W/T) lever during recording, the sound of the lever may be recorded as well.
- You can also zoom with the **Control** (W/T) button on the LCD panel.
- The minimum possible distance between camcorder and subject while maintaining sharp focus is about 1cm (about 0.39 inch) for wide angle and 1m (about 39.4 inch) for telephoto.
- The focus changes when zooming after focussing manually. Focus automatically or seize the desired scene by zooming before focussing manually. ➔page 58
- Optical zoom preserves the movie quality, but during digital zoom the quality of image may suffer.
- Fast zooming or zooming in subject of far distance may produce slow focusing. In this case, use "**Manual Focus**". ➔page 58
- It is recommended to use "**Anti-Shake (HDIS)**" with handheld recording if the subject is zoomed in and enlarged.
- Frequent use of zooming in / out consumes more battery power.





playback

MOVIE IMAGES PLAYBACK

You can find a desired movie image quickly using thumbnail index view.

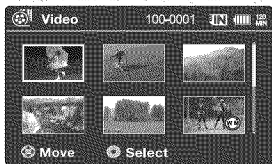
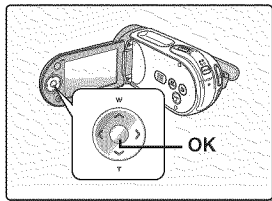
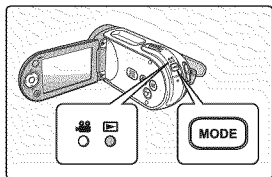
1. Turn the memory camcorder on.
 - Slide the **POWER** switch downward to turn on the power. ➡page 22
 - Set the appropriate storage media. ➡page 37
(SC-MX20C/MX20CH/MX20E/MX20EL/MX20ER only)
(If images were recorded on a memory card, insert the memory card.)
2. Open the LCD screen.
 - Adjust brightness or color of the LCD screen. ➡page 81
3. Press the **MODE** button.
 - Switches to Movie Play mode ().
 - The recorded movie images are displayed in thumbnail index view.
4. Use the **Control** button ( /  /  / ) to select the desired movie images, and then press the **OK** button.
 - Shortcut menu for playback will be displayed for a while.
 - The selected movie images are played according to Play Option setting. ➡page 69
 - To stop playback and return to the thumbnail index view, move the zoom lever.



-  If there is no file stored to view, the message "**Empty**" appears.
- Closing the LCD screen while in playback will automatically mute the sound.
- Movie files may not playback with memory camcorder in following cases:
 - Edited or renamed movie file on a PC
 - Movie file recorded by devices other than memory camcorder
 - Movie files of not supported file format by the memory camcorder
- The Built-in speaker automatically turns off when Audio/Video cable is connected to the memory camcorder. (When connected to external devices, volume adjustment should be done on the connected external device.)
- You can play back recorded movie files on a TV or a PC. ➡pages 88, 93
- You can upload recorded movie files to YouTube. ➡page 92
- For various functions available during playback, see "**playback options**". ➡pages 68~73

Adjusting the volume

- You can hear the recorded sound from the built-in speaker.
- You can control the volume by using the **Control** button (▲/▼).
- The level can be adjusted anywhere between 0 and 10.
(If you close the LCD screen while playing, you will not hear the sound from the speaker.)

Press the **Control** button (▲/▼) to increase or decrease the volume.

- The volume bar disappears after 3~4 seconds.

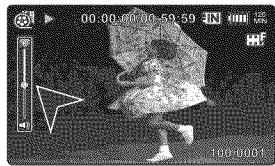

playback

Various Playback Operations

Still playback (pause) (▶/||)

- Press the **OK** button during playback.
 - To resume normal playback, press the **OK** button again.

Search playback (◀/▶)

- During normal playback, press and hold the **Control** button (➤) for forward search, or to the left for reverse search.
- Pressing the **Control** button to (◀/➤) repeatedly increases the search speed for each direction.
 - RPS (Reverse Playback Search) rate: x2→x4→x8→x16
 - FPS (Forward Playback Search) rate: x2→x4→x8→x16
- To resume normal playback, press the **OK** button.

Skip playback (⏮/⏭)

- During playback, press the **Control** button (➤) to locate the start point of the next file. Pressing the **Control** button (➤) repeatedly skips files in forward direction.
- During playback, press the **Control** button (◀) to locate the start point of the current file, pressing the **Control** button (◀) repeatedly skips files in reverse direction.
- Press the **Control** button (◀) within 3 seconds from the start point, it skips to the first image of the previous file.

Frame-by-frame playback (⏪)

- While playback is paused, press the **Control** button (➤).
 - Pressing the **Control** button (➤) repeatedly advances the still picture frame by frame.
 - To resume normal playback, press the **OK** button.

Slow motion playback (⏩)

- While playback is paused, press and hold the **Control** button (➤), it plays back in slow motion at x1/2, x1/4, x1/8 and x1/16 speed.
- To resume normal playback, press the **OK** button.
- Recorded sound does not play in slow playback.

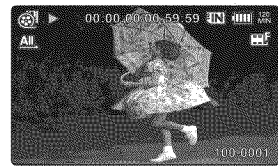
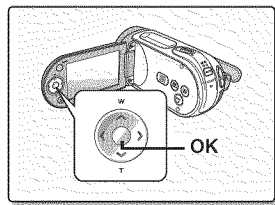

recording options

CHANGING THE MENU SETTINGS

You can change the menu settings to customize your memory camcorder. Access the desired menu screen by following the steps below, then change the various settings.

1. Slide **POWER** switch downward to turn the memory camcorder on.
2. Select the operation mode. ➡page 22
3. Press **MENU** button.
 - The menu screen appears.
4. Select the desired sub menu and menu item with the **Control** buttons (**▲/▼/◀/▶**) and the **OK** button.
 - To return to the normal screen, press **MENU** button.
 - Depending on the mode selected, some menu items may not be available to select and change.

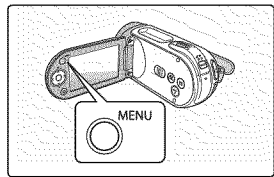





You can also access the shortcut menu using the **OK** button. ➡page 32

Button Tips

- a. **MENU** button : Use it to enter or exit the menu.
- b. **Control** button (**▲/▼/◀/▶**) : Use it to move up/down/left/right
- c. **OK** button : Use it to select or confirm the menu.

➤ Follow the instructions below to use each of the menu items listed after this page.

For example: setting the White Balance in Movie Record mode.

1. Slide the **POWER** switch downward to turn the memory camcorder on.
2. Select the operation mode.
 - For Movie Record Menus: Press **MODE** button to set Record ().
3. Press **MENU** button.
 - The menu screen appears.
4. Press the **Control** button ( / ) to select "**White Balance**".
5. Select the desired sub menu item with the **Control** button ( / ), and then press the **OK** button.
6. Press **MENU** button to exit the menu.



- The selected item is applied and the indicator is displayed. If you set some items to "**Auto**", the item's indicator may not displayed on the screen. (iSCENE, White Balance, Exposure, Shutter, Focus, etc.)
- You can also change the menu setting, using the shortcut menu represents the most frequently accessed functions. ➡ page 33

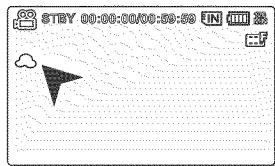
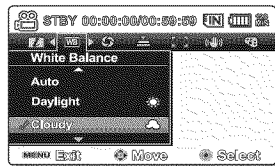
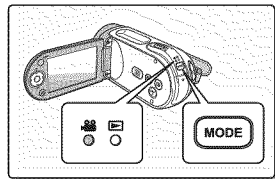

recording options

MENU ITEMS

- Accessing items in the menu depends on the operation mode.
- For operation details, see the corresponding page. ➔ pages 53~67

Menu items in Movie Record ()

Items	Default value	Page
iSCENE	Auto	53
White Balance	Auto	54
Exposure	Auto	55
Shutter	Auto	56
Focus	Auto	57
Anti-Shake (HDIS)	Off	59
Digital Effect	Off	60
16:9 Wide	On	61
Resolution	TV Fine	61
Wind Cut	Off	62
Voice Mute	Off	62
Back Light	Off	63
Interval REC	Off	64
C.Nite	Off	66
Fader	Off	66
Guideline	Off	67
Digital Zoom	Off	67
Settings	-	

USING THE RECORDING MENU ITEMS

You can set up the menu items for movie images recording.

iSCENE

This memory camcorder automatically sets the shutter speed and aperture according to the subject brightness for optimum recording. You can also specify one of various modes depending on subject conditions, recording environment or purpose of filming.

item	contents	on-screen display
"Auto"	- You can shoot images in Auto adjustment mode.	None
"Sports"	- Reduces blurring when recording rapidly moving subjects such as in golf or tennis. If the Sports mode is used under a fluorescent light, the image may flicker. In this case, use the Auto mode for recording.	
"Portrait"	- Creates a shallow depth of field so that the person or subject appears against a softened background. - The portrait mode is most effective when used outdoors. - The shutter speed is automatically adjusted from 1/60 to 1/1000 per second.	
"Spotlight"	- Prevents over exposure of subject's face, etc. when strong light strikes the subject, as in a wedding or on stage.	
"Beach"	- When recording seaside or lakeside scenes, the blue of the water is clearly recorded.	
"Snow"	- When recording snowy scenes of other places where the whole screen appears white, use this mode to prevent sunken colors and record clear images.	
"High Speed"	- For recording fast-moving subjects such as golf or tennis matches.	
"Food"	- Recording close-up objects in high saturation.	
"Waterfall"	- Recording a waterfall or fountain.	
"Manual"	- Adjustments necessary for shooting are made automatically, but you can also make exposure value, shutter speed, etc. adjustments as desired. In addition, you can also set the desired shooting functions using menus.	





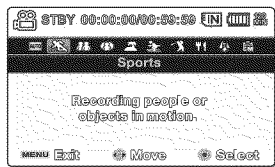

- This function will not operate in the EASY Q mode.
- You can check the selected "iSCENE" on the on-screen information display. However, nothing will appear in "Auto" mode.
- In iSCENE mode, setting the exposure to "Manual" applies the exposure first (aperture priority).
- You can directly select iSCENE mode by the pressing **EASY Q** button for 3 seconds.





recording options

White Balance

This memory camcorder automatically adjusts the color of subject. Change the white balance setting depending on the recording conditions.

item	contents	on-screen display
"Auto"	Adjusts the White Balance automatically.	None
"Daylight"	Adjusts for conditions outside under a clear sky, at sundown, night scenes, the presence of neon signs or fireworks.	
"Cloudy"	Adjusts for a cloudy sky or shady location.	
"Fluorescent "	Adjusts for white fluorescent lighting.	
"Tungsten"	Adjusts for places under incandescent lamp, or under bright lighting, such as in a photo studio.	
"Custom WB"	Adjusts White Balance manually to match the light source or situation.	

Setting the white balance manually :

1. Select **"Custom WB"**.
 - The indicator () and the message **"Set White Balance"** are displayed.
2. Frame a white object such as a piece of paper so that it fills the screen. Use an object that is not transparent.
 - If the object that fills the screen is not focused, correct the focus using **"Manual Focus"** ➔ page 57
3. Press the **OK** button.
 - The white balance setting will be applied and indicator () is displayed.

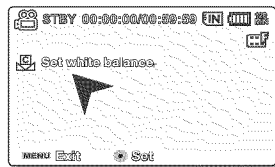
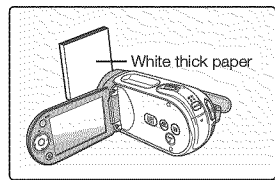

-  A subject can be recorded under various types of lighting conditions indoors (natural, fluorescent, candlelight, etc.). Because the color temperature is different depending on the light source, the subject tint will differ depending on the white balance settings. Use this function for a more natural result.
- The white balance can not be used while EASY Q is in use.
- It is recommended that you specify **"Digital Zoom"** to **"Off"** before setting white balance. ➡page 67
- Reset the white balance if lighting conditions change.
- During normal outdoor recording, setting to auto may provide better results.
- Do not use a colored object when setting white balance: The appropriate tint cannot be set.

Exposure

The memory camcorder usually adjusts the exposure automatically. You can also manually adjust the exposure depending on the recording conditions.

item	contents	on-screen display
"Auto"	This option automatically adjusts image brightness according to the environmental light conditions.	None
"Manual"	<ul style="list-style-type: none"> - You can adjust the brightness of an image manually. - Adjust the brightness when the subject is too bright or too dark. 	

Setting the exposure manually:

When manually setting the exposure, the default setting appears as the value is automatically adjusted according to the environmental light conditions.

- Press the **Control** button (< / >) to adjust the exposure while viewing the image on the LCD screen.
 - Confirm your selection by pressing the **OK** button.
 - Exposure value can be set between **"00"** and **"29"**.
 - If you set exposure to manual, the higher the exposure, the brighter the recorded picture will be.

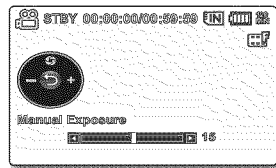

Manual exposure is recommended in situations listed below :

- When shooting using reverse lighting or when the background is too bright.
- When shooting on a reflective natural background such as at the beach or when skiing.
- When the background is overly dark or the subject is bright.

-  The exposure also can be set in the shortcut menu. ➡page 32
- EASY Q mode automatically sets the **"Exposure"** to **"Auto"**.
- In iSCENE mode, setting the exposure to **"Manual"** applies the manual adjustment of the exposure first, and the iSCENE mode is set to **"Manual"** automatically.

recording options



Shutter

The memory camcorder automatically sets the shutter speed depending on the subject brightness. You can also manually adjust the shutter speed according to the scene conditions.

Settings	Contents	On-screen display
"Auto"	The memory camcorder automatically sets the appropriate aperture value.	None
"Manual"	Shutter speed can be set to 1/60, 1/100, 1/250, 1/500, 1/1000, 1/2000, 1/4000, or 1/10000.	 1/XXXX

Setting the shutter speed manually:

You can set the shutter speed manually. A fast shutter speed can freeze the motion of a fast moving subject and a slow shutter speed can blur the subject to give the impression of motion. The adjusted value is applied right after moving the **Control** button (</>) to adjust the shutter speed.

1. Press the **Control** button () to select "**Manual**".
 - The manual shutter adjustment indicators appear.
2. Press the **Control** button (</>) to select the desired indicator to adjust the shutter speed, then press the **OK** button.
 - The adjusted value is applied right after pressing the **Control** button (</>) to adjust the shutter speed.
 - The manual shutter setting will be applied and ( 1/XXXX) indicator is displayed.



The shutter speed also can be set in the shortcut menu. ➡page 32

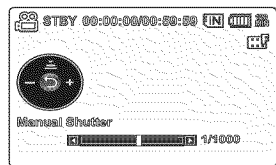

Recommended shutter speed when recording:



Shutter speed	Conditions
1/60	The shutter speed is fixed at 1/60 second. Black bands that usually appear when shooting a TV screen become narrower.
1/100	The shutter speed is fixed at 1/100 second. Indoor sports such as basketball. The flickering that occurs when shooting under a florescent light or mercury-vapor lamp is reduced.
1/250, 1/500, 1/1000	Moving cars, trains or other rapidly moving vehicles such as roller coasters.
1/2000, 1/4000, 1/10000	Outdoor sports such as golf and tennis.



- In iSCENE mode, setting the shutter speed to "**Manual**" applies the manual adjustment of the shutter speed first.
- The image may not seem smooth when a high shutter speed is set.
- This function will be set to "**Auto**" in the EASY Q mode.
- When recording with a shutter speed of 1/1000 or higher, make sure the sun is not directly shining into the lens.



Focus

- The memory camcorder usually focuses on a subject automatically (auto-focus).
- You can also manually focus a subject depending on the recording conditions.



item	contents	on-screen display
"Auto"	In most situations, it is better to use the automatic focus feature, as it enables you to concentrate on the creative side of your recording.	None
"Face Detection"	Records under the optimal condition by detecting faces automatically.	
"Manual"	Manual focusing may be necessary under certain conditions that make automatic focusing difficult or unreliable.	

Face detection

It detects and recognizes face-like shape and adjusts focus, color and exposure automatically. Also, it adjusts recording conditions optimized for the face detected.

1. Press the **Control** button ( / ) to select **"Face Detection"**, and then press the **OK** button.
 - Detects a face and shows a frame on it. The detected face image is optimized automatically.



- The Face Detection Indicator () and Face Detection Frame () are not recorded.
- Framing a person's face while Face Detection is set will adjust focus and exposure to optimal values automatically.
- Face Detection may not operate depending on the recording conditions. For example, the Face Detection Frame may appear when framing a "face-like" shape, even when the subject is not a person's face. If this occurs, turn off the Face Detection feature.
- The Face Detection feature will not work when framing the side of a person's face. You must facing them "head-on"
- Face Detection will not work in Web&Mobile mode.
- While using the following functions, you cannot use the **"Face Detection"** function: EASY Q, iSCENE, Shutter, Exposure, Digital Effect, C.Nite  page 105

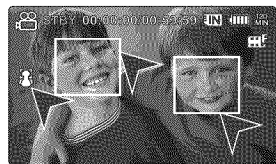
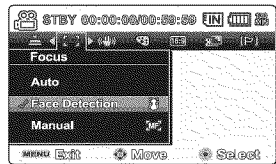

recording options

Focusing manually during recording:

This memory camcorder automatically focuses a subject from close-up to infinity. However, the correct focus may not be obtained depending on the recording condition. In this case, use the manual focus mode.

1. Press the **Control** button (\wedge / \vee) to select "**Manual**".
 - The manual focus adjustment indicator appears.
2. Press the **Control** button (\langle / \rangle) to select the desired indicator to adjust focus, then press the **OK** button.

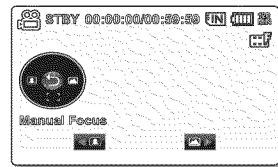



Focusing in a nearer subject

To focus on a nearer subject, press the **Control** button (\langle) towards the indicator ().

Focusing on a subject further away

To focus on a subject further away, press the **Control** button (\rangle) towards the indicator ().

- The nearer or farther icon ( / ) appears between the indicators when focus adjustment reaches the end. The adjusted value is applied right after press the **Control** button (\langle / \rangle) is pressed.
- The manual focus setting will be applied and () indicator is displayed.



<Nearer subject >

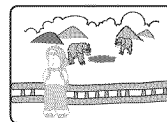

<Further subject >

Manual focus is recommended in the following situations :

- A picture containing several objects, some close to the memory camcorder, others further away.
- A person enveloped in fog or surrounded by snow.
- Very shiny or glossy surfaces like a car.
- People or objects moving constantly or quickly like an athlete or a crowd.



- You can easily adjust the focus using Shortcut menu button. ➡ page 32
- Manual focusing focuses on a point in the framed scene while auto focusing focuses on the center area automatically.
- EASY Q mode will set the focusing to "**Auto**" automatically.
- Before focusing by manual, frame your scene by zooming. Zooming after setting the focus requires focusing again.
- Before focusing by manual, check if the "**Digital Zoom**" is turned off. While "**Digital Zoom**" is turned on, manual focusing will not focus with accuracy. Turn the "**Digital Zoom**" off. ➡ page 67
- When the focusing reaches to its limit, an indicator appears on the center of the LCD screen.

Anti-Shake (HDIS)

Helps compensate for natural hand-shaking movements when recording.

item	contents	on-screen display
"Off"	Disables the function.	None
"On"	Compensates for unstable images caused by camcorder-shake, particularly at high magnification.	

Anti-Shake(HDIS) provides a more stable image when:

- Recording while zooming
- Recording small objects
- Recording while walking or moving
- Recording through the window of a moving vehicle























- EASY Q mode automatically sets the "Anti-Shake(HDIS)" to "On" while using EASY Q.
- When "Anti-Shake(HDIS) : On" is specified, there will be a slight difference between the actual movement and the movement on screen.
- Excessive camcorder shake may not be entirely corrected even if "Anti-Shake(HDIS) : On" is set.
- It is recommended that you specify "Anti-Shake(HDIS): Off" when using the memory camcorder on a desk or tripod.
- When you record pictures with 34x or more magnification and the "Anti-Shake(HDIS)" is set to "On" in dark locations, after-images may appear. If this occurs, we recommend using a tripod and turning the "Anti-Shake(HDIS)" to "Off".

recording options

Digital Effect

- The digital effect enables you to give a creative look to your recording.
- Select the appropriate digital effect for the type of picture that you wish to record and the effect you wish to create.
- There are 10 different digital effect options.

item	contents	on-screen display	
"Off"	Disables the function.	None	
1 "BLK&WHT"	Changes the images into Black and White.		
2 "Sepia "	This mode gives the images a reddish brown pigment.		
3 "Negative"	Reverses the colors and the brightness, creating the look of a negative.		
4 "Art"	Adds artistic effects to an image.		
5 "Emboss"	This mode creates a 3D effect (embossing).		
6 "Mosaic"	A mosaic overlay appears on an image.		
7 "Mirror"	This mode cuts the image in half and displays a mirrored image on the other half.		
8 "Pastel"	This mode applies a pale pastel drawing effect to an image.		
9 "Cosmetic"	This mode helps adjust for facial imperfections.		
10 "Stepprinting"	Technique of recording the image in segments.		

-  "Digital Effect" modes are not available while **EASY Q** is in use.
- In "16:9 Wide" or "C.Nite" mode, you can not use the following functions : "Mosaic", "Mirror", "Stepprinting"(Digital Effect). If you want to use the following functions, set the "16:9 Wide" or "C.Nite" menu to "Off" first.

16:9 Wide

You can select the desired LCD display aspect ratio for recording or playback (16:9 Wide/4:3 aspect ratio).

item	contents	on-screen display
"Off"	Disables the function. Displays the image in 4:3 aspect ratio. Select to use the standard display aspect 4:3 ratio on the screen.	None
"On"	Recording and playback of 16:9 aspect ratio.	None



- In **"16:9 Wide"** mode, you can not use the following functions : **"Mosaic"**, **"Mirror"**, **"Stepprinting"** (Digital Effect). If you want to use the following functions, set the **"16:9 Wide"** menu to **"Off"** first.
- Please set the aspect ratio before recording. The default setting is **"16:9 Wide"**.
- 16:9 Wide mode is not available when the resolution is set to **"Web & Mobile"**.

Resolution

You can select the resolution of a movie to be recorded. This memory camcorder can record in the **"TV Super Fine"**, **"TV Fine"**, **"TV Normal"** and **"Web & Mobile"** modes. The "TV Fine" mode is set as the factory default.

item	contents	on-screen display
"TV Super Fine"	Movie images recorded in the 720x480(60i) resolution at super-fine image quality.	
"TV Fine"	Movie images recorded in the 720x480(60i) resolution at fine image quality.	
"TV Normal"	Movie images recorded in the 720x480(60i) resolution at normal image quality.	
"Web & Mobile"	Movie images recorded in the 640x480 resolution at normal image quality. It supports viewing with the optimal resolution on a PC.	



- You can record a scene at four resolution levels: **"TV Super Fine"**, **"TV Fine"**, **"TV Normal"** or **"Web & Mobile"**. However, the better the resolution is, the more memory is used.
- The recording times depend on the resolution of a movie to be recorded. ➤page 42
- Only 4:3 aspect ratio is applied to the recording in **"Web & Mobile"** mode.

recording options

Wind Cut

You can reduce wind noise when recording sound from the built-in microphone.

If **"Wind Cut : On"** is set, the low-frequency components in the sound picked up by the microphone will be cut off during recording: This makes it easier to hear voice and sound during playback.

- Use the Wind Cut when recording in windy places such as a beach.

item	contents	on-screen display
"Off"	Disables the function	None
"On"	Minimizes wind noise or other noise while recording.	



- Make sure the **"Wind Cut"** is set to **"Off"** when you want the microphone to be sensitive as possible.
- The Wind Cut function works only with the built-in microphone.
- The Wind Cut function can not use while EASY Q is in use.

Voice Mute

The Voice Mute function is used if you want to block the incoming external sound and make a silent recording.

item	contents	on-screen display
"Off"	Disables the function.	None
"On"	Movie images are recorded without audio.	



The Voice Mute also can be set in the shortcut menu. ➔page 32

Back Light

When subject is lit from behind, this function will compensate for lighting so that the subject is not too dark.

item	contents	on-screen display
"Off"	Disables the function.	None
"On"	- Backlight compensation is executed. - Backlight compensation brightens the subject quickly.	

Back lighting influences recording when the subject is darker than the background:

- The subject is in front of a window.
- The subject is against a snowy background.
- The subject is outdoors and the background is overcast.
- The light sources are too bright.
- The person to be recorded is wearing white or shiny clothes and is placed against a bright background:
The person's face is too dark to distinguish his/her features.



<BLC off>



<BLC on>



The **"Back Light"** function can not use while EASY Q is in use.

recording options

Interval REC (Interval recording)

Interval Rec records still images at specific intervals you can set and plays them as one movie file.

This function is useful to observe the movement of clouds, the changes in daylight or blooming flowers, etc.

item	contents	on-screen display
"Off"	Disables the function	None
"On"	- Interval time ("Sec"): Image of the subject is captured by set interval. 1→3→5→10→15→30 Sec - Total recording time ("Hr"): Total recording time, from the beginning to the end of the interval recording. 24→48→72→∞ Hr	

Setting the Interval:

1. Press the **MENU** button.
2. Press the **Control** button (**</>**) to select **"Interval REC"**, and then press the **OK** button.
3. Press the **Control** button (**^/∨**) to select **"On"** then press the **OK** button.
 - The interval ("**Sec**") and total recording time ("**Hr**") items appear.
4. Set a desired interval time ("**Sec**") and total recording time ("**Hr**") using the **Control** button (**^/∨/ </>**).
5. After setting the last item, press the **OK** button to finish the setting. When you start movie recording, and interval recording starts.
 - Images of the subject are captured and saved to the storage media by set interval and total recording period.
 - Playing back will display 30 images per second. (Sound is not available.) For example, if the interval was **"30 Sec"** and the total recording period was **"24 Hr"**, interval recording captures images of the subject and saves to the storage media at every 30 seconds for 24 hours. (After 24 hours of recording, playing it back will play the recording of 24 hours for about 48 minutes.)

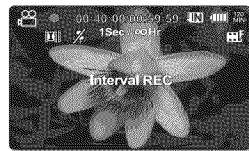
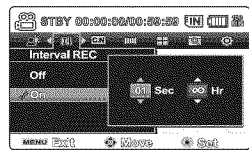
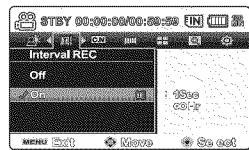

Example of Interval Recording

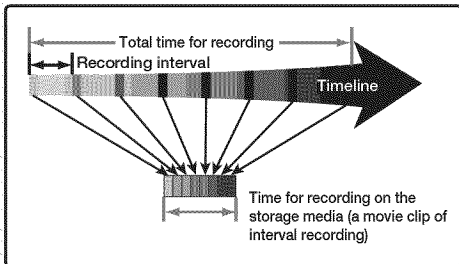

Interval Recording records image frames at the predefined interval over the total recording time to produce a time-lapse video.

For example, Interval Recording is useful for filming following cases:

- Blooming flowers
- Insect's skin-casting
- Clouds rolling by in the sky

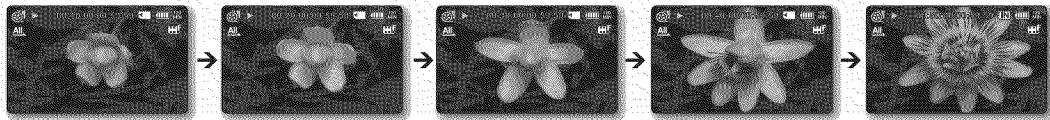







- Interval recording mode is released once it has been finished. To start another interval recording, repeat steps 1~5.
- Captured 30 contiguous images compose a movie clip of 1 second length. Since the minimum length of a movie to be saved by the memory camcorder is one second, Interval defines how long the interval recording should be taken. For example, if you set the interval to **"30 Sec"**, interval recording should be taken for at least 15 minutes to record minimum movie length of 1 second (30 images).
- Once the interval recording finishes recording for its total recording period, it switches to the standby mode.
- When the memory space of the storage media is insufficient for the recorded interval recording, it switches to the standby mode after saving the recording up to its maximum.
- When the battery charge was exhausted during an interval recording, it saves recording up to the point and switches to standby mode, displays message of exhausted battery, and then turns off automatically.
- Do not turn off the LCD during the Interval recording.
- Press the **Recording start/stop** button if you want to stop the Interval recording.
- The Interval recording does not support the sound input. (mute recording)
- When a movie recording fills up 1.8GB of built-in memory, a new recording file is automatically started at that point. (SC-MX20C/MX20CH/MX20E/MX20EL/MX20ER only).
- Fade function is not available with interval recording. ➡page 105
- We recommend using AC power adaptor when you are using the Interval REC Function.

recording options

C.Nite

You can take a shot of an object in slow motion by controlling the shutter speed, or a brighter image in dark places without compromising colours.



item	contents	on-screen display
"Off"	Disables the function.	None
"  AUTO"	The memory camcorder automatically adjusts image brightness.	
"  1/30"	Records a brighter image brighter.	
"  1/15"	Records a brighter image even in a dark place.	



- When using the C.Nite, the image takes on a slow motion like effect.
- When using the C.Nite, the focus adjusts slowly and white dots may appear on the screen, this is not a defect.
- The C.Nite function can not use while the following functions are in use.
: "iSCENE", "Anti-Shake(HDIS)" or EASY Q
- "Mirror", "Mosaic" and "Stepprinting" mode is not available in the "C.Nite" mode. ➔page 60

Fader

You can give your recording a professional look by using special effects such as fade in at the beginning of a sequence or fade out at the end of a sequence.

item	contents	on-screen display
"Off"	Disables the function.	None
"In"	As soon as you start recording, the fader will be executed.	
"Out"	When the recording is done, the fader will be executed.	
"In-Out"	When you start or stop recording, the fader will be executed accordingly.	

Fade in

Press the **Recording start/stop** button when "Fader" is set to "In".
Recording starts with a dark screen and then the image and sound are faded in.

Fade out

Press the **Recording start/stop** button when "Fader" is set to "Out".
Recording stops as the image and sound are faded out.

Fade in-out

Press the **Recording start/stop** button when "Fader" is set to "In-Out".
Recording starts with a dark screen and then the image and sound are faded in.
And recording stops as the image and sound are faded out.

Fade In (Approx. 3 seconds)





Fade Out (Approx. 3 seconds)



Guideline

- Guideline displays a certain pattern on the LCD screen so that you can easily set the image composition when recording.
- The memory camcorder provides 3 types of guidelines.

item	contents	on-screen display
"Off"	Disables the function.	None
"Cross"	Enables you to center the subject for proper recording.	
"Grid"	Enables you to place the subject in the center square for proper positioning.	
"Safety Zone"	Enables you to place the subject within a safety zone which prevents it being cut when editing in 4:3 for left and right and 2.35:1 for top and bottom.	



- Positioning the subject at the cross point of the guideline makes a balanced composition.
- Guideline cannot be recorded on the images being recorded.

Digital Zoom

- You can select the maximum zoom level in case you want to zoom to a level greater than 34x (the default setting) during recording. Up to 34x zoom is performed optically, and after that, up to 1200X zoom is performed digitally. Note that the image quality decreases when you use the digital zoom.



This right side of the bar shows the digital zooming zone.
The zooming zone appears when you move the zoom lever.

item	contents	on-screen display
"Off"	Only optical zoom is available up to 34x.	None
"On"	Digital zoom is available up to 1200x. Moving the zoom lever will display the digital zoom bar.	None







- You can also zoom with the **Control (W/T)** button on the LCD panel.
- The image quality may deteriorate depending on how much you zoom in on the subject.
- Maximum zooming may result in lower image quality.

playback options

MENU ITEMS

- Accessible items in the menu vary depending on the operation mode.
- See pages 47-49 for playback information and button operation.
- See pages 69-73 for details on menu items during playback.

Menu items in Movie Play (▶)

Items	on-screen display	Default value	Page
Play Option		Play All	69
Delete		-	70
Protect		-	71
Copy (SC-MX20C/MX20CH/MX20E/ MX20EL/MX20ER only)		-	72
File Info	-	-	73
Settings	-	-	74

SETTING THE PLAY OPTION

- You can play all movie images continuously or play the selected movie images only.
- You can also set the repeat option for all movie images.

- Slide the **POWER** switch downward to turn on the memory camcorder.
 - Set the appropriate storage media.
(SC-MX20C/MX20CH/MX20E/MX20EL/MX20ER only)
(If images were recorded on a memory card, insert the memory card.)
- Press the **MODE** button. ➔page 22
 - Switches to Movie Play mode (📺).
The recorded movie images are displayed in thumbnail index view.
- Press the **MENU** button.
 - Press the **Control** button (< / >) to select "**Play Option**".
- Press the **Control** button (^ / v) to select an option, and then press the **OK** button.

item	contents
"Play All"	Plays back from the selected image to the last image.
"Play One"	The selected movie image will be played.
"Repeat All"	All movie images will be played repeatedly.
"Repeat One"	The selected movie image will be played repeatedly.

- Press the **MENU** button to exit the menu.
 - During playback, the selected item is applied.





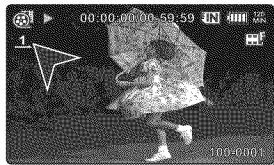
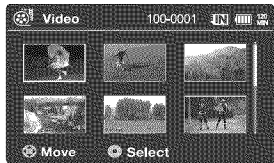
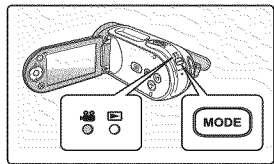

- While the menu or thumbnail image screen is displayed, pressing the **Recording start/stop** button will move to the Movie Record mode.
- In general, use of functions both in thumbnail display and full image display employs the same method, while their detailed options appear to be different.





playback options

DELETING MOVIE IMAGES

- You can delete saved movie images.
- Slide the **POWER** switch downward to turn on the memory camcorder.
 - Set the appropriate storage media.
(SC-MX20C/MX20CH/MX20E/MX20EL/MX20ER only)
(If images were recorded on a memory card, insert the memory card.)
 - Press the **MODE** button. ➔page 22
 - Switches to Movie Play mode ().
 - Select the desired movie images, using the **Control** button.
 - Press the **MENU** button.
 - Press the **Control** button ( / ) to select "**Delete**".
 - Select an option by pressing the **Control** button ( / ) and then press the **OK** button.

item	contents
"This File"	Deletes the selected movie image. (This function is available only in the full image display mode)
"Select Files"	Deletes individual selected movie images. <ul style="list-style-type: none">To delete individual movie images, select desired movie images to delete by pressing the OK button. Press the MENU button to delete.The indicator () is displayed on the selected movie images.Pressing the OK button toggles between selecting the item for deletion or not.
"All Files"	Deletes all movie images.

- The pop-up selection menu will appear depending on the selected menu item.
In this case, select the desired item with the **Control** buttons ( / ) and the **OK** button.
 - Accordingly the deleted images also disappear from the thumbnail images screen.



- In general, use of functions both in thumbnail display and full image display employs the same method, while their detailed options appear to be different.
- Once deleted, an image can not be restored.
- Protected files will not be deleted.
- If the write protection tab on the memory card is set to lock, you cannot delete.
- To protect important images from accidental deletion, activate the image protection. ➔page 71
- Note that removing the battery pack or disconnecting AC power adaptor while you delete files may damage the storage media.

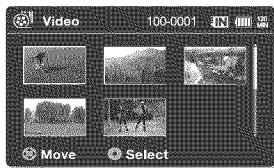
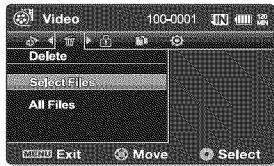
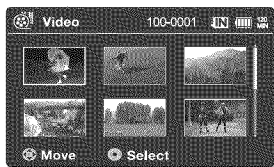
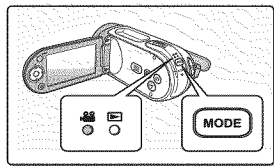

PROTECTING MOVIE IMAGES

- You can protect saved important movie images from accidental deletion.
- Protected images will not be deleted unless you release the protection or format the memory.

- Slide the **POWER** switch downward to turn on the memory camcorder.
 - Set the appropriate storage media.
(SC-MX20C/MX20CH/MX20E/MX20EL/MX20ER only)
(If images were recorded on a memory card, insert the memory card.)
- Press the **MODE** button. ➔page 22
 - Switches to Movie Play mode (▶).
 - Select the desired movie images, using the **Control** button.
- Press the **MENU** button.
 - Menu screen appears.
- Press the **Control** button (◀/▶) to select "**Protect**".
- Select an option by pressing the **Control** button (▲/▼) and then press the **OK** button.

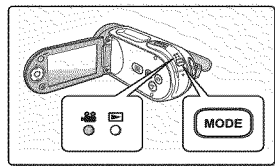

item	contents
"On"	Protects the selected movie image from deletion. (This function is available only in the full image display mode)
"Select Files"	Protects selected movie images from deletion - To protect individual movie images, select desired movie images by pressing the OK button. Press the MENU button to confirm. - The indicator (🔒) is displayed on the selected movie images. - Pressing the OK button toggles the selection and release.
"All On"	Protects all movie images.
"All Off"	Cancels the protection for all movie images.

- The pop-up selection menu will appear depending on the selected menu item. In this case, select the desired item with the **Control** buttons (◀/▶) and the **OK** button.





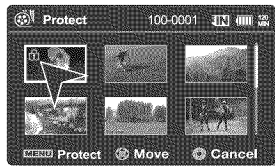
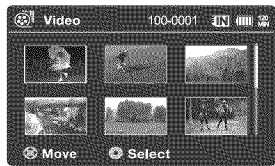

- In general, use of functions both in thumbnail display and full image display employs the same method, while their detailed options appear to be different.
- Protected movie images will show the indicator (🔒) when they are displayed.
- If the write protection tab on the memory card is set to lock, you cannot set image protection.





playback options

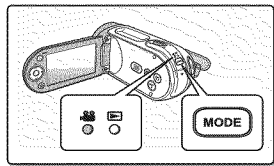

COPYING MOVIE IMAGES (SC-MX20C/MX20CH/MX20E/MX20EL/MX20ER ONLY)

- Movie images are copied to the destination storage while leaving original movie images in the source storage.
- It copies from the currently-used memory to another. For example, if the built-in memory was used, it copies to a memory card.

1. Slide the **POWER** switch downward to turn on the memory camcorder.
 - Set the appropriate storage media. (Insert a memory card.)
2. Press the **MODE** button. ➡ page 22
 - Switches to Movie Play mode ().
 - Select the desired movie images, using the **Control** button.
3. Press the **MENU** button.
 - Menu screen appears.
4. Press the **Control** button ( / ) to select "Copy".
5. Select an option by pressing the **Control** button ( / ) and then press the **OK** button.





item	contents
"This File"	Copies the selected movie images. (This function is available only in the full image display mode)
"Select Files"	Copies the individual movie images. <ul style="list-style-type: none">- To copy individual movie images, select desired movie images by pressing the OK button.- The indicator () is displayed on the selected movie images. Press the MENU button to confirm.- Pressing the OK button toggles selecting the images for copying or not.
"All Files"	Copies all the movie images.

6. The pop-up selection menu will appear depending on the selected menu item.
In this case, select the desired item with the **Control** buttons ( / ) and the **OK** button.



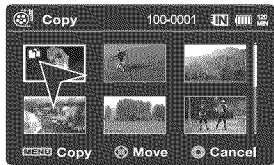
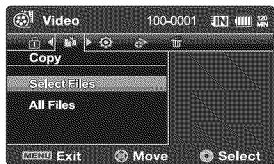
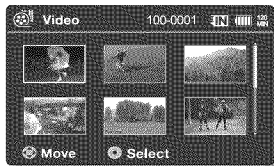

- In general, use of functions both in thumbnail display and full image display employs the same method, while their detailed options appear to be different.
- If a memory card is not inserted, you can not perform the "Copy" function.



- 
 • If available free space on the storage is insufficient, copying may not be possible. Delete unnecessary images. ➡page 70
- Copied movie images have no protection even if the original is set to be protected.
- Copying may take a while depending on the number of files and file size.
- Copying may not operate if the battery charge is insufficient. If available, use AC adaptor while copying to prevent power disconnection.
- Note that removing the battery pack or disconnecting AC power adaptor while you copy files may damage the storage media.
- Follow the same instruction to copy video clips from memory card to built-in memory. Before using this function, select the storage media that has desired video files to be copied.

FILE INFORMATION

- You can see the image information for all images.
- Slide the **POWER** switch downward to turn on the memory camcorder.
 - Set the appropriate storage media.
(SC-MX20C/MX20CH/MX20E/MX20EL/MX20ER only)
 - Press the **MODE** button. ➡page 22
 - Switches to Movie Play mode ().
 - Select the desired movie images, using the **Control** button.
 - Press the **OK** button.
 - The selected movie image is played according to Play Option setting.
 - Press the **MENU** button.
 - Press the **Control** button ( / ) to select "**File Info**".
 - Press the **OK** button.
 - Press the **MENU** button again after confirming.
 - The information of the selected file is displayed as shown below.
 - Date
 - Duration
 - Size
 - Resolution



This function is available only in the full image display mode.

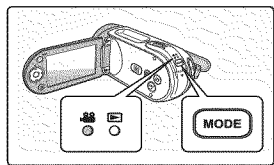

settings options

CHANGING THE MENU SETTINGS IN "SETTINGS"

You can change the menu settings to customize your memory camcorder.
Access the desired menu screen by following the steps below and change the various settings.

1. Slide **POWER** switch downward to turn the memory camcorder on.
2. Press **MENU** button.
 - The menu screen appears.
3. Press the **Control** button (**</>**) to select "**Settings**".
 - The menus in "**Settings**" mode will appear.
4. Select the desired sub menu and menu item with the **Control** buttons (**^/v**) and the **OK** button.
 - To return to the normal screen, press **MENU** button.
 - Depending on the mode selected, not all items will be selectable to be changed. (If there is no storage media inserted, it can not be selected and will be dimmed on the menu: "**Storage**", "**Storage Info**", "**Format**", etc.)

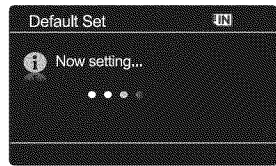
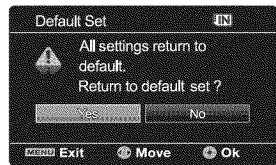
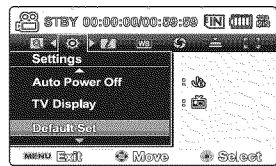

Button Tips

- a. **MENU** button : Use it to enter or exit the menu.
- b. **Control** button (**^/v/</>**) : Use it to move up/down/left/right
- c. **OK** button : Use it to select or confirm the menu.



The pop-up selection menu will appear depending on the selected menu item. In this case, select the desired item with the **Control** buttons (**</>**) and the **OK** button.

MENU ITEMS

- You can setup the date/time, OSD language and display settings of the memory camcorder.

Items	Default values	Page
Storage (SC-MX20C/MX20CH/MX20E/ MX20EL/MX20ER only)	Memory	76
Storage Info	-	76
Format	-	77
File No.	Series	77
Time Zone	Home	78
Date/Time Set	01/01/2008 12:00 AM	80
Date Format	MM/DD/YY	80
Time Format	12Hr	80
Date/Time	Off	80
LCD Brightness	0	81
LCD Color	-	81
Beep Sound	On	81
Auto Power Off	5 Min	82
TV Display	On	82
Default Set	-	82
Version	-	83
Menu Color	Blue	83
Transparency	0%	83
Language	English	83
Demo	Off	83





- These Items and Default values may be changed without notice.
- There are some functions you cannot activate simultaneously in the menu. You cannot select the grey menu items.

settings options

USING THE SETTINGS MENU ITEMS

Storage

You can record movie files on the built-in memory or a memory card, so you should select the desired storage media before starting recording or playback.

settings	contents	on-screen display
"Memory"	Select the built-in memory for storage medium. So you can record or play back movie file on the built-in memory. (SC-MX20C/MX20CH/MX20E/MX20EL/MX20ER only)	
"Card"	Select a memory card for storage medium. So you can record or play back movie file on memory card.	



If there is no storage media inserted, it can not be selected and will be dimmed in the menu.

Storage Info

It shows you the storage information. You can view the storage media, used memory space and available memory space.

settings	contents	on-screen display
"Memory"	It shows you the memory information of built-in storage media. (SC-MX20C/MX20CH/MX20E/MX20EL/MX20ER only)	None
"Card"	It shows you the memory information of the inserted memory card.	None



If there is no storage media inserted, it can not be selected and will be dimmed on the menu. On models SC-MX20/MX20B/MX20H/MX20L/MX20R, memory card information appears by selecting "OK".

Format

The format function completely deletes all files and options on the storage media, including protected files. You can format (initialize) recording data in the storage media. You have to format the pre-used storage media or newly purchased memory cards with this memory camcorder before using them. This enables stable speeds and operation when accessing the recording medium.

Be aware that all files and data including protected files will be erased.

settings	contents	on-screen display
"Memory"	Formats the built-in storage media. (SC-MX20C/MX20CH/MX20E/MX20EL/MX20ER only)	None
"Card"	Formats the memory card.	None



- Do not remove the recording medium or perform any other operation (such as turning off the power) during formatting. Also, be sure to use the provided AC power adaptor, as the recording medium may be corrupted if the battery loses its charge during formatting. If the recording medium becomes corrupted, format it again.
- A memory card with the protection tab set to lock will not be formatted. ➔page 39
- If there is no storage media inserted, it can not be selected and will be dimmed on the menu.
- On models SC-MX20/MX20B/MX20H/MX20L/MX20R, formatting is executed by selecting "OK".



WARNING

Do not format the recording medium on the PC or a different device.

Make sure to format the recording medium on the memory camcorder.

File No.

File numbers are assigned to recorded files in the order they were recorded.

settings	contents	on-screen display
"Series"	Assigns file numbers in sequence even if the memory card is replaced with another one or after formatting or deleting all files. The file number is reset when a new folder is created.	
"Reset"	Resets the file number to 0001 even after formatting, deleting all files or inserting a new memory card.	





When you set "File No." to "Series", each file is assigned with a different number so as to avoid duplicating file names. It is convenient when you want to manage your files on a PC.

settings options

Time Zone

You can easily set the clock to the local time when using your memory camcorder while traveling.

settings	contents	on-screen display
"Home"	The clock will be used according to your setting on the Date/Time Set menu. Select it when using this memory camcorder for the first time or when returning the clock to your hometown date/time setting.	
"Visit"	When you visit a different time zone, it allows you to use the local time without changing your hometown time setting. The clock will be adjusted in accordance with the time difference between the two locations.	

Setting the clock to the local time ("Visit")

You can easily set the clock to the local time zone when traveling.

1. Press the **Control** button (\wedge / \vee) to select the **"Time Zone"** in Settings mode, and then press the **OK** button.
 - Time Zone screen will be displayed.
2. Select **"Visit"** with the **Control** button (\wedge / \vee), and then select your local area using the **Control** button (\leftarrow / \rightarrow).
 - You can check the time difference between **"Home"** and **"Visit"**.
3. Press the **OK** button to confirm.
 - The clock is set to the time zone of the place you are visiting.
 - When **"Date/Time" : "On"** is set, the icon () will be displayed next to the date and time display. ➔page 80

 You can set the date and time in **"Date/Time set"** from the **"Settings"** menu.
➔page 34

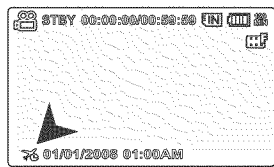

Cities used to set the time zone

Cities	Cities
London, Lisbon	Adelaide
Rome, Paris, Berlin, Stockholm, Madrid, Frankfurt	Guam, Sydney, Brisbane
Athens, Helsinki, Cairo, Ankara	Solomon Islands
Moskva, Riyadh	Wellington, Fiji
Teheran	Samoa, Midway
Abu Dhabi, Muscat	Honolulu, Hawaii, Tahiti
Kabul	Alaska
Tashkent, Karachi	LA, San Francisco, Vancouver, Seattle
Calcutta, New Delhi	Denver, Phoenix, Salt Lake City
Almaty, Kathmandu	Chicago, Dallas, Houston, Mexico City
Dacca	New York, Miami, Washington D.C., Montreal Atlanta
Yangon	Caracas, Santiago
Bangkok	Buenos Aires, Brasilia, Sao Paulo
Hong Kong, Beijing, Taipei, Singapore, Manila	Fernando de Noronha
Seoul, Tokyo, Pyongyang	Azores, Cape Verde

settings options

Date/Time Set

Set the current date and time so that the date and time are recorded correctly. ➔page 34

Date Format

You can select the date format to display.

settings	contents	on-screen display
"YY/MM/DD"	The date is displayed in the order of year / month / date.	-
"DD/MM/YY"	The date is displayed in the order of date / month / year.	-
"MM/DD/YY"	The date is displayed in the order of month / date / year.	-

Time Format

You can select the time format to display.

settings	contents	on-screen display
"12 Hr"	The time is displayed as 12 hour units.	-
"24 Hr"	The time is displayed as 24 hour units.	-

Date/Time

You can set the date and time to be displayed on the LCD monitor.

- Before you can use the **"Date/Time"** function, you must set the **"Date/Time Set"**. ➔page 34

settings	contents	on-screen display
"Off"	The date and time are not displayed.	None
"Date"	The date is displayed.	01/01/ 2008
"Time"	The time is displayed.	12:00 AM
"Date & Time"	The date and time are displayed.	01/01/ 2008 12:00 AM



- The date/time will read **"01/01/ 2008 12:00 AM"** in the following conditions:
 - The movie recording was made before setting the date/time in the memory camcorder.
 - The built-in rechargeable battery becomes weak or dead.
- This function depends on **"Date Format"** setting.

LCD Brightness

- You can adjust the brightness of the LCD screen to compensate for ambient lighting conditions.
- Press the **Control** button (◀) will brighten the screen whereas press the the **Control** button (▶) will darken the screen.



- A brighter LCD screen setting consumes more battery power.
- If you adjust the LCD brightness when the ambient lighting is too bright, it is hard to see the LCD screen indoors.
 - LCD Brightness does not affect the brightness of images to be stored.
 - You can adjust the LCD Brightness from -15 to 15.

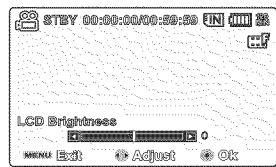

LCD Color

- You can change the color impression of the screen with a variety of color options by adjusting the color rate of red and blue.
- When you set the red and blue color range, the higher the setting, the brighter the LCD monitor will be.
- You can adjust the LCD color (red/blue) from -15 to 15, using the **Control** button (◀/▶).



Setting the LCD Color does not affect recordings.

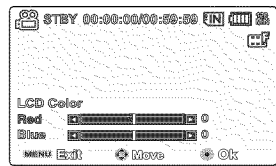

Beep Sound

You can set the beep sound to on/off.

settings	contents	on-screen display
"Off"	Disables the function	
"On"	When on, a beep will sound every time a button is pressed.	





- When beep sound is set to off, the power on/off sound is off.
- The beep sound is off when recording in movie mode.
- If you insert AV jack into the memory camcorder, beep sound will be automatically off.

settings options

Auto Power Off

To save battery power, you can set the **"Auto Power Off"** function which turns off the memory camcorder if there is no operation for 5 minutes.

settings	contents	on-screen display
"Off"	The memory camcorder does not turn off automatically.	
"5 Min"	For power saving purposes, the memory camcorder will automatically turn power off if there is no operation for 5 minutes in STBY mode or in thumbnail index view.	





Auto Power Off does not work at following situations.

- When a USB cable is connected.
- When the memory camcorder is connected to the AC adaptor.
(And it cannot be selected and will be dimmed on the menu.)

TV Display

- You can select the output path of the OSD (On Screen Display).

settings	contents	on-screen display
"Off"	The OSD appears in the LCD screen only.	
"On"	The OSD appears in the LCD screen and TV. (Connecting to a TV ➡page 93)	

Default Set

You can initialize your memory camcorder settings to the factory defaults (initial settings at the factory). Initializing the memory camcorder settings to factory defaults does not affect recorded images.



After resetting the memory camcorder, set **"Time Zone"** and **"Date/Time Set"**. ➡page 34

Version

The version information could be changed without the noticement.

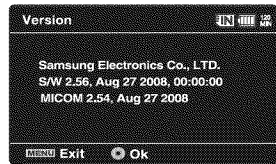

Menu Color

You can select the desired menu color to display the menu.

- "Blue" → "Pink" → "Purple" → "Orange" → "Green"

Transparency

You can select the desired transparency to display the menu.

- "0%" → "20%" → "40%" → "60%"



<Transparency 0%>



<Transparency 60%>

Language

You can select a desired language to display the menu and messages. ➡page 36

Demo

Demonstration automatically shows you the major features that are included with your memory camcorder so that you may use them more easily.

settings	contents	on-screen display
"Off"	Disables the function	
"On"	Activates demonstration mode and shows various features on the LCD screen.	



- Demonstration starts in the following cases:
 - Right after "Demo" is set to "On"
 - With "Auto Power Off" set to "Off", if there is no operation for about 5 minutes in the STBY mode.
- Demonstration stops temporarily by pressing other buttons (**MENU**, **Control** button, **Recording start/stop**, etc).
- When the Auto Power Off function is set to "5 Min", the Auto Power Off function has priority over the Demo function. If you execute Demo function, turn off the Auto Power Off function. ➡page 82
- Press and hold **MENU** button for 5 seconds in STBY mode to run the Demo function immediately.

connecting to a PC

- ✦ This chapter explains how to connect a PC using the USB cable for various actions.
 - When connecting a USB cable to a PC, refer to the software installation instructions and PC specifications below.

TRANSFERRING A RECORDED FILE THROUGH A USB CONNECTION

- The camcorder supports both USB 1.1 and 2.0 standards. (Depends on the PC specification)
- You can transfer a recorded file on a storage media to your PC via a USB connection.

USB Connection Speed depending on the System

- High speed USB connection is supported by Microsoft (Windows) device drivers only.
- Windows 2000 - High speed USB on a system with Service Pack 4 or later installed.
- Windows XP - High speed USB on a system with Service Pack 1 or later installed.
- Windows VISTA - High speed USB on a system with Service Pack 1 or later installed.



Cyberlink MediaShow4

System Requirements

The following requirements must be satisfied to use CyberLink MediaShow4.

CPU	Intel® Pentium®4, at least 3.0 GHz/AMD recommended
OS (Operating System)	Windows Vista or XP (Windows XP Service Pack 2) * Standard installation is recommended. Operation cannot be guaranteed if the above OS has been upgraded.
RAM	512MB (1 GB and above recommended)
Resolution	800 x 600, 16-bit color or higher
USB	USB2.0 High Speed
VGA	Intel® 945GM or faster NVIDIA Geforce 6600 or higher ATI Radeon X1600 or higher - On a low performance graphics system, running the MediaShow4 may cause error or not apply some of animation effects.
Miscellaneous	Internet Explorer 5.5 or later DirectX 9.0 or later
Supported media	DVD+R/RW, DVD-R/RW For the compatible DVD/CD burners, refer to CyberLink web site: http://www.gocyberlink.com/english/products/powerproducer2_gold/comp_dvd_drives.jsp

- System requirements mentioned above are recommendations. Even on a system that satisfies the requirements operation is not ensured depending on the system.
- On a Macintosh computer, you can also transfer data by connecting the USB cable, but the provided CyberLink MediaShow4 is not Macintosh-compliant. On a Macintosh computer, you can upload recordings using the iMovie application.
- This memory camcorder can be used only as a removable storage device for the computers with Macintosh (OS version 10.3 or later) and Windows 2000.



- On a slower PC than recommended, movie playback may skip frames or operate unexpectedly.
- If your OS is Windows XP/Vista, log in as the Administrator (administrator of the PC) (or a user with the equivalent privileges) to install the software.
- Check out the storage media of the memory camcorder before connecting USB cable.
If no memory card or an unformatted memory card is inserted, the PC will not recognize your memory camcorder as a removable disk.
- If you disconnect the USB cable from the PC or the memory camcorder during the data transfer, the data transfer will stop and the data may be damaged.
- If you connect the USB cable to a PC using a USB HUB or with other devices at the same time, it may cause conflict and may not work properly. If this occurs, remove all other USB devices and try the connection again.
- Intel® Pentium III® or Pentium®4 is a trademark of the Intel Corporation.
- Windows® is a registered trademark of the Microsoft® Corporation.
- All other brands and names are property of their respective owners.
- CyberLink MediaShow4 is optimized for Intel Core 2 Duo processors and CPUs with MMX, SSE, SSE2, 3DNow!, and Intel HyperThreading technology.
- DirectX is necessary so that CyberLink MediaShow4 works properly and it is automatically installed during CyberLink MediaShow4 installation.
- We recommend using the AC power adaptor as the power supply instead of the battery pack.

connecting to a PC

INSTALLING THE CYBERLINK MEDIASHOW4

CyberLink MediaShow4 is a software for easy of editing MPEG, AVI, and other video files, still images, and other contents for creating a movie. This software has an interface that allows editing in either timeline or storyboard mode, maintains superior image quality, uses SVRT (Smart Video Rendering Technology) for high-speed rendering, and has a host of other advanced video editing features. This manual only refers to software installation and PC connection. For more details on software, refer to the "Online help/Readme" on the CyberLink MediaShow4 CD.

Before you begin:

Quit any other software you are using.

(Check that there are no other application icons on the status bar.)

1. Load the provided CyberLink MediaShow4 CD-ROM into the PC.
 - The setup screen appears in several seconds.
If the setup screen does not appear, double click the CD-ROM icon in the "My Computer" window.
 - Click "Install Now."
2. Select the desired language and click "OK"
3. "Installing CyberLink MediaShow 4.0..." screen appears.
 - Click "Next"
4. "License Agreement" screen appears.
 - Click "Yes"

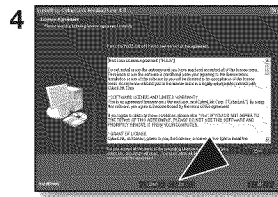
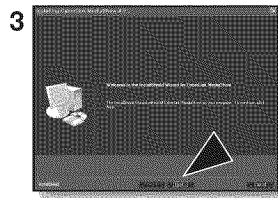

5. "Customer Information" screen appears.

- Click "Next."

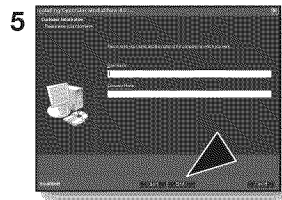

6. "Choose Destination Location" screen appears.

- Choose the destination location on your PC where you want to install.
- Click "Next."

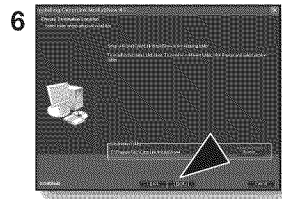

7. "Setup Complete" appears.

- Click "Finish."
- The "CyberLink MediaShow4" icon is created on the desktop.

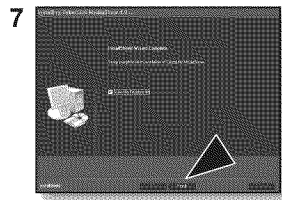

- If you perform installation of software that is already installed, uninstallation will start. In this case, perform the installation again after uninstallation is finished.
- This manual only refers to software installation and PC connection.

For more details on software, refer to the "Online help/Read me" on the CyberLink MediaShow4 CD.

connecting to a PC

CONNECTING THE USB CABLE

Connect the USB cable to copy movie images in a recording medium to the PC and vice versa. When the USB cable is connected in Record / Play mode, the product will switch to USB mode immediately.

1. Connect the memory camcorder to the PC with a USB cable.



- Don't apply excessive force when inserting or extracting a USB jack.
- Insert a USB jack after checking the direction of its insertion is correct.
- It is recommended to use the AC adaptor as the power supply instead of the battery pack.
- When the USB cable is connected, do not turn the camcorder on and off as it may cause PC malfunctions.

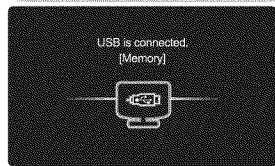
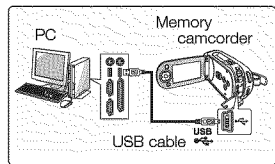

Disconnecting the USB cable

Before loading or unloading recording mediums or turning off the PC, first disconnect the USB cable and turn off the memory camcorder. After completing the data transmission, you must disconnect the cable in the following way:

1. Click the "Unplug or eject hardware" icon on the task tray.
2. Select "USB Mass Storage Device" or "USB Disk," and then click "Stop."
3. Click "OK."
4. Disconnect the USB cable from the memory camcorder and PC.



- If you disconnect the USB cable from the PC or the memory camcorder while transferring, the data transmission will stop and the data may be damaged.
- If you connect the USB cable to a PC via a USB HUB or simultaneously connect the USB cable along with other USB devices, the memory camcorder may not work properly. If this occurs, remove all USB devices from the PC and reconnect the memory camcorder.



VIEWING THE CONTENTS OF STORAGE MEDIA

- Slide the **POWER** switch downward to turn on the memory camcorder.
 - Set the appropriate storage media. ➔page 37
(SC-MX20C/MX20CH/MX20E/MX20EL/MX20ER only)
(If you want to view contents on a memory card, insert the memory card.)
- Connect the memory camcorder to the PC with a USB cable. ➔page 88
 - Check out the USB connection on the LCD monitor.

When using Windows® XP, Vista version :

- The "Removable Disk" window appears on the PC's screen after a moment.
- Select "Open folders to view files using Windows Explorer" and click "OK."

When using Windows® 2000:

- Double-click the "My Computer" icon on the desktop.

The "Removable Disk" icon which represents the storage media in the memory camcorder appears in the "My Computer" window.
 - Doubleclick the "Removable Disk" icon.
- The folders in the storage media appear.
 - Different file types are stored in different folders.



- If the "Removable Disk" window does not appear, confirm the connection (page 88) or perform steps 1 and 2.
- When the removable disk does not appear automatically, open the removable disk folder of My Computer.
- Your PC can recognize only one storage media(built-in memory or card) from the camcorder at a time. If you cannot find the removable disk of your choice, change the storage setting (built-in memory or card) of your camcorder. ➔page 37
(SC-MX20C/MX20CH/MX20E/MX20EL/MX20ER only)

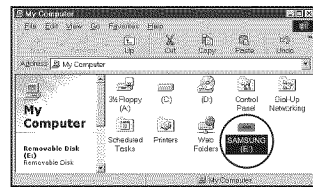
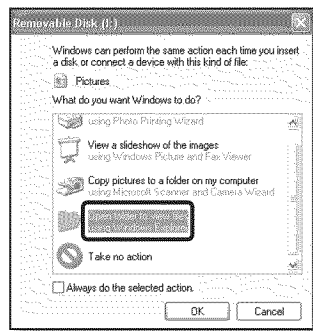

Movie images

connecting to a PC

Structure of folders and files on the storage media

- The folder and file structure for built-in memory or memory card is as follows.
- Don't arbitrarily change or remove the folder or file name. It may not be playable.

Movie Images (H.264)

The SD-quality movie images are named as "SDV_####.MP4" and Web file movie images are named as "WEB_####.MP4".

The file number automatically increases when a new movie image file is created.

Up to 9999 files are created in one folder. A new folder is created when more than 9999th files are created.

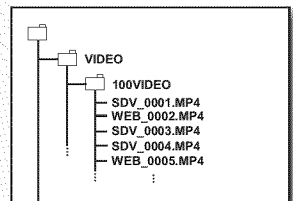

Image format

Movie Images

- Movie images are compressed in H.264 format. The file extension is **".MP4."**
- The image size is 720x480(60i) or 640x480(WEB). ➡page 61



- When the 9999th file is created in the 999th folder (i.e. SDV_9999.MP4 is created in the 999 VIDEO folder), a new folder cannot be created anymore. Backup your files to a PC and format the storage media, and then reset file numbering from the menu.
- We don't recommend you to modify the name of a file/folder stored in the storage media using a PC. If you modify it, this memory camcorder may not recognize modified files.
- You can use your memory camcorder as a mass storage device. So you can store general data in the storage media of the memory camcorder.

TRANSFERRING FILES FROM THE MEMORY CAMCORDER TO YOUR PC

You can copy movie images to your PC and view them.

1. Execute the procedure in "VIEWING THE CONTENTS OF STORAGE MEDIA." ➔page 89
 - The folders in the storage media appear.
2. Create a new folder, enter the folder name, and then double-click it.
3. Select the folder to copy, and then drag and drop it into the destination folder.
 - The folder is copied from the storage media (memory card (all models) or built-in memory (SC-MX20C/MX20CH/MX20E/MX20EL/MX20ER) to the PC.
 - Do not move or rename the camcorder's folders and files after transferring them. If you change the basic name of folders and files, your memory camcorder will no longer recognize them and they will not be played.
 - If your camcorder can not recognize the built-in memory or your memory card, you should format it using the camcorder.

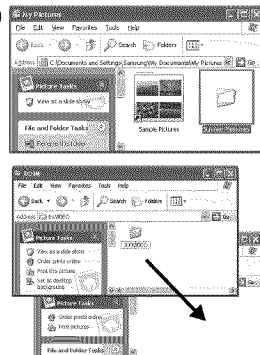

Playing Back Files on the PC

Use the provided software (CyberLink MediaShow4) to play back movie images on your PC.

The movie images recorded on your memory camcorder may not be played back in other software.



- On a Macintosh computer, you can also transfer data by connecting the USB cable, but the provided CyberLink MediaShow4 software is not Macintosh-compliant. On a Macintosh computer, you can upload recordings using the iMovie application.
- This memory camcorder can be used only as a removable storage device for the computers with Macintosh (OS version 10.3 or later) and Windows 2000.

connecting to a PC

UPLOADING MOVIE IMAGES IN THE MEMORY CAMCORDER TO YouTube

You can connect your camcorder to a PC and directly upload movie images to YouTube with the CyberLink Media Show4 software. If you are a Mac user, you can upload your content to YouTube using iMovie.

1. Connect the memory camcorder to the PC with a USB cable. ➔page 88
2. Install CyberLink MediaShow4 (provided) and, when done, enter Video mode. ➔pages 86,87
 - Running the CyberLink MediaShow4 for the first time may display registration screen.
3. Click Import in the main screen.
 - Open a folder from the left removable disk and select files of your choice.
4. Then, click **Import all** or **Import selected** to start importing movie image files.
 - All or selected files are uploaded according to your choice.
 - Click Back to return home.
5. Click the YouTube shortcut icon in the **Share** tab.
 - You will see the login or subscription dialog box.
 - First, log into the YouTube site and click Upload on the top right corner of the main menu.
6. The Video Upload window appears where you can follow the screen instructions to upload movie images in sequence.

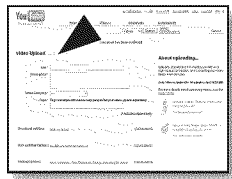
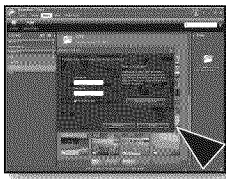
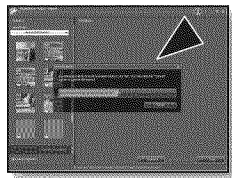
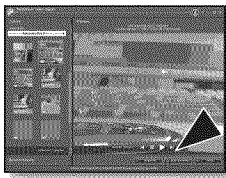

- YouTube is a video sharing website where users can upload, view and share video clips. The San Bruno-based service uses Adobe Flash technology to display a wide variety of user-generated video content, including movie clips, TV clips and music videos, as well as amateur content such as video blogging and short original videos.
- <http://www.youtube.com/>

connecting to other devices

You can view the recorded movie on a large screen by connecting the memory camcorder to a TV.

CONNECTING TO A TV

- To playback your recordings, the television must be NTSC compatible. ➔ page 99
- We recommend that you use the AC power adaptor as the power source for the memory camcorder.

Use the provided AV cable to connect the memory camcorder to a TV as follows:

1. Connect the end of the AV cable with the single plug to the AV jack of the memory camcorder.
2. Connect the other end with video (yellow) and left (white) / right (red) audio cables to the TV.

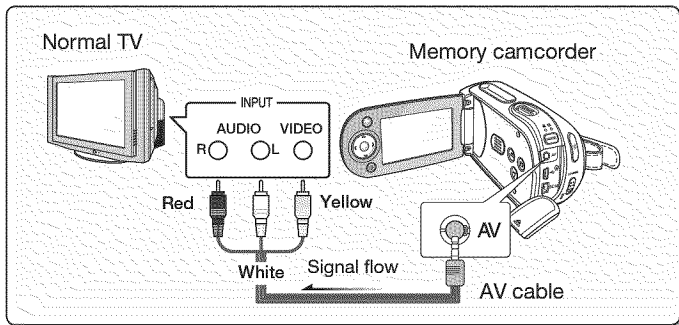

- For more information about the connection, refer to your TV's user manual.
- Before connecting, make sure that the volume on TV is turned down: forgetting this may cause howling from the TV speakers.
- Carefully connect the input and output cables to the corresponding connections on the device the memory camcorder is being used with.

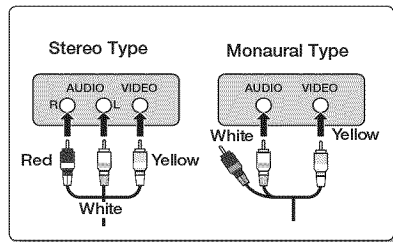

VIEWING ON TV SCREEN

- Turn on the TV and set the input selector to the Input connection the memory camcorder is connected to.
 - This is often referred to as "line". Refer to the TV instruction manual for how to switch the TV input.
- Turn the memory camcorder on.
 - Slide the **POWER** switch downward and press the **MODE** button to set Play (). ➔ page 22
 - The image that the memory camcorder is viewing will appear on the TV screen.
 - You can also monitor the image on the LCD screen of the memory camcorder.
- Perform playback.
 - You can perform playback, recording or setting the menu while viewing on TV screen.

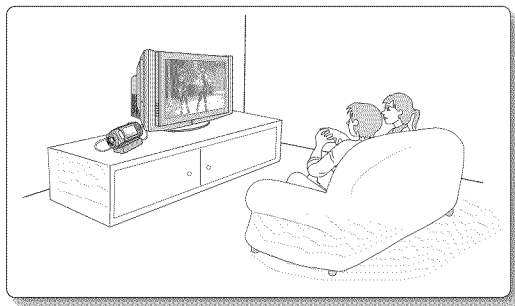









- Information that the memory camcorder is recording will appear on the TV screen: You can also display only part of information or switch off the display. Refer to "TURNING THE SCREEN INDICATORS ON/OFF ()" on page 27, and press the  / **CHECK** button to switch the display status.
- When "**TV Display**" is set to "**Off**", OSD (On-Screen-Display) does not appear on the TV screen. ➔ page 82
- Howling may occur when the memory camcorder is too close to the other devices or the volume is high. Keep the memory camcorder a reasonable distance away from the other connected devices.
- When the AV cable is connected to the memory camcorder, the built-in speaker will automatically turn off and you can not adjust the volume bar.

Image display depending on LCD and TV screen ratio

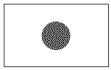
 Icon  Subject

	Record	LCD	TV	
			16:9	4:3
16:9				
4:3				

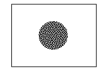
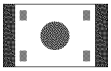
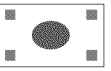
 Refer to page 61 for "**16:9 Wide**" setting.

connecting to other devices

RECORDING (DUBBING) IMAGES ON A VCR OR DVD/HDD RECORDER

You can record (dub) images played back on this memory camcorder onto other video devices, such as VCRs or DVD/HDD recorders. Use the AV cable (provided) to connect the memory camcorder to another video device as shown in the following figure:

1. Press the **MODE** button to set Player (▶). ➔page 22
2. Choose the recorded (dubbed) movie on the thumbnail view and then press the **OK** button.
3. Press the record button on the connected device.
 - The memory camcorder will start playback and the recording device will record (dub) it.

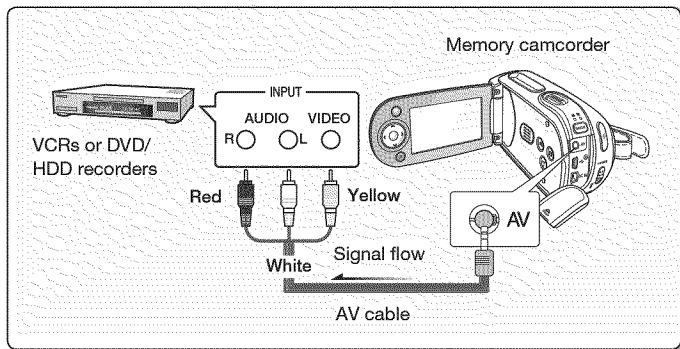

- Be sure to use the AC adaptor to power the memory camcorder from household AC outlet to prevent battery power from shutting off during recording on another video device.
- To prevent recording OSD (information) displayed along with AV signal, set the "**TV Display**" to "**Off**" in Menu Settings. ➔page 82

maintenance & additional information

MAINTENANCE

Your memory camcorder is a product of superior design and craftsmanship and should be treated with care.

The suggestions below will help you fulfill any warranty obligations and allow you to enjoy this product for many years.

- ⊕ For safekeeping of the memory camcorder, turn off the memory camcorder.
 - Remove the battery pack and AC power adaptor. ➔page 14
 - Remove the memory card. ➔page 38

Cautions on Storing

- **Do not leave the memory camcorder in a place where the temperature is very high for a long period of time:**

The temperature inside a closed vehicle or trunk can become very high in a hot season. If you leave the memory camcorder in such a place, it could malfunction or the case could be damaged. Do not expose the memory camcorder to direct sunlight or place it near a heater.

- **Do not store the memory camcorder in a place where the humidity is high or in a dusty place:**
Dust entering the memory camcorder could cause malfunctions. If humidity is high, the lens could become moldy, and the memory camcorder could become inoperative. It is recommended that you put the memory camcorder in a box together with a desiccant when storing it in a closet, etc.
- **Do not store the memory camcorder in a place subject to strong magnetism or intense vibrations:**
This could cause malfunctions.
- **Detach the battery pack from the memory camcorder and store it in a cool place:**
Leaving the battery pack attached or storing it at high temperature could shorten its life.

Cleaning the memory camcorder

- ⊕ **Before cleaning, turn off the memory camcorder and remove the battery pack and AC power adaptor.**
- **To clean the exterior**
 - Wipe gently with a soft dry cloth. Do not apply excessive force when cleaning, gently rub the surface.
 - Do not use benzene or thinner to clean the camcorder. The coating of exterior could peel off or the case could deteriorate.
- **To clean the LCD monitor**
Wipe gently with a soft dry cloth. Be careful not to damage the monitor.

- **To clean the lens**

Use an optional air blower to blow out dirt and other small object. Do not wipe the lens with cloth or your fingers. If necessary, wipe gently with lens cleaning paper.

- Mold may form if the lens is left dirty.
- If the lens looks dimmer, turn off the memory camcorder and leave it for about 1 hour.

ADDITIONAL INFORMATION

Storage media

- **Be sure to follow the guidelines below to prevent corruption or damage to your recorded data.**
 - Do not bend or drop the storage media, or subject it to strong pressure, jolts or vibrations.
 - Do not splash the storage media with water.
 - Do not use, replace, or store the storage media in locations that are exposed to strong static electricity or electrical noise.
 - Do not turn off the camcorder power or remove the battery or AC power adaptor during recording, playback, or when otherwise accessing the storage media.
 - Do not bring the storage media near objects that have a strong magnetic field or that emit strong electromagnetic waves.
 - Do not store the storage media in locations with high temperature or high humidity.
 - Do not touch the metal parts.
- **Copy the recorded files to your PC. Samsung shall not be responsible for any lost data. (It is recommended that you copy the data from your PC to other media for storage.)**
- **A malfunction may cause the storage media to fail to operate properly. Samsung will not provide any compensation for any lost contents.**
- **Refer to pages 37-43 for details.**

LCD screen

- **To prevent damage to the LCD screen**
 - Do not push it too hard or knock it on anything.
 - Do not place the camcorder with LCD screen on the bottom.
- **To prolong service life, avoid rubbing it with a coarse cloth.**
- **Be aware of the following phenomena for LCD screen use. They are not malfunctions.**
 - While using the camcorder, the surface around the LCD screen may heat up.
 - If you leave power on for a long time, the surface around the LCD screen becomes hot.

maintenance & additional information

Battery packs

The supplied battery pack is a lithium-ion battery. Before using the supplied battery pack or an optional battery pack, be sure to read the following cautions:

- **To avoid hazards**

- Do not burn.
- Do not short-circuit the terminals. When transporting, carry the battery in a plastic bag.
- Do not modify or disassemble.
- Do not expose the battery to temperatures exceeding 60°C (140°F), as this may cause the battery to overheat, explode or catch fire.

- **To prevent damage and prolong service life**

- Do not subject to unnecessary shock.
- Charge in an environment where temperatures are within the tolerances shown below.
This is chemical reaction - cooler temperatures impede chemical reaction, while warmer temperatures can prevent complete charging.
- Store in a cool, dry place. Extended exposure to high temperatures will increase natural discharge and shorten service life.
- Fully charge the battery pack at least every 6 months when storing the battery pack over a long period of time.
- Remove the battery pack and charger from the camcorder when not in use, as the camcorder will use current even when switched off.



- It is recommended that only genuine **Samsung** batteries are used in this camcorder. Using generic non-**Samsung** batteries can cause damage to the internal charging circuitry.
- It is normal for the battery pack to be warm after charging, or after use.

Temperature range specifications

- Charging: 10°C to 35°C (50°F to 95°F)
 - Operation: 0°C to 40°C (32°F to 104°F)
 - Storage: -20°C to 60°C (-4°F to 132°F)
- The lower the temperature, the longer recharging takes.
 - **Refer to pages 14-20 for detail.**

USING YOUR MEMORY CAMCORDER ABROAD

- Each country or region has its own electric and color systems.
- Before using your memory camcorder abroad, check the following items.

Power sources

The provided AC adaptor features automatic voltage selection in the AC range from 100 V to 240 V. You can use your camcorder in any countries/regions using the AC power adaptor supplied with your camcorder within the AC 100 V to 240 V, 50/60 Hz range. Use a commercially available AC plug adaptor, if necessary, depending on the design of the wall outlet.

On TV color systems

Your camcorder is an **NTSC**-system-based camcorder. If you want to view your recordings on a TV or to copy it to an external device, it must be an **NTSC**-system-based TV or an external device having the appropriate Audio/Video jacks. Otherwise, you may need to use a separate video format transcoder (NTSC-PAL format converter).

NTSC-compatible countries/regions

Bahamas, Canada, Central America, Japan, Korea, Mexico, Philippines, Taiwan, United States of America, etc.

PAL-compatible countries/regions

Australia, Austria, Belgium, Bulgaria, China, CIS, Czech Republic, Denmark, Egypt, Finland, France, Germany, Greece, Great Britain, Netherlands, Hong Kong, Hungary, India, Iran, Iraq, Kuwait, Libya, Malaysia, Mauritius, Norway, Romania, Saudi Arabia, Singapore, Slovak Republic, Spain, Sweden, Switzerland, Syria, Thailand, Tunisia, etc.



You can make recordings with your memory camcorder and view pictures on the LCD screen from anywhere in the world.



troubleshooting

TROUBLESHOOTING



- ✦ Before contacting a Samsung authorized service center, perform the following simple checks. They may save you the time and expense of an unnecessary call.





Warning indicators and messages

Power source

Message	Icon	Informs that...	Action
Low Battery		The battery pack is almost discharged.	Change to a charged one or use AC adaptor. Charge the battery pack.
Auto Power Off		If no button is pressed for about 5 minutes, the memory camcorder is automatically turned off.	To disable this option, change the setting of "Auto Power Off" to "Off" ➔page 82

Storage media

Message	Icon	Informs that...	Action
Memory Full		There is not enough space to record on built-in memory.	<ul style="list-style-type: none">• Delete unnecessary files on the built-in memory. (SC-MX20C/MX20CH/MX20E/MX20EL/MX20ER) Use a memory card.• Back-up files to your PC or another storage media and delete files.
Insert Card		There is no memory card inserted in the card slot.	Insert a memory card. (SC-MX20/MX20B/MX20H/MX20L/MX20R)
Card Full		There is not enough space to record on memory card.	<ul style="list-style-type: none">• Delete unnecessary files on the memory card. Use the built-in memory. (SC-MX20C/MX20CH/MX20E/MX20EL/MX20ER)• Back-up files to your PC or another storage media and delete files.• Change to another memory card which has enough free space.

Message	Icon	Informs that...	Action
Card Error		The memory card has some problem and can not be recognized.	Format the memory card or replace it with a new one.
Card Locked		The write protection tab on an SDHC card has been set to lock.	Release write protection tab.
Not Supported Card		The memory card is not supported in this camcorder.	Change to a memory card that we recommend.
Please format!		The memory card is not formatted.	Format the memory card using menu item.
Not formatted. Format the Card? (Format the memory?)	-	The format of the file is not supported by this memory camcorder.	<ul style="list-style-type: none"> The file format is not supported. Check the supported file. Format the memory card on the camcorder.
Low speed card. Please record a lower resolution.	-	The memory card does not have enough performance to record.	<ul style="list-style-type: none"> Record movie at a lower resolution. Change memory card to faster one. <ul style="list-style-type: none"> ➡ page 39

Recording

Message	Icon	Informs that...	Action
Check the lens cover		Lens cover is closed.	Open the lens cover.
Write Error	-	Some problems occurred while writing data to storage media.	Format storage media using menus after backing-up important files to your PC or another storage media.
Release the EASY Q	-	You can not operate some functions manually when EASY Q is activated.	Release EASY Q function.
Number of video files is full. Cannot record video.	-	Folder and file number reached to its limitation and you can not record.	Format storage media using menu item after backup important files to PC or another storage device. Set " File No. " to " Reset. "

troubleshooting

Playback

Message	Icon	Informs that...	Action
Read Error		Some problems occurred during reading data from storage media.	Format storage media using menus after back-up important files to PC or another storage device.



CAUTION

When there is moisture condensation, put aside for a while before using

- What is condensation?

Condensation happens when a memory camcorder is moved to a place where there is a significant temperature difference from the previous place. In other words, the water vapor in the air turns into dew because of the temperature difference, and it condensates like dew on the external or internal lenses of the memory camcorder and on the reflection lens.

When this happens, you temporarily may not use the record or play functions of the memory camcorder. Also, it may cause a malfunction or damage to the memory camcorder when using the device with the power on while there is condensation.

- What can I do?

Turn the power off and detach the battery pack, and leave it in a dry area for 1~2 hours before using it.

- When does the condensation occur?

When the device is relocated to a place with a higher temperature than the previous location, or when using it in a hot area suddenly, it will cause condensation.

- When recording outside in cold weather during the winter and then using it in indoors.
- When recording outside in hot weather after being indoors or inside a car where the AC was running.

Note before sending your camcorder for repair.

- If these instructions do not solve your problem, contact your nearest Samsung authorized service center.
- Depending on the problem, the camcorder's built-in memory may need to be initialized or replaced and the data will be deleted. Be sure to back up the camcorder's data on other storage media before sending your camcorder to repair. Samsung cannot guarantee any loss of your data.

- ❖ If you encounter any problem using your camcorder, check the following before asking for service repair. If these instructions do not solve your problem, contact the nearest Samsung authorized service center.

Symptoms and solutions

Power

Symptom	Explanation/Solution
The camcorder does not turn on.	<ul style="list-style-type: none"> The battery pack may not be installed on your memory camcorder. Insert a battery pack to the memory camcorder. The inserted battery pack may be discharged. Charge the battery pack or replace it with a charged one. If you use an AC power adaptor, make sure it is properly connected to the wall outlet.
The power automatically turns off.	<ul style="list-style-type: none"> Is "Auto Power Off" set to "5 Min"? If no button is pressed for about 5 minutes, the memory camcorder is automatically turned off ("Auto Power Off"). To disable this option, change the setting of "Auto Power Off" to "Off" ➔page 82 The battery pack is almost discharged. Charge the battery pack or replace it with a charged one. Use the AC Power adaptor.
Power cannot be turned off .	<ul style="list-style-type: none"> Remove the battery pack or unplug the AC power adaptor, and connect the power supply to the camcorder again before turning it on.
The battery pack is quickly discharged.	<ul style="list-style-type: none"> The temperature when using the camcorder is too low. The battery pack is not fully charged. Charge the battery pack again. The battery pack reached its lifespan and cannot be recharged. Use another battery pack.

troubleshooting

Displays

Symptom	Explanation/Solution
The Recorded Image is more narrow or fat than original Image.	<ul style="list-style-type: none">You should check the size for recording before you record. ➡page 61
Unknown image appears on the LCD screen.	<ul style="list-style-type: none">The memory camcorder is in Demo mode. If you do not want to see Demo image, change the setting of "Demo" to "Off". ➡page 83
Unknown indicator appears on the screen.	<ul style="list-style-type: none">A warning indicator or message appears on the screen. ➡pages 100~102
The after image remains on the LCD screen.	<ul style="list-style-type: none">This occurs if you disconnect the AC power adaptor or remove the battery pack before turning the power off.
The image on the LCD screen looks dark.	<ul style="list-style-type: none">Ambient is too bright. Adjust the brightness and angle of LCD.Use the LCD enhancer function.

Menu



Symptom	Explanation/Solution	
Menu items are grayed out.	<ul style="list-style-type: none"> You cannot select grayed items in the current recording/playback mode. Most of menu items cannot be selected when you set the EASY Q function. If there is no storage media inserted, it can not be selected and will be dimmed on the menu : "Storage", "Storage Info", "Format", etc. There are some functions you cannot activate simultaneously. The following list shows examples of unworkable combinations of functions and menu items. If you want to set the desired functions, do not set the following items first. 	
	<Cannot Use>	<Because of the following setting>
	<p>"C.Nite", "Digital Zoom", "Digital Effect : Mirror", "Digital Effect : Mosaic", "Digital Effect : Stepprinting"</p>	<p>"Anti-Shake (HDIS)"</p>
	<p>"Digital Zoom", "Exposure : Manual", "Shutter : Manual", "Focus : Face Detection", "Back Light", "iSCENE : Manual", "Digital Effect : Mirror", "Digital Effect : Mosaic", "Digital Effect : Stepprinting"</p>	<p>"C.Nite"</p>
	<p>"C.Nite", "Focus : Face Detection"</p>	<p>"iSCENE"</p>
	<p>"Focus : Face Detection"</p>	<p>"Digital Effect"</p>
	<p>"Focus : Face Detection", "Digital Zoom"</p>	<p>"Digital Effect : Mirror", "Digital Effect : Mosaic", "Digital Effect : Stepprinting"</p>
	<p>"Digital Effect : Mirror", "Digital Effect : Mosaic", "Digital Effect : Stepprinting"</p>	<p>"16:9 Wide"</p>
	<p>"Fader"</p>	<p>"Interval REC"</p>
	<p>"Focus : Face Detection"</p>	<p>"Exposure : Manual", "Shutter : Manual"</p>

troubleshooting

Storage Media

Symptom	Explanation/Solution
Memory card functions are not operable.	<ul style="list-style-type: none">• Insert a memory card into your camcorder properly. ➡page 38• If you use a memory card formatted on a computer, format it again directly on your camcorder. ➡page 77
Image cannot be deleted.	<ul style="list-style-type: none">• You cannot delete the images protected by other device. Release the protection of the image on the device. ➡page 71• Release the lock on the write-protect tab of the memory card (SDHC memory card, etc.), if any. ➡page 39
You cannot format the memory card.	<ul style="list-style-type: none">• Release the lock on the write-protect tab of the memory card (SDHC memory card, etc.), if any. ➡page 39• Copy any important recorded files to your PC before formatting. Samsung shall not be responsible for any loss of data. (It is recommended that you copy the data to your PC or other storage media.)
The data file name is not indicated correctly.	<ul style="list-style-type: none">• The file may be corrupted.• The file format is not supported by your camcorder.• Only the file name is displayed, if the directory structure does not comply with the international standard.
Does not charge or operate even the battery pack is inserted.	<ul style="list-style-type: none">• Check whether the battery pack is genuine. Non-genuine battery pack is not recognized properly by the memory camcorder.

Recording

Symptom	Explanation/Solution
Pressing the Recording start/stop button does not start recording.	<ul style="list-style-type: none"> • Press the MODE button to set Movie Record mode (). • There is not enough free space to record on the built-in memory or memory card. • Check if memory card is not inserted or write-protect tab is set to lock. • The internal temperature of your camcorder is unusually high. Turn off your camcorder and leave it for a while in a cool place. • Your camcorder is damp and moist inside (condensation). Turn off your camcorder and leave it for about 1 hour in a cool place.  page 96
The actual recording time is less than the estimated time.	<ul style="list-style-type: none"> • The estimated recording time may vary depending on contents and features used. • Recording a fast-moving subject increases the bit rate and consequently the amount of storage space required for the recording, which can lead to a shorter available recording time.
The recording stops automatically.	<ul style="list-style-type: none"> • There is no more free space for recording on the storage media. Back up important files on your PC and format the storage media or delete the unnecessary files. • If you make a frequent recording or deletion of files, the performance of the built-in flash memory will be deteriorated. In this case, format the built-in memory again. • If you use the memory card with low writing speed, the memory camcorder automatically stops recording the movie images and the corresponding message appears on the LCD screen.
When recording a subject illuminated by bright light, vertical lines appear.	<ul style="list-style-type: none"> • The memory camcorder is unable to record these levels of brightness.

troubleshooting

Recording

Symptom	Explanation/Solution
When the screen is exposed to the direct sunlight during recording, the screen becomes red or black for an instant.	<ul style="list-style-type: none">Do not leave the memory camcorder with the LCD screen exposed to direct sunlight.
During recording, the date/time does not display.	<ul style="list-style-type: none">"Date/Time" is set to off. Set the "Date/Time" to on. ➔page 80
The beep sound is not heard.	<ul style="list-style-type: none">Set "Beep Sound" to "On".Beep sound is temporarily off while recording movies.When the AV cable is connected to the memory camcorder, the beep sound will automatically turn off.
There is a time difference between the point where you press Recording start/stop button and the point where the recorded movie starts/stops.	<ul style="list-style-type: none">On your camcorder, there may be a slight time delay between the point when you press Recording start/stop button and the actual point where the recorded movie starts/stops. This is not an error.
The recording stops.	<ul style="list-style-type: none">The internal temperature of your camcorder is unusually high. Turn off your camcorder and leave it for a while in a cool place.Your camcorder is damp and moist inside (condensation). Turn off your camcorder and leave it for about 1 hour in a cool place. ➔page 96

Adjusting the image during recording

Symptom	Explanation/Solution
Focus does not adjust automatically.	<ul style="list-style-type: none">• Set "Focus" to "Auto". ➡page 57• The recording conditions are not suitable for auto focus. Adjust the focus manually. ➡page 57• The lens is dusty on the surface. Clear the lens and check the focus.• Recording is being made in a dark place. Light up to brighten the place.
The image appears too bright or flickering, or changes in color.	<ul style="list-style-type: none">• This occurs when recording images under a fluorescent lamp, sodium lamp, or mercury lamp. Cancel "iSCENE" to minimize this phenomena. ➡page 53
Color balance of image is not natural.	<ul style="list-style-type: none">• White balance adjustment is required. Set proper "White Balance". ➡page 54
The backlight function does not function.	<ul style="list-style-type: none">• While recording in EASY Q mode, the backlight function does not work.

troubleshooting

Playback on your memory camcorder

Symptom	Explanation/Solution
Using the playback (Play/Pause) button would not start playing.	<ul style="list-style-type: none">• Press the MODE button to set Movie Play mode. (▶)• Image files recorded using other device may not be played on your memory camcorder.• Check out the memory card compatibility. ▶page 39
The Skip or Search function does not work properly.	<ul style="list-style-type: none">• If the temperature inside the camcorder is too high, it can not function properly. Turn the camcorder off, wait for a few moments, and turn it on again.
Playback is interrupted unexpectedly.	<ul style="list-style-type: none">• Check the AC adaptor or battery pack is properly connected and stable.
You cannot hear the sound when playing movie recorded by Interval Recording.	<ul style="list-style-type: none">• The Interval recording does not support the sound input. (mute recording) ▶page 64

Playback on other devices (TV, etc.)

Symptom	Explanation/Solution
You cannot view the image or hear the sound on the connected device.	<ul style="list-style-type: none">• Connect the audio line of the AV cable to your camcorder or to the connected device (TV, DVD recorder, etc). (Red color- right, White color- left)• The AV cable is not connected properly. Make sure that the AV cable is connected to the proper jack. ▶page 93

Connecting to a computer

Symptom	Explanation/Solution
When using the movies, a computer does not recognize your camcorder.	<ul style="list-style-type: none"> • Install the provided software program. ➡pages 86, 87 • Disconnect the USB device other than the keyboard, the mouse and the camcorder from the computer. • Disconnect the cable from the computer and camcorder, restart the computer, then connect them again correctly.
Cannot play a movie file properly on a PC.	<ul style="list-style-type: none"> • A video codec is needed to play the file recorded on your memory camcorder. Install the software provided with your camcorder. ➡pages 86, 87 Please install by using the software CD that came with this camcorder. We do not guarantee compatibility for different CD versions. • Make sure you insert the connector in the correct direction, and connect the USB cable to the USB jack on your camcorder firmly. • Disconnect the cable from the computer and camcorder, restart the computer. And connect it again properly.
Cannot use the provided software, "CyberLink Media Show4", on the Macintosh computer.	<ul style="list-style-type: none"> • On a Macintosh computer, you can also transfer data by connecting the USB cable, but the provided CyberLink MediaShow4 is not Macintosh-compliant. On a Macintosh computer, you can upload recordings using the iMovie application. • This memory camcorder can be used only as a removable storage device for the computers with Macintosh (OS version 10.3 or later) and Windows 2000.
"CyberLink MediaShow4" does not function properly.	<ul style="list-style-type: none"> • Exit the "CyberLink MediaShow4" program, and restart the Windows computer.
The image or sound on your camcorder is not played on your computer properly.	<ul style="list-style-type: none"> • Movie playback or sound may stop temporarily depending on your computer. The movie or sound copied to your computer is not affected. • If your camcorder is connected to a computer that does not support Hi-speed USB (USB2.0), the images or sound may not be played back correctly. The images and sound is copied to your computer is not affected.
The playback screen is paused or distorted.	<ul style="list-style-type: none"> • Check the system requirements to play a movie. ➡page 84 • Exit other all applications running on the current computer. • If a recorded movie is played on your camcorder connected to a computer, the image may not play smoothly, depending on the transfer speed. Please copy the file to your PC, and then play it back.

troubleshooting

Connecting/Dubbing with other devices (TV, DVD recorder, etc)

Symptom	Explanation/Solution
You cannot dub correctly using the AV cable.	<ul style="list-style-type: none">The AV cable is not connected properly. Make sure that the AV cable is connected to the proper jack, i.e. to the input jack of the device used for dubbing an image from your camcorder. ➡page 93

Overall operations

Symptom	Explanation/Solution
The date and time are incorrect.	<ul style="list-style-type: none">Has the camcorder been left unused for a long period of time? The backup built-in rechargeable battery may be discharged. ➡page 35
The camcorder does not turn on, or does not operate by pressing any button.	<ul style="list-style-type: none">Remove the battery pack or unplug AC power adaptor, and connect the power supply to the camcorder again before turning it on.

specifications

**Model Name: SC-MX20/SC-MX20B/SC-MX20H/SC-MX20L/SC-MX20R
SC-MX20C/SC-MX20CH/SC-MX20E/SC-MX20EL/SC-MX20ER**

System	
Video signal	NTSC
Picture compression format	H.264/AVC Format
Audio compression format	AAC (Advanced Audio Coding)
Recording resolution	TV Super Fine (about 5.0Mbps), TV Fine (about 4.0Mbps), TV Normal (about 3.0Mbps), Web & Mobile (about 2.0Mbps)
Image device	CCD (Charge Coupled Device) (Max/Effective : 680K/460K pixels)
Lens	F1.6 to 4.3, 34x (Optical), 1200x (Digital) Electronic zoom lens
Focal Length	2.3~78.2mm
Minimum Illumination	3.0 Lux
Filter diameter	Ø30.5
LCD screen	
Size/dot number	2.7 inches wide, 112k
LCD screen method	1.6" interlaced scan, LCD panel / TFT active matrix system
Connectors	
Composite video out	1.0V (p_p), 75Ω, analog
Audio output	(-7.5dBm 47KΩ, analog, stereo)
USB output	mini USB-B type (USB2.0 High Speed)
General	
Power source	8.4V (Using AC adaptor), 7.4V (Using Lithium Ion battery pack)
Power source type	Power supply (100V~240V) 50/60Hz, Lithium Ion battery pack
Power consumption	2.0W (LCD on)
Operating temperature	0°~40°C (32°F~104°F)
Operating humidity	10% ~80%
Storage temperature	-20°C ~ 60°C (-4°F ~ 140°F)
Dimensions (W x H x D)	Approx. 2.38" x 2.36" x 4.92" (60.5mm x 60mm x 125mm)
Weight	Approx. 0.611lbs (280g) (expect for battery pack or memory card)
Internal MIC	Omni-directional stereo microphone

- These technical specifications and design may be changed without notice.

Warranty

SAMSUNG LIMITED WARRANTY

SAMSUNG Electronics America Inc. (SEA), warrants that this product is free from defective material and workmanship.

SEA further warrants that if product fails to operate properly within the specified warranty period and the failure is due to improper workmanship or defective material, SEA will repair or replace the product at it's option. All warranty repairs must be performed by a SEA authorized service center. The name and address of the location nearest you can be obtained by calling toll free: 1-800 SAMSUNG (1-800-726-7864).

Labor

90 days carry-in

Parts

1 year

On carry-in models, transportation to and from the service center is the customer's responsibility.

The original dated sales receipt must be retained by the customer and is the only acceptable proof of purchase. It must be presented to the authorized service center.

EXCLUSIONS (WHAT IS NOT COVERED)

This warranty does not cover damage due to accident, fire, flood and/or other acts of God; misuse, incorrect line voltage, improper installation, improper or unauthorized repairs, commercial use, or damage that occurs in shipping. Exterior and interior finish, lamps, and glass are not covered under this warranty.

Customer adjustments which are explained in the instruction manual are not covered under the terms of this warranty. This warranty will automatically be voided for any unit found with a missing or altered serial number. This warranty is valid only on products purchased in the United States and Puerto Rico.

Some States do not allow the exclusions or limitations of incidental or consequential damages, or allow limitations on how long an implied warranty lasts, so the above limitations or exclusions may not apply to you.

This warranty gives you specific legal rights, and you may also have other rights which vary from State to State.



If you have any questions or comments relating to Samsung products, please contact the SAMSUNG customer care center Samsung Electronics America, inc.

1-800-SAMSUNG (726-7864)

www.samsung.com/us



RoHS compliant

Our product complies with "The Restriction Of the use of certain Hazardous Substances in electrical and electronic equipment", and we do not use the 6 hazardous materials- Cadmium(Cd), Lead (Pb), Mercury (Hg), Hexavalent Chromium (Cr +6), Poly Brominated Biphenyls (PBBs), Poly Brominated Diphenyl Ethers(PBDEs)- in our products.