

OWNER'S MANUAL

**SANSUI**®

**37" WIDE TFT LCD TELEVISION  
WITH DIGITAL TUNER  
HDLCD3700C**

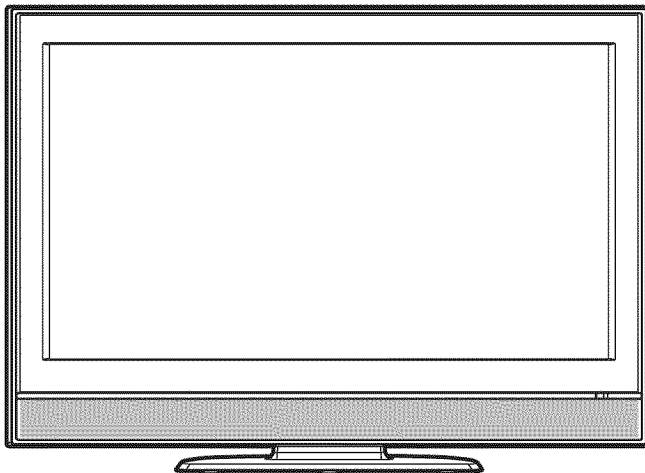
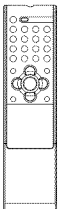

**ATTENTION**

If you purchase a universal remote control from your local retailer, please contact the remote manufacturer for the required programming code.

**Air/Cable MODE SELECTION**

When shipped from the factory, the Signal Type option is set to the "Cable" (Cable Television) mode. If not using Cable TV, set this menu option to the "Air" position.

IF CONTACT WITH CUSTOMER SERVICE IS REQUIRED  
PLEASE HAVE THE MODEL NUMBER READY PRIOR TO THE CALL

**CUSTOMER SERVICE – 1-800-289-0980**

**ORION WEBSITE**

FOR INFORMATION ON OUR OTHER PRODUCTS, PLEASE VISIT OUR WEBSITE AT

**[www.orionsalesinc.com](http://www.orionsalesinc.com)**

Before operating the unit, please read this manual thoroughly.

	<b>CAUTION</b> <b>RISK OF ELECTRIC SHOCK</b> <b>DO NOT OPEN</b>	
<p><b>CAUTION:</b> TO REDUCE THE RISK OF ELECTRIC SHOCK, DO NOT REMOVE COVER (OR BACK). NO USER-SERVICEABLE PARTS INSIDE. REFER SERVICING TO QUALIFIED SERVICE PERSONNEL.</p>		



The lightning flash with arrowhead symbol, within an equilateral triangle is intended to alert the user to the presence of uninsulated dangerous voltage within the product's enclosure that may be of sufficient magnitude to constitute a risk of electric shock.



The exclamation point within an equilateral triangle is intended to alert the user to the presence of important operating and maintenance (servicing) instructions in the literature accompanying the appliance.

<p><b>WARNING:</b> TO PREVENT FIRE OR SHOCK HAZARD, DO NOT EXPOSE THIS APPLIANCE TO RAIN OR MOISTURE.</p> <p><b>CAUTION:</b> TO PREVENT ELECTRIC SHOCK DO NOT USE THIS POLARIZED PLUG WITH AN EXTENSION CORD, RECEPTACLE OR OTHER OUTLET UNLESS THE BLADES CAN BE FULLY INSERTED TO PREVENT BLADE EXPOSURE.</p>
---

**WARNING:** This equipment has been tested and found to comply with the limits for a Class B digital device, pursuant to Part 15 of the FCC Rules. These limits are designed to provide reasonable protection against harmful interference in a residential installation. This equipment generates, uses and can radiate radio frequency energy and, if not installed and used in accordance with the instructions, may cause harmful interference to radio communications. However, there is no guarantee that interference will not occur in a particular installation. If this equipment does cause harmful interference to radio or television reception, which can be determined by turning the equipment off and on, the user is encouraged to try to correct the interference by one or more of the following measures:

- Reorient or relocate the receiving antenna.
- Increase the separation between the equipment and receiver.
- Connect the equipment into an outlet on a circuit different from that to which the receiver is connected.
- Consult the dealer or an experienced radio/TV technician for help.

**CAUTION:** Changes or modifications not expressly approved by the party responsible for compliance with the FCC Rules could void the user's authority to operate this equipment.

<p><b>The lamp(s) within this product contain mercury. Disposal should be in compliance with local, state or federal laws.</b></p>
--

**Location of the required Marking**

The rating sheet and the safety caution are on the rear of the unit.

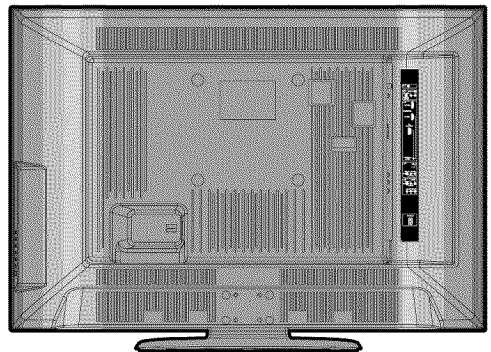

Record the model number and serial number.

Model number \_\_\_\_\_ Serial number \_\_\_\_\_

# IMPORTANT SAFETY INSTRUCTIONS

---

- 1) Read these instructions.
- 2) Keep these instructions.
- 3) Heed all warnings.
- 4) Follow all instructions.
- 5) Do not use this apparatus near water.
- 6) Clean only with a clean dry cloth.
- 7) Do not block any ventilation openings. Install in accordance with the manufacturer's instructions.
- 8) Do not install near any heat sources such as radiators, heat registers, stoves, or other apparatus (including amplifiers) that produce heat.
- 9) Do not defeat the safety purpose of the polarized or grounding-type plug. A polarized plug has two blades with one wider than the other. A grounding type plug has two blades and a third grounding prong. The wide blade and the third prong are provided for your safety. If the provided plug does not fit into your outlet, consult an electrician to replace the obsolete receptacle.
- 10) Protect the power cord from being walked on or pinched particularly at plug, and the point where it exits from the apparatus.
- 11) Only use attachments/accessories specified by the manufacturer.
- 12) Use only with the cart, stand, tripod, bracket, or table specified by the manufacturer, or sold with the apparatus. When a cart is used, use caution when moving the cart/apparatus combination to avoid injury from tip-over.
- 13) Unplug this apparatus during lightning storms or when unused for long periods of time.
- 14) Refer all servicing to qualified service personnel. Servicing is required when the apparatus has been damaged in any way, such as power-supply cord or plug damage, liquid has been spilled or objects have fallen into the apparatus, the apparatus has been exposed to rain or moisture, does not operate normally, or has been dropped.
- 15) Apparatus should not be exposed to dripping or splashing, and objects filled with liquids, such as vases, should not be placed on the apparatus.
- 16) An outside antenna system should not be located in the vicinity of overhead power lines or other electric light or power circuits, or where it can fall into such power lines or circuits. When installing an outside antenna system, extreme care should be taken to keep from touching such power lines or circuits, as contact with them might be fatal.
- 17) Do not overload wall outlets and extension cords, as this can result in a risk of fire or electric shock.
- 18) Do not push objects through any openings in this unit, as they may touch dangerous voltage points or short out parts that could result in fire or electric shock. Never spill or spray any type of liquid into the unit.

PORTABLE CART WARNING  
(symbol provided by RETAC)



**S3126A**

# IMPORTANT SAFETY INSTRUCTIONS

- 19) If an outside antenna or cable system is connected to the unit, be sure the antenna or cable system is grounded to provide some protection against voltage surges and built-up static charges, Section 810 of the National Electrical Code, ANSI/NFPA 70, provides information with respect to proper grounding of the mast and supporting structure, grounding of the lead-in wire to an antenna discharge unit, size of grounding conductors, location of antenna discharge unit, connection to grounding electrodes, and requirements for the grounding electrode.

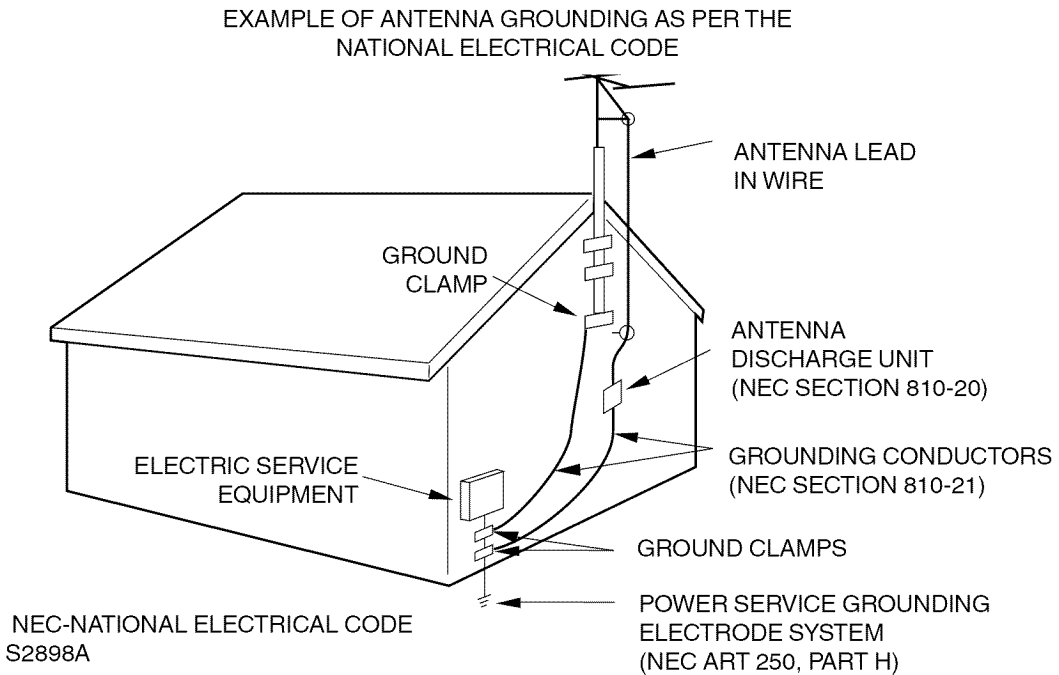

- 20) When replacement parts are required, be sure the service technician uses replacement parts specified by the manufacturer or those that have the same characteristics as the original part. Unauthorized substitutions may result in fire, electric shock or other hazards.
- 21) Upon completion of any service or repairs to this unit, ask the service technician to perform safety checks to determine that the unit is in proper operating condition.
- 22) When you connect the product to other equipment, turn off the power and unplug all of the equipment from the wall outlet. Failure to do so may cause an electric shock and serious personal injury. Read the owner's manual of the other equipment carefully and follow the instructions when making any connections.
- 23) Reduce the volume to the minimum level before you turn on the product. Otherwise, sudden high volume sound may cause hearing or speaker damage.
- 24) Do not allow the product to output distorted sound for an extended period of time. It may cause speaker overheating and fire.
- 25) This reminder is provided to call the cable TV system installer's attention to Article 820-40 of the NEC that provides guidelines for proper grounding and, in particular, specifies that the cable ground shall be connected to the grounding system of the building, as close to the point of cable entry as practical.

# IMPORTANT SAFETY INSTRUCTIONS

## CONDENSATION

Moisture will form in the operating section of the player if the player is brought from cool surroundings into a warm room or if the temperature of the room rises suddenly. When this happens, player's performance will be impaired. To prevent this, let the player stand in its new surroundings for about an hour before switching it on, or make sure that the room temperature rises gradually.

Condensation may also form during the summer if the player is exposed to the breeze from an air conditioner. In such cases, change the location of the player.

## HOW TO HANDLE THE LCD PANEL

- Do not press hard or jolt the LCD panel. It may cause the LCD panel glass to break and injury may occur.
- If the LCD panel is broken, make absolutely sure that you do not touch the liquid in the panel. This may cause skin inflammation.  
If the liquid gets in your mouth, immediately gargle and consult with your doctor. Also, if the liquid gets in your eyes or touches your skin, consult with your doctor after rinsing for at least 15 minutes or longer in clean water.

**Possible Adverse Effects on LCD Panel:** If a fixed (non-moving) pattern remains on the LCD Panel for long periods of time, the image can become permanently engrained in the LCD Panel and cause subtle but permanent ghost images. This type of damage is **NOT COVERED BY YOUR WARRANTY**. Never leave your LCD Panel on for long periods of time while it is displaying the following formats or images:

- Fixed Images, such as stock tickers, video game patterns, TV station logos, and websites.
- Special Formats that do not use the entire screen. For example, viewing letterbox style (16:9) media on a normal (4:3) display (black bars at top and bottom of screen); or viewing normal style (4:3) media on a widescreen (16:9) display (black bars on left and right sides of screen).

**The following symptoms are not signs of malfunction but technical limitation. Therefore we disclaim any responsibility for these symptoms.**

- LCD Panels are manufactured using an extremely high level of precision technology, however sometimes parts of the screen may be missing picture elements or have luminous spots. This is not a sign of a malfunction.
- Do not install the LCD Panel near electronic equipment that is susceptible to electromagnetic waves. Some equipment placed too near this unit may cause interference.
- Effect on infrared devices – There may be interference while using infrared devices such as infrared cordless headphones.

## SAFETY PRECAUTIONS

The unit emits heat when in operation. Do not place any covers or blankets on the unit, this may cause overheating.

Do not block ventilation holes, or set up near radiators. Do not place in direct sunshine. When placing on a shelf leave 10 cm (4 inches) free space around the entire unit.

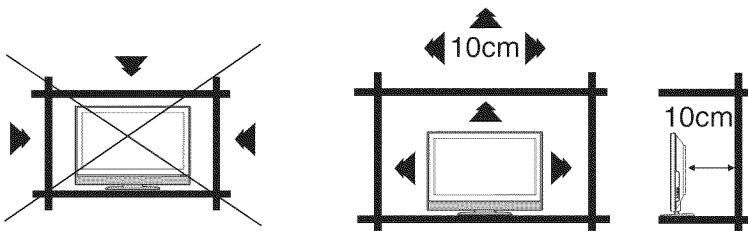

## Notes when mounting the LCD TV on a wall

- If the unit is to be mounted on the wall, contact the retailer where you purchased the LCD TV for advice, and have the equipment professionally installed. Incomplete or improper installation may cause injury to you, and/or damage to the LCD TV.
- Bracket holes: To attach a wall mounting bracket (not supplied) remove the screws and attached where indicated in the drawing right.

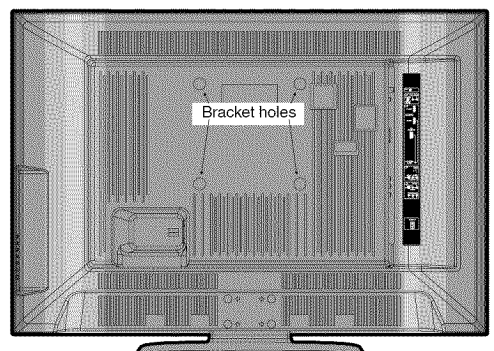

# Contents

---

## PREPARATIONS

IMPORTANT SAFETY INSTRUCTIONS .....	3
SAFETY PRECAUTIONS .....	5
Contents .....	6
Features .....	7
Power source .....	7
Parts and functions .....	8
Remote control .....	9
Antenna connections .....	10
Cable TV connections .....	11
Connections to other equipment .....	12
Setting the language .....	17

## OPERATION

Memorizing channels .....	17
TV operation .....	18
Labeling channels .....	19
Labeling video inputs .....	20
Setting the V-Chip .....	20
Closed Caption .....	21
CC advanced .....	22
Adjusting the picture preference .....	22
Picture control adjustment .....	23
Selecting the color temperature .....	23
Setting the picture size .....	23
Film Mode .....	24
Picture control adjustment in the PC mode .....	24
DNR .....	25
Sound control adjustment .....	25
Selecting Stereo/Second Audio Program (SAP) .....	25
Selecting the audio language .....	25
Selecting the HDMI audio input source .....	26
Turning off the built-in speakers .....	26
Adjusting the back lighting .....	26
Setting the Auto Shut Off .....	26
Resetting your settings .....	26

## OTHERS

Reception disturbances .....	27
Troubleshooting .....	28
Specifications .....	29
LIMITED WARRANTY .....	30

- **Integrated Digital Tuner** - You can view digital broadcasts without using a Digital TV Set-Top Box.
- **Closed Caption Decoder With Full Text Mode** - Displays text captions or full screen text on the screen for hearing impaired viewers.
- **Picture Adjustments Using The Remote Control** - The On-Screen display allows precise remote control adjustment of BRIGHTNESS, CONTRAST, COLOR, TINT and SHARPNESS.
- **Programmable TV Sleep Timer** - Operable from the remote control, the LCD TV can be programmed for up to 120 minutes to turn off automatically.
- **V-Chip** - The V-Chip function can read the rating of a broadcast program or movie content if the program is encoded with this information. V-chip will allow you to set a restriction level.
- **Digital Audio Jack (Coaxial)** - When a component with a built-in Dolby Digital decoder is connected, Dolby Digital sound can produce the effect of being in a movie theater or a concert hall.
- **S-Video/Component Video Jacks** - A VCR, DVD player, satellite receiver or other audio/video component can be connected to this unit.
- **Video Input Jacks** - This unit is equipped with 3 types of video input jacks. The component video in jacks and S-video in jack enable you to watch the DVD player or the video devices with high quality picture.
- **On-Screen 3 Language Display** - You can select one of 3 languages, English, French or Spanish for on-screen programming.

\* Manufactured under license from Dolby Laboratories. "Dolby" and the double-D symbol are trademarks of Dolby Laboratories.

\* HDMI, the HDMI logo and High-Definition Multimedia Interface are trademarks or registered trademarks of HDMI Licensing LLC.

## Power source

### TO USE AC POWER

1. Connect the AC cord plug into this unit's AC INPUT jack.
2. Connect the AC cord into an AC outlet.

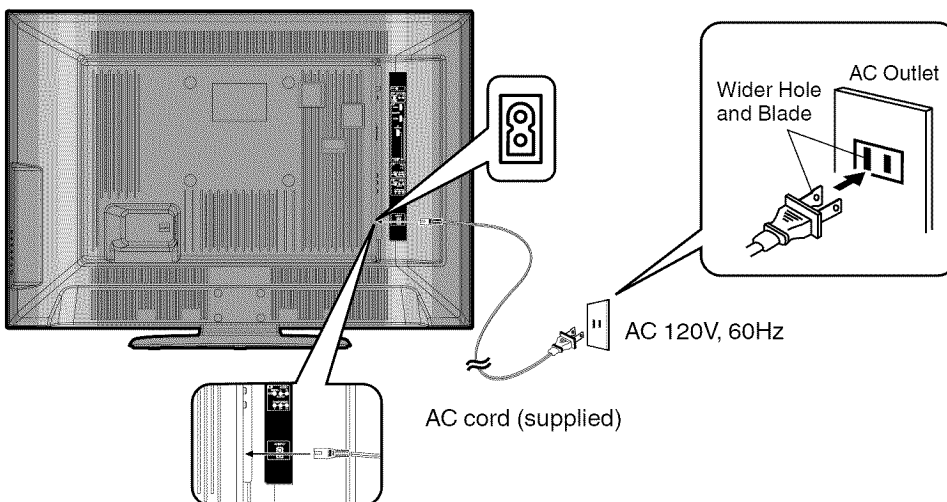

### NOTE:

- Please make sure to insert the cord securely at both the LCD TV and the wall outlet.
- The AC cord has a grounding-type AC line plug. If the supplied AC cord does not match your AC outlet, contact a qualified electrician, do not defeat the purpose of a grounding plug.

### WARNING:

- DO NOT CONNECT THIS UNIT TO THE POWER USING ANY DEVICE OTHER THAN THE SUPPLIED AC CORD. THIS COULD CAUSE FIRE, ELECTRICAL SHOCK, OR DAMAGE.
- DO NOT USE WITH A VOLTAGE OTHER THAN THE POWER VOLTAGE DISPLAYED. THIS COULD CAUSE FIRE, ELECTRICAL SHOCK, OR DAMAGE.

### CAUTION:

- WHEN THIS UNIT IS NOT USED FOR A LONG TIME, (E.G., AWAY ON A TRIP) IN THE INTEREST OF SAFETY, BE SURE TO UNPLUG IT FROM THE AC OUTLET.
- DO NOT PLUG/UNPLUG THE PLUG WHEN YOUR HANDS ARE WET. THIS MAY CAUSE ELECTRICAL SHOCK.
- IF YOU NEED TO REPLACE THE SUPPLIED AC ADAPTER OR AC CORD, THE SPECIFIED ONE IS RECOMMENDED. CONTACT CUSTOMER SERVICE AT 1-800-289-0980.

# Parts and functions

## Front

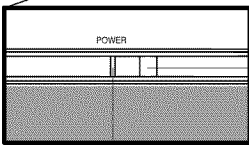
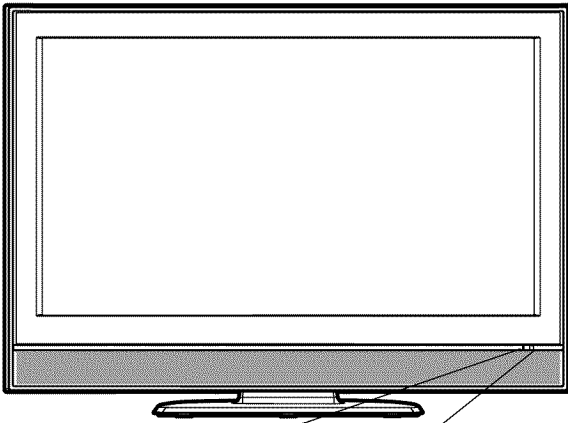

Remote sensor

POWER indicator  
 Red: Standby  
 Green: On  
 (It alternately blinks to red and green while starting.)

## Right side

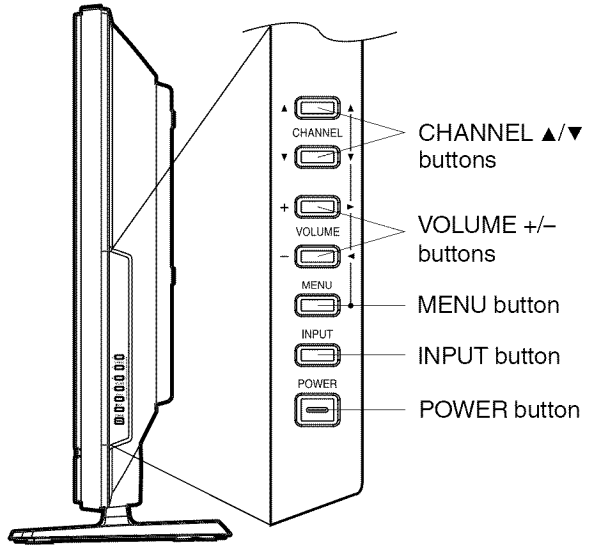

CHANNEL ▲/▼ buttons

VOLUME +/- buttons

MENU button

INPUT button

POWER button

## Left side

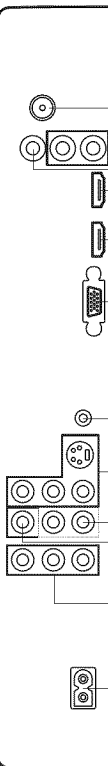
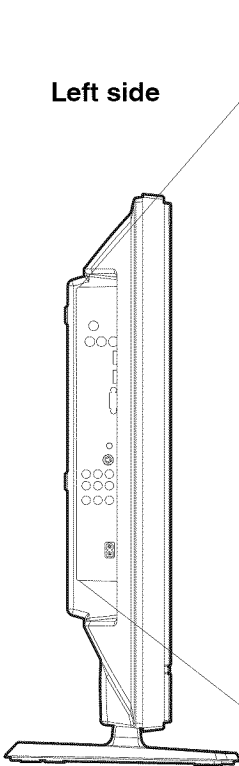

RF (ANT) IN jack

VAR (VARIABLE) AUDIO OUT jacks

COAXIAL DIGITAL AUDIO OUT jack

HDMI-2 IN jack

HDMI-1 IN jack

PC MONITOR IN jack

PC/HDMI-1 AUDIO IN jack

AV1 IN jacks (VIDEO/S-VIDEO/AUDIO (L/R))

AUDIO (L/R) jacks  
 (for COMPONENT IN and AV2 VIDEO IN)

AV2 VIDEO IN jack

COMPONENT IN jacks

AC INPUT jack

To display the menu screen.  
 Press MENU button to display the menu screen.  
 CHANNEL ▲/▼ buttons and VOLUME +/- buttons can be used to select the desired setting during the menu screen operations.



# Remote control

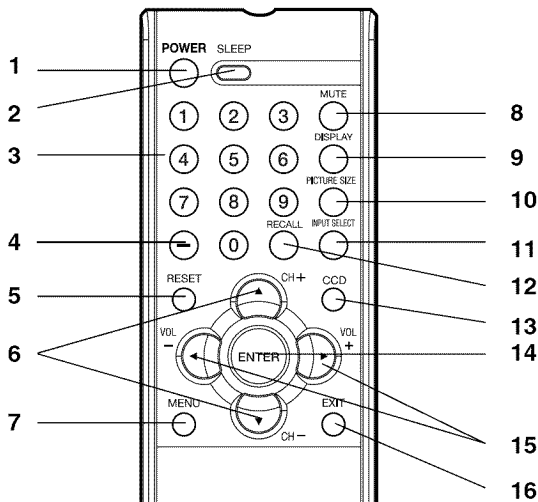

- 1. POWER Button** - Used to turn the power on/off to the LCD TV.
- 2. SLEEP Button** - To set the LCD TV to turn off after a preset amount of time, use the SLEEP button on the remote control.
- 3. Direct Channel Selection Buttons (0-9)** - Allows direct access to any channel of the LCD TV.
- 4. - Button** - This button is the “-” button used when selecting digital channels. Also can display the current channel number when viewing the program.
- 5. RESET Button** - Press to reset the On-Screen picture adjustments to their factory preset positions. To use this function, select “Picture” or “Audio” in the menu screen, then press this button.

- 6. CH (CHANNEL) + / - / CURSOR ▲ / ▼ Buttons** - Used to operate the menu functions of the LCD TV, and to change the channels of the LCD TV.
- 7. MENU Button** - Use to display the On-Screen menu function.
- 8. MUTE Button** - To turn off the sound, press this button once. The LCD TV will be silenced and the symbol “Mute” will appear on the screen. The muting feature can be released by pressing the MUTE button again or one of the VOL (VOLUME) + or - buttons.
- 9. DISPLAY Button** - When you press this button, the current information will be displayed on a screen. To remove the display from the screen, press this button again.
- 10. PICTURE SIZE Button** - Used to change the picture size.
- 11. INPUT SELECT Button** - Use to change the external input.
- 12. RECALL Button** - This button allows you to go back to the previous channel selected by just pressing the RECALL button. Press this button again to return to the channel you were watching.
- 13. CCD Button** - Used to display the Closed Caption menu screen.
- 14. ENTER Button** - Use to enter or select information for On-Screen operations. Also can display the current channel number when viewing the program.
- 15. VOL (VOLUME) + / - / CURSOR ◀ / ▶ Buttons** - Used to operate the menu functions of the LCD TV. Press the ▶ button to increase, or the ◀ button to decrease the sound level.
- 16. EXIT Button** - Press to remove setup menu.

Before using the remote control, batteries must first be installed.

## HOW TO INSTALL BATTERIES

1. Open the battery compartment cover.

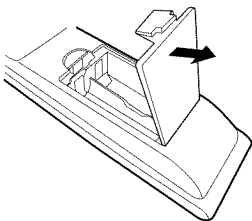

2. Install two “AA” batteries (supplied).

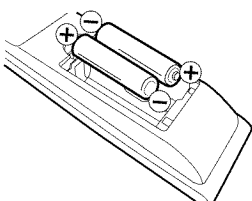

3. Replace the battery compartment cover.

Use two “AA” size batteries. The batteries may last approximately one year depending on how much the remote control is used. For best performance, it is recommended that batteries should be replaced on a yearly basis, or when the remote operation becomes erratic. Do not mix old and new batteries or different types.

## BATTERY PRECAUTIONS

These precautions should be followed when using batteries in this device:

- Use only the size and type of batteries specified.
- Be sure to follow the correct polarity when installing the batteries as indicated in the battery compartment. Reversed batteries may cause damage to the device.
- Do not mix different types of batteries together (e.g. Alkaline and Carbon-zinc) or old batteries with fresh ones.
- If the device is not to be used for a long period of time, remove the batteries to prevent damage or injury from possible battery leakage.
- Do not try to recharge batteries not intended to be recharged; they can overheat and rupture. (Follow battery manufacturer’s directions.)

# Antenna connections

If you are using an indoor or outdoor antenna, follow the instructions below that correspond to your antenna system. If you are using a Cable TV service, see page 11 for Cable TV connections.

## Combination VHF/UHF Antenna (Single 75 ohm cable or 300 ohm twin-lead wire)

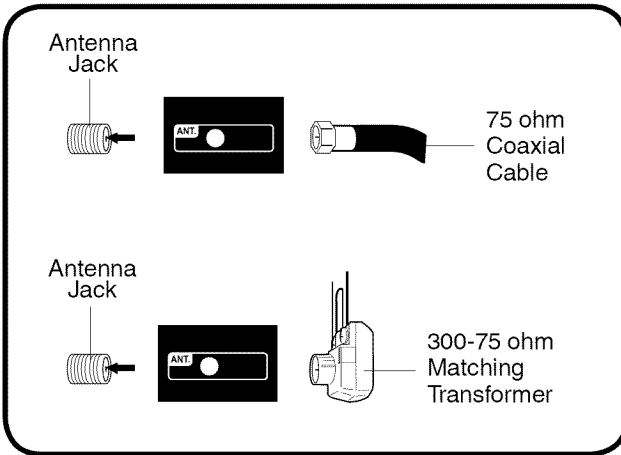

Connect the 75 ohm cable from the combination VHF/UHF antenna to the antenna jack.

If your combination VHF/UHF antenna has a 300 ohm twin-lead wire, the use of the 300-75 ohm matching transformer may be necessary.

## Combination VHF/UHF Antenna (Separate VHF and UHF 300 ohm twin-lead wires)

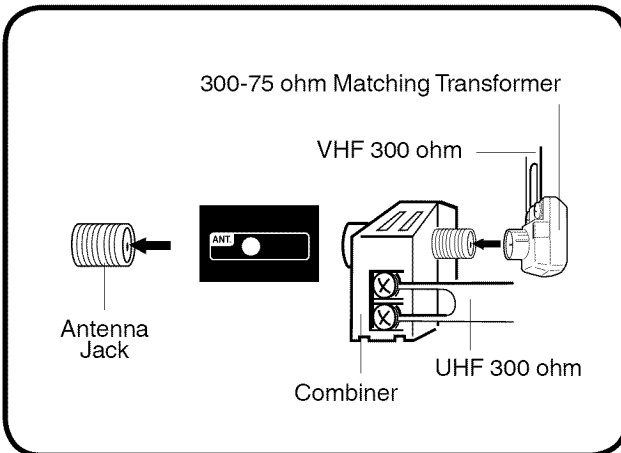

Connect the UHF 300 ohm twin-lead wire to the Combiner (not supplied). Connect the VHF 300 ohm twin-lead wire to the 300-75 ohm Matching Transformer. Attach the Transformer to the Combiner, then attach the Combiner to the Antenna Jack.

## Separate VHF/UHF Antennas (75 ohm VHF cable and 300 ohm UHF twin-lead wires)

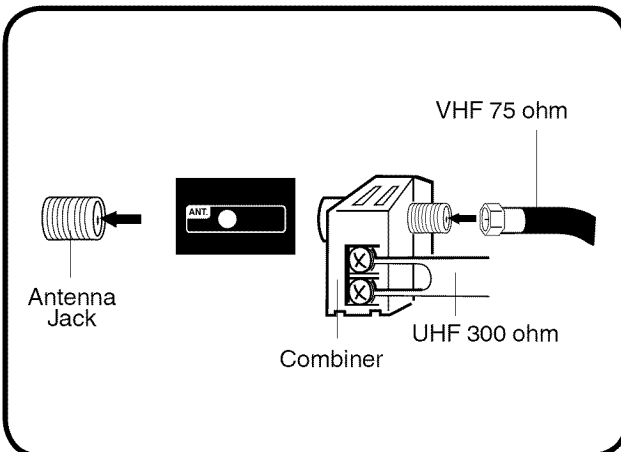

Connect the VHF 75 ohm cable and UHF 300 ohm twin-lead wire to the Combiner (not supplied). Attach the Combiner to the Antenna Jack.

# Cable TV connections

This TV has an extended tuning range and can tune most cable channels without using a Cable TV Converter box. Some cable companies offer "premium pay channels" where the signal is scrambled. Descrambling these signals for normal viewing requires the use of a descrambler device which is generally provided by the Cable TV company.

## For subscribers to basic Cable TV service

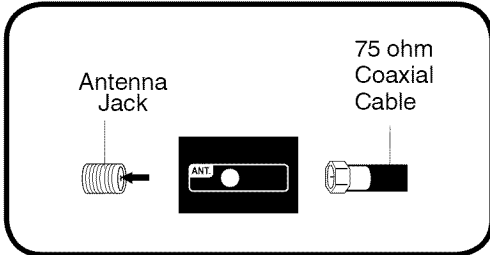

For basic Cable TV service not requiring a Converter/Descrambler box, connect the 75 ohm Coaxial Cable directly to the Antenna Jack on the back of the TV.

## For subscribers to scrambled Cable TV service

If you subscribe to a Cable TV service which requires the use of a Converter/Descrambler box, connect the incoming 75 ohm Coaxial Cable to the Converter/Descrambler box. Using another 75 ohm Coaxial Cable, connect the output jack of the Converter/Descrambler box to the Antenna Jack on the TV. Follow the connections shown below. Set the TV to the output channel of the Converter/Descrambler box (usually channel 3 or 4) and use the Converter/Descrambler box to select channels.

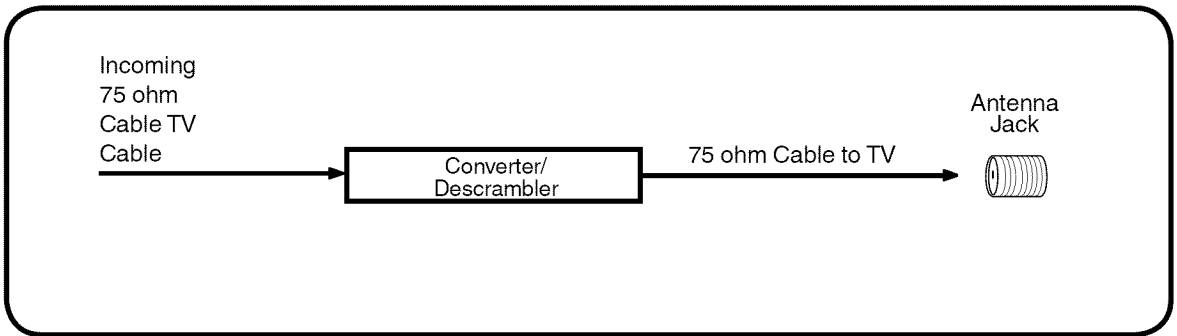

## For subscribers to unscrambled Cable TV service with scrambled premium channels

If you subscribe to a Cable TV service in which basic channels are unscrambled and premium channels require the use of a Converter/Descrambler box, you may wish to use a signal Splitter and an A/B Switch box (available from the Cable TV company or an electronics supply store). Follow the connections shown below. With the switch in the "B" position, you can directly tune any unscrambled channels on your TV. With the switch in the "A" position, tune your TV to the output of the Converter/Descrambler box (usually channel 3 or 4) and use the Converter/Descrambler box to tune scrambled channels.

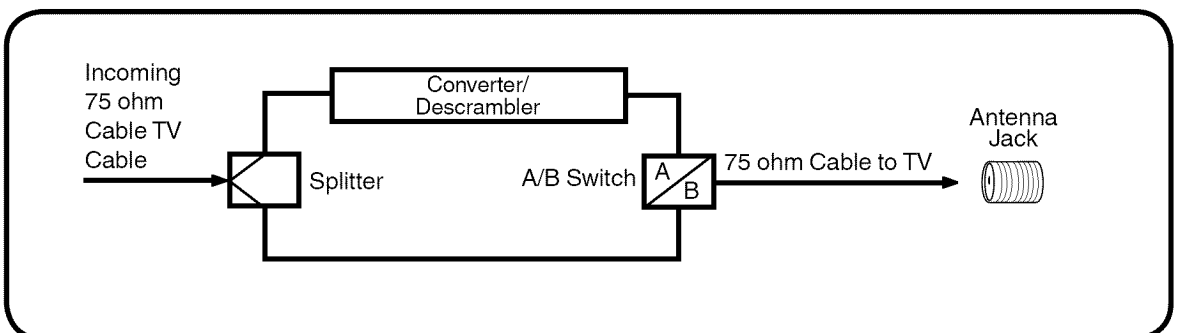

# Connections to other equipment

The exact arrangement you use to interconnect various video and audio components to the LCD TV is dependent on the model and features of each component. Check the Owner's Manual provided with each component for the location of video and audio inputs and outputs.

The connection diagrams below are offered as suggestions. You may need to modify them to accommodate your particular assortment of components. The diagrams are intended to show component video and audio interconnections only.

## To connect the LCD TV to a VCR

### Left side of the LCD TV

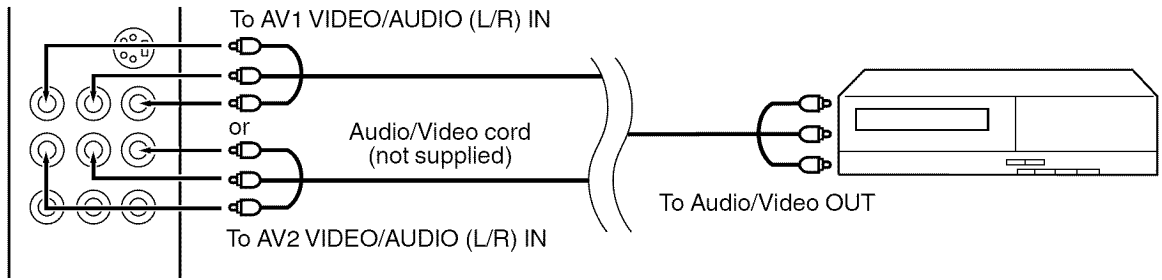

## To connect the LCD TV to a VCR with an S-Video cord

If you connect a VCR with a S-Video cord to the S-VIDEO IN jack on the LCD TV, you must also connect the audio cords to the AV1 AUDIO(L/R) IN jacks. The S-Video cord only carries the video signal. The audio signal is separate.

### Rear of the LCD TV

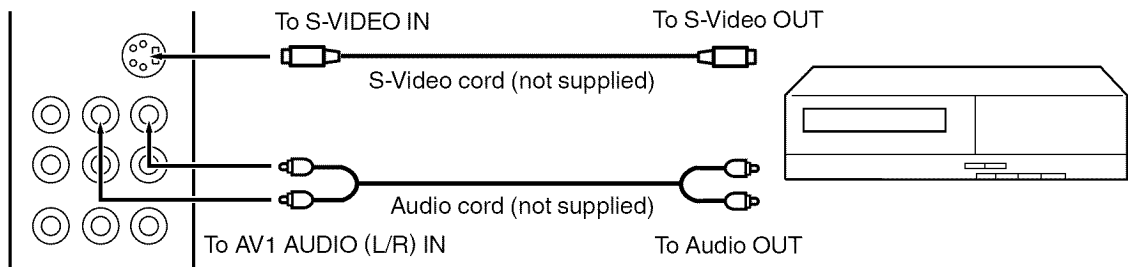

### NOTE:

- When the S-Video cord and the video cord are connected to each jack at the same time, the S-Video cord takes precedence over the video cord.

# Connections to other equipment

## To connect the LCD TV to a DVD player/Satellite receiver

If your DVD player or Satellite receiver has a S-Video out jack, connect cords as shown.

### Left side of the LCD TV

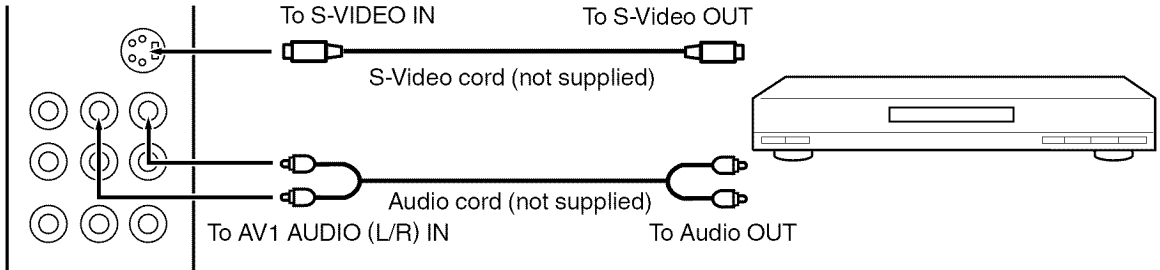

## To connect the LCD TV to a DVD player with component video

If your DVD player has component video out jacks, connect your LCD TV to a DVD player using a component video cord. It can greatly enhance picture quality and performance.

### Left side of the LCD TV

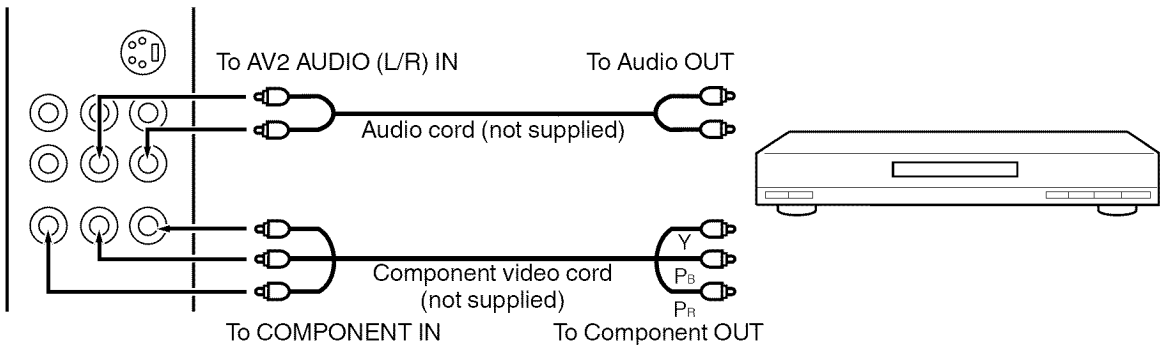

### NOTE:

- Component Video inputs of the unit are for use with a device which outputs 480i/1080i interlaced signals and 480p/720p progressive signals.

# Connections to other equipment

## To connect the LCD TV to a DTV receiver/set-top box

If you connect a DTV receiver/set-top box, connect your LCD TV to a DTV receiver/set-top box using a component video cord.

### Left side of the LCD TV

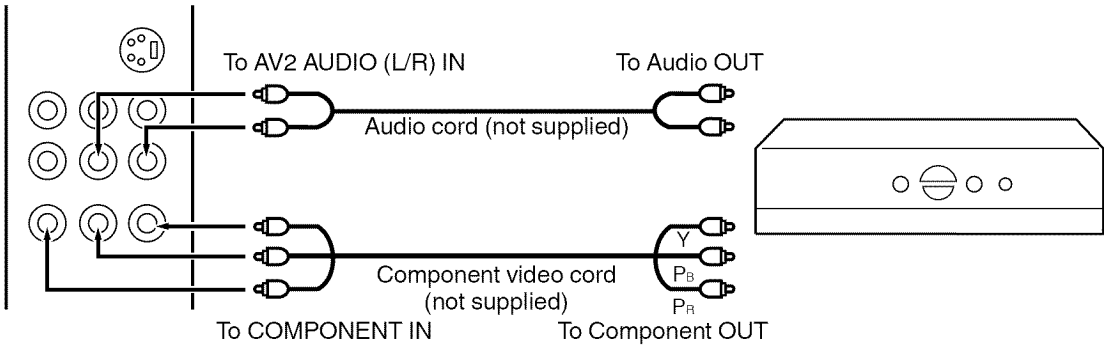

## To connect the LCD TV to an HDMI or a DVI device

The HDMI input receives digital audio and uncompressed video from an HDMI device or uncompressed digital video from a DVI device.

When you connect to a DVI device with an HDMI-to-DVI adapter cable, it transfers only the video signal. Separate analog audio cords are required.

### Left side of the LCD TV

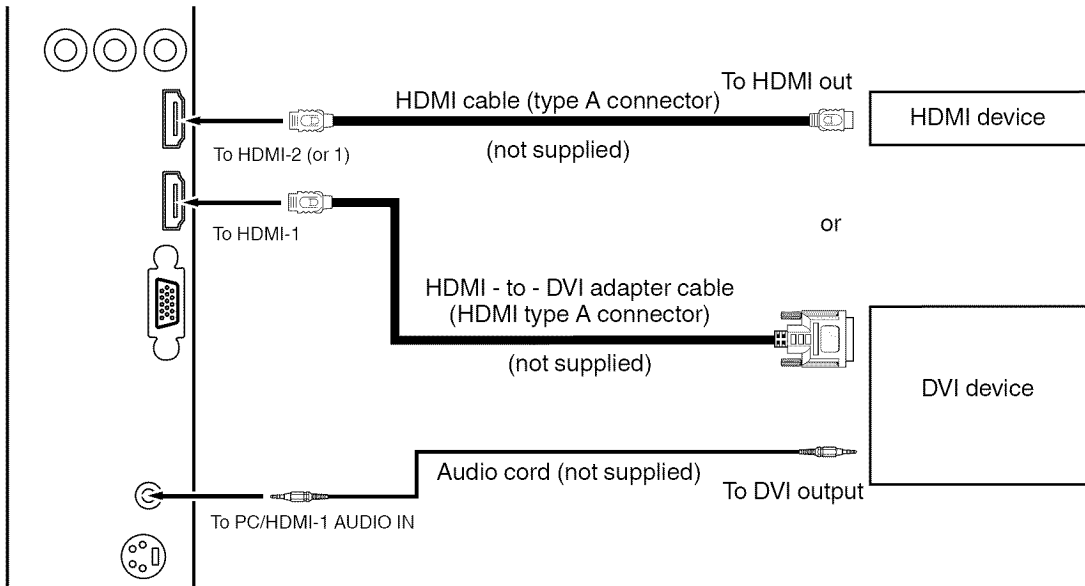

### NOTE:

- When you connect a DVI device, you must connect only with HDMI-1. When using HDMI-1 to connect your HDMI or DVI devices, you must select the corresponding audio source (HDMI or DVI) on the menu screen (see "Selecting the HDMI audio input source" on page 26). Otherwise you will only see the image with no sound.
- If you connect an external component (cable box, satellite receiver, etc.) to this LCD TV using an HDMI cable or a DVI to HDMI cable, the image will not display if the output resolution of the component is set to 480i. To receive the picture you must change the output resolution on the external component. Should you require further instruction, please contact the manufacturer of the external component.

# Connections to other equipment

## To connect the LCD TV to a Game or a Camcorder

The LCD TV can also be used as a TV device for many video games or camcorders. However, due to the wide variety of signals generated by these devices and subsequent hook-up variations required, they have not all been included in the suggested connection diagrams. You'll need to consult each component's Owner's Manual for additional information.

### Left side of the LCD TV

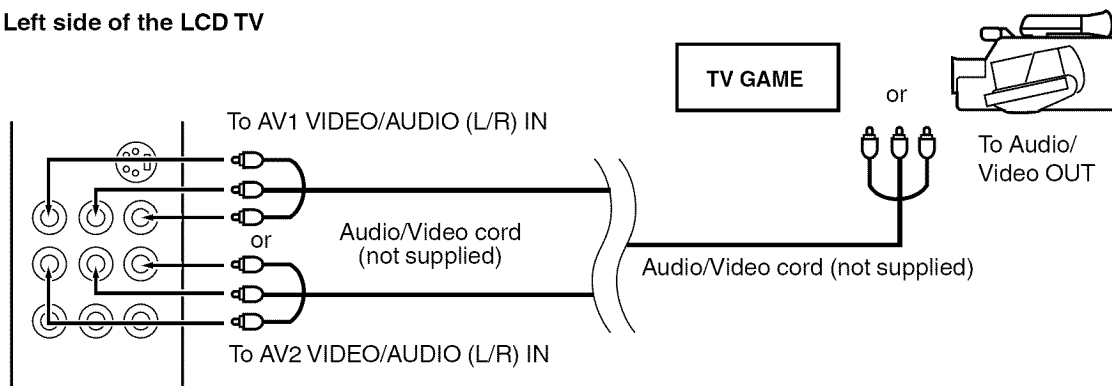

## Using an AV Amplifier with built-in digital surround

If you are using an Amplifier with built-in digital surround sound, you can enjoy various audio systems including Dolby Digital Surround audio that sounds just like the movie.

**Connect an AV amplifier with built-in Dolby Digital decoder, or etc. as shown below.**

### Rear of the LCD TV

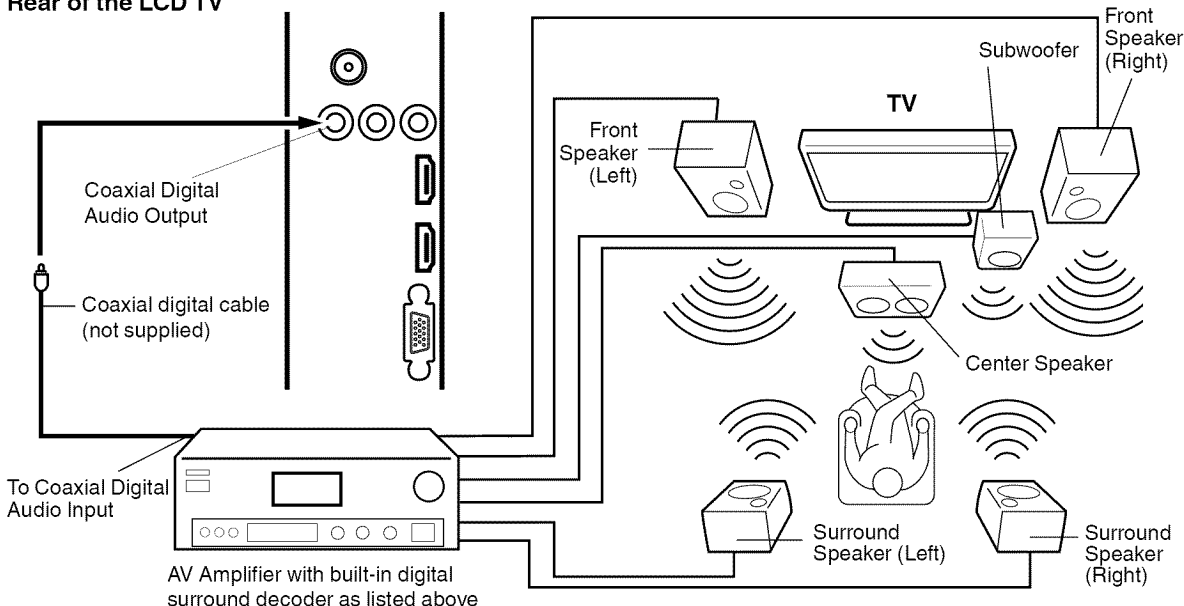

### NOTE:

- Coaxial digital audio output is active only when receiving digital broadcasting, not when receiving analog broadcasting.
- Coaxial digital audio output doesn't output the sound of external inputs.
- This unit will not work in conjunction with DTS audio. There will be no sound output if connected to an AV amplifier with a built-in DTS decoder.

# Connections to other equipment

## To connect an audio system

This connection allows you to use an audio amplifier and external speakers, and adjust the audio level using the TV's remote control.

To control the audio, turn on the TV and the stereo amplifier, and turn off the TV's built-in speakers (see "Turning off the built-in speakers" on page 26).

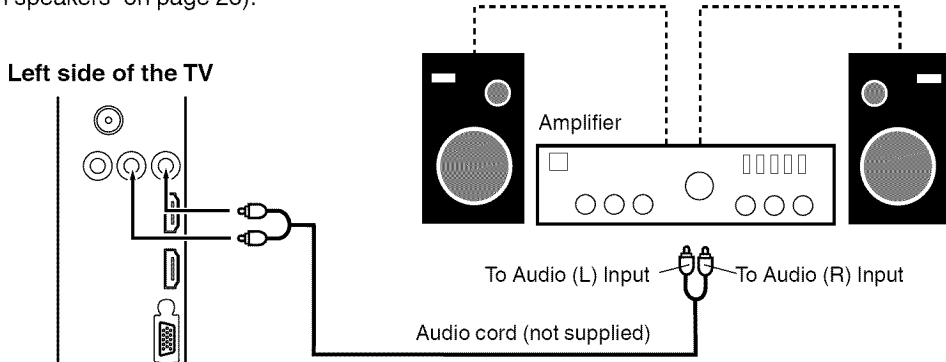

### NOTE:

To hear sound when using an external audio amplifier, the volume of both the TV and the amplifier must be set above 0 (zero).

For example, if the volume of the TV is set to 0, you will not be able to hear any sound, even if the volume of the amplifier is at its highest level.

## To connect the LCD TV to a PC (Personal Computer)

Before you connect this LCD TV to your PC, change the adjustment of your PC's Resolution and Refresh rate (60 Hz).

Connect one end of a (male to male) VGA cable to the video card of the computer and the other end to the VGA connector PC MONITOR IN on the back of the LCD TV. Attach the connectors firmly with the screws on the plug. In case of a Multimedia computer, connect the audio cord to the audio output of your Multimedia computer and to the AUDIO connector of the PC/HDMI-1 AUDIO IN jack of the LCD TV.

Press **INPUT SELECT** on the remote control to select PC mode.

Switch on the computer. The LCD TV can operate as the computer monitor.

### Left side of the LCD TV

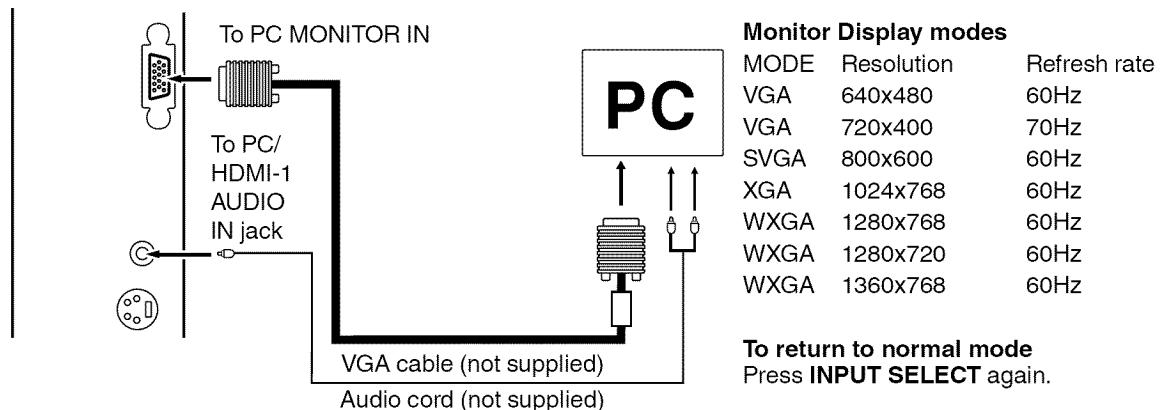

### NOTE:

- The on-screen displays will have a different appearance in PC mode than in TV mode.
- If there is no video signal from the PC when the unit is in PC mode, "No signal" will appear on the TV-screen.



# Setting the language

You can choose from three different languages (English, French and Spanish) for the on-screen displays.

Select the language you prefer first, then proceed with the other menu options.

**1** To turn on the TV, press **POWER**. (POWER indicator on the front of the unit changes green. It may take approx. 10 seconds for a picture to appear on screen.)

**2** Press **MENU**. The menu screen will appear.

**3** Press **▲** or **▼** to select "Setup", then press **▶** or **ENTER**.

**4** Press **▲** or **▼** to select "Language".

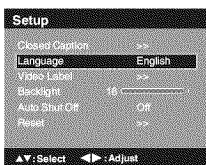

## NOTE:

- When you press **MENU** first time after purchase this LCD TV, above screen will appear automatically.

**5** Press **◀** or **▶** to select the desired language: English, French (Français) or Spanish (Español).

**6** Press **EXIT** to return to the normal screen.

## NOTE:

- If no buttons are pressed for more than about 60 seconds, the MENU screen will return to normal operation automatically.

# Memorizing channels

This TV is equipped with a channel memory feature which allows channels to skip up or down to the next channel set into memory, skipping over unwanted channels. Before selecting channels, they must be programmed into the TV's memory. To use this TV with an antenna, set the Tuning Band menu option to the Air mode. When shipped from the factory, this menu option is in the Cable mode.

## Air/Cable selection

**1** Press **MENU**. The menu screen will appear.

**2** Press **▲** or **▼** to select "Channel", then press **▶** or **ENTER**.

**3** Press **▲** or **▼** to select "Auto Ch Memory", then press **▶** or **ENTER**.

**4** Press **▲** or **▼** to select "Signal Type".

**5** Press **◀** or **▶** to select "Air" or "Cable".

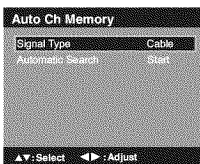

**6** Press **EXIT** to return to the normal screen.

## CABLE CHART

The chart below is typical of many cable system channel allocations.

Number on this TV		Corresponding CABLE channel		14	15	16	17	18	19	20	21	22
A	B	C	D	E	F	G	H	I	J	K	L	M
23	24	25	26	27	28	29	30	31	32	33	34	35
J	K	L	M	N	O	P	Q	R	S	T	U	V
41	42	43	44	45	46	47	48	49	50	51	52	53
EE	FF	GG	HH	II	JJ	KK	LL	MM	NN	OO	PP	QQ
59	60	61	62	63	64	65	66	67	68	69	70	71
WW	AAA	BBB	CCC	DDD	EEE	FFF	GGG	HHH	III	JJJ	KKK	LLL
77	78	79	80	81	82	83	84	85	86	87	88	89
RRR	SSS	TTT	UUU	VVV	WWW	XXX	YYY	ZZZ	86	87	88	89
95	96	97	98	99	100	101	102	103	104	105	106	107
A-5	A-4	A-3	A-2	A-1	100	101	102	103	104	105	106	107
113	114	115	116	117	118	119	120	121	122	123	124	125
113	114	115	116	117	118	119	120	121	122	123	124	125

## NOTE:

- It may take a few seconds for a digital channel picture to appear on screen after being selected.

## Automatic search

**1** Press **MENU**. The menu screen will appear.

**2** Press **▲** or **▼** to select "Channel", then press **▶** or **ENTER**.

**3** Press **▲** or **▼** to select "Auto Ch Memory", then press **▶** or **ENTER**.

**4** Press **▲** or **▼** to select "Automatic Search", then press **▶** or **ENTER**.

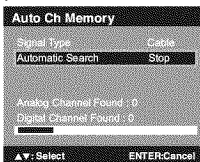

**5** The TV will begin memorizing all the channels available in your area.

- It may take from 15 minutes to 30 minutes to complete memorizing digital cable channels. Depending on the reception condition, a BAR display may not advance for several minutes, please be patient.

## NOTE:

- Memorizing channels is best accomplished during evening "PRIMETIME" hours, as more stations are broadcasting digital signals. Memorizing channels can only be accomplished while a station is broadcasting a digital signal to set that channel into memory.
- If you are unsure of the digital channels available in your area, you may visit [www.antennaweb.org](http://www.antennaweb.org) to receive a list based on your address or zip code. Should you require further assistance you may call our toll-free customer service line at 1-800-289-0980.
- New digital channels may be added to your area periodically, it is recommended to perform the "Automatic Search" procedure regularly.

## Adding Channel

If you find a new channel unregistered, you can add the new channel into the channel memory.

- 1 Tune in the new channel.
- 2 Press **MENU**. The menu screen will appear.
- 3 Press **▲** or **▼** to select "Channel", then press **▶** or **ENTER**.
- 4 Press **▲** or **▼** to select "Add/Delete", then press **▶** or **ENTER**.

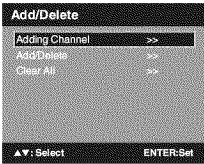

- 5 Press **▲** or **▼** to select "Adding Channel", then press **▶** or **ENTER**. The new channel will be added into the channel memory.
- 6 Press **EXIT** to return to the normal screen.

## Add/Delete channel

You can select the channel that you want to skip.

- 1 Press **MENU**. The menu screen will appear.
- 2 Press **▲** or **▼** to select "Channel", then press **▶** or **ENTER**.
- 3 Press **▲** or **▼** to select "Add/Delete", then press **▶** or **ENTER**.
- 4 Press **▲** or **▼** to select "Add/Delete", then press **▶** or **ENTER**.
- 5 Press **▲** or **▼** to select the channel that you want to skip.

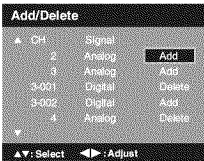

- 6 Press **◀** or **▶** to select "Add" or "Delete", whichever function you want to perform.
- 7 Repeat steps 5 - 6 for other channels you want to add or delete.
- 8 Press **EXIT** to return to the normal screen.

## Clear All

All channels are deleted from the channel memory.

- 1 Press **MENU**. The menu screen will appear.
- 2 Press **▲** or **▼** to select "Channel", then press **▶** or **ENTER**.
- 3 Press **▲** or **▼** to select "Add/Delete", then press **▶** or **ENTER**.
- 4 Press **▲** or **▼** to select "Clear All", then press **▶** or **ENTER**.



- 5 Press **EXIT** to return to the normal screen.

## TV operation

- 1 To turn on the TV, press **POWER**. (POWER indicator on the front of the unit changes green. It may take approx. 10 seconds for a picture to appear on screen.)
- 2 Adjust the volume level by pressing **VOL +** or **-**. The volume level will be indicated on the screen by blue bars. As the volume level increases, so do the number of bars. If the volume decreases, the number of blue bars also decreases.
- 3 Set the Signal Type option to the appropriate position (see "Air/Cable selection" on page 17).
- 4 Press the **Direct Channel Selection (0-9, -)** buttons to select the channel. (If you press only channel number, channel selection will be delayed for a few seconds.)

### TO SELECT ANALOG CHANNELS

- 1-9: Press 1-9 as needed. Example, to select channel 2, press **2**.
- 10-99: Press the 2 digits in order. Example, to select channel 12, press **1, 2**.
- 100-125: Press the 3 digits in order. Example, to select channel 120, press **1, 2, 0**.

### TO SELECT DIGITAL CHANNELS

Press the first 3 digits, then press the **-** button, followed by the remaining number.

- Example, to select channel 015-001, press **0, 1, 5, -, 1**.
- If a channel is selected with only audio content, "Audio only" will be displayed on the screen.
- If a channel is selected with a weak digital signal, "Digital channel signal strength is low" will be displayed on the screen. The same program may be available on either an analog channel or a digital channel. You may choose to watch either format.
- If a channel is selected to which you have not subscribed, "Digital channel is encrypted" will be displayed on the screen.

### VHF/UHF/CABLE CHANNELS

Air	Cable
VHF 2-13	VHF 2-13
UHF 14-69	STD/HRC/IRC 14-36 (A) (W) 37-59 (AA) (WW) 60-85 (AAA) (ZZZ) 86-94 (86) (94) 95-99 (A-5) (A-1) 100-125 (100) (125) 01 (5A)

**NOTE:**

- If a channel with no broadcast is selected, the sound will automatically be muted.
- It may take a few seconds for a digital channel picture to appear on screen after being selected.

**To select the video input source**

Press **INPUT SELECT**, then press **▲/▼** or corresponding **Number buttons (0-6)** to view a signal from another device connected to your LCD TV, such as a VCR or DVD player. You can select TV, Video1, Video2, Component, HDMI1, HDMI2 or PC depending on which input jacks you used to connect your devices.

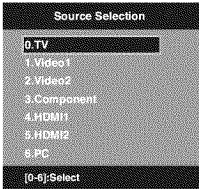

**CH + / -**

Press and release **CH + / -**. The channel automatically stops at the next channel set into memory.

For proper operation, before selecting channels, they should be set into the memory. See “Memorizing channels” on pages 17 and 18.

**DISPLAY**

Press **DISPLAY** to display the current information on the screen.

When the TV receives a digital signal, the digital information will appear.

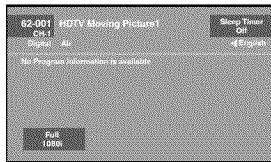

- Channel number
- Channel label (if preset)
- V-Chip rating
- Sleep timer
- Program guide
- Resolution
- Station name
- Broadcast program name
- Signal type
- Audio language
- Picture size

When the TV receives an analog signal, the analog information will appear.

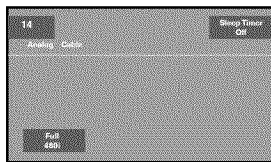

- Channel number
- Channel label (if preset)
- V-Chip rating
- Sleep timer
- Picture size
- Channel label (if preset)
- Signal type
- Audio information (Stereo or SAP)
- Resolution

Press **DISPLAY** again to clear the call display.

**NOTE:**

- After a few seconds, **DISPLAY** screen will return to normal TV-operation automatically.

**RECALL**

This button allows you to go back to the last channel selected by pressing **RECALL**. Press **RECALL** again to return to the last channel you were watching.

**MUTE**

Press **MUTE** to switch off the sound. The TV's sound will be silenced and “Mute” will appear on the screen. The sound can be switched back on by pressing this button again or the **VOL +** or **-**.

**SLEEP**

To set the TV to turn off after a preset amount of time, press **SLEEP** on the remote control. The clock will count up 10 minutes for each press of the **SLEEP** button (Off, 0h 10m, 0h 20m, ..., 2h 0m). After the sleep time is programmed, the display will appear briefly every ten minutes to remind you that the sleep timer is operating. To confirm the sleep timer setting, press **SLEEP** and the remaining time will be displayed for a few seconds. To cancel the sleep timer, press **SLEEP** repeatedly until the display turns to Off.

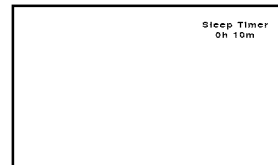

**Labeling channels**

Channel label appear with the channel number display each time you turn on the TV, select a channel, or press **DISPLAY**. You can choose any four characters to identify a channel.

**To create channel labels**

- 1 Press **MENU**, then press **▲** or **▼** to select “Channel” menu, then press **▶** or **ENTER**.
- 2 Press **▲** or **▼** to select “Ch Label”, then press **▶** or **ENTER**. The “Ch Label” menu will appear.
- 3 Press **◀** or **▶** to select a channel you want to label, then press **▼**.

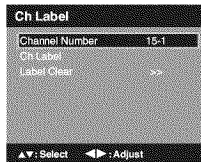

- 4 Press **◀** or **▶** repeatedly until the character you want appears in the first space.

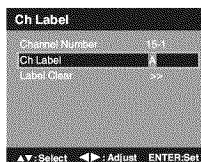

The characters rotation as follows:

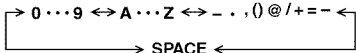

If the character which you desire appears, press **ENTER**.

Repeat this step to enter the rest of the characters.

If you would like a blank space in the label name, you must choose the empty space from the list of characters.

**5** When you finish inputting the label name, press **EXIT** to return to the normal screen.

**6** Repeat steps 1-5 for other channel. You can assign a label to each channel.

### To clear a Ch Label

After step 3 above, press **▲** or **▼** to select "Label Clear", then press **▶** or **ENTER**.

#### NOTE:

The channel labels will be reset after "Automatic Search" on page 17.

## Labeling video inputs

The Video Label feature allows you to label each input source for your TV.

- 1** Press **MENU**. The menu screen will appear.
- 2** Press **▲** or **▼** to select "Setup", then press **▶** or **ENTER**.
- 3** Press **▲** or **▼** to select "Video Label", then press **▶** or **ENTER**.
- 4** Press **▲** or **▼** to select an input which you want to label.
- 5** Press **◀** or **▶** to select the desired label for that input source.

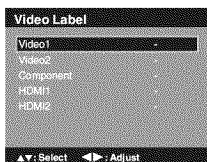

- : Uses the default label name
- VCR** : Video cassette recorder
- DVD** : DVD video
- DTV** : Digital TV set-top box
- SAT** : Satellite box
- CBL** : Cable box
- HD** : HDMI device (only for HDMI inputs)

**6** Press **EXIT** to return to the normal screen.

## Setting the V-Chip

An age limitation can be set to restrict children from viewing or hearing violent scenes or pictures that you may choose to exclude. The restriction applies to "TV Rating" and "Movie Rating" if this data is transmitted. You may set this restriction separately. To use the V-Chip function, you must register a password.

### To register a password

- 1** Press **MENU**. The menu screen will appear. Press **▲** or **▼** to select "Lock", then press **▶** or **ENTER**.
- 2** Select and enter your password (4 digits) using **Number buttons (0-9)**, then press **ENTER**.

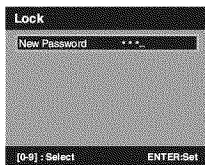

"\*" appears instead of the number.

- 3** Enter the same password again to confirm, then press **ENTER**. The password is now registered.

#### NOTE:

- If you forget the password, contact Customer Service at 1-800-289-0980 for assistance. Your original remote control will be required.
- To avoid forgetting the password, write it down and keep in a safe place.

### To set the V-Chip

- 1** Press **MENU**. Press **▲** or **▼** to select "Lock" menu, then press **▶** or **ENTER**.
- 2** Use **Number buttons (0-9)** to enter your password, then press **ENTER**. Then Lock menu will appear.
- 3** Press **▲** or **▼** to select "V-Chip", then press **◀** or **▶** to select "On".
- 4** Press **▲** or **▼** to select "V-Chip Set", then press **▶** or **ENTER**. The V-Chip Set Menu appears.
- 5** Press **▲** or **▼** to select which rating will be used, then press **▶** or **ENTER**. Each rating below will appear.

#### TV Rating

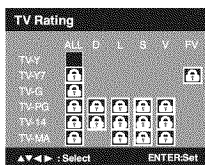

You can set the rating using age level and genre.

#### Age:

- TV-Y** : All children
- TV-Y7** : 7 years old and above
- TV-G** : General audience
- TV-PG** : Parental guidance
- TV-14** : 14 years old and above
- TV-MA** : 17 years old and above

#### Genre:

- ALL** : All
- D** : Dialogue
- L** : Language
- S** : Sex
- V** : Violence
- FV** : Fantasy Violence

## Movie Rating

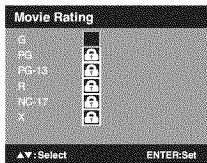

- G** : All ages  
**PG** : Parental guidance  
**PG-13** : Parental guidance less than 13 years old  
**R** : Under 17 years old parental guidance suggested  
**NC-17** : 17 years old and above  
**X** : Adult only

**6** Press ▲/▼/◀/▶ to select the desired rating, then press **ENTER**.

**7** Press **EXIT** to return to the normal screen. V-Chip function is activated now.

### To use the TV after the TV is protected.

When a program is received that is blocked by the V-Chip, press **MUTE**, then enter your password. The protection will be temporarily overridden. If the TV is turned off, the V-Chip restriction will be reactivated.

#### NOTE:

- The V-Chip function is activated only on programs and input sources that include a rating signal.

### To change the password

**1** Press **MENU**. The TV menu screen will appear. Press ▲ or ▼ to select "Lock", then press ▶ or **ENTER**.

**2** Use **Number buttons (0-9)** to enter your password, then press **ENTER**. The Lock menu will appear.

**3** Press ▲ or ▼ to select "Change Password", then press ▶ or **ENTER**. The Change Password screen will appear.

**4** Enter a new password using **Number buttons (0-9)**, then press **ENTER**.

**5** Enter the same password again to confirm, then press **ENTER**. The password is now registered.

### Downloading the additional V-Chip rating system

As a supplement to the standard V-Chip rating system, your television will be able to download an additional rating system, if such a system becomes available in the future.

### To download the additional V-Chip rating system (when available)

**1** Press **MENU** in the digital channel. Press ▲ or ▼ to select "Lock", then press ▶ or **ENTER**.

Use **Number buttons (0-9)** to enter your password, then press **ENTER**.

**2** Press ▲ or ▼ to select "V-Chip Set (DTV)", then press ▶ or **ENTER**.

**3** If the TV is not storing the additional rating system, the TV will begin downloading it, which may take some time to be completed.

**4** Set your preferred content rating limits for the additional rating system.

**5** You also need "Update" procedure to update rating information.

#### NOTE:

- You can only download the additional V-Chip rating system when your TV is receiving a digital signal.
- When you download the additional rating system, it may take some time for the download to occur.
- The V-Chip rating information and system are not determined or controlled by the TV.
- The standard V-Chip rating system is available whether your TV is receiving a digital signal or not, and will block both analog and digital programs. To set the restriction level using the standard V-Chip rating system, select V-Chip Set in step 2.
- The downloadable V-Chip rating system is an evolving technology, and availability, content, and format may vary.
- You cannot select this feature if the TV is not receiving a digital signal for the current station.

## Closed Caption

### WHAT IS CLOSED CAPTIONING?

This television has the capability to decode and display Closed Captioned television programs. Closed Captioning will display text on the screen for hearing impaired viewers or it will translate and display text in another language.

**Captions:** This Closed Caption Mode will display text on the screen in English or another language. Generally, Closed Captions in English are transmitted on C1 and Closed Captions in other languages are transmitted on C2.

**Text:** The Text Closed Caption Mode will usually fill 1/2 of the screen with a programming schedule or other information.

**1** Press **MENU**. Press ▲ or ▼ to select "Setup", then press ▶ or **ENTER**.

**2** Press ▲ or ▼ to select "Closed Caption", then press ▶ or **ENTER**. The Closed Caption menu will appear.

#### NOTE:

- Closed Caption menu screen also can be displayed by pressing **CCD** on the remote control.

**3** Press ▲ or ▼ to select "CC Setting", then press ◀ or ▶ to select "On".

**On:** Captions will be displayed on the screen.

**Off:** Captions will not be displayed on the screen.

4 Press ▲ or ▼ to select “Analog Caption” or “Digital Caption”.

When you select “Analog Caption”, you can choose C1, C2, C3, C4, T1, T2, T3 and T4.

When you select “Digital Caption”, you can choose from CS1, CS2, CS3, CS4, CS5 and CS6.

5 Press ◀ or ▶ to select the desired Closed Caption mode for both Digital and Analog Caption.

6 Press ▲ or ▼ to select “CC Priority”, then press ◀ or ▶ to select “Digital CC” or “Analog CC”.

**NOTE:**

- Depending on the broadcast signal, some Analog Captions will function with a Digital broadcast signal. This step prevent that two kind of captions are overlapping.

7 Press **EXIT** to return to the normal screen.

**NOTE:**

- If the program or video you selected is not closed-captioned, no captions will display on-screen.
- If text is not available in your viewing area, a black rectangle may appear on-screen. If this happens, set the CC Setting to “Off”.
- When selecting Closed Captions, the captioning will be delayed approx. 10 seconds.
- If no caption signal is received, no captions will appear, but the television will remain in the Caption Mode.
- Misspellings or unusual characters may occasionally appear during Closed Captioning. This is normal with Closed Captioning, especially with live programs. This is because during live programs, captions are also entered live. These transmissions do not allow time for editing.
- When Captions are being displayed, on-screen displays, such as volume and mute may be seen but may interfere with Closed Captions.
- Some cable systems and copy protection systems may interfere with the Closed Captioned signal.
- If using an indoor antenna or if TV reception is very poor, the Closed Caption Decoder may not appear or may appear with strange characters or misspelled words. In this case, adjust the antenna for better reception or use an outdoor antenna.

## CC advanced

When you have selected Custom as the display method, you can adjust the various setting listed below as follows:

This feature is designed to customize Digital Captions only.

1 Press **MENU**. The menu screen will appear.

2 Press ▲ or ▼ to select “Setup”, then press ▶ or **ENTER**.

3 Press ▲ or ▼ to select “Closed Caption”, then press ▶ or **ENTER**.

The Closed Caption menu will appear.

4 Press ▲ or ▼ to select “Digital CC Preset”, then press ◀ or ▶ to select “Custom”.

5 Press ▲ or ▼ to select “CC Advanced”, then press ▶ or **ENTER**.

The CC Advanced menu will appear.

6 Press ▲ or ▼ to select the desired item, then press ◀ or ▶ to change the setting.

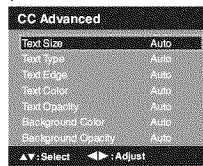

You can select from among the following items and parameters.

**Text Size:** Auto, Small, Standard, Large

**Text Type:** Auto, Style1, Style2, Style3, Style4, Style5, Style6, Style7

**Text Edge:** Auto, None, Raised, Depressed, Uniform, Left Shadow, Right Shadow

**Text Color:** Auto, Black, White, Red, Green, Blue, Yellow, Magenta, Cyan

**Text Opacity:** Auto, Solid, Transparent, Translucent, Flashing

**Background Color:** Auto, Black, White, Red, Green, Blue, Yellow, Magenta, Cyan

**Background Opacity:** Auto, Solid, Transparent, Translucent, Flashing

7 Press **EXIT** to return to the normal screen.

**NOTE:**

- Do not set the Closed Caption “Text Color” and “Background Color” as the same color or you will not be able to see the text.
- Do not set both the “Text Opacity” and the “Background Opacity” to “Transparent” or you will not be able to see the text.

## Adjusting the picture preference

You can select four picture modes—Sports, Standard, Movie and Memory—as described in the following table:

1 Press **MENU**. Then press ▲ or ▼ to select “Picture”, then press ▶ or **ENTER**.

2 Press ▲ or ▼ to select “Picture Preference”.

3 Press ◀ or ▶ to select a mode you want to adjust.

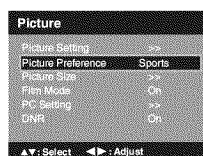

Mode	Picture Quality
<b>Sports</b>	Bright and dynamic picture (factory-set)
<b>Standard</b>	Standard picture quality (factory-set)
<b>Movie</b>	Movie-like picture setting (factory-set)
<b>Memory</b>	Your personal preferences (set by you; see "Picture control adjustment" below).

4 After your desired setting, press **EXIT** to return to the normal screen.

## Picture control adjustment

- 1 Press **MENU**. Then press **▲** or **▼** to select "Picture", then press **▶** or **ENTER**.
- 2 Press **▲** or **▼** to select "Picture Setting", then press **▶** or **ENTER**. The Picture Setting menu will appear.
- 3 Press **▲** or **▼** to select the item you want to adjust. Press **◀** or **▶** to adjust the setting.

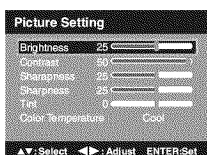

4 After adjusting, press **ENTER** to return to the Picture Setting menu. Then continue to adjust the other items.

	◀	▶
<b>Contrast</b>	decrease contrast	increase contrast
<b>Brightness</b>	decrease brightness	increase brightness
<b>Sharpness</b>	makes picture softer	makes picture clearer
<b>Color</b>	be pale color	be brilliant color
<b>Tint</b>	be reddish color	be greenish color

5 After your desired setting, press **EXIT** to return to the normal screen.

### NOTE:

- The Contrast default setting is set to maximum at the factory.

## Selecting the color temperature

1 Press **MENU**. Then press **▲** or **▼** to select "Picture", then press **▶** or **ENTER**.

2 Press **▲** or **▼** to select "Picture Setting", then press **▶** or **ENTER**.

The Picture Setting menu will appear.

3 Press **▲** or **▼** to select "Color Temperature", then press **◀** or **▶** to change the setting.

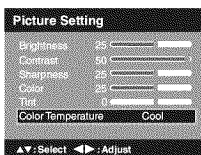

Setting	Picture Quality
<b>Cool</b>	Bluish
<b>Standard</b>	Neutral
<b>Warm</b>	Reddish

4 Press **EXIT** to return to the normal screen.

## Setting the picture size

You can view 480i and 480p format programs in a variety of picture sizes— Natural, Cinema Wide1, Cinema Wide2, Cinema Wide3 and Full.

### Selecting the picture size

- 1 Press **MENU**. Press **▲** or **▼** to select "Picture", then press **▶** or **ENTER**.
- 2 Press **▲** or **▼** to select "Picture Size", then press **▶** or **ENTER** to display Picture Size menu. Press **▲/▼** or corresponding **Number button (0-4)** to select the desired picture size, as described below and on the next page.

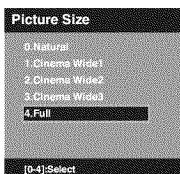

### NOTE:

- Selectable picture sizes may vary depending on the input source or broadcast signal.
- Picture Size menu also can be displayed by pressing **PICTURE SIZE** on the remote control.

3 Press **EXIT** to return to the normal screen.

### Natural picture size

In some cases, this image will display the size of standard 4:3 with a gray side bar.

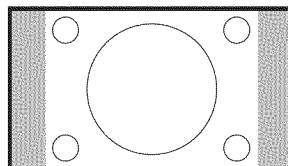

## Cinema Wide1 picture size (for 4:3 format programs)

To fill the screen, the right and left edges are extended, however; the center of the picture remains near its former ratio.

The top and bottom edges of the picture may be hidden.

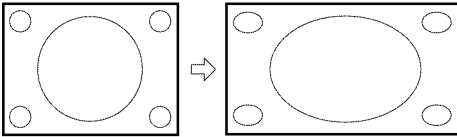

## Cinema Wide2 picture size (for letter box programs)

The entire picture is uniformly enlarged—it is stretched the same amount both wider and taller (retains its original proportion).

The top and bottom edges of the picture may be hidden.

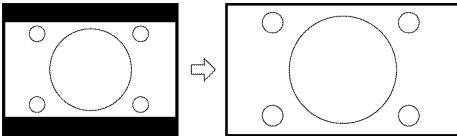

## Cinema Wide3 picture size (for letter box programs with subtitles)

To fill the width of the screen, it is extended horizontally. However; it is only slightly extended at the top and the bottom.

The top and bottom edges of the picture may be hidden.

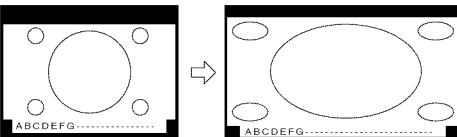

## Full picture size (for 16:9 source programs)

Full will display the picture at the maximum size.

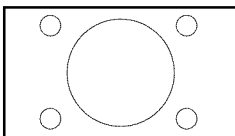

### NOTE:

- Some High Definition and/or Digital broadcasts may not allow you to change the picture size.
- In HDMI or COMPONENT mode with a scanning rate of 720p or 1080i, only the CINEMA WIDE2 and FULL PICTURE SIZE features are available.
- In PC Mode, only the Natural and Full picture size features are available. Additionally this feature will not work when display mode is WXGA.
- In Cinema Wide2 picture size, some of the on screen display items may be positioned off the visible portion of the screen.

## Film Mode

A smoother motion may be obtained by setting the Film Mode to "On" when you view a DVD from the DVD player connected with the component input.

- 1 Press **MENU**. The menu screen will appear.
- 2 Press **▲** or **▼** to select "Picture", then press **▶** or **ENTER**.
- 3 Press **▲** or **▼** to select "Film Mode". Press **◀** or **▶** to select "On" or "Off".

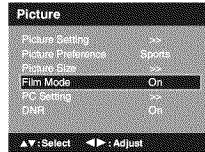

- 4 Press **EXIT** to return to the normal screen.

## Picture control adjustment in the PC mode

You can adjust to optimize the performance of the TV in the PC mode.

- 1 Press **INPUT SELECT**, then press **▲/▼** or **Number button (6)** to select the PC mode.
- 2 Press **MENU**. Then press **▲** or **▼** to select "Picture", then press **▶** or **ENTER**.
- 3 Press **▲** or **▼** to select "PC Setting", then press **▶** or **ENTER**.

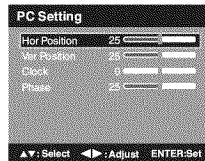

- 4 Press **▲** or **▼** to select the desired item you want to adjust.
- 5 Press **◀** or **▶** to adjust the setting.

- Hor Position:** To adjust the horizontal position of the image on the PC mode.
- Ver Position:** To adjust the vertical position of the image on the PC mode.
- Clock:** To minimize any vertical bars or stripes visible on the screen background.
- Phase:** This must be adjusted after the frequency of the PC mode has been set to 60Hz to optimize picture quality (page 16).



6 After adjusting, press **ENTER** to return to the PC Setting menu. Then continue to adjust the other items.

7 Press **EXIT** to return to the normal screen.

#### NOTE:

- If no buttons are pressed for more than approx. 60 seconds, the Menu-screen will return to normal Monitor-screen automatically.
- The PC settings are not effective for other input modes.

## DNR

**DNR (Digital Noise Reduction) can reduce the roughness of the picture. (This function is available only for analog broadcast.)**

- 1 Press **MENU**. Then press **▲** or **▼** to select "Picture", then press **▶** or **ENTER**.
- 2 Press **▲** or **▼** to select "DNR". Press **◀** or **▶** to select "On" or "Off".

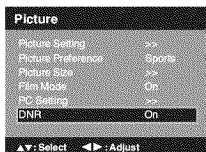

3 Press **EXIT** to return to the normal screen.

## Sound control adjustment

- 1 Press **MENU**. Then press **▲** or **▼** to select "Audio", then press **▶** or **ENTER**.
- 2 Press **▲** or **▼** to select the item you want to adjust.

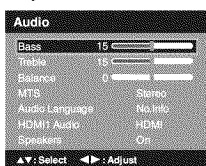

- Bass:** Press **◀** or **▶** to adjust the bass sound.
- Treble:** Press **◀** or **▶** to adjust the treble sound.
- Balance:** Press **◀** or **▶** to obtain an equal sound level from both speakers.

- Press **▲** or **▼** to change the adjusting item.

3 After you desired setting, press **EXIT** to return to the normal screen.

## Selecting Stereo/Second Audio Program (SAP)

The multi-channel TV sound (MTS) feature provides high-fidelity stereo sound. MTS also can transmit a second audio program (SAP) containing a second language or other audio information.

When the TV receives a stereo or SAP broadcast, the word "Stereo" or "SAP" displays on-screen every time you press **DISPLAY**.

1 Press **MENU**. Then press **▲** or **▼** to select "Audio", then press **▶** or **ENTER**.

2 Press **▲** or **▼** to select "MTS", then press **◀** or **▶** to select "Stereo".



3 Press **EXIT** to return to the normal screen.

#### NOTE:

- Generally you can leave your TV in stereo mode because the TV automatically outputs the type of sound being broadcast (stereo or mono).
- If the stereo sound is noisy, select "Mono" to reduce the noise.

**To listen to a second audio program (SAP)**

Press **◀** or **▶** to select "SAP" in step 2 above. The TV speakers will output the second audio program instead of normal audio.

## Selecting the audio language

When two or more audio languages are included in a digital signal, you can select one of the audio language.

1 Press **MENU**. Then press **▲** or **▼** to select "Audio", then press **▶** or **ENTER**.

2 Press **▲** or **▼** to select "Audio Language", then press **▶** or **ENTER** to display the Audio Language menu.

3 Press **▲/▼** or **Number buttons (0-6)** to select your desired language.

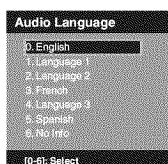

4 Press **EXIT** to return to the normal screen.

# Selecting the HDMI audio input source

When you use PC/HDMI-1 AUDIO IN jacks with HDMI or DVI device, you must select HDMI audio input source from "HDMI" or "DVI".

- 1 Press **MENU**. The menu screen will appear.
- 2 Press **▲** or **▼** to select "Audio", then press **▶** or **ENTER**.
- 3 Press **▲** or **▼** to select "HDMI1 Audio". Press **◀** or **▶** to select "HDMI" or "DVI".

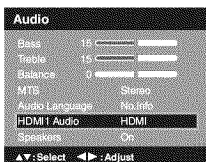

- HDMI:** When you connect the HDMI device to the TV, select this setting.
- DVI:** When you connect the DVI device to the TV with analog audio cords, select this setting.

- 4 Press **EXIT** to return to the normal screen.

# Turning off the built-in speakers

Use this feature to turn the TV speakers off when you connect an audio system (see pages 16).

- 1 Press **MENU**. The menu screen will appear.
- 2 Press **▲** or **▼** to select "Audio", then press **▶** or **ENTER**.
- 3 Press **▲** or **▼** to select "Speakers". Press **◀** or **▶** to select "Off".



- 4 Press **EXIT** to return to the normal screen.

**To turn on the built-in speakers:**  
Select "On" in step 3 above.

# Adjusting the back lighting

The Backlight feature adjusts the screen brightness for improved picture clarity.

- 1 Press **MENU**. The menu screen will appear.
- 2 Press **▲** or **▼** to select "Setup", then press **▶** or **ENTER**.
- 3 Press **▲** or **▼** to select "Backlight".



- 4 Press **◀** or **▶** to adjust the setting.
- 5 Press **EXIT** to return to the normal screen.

# Setting the Auto Shut Off

If the Auto Shut Off feature is On, a station being viewed stops broadcasting and the TV is not operated, the TV will automatically shut itself off after 15 minutes.

- 1 Press **MENU**. The menu screen will appear.
- 2 Press **▲** or **▼** to select "Setup", then press **▶** or **ENTER**.
- 3 Press **▲** or **▼** to select "Auto Shut Off". Press **◀** or **▶** to select "On" or "Off".

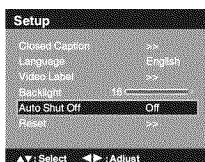

- 4 Press **EXIT** to return to the normal screen.

# Resetting your settings

The Reset function returns your settings to the factory settings.

- 1 Press **MENU**. Then press **▲** or **▼** to select "Setup", then press **▶** or **ENTER**.
- 2 Press **▲** or **▼** to select "Reset".



- 3 Press **▶** or **ENTER** to return your settings to the factory settings.
- 4 "Reset" will appear on the screen approx. 3 seconds, then it returns to the normal screen.

**NOTE:**

- You also can reset the settings by pressing **RESET** when "Picture" and "Audio" menu is displayed.

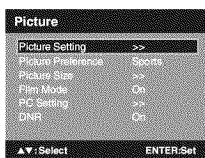

# Reception disturbances

Most types of television interference can be remedied by adjusting the height and position of the VHF/ UHF antenna. Outdoor antennas are recommended for best results. The most common types of television interference are shown below. If one of these symptoms appear when the TV is connected to a Cable TV system, the disturbance may be caused by the local Cable TV company broadcast.

## IGNITION

Black spots or horizontal streaks may appear, the picture may flutter or drift. Usually caused by interference from automobile ignition systems, neon lamps or AC powered tools and appliances such as drills or hair dryers.



## GHOSTS

Ghosts are caused by the television signal following two paths. One is the direct path and the other is reflected by tall buildings, hills or other large objects. Changing the direction or position of the antenna may improve the reception.



## SNOW

If the TV is located far from the TV station, in a fringe reception area where the signal is weak, small dots may appear in the picture. If the signal is extremely weak, the installation of a larger external antenna may be necessary.

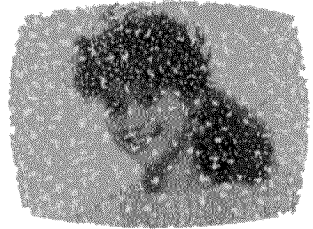

## RADIO FREQUENCY INTERFERENCE (RFI)

Caused by two-way radios, this type of interference produces moving ripples or diagonal streaks in the picture. Some cases may cause a loss of contrast in the picture. Changing the direction and position of the antenna or installing an RFI filter may improve the picture.

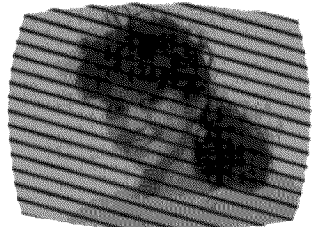

## PICTURE SIZE VARIATION

A slight picture size variation is normal when you adjust the CONTRAST or BRIGHTNESS settings.



## CARE AND MAINTENANCE

To prevent fire or shock hazard, disconnect the TV from the power source before cleaning. The finish on the cabinet may be cleaned with mild soap and a soft, damp cloth and cared for as other furniture. Use caution when cleaning or wiping the plastic parts.

# Troubleshooting

Use the following checklist for troubleshooting if you have problems with your LCD TV. Consult your local dealer or service outlet if problems persist. Be sure all connections are properly made when using with other units.

SYMPTOMS	POSSIBLE SOLUTIONS
TV does not operate.	<ul style="list-style-type: none"> <li>• Make sure the power cord is plugged in.</li> <li>• Try another AC outlet.</li> <li>• Power is off, check fuse or circuit breaker.</li> <li>• Unplug unit for an hour, then plug it back in.</li> </ul>
Poor sound or no sound.	<ul style="list-style-type: none"> <li>• Station or Cable TV experiencing problems, tune to another station.</li> <li>• Check sound adjustments (Volume and Mute).</li> <li>• Check for sources of possible interference.</li> <li>• Check Speakers of the menu.</li> </ul>
Poor picture or no picture.	<ul style="list-style-type: none"> <li>• Station or Cable TV experiencing problems, tune to another station.</li> <li>• Make sure channels are set into memory.</li> <li>• Check antenna or Cable TV connections, adjust antenna.</li> <li>• Check for sources of possible interference.</li> <li>• Check picture control adjustments.</li> </ul>
Poor reception on some channels.	<ul style="list-style-type: none"> <li>• Station or Cable TV experiencing problems, tune to another station.</li> <li>• Make sure channels are set into memory.</li> <li>• Station is weak, adjust antenna to receive desired station.</li> <li>• Check for sources of possible interference.</li> </ul>
Poor color or no color.	<ul style="list-style-type: none"> <li>• Station or Cable TV experiencing problems, tune to another station.</li> <li>• Make sure channels are set into memory.</li> <li>• Check picture control adjustments.</li> <li>• Check antenna or Cable TV connections, adjust antenna.</li> <li>• Check for sources of possible interference.</li> </ul>
Picture wobbles or drifts.	<ul style="list-style-type: none"> <li>• Station or Cable TV experiencing problems, tune to another station.</li> <li>• Make sure channels are set into memory.</li> <li>• Cable TV company is scrambling signal.</li> <li>• Adjust antenna.</li> </ul>
Digital broadcasting screen problem.	<ul style="list-style-type: none"> <li>• Check digital signal strength.</li> </ul>

SYMPTOMS	POSSIBLE SOLUTIONS
No CATV reception.	<ul style="list-style-type: none"> <li>• Check all Cable TV connections.</li> <li>• Set Signal type option to the Cable mode.</li> <li>• Station or Cable TV system problems, try another station.</li> </ul>
Horizontal or diagonal bars on screen.	<ul style="list-style-type: none"> <li>• Check antenna connections, adjust or re-direct antenna.</li> <li>• Check for sources of possible interference.</li> </ul>
No reception above channel 13.	<ul style="list-style-type: none"> <li>• Make sure Signal Type option is in the appropriate mode.</li> <li>• If using antenna, check UHF antenna connections.</li> </ul>
No Remote operation.	<ul style="list-style-type: none"> <li>• Batteries are weak, dead or inserted incorrectly.</li> <li>• Remote is out of range, move closer to TV (within 15 feet).</li> <li>• Make sure Remote is aimed at sensor.</li> <li>• Confirm there are no obstructions between the Remote and the TV.</li> <li>• Make sure the power cord is plugged in.</li> </ul>
TV shuts off.	<ul style="list-style-type: none"> <li>• Sleep Timer is set.</li> <li>• Power interrupted.</li> </ul>
Closed - Caption is not activated.	<ul style="list-style-type: none"> <li>• TV station experiencing problems or program tuned is not closed captioned. Try another channel.</li> <li>• Check Cable TV connection or VHF/UHF antenna, reposition or rotate antenna.</li> <li>• Set closed caption decoder in the menu.</li> </ul>
TV is not shown in your language.	<ul style="list-style-type: none"> <li>• Select proper language in the menu options.</li> </ul>



FOR CUSTOMER SERVICE, ADDITIONAL SET-UP OR OPERATING ASSISTANCE PLEASE CALL:

1-800-289-0980

**WHEN CALLING CUSTOMER SERVICE – PLEASE HAVE YOUR MODEL NUMBER READY**

OR WRITE TO:  
**ORION SALES, INC.**  
 3471 N. UNION DR.  
 OLNEY, ILLINOIS 62450

FOR INFORMATION ON OUR OTHER PRODUCTS, PLEASE VISIT OUR WEBSITE AT  
[www.orionsalesinc.com](http://www.orionsalesinc.com)

# Specifications

---

Power supply:	AC 120 V 60 Hz
Power consumption:	Operation: 175 W Stand by: 1 W
Weight:	50.7 lbs (23.0 kg)
Dimensions:	Width: 37-3/8 inches (949 mm) Height: 27-3/8 inches (695 mm) Depth: 13-1/16 inches (332.5 mm)
Inputs:	VIDEO: 1 V (p-p)/75 ohms AUDIO: -8 dBm/50k ohms S-VIDEO: Y: 1 V (p-p), 75 ohms C: 0.286 V (p-p), 75 ohms COMPONENT: Y: 1 V (p-p), 75 ohms PR: 0.7 V (p-p), 75 ohms PB: 0.7 V (p-p), 75 ohms HDMI: HDMI compliant (type A connector) HDCP compliant E-EDID compliant Suggested scan rates: 1080i, 480p, 720p HDMI Audio: 2-channel PCM 32/44.1/48 kHz sampling frequency 16/20/24 bits per sample
PC MONITOR:	Mini-Dsub 15pin x 1
Outputs: Digital audio out:	0.5 Vp-p 75 ohms terminated
Variable audio out:	0-600mV/1k ohms
PC/HDMI AUDIO:	3.5ø mm Stereo jack
Type:	37.02 inches (940.3 mm diagonal)
Number of Pixels:	1366 (H) x 768 (V)
Viewing angle:	Left/Right: 89/89 degree Up/Down: 89/89 degree
Antenna input:	VHF/UHF/CABLE In 75 ohm coaxial
Tuner type:	NTSC standard ATSC standard (8VSB), QAM
Receiving channels:	VHF 2-13 UHF 14-69 CABLE 14-36 (A)-(W) 37-59 (AA)-(WW) 60-85 (AAA)-(ZZZ) 86-94 (86)-(94) 95-99 (A-5)-(A-1) 100-125 (100)-(125) 01 (5A)
Speaker:	2-3/16 inches (56 mm) x 5 inches (127 mm), 8 ohms x 2
Sound output power:	5 W + 5 W
<b>ACCESSORIES:</b>	Remote control Batteries (UM-3) x 2 AC Cord

**Designs and specifications are subject to change without notice.**



## LIMITED WARRANTY

### 37" WIDE LCD TELEVISION

ORION warrants this product to be free from manufacturing defects in material and workmanship under normal use and conditions for a period of 1 year from date of original purchase in the United States.

Should service be necessary under this warranty for any reason due to a manufacturing defect or malfunction during the first 12 months from date of original purchase, ORION will provide in-home repair service by an ORION authorized Independent Service Center at no charge. Also, if an original part fails due to manufacturing defect in material and workmanship within one year from date of original purchase we will replace the defective part, provided the defect or malfunction is verified along with dated proof of purchase.

There are ORION authorized Independent Service Centers located throughout the country. For the one nearest you, DIAL TOLL FREE: 1-800-289-0980 or visit our website at [www.orionsalesinc.com](http://www.orionsalesinc.com). ORION will not be liable for damages incurred in shipment of the unit. If there are no ORION authorized Independent Service Centers in your area please call - 1-888-296-7466 for assistance.

**Note: This warranty is void if the product is:**

- (a) Damaged through negligence, misuse, abuse, or accident.
- (b) Used in a commercial application or rentals.
- (c) Modified or repaired by anyone other than an Independent Service Center authorized by ORION to effect warranty repairs to the class of product or by the ORION Factory Service Center.
- (d) Damaged because it is improperly connected to the equipment of other manufacturers.

**This warranty does not cover:**

- (a) Damage to equipment not properly connected to the product.
- (b) Costs incurred in the shipping of the product to an ORION authorized Independent Service Center or ORION Factory Service Center.
- (c) Damage or improper operation of unit caused by customer abuse, misuse, negligence, or failure to follow operating instructions provided with the product.
- (d) Ordinary adjustments to the product which can be performed by customer as outlined in the owner's manual.
- (e) Signal reception problems caused by external antenna or cable systems.

THIS WARRANTY IS NON TRANSFERABLE AND APPLIES ONLY TO THE ORIGINAL PURCHASER AND DOES NOT EXTEND TO SUBSEQUENT OWNERS OF THE PRODUCT. ANY APPLICABLE IMPLIED WARRANTIES, INCLUDING THE WARRANTY OF MERCHANTABILITY, ARE LIMITED IN DURATION TO A PERIOD OF THE EXPRESS WARRANTY AS PROVIDED HEREIN BEGINNING WITH THE DATE OF ORIGINAL PURCHASE AT RETAIL AND NO WARRANTIES, WHETHER EXPRESS OR IMPLIED SHALL APPLY TO THIS PRODUCT THEREAFTER. ORION MAKES NO WARRANTY AS TO THE FITNESS OF THE PRODUCT FOR ANY PARTICULAR PURPOSE AND USE.

UNDER NO CIRCUMSTANCES SHALL ORION BE LIABLE FOR ANY LOSS, DIRECT, INDIRECT, INCIDENTAL, SPECIAL, OR CONSEQUENTIAL DAMAGE ARISING OUT OF OR IN CONNECTION WITH THE USE OF THIS PRODUCT.

THIS WARRANTY IS VALID ONLY IN THE UNITED STATES OF AMERICA. THIS WARRANTY GIVES YOU SPECIFIC LEGAL RIGHTS, HOWEVER, YOU MAY HAVE OTHER RIGHTS WHICH MAY VARY FROM STATE TO STATE. SOME STATES DO NOT ALLOW LIMITATION ON IMPLIED WARRANTIES OR EXCLUSION OF CONSEQUENTIAL DAMAGE, THEREFORE THESE RESTRICTIONS MAY NOT APPLY TO YOU.

**ORION SALES, INC.**  
3471 N. UNION DR.  
OLNEY, ILLINOIS 62450

---

A series of horizontal dotted lines for writing.



J35A0101A SH 08/03

Printed in Thailand