

OWNER'S MANUAL

 **SANSUI**®

**32" WIDE TFT LCD TELEVISION  
WITH DIGITAL TUNER**

**HDLCD3200**

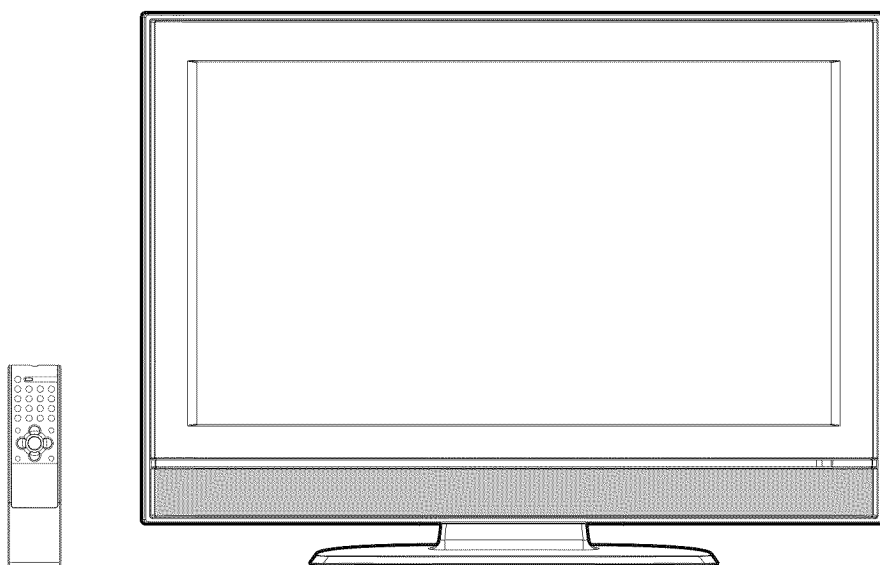

**ATTENTION**

If you purchase a universal remote control from your local retailer, please contact the remote manufacturer for the required programming code.

**TV/CABLE MODE SELECTION**

When shipped from the factory, the TV/CABLE menu option is set to the "CABLE" (Cable Television) mode. If not using Cable TV, set this menu option to the "TV" position.



IF CONTACT WITH CUSTOMER SERVICE IS REQUIRED  
PLEASE HAVE THE MODEL NUMBER READY PRIOR TO THE CALL  
**CUSTOMER SERVICE – 1-800-289-0980**

**ORION WEBSITE**

FOR INFORMATION ON OUR OTHER PRODUCTS, PLEASE VISIT OUR WEBSITE AT

**[www.orionsalesinc.com](http://www.orionsalesinc.com)**

Before operating the unit, please read this manual thoroughly.

	<b>CAUTION</b> RISK OF ELECTRIC SHOCK DO NOT OPEN	
<b>CAUTION:</b> TO REDUCE THE RISK OF ELECTRIC SHOCK, DO NOT REMOVE COVER (OR BACK). NO USER-SERVICEABLE PARTS INSIDE. REFER SERVICING TO QUALIFIED SERVICE PERSONNEL.		



The lightning flash with arrowhead symbol, within an equilateral triangle is intended to alert the user to the presence of uninsulated dangerous voltage within the product's enclosure that may be of sufficient magnitude to constitute a risk of electric shock.



The exclamation point within an equilateral triangle is intended to alert the user to the presence of important operating and maintenance (servicing) instructions in the literature accompanying the appliance.

<b>WARNING:</b> TO PREVENT FIRE OR SHOCK HAZARD, DO NOT EXPOSE THIS APPLIANCE TO RAIN OR MOISTURE.
<b>CAUTION:</b> TO PREVENT ELECTRIC SHOCK DO NOT USE THIS POLARIZED PLUG WITH AN EXTENSION CORD, RECEPTACLE OR OTHER OUTLET UNLESS THE BLADES CAN BE FULLY INSERTED TO PREVENT BLADE EXPOSURE.

**WARNING:** This equipment has been tested and found to comply with the limits for a Class B digital device, pursuant to Part 15 of the FCC Rules. These limits are designed to provide reasonable protection against harmful interference in a residential installation. This equipment generates, uses and can radiate radio frequency energy and, if not installed and used in accordance with the instructions, may cause harmful interference to radio communications. However, there is no guarantee that interference will not occur in a particular installation. If this equipment does cause harmful interference to radio or television reception, which can be determined by turning the equipment off and on, the user is encouraged to try to correct the interference by one or more of the following measures:

- Reorient or relocate the receiving antenna.
- Increase the separation between the equipment and receiver.
- Connect the equipment into an outlet on a circuit different from that to which the receiver is connected.
- Consult the dealer or an experienced radio/TV technician for help.

**CAUTION:** Changes or modifications not expressly approved by the party responsible for compliance with the FCC Rules could void the user's authority to operate this equipment.

**Location of the required Marking**

The rating sheet and the safety caution are on the rear of the unit.

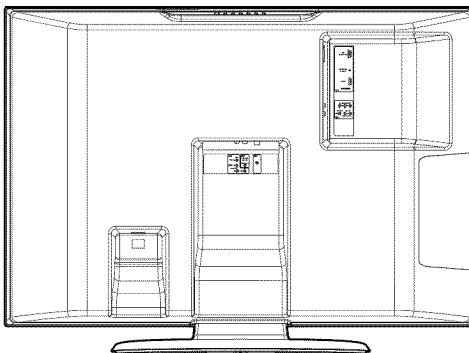

# IMPORTANT SAFETY INSTRUCTIONS

---

- 1) Read these instructions.
- 2) Keep these instructions.
- 3) Heed all warnings.
- 4) Follow all instructions.
- 5) Do not use this apparatus near water.
- 6) Clean only with dry cloth.
- 7) Do not block any ventilation openings. Install in accordance with the manufacturer's instructions.
- 8) Do not install near any heat sources such as radiators, heat registers, stoves, or other apparatus (including amplifiers) that produce heat.
- 9) Do not defeat the safety purpose of the polarized or grounding-type plug. A polarized plug has two blades with one wider than the other. A grounding type plug has two blades and a third grounding prong. The wide blade or the third prong are provided for your safety. If the provided plug does not fit into your outlet, consult an electrician for replacement of the obsolete outlet.
- 10) Protect the power cord from being walked on or pinched particularly at plugs, convenience receptacles, and the point where they exit from the apparatus.
- 11) Only use attachments/accessories specified by the manufacturer.
- 12) Use only with the cart, stand, tripod, bracket, or table specified by the manufacturer, or sold with the apparatus. When a cart is used, use caution when moving the cart/apparatus combination to avoid injury from tip-over.
- 13) Unplug this apparatus during lightning storms or when unused for long periods of time.
- 14) Refer all servicing to qualified service personnel. Servicing is required when the apparatus has been damaged in any way, such as power-supply cord or plug is damaged, liquid has been spilled or objects have fallen into the apparatus, the apparatus has been exposed to rain or moisture, does not operate normally, or has been dropped.
- 15) Apparatus shall not be exposed to dripping or splashing and that no objects filled with liquids, such a vases, shall be placed on the apparatus.
- 16) An outside antenna system should not be located in the vicinity of overhead power lines or other electric light or power circuits, or where it can fall into such power lines or circuits. When installing an outside antenna system, extreme care should be taken to keep from touching such power lines or circuits, as contact with them might be fatal.
- 17) Do not overload wall outlets and extension cords, as this can result in a risk of fire or electric shock.
- 18) Do not push objects through any openings in this unit, as they may touch dangerous voltage points or short out parts that could result in fire or electric shock. Never spill or spray any type of liquid into the unit.

PORTABLE CART WARNING  
(symbol provided by RETAC)



**S3126A**

# IMPORTANT SAFETY INSTRUCTIONS

- 19) If an outside antenna or cable system is connected to the unit, be sure the antenna or cable system is grounded to provide some protection against voltage surges and built-up static charges, Section 810 of the National Electrical Code, ANSI/NFPA 70, provides information with respect to proper grounding of the mast and supporting structure, grounding of the lead-in wire to an antenna discharge unit, size of grounding conductors, location of antenna discharge unit, connection to grounding electrodes, and requirements for the grounding electrode.

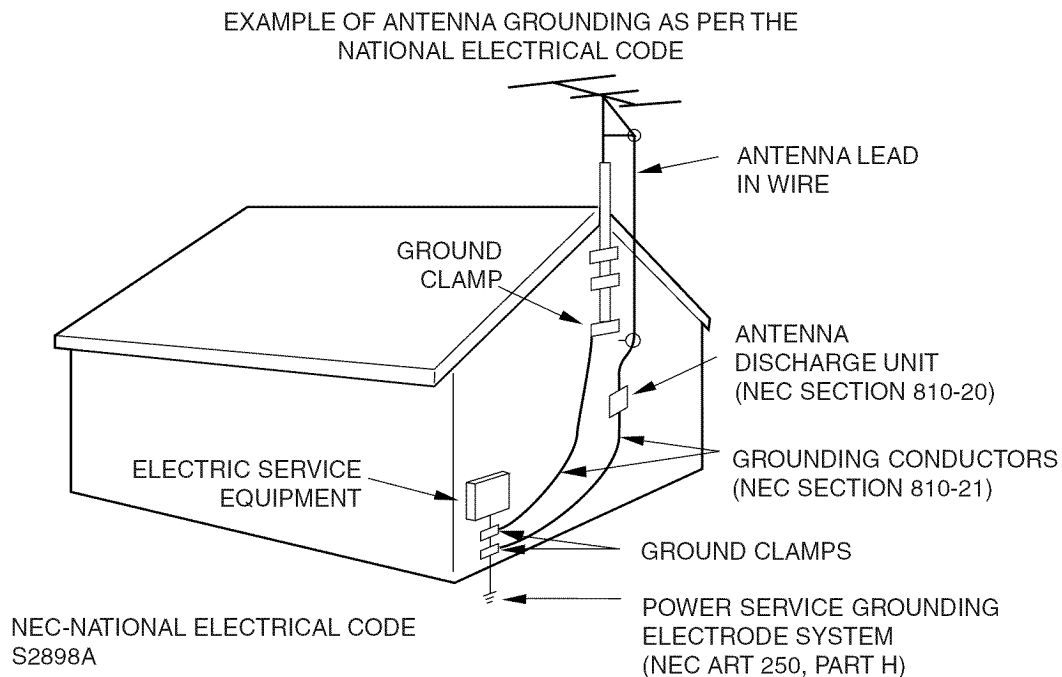

- 20) When replacement parts are required, be sure the service technician uses replacement parts specified by the manufacturer or those that have the same characteristics as the original part. Unauthorized substitutions may result in fire, electric shock or other hazards.
- 21) Upon completion of any service or repairs to this unit, ask the service technician to perform safety checks to determine that the unit is in proper operating condition.
- 22) When you connect the product to other equipment, turn off the power and unplug all of the equipment from the wall outlet. Failure to do so may cause an electric shock and serious personal injury. Read the owner's manual of the other equipment carefully and follow the instructions when making any connections.
- 23) Reduce the volume to the minimum level before you turn on the product. Otherwise, sudden high volume sound may cause hearing or speaker damage.
- 24) Do not allow the product to output distorted sound for an extended period of time. It may cause speaker overheating and fire.
- 25) This reminder is provided to call the cable TV system installer's attention to Article 820-40 of the NEC that provides guidelines for proper grounding and, in particular, specifies that the cable ground shall be connected to the grounding system of the building, as close to the point of cable entry as practical.

# IMPORTANT SAFETY INSTRUCTIONS

## CONDENSATION

Moisture will form in the operating section of the player if the player is brought from cool surroundings into a warm room or if the temperature of the room rises suddenly. When this happens, player's performance will be impaired. To prevent this, let the player stand in its new surroundings for about an hour before switching it on, or make sure that the room temperature rises gradually.

Condensation may also form during the summer if the player is exposed to the breeze from an air conditioner. In such cases, change the location of the player.

## HOW TO HANDLE THE LCD PANEL

- Do not press hard or jolt the LCD panel. It may cause the LCD panel glass to break and injury may occur.
- If the LCD panel is broken, make absolutely sure that you do not touch the liquid in the panel. This may cause skin inflammation.  
If the liquid gets in your mouth, immediately gargle and consult with your doctor. Also, if the liquid gets in your eyes or touches your skin, consult with your doctor after rinsing for at least 15 minutes or longer in clean water.

**Possible Adverse Effects on LCD Panel:** If a fixed (non-moving) pattern remains on the LCD Panel for long periods of time, the image can become permanently engraved in the LCD Panel and cause subtle but permanent ghost images. This type of damage is NOT COVERED BY YOUR WARRANTY. Never leave your LCD Panel on for long periods of time while it is displaying the following formats or images:

- Fixed Images, such as stock tickers, video game patterns, TV station logos, and websites.
- Special Formats that do not use the entire screen. For example, viewing letterbox style (16:9) media on a normal (4:3) display (black bars at top and bottom of screen); or viewing normal style (4:3) media on a widescreen (16:9) display (black bars on left and right sides of screen).

**The following symptoms are not signs of malfunction but technical limitation. Therefore we disclaim any responsibility for these symptoms.**

- LCD Panel are manufactured using an extremely high level of precision technology, however sometimes parts of the screen may be missing picture elements or have luminous spots.  
This is not a sign of a malfunction.
- Do not install the LCD Panel near electronic equipment that is susceptible to electromagnetic waves. Some equipment placed too near this unit may cause interference.
- Effect on infrared devices – There may be interference while using infrared devices such as infrared cordless headphones.

# SAFETY PRECAUTIONS

The unit emits heat when in operation. Do not place any covers or blankets on the unit, this may cause overheating. Do not block ventilation holes, or set up near radiators. Do not place in direct sunshine. When placing on a shelf leave 10 cm (4 inches) free space around the entire unit.

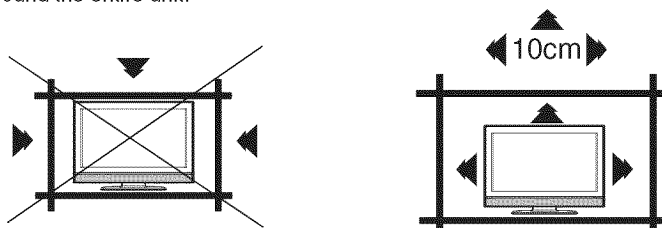

## Notes when mounting the LCD TV on a wall

- When installing the unit on a wall, allow at least 6 cm (2 1/2 inches) clearance between the rear of the LCD TV and the wall. Clearance of less than 6 cm (2 1/2 inches) will obstruct the vents and may cause the interior of the unit to overheat, resulting in damage to the unit.
- If the unit is to be mounted on the wall, contact the retailer where you purchased the LCD TV for advice, and have the equipment professionally installed. Incomplete or improper installation may cause injury to you and/or the LCD TV.
- Bracket holes: To attach a wall mounting bracket (not supplied) here, remove the screws.

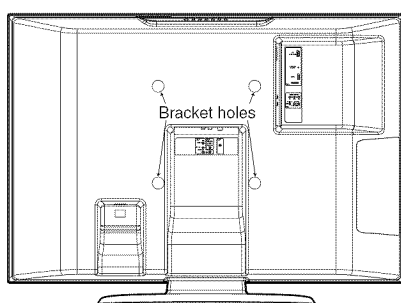

# Contents

---

## PREPARATIONS

IMPORTANT SAFETY INSTRUCTIONS .....	3
SAFETY PRECAUTIONS .....	5
Contents .....	6
Features .....	7
Power source .....	7
Parts and functions .....	8
Remote control .....	9
Antenna connections .....	10
Cable TV connections .....	11
Connections to other equipment .....	12
Setting the language .....	17

## OPERATION

Memorizing channels .....	18
TV operation .....	20
Labeling channels .....	22
Selecting the video input source .....	23
Labeling the video input source .....	23
Setting the V-Chip .....	24
Closed Caption .....	27
CC advanced .....	28
Setting the picture size .....	29
Setting the picture scroll .....	31
Selecting the cinema mode .....	32
Using the aspect feature .....	32
Adjusting the picture preference .....	33
Picture control adjustment .....	33
Selecting the color temperature .....	34
Adjusting the backlighting .....	34
Resetting your picture adjustments .....	35
Selecting Stereo/Second Audio Program (SAP) .....	36
Sound control adjustment .....	36
Selecting the HDMI audio input source .....	37
Selecting the audio language .....	37
Selecting the digital output .....	38
Resetting your audio adjustments .....	38
Checking the Digital-signal strength .....	39
Setting the auto shut off .....	40
Picture/Audio control adjustment in the PC mode .....	41

## OTHERS

Reception disturbances .....	43
Troubleshooting .....	44
Specifications .....	45
LIMITED WARRANTY .....	46

- **Integrated Digital Tuner** - You can view digital broadcasting without using a Digital TV Set-Top Box.
- **Closed Caption Decoder With Full Text Mode** - Displays text captions or full screen text on the screen for hearing impaired viewers.
- **Picture Adjustments Using The Remote Control** - The On-Screen display allows precise remote control adjustment of BRIGHTNESS, CONTRAST, COLOR, TINT and SHARPNESS.
- **Programmable TV Sleep Timer** - Operable from the remote control, the LCD TV can be programmed for up to 120 minutes to turn off automatically.
- **V-Chip** - The V-Chip function can read the rating of a broadcast program or movie content if the program is encoded with this information. V-chip will allow you to set a restriction level.
- **Digital Audio Jack (Coaxial)** - When a component with a built-in Dolby Digital decoder is connected, Dolby Digital sound can produce the effect of being in a movie theater or a concert hall.
- **S-Video/Component Video Jacks** - A VCR, DVD player, satellite receiver or other audio/video component can be connected to this unit.
- **Video Input Jacks** - This unit is equipped 3 types of video input jacks. The component video in jacks and S-video in jack enable you to watch the DVD player or the video devices with high quality picture.
- **On-Screen 3 Language Display** - You can select one of 3 languages, English, Spanish or French for on-screen programming.

\* Manufactured under license from Dolby Laboratories. "Dolby" and the double-D symbol are trademarks of Dolby Laboratories.

## Power source

### TO USE AC POWER

1. Connect the AC cord plug into this unit's AC IN jack.
2. Connect the AC cord into an AC outlet.

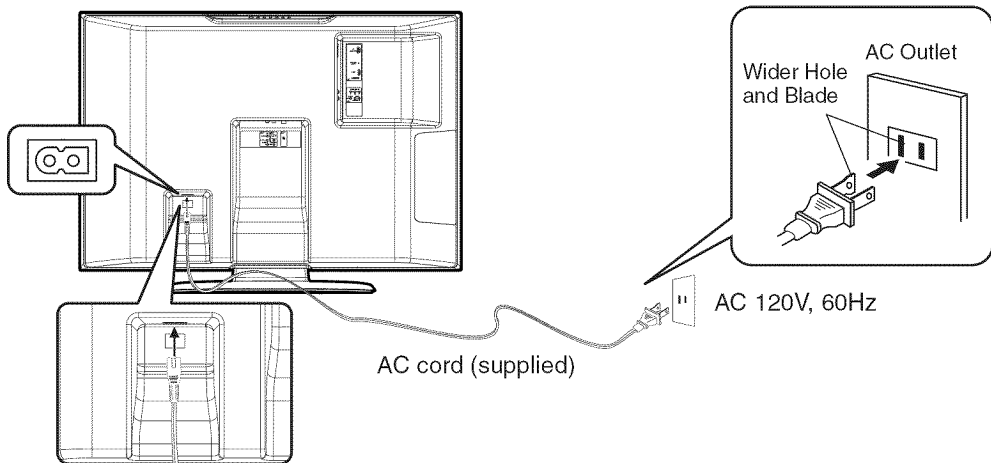

### NOTES:

- Please make sure to insert the cord securely at both the LCD TV and the wall outlet.
- The AC cord has a grounding-type AC line plug. If the supplied AC cord does not match your AC outlet, contact a qualified electrician, do not defeat the purpose of a grounding plug.

### WARNING:

- DO NOT CONNECT THIS UNIT TO THE POWER USING ANY DEVICE OTHER THAN THE SUPPLIED AC CORD. THIS COULD CAUSE FIRE, ELECTRICAL SHOCK, OR DAMAGE.
- DO NOT USE WITH A VOLTAGE OTHER THAN THE POWER VOLTAGE DISPLAYED. THIS COULD CAUSE FIRE, ELECTRICAL SHOCK, OR DAMAGE.

### CAUTION:

- WHEN THIS UNIT IS NOT USED FOR A LONG TIME, (E.G., AWAY ON A TRIP) IN THE INTEREST OF SAFETY, BE SURE TO UNPLUG IT FROM THE AC OUTLET.
- DO NOT PLUG/UNPLUG THE PLUG WHEN YOUR HANDS ARE WET. THIS MAY CAUSE ELECTRICAL SHOCK.
- IF YOU NEED TO REPLACE THE SUPPLIED AC ADAPTER OR AC CORD, THE SPECIFIED ONE IS RECOMMENDED. CONTACT CUSTOMER SERVICE AT 1-800-289-0980.

# Parts and functions

## Top

CHANNEL ▲/▼ buttons  
VOLUME +/- buttons  
MENU button  
INPUT button  
POWER button

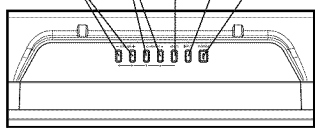

To display the menu screen.  
Press MENU button to display the menu screen.  
CHANNEL ▲/▼ buttons and VOLUME +/- buttons can be used to select the desired setting during the menu screen operations.

## Front

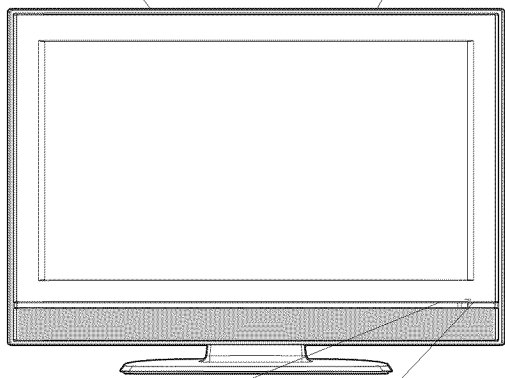

Remote sensor

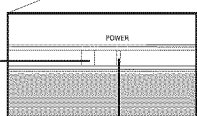

POWER indicator

## Rear

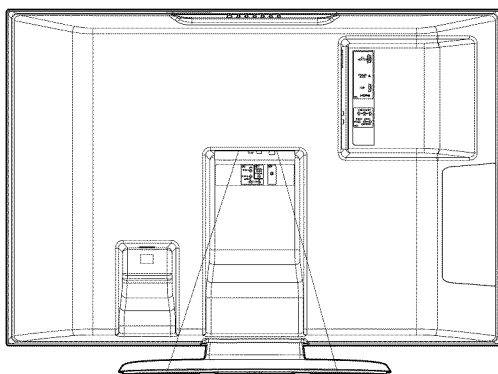

COAXIAL DIGITAL AUDIO OUT jack

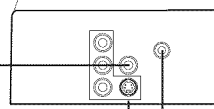

RF (ANT) IN jacks  
AV1 IN jacks

## Left side

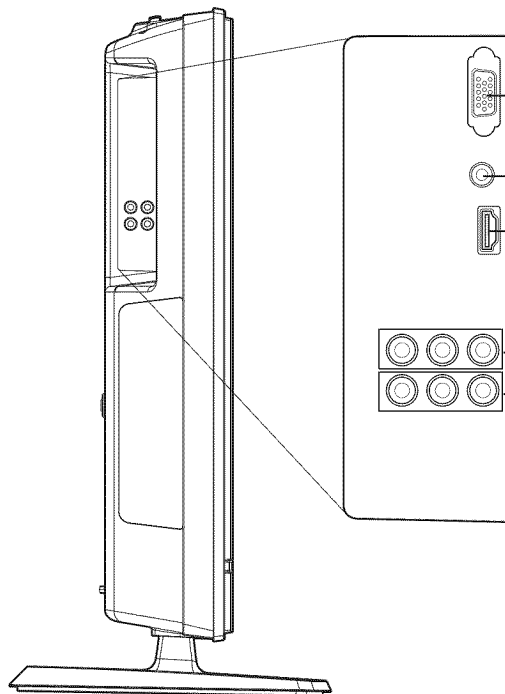

PC IN jacks

PC/HDMI AUDIO IN jacks

HDMI IN jacks

COMPONENT IN jacks

AV2 IN jacks



# Remote control

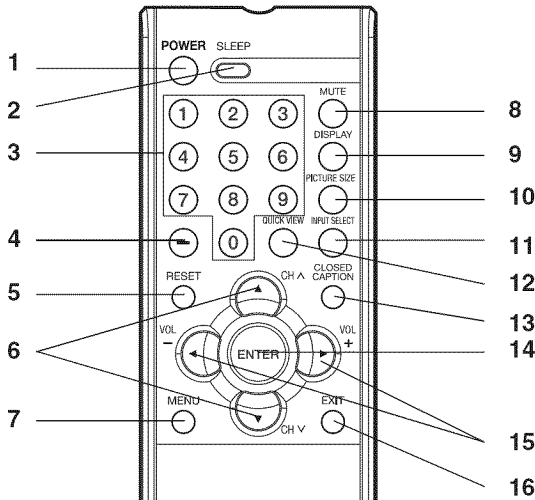

- 1. POWER Button** - Used to turn the LCD TV.
- 2. SLEEP Button** - To set the LCD TV to turn off after a preset amount of time, use the SLEEP button on the remote control.
- 3. Direct Channel Selection Buttons (0-9)** - Allows direct access to any channel of the LCD TV.
- 4. - Button** - This button is the “-” button used when selecting digital channels.
- 5. RESET Button** - Press to reset the On-Screen picture adjustments to their factory preset positions.
- 6. CH (CHANNEL) ^ / v / CURSOR ▲ / ▼ Buttons** - Used to operate the menu functions of the LCD TV, and to change the channels of the LCD TV.

- 7. MENU Button** - Use to display the On-Screen menu function.
- 8. MUTE Button** - To turn off the sound, press this button once. The LCD TV will be silenced and the symbol “MUTE” will appear on the screen. The muting feature can be released by pressing the MUTE button again or one of the VOL (VOLUME) + or - buttons.
- 9. DISPLAY Button** - When you press this button, the current information will be displayed on a screen. To remove the display from the screen, press this button again.
- 10. PICTURE SIZE Button** - Press to display PICTURE SIZE menu.
- 11. INPUT SELECT Button** - Press to display SOURCE SELECTION menu.
- 12. QUICK VIEW Button** - This button allows you to go back to the previous channel selected by just pressing the QUICK VIEW button. Press this button again to return to the channel you were watching.
- 13. CLOSED CAPTION Button** - Displays text captions or full screen text on the screen for hearing impaired viewers.
- 14. ENTER Button** - Use to enter or select information for On-Screen operations.
- 15. VOL (VOLUME) + / - / CURSOR ◀ / ▶ Buttons** - Used to operate the menu functions of the LCD TV. Press the ▶ button to increase, or the ◀ button to decrease the sound level.
- 16. EXIT Button** - Press to remove setup menu.

Before using the remote control, batteries must first be installed.

## HOW TO INSTALL BATTERIES

1. Open the battery compartment cover.

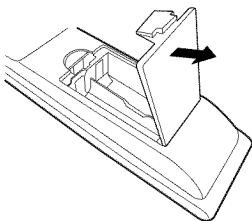

2. Install two “AA” batteries (supplied).

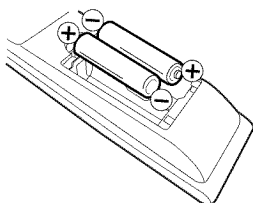

3. Replace the battery compartment cover.

Use two “AA” size batteries. The batteries may last approximately one year depending on how much the remote control is used. For best performance, it is recommended that batteries should be replaced on a yearly basis, or when the remote operation becomes erratic. Do not mix old and new batteries or different types.

## BATTERY PRECAUTIONS

These precautions should be followed when using batteries in this device:

- Use only the size and type of batteries specified.
- Be sure to follow the correct polarity when installing the batteries as indicated in the battery compartment. Reversed batteries may cause damage to the device.
- Do not mix different types of batteries together (e.g. Alkaline and Carbon-zinc) or old batteries with fresh ones.
- If the device is not to be used for a long period of time, remove the batteries to prevent damage or injury from possible battery leakage.
- Do not try to recharge batteries not intended to be recharged; they can overheat and rupture. (Follow battery manufacturer's directions.)

# Antenna connections

If you are using an indoor or outdoor antenna, follow the instructions below that correspond to your antenna system. If you are using a Cable TV service, see page 11 for Cable TV connections.

## Combination VHF/UHF Antenna (Single 75 ohm cable or 300 ohm twin-lead wire)

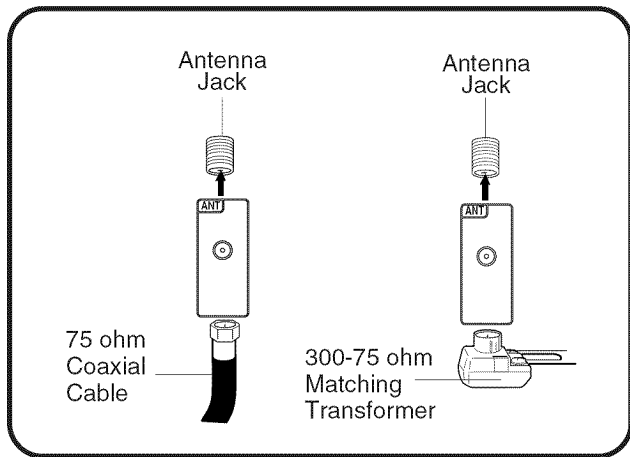

Connect the 75 ohm cable from the combination VHF/UHF antenna to the antenna jack.

If your combination VHF/UHF antenna has a 300 ohm twin-lead wire, the use of the 300-75 ohm matching transformer may be necessary.

## Combination VHF/UHF Antenna (Separate VHF and UHF 300 ohm twin-lead wires)

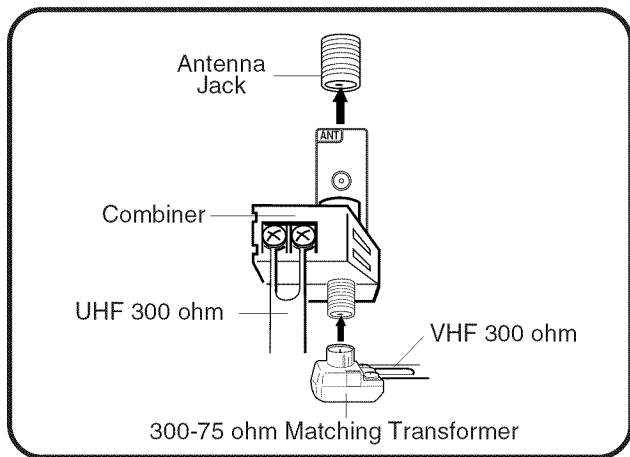

Connect the UHF 300 ohm twin-lead wire to the Combiner (not supplied). Connect the VHF 300 ohm twin-lead wire to the 300-75 ohm Matching Transformer. Attach the Transformer to the Combiner, then attach the Combiner to the Antenna Jack.

## Separate VHF/UHF Antennas (75 ohm VHF cable and 300 ohm UHF twin-lead wires)

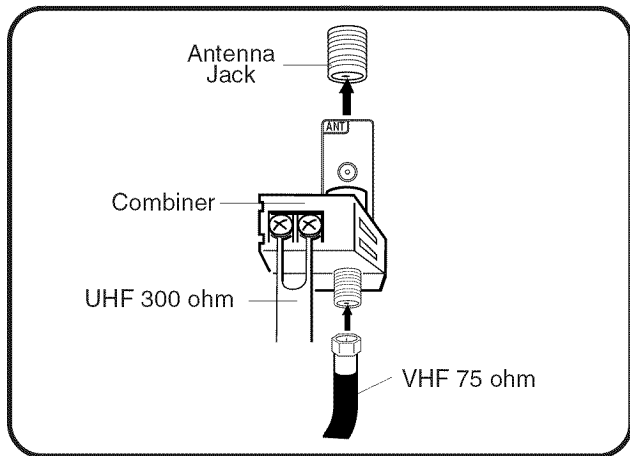

Connect the VHF 75 ohm cable and UHF 300 ohm twin-lead wire to the Combiner (not supplied). Attach the Combiner to the Antenna Jack.

# Cable TV connections

This TV has an extended tuning range and can tune most cable channels without using a Cable TV Converter box. Some cable companies offer “premium pay channels” where the signal is scrambled. Descrambling these signals for normal viewing requires the use of a descrambler device which is generally provided by the Cable TV company.

## FOR SUBSCRIBERS TO BASIC CABLE TV SERVICE

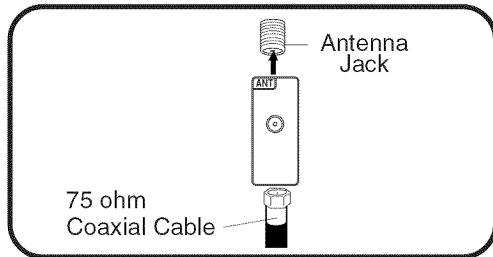

For basic Cable TV service not requiring a Converter/Descrambler box, connect the 75 ohm Coaxial Cable directly to the Antenna Jack on the back of the TV.

## FOR SUBSCRIBERS TO SCRAMBLED CABLE TV SERVICE

If you subscribe to a Cable TV service which requires the use of a Converter/Descrambler box, connect the incoming 75 ohm Coaxial Cable to the Converter/Descrambler box. Using another 75 ohm Coaxial Cable, connect the output jack of the Converter/Descrambler box to the Antenna Jack on the TV. Follow the connections shown below. Set the TV to the output channel of the Converter/Descrambler box (usually channel 3 or 4) and use the Converter/Descrambler box to select channels.

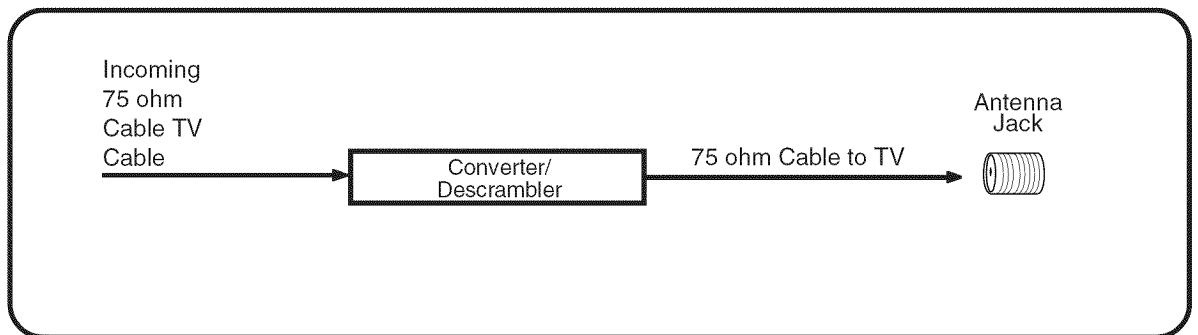

## FOR SUBSCRIBERS TO UNSCRAMBLED BASIC CABLE TV SERVICE WITH SCRAMBLED PREMIUM CHANNELS

If you subscribe to a Cable TV service in which basic channels are unscrambled and premium channels require the use of a Converter/Descrambler box, you may wish to use a signal Splitter and an A/B Switch box (available from the Cable TV company or an electronics supply store). Follow the connections shown below. With the switch in the “B” position, you can directly tune any unscrambled channels on your TV. With the switch in the “A” position, tune your TV to the output of the Converter/Descrambler box (usually channel 3 or 4) and use the Converter/Descrambler box to tune scrambled channels.

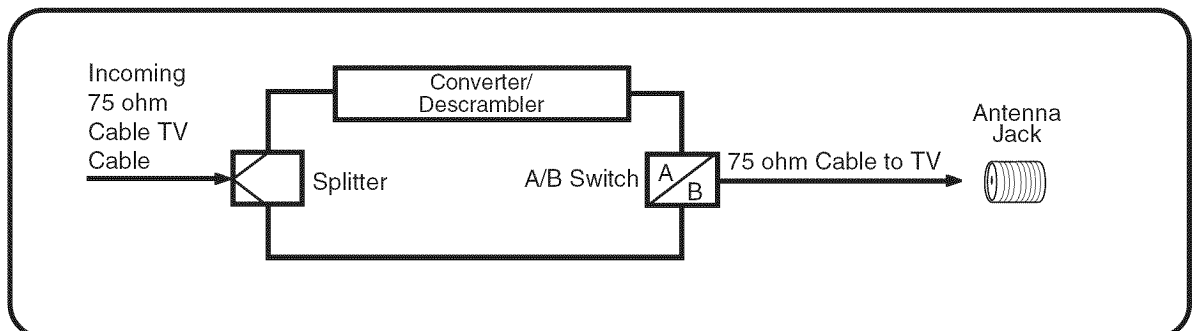

# Connections to other equipment

The exact arrangement you use to interconnect various video and audio components to the LCD TV is dependent on the model and features of each component. Check the Owner's Manual provided with each component for the location of video and audio inputs and outputs.

The connection diagrams below are offered as suggestions. You may need to modify them to accommodate your particular assortment of components. The diagrams are intended to show component video and audio interconnections only.

## To connect the LCD TV to a VCR

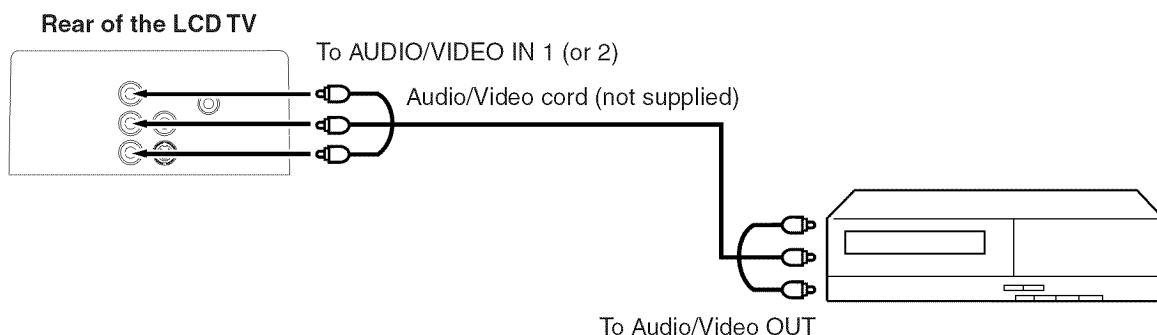

## To connect the LCD TV to a VCR with an S-Video cord

If you connect a VCR with a S-VIDEO cord to the S-VIDEO IN jack on the rear of the LCD TV, you must also connect the audio cords to the AUDIO IN jacks on the rear of the LCD TV. The S-VIDEO cord only carries the video signal. The audio signal is separate.

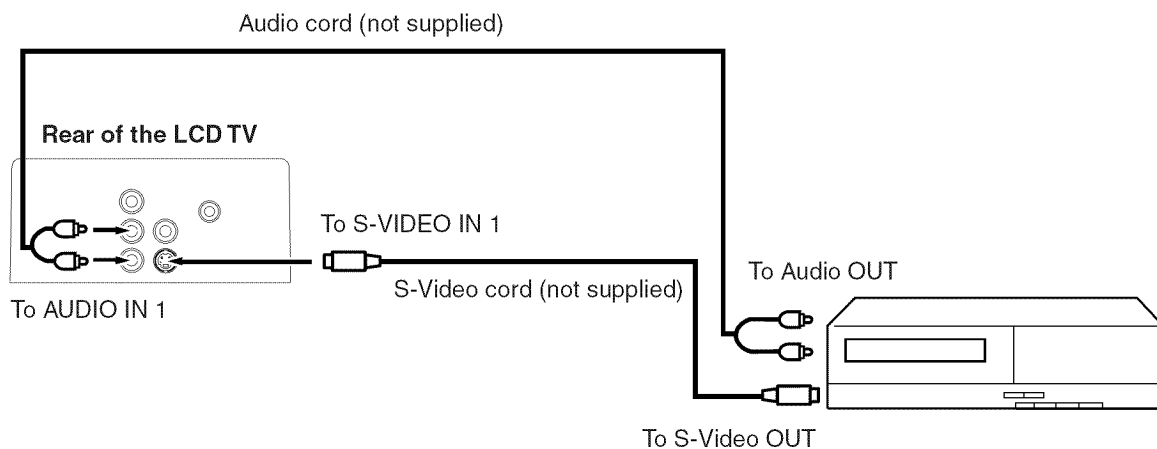

### NOTE:

When the S-video cord and the video cord are connected to each jack at the same time, the S-video cord takes precedence over the video cord.

# Connections to other equipment

## To connect the LCD TV to a DVD player/Satellite receiver

If your DVD player or Satellite receiver has a S-Video out jack, connect cords as shown.

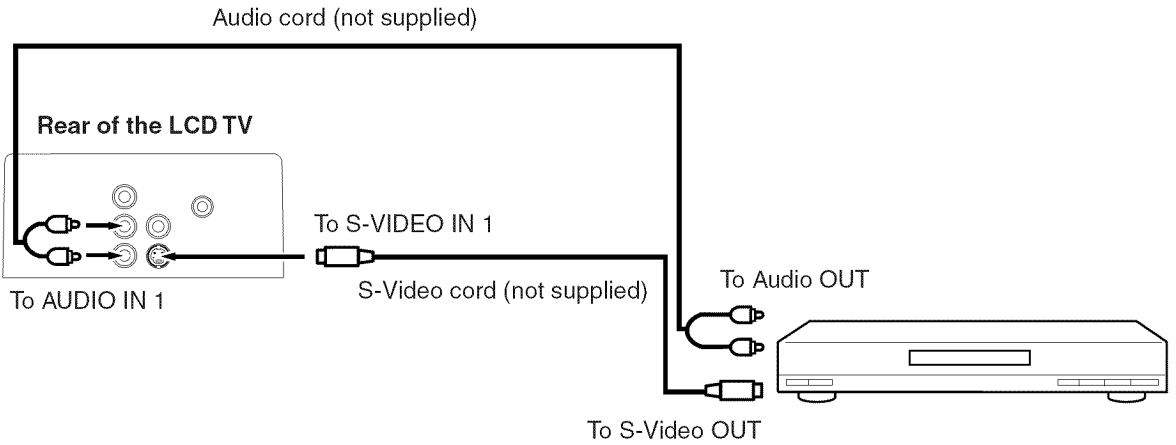

## To connect the LCD TV to a DVD player with component video

If your DVD player has component video out jacks, connect your LCD TV to a DVD player using a component video cord. It can greatly enhance picture quality and performance.

### Left side of the LCD TV

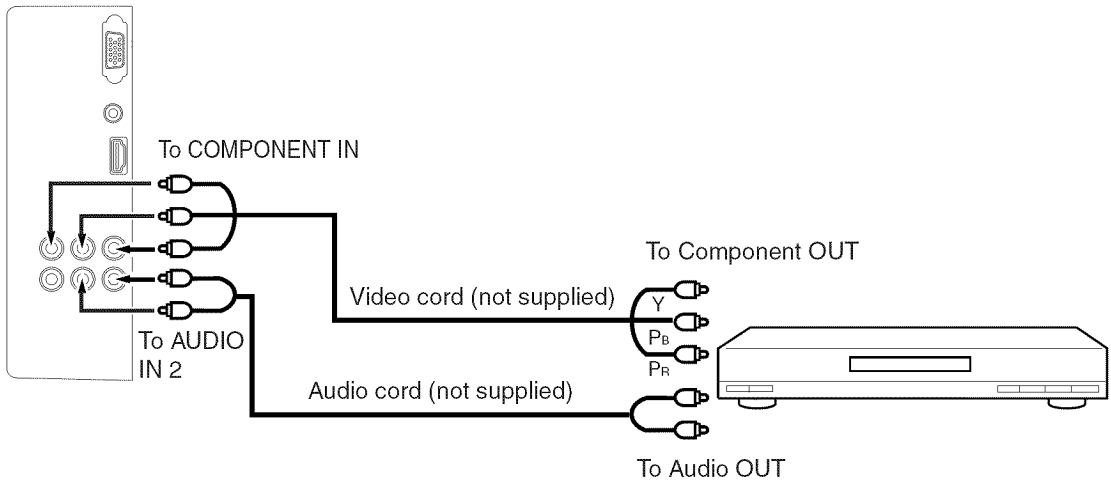

### NOTE:

Component Video inputs of the unit are for use with a device which outputs 480i/1080i interlaced signals and 480p/720p progressive signals.

# Connections to other equipment

## To connect the LCD TV to a DTV receiver/set-top box

If you connect a DTV receiver/set-top box, connect your LCD TV to a DTV receiver/set-top box using a component video cord.

### Left side of the LCD TV

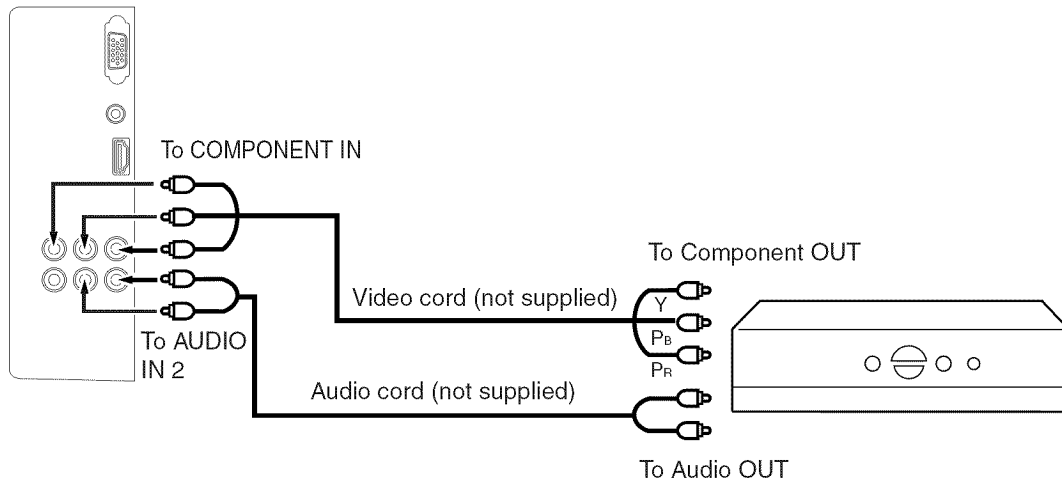

## To connect the LCD TV to a HDMI or a DVI device

The HDMI input receives digital audio and uncompressed video from a HDMI device or uncompressed digital video from a DVI device.

When you connect to a DVI device with a HDMI-to-DVI adapter cable, it transfers only the video signal. Separate analog audio cords are required.

### Left side of the LCD TV

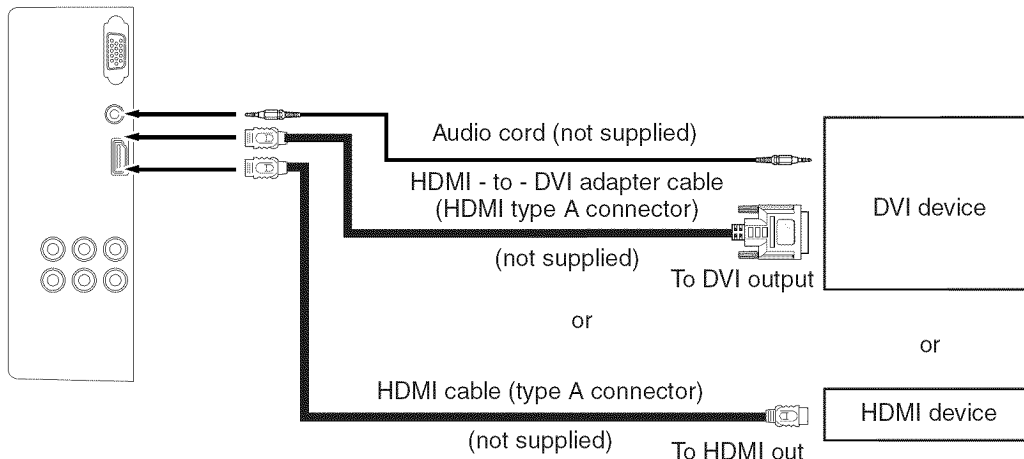

### NOTE:

You must choose an appropriate setting for each connection (see "Selecting the HDMI audio input source" on page 37).

# Connections to other equipment

## Using an AV Amplifier with built-in digital surround

If you are using an Amplifier with built-in digital surround sound, you can enjoy various audio systems including Dolby Digital Surround audio that sounds just like the movie.

Connect an AV amplifier with built-in Dolby Digital decoder, or etc. as shown below.

### Left side of the LCD TV

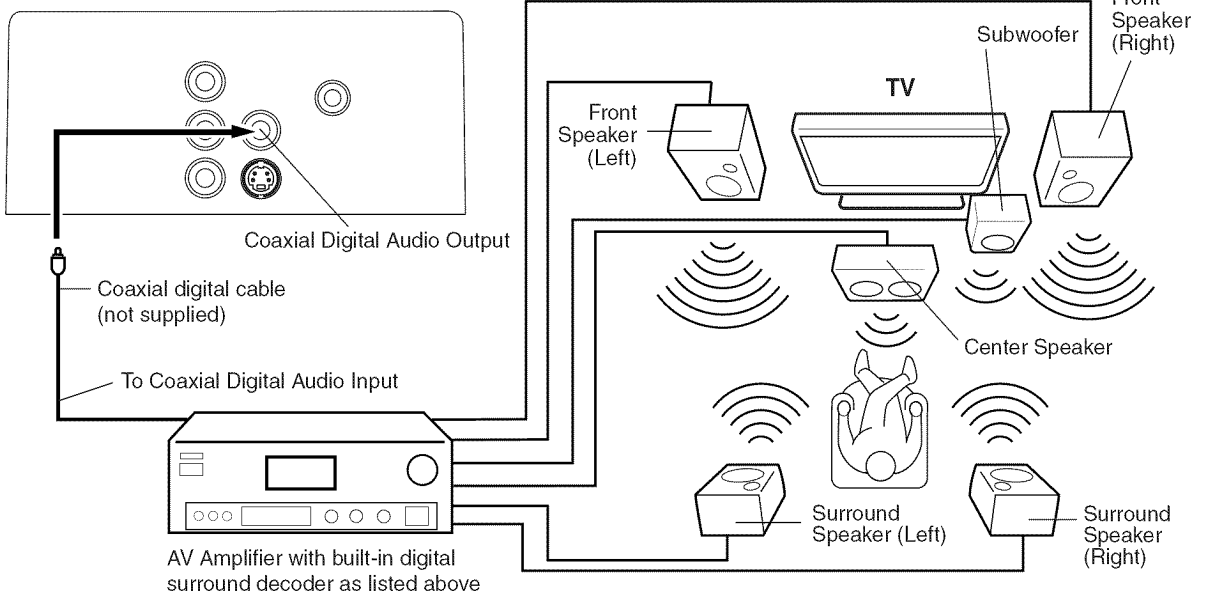

### NOTE:

This unit will not work in conjunction with DTS audio. There will be no sound output if connected to an AV amplifier with a built-in DTS decoder.

## To connect the LCD TV to a camcorder

To playback from a camcorder, connect the camcorder to the LCD TV as shown.

### Left of the LCD TV

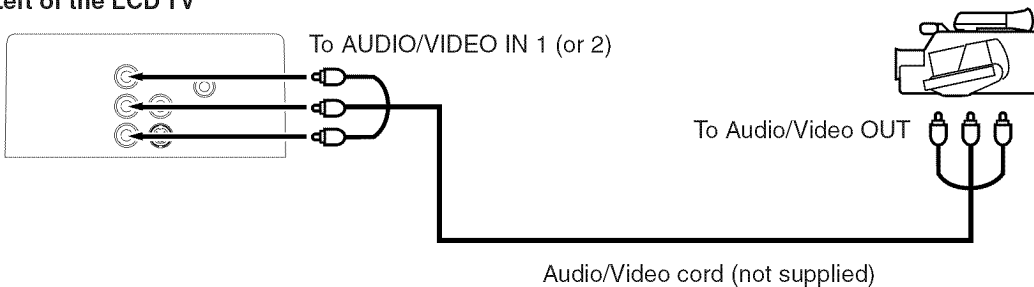

# Connections to other equipment

## To connect the LCD TV to a Game

The LCD TV can also be used as a TV device for many video games. However, due to the wide variety of signals generated by these devices and subsequent hook-up variations required, they have not all been included in the suggested connection diagrams. You'll need to consult each component's Owner's Manual for additional information.

### Rear of the LCD TV

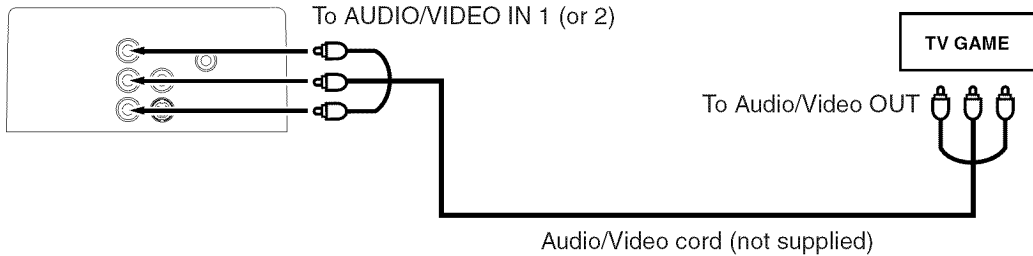

## To connect the LCD TV to a PC (Personal Computer)

Before you connect this LCD TV to your PC, change the adjustment of your PC's Resolution and Refresh rate (60 Hz).

Connect one end of a (male to male) VGA cable to the video card of the computer and the other end to the VGA connector PC MONITOR on the back of the LCD TV. Attach the connectors firmly with the screws on the plug. In case of a Multimedia computer, connect the audio cord to the audio output of your Multimedia computer and to the AUDIO connector of the PC/HDMI AUDIO IN jacks of the LCD TV.

Press **INPUT SELECT** on the remote control to select PC mode.

Switch on the computer. The LCD TV can operate as the computer monitor.

### Left side of the LCD TV

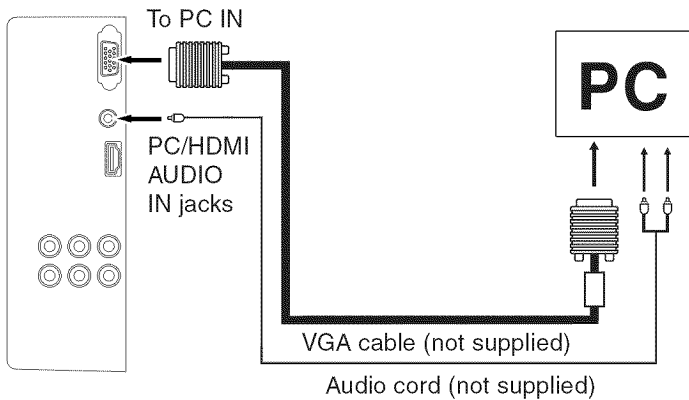

### Monitor Display modes

MODE	Resolution	Refresh rate
VGA	640x480	60Hz
VGA	720x400	70Hz
WVGA	848x480	60Hz
SVGA	800x600	60Hz
XGA	1024x768	60Hz
WXGA	1280x768	60Hz
WXGA	1280x720	60Hz

### To return to normal mode

Press **INPUT SELECT** again.

### NOTES:

- The on-screen displays will have a different appearance in PC mode than in TV mode.
- When you select WXGA or WVGA mode, see the WXGA INPUT to ON in the PC PICTURE menu (see page 41).
- If there is no video signal from the PC when the unit is in PC mode, "NO SIGNAL" will appear on the TV-screen for approx. 10 seconds.



# Setting the language

You can choose from three different languages (English, French and Spanish) for the on-screen displays. On-screen language selection (step 3) will automatically appear on the screen when you press MENU initially. Select the language you prefer first, then proceed with the other menu options.

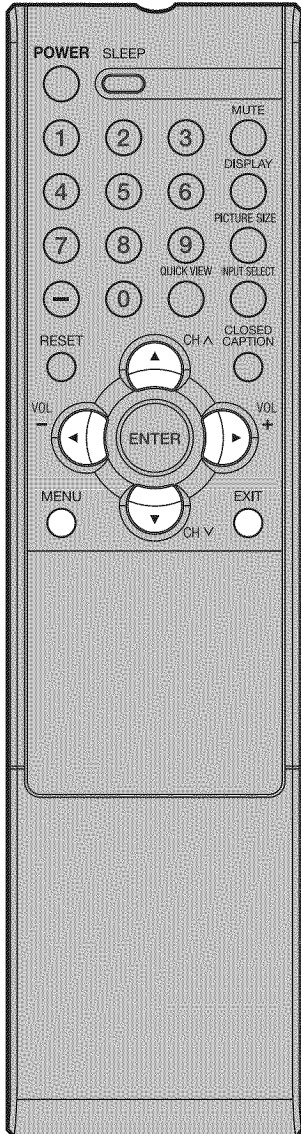

1 Press **MENU**. The menu screen will appear.

2 Press ◀ or ▶ to select  (SETUP) menu.

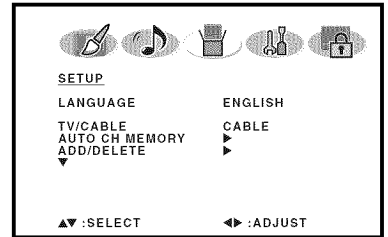

3 Press ▲ or ▼ to select "LANGUAGE".

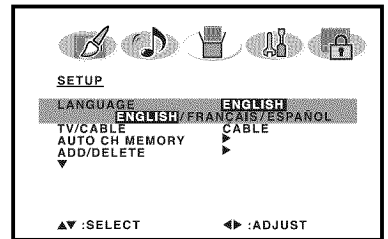

4 Press ◀ or ▶ to select the desired language: English (ENGLISH), French (FRANÇAIS) or Spanish (ESPAÑOL).

5 Press **EXIT** to return to the normal screen.

## NOTE:

If no buttons are pressed for more than about 60 seconds, the MENU screen will return to normal operation automatically.

# Memorizing channels

This TV is equipped with a channel memory feature which allows channels to skip up or down to the next channel set into memory, skipping over unwanted channels. Before selecting channels, they must be programmed into the TV's memory. To use this TV with an antenna, set the TV/CABLE menu option to the TV mode. When shipped from the factory, this menu option is in the CABLE mode.

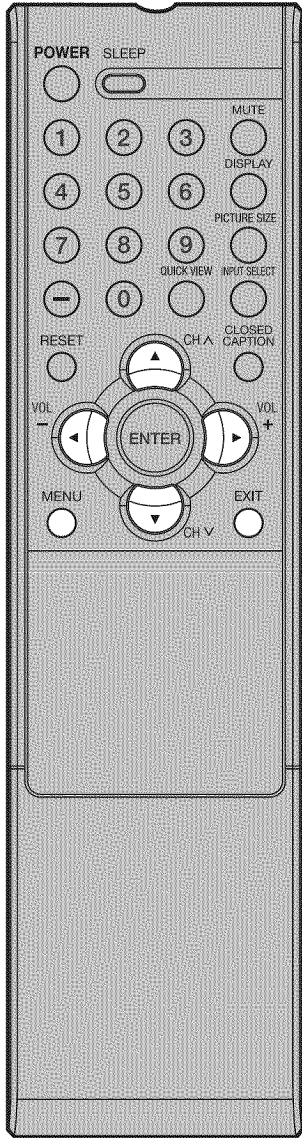

## TV/CABLE selection

1 Press **MENU**. The menu screen will appear.

2 Press **◀** or **▶** to select  (SETUP) menu.

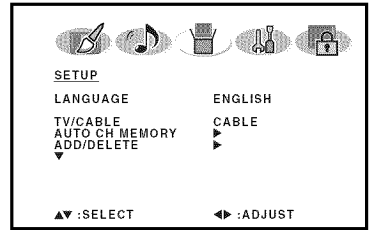

3 Press **▲** or **▼** to select "TV/CABLE".

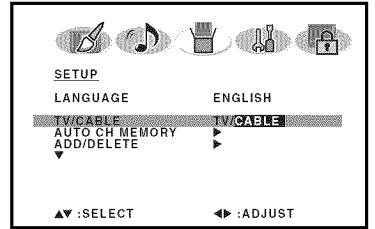

4 Press **◀** or **▶** to select "TV" or "CABLE".

**TV** - VHF/UHF channels  
**CABLE** - CABLE TV channels

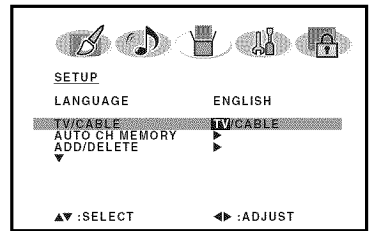

5 Press **EXIT** to return to the normal screen.

## CABLE CHART

The chart below is typical of many cable system channel allocations.

Number on this TV													14	15	16	17	18	19	20	21	22
Corresponding CABLE channel													A	B	C	D	E	F	G	H	I
23	24	25	26	27	28	29	30	31	32	33	34	35	36	37	38	39	40	DD			
J	K	L	M	N	O	P	Q	R	S	T	U	V	W	AA	BB	CC	DD				
41	42	43	44	45	46	47	48	49	50	51	52	53	54	55	56	57	58	58			
EE	FF	GG	HH	II	JJ	KK	LL	MM	NN	OO	PP	QQ	RR	SS	TT	UU	VV				
59	60	61	62	63	64	65	66	67	68	69	70	71	72	73	74	75	76	76			
WW	AAA	BBB	CCC	DDD	EEE	FFF	GGG	HHH	III	JJJ	KKK	LLL	MMM	NNN	OOO	PPP	QQQ				
77	78	79	80	81	82	83	84	85	86	87	88	89	90	91	92	93	94	94			
RRR	SSS	TTT	UUU	VVV	WWW	XXX	YYY	ZZZ	86	87	88	89	90	91	92	93	94				
95	96	97	98	99	100	101	102	103	104	105	106	107	108	109	110	111	112	112			
A-5	A-4	A-3	A-2	A-1	100	101	102	103	104	105	106	107	108	109	110	111	112				
113	114	115	116	117	118	119	120	121	122	123	124	125	01								
113	114	115	116	117	118	119	120	121	122	123	124	125	5A								

### NOTE:

It may take a few seconds for a digital channel picture to appear on screen after being selected.

## Automatic memory tuning

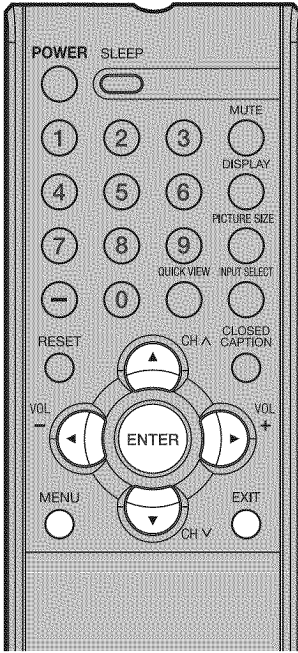

**1** Press **MENU**. The menu screen will appear.

**2** Press ◀ or ▶ to select  (SETUP) menu, then press ▲ or ▼ to select "AUTO CH MEMORY".

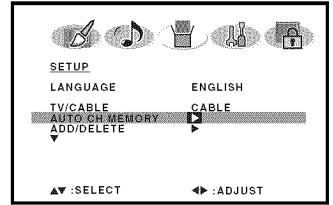

**3** Press ◀ or ▶. The TV will begin memorizing all the channels available in your area.

- It may take from 15 minutes to 30 minutes to complete memorizing digital cable channels.

Depending on the reception condition, a BAR display may not advance for several minutes, please be patient.

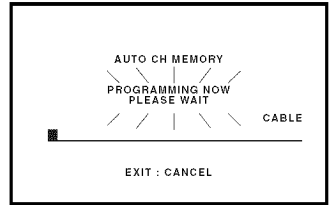

## To ADD/DELETE channels

**1** Press **MENU**. The menu screen will appear.

**2** Press ◀ or ▶ to select  (SETUP) menu, then press ▲ or ▼ to select "ADD/DELETE". Press ◀ or ▶. The ADD/DELETE menu will appear.

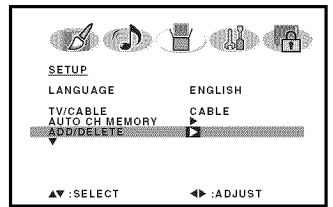

**3** Press ▲ or ▼ to select "ADD/DELETE", then press ◀ or ▶.

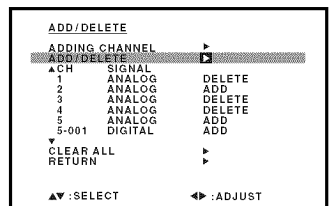

**4** Select the desired channel to be memorized or deleted using ▲ or ▼. Press ◀ or ▶ to select "ADD" or "DELETE", whichever function you want to perform.

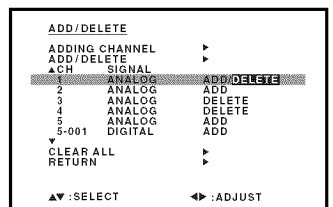

**5** Repeat step 4 for other channels you want to add or delete, then press **ENTER**.

**6** Press **EXIT** to return to the normal screen.

## To add a digital channel

Select the channel you wish to add.

Press ▲ or ▼ to select "ADDING CHANNEL" as in step 3 above, then press ◀ or ▶.

## CLEAR ALL

All channels are deleted from the channel memory.

Press ▲ or ▼ to select "CLEAR ALL" as in step 3 above, then press ▶.

## NOTES:

- Memorizing channels is best accomplished during evening "PRIMETIME" hours, as more stations are broadcasting digital signals. Memorizing channels can only be accomplished while a station is broadcasting a digital signal to set that channel into memory.
- If you are unsure of the digital channels available in your area you may visit [www.antennaweb.org](http://www.antennaweb.org) to receive a list based on your address or zip code. Should you require further assistance you may call our toll-free customer service line at 1-800-289-0980.
- New digital channels may be added to your area periodically, it is recommended to perform the "AUTO CH MEMORY" procedure regularly.
- To return from ADD/DELETE menu to SETUP menu, select "RETURN", then press ◀ or ▶.

# TV operation

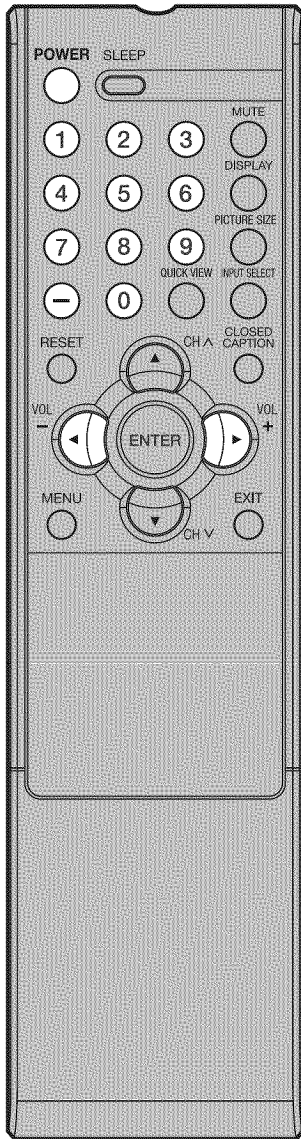

**1** To turn on the TV, press **POWER**.

**2** Adjust the volume level by pressing **VOL +** or **-**. The volume level will be indicated on the screen by white bars. As the volume level increases, so do the number of bars. If the volume decreases, the number of white bars also decreases.

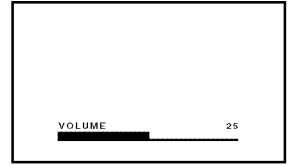

**3** Set the TV/CABLE menu option to the appropriate position (see page 18).

**TV - VHF/UHF channels**  
**CABLE - CABLE TV channels**

**4** Press the **Direct Channel Selection (0-9, -)** buttons to select the channel.

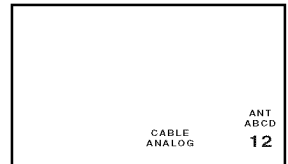

## TO SELECT ANALOG CHANNELS

- 1-9: Press **0** twice, then 1-9 as needed. Example, to select channel 2, press **0, 0, 2**.
- 10-99: Press **0**, then the remaining 2 digits. Example, to select channel 12, press **0, 1, 2**.
- 100-125: Press the 3 digits in order. Example, to select channel 120, press **1, 2, 0**.

## TO SELECT DIGITAL CHANNELS

Press the first 3 digits, then press the **-** button, followed by the remaining 3 digits.

Example, to select channel 015-001, press **0, 1, 5, -, 0, 0, 1**.

- If a channel is selected with only audio content, "AUDIO ONLY" will be displayed on the screen.
- If a channel is selected with a weak digital signal, "DIGITAL CHANNEL SIGNAL STRENGTH IS LOW" will be displayed on the screen.
- If a channel is selected to which you have not subscribed, "DIGITAL CHANNEL IS SCRAMBLED" will be displayed on the screen.

## VHF/UHF/CABLE CHANNELS

TV	CABLE
VHF 2-13	VHF 2-13
UHF 14-69	STD/HRC/IRC 14-36 (A) (W) 37-59 (AA) (WW) 60-85 (AAA) (ZZZ) 86-94 (86) (94) 95-99 (A-5) (A-1) 100-125 (100) (125) 01 (5A)

### NOTES:

- If a channel with no broadcast is selected, the sound will automatically be muted.
- It may take a few seconds for a digital channel picture to appear on screen after being selected.

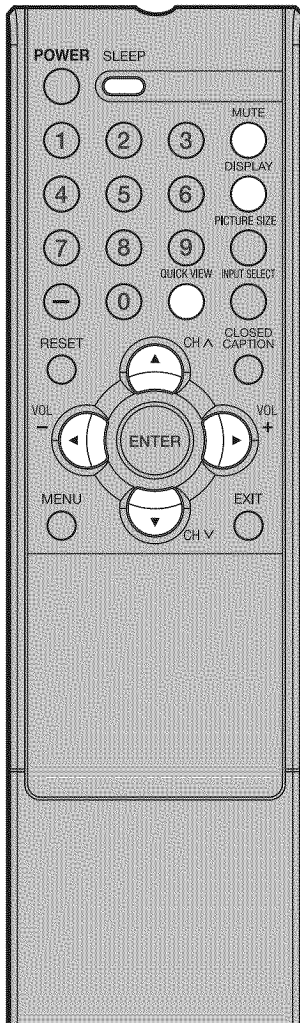

## CH ^/v

Press and release **CH ^** or **v**. The channel automatically stops at the next channel set into memory. For proper operation, before selecting channels, they should be set into the memory. See pages 18 and 19 "Memorizing channels".

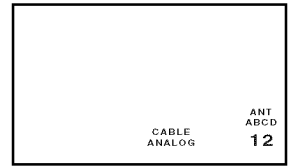

## DISPLAY

Press **DISPLAY** to display the current information on the screen.

When the TV receives a digital signal, the digital information will appear.

- Channel number
- Broadcast program name
- Station name
- Audio language
- V-CHIP RATING
- Sleep time
- Remaining time
- Program guide
- V-Chip mark
- Picture size



When the TV receives an analog signal, the analog information will appear.

- Channel number or VIDEO mode selected
- Channel label (if preset)
- Stereo or SAP (second audio program) audio status
- Content rating
- Sleep time
- Picture size

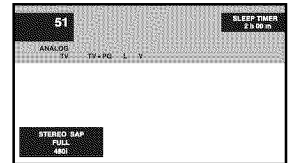

Press **DISPLAY** again to clear the call display.

## QUICK VIEW

This button allows you to go back to the last channel selected by pressing **QUICK VIEW**. Press **QUICK VIEW** again to return to the last channel you were watching.

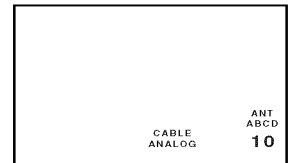

## NOTES:

- The TV is capable of holding a still video image or On screen display image on your TV screen indefinitely. If you leave the still video image or On screen display image displayed on your TV for an extended period of time, you risk permanent damage to your TV screen.
  - When the TV receives an analog signal, **DISPLAY** shows only analog information.
  - After 10 seconds, **DISPLAY** screen will return to normal TV-operation automatically, when a Digital signal is received.
- After 4 seconds, **DISPLAY** screen will return to normal TV-operation automatically, when a Analog signal is received.

## MUTE

Press **MUTE** to switch off the sound. The TV's sound will be silenced and "MUTE" will briefly appear on the screen. The sound can be switched back on by pressing this button again or the **VOL +** or **-**.



## SLEEP

To set the TV to turn off after a preset amount of time, press **SLEEP** on the remote control. The clock will count up 10 minutes for each press of the **SLEEP** button (OFF, 0h10m, ..., 1h50m, 2h00m). After the sleep time is programmed, the display will appear briefly every ten minutes to remind you that the sleep timer is operating. To confirm the sleep timer setting, press **SLEEP** and the remaining time will be displayed for a few seconds. To cancel the sleep timer, press **SLEEP** repeatedly until the display turns to 0h00m.

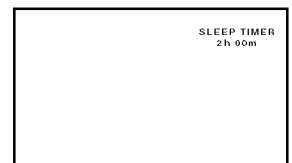

# Labeling channels

Channel labels appear over the channel number display each time you turn on the TV, select a channel, or press **DISPLAY**. You can choose any four characters to identify a channel.

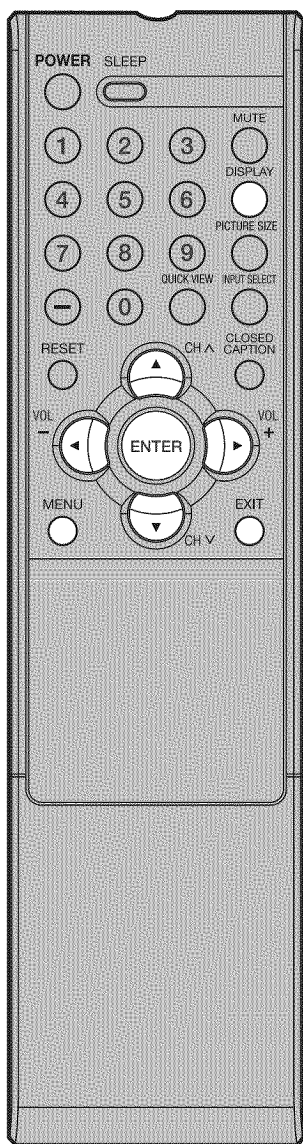

## NOTE:

Select "RETURN" and press ◀ or ▶ to return from CH LABEL menu to OPTION menu.

## To create channel labels

- 1 Select a channel you want to label.
- 2 Press **MENU**, then press ◀ or ▶ to select  (OPTION) menu. Press ▲ or ▼ to select "CH LABEL", then press ◀ or ▶. The CH LABEL menu will appear.
- 3 Press ▲ or ▼ to select "SET/CLEAR". Press ◀ or ▶ to select "SET".
- 4 Press **ENTER** to select "LABEL". Then press ◀ or ▶ to enter a character in the first space. Press the button repeatedly until the character you want appears on the screen.

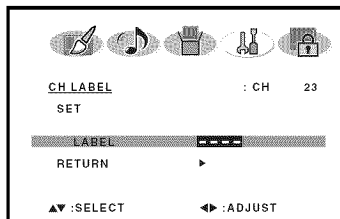
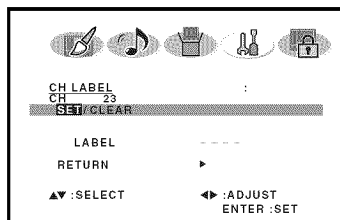
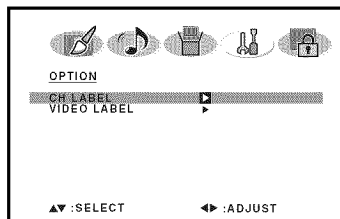

The characters rotation as follows:

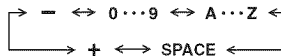

If the character which you desire appears, press **ENTER**. Repeat this step to enter the rest of the characters. If you would like a blank space in the label name, you must choose the empty space from the list of characters; otherwise, a dash will appear in that space. When you finish inputting the label name, press **ENTER**.

- 5 Press **EXIT** to return to the normal screen.
- 6 Repeat steps 1-5 for other channel. You can assign a label to each channel.

## To erase channel labels

- 1 Select a channel with a label which you want remove.
- 2 Press **MENU**, then press ◀ or ▶ to select  (OPTION) menu. Press ▲ or ▼ to select "CH LABEL", then press ◀ or ▶ to display the CH LABEL menu.
- 3 Press ▲ or ▼ to select "SET/CLEAR", then press ◀ or ▶ to select "CLEAR".
- 4 Press **EXIT** to return to the normal screen.
- 5 Repeat steps 1-4 to erase other channel labels.

# Selecting the video input source/Labeling the video input source

## Selecting the video input source

Press **INPUT SELECT** to view a signal from another device connected to your LCD TV, such as a VCR or DVD player. You can select ANT, VIDEO1, VIDEO2, COMPONENT, HDMI or PC depending on which input jacks you used to connect your devices.

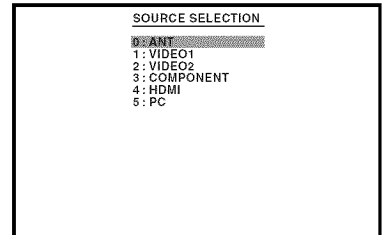

Pressing **INPUT SELECT** on the remote control displays the current signal source. To change the video input source, press **INPUT SELECT** again or 0-5.

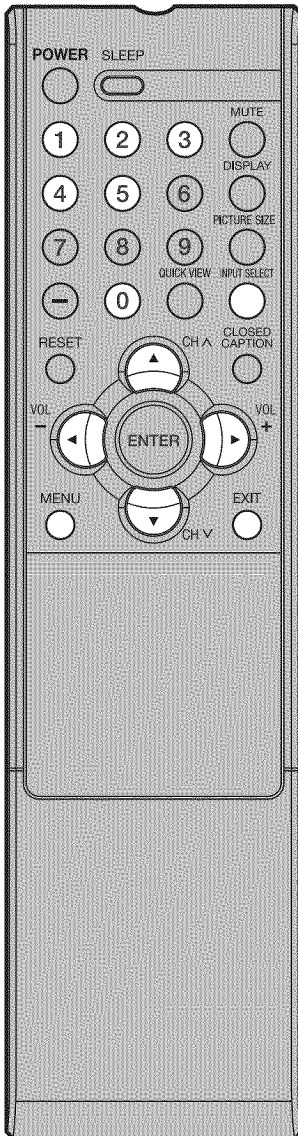

## Labeling the video input source

The video label feature allows you to label each input source for your TV.

- 1 Press **MENU**. Then press ◀ or ▶ to select  (OPTION) menu. Press ▲ or ▼ to select "VIDEO LABEL", then press ◀ or ▶. The VIDEO LABEL menu will appear.

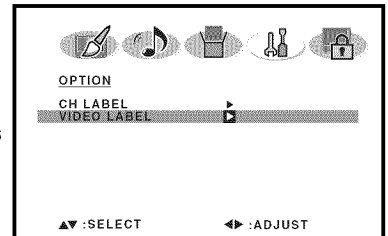

- 2 Press ▲ or ▼ to select the video source you want to label.

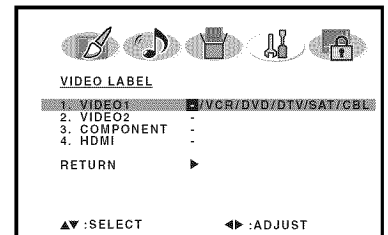

- 3 Press ◀ or ▶ to select the desired label for that input source.

- : Uses the default label name
- VCR** : Video cassette recorder
- DVD** : DVD video
- DTV** : Digital TV set-top box
- SAT** : Satellite box
- CBL** : Cable box
- HD** : HDMI device (only HDMI)

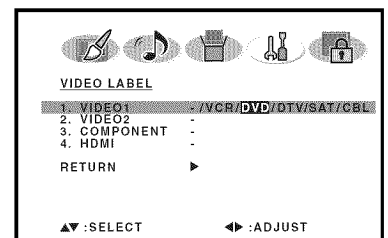

- 4 Press **EXIT** to return to the normal screen.

### NOTE:

Select "RETURN" and press ◀ or ▶ to return from VIDEO LABEL menu to OPTION menu.

# Setting the V-Chip

An age limitation can be set to restrict children from viewing or hearing violent scenes or pictures that you may choose to exclude. The restriction applies to “TV RATING” and “MOVIE RATING” if this data is transmitted. You may set this restriction separately. To use the V-Chip function, you must register a password.

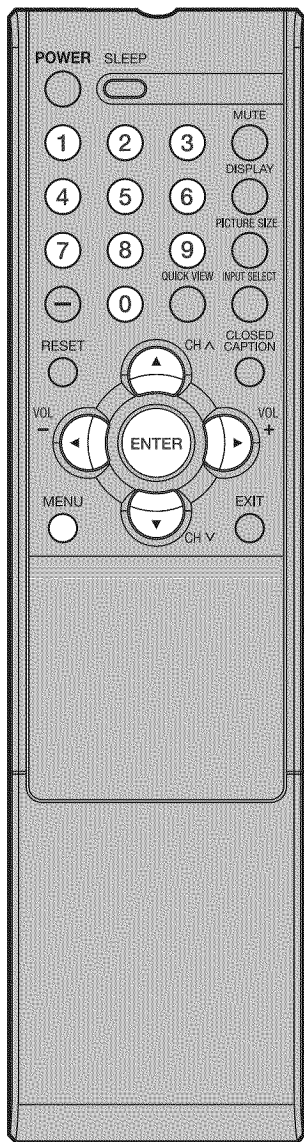

## To register a password

- 1 Press **MENU**. The menu screen will appear. Then press ◀ or ▶ to select  (LOCKS) menu.

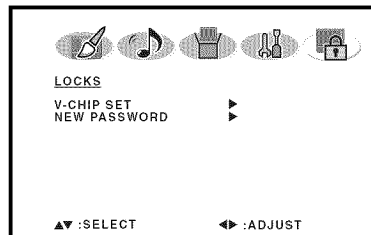

- 2 Press ▲ or ▼ to display the password entering mode.

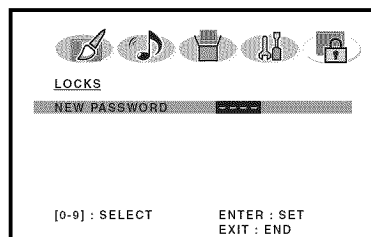

- 3 Select and enter a password (4 digits) using **Number buttons (0-9)**, then press **ENTER**.

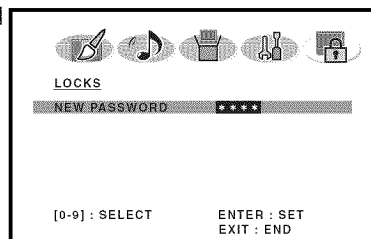

“\*” appears instead of the number.

- 4 Enter the same password again to confirm, then press **ENTER**. The password is now registered and the LOCKS menu will appear on the screen.

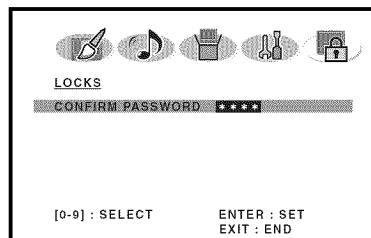

## NOTES:

- If you forget the password, contact Customer Service at 1-800-289-0980 for assistance. Your original remote control will be required.
- To avoid forgetting the password, write it down and keep in a safe place.



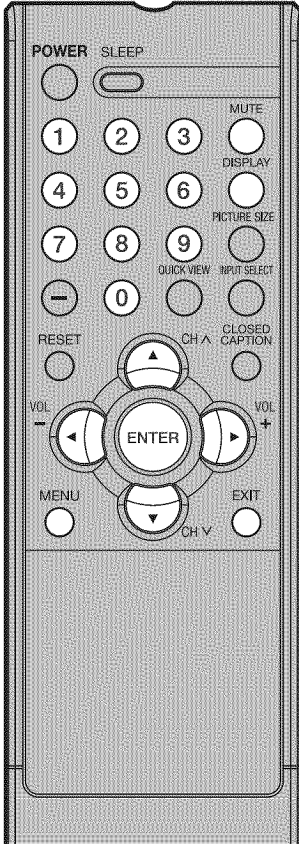

## To use the TV after the TV is protected.

When a program is received that is blocked by the V-Chip, press **MUTE** and enter the password, then press **ENTER**. When the password is entered correctly the protection will be temporarily overridden. If the TV is turned off, or the channel is changed the V-Chip restriction will be reactivated.

## NOTES:

- The V-Chip function is activated only on programs and input sources that have the rating signal.
- The V-CHIP SET (DTV) will only be selectable when the TV receives a digital broadcast using the new rating system. It may take several minutes for the initial V-Chip Set-up to complete. At this time some stations are still developing this signal, in those cases the V-CHIP SET (DTV) will not function.

## To set the V-Chip

- 1 Press **MENU**.  
Then press ◀ or ▶ to select  (LOCKS) menu.
- 2 Press ▲ or ▼ to display the password entering mode.  
Use **Number buttons (0-9)** to enter your password, then press **ENTER**. The LOCKS menu appears.
- 3 Press ▲ or ▼ to select "V-CHIP SET", then press ◀ or ▶. The V-CHIP SET menu appears.
- 4 Press ▲ or ▼ to select "TV RATING". Then press ◀ or ▶ to display the desired rating.  

<b>OFF</b>	: TV RATING is not set
<b>TV-Y</b>	: All children
<b>TV-Y7</b>	: 7 years old and above
<b>TV-G</b>	: General audience
<b>TV-PG</b>	: Parental guidance
<b>TV-14</b>	: 14 years old and above
<b>TV-MA</b>	: 17 years old and above

- When you select TV-Y7, TV-PG, TV-14 or TV-MA, press **DISPLAY** to explain the rating. Press ▲ or ▼ to select the desired rating you want. Press ◀ or ▶ to select the setting "ON" or "OFF".

- 5 Press ▲ or ▼ to select "MOVIE RATING", then press ◀ or ▶. The RATING SET menu appears.

- 6 Press ▲ or ▼ to select a rating, then press ◀ or ▶ to select ON or OFF for each rating.

- |              |  |
|--------------|--|
| <b>G</b>     | : All ages                                       |
| <b>PG</b>    | : Parental guidance                              |
| <b>PG-13</b> | : Parental guidance less than 13 years old       |
| <b>R</b>     | : Under 17 years old Parental guidance suggested |
| <b>NC-17</b> | : 17 years old and above                         |
| <b>X</b>     | : Adult only                                     |

- 7 Press **ENTER** twice to return to the LOCKS menu, then press ▲ or ▼ to select "V-CHIP".

- 8 Press ◀ or ▶ to select "ON". Your settings are now set into memory.

- 9 Press **EXIT** to return to the normal screen.

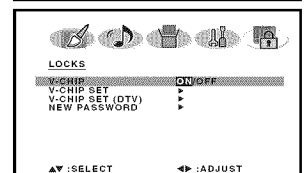
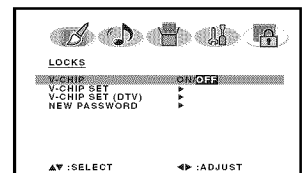
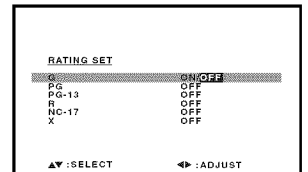
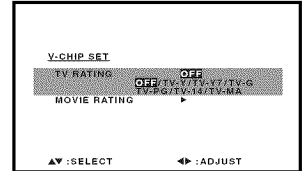
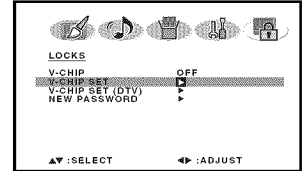
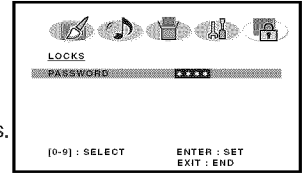
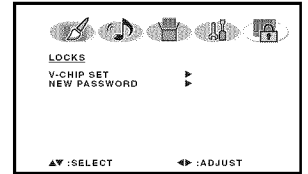

# Setting the V-Chip

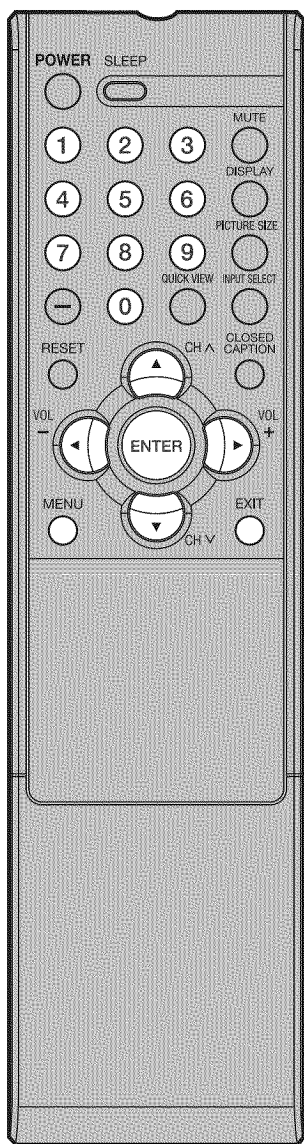

## To change the password

1 Press **MENU**. The TV menu screen will appear.

2 Press ◀ or ▶ to select  (LOCKS) menu.

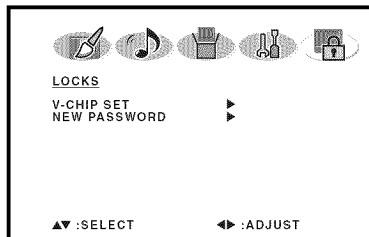

3 Press ▲ or ▼ to display the password entering mode. Use **Number buttons (0-9)** to enter your password, then press **ENTER**. The LOCKS menu appears.

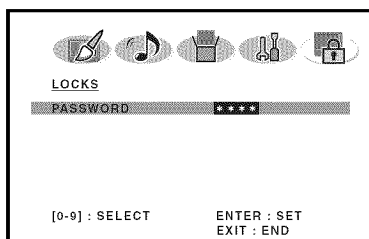

4 Press ▲ or ▼ to select "NEW PASSWORD", then press ◀ or ▶.

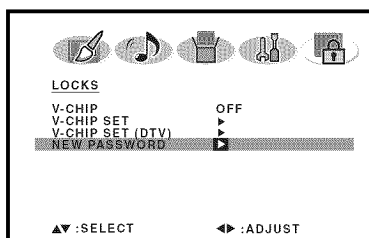

5 Enter a new password using **Number buttons (0-9)**, then press **ENTER**.

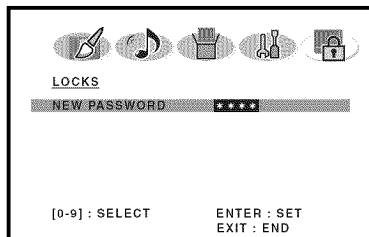

6 Enter the same password again to confirm, then press **ENTER**.

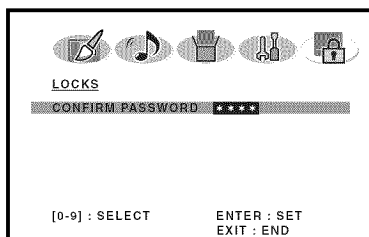

7 Press **EXIT** to return to the normal screen.

## WHAT IS CLOSED CAPTIONING?

This television has the capability to decode and display Closed Captioned television programs. Closed Captioning will display text on the screen for hearing impaired viewers or it will translate and display text in another language.

**Captions:** This Closed Caption Mode will display text on the screen in English or another language. Generally, Closed Captions in English are transmitted on C1 and Closed Captions in other languages are transmitted on C2.

**Text:** The Text Closed Caption Mode will usually fill 1/2 of the screen with a programming schedule or other information.

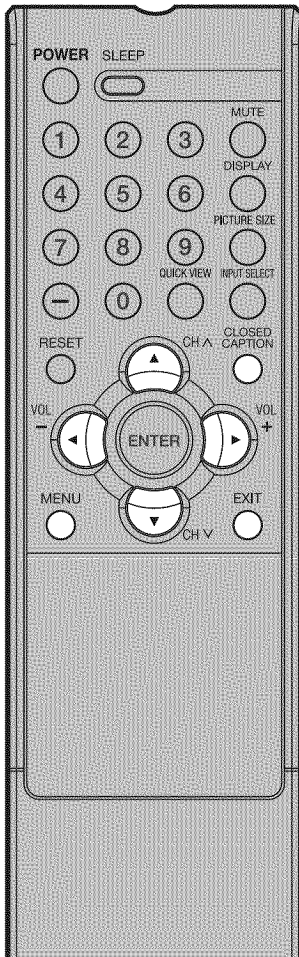

- 1 Tune the TV to the desired program.
- 2 Press **MENU**, then press ◀ or ▶ to display the  (SETUP) menu.
- 3 Press ▲ or ▼ to select “ANALOG CAPTION” or DIGITAL CAPTION”.

### NOTE:

You can also display the ANALOG CAPTION menu by pressing the CLOSED CAPTION button on the remote control.

When an Analog signal is received, you can choose C1, C2, T1, T2 and OFF.

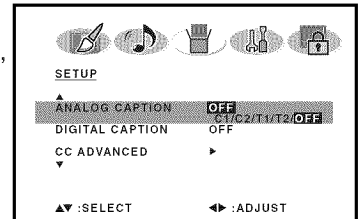

When a Digital signal is received, you can choose from CS1, CS2, CS3, CS4, CS5, CS6 and OFF.

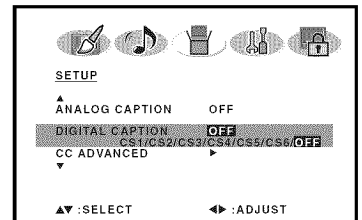

### NOTE:

Depending on the broadcast signal, some Analog Captions will function with a Digital broadcast signal.

- 4 Press ◀ or ▶ to select the desired Closed Caption mode.

### NOTE:

To turn the Closed Caption feature off, select “OFF”.

- 5 Press **EXIT** to return to the normal screen.

### NOTES:

- If the program or video you selected is not closed-captioned, no captions will display on-screen.
- If text is not available in your viewing area, a black rectangle may appear on-screen. If this happens, set the Closed Caption feature to “OFF”.
- When selecting Closed Captions, the captioning will be delayed approx. 10 seconds.
- If no caption signal is received, no captions will appear, but the television will remain in the Caption Mode.
- Misspellings or unusual characters may occasionally appear during Closed Captioning. This is normal with Closed Captioning, especially with live programs. This is because during live programs, captions are also entered live. These transmissions do not allow time for editing.
- When Captions are being displayed, on-screen displays, such as volume and mute may be seen but may interfere with Closed Captions.
- Some cable systems and copy protection systems may interfere with the Closed Captioned signal.
- If using an indoor antenna or if TV reception is very poor, the Closed Caption Decoder may not appear or may appear with strange characters or misspelled words. In this case, adjust the antenna for better reception or use an outdoor antenna.

# CC advanced

Closed Captions are factory preset however you can adjust them individually as follows:

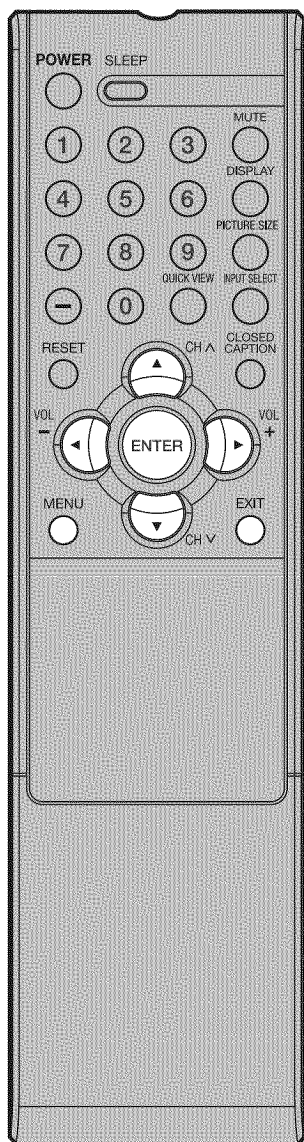

This feature is designed to customize Digital Captions only.

**1** Press **MENU**. The menu screen will appear.

**2** Press ◀ or ▶ to select (SETUP) menu.

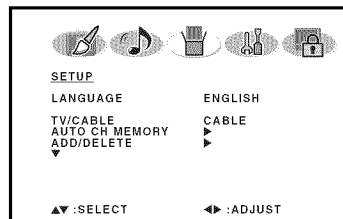

**3** Press ▲ or ▼ to select "CC ADVANCED", then press ◀ or ▶. The CC ADVANCED menu will appear.

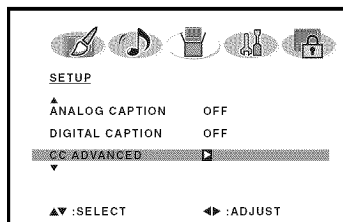

**4** Press ▲ or ▼ to select the item you want to adjust, then press ◀ or ▶.

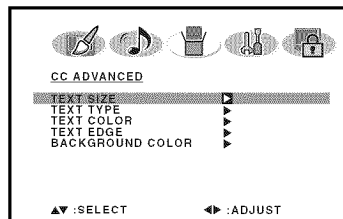

**5** Press ▲ or ▼ to select desired setting, then press **ENTER**.

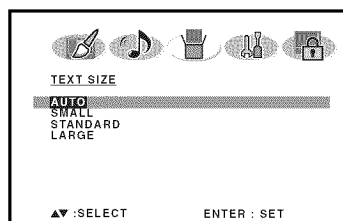

You can select from among the following items and parameters.

**TEXT SIZE:** AUTO, SMALL, STANDARD, LARGE

**TEXT TYPE:** AUTO, DEFAULT, MONO W. SERIF, PROP. W. SERIF, MONO W/O SERIF, PROP. W/O SERIF, CASUAL, CURSIVE, SMALL CAPITALS

**TEXT COLOR:** AUTO, BLACK, WHITE, RED, GREEN, BLUE, YELLOW, MAGENTA, CYAN

**TEXT EDGE:** AUTO, NONE, RAISED, DEPRESSED, UNIFORM, LEFT DROP SHADOW, RIGHT DROP SHADOW

**BACKGROUND COLOR:** AUTO, BLACK, WHITE, RED, GREEN, BLUE, YELLOW, MAGENTA, CYAN

**6** Press **EXIT** to return to the normal screen.

## NOTE:

Do not set the Closed Caption "TEXT COLOR" and "BACKGROUND COLOR" as the same color or you will not be able to see the text.

# Setting the picture size

You can view 480i and 480p format programs in a variety of picture sizes—**NATURAL**, **CINEMA WIDE1**, **CINEMA WIDE2**, **CINEMA WIDE3**, and **FULL**.

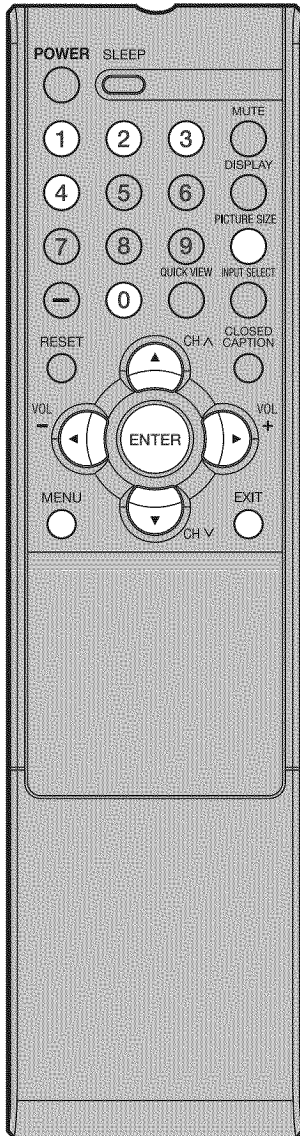

## Selecting the picture size

- 1 Press **MENU**. Press ◀ or ▶ to select  (SETUP) menu. Press ▲ or ▼ to select "PICTURE SIZE".

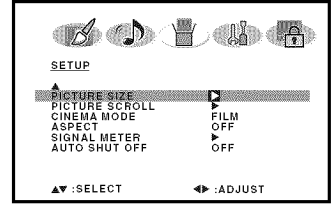

- 2 Press ◀ or ▶. The PICTURE SIZE menu will appear. Press ▲/▼ or a **Number button (0-4)** to select the desired picture size, as described below and on the next page, then press **ENTER**.



- 3 Press **EXIT** to return to the normal screen.

### NOTE:

You can also display the PICTURE SIZE menu by pressing the **PICTURE SIZE** button on the remote control.

## NATURAL picture size

In some cases, this image will display the size of standard 4:3 with a gray side bar.

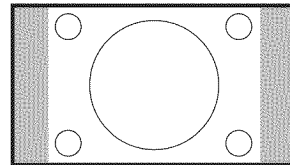

## CINEMA WIDE1 picture size (for 4:3 format programs)

To fill the screen, the right and left edges are extended, however; the center of the picture remains near its former ratio.

The top and bottom edges of the picture may be hidden.

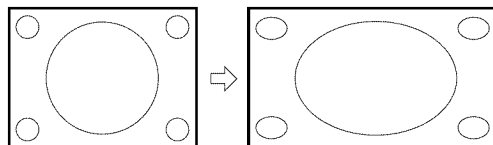

### NOTE:

Some High Definition and/or Digital broadcasts may not allow you to change the picture size.

# Setting the picture size

## NOTES:

- The PICTURE SIZE feature is not available for some program formats (such as 1080i or 720p). Such formats will display in FULL.
- The PICTURE SIZE feature is in the PC mode only for NATURAL or FULL.
- In CINEMA WIDE2 picture size, some of the on screen display items may be positioned off the visible portion of the screen. You can use Picture Scroll, as explained on the right, to view off screen items.

## CINEMA WIDE2 picture size (for letter box programs)

The entire picture is uniformly enlarged—it is stretched the same amount both wider and taller (retains its original proportion).

The top and bottom edges of the picture may be hidden. To view the hidden areas, it is possible to make the picture scroll (see page 31).

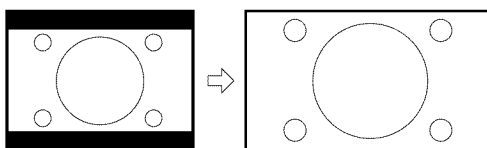

## CINEMA WIDE3 picture size (for letter box programs with subtitles)

To fill the width of the screen, it is extended horizontally. However, it is only slightly extended at the top and the bottom.

The top and bottom edges of the picture may be hidden. To view the hidden areas (such as subtitles or captions), it is possible to make the picture scroll (see page 31).

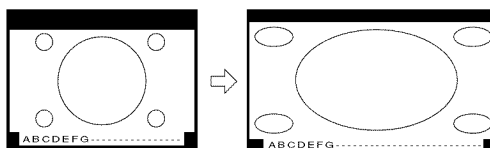

## FULL picture size (for 16:9 source programs)

FULL will display the picture at the maximum size.

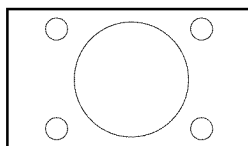

# Setting the picture scroll

You can scroll the picture in CINEMA WIDE2 and CINEMA WIDE3

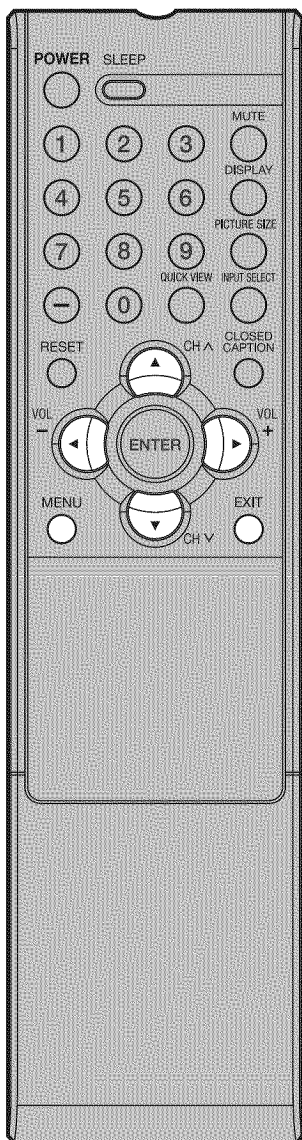

- 1 Press **MENU** in CINEMA WIDE2 or CINEMA WIDE3 mode. Then press ◀ or ▶ to select  (SETUP) menu.

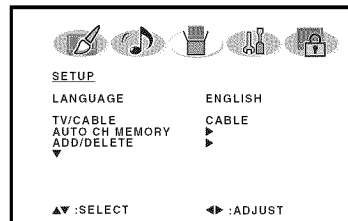

- 2 Press ▲ or ▼ to select "PICTURE SCROLL".

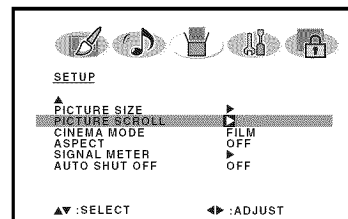

- 3 Press ◀ or ▶ to display the SCROLL ADJUSTMENT mode.

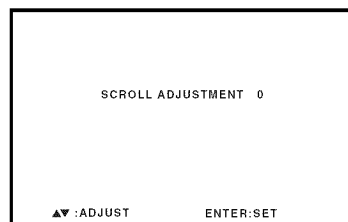

- 4 Press ▲ or ▼ to adjust the vertical position of the picture.

Normal (center) position.

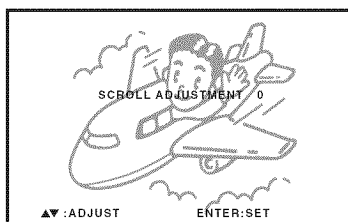

To raise the picture, press ▲.

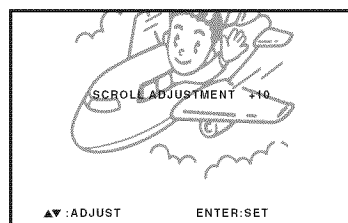

To lower the picture, press ▼.

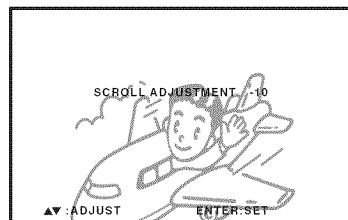

## NOTE:

The scroll amounts are as follows:

- 480i/480p signal source:  
CINEMA WIDE1 : Not adjustable  
CINEMA WIDE2 : -10 to +10  
CINEMA WIDE3 : -10 to +10

- 5 Press **EXIT** to return to the normal screen.

# Selecting the cinema mode/Using the aspect feature

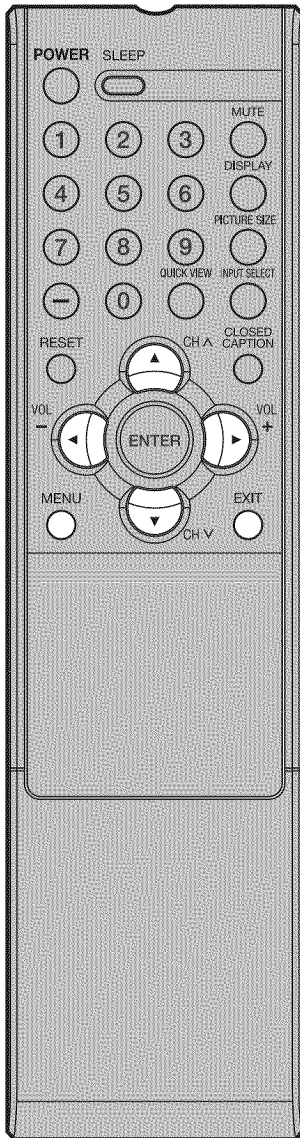

## Selecting the cinema mode

A smoother motion may be obtained by setting the Picture Mode to Film when you view a DVD from the DVD player connected with the component input.

- 1 Press **MENU**, then press ◀ or ▶ to select  (SETUP) menu.

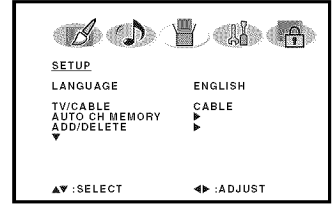

- 2 Press ▲ or ▼ to select **CINEMA MODE**, then press ◀ or ▶ to select "FILM".

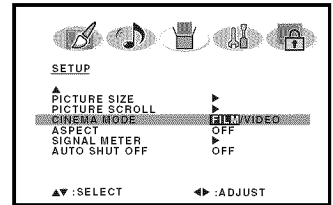

- 3 Press **EXIT** to return to the normal screen.

## To set the CINEMA MODE to VIDEO :

Press ◀ or ▶ to select "VIDEO" in step 2 above.

## Using the aspect feature

When the **ASPECT** feature is set to ON and the TV receives a 480i signal, the picture size is automatically selected (as described in the following table).

- 1 Press **MENU**, then press ◀ or ▶ to select  (SETUP) menu.

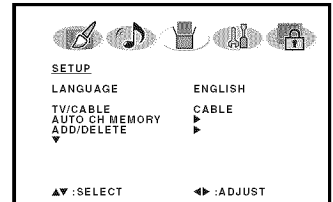

- 2 Press ▲ or ▼ to select "ASPECT", then press ◀ or ▶ to select "ON" or "OFF".

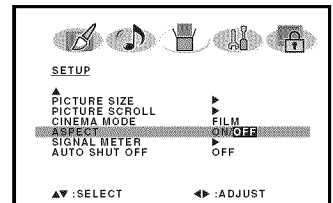

- 3 Press **EXIT** to return to the normal screen.

Aspect ratio of signal source	Automatic aspect size (When ASPECT is ON)
4:3 Normal	NATURAL
16:9 Full	FULL
4:3 Letter box	CINEMA WIDE
Not defined	User-set mode

### NOTE:

If the signal does not include aspect information, the picture size you selected on page 29 is displayed.



# Adjusting the picture preference/Picture control adjustment

You can select four picture modes—SPORTS, STANDARD, MOVIE, and MEMORY—as described in the following table:

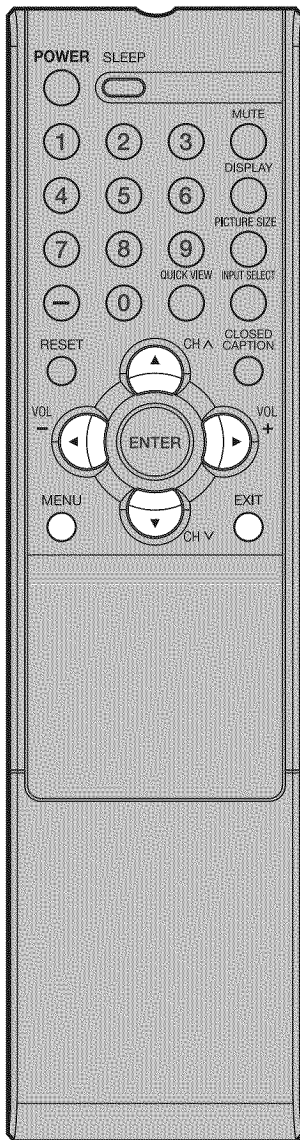

## Adjusting the picture preference

1 Press **MENU**, then press ◀ or ▶ to select (PICTURE) menu.

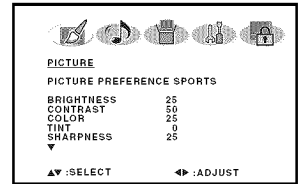

2 Press ▲ or ▼ to select "PICTURE PREFERENCE".

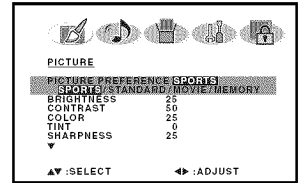

3 Press ◀ or ▶ to select the item you want to adjust.

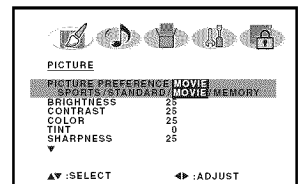

Mode	Picture Quality
<b>SPORTS</b>	Bright and dynamic picture (factory-set)
<b>STANDARD</b>	Standard picture quality (factory-set)
<b>MOVIE</b>	Movie-like picture setting (factory-set)
<b>MEMORY</b>	Your personal preferences (set by you; see "Picture control adjustment" below).

4 After your desired setting, press **EXIT** to return to the normal screen.

## Picture control adjustment

1 Press **MENU**, then press ◀ or ▶ to select (PICTURE) menu.

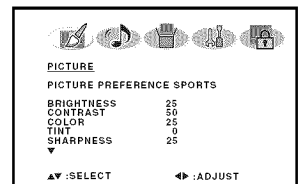

2 Press ▲ or ▼ to select the item you want to adjust. Press ◀ or ▶ to adjust the setting.

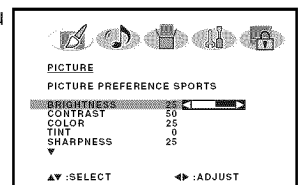

	◀	▶
<b>BRIGHTNESS</b>	decrease brightness	increase brightness
<b>CONTRAST</b>	decrease contrast	increase contrast
<b>COLOR</b>	be pale color	be brilliant color
<b>TINT</b>	be reddish color	be greenish color
<b>SHARPNESS</b>	makes picture softer	makes picture clearer

### NOTE:

The CONTRAST default setting is set to maximum at the factory.

3 After your desired setting, press **EXIT** to return to the normal screen.

# Selecting the color temperature/ Adjusting the backlighting

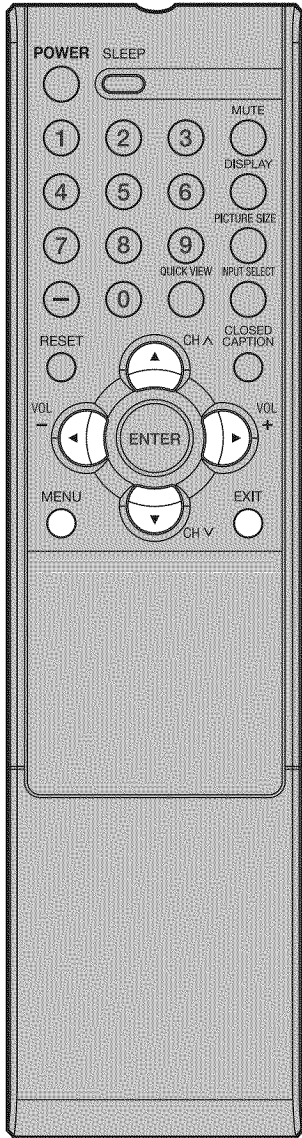

## Selecting the color temperature

Change the picture quality by selecting from three preset color temperatures—COOL, MEDIUM, and WARM:

- 1 Press **MENU**, then press ◀ or ▶ to select (PICTURE) menu.

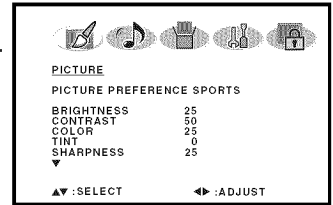

- 2 Press ▲ or ▼ to select “COLOR TEMPERATURE”. Press ◀ or ▶ to select the mode you prefer.

Mode	Picture Quality
<b>COOL</b>	Blueish
<b>MEDIUM</b>	Neutral
<b>WARM</b>	Reddish

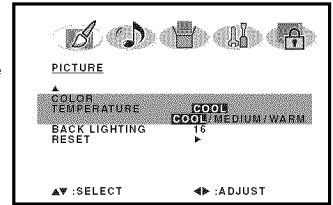

- 3 Press **EXIT** to return to the normal screen.

## Adjusting the backlighting

The **BACKLIGHTING** feature adjusts the screen brightness for improved picture clarity.

- 1 Press **MENU**, then press ◀ or ▶ to select (PICTURE) menu.

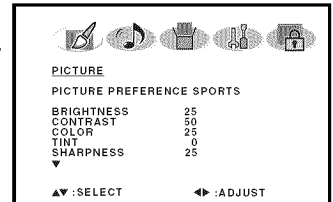

- 2 Press ▲ or ▼ to select “BACKLIGHTING”. Press ◀ or ▶ to adjust the setting.

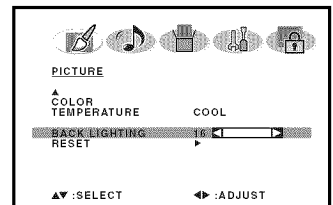



- 3 After your desired setting, press **EXIT** to return to the normal screen.

# Resetting your picture adjustments

The **RESET** function returns your picture quality adjustments to the following factory settings:

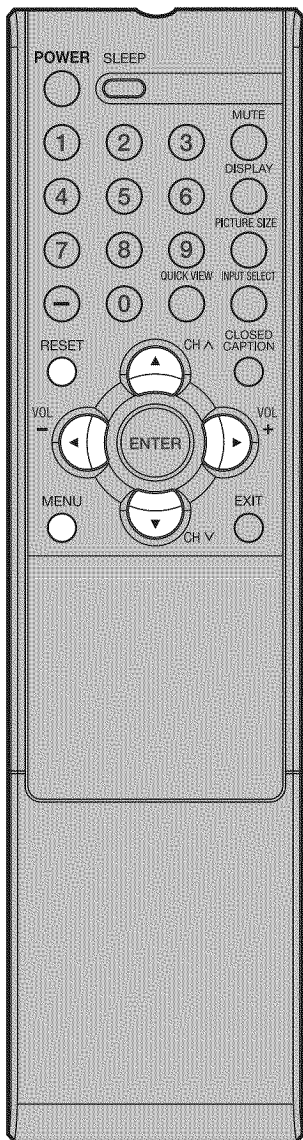
PICTURE PREFERENCE .....	SPORTS	TINT .....	center (0)
BRIGHTNESS .....	center (25)	SHARPNESS .....	center (25)
CONTRAST .....	max (50)	COLOR TEMPERATURE ...	COOL
COLOR .....	center (25)		



**1** Press **MENU**, then press ◀ or ▶ to select  (PICTURE) menu.

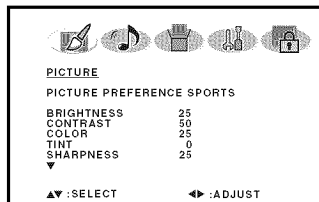

**2** Press ▲ or ▼ to select "RESET", and then press ▶.

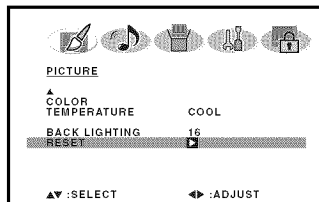

**NOTE:**

When you press **RESET** in the  (PICTURE) menu, the picture adjustment returns to the factory preset level.

# Selecting Stereo/Second Audio Program (SAP)/ Sound control adjustment

The multi-channel TV sound (MTS) feature provides high-fidelity stereo sound. MTS also can transmit a second audio program (SAP) containing a second language or other audio information.

When the TV receives a stereo or SAP broadcast, the word "STEREO" or "SAP" displays on-screen every time you turn the TV on, change the channel, or press DISPLAY.

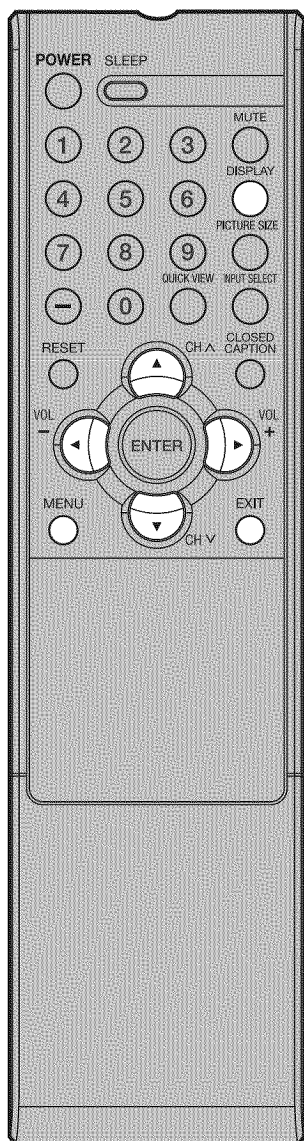

## Selecting Stereo/Second Audio Program (SAP)

1 Press **MENU**, then press ◀ or ▶ to select (AUDIO) menu.



2 Press ▲ or ▼ to select "MTS". Press ◀ or ▶ to select "STR (STEREO)".

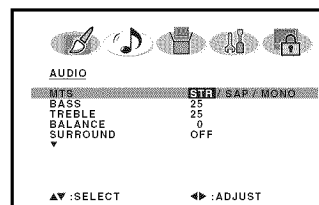

3 Press **EXIT** to return to the normal screen.

### NOTES:

- Generally you can leave your TV in stereo mode because the TV automatically outputs the type of sound being broadcast (stereo or mono).
- If the stereo sound is noisy, select MONO to reduce the noise.

## To listen to a second audio program (SAP)

Press ◀ or ▶ to select "SAP" in step 2 above. The TV speakers will output the second audio program instead of normal audio.

## Sound control adjustment

1 Press **MENU**, then press ◀ or ▶ to select (AUDIO) menu.

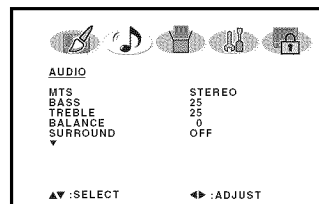

2 Press ▲ or ▼ to select the item you want to adjust.

**BASS:** Press ◀ or ▶ to adjust the bass sound.

**TREBLE:** Press ◀ or ▶ to adjust the treble sound.

**BALANCE:** Press ◀ or ▶ to obtain an equal sound level from both speakers.

### SURROUND:

Press ◀ or ▶ to select "ON" or "OFF".

**ON:** The dynamic presence and sound created offers a thoroughly enjoyable listening experience.

**OFF:** Normal sound.

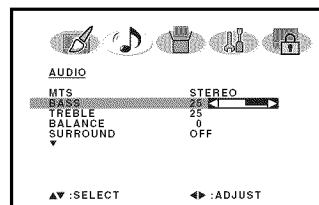

3 After your desired setting, press **EXIT** to return to the normal screen.

# Selecting the HDMI audio input source/ Selecting the audio language

## Selecting the HDMI audio input source

When you use HDMI AUDIO IN jacks with HDMI or DVI device, you must select HDMI audio input source from "HDMI" or "DVI".

- 1 Press **MENU**. Then press ◀ or ▶ to select  (AUDIO) menu.

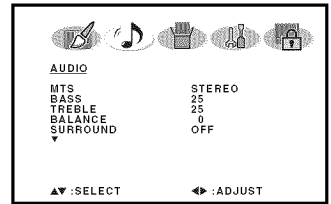

- 2 Press ▲ or ▼ to select "HDMI", then press ◀ or ▶ to select "HDMI" or "DVI".

**HDMI:** When you connect the HDMI device to the TV, select this setting.

**DVI:** When you connect the DVI device to the TV with analog audio cords, select this setting.

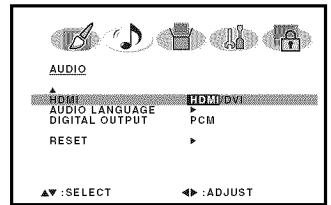

- 3 Press **EXIT** to return to the normal screen.

## Selecting the audio language

When two or more audio languages are included in a digital signal, you can select one of the audio language.

- 1 Press **MENU**, then press ◀ or ▶ to select  (AUDIO) menu.

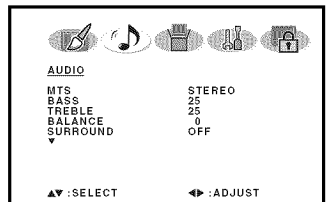

- 2 Press ▲ or ▼ to select "AUDIO LANGUAGE". Then press ▶ to display the AUDIO LANGUAGE menu.

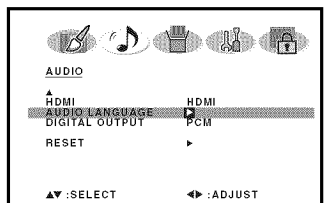

- 3 Press ▲ / ▼ or **Number button (0-7)** to select your desired language, then press **ENTER**.

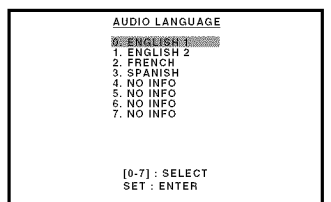

- 4 Press **EXIT** to return to the normal screen.

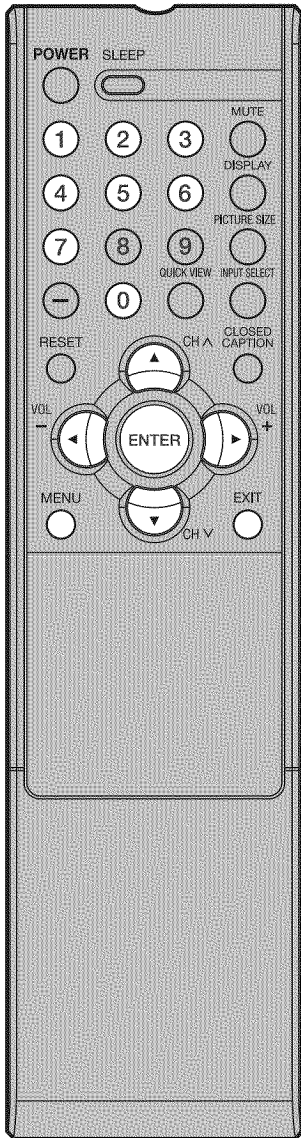

# Selecting the digital output/ Resetting your audio adjustments

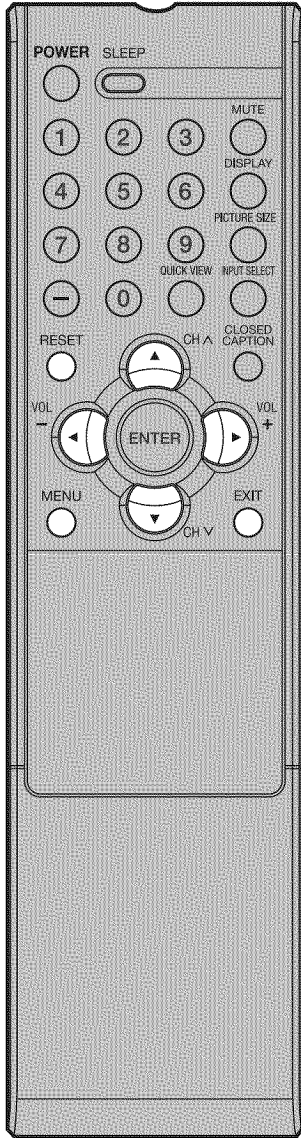

## Selecting the digital output

You can choose the format of the digital audio output signal.

- 1 Press **MENU**, then press ◀ or ▶ to select (AUDIO) menu.

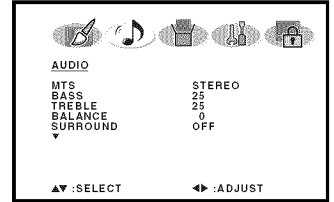

- 2 Press ▲ or ▼ to select "DIGITAL OUTPUT", then press ◀ or ▶ to select "PCM" or "DOLBY DIGITAL".

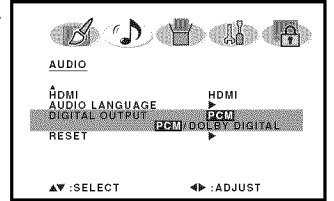

- 3 Press **EXIT** to return to the normal screen.

## Resetting your audio adjustments

The **RESET** function returns the audio adjustments to the following factory settings:

- BASS..... center (25)
- TREBLE ..... center (25)
- BALANCE ..... center (0)

- 1 Press **MENU**, then press ◀ or ▶ to select (AUDIO) menu.

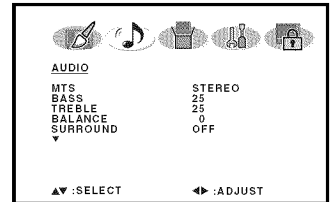

- 2 Press ▲ or ▼ to select "RESET", and then press ▶.

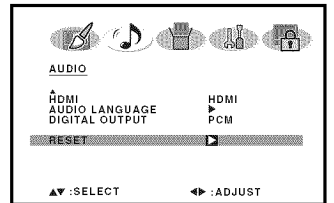

### NOTE:

When you press **RESET** in (AUDIO) menu, the audio adjustment returns to the factory preset levels.

# Checking the Digital-signal strength

This TV will allow you to view the digital signal meter for digital channels.

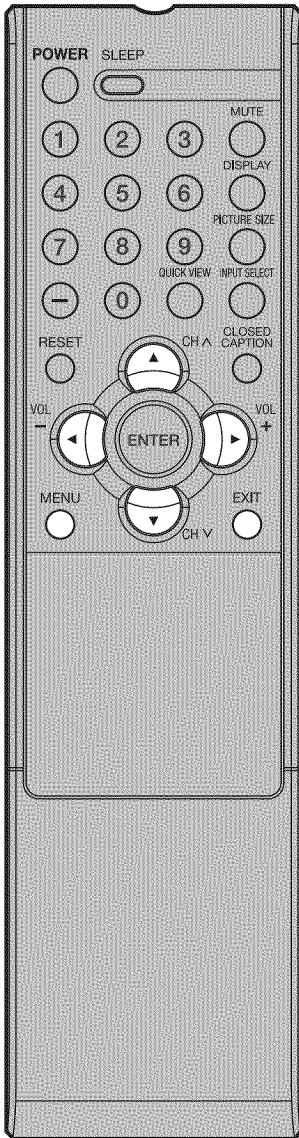

- 1 Press **MENU**, then press ◀ or ▶ to select  (SETUP) menu.

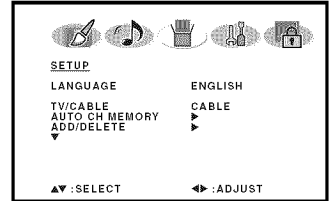

- 2 Press ▲ or ▼ to select "SIGNAL METER".

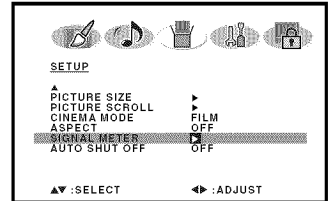

- 3 Press ◀ or ▶ to check the Digital-signal strength.

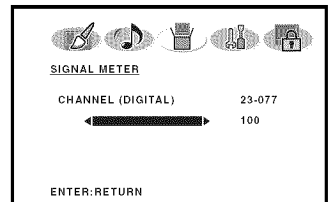

- 4 Press **EXIT** to return to the normal screen.

## NOTES:

- Signal meter feature is not available for analog channels.
- After 240 seconds, SIGNAL METER screen will return to normal TV-operation automatically.

# Setting the auto shut off

In case of "AUTO SHUT OFF" feature is "ON", if a station being viewed stops broadcasting, the TV will automatically shut itself off after 15 minutes.

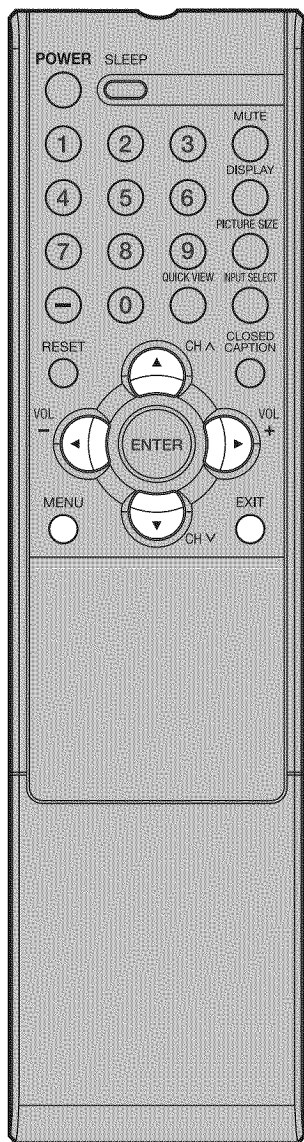

- 1 Press **MENU**, then press ◀ or ▶ to select  (SETUP) menu.

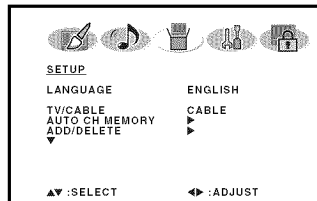

- 2 Press ▲ or ▼ to select "AUTO SHUT OFF".

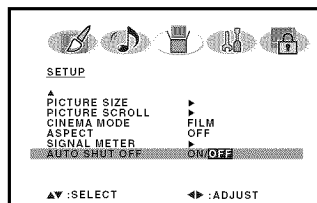

- 3 Press ◀ or ▶ to select "ON" or "OFF".

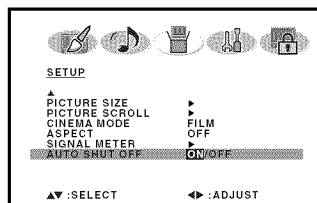

- 4 Press **EXIT** to return to the normal screen.



# Picture/Audio control adjustment in the PC mode

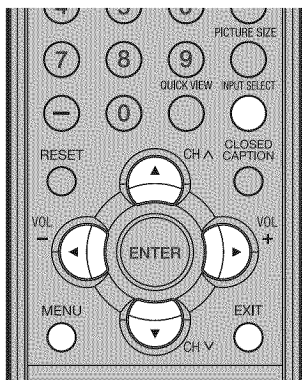

## PC Monitor Menu

There are a number of picture and audio settings you can adjust to optimize the performance of the TV in PC mode.

Press **INPUT SELECT** repeatedly to select PC mode.  
Press **MENU**. The PC Monitor Menu will appear.

### PICTURE Menu

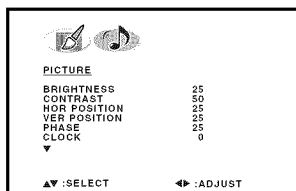

### AUDIO Menu

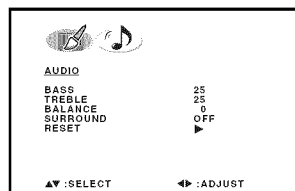

## NOTES:

- If you wish to change the on-screen language, follow the steps 1 - 5 on page 17.
- If no buttons are pressed for more than approx. 60 seconds, the PC Monitor Menu-screen will return to normal Monitor-screen automatically.
- The PC Monitor Menu settings are not effective for normal mode, or external input mode.

**Example:** Adjust the contrast.

- 1 Press **MENU** during PC mode, then press ◀ or ▶ to select  (PICTURE) menu.
- 2 Press ▲ or ▼ to select **CONTRAST**.
- 3 Press ◀ or ▶ to adjust the setting.
- 4 Press **EXIT** to return to the normal screen.

## Picture menu setting:

<b>BRIGHTNESS:</b>	To adjust the brightness of PC Monitor-screen.
<b>CONTRAST:</b>	To adjust the contrast of PC Monitor-screen.
<b>HOR POSITION:</b>	To adjust the horizontal position of the image on the PC Monitor-screen.
<b>VER POSITION:</b>	To adjust the vertical position of the image on the PC Monitor-screen.
<b>PHASE:</b>	This must be adjusted after the frequency of your PC has been set to 60hz to optimize picture quality (page 16).
<b>CLOCK:</b>	To minimize any vertical bars or stripes visible on the screen background.
<b>RED/GREEN/BLUE:</b>	To adjust the color temperature
<b>WXGA INPUT:</b>	Set to ON, when you select the WXGA mode on the PC.
<b>BACKLIGHT:</b>	To adjust the screen brightness for improved picture clarity.

## Audio menu setting:

<b>BASS/TREBLE/BALANCE:</b>	To adjust the sound quality of PC mode.
<b>SURROUND:</b>	To turn on or off the surround effect in PC mode.

# Picture/Audio control adjustment in the PC mode

## Resetting your picture/audio adjustment in the PC mode

The RESET function returns your picture/audio adjustment to the following factory settings:



### PICTURE menu

BRIGHTNESS ..... center (25)  
CONTRAST ..... max (50)  
RED ..... center (25)  
GREEN ..... center (25)  
BLUE ..... center (25)  
BACKLIGHTING ..... max (16)

### AUDIO menu

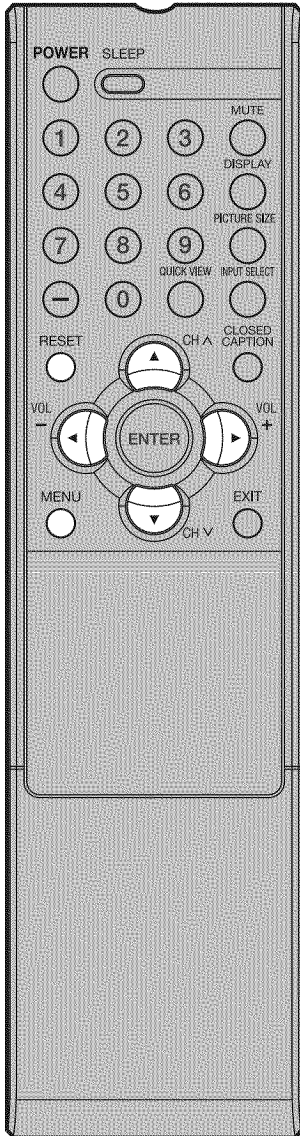
BASS ..... center (25)  
TREBLE ..... center (25)  
BALANCE ..... center (0)



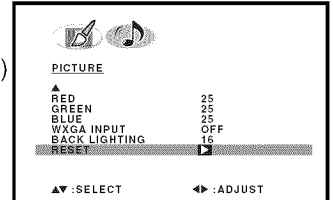

- 1 Press **MENU** during PC mode, then press ◀ or ▶ to select  (PICTURE) or  (AUDIO) menu.



- 2 Press ▲ or ▼ to select "RESET", then press ▶.

### NOTE:

When you press **RESET** in  (PICTURE) or  (AUDIO) menu, the picture or audio adjustment returns to the factory preset level.

# Reception disturbances

Most types of television interference can be remedied by adjusting the height and position of the VHF/UHF antenna. Outdoor antennas are recommended for best results. The most common types of television interference are shown below. If one of these symptoms appear when the TV is connected to a Cable TV system, the disturbance may be caused by the local Cable TV company broadcast.

## IGNITION

Black spots or horizontal streaks may appear, the picture may flutter or drift. Usually caused by interference from automobile ignition systems, neon lamps or AC powered tools and appliances such as drills or hair dryers.



## GHOSTS

Ghosts are caused by the television signal following two paths. One is the direct path and the other is reflected by tall buildings, hills or other large objects. Changing the direction or position of the antenna may improve the reception.

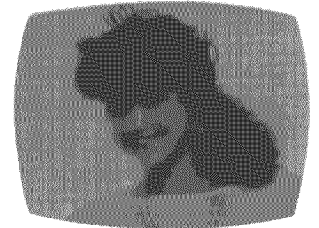

## SNOW

If the TV is located far from the TV station, in a fringe reception area where the signal is weak, small dots may appear in the picture. If the signal is extremely weak, the installation of a larger external antenna may be necessary.

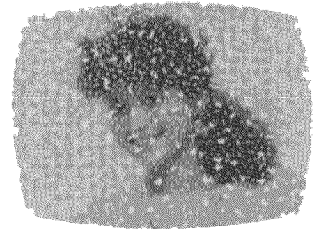

## RADIO FREQUENCY INTERFERENCE (RFI)

Caused by two-way radios, this type of interference produces moving ripples or diagonal streaks in the picture. Some cases may cause a loss of contrast in the picture. Changing the direction and position of the antenna or installing an RFI filter may improve the picture.

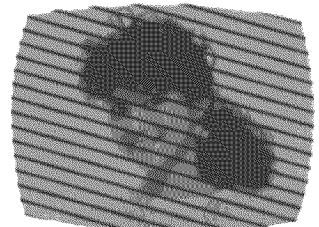

## PICTURE SIZE VARIATION

A slight picture size variation is normal when you adjust the CONTRAST or BRIGHTNESS settings.



## CARE AND MAINTENANCE

To prevent fire or shock hazard, disconnect the TV from the power source before cleaning. The finish on the cabinet may be cleaned with mild soap and a soft, damp cloth and cared for as other furniture. Use caution when cleaning or wiping the plastic parts.

# Troubleshooting

Use the following checklist for troubleshooting if you have problems with your LCD TV. Consult your local dealer or service outlet if problems persist. Be sure all connections are properly made when using with other units.

SYMPTOMS	POSSIBLE SOLUTIONS	SYMPTOMS	POSSIBLE SOLUTIONS
TV does not operate.	<ul style="list-style-type: none"> <li>• Make sure the power cord is plugged in.</li> <li>• Try another AC outlet.</li> <li>• Power is off, check fuse or circuit breaker.</li> <li>• Unplug unit for an hour, then plug it back in.</li> </ul>	No CATV reception.	<ul style="list-style-type: none"> <li>• Check all CABLE connections.</li> <li>• Set TV/CABLE menu option to the CABLE mode.</li> <li>• Station or CABLE system problems, try another station.</li> </ul>
Poor sound or no sound.	<ul style="list-style-type: none"> <li>• Station or CABLE experiencing problems, tune to another station.</li> <li>• Check sound adjustments (Volume and Mute).</li> <li>• Check for sources of possible interference.</li> </ul>	Horizontal or diagonal bars on screen.	<ul style="list-style-type: none"> <li>• Check antenna connections, adjust or re-direct antenna.</li> <li>• Check for sources of possible interference.</li> </ul>
Poor picture or no picture.	<ul style="list-style-type: none"> <li>• Station or CABLE experiencing problems, tune to another station.</li> <li>• Make sure channels are set into memory.</li> <li>• Check antenna or CABLE connections, adjust antenna.</li> <li>• Check for sources of possible interference.</li> <li>• Check picture control adjustments.</li> </ul>	No reception above channel 13.	<ul style="list-style-type: none"> <li>• Make sure TV/CABLE menu option is in the appropriate mode.</li> <li>• If using antenna, check UHF antenna connections.</li> </ul>
Poor reception on some channels.	<ul style="list-style-type: none"> <li>• Station or CABLE experiencing problems, tune to another station.</li> <li>• Make sure channels are set into memory.</li> <li>• Station is weak, adjust antenna to receive desired station.</li> <li>• Check for sources of possible interference.</li> </ul>	No Remote operation.	<ul style="list-style-type: none"> <li>• Batteries are weak, dead or inserted incorrectly.</li> <li>• Remote is out of range, move closer to TV (within 15 feet).</li> <li>• Make sure Remote is aimed at sensor.</li> <li>• Confirm there are no obstructions between the Remote and the TV.</li> <li>• Make sure the power cord is plugged in.</li> </ul>
Poor color or no color.	<ul style="list-style-type: none"> <li>• Station or CABLE experiencing problems, tune to another station.</li> <li>• Make sure channels are set into memory.</li> <li>• Check picture control adjustments.</li> <li>• Check antenna or CABLE connections, adjust antenna.</li> <li>• Check for sources of possible interference.</li> </ul>	TV shuts off.	<ul style="list-style-type: none"> <li>• No broadcast on station tuned.</li> <li>• Sleep Timer is set.</li> <li>• Power interrupted.</li> </ul>
Picture wobbles or drifts.	<ul style="list-style-type: none"> <li>• Station or CABLE experiencing problems, tune to another station.</li> <li>• Make sure channels are set into memory.</li> <li>• CABLE company is scrambling signal.</li> <li>• Adjust antenna.</li> </ul>	Closed - Caption is not activated.	<ul style="list-style-type: none"> <li>• TV station experiencing problems or program tuned is not closed captioned. Try another channel.</li> <li>• Check CABLE connection or VHF/UHF antenna, reposition or rotate antenna.</li> <li>• Set closed caption decoder in the menu.</li> </ul>
Digital broadcasting screen problem.	<ul style="list-style-type: none"> <li>• Check digital signal strength.</li> </ul>	TV is not shown in your language.	<ul style="list-style-type: none"> <li>• Select proper language in the menu options.</li> </ul>



FOR CUSTOMER SERVICE,  
ADDITIONAL SET-UP OR  
OPERATING ASSISTANCE  
PLEASE CALL:

1-800-289-0980

TO ORDER ACCESSORY  
PARTS OR LITERATURE

PLEASE CALL:

1-888-369-0304

**WHEN CALLING CUSTOMER SERVICE – PLEASE HAVE YOUR MODEL NUMBER READY**

OR WRITE TO:  
**ORION SALES, INC.**  
3471 N. UNION DR.  
OLNEY, ILLINOIS 62450

FOR INFORMATION ON OUR OTHER PRODUCTS, PLEASE VISIT OUR WEBSITE AT  
[www.orionsalesinc.com](http://www.orionsalesinc.com)

# Specifications

Power supply:	AC 120 V 60 Hz
Power consumption:	Operation: 170 W Stand by: 1 W
Weight:	35.3 lbs (16.0 kg)
Dimensions:	Width: 32-3/8 inches (822 mm) Height: 23-3/4 inches (604 mm) Depth: 11-1/8 inches (282.5 mm)
Inputs:	VIDEO: 1 V (p-p)/75 ohms AUDIO: -8 dBm/50k ohms S-VIDEO: Y: 1 V (p-p), 75 ohms C: 0.286 V (p-p), 75 ohms COMPONENT: Y: 1 V (p-p), 75 ohms PR: 0.7 V (p-p), 75 ohms PB: 0.7 V (p-p), 75 ohms
Digital audio out:	0.5 Vp-p 75 ohms terminated
HDMI input:	HDMI compliant (type A connector) HDCP compliant E-EDID compliant Suggested scan rates: 1080i, 480p, 480i, 720p HDMI Audio: 2-channel PCM 32/44.1/48 kHz sampling frequency 16/20/24 bits per sample
PC Monitor input:	Mini-Dsub 15pin x 1
Type:	31.5 inches (800.4 mm diagonal)
Number of Pixels:	1366 (H) x 768 (V)
Viewing angle:	Left/Right: 88/88 degree Up/Down: 88/88 degree
Antenna input:	VHF/UHF/CABLE In 75 ohm coaxial
Tuner type:	NTSC standard ATSC standard (8VSB), QAM
Receiving channels:	VHF 2-13 UHF 14-69 CABLE 14-36 (A)-(W) 37-59 (AA)-(WW) 60-85 (AAA)-(ZZZ) 86-94 (86)-(94) 95-99 (A-5)-(A-1) 100-125 (100)-(125) 01 (5A)
Speaker:	2-3/16 inches (56 mm) x 5 inches (127 mm), 4 ohms x 2
Sound output power:	5 W + 5 W
<b>ACCESSORIES:</b>	Remote control Batteries (UM-3) x 2 AC Cord

**Designs and specifications are subject to change without notice.**



## LIMITED WARRANTY

### 32" WIDE LCD TELEVISION

ORION warrants this product to be free from manufacturing defects in material and workmanship under normal use and conditions for a period of 1 year from date of original purchase in the United States.

Should service be necessary under this warranty for any reason due to a manufacturing defect or malfunction during the first 12 months from date of original purchase, ORION will provide in-home repair service by an ORION authorized Independent Service Center at no charge. Also, if an original part fails due to manufacturing defect in material and workmanship within one year from date of original purchase we will replace the defective part, provided the defect or malfunction is verified along with dated proof of purchase.

There are ORION authorized Independent Service Centers located throughout the country. For the one nearest you, DIAL TOLL FREE: 1-800-289-0980 or visit our website at [www.orionsalesinc.com](http://www.orionsalesinc.com). ORION will not be liable for damages incurred in shipment of the unit. If there are no ORION authorized Independent Service Centers in your area please call - 1-888-296-7466 for assistance.

**Note: This warranty is void if the product is:**

- (a) Damaged through negligence, misuse, abuse, or accident.
- (b) Used in a commercial application or rentals.
- (c) Modified or repaired by anyone other than an Independent Service Center authorized by ORION to effect warranty repairs to the class of product or by the ORION Factory Service Center.
- (d) Damaged because it is improperly connected to the equipment of other manufacturers.

**This warranty does not cover:**

- (a) Damage to equipment not properly connected to the product.
- (b) Costs incurred in the shipping of the product to an ORION authorized Independent Service Center or ORION Factory Service Center.
- (c) Damage or improper operation of unit caused by customer abuse, misuse, negligence, or failure to follow operating instructions provided with the product.
- (d) Ordinary adjustments to the product which can be performed by customer as outlined in the owner's manual.
- (e) Signal reception problems caused by external antenna or cable systems.

THIS WARRANTY IS NON TRANSFERABLE AND APPLIES ONLY TO THE ORIGINAL PURCHASER AND DOES NOT EXTEND TO SUBSEQUENT OWNERS OF THE PRODUCT. ANY APPLICABLE IMPLIED WARRANTIES, INCLUDING THE WARRANTY OF MERCHANTABILITY, ARE LIMITED IN DURATION TO A PERIOD OF THE EXPRESS WARRANTY AS PROVIDED HEREIN BEGINNING WITH THE DATE OF ORIGINAL PURCHASE AT RETAIL AND NO WARRANTIES, WHETHER EXPRESS OR IMPLIED SHALL APPLY TO THIS PRODUCT THEREAFTER. ORION MAKES NO WARRANTY AS TO THE FITNESS OF THE PRODUCT FOR ANY PARTICULAR PURPOSE AND USE.

UNDER NO CIRCUMSTANCES SHALL ORION BE LIABLE FOR ANY LOSS, DIRECT, INDIRECT, INCIDENTAL, SPECIAL, OR CONSEQUENTIAL DAMAGE ARISING OUT OF OR IN CONNECTION WITH THE USE OF THIS PRODUCT.

THIS WARRANTY IS VALID ONLY IN THE UNITED STATES OF AMERICA. THIS WARRANTY GIVES YOU SPECIFIC LEGAL RIGHTS, HOWEVER, YOU MAY HAVE OTHER RIGHTS WHICH MAY VARY FROM STATE TO STATE. SOME STATES DO NOT ALLOW LIMITATION ON IMPLIED WARRANTIES OR EXCLUSION OF CONSEQUENTIAL DAMAGE, THEREFORE THESE RESTRICTIONS MAY NOT APPLY TO YOU.

ORION SALES, INC.  
3471 N. UNION DR.  
OLNEY, ILLINOIS 62450





J32D0101A SH 07/02 ☐

Printed in Thailand