

26" TFT LCD DIGITAL TV WITH DVD PLAYER

HDLCDVD260

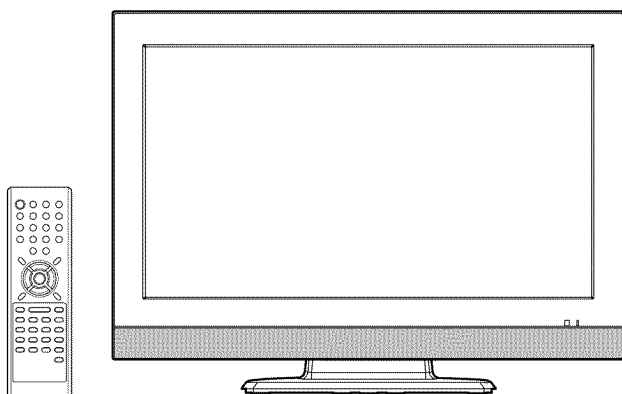

ATTENTION

If you purchase a universal remote control from your local retailer, please contact the remote manufacturer for the required programming code.

TV/CABLE MODE SELECTION

When shipped from the factory, the TV/CABLE menu option is set to the "CABLE" (Cable Television) mode. If not using CABLE, set this menu option to the "TV" position.

IF CONTACT WITH CUSTOMER SERVICE IS REQUIRED
PLEASE HAVE THE MODEL NUMBER READY PRIOR TO THE CALL
CUSTOMER SERVICE – 1-800-289-0980

ORION WEBSITE

FOR INFORMATION ON OUR OTHER PRODUCTS, PLEASE VISIT OUR WEBSITE AT

www.orionsalesinc.com

Before operating the unit, please read this manual thoroughly.

	CAUTION RISK OF ELECTRIC SHOCK DO NOT OPEN	
CAUTION: TO REDUCE THE RISK OF ELECTRIC SHOCK, DO NOT REMOVE COVER (OR BACK). NO USER-SERVICEABLE PARTS INSIDE. REFER SERVICING TO QUALIFIED SERVICE PERSONNEL.		



The lightning flash with arrowhead symbol, within an equilateral triangle is intended to alert the user to the presence of uninsulated dangerous voltage within the product's enclosure that may be of sufficient magnitude to constitute a risk of electric shock.



The exclamation point within an equilateral triangle is intended to alert the user to the presence of important operating and maintenance (servicing) instructions in the literature accompanying the appliance.

WARNING: TO PREVENT FIRE OR SHOCK HAZARD, DO NOT EXPOSE THIS APPLIANCE TO RAIN OR MOISTURE.
CAUTION: TO PREVENT ELECTRIC SHOCK DO NOT USE THIS POLARIZED PLUG WITH AN EXTENSION CORD, RECEPTACLE OR OTHER OUTLET UNLESS THE BLADES CAN BE FULLY INSERTED TO PREVENT BLADE EXPOSURE.

WARNING: This equipment has been tested and found to comply with the limits for a Class B digital device, pursuant to Part 15 of the FCC Rules. These limits are designed to provide reasonable protection against harmful interference in a residential installation. This equipment generates, uses and can radiate radio frequency energy and, if not installed and used in accordance with the instructions, may cause harmful interference to radio communications. However, there is no guarantee that interference will not occur in a particular installation. If this equipment does cause harmful interference to radio or television reception, which can be determined by turning the equipment off and on, the user is encouraged to try to correct the interference by one or more of the following measures:

- Reorient or relocate the receiving antenna.
- Increase the separation between the equipment and receiver.
- Connect the equipment into an outlet on a circuit different from that to which the receiver is connected.
- Consult the dealer or an experienced radio/TV technician for help.

CAUTION: Changes or modifications not expressly approved by the party responsible for compliance with the FCC Rules could void the user's authority to operate this equipment.

<p>CAUTION: THIS DIGITAL VIDEO PLAYER EMPLOYS A LASER SYSTEM. TO ENSURE PROPER USE OF THIS PRODUCT, PLEASE READ THIS OWNER'S MANUAL CAREFULLY AND RETAIN FOR FUTURE REFERENCE. SHOULD THE UNIT REQUIRE MAINTENANCE, CONTACT AN AUTHORIZED SERVICE LOCATION-SEE SERVICE PROCEDURE.</p> <p>USE OF CONTROLS, ADJUSTMENTS OR THE PERFORMANCE OF PROCEDURES OTHER THAN THOSE SPECIFIED HEREIN MAY RESULT IN HAZARDOUS RADIATION EXPOSURE.</p> <p>TO PREVENT DIRECT EXPOSURE TO THE LASER BEAM, DO NOT TRY TO OPEN THE ENCLOSURE. RADIATION MAY BE PRESENT WHEN THE ENCLOSURE IS OPENED. DO NOT STARE INTO THE BEAM.</p>

Location of the required Marking

The rating sheet and the safety caution are on the rear of the unit.

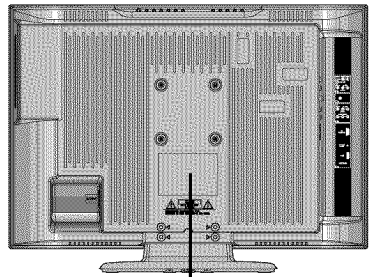

CERTIFICATION: COMPLIES WITH FDA RADIATION PERFORMANCE STANDARDS, 21 CFR SUBCHAPTER J.

<p>The lamp(s) within this product contain mercury. Disposal should be in compliance with local, state or federal laws.</p>

IMPORTANT SAFETY INSTRUCTIONS

- 1) Read these instructions.
- 2) Keep these instructions.
- 3) Heed all warnings.
- 4) Follow all instructions.
- 5) Do not use this apparatus near water.
- 6) Clean only with a clean dry cloth.
- 7) Do not block any ventilation openings. Install in accordance with the manufacturer's instructions.
- 8) Do not install near any heat sources such as radiators, heat registers, stoves, or other apparatus (including amplifiers) that produce heat.
- 9) Do not defeat the safety purpose of the polarized or grounding-type plug. A polarized plug has two blades with one wider than the other. A grounding type plug has two blades and a third grounding prong. The wide blade and the third prong are provided for your safety. If the provided plug does not fit into your outlet, consult an electrician to replace the obsolete receptacle.
- 10) Protect the power cord from being walked on or pinched particularly at plug, and the point where it exits from the apparatus.
- 11) Only use attachments/accessories specified by the manufacturer.
- 12) Use only with the cart, stand, tripod, bracket, or table specified by the manufacturer, or sold with the apparatus. When a cart is used, use caution when moving the cart/apparatus combination to avoid injury from tip-over.
- 13) Unplug this apparatus during lightning storms or when unused for long periods of time.
- 14) Refer all servicing to qualified service personnel. Servicing is required when the apparatus has been damaged in any way, such as power-supply cord or plug damage, liquid has been spilled or objects have fallen into the apparatus, the apparatus has been exposed to rain or moisture, does not operate normally, or has been dropped.
- 15) Apparatus should not be exposed to dripping or splashing, and objects filled with liquids, such as vases, should not be placed on the apparatus.
- 16) An outside antenna system should not be located in the vicinity of overhead power lines or other electric light or power circuits, or where it can fall into such power lines or circuits. When installing an outside antenna system, extreme care should be taken to keep from touching such power lines or circuits, as contact with them might be fatal.
- 17) Do not overload wall outlets and extension cords, as this can result in a risk of fire or electric shock.
- 18) Do not push objects through any openings in this unit, as they may touch dangerous voltage points or short out parts that could result in fire or electric shock. Never spill or spray any type of liquid into the unit.
- 19) If an outside antenna or cable system is connected to the unit, be sure the antenna or cable system is grounded to provide some protection against voltage surges and built-up static charges, Section 810 of the National Electrical Code, ANSI/NFPA 70, provides information with respect to proper grounding of the mast and supporting structure, grounding of the lead-in wire to an antenna discharge unit, size of grounding conductors, location of antenna discharge unit, connection to grounding electrodes, and requirements for the grounding electrode.

PORTABLE CART WARNING
(symbol provided by RETAC)



S3126A

IMPORTANT SAFETY INSTRUCTIONS (continued)

EXAMPLE OF ANTENNA GROUNDING AS PER THE NATIONAL ELECTRICAL CODE

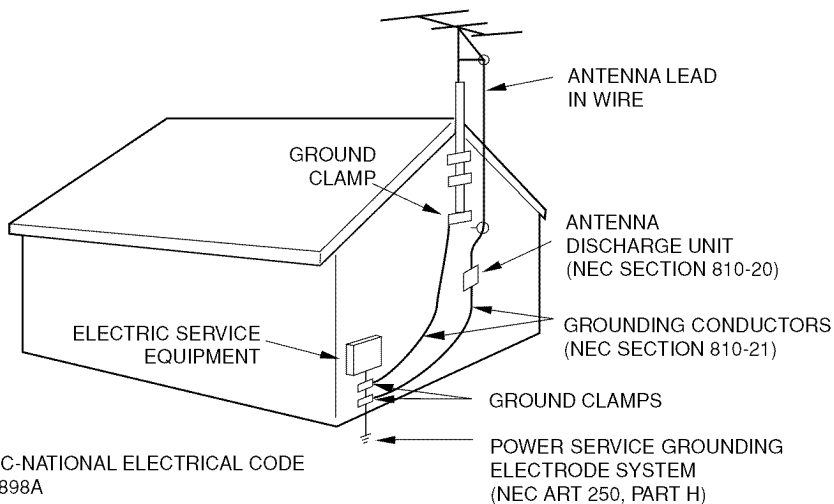

NEC-NATIONAL ELECTRICAL CODE
S2898A

- 20) When replacement parts are required, be sure the service technician uses replacement parts specified by the manufacturer or those that have the same characteristics as the original part.
Unauthorized substitutions may result in fire, electric shock or other hazards.
- 21) Upon completion of any service or repairs to this unit, ask the service technician to perform safety checks to determine that the unit is in proper operating condition.
- 22) Keep your fingers clear of the disc slot as it is closing. It may cause injury.
- 23) When you connect the product to other equipment, turn off the power and unplug all of the equipment from the wall outlet. Failure to do so may cause an electric shock and serious personal injury. Read the owner's manual of the other equipment carefully and follow the instructions when making any connections.
- 24) Reduce the volume to the minimum level before you turn on the product. Otherwise, sudden high volume sound may cause hearing or speaker damage.
- 25) Do not allow the product to output distorted sound for an extended period of time. It may cause speaker overheating and fire.
- 26) When you use the headphones, keep the volume at a moderate level. If you use the headphones continuously with high volume sound, it may cause hearing damage.
- 27) Do not look into the opening of the disc slot or ventilation opening of the product to see the source of the laser beam. It may cause eye damage.
- 28) Do not use a cracked, deformed, or repaired disc. These discs are easily broken and may cause serious personal injury and product malfunction.
- 29) This reminder is provided to call the cable TV system installer's attention to Article 820-40 of the NEC that provides guidelines for proper grounding and, in particular, specifies that the cable ground shall be connected to the grounding system of the building, as close to the point of cable entry as practical.

IMPORTANT SAFETY INSTRUCTIONS (continued)

CONDENSATION

Moisture will form in the operating section of the player if the player is brought from cool surroundings into a warm room or if the temperature of the room rises suddenly. When this happens, player's performance will be impaired.

To prevent this, let the player stand in its new surroundings for about an hour before switching it on, or make sure that the room temperature rises gradually.

Condensation may also form during the summer if the player is exposed to the breeze from an air conditioner. In such cases, change the location of the player.

HOW TO HANDLE THE LCD PANEL

- Do not press hard or jolt the LCD panel. It may cause the LCD panel glass to break and injury may occur.
- If the LCD panel is broken, make absolutely sure that you do not touch the liquid in the panel. This may cause skin inflammation.

If the liquid gets in your mouth, immediately gargle and consult with your doctor. Also, if the liquid gets in your eyes or touches your skin, consult with your doctor after rinsing for at least 15 minutes or longer in clean water.

SAFETY PRECAUTIONS

The unit emits heat when in operation. Do not place any covers or blankets on the unit, this may cause overheating. Do not block ventilation holes, or set up near radiators. Do not place in direct sunshine. When placing on a shelf leave 10 cm (4 inches) free space around the entire unit.

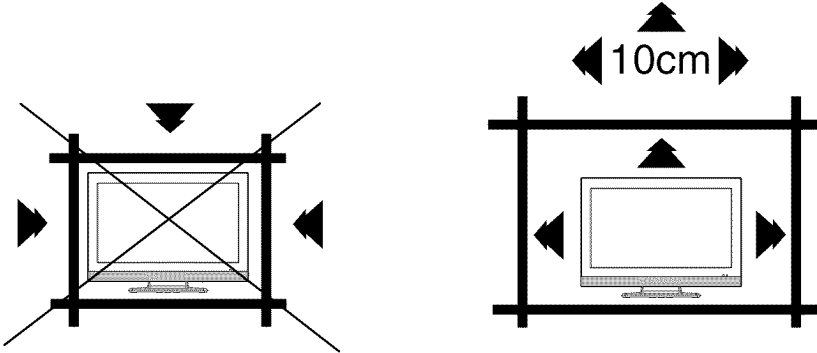

Notes when mounting the LCD TV/DVD on a wall

- When installing the unit on a wall, allow at least 6 cm (2 1/2 inches) clearance between the rear of the LCD TV/DVD and the wall. Clearance of less than 6 cm (2 1/2 inches) will obstruct the vents and may cause the interior of the unit to overheat, resulting in damage to the unit.
- If the unit is to be mounted on the wall, contact the retailer where you purchased the LCD TV/DVD for advice, and have the equipment professionally installed. Incomplete or improper installation may cause injury to you, and/or damage to the LCD TV/DVD.

IMPORTANT NOTICE

Possible Adverse Effects on LCD Panel: If a fixed (non-moving) pattern remains on the LCD Panel for long periods of time, the image can become permanently engrained in the LCD Panel and cause subtle but permanent ghost images. This type of damage is NOT COVERED BY YOUR WARRANTY. Never leave your LCD Panel on for long periods of time while it is displaying the following formats or images:

- Fixed Images, such as stock tickers, video game patterns, TV station logos, and websites.
- Special Formats that do not use the entire screen. For example, viewing letterbox style (16:9) media on a normal (4:3) display (black bars at top and bottom of screen); or viewing normal style (4:3) media on a widescreen (16:9) display (black bars on left and right sides of screen).

The following symptoms are not signs of malfunction but technical limitation. Therefore we disclaim any responsibility for these symptoms.

- LCD Panels are manufactured using an extremely high level of precision technology, however sometimes parts of the screen may be missing picture elements or have luminous spots. This is not a sign of a malfunction.
- Do not install the LCD Panel near electronic equipment that is susceptible to electromagnetic waves. Some equipment placed too near this unit may cause interference.
- Effect on infrared devices – There may be interference while using infrared devices such as infrared cordless headphones.

LCD color TV With DVD/CD player

Unique space saving design combines a 26" LCD color TV and a DVD/CD player.

A DVD disc has much more capacity, but is the same size as an audio CD disc. The Picture/Audio quality of a DVD exceeds other software. The picture quality is higher than Super VHS video cassettes. The audio quality is higher than an audio CD. The DVD also has special options; audio language selection, subtitle language selection, or multi-angle, etc.

The DVD PLAYER can play back both audio CDs and MP3/WMA/JPEG CDs.

Compatible with a wide range of DVD audio outputs

Digital Audio Jack (Coaxial)

- When a component with a built-in Dolby Digital decoder is connected, Dolby Digital sound can produce the effect of being in a movie theater or a concert hall.
- Surround standard is different from Dolby Digital. This format is already in use in many theaters. By connecting this unit to a DTS decoder or an AV amplifier with a built-in DTS decoder, the DTS audio of DVD discs recorded in this format can be enjoyed. However, audio will not be output from the analog audio output jacks.
- By connecting this unit to an AV amplifier with a built-in MPEG decoder, the MPEG audio of DVD discs recorded in this format can be enjoyed.
- The Linear PCM sound of a 48 kHz/24 bit through 96 kHz/24 bit exceeds audio CD sound.

Convenience Features

Direct selection of your desired scenes using Title/Chapter/Time/Track - You can play back from the desired scene.

Recalling Up to 3 Scenes (DVD only) - You can program up to 3 scenes in memory and recall the marked scenes.

Frame Advance - The **PAUSE/STILL** moves one frame at a time.

Slow Motion - The **SLOW** moves you back and forth through the program by 4 steps of 1/7-1/2 times.

Repeat Playback - You can repeat chapter, track, title, sides or material between two selected points.

Program Playback (Audio CD/MP3/WMA CD) - You can play back tracks in programmed sequences.

Zoom (DVD only) - You can zoom in the selected subject on the screen during playback.

Note: Make sure that discs are suitable for the following functions.

Multi-Language - Maximum 32 language subtitles and maximum 8 language soundtracks can be played back for movies or programs.

Multi-Angle - Pictures of Sports or a Live Concert are recorded with many cameras. When you play such a disc, you can change the angles during playback.

Parental Control - You can limit the play back of scenes or sounds of DVD discs that have a rating level encoded on the disc.

Video Aspect Ratio - You can change the aspect ratio of the screen for your monitor.

TV Features

Integrated Digital Tuner - You can view digital broadcasts without using a Digital TV Set-Top Box.

Closed Caption Decoder With Full Text Mode - Displays text captions or full screen text on the screen for hearing impaired viewers.

Picture Adjustments Using The Remote Control - The On-Screen display allows precise remote control adjustment of BRIGHTNESS, CONTRAST, COLOR, TINT and SHARPNESS.

Programmable TV Sleep Timer - Operable from the remote control, the TV can be programmed for up to 120 minutes to turn off automatically.

On-Screen 3 Language Display - You can select one of 3 languages, English, Spanish or French for on-screen programming.

V-Chip - The V-Chip function can read the rating of a TV program or movie content if the program is encoded with this information. V-chip will allow you to set a restriction level.

* This product incorporates copyright protection technology that is protected by U.S. patents and other intellectual property rights. Use of this copyright protection technology must be authorized by Macrovision, and is intended for home and other limited viewing uses only unless otherwise authorized by Macrovision. Reverse engineering or disassembly is prohibited.

* **DVD** is a trademark of DVD Format/Logo Licensing Corporation.

* Manufactured under license from Dolby Laboratories. "Dolby" and the double-D symbol are trademarks of Dolby Laboratories.

* "DTS" and "DTS Digital Out" are registered trademarks of DTS, Inc.

Contents

Before using your unit

IMPORTANT SAFETY INSTRUCTIONS	3
SAFETY PRECAUTIONS	6
IMPORTANT NOTICE	6
Features	7
Contents	8
Disc	9
Location of controls	10
Remote control	12
Power source	13
Antenna connections	14
Cable TV connections	15

TV operation

Setting the on-screen display language	16
TV operation	17
Memorizing channels	19
Setting the V-Chip	21
Labeling channels	24
Selecting the video input source	25
Labeling the video input source	25
Setting the picture size	26
Setting the picture scroll	28
Selecting the cinema mode	29
Using the aspect feature	29
Adjusting the picture preference	30
Picture control adjustment	30
Selecting the color temperature	31
Adjusting the back lighting feature	31
Resetting your picture adjustments	31
Closed Caption	32
CC advanced	33
Selecting Stereo/Second Audio Program (SAP)	34
Sound control adjustment	34
Selecting the HDMI audio input source	35
Selecting the audio language	35
Selecting the digital output	36
Resetting your audio adjustments	36
Checking the Digital-signal strength	37
Setting the auto shut off	37
Picture/Audio control adjustment in the PC mode	38

Playback operation

Preparation	40
Status display of disc	40
Playback procedure	41
Special playback	42
MP3/WMA/JPEG and Audio CD playback	43
Setting the JPEG interval	45



Advanced function

Program playback (CD)	46
Repeat playback (CD)	47
Random playback (CD)	47
Zooming	48
Locating desired scene	48
Repeat playback	49
Marking desired scenes	50
Changing soundtrack language	51
Subtitles	51
Changing angles	52
Title selection	52
DVD menu	52

Additional information

Setting the language	53
Setting the aspect ratio of TV screen	54
Setting on screen display	54
Setting the picture mode	55
Night Mode	56
Digital out	56
Parental control setting	57
Setting the new password	58
Temporary disabling of rating level by DVD disc	59
Language code list	60
Connections to other equipment	61
Reception disturbances	64
Problems and troubleshooting	65
Specifications	67
Limited WARRANTY	Back cover

Playable discs

Disc type and logo mark	content
 DVD Video	Audio + Video (moving pictures)
 CD-DA	Audio

The following discs are also available.

- DVD-R/RW discs of DVD video format.
- CD-R/RW discs of MP3/WMA/JPEG.

CAUTION:

- Only the left types of discs can be played on this unit. DVD-ROM, CD-ROM, SVCD, CVD, VCD, etc. cannot be played.
- 8cm discs can be played directly. If an 8cm disc adapter is used it will cause errors.
- If you insert an irregular shaped disc, it may get stuck and cause a malfunction.
- The use of a ring protector or other disc accessories will cause errors.
- This unit is to be used exclusively with the NTSC color system. PAL and SECAM system discs cannot be used with this unit.
- Some CD-R/RWs and DVD-R/RW can not be played back depending on the recording conditions.

Region Number

Region number (Regional restriction code) is built-in to the unit and DVD video discs.

Region number "1" or "ALL" of DVD video discs can be used on this unit.



Title

When two or more movies are recorded on a disc, the disc is divided into two or more sections. Each section is called a "TITLE".

Chapter

The titles can be subdivided into many sections. Each section is called a "CHAPTER".

Track

An Audio CD can contain several items. These are assigned to the tracks.

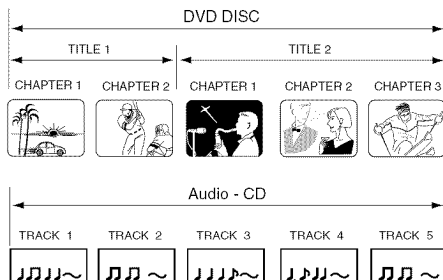

Removing Disc from Case

Be sure to hold the edge of disc. Do not touch the surface of the disc. Pick up the disc gently from the case.

- Do not scratch the disc.
- Do not get dirt on the surface of the disc.
- Do not stick a label or adhesive tape on the disc.
- Do not drop or bend the disc.

Storing Disc

- Store the disc in the case to avoid risk of scratches, dirt or damage.
- Do not leave disc exposed to direct sunlight or in hot or humid places.

Cleaning Disc

Wipe the disc with a clean, dry cloth from center to edge.

- Do not wipe the disc in a circular motion.
- Do not use liquid or aerosol cleaners.

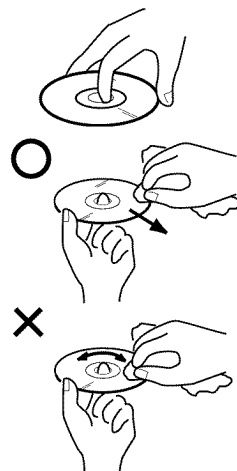

Location of controls

Top

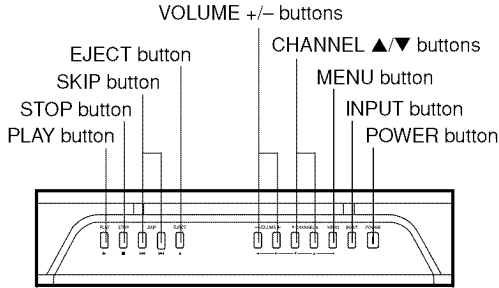

Front

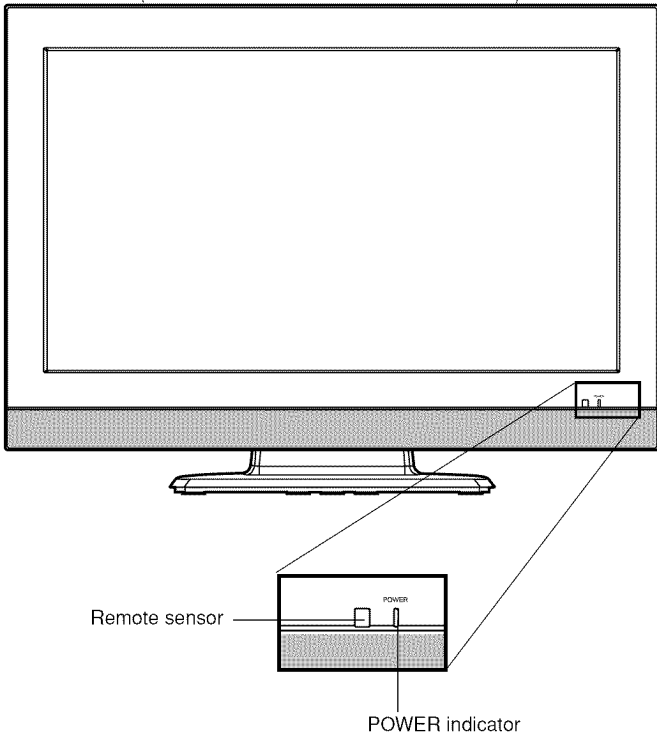

To display the menu screen.

Press MENU button to display the menu screen.

CHANNEL ▲/▼ buttons and VOLUME +/- buttons can be used to select the desired setting during the menu screen operations.

Right side

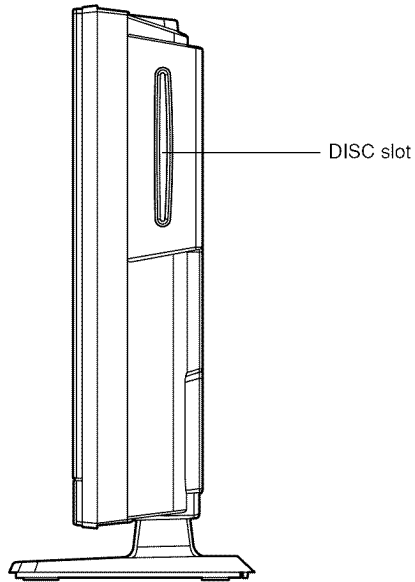

Left side

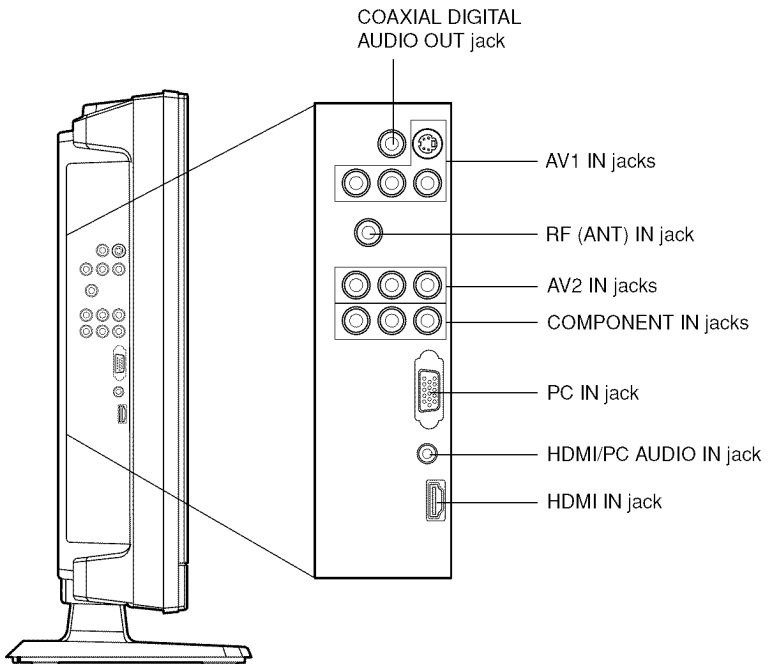

Remote control

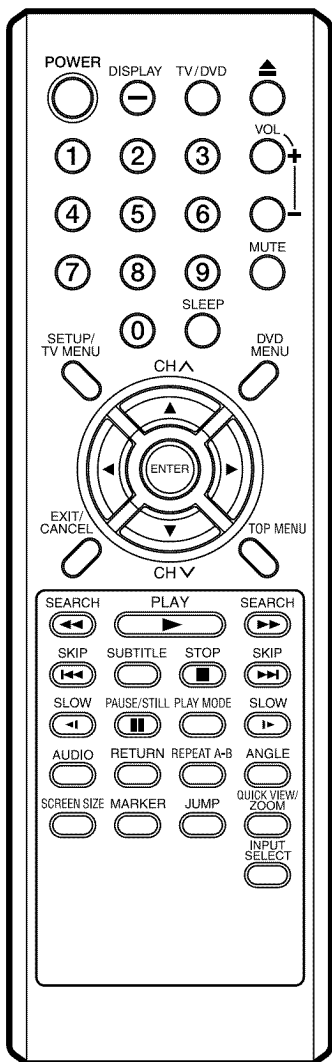

		Page
POWER	Power On/Off	16,17,40,41
DISPLAY/-	Call TV information	18,22
	Call DVD information	40
	Input "-" for digital channels	17
TV/DVD	Switch between TV/AV and DVD	16,40,41
▲ (EJECT)	Eject a disc	41,59
0-9	Direct channel selection of TV	17
	Input setting	25,26,43,44,48
	Enter a password	21~23,57~59
VOL +/-	Adjust volume of TV	17,18
MUTE	Switch off the sound	18,22
SLEEP	Sleep timer	18
SETUP/TV MENU	TV mode - Display menu of TV	16,19~26,30~39
	DVD mode - Call up initial setup mode	45,53~58
DVD MENU	Display DVD menu	52
CH ^/v	Select channel of TV	18
▲▼▶◀	Cursor buttons	16,19~26,28~39,41,43~50,52~59
ENTER	Enter information in the menu	20~24,26,33,36,41,43~50,52~59
EXIT	Exit from On-Screen menu	16,19,20,22~26,28~38
CANCEL	Reset information in the menu	48,50,57,58
TOP MENU	Select title	52
SEARCH	Fast Forward/Review playback	42
PLAY	Playback	41~44,46,47,49,52
SKIP	Skip chapter to forward or reverse direction	42,47
SUBTITLE	Set subtitle	51
STOP	Stop	41,43,44
SLOW	Forward/Reverse- slow motion	42
PAUSE/STILL	Pause CD sound	
	Still picture of DVD	42
PLAY MODE	Select playback mode	49
AUDIO	Display AUDIO menu	34
	Switch the sound of TV	
	Change sound track language	51
RETURN	Remove DVD setup menu	45,53~59
REPEAT A-B	Repeat playback between A and B	49
ANGLE	Change playback angle	52
SCREEN SIZE	Display PICTURE SIZE menu	26
MARKER	Index	50
JUMP	Locating desired scene	48
QUICK VIEW	Switch between present/last channel	18
ZOOM	Zoom	48
INPUT SELECT	Display SOURCE SELECTION menu	25,38

Inserting Batteries

- 1** Open the battery compartment cover in the direction of the arrow.



- 2** Install two "AAA" batteries, paying attention to the polarity diagram in the battery compartment.

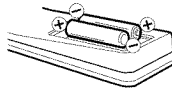

- 3** Replace the compartment cover.



Operation

- Aim the remote control at the remote sensor and press control buttons to operate.
- Operate the remote control within a 30° angle on either side of the remote sensor, up to a distance of approximately 15 feet.

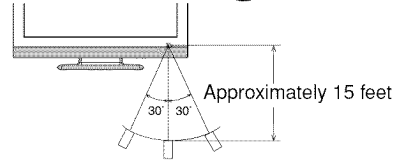

NOTES:

- Do not leave the remote control unit exposed to direct sunlight or in hot or humid places.
- The remote control unit uses infrared beams to transmit signals, so sunlight or fluorescent light on the remote sensor may shorten operating distance.
- Incorrect use of batteries may cause them to leak or burst. Read the battery warnings and use the batteries properly.
- Do not mix old and new batteries.
- Remove batteries if the remote control will not be operated for an extended period of time.

Power source

TO USE AC POWER

1. Connect the AC cord plug into this unit's AC IN jack.
2. Connect the AC cord into an AC outlet.

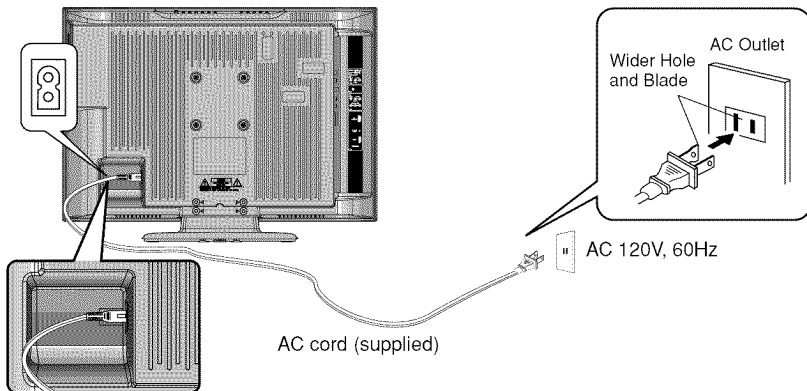

NOTES:

- Please make sure to insert the cord securely at both the LCD TV/DVD and the wall outlet.
- The AC Cord has a grounding-type AC line plug. If the supplied AC cord does not match your AC outlet, contact a qualified electrician, do not defeat the purpose of a grounding plug.

WARNING:

- DO NOT CONNECT THIS UNIT TO THE POWER USING ANY DEVICE OTHER THAN THE SUPPLIED AC CORD. THIS COULD CAUSE FIRE, ELECTRICAL SHOCK, OR DAMAGE.
- DO NOT USE WITH A VOLTAGE OTHER THAN THE POWER VOLTAGE DISPLAYED. THIS COULD CAUSE FIRE, ELECTRICAL SHOCK, OR DAMAGE.

CAUTION:

- WHEN THIS UNIT IS NOT USED FOR A LONG TIME, (E.G., AWAY ON A TRIP) IN THE INTEREST OF SAFETY, BE SURE TO UNPLUG IT FROM THE AC OUTLET.
- DO NOT PLUG/UNPLUG THE PLUG WHEN YOUR HANDS ARE WET. THIS MAY CAUSE ELECTRICAL SHOCK.
- IF YOU NEED TO REPLACE THE SUPPLIED AC ADAPTER OR AC CORD, THE SPECIFIED ONE IS RECOMMENDED. CONTACT CUSTOMER SERVICE AT 1-800-289-0980.

Antenna connections

If you are using an indoor or outdoor antenna, follow the instructions below that correspond to your antenna system. If you are using a Cable TV service, see page 15 for Cable TV connections.

Combination VHF/UHF Antenna (Single 75 ohm cable or 300 ohm twin-lead wire)

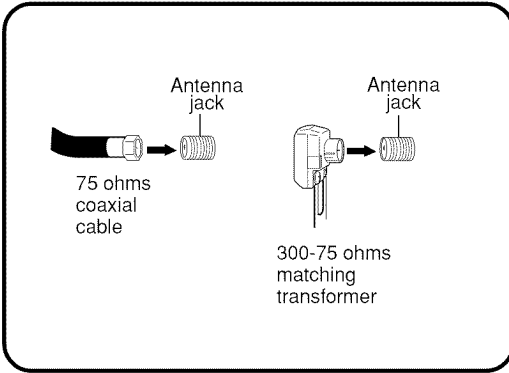

Connect the 75 ohm cable from the combination VHF/UHF antenna to the antenna jack.

If your combination VHF/UHF antenna has a 300 ohm twin-lead wire, the use of the 300-75 ohm matching transformer may be necessary.

Combination VHF/UHF Antenna (Separate VHF and UHF 300 ohm twin-lead wires)

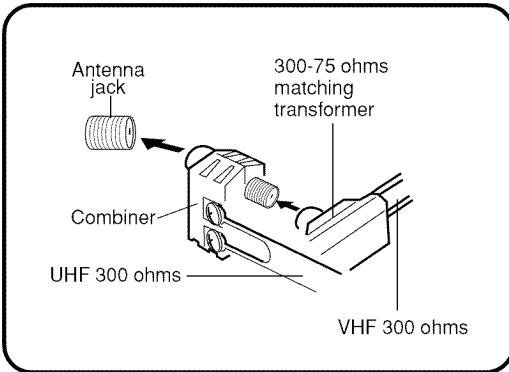

Connect the UHF 300 ohm twin-lead wire to the Combiner (not supplied). Connect the VHF 300 ohm twin-lead wire to the 300-75 ohm Matching Transformer. Attach the Transformer to the Combiner, then attach the Combiner to the Antenna Jack.

Separate VHF/UHF Antennas (75 ohm VHF cable and 300 ohm UHF twin-lead wires)

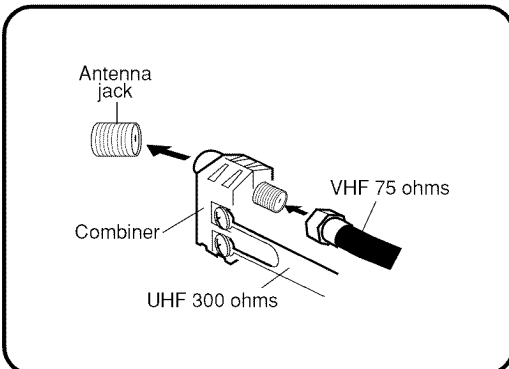

Connect the VHF 75 ohm cable and UHF 300 ohm twin-lead wire to the Combiner (not supplied). Attach the Combiner to the Antenna Jack.

Cable TV connections

This TV/DVD has an extended tuning range and can tune most cable channels without using a Cable TV Converter box. Some cable companies offer “premium pay channels” where the signal is scrambled. Descrambling these signals for normal viewing requires the use of a descrambler device which is generally provided by the Cable TV company.

FOR SUBSCRIBERS TO BASIC CABLE TV SERVICE

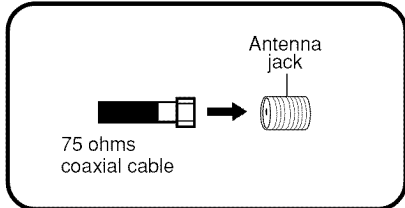

For basic Cable TV service not requiring a Converter/Descrambler box, connect the 75 ohm Coaxial Cable directly to the Antenna Jack on the back of the TV/DVD.

FOR SUBSCRIBERS TO SCRAMBLED CABLE TV SERVICE

If you subscribe to a Cable TV service which requires the use of a Converter/Descrambler box, connect the incoming 75 ohm Coaxial Cable to the Converter/Descrambler box. Using another 75 ohm Coaxial Cable, connect the output jack of the Converter/Descrambler box to the Antenna Jack on the TV/DVD. Follow the connections shown below. Set the TV/DVD to the output channel of the Converter/Descrambler box (usually channel 3 or 4) and use the Converter/Descrambler box to select channels.

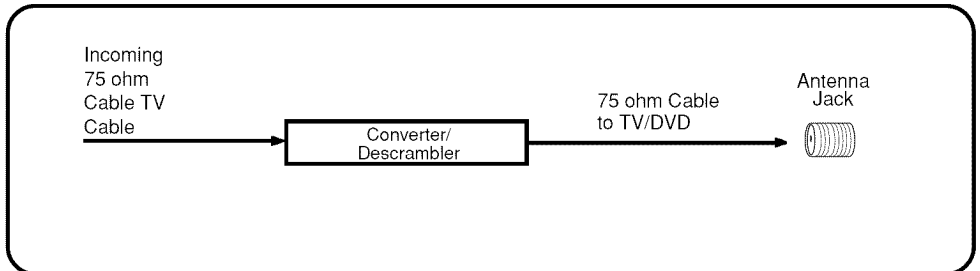

FOR SUBSCRIBERS TO UNSCRAMBLED BASIC CABLE TV SERVICE WITH SCRAMBLED PREMIUM CHANNELS

If you subscribe to a Cable TV service in which basic channels are unscrambled and premium channels require the use of a Converter/Descrambler box, you may wish to use a signal Splitter and an A/B Switch box (available from the Cable TV company or an electronics supply store). Follow the connections shown below. With the switch in the “B” position, you can directly tune any nonscrambled channels on your TV/DVD. With the switch in the “A” position, tune your TV/DVD to the output of the Converter/Descrambler box (usually channel 3 or 4) and use the Converter/Descrambler box to tune scrambled channels.

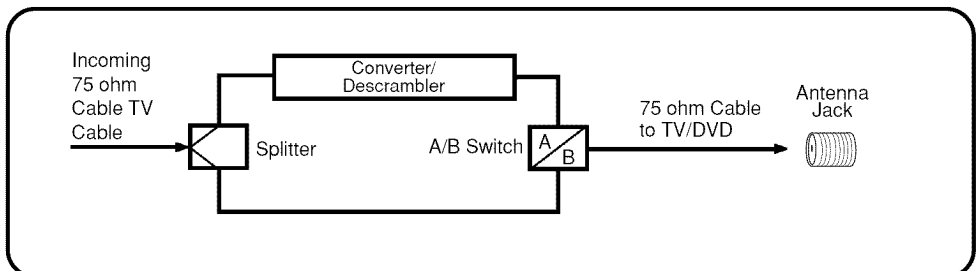

Setting the on-screen display language

You can choose from three different languages (English, French and Spanish) for the on-screen displays. On-screen language selection (step 5) will automatically appear on the screen when you press SETUP/MENU initially. Select the language you prefer first, then proceed with the other menu options.

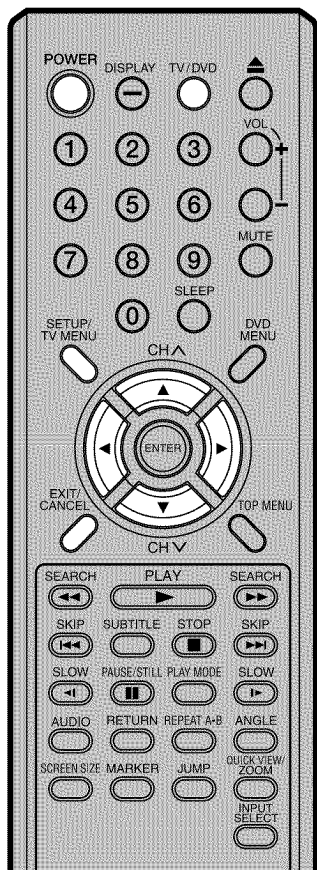

- 1 Press **POWER** to turn on the unit.
- 2 Press **TV/DVD** to select the TV mode.
- 3 Press **SETUP/TV MENU**. The TV menu screen will appear.
- 4 Press **◀** or **▶** to select (SETUP) menu.

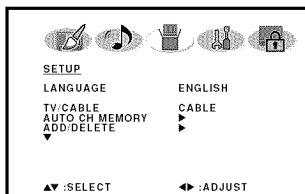

- 5 Press **▲** or **▼** to select "LANGUAGE".

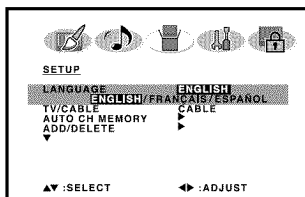

- 6 Press **◀** or **▶** to select the desired language: English (ENGLISH), French (FRANÇAIS) or Spanish (ESPANOL).
- 7 Press **EXIT** to return to the normal screen.

NOTES:

- If the unit does not operate properly (by the buttons on the unit and/or the remote control) disconnect the AC cord, wait a few minutes and plug it back in. Static electricity, etc., may have affected the player's operation.
- If no buttons are pressed for more than 60 seconds, the MENU screen will return to normal TV-operation automatically.

1 To turn on the unit, press **POWER**.

2 Adjust the volume level by pressing **VOL +** or **-**. The volume level will be indicated on the screen by white bars. As the volume level increases, so do the number of bars. If the volume decreases, the number of white bars also decreases.

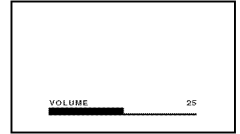

3 Set the TV/CABLE menu option to the appropriate position (see page 19).

TV - VHF/UHF channels
CABLE - CABLE TV channels

4 Press the **Direct Channel Selection (0-9,-)** buttons to select the channel.

To select analog channels

When the **TV/CABLE** menu option is in the TV position, all channels can be instantly selected by using two buttons.

(For example, to select channel 2, press "0", then "2". If you press only "2", channel selection will be delayed for a few seconds.) For channels 10 and above, press the 2 digits in order.

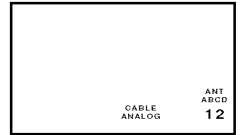

When the **TV/CABLE** menu option is in the CABLE position, channels can be selected as follows:

- 1-9: Press **0** twice, then 1-9 as needed.
Example, to select channel 2, press **002**.
- 10-12: Press **0**, then remaining 2 digits.
Example, to select channel 12, press **012**.
- 13-99: Press the 2 digits in order.
Example, to select channel 36, press **36**.
- 100-125: Press the 3 digits in order.
Example, to select channel 120, press **120**.

To select digital channels

Press the channel number in order.

When "-" is contained in the channel number, Press the first 3 digits, then press **"-"/DISPLAY**, followed by the remaining 3 digits. (Example, to select channel 015-001, press **015 - 001**.)

- If a channel is selected with only audio content, "AUDIO ONLY" will be displayed on the screen.
- If a channel is selected with a weak digital signal, "DIGITAL CHANNEL SIGNAL STRENGTH IS LOW" will be displayed on the screen.
- If the digital channel has the same analog channel, you may be able to watch the same channel with analog.
- If a channel is selected to which you have not subscribed, "DIGITAL CHANNEL IS ENCRYPTED" will be displayed on the screen.

VHF/UHF/CABLE CHANNELS

TV	CABLE
VHF 2-13	VHF 2-13
UHF 14-69	STD/HRC/IRC 14-36 (A) (W) 37-59 (AA) (WW) 60-85 (AAA) (ZZZ) 86-94 (86) (94) 95-99 (A-5) (A-1) 100-125 (100) (125) 01 (5A)

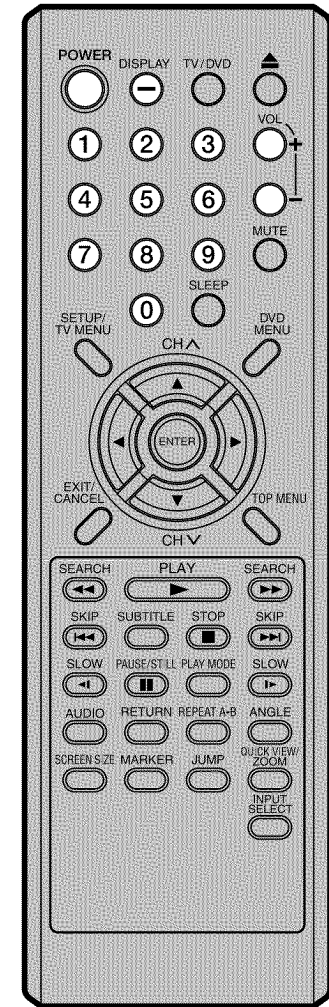

NOTES:

- If a channel with no broadcast is selected, the sound will automatically be muted.
- It may take a few seconds for a digital channel picture to appear on screen after being selected.

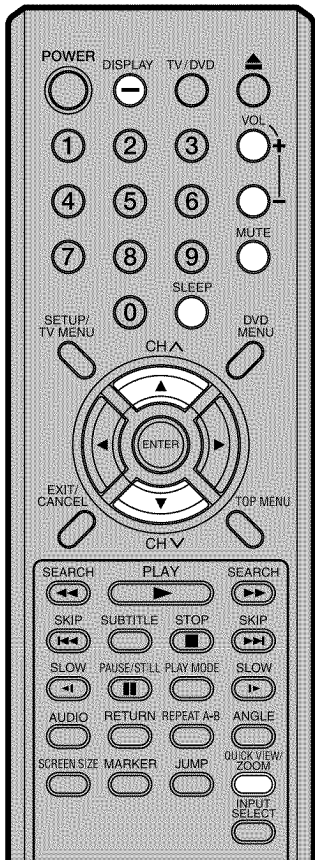

CH ^ / v

Press and release **CH ^** or **v**. The channel automatically stops at the next channel set into memory.

For proper operation, before selecting channels, they should be set into the memory. See pages 19 and 20 "Memorizing channels".

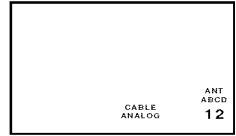

DISPLAY

Press **DISPLAY** to display the current information on the screen.

When the TV receives a digital signal, the digital information will appear.

- Channel number
- Broadcast program name
- Station name
- Audio language
- V-CHIP RATING
- Sleep time
- Remaining time
- Program guide
- V-Chip mark
- Picture size



When the TV receives an analog signal, the analog information will appear.

- Channel number or VIDEO mode selected
- Channel label (if preset)
- Stereo or SAP (second audio program) audio status
- Content rating
- Sleep time
- Picture size

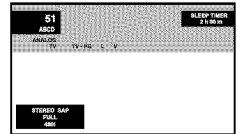

Press **DISPLAY** again to clear the call display.

QUICK VIEW

This button allows you to go back to the last channel selected by pressing **QUICK VIEW**. Press **QUICK VIEW** again to return to the last channel you were watching.

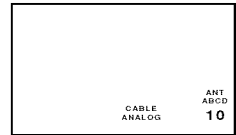

NOTES:

- The unit is capable of holding a still video image or On screen display image on your television screen indefinitely. If you leave the still video image or On screen display image displayed on your unit for an extended period of time, you risk permanent damage to your television screen.
- When the TV receives an analog signal, **DISPLAY** shows only analog information.
- After 10 seconds, **DISPLAY** screen will return to normal TV-operation automatically, when a Digital signal is received.
- After 4 seconds, **DISPLAY** screen will return to normal TV-operation automatically, when a Analog signal is received.

MUTE

Press **MUTE** to switch off the sound. The unit's sound will be silenced and "MUTE" will briefly appear on the screen. The sound can be switched back on by pressing this button again or the **VOL +** or **-**.



SLEEP

To set the unit to turn off after a preset amount of time, press **SLEEP** on the remote control. The clock will count up 10 minutes for each press of the **SLEEP** button (OFF, 0h10m, ..., 1h50m, 2h00m). After the sleep time is programmed, the display will appear briefly every ten minutes to remind you that the sleep timer is operating. To confirm the sleep timer setting, press **SLEEP** and the remaining time will be displayed for a few seconds. To cancel the sleep timer, press **SLEEP** repeatedly until the display turns to OFF.



Memorizing channels

This TV/DVD is equipped with a channel memory feature which allows channels to skip up or down to the next channel set into memory, skipping over unwanted channels. Before selecting channels, they must be programmed into the TV/DVD's memory. To use this TV/DVD with an antenna, set the TV/ CABLE menu option to the TV mode. When shipped from the factory, this menu option is in the CABLE mode.

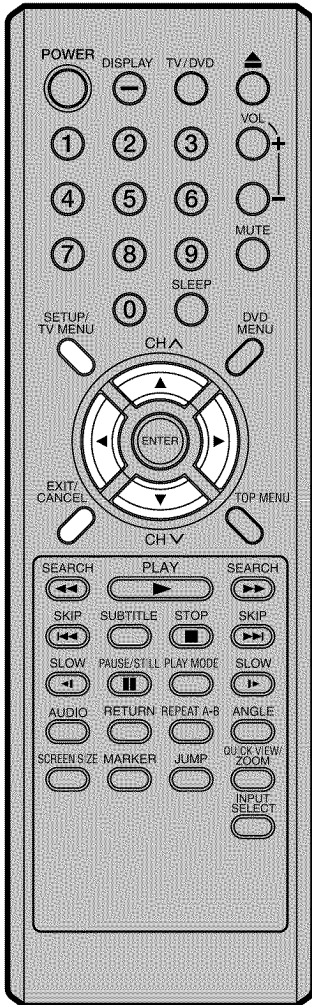

TV/CABLE selection

1 Press **SETUP/TV MENU** in the TV mode. The TV menu screen will appear.

2 Press **◀** or **▶** to select (SETUP) menu.

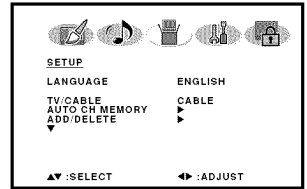

3 Press **▲** or **▼** to select "TV/CABLE".

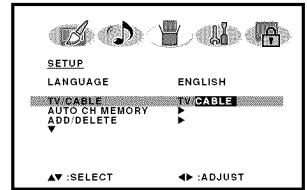

4 Press **◀** or **▶** to select "TV" or "CABLE".

TV - VHF/UHF channels
CABLE - CABLE TV channels

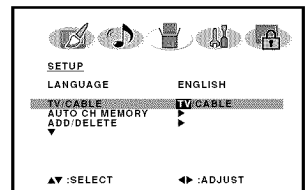

5 Press **EXIT** to return to the normal screen.

CABLE CHART

The chart below is typical of many cable system channel allocations.

Number on this TV													14	15	16	17	18	19	20	21	22
Corresponding CABLE channel													A	B	C	D	E	F	G	H	I
23	24	25	26	27	28	29	30	31	32	33	34	35	36	37	38	39	40				
J	K	L	M	N	O	P	Q	R	S	T	U	V	W	AA	BB	CC	DD				
41	42	43	44	45	46	47	48	49	50	51	52	53	54	55	56	57	58				
EE	FF	GG	HH	II	JJ	KK	LL	MM	NN	OO	PP	QQ	RR	SS	TT	UU	VV				
59	60	61	62	63	64	65	66	67	68	69	70	71	72	73	74	75	76				
WW	AA	BBB	CCC	DDD	EEE	FFF	GGG	HHH	III	JJJ	KKK	LLL	MMM	NNN	OOO	PPP	QQQ				
77	78	79	80	81	82	83	84	85	86	87	88	89	90	91	92	93	94				
RRR	SSS	TTT	UUU	VVV	WWW	XXX	YYY	ZZZ	86	87	88	89	90	91	92	93	94				
95	96	97	98	99	100	101	102	103	104	105	106	107	108	109	110	111	112				
A-5	A-4	A-3	A-2	A-1	100	101	102	103	104	105	106	107	108	109	110	111	112				
113	114	115	116	117	118	119	120	121	122	123	124	125	01								
113	114	115	116	117	118	119	120	121	122	123	124	125	5A								

NOTE:

It may take a few seconds for a digital channel picture to appear on screen after being selected.

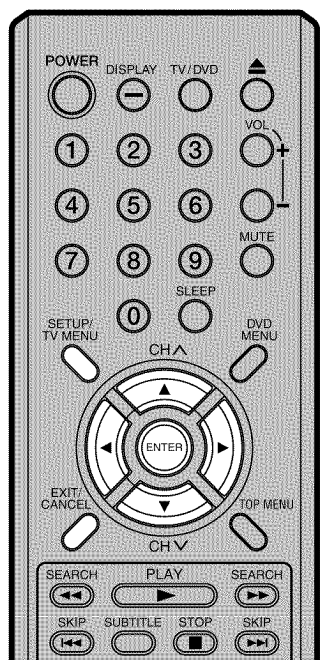

Automatic memory tuning

1 Press **SETUP/TV MENU** in the TV mode. The TV menu screen will appear.

2 Press **◀** or **▶** to select  (SETUP) menu, then press **▲** or **▼** to select "AUTO CH MEMORY".

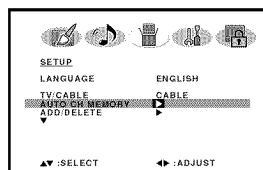

3 Press **◀** or **▶**. The unit will begin memorizing all the channels available in your area.

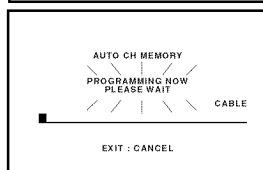

- It may take from 15 minutes to 30 minutes to complete memorizing digital cable channels.

Depending on the reception condition, a BAR display may not advance for several minutes, please be patient.

To ADD/DELETE channels

1 Press **SETUP/TV MENU**. The menu screen will appear.

2 Press **◀** or **▶** to select  (SETUP) menu, then press **▲** or **▼** to select "ADD/DELETE". Press **◀** or **▶**. The ADD/DELETE menu will appear.

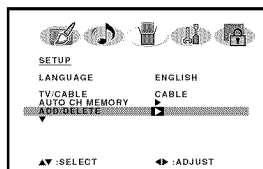

3 Press **▲** or **▼** to select "ADD/DELETE", then press **◀** or **▶**.

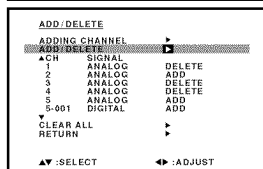

4 Select the desired channel to be memorized or deleted using **▲** or **▼**. Press **◀** or **▶** to select "ADD" or "DELETE", whichever function you want to perform.

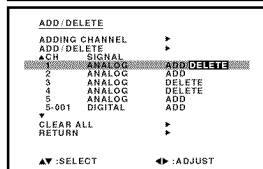

5 Repeat step 4 for other channels you want to add or delete, then press **ENTER**.

6 Press **EXIT** to return to the normal screen.

To add a digital channel

Select the channel you wish to add. Press **▲** or **▼** to select "ADDING CHANNEL" as in step 3 above, then press **◀** or **▶**.

CLEAR ALL

All channels are deleted from the channel memory. Press **▲** or **▼** to select "CLEAR ALL" in step 3 above, then press **◀** or **▶**.

NOTES:

- Memorizing channels is best accomplished during evening "PRIMETIME" hours, as more stations are broadcasting digital signals. Memorizing channels can only be accomplished while a station is broadcasting a digital signal to set that channel into memory.
- If you are unsure of the digital channels available in your area you may visit www.antennaweb.org to receive a list based on your address or zip code. Should you require further assistance you may call our toll-free customer service line at 1-800-289-0980.
- New digital channels may be added to your area periodically, it is recommended to perform the "AUTO CH MEMORY" procedure regularly.
- To return from ADD/DELETE menu to SETUP menu, select "RETURN", then press **◀** or **▶**.

Setting the V-Chip

An age limitation can be set to restrict children from viewing or hearing violent scenes or pictures that you may choose to exclude. The restriction applies to "TV RATING" and "MOVIE RATING" if this data is transmitted. You may set this restriction separately. To use the V-Chip function, you must register a password.

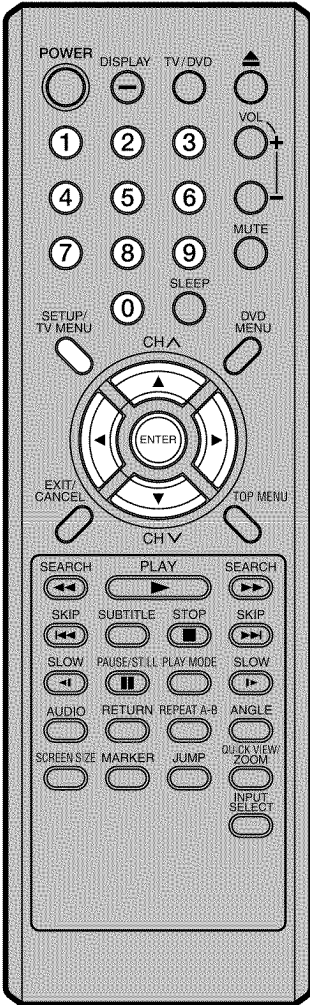

To register password

1 Press **SETUP/TV MENU** in the TV mode.
The TV menu screen will appear.

2 Press **◀** or **▶** to select  (LOCKS) menu.

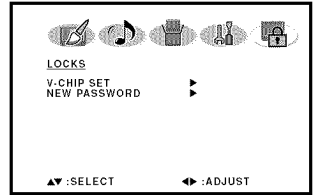

3 Press **▲** or **▼** to display the password entering mode.

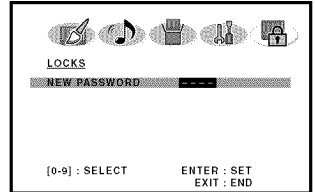

4 Select and enter a password (4 digits) using **Number buttons (0-9)**, then press **ENTER**.

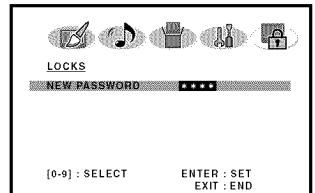

5 Enter the same password again to confirm, then press **ENTER**.

The password is now registered and the LOCKS menu will appear on the screen.

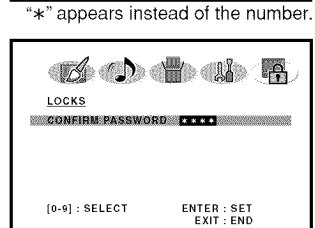

NOTES:

- If you forget the password, contact Customer Service at 1-800-289-0980 for assistance. Your original remote control will be required.
- To avoid forgetting the password, write it down and keep in the safe place.

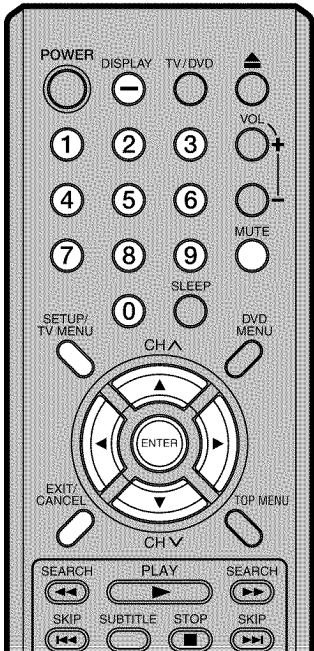

To set the V-Chip

- 1 Press **SETUP/TV MENU** in the TV mode. Then press **◀** or **▶** to select (LOCKS) menu.
- 2 Press **▲** or **▼** to display the password entering mode. Use **Number buttons (0-9)** to enter your password, then press **ENTER**. The LOCKS menu appears.
- 3 Press **▲** or **▼** to select "V-CHIP SET", then press **◀** or **▶**. The V-CHIP SET menu appears.
- 4 Press **▲** or **▼** to select "TV RATING". Then press **◀** or **▶** to display the desired rating.
 - OFF** : TV RATING is not set
 - TV-Y** : All children
 - TV-Y7** : 7 years old and above
 - TV-G** : General audience
 - TV-PG** : Parental guidance
 - TV-14** : 14 years old and above
 - TV-MA** : 17 years old and above

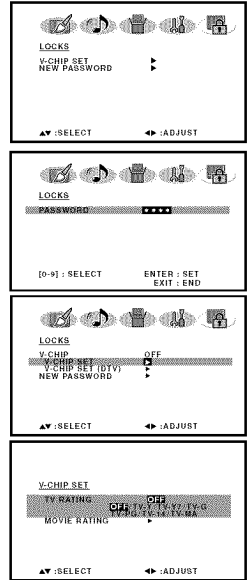

- When you select TV-Y7, TV-PG, TV-14 or TV-MA, press **DISPLAY** to explain the rating. Press **▲** or **▼** to select the desired rating you want. Press **◀** or **▶** to select the setting "ON" or "OFF".

To use the TV after the TV is protected.

When a program is received that is blocked by the V-Chip, press **MUTE** and enter the password, then press **ENTER**. When the password is entered correctly the protection will be temporarily overridden. If the unit is turned off, or the channel is changed the V-Chip restriction will be reactivated.

NOTES:

- The V-Chip function is activated only on programs and input sources that include a rating signal.
- The V-CHIP SET (DTV) will only be selectable when the unit receives a digital broadcast using the new rating system. It may take several minutes for the initial V-Chip Set-up to complete. At this time some stations are still developing this signal, in those cases the V-CHIP SET (DTV) will not function.

- 5 Press **▲** or **▼** to select "MOVIE RATING", then press **◀** or **▶**. The RATING SET menu appears.

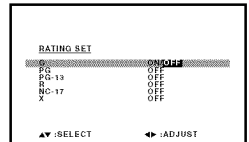

- 6 Press **▲** or **▼** to select a rating, then press **◀** or **▶** to select ON or OFF for each rating.

- G** : All ages
- PG** : Parental guidance
- PG-13** : Parental guidance less than 13 years old
- R** : Under 17 years old Parental guidance suggested
- NC-17** : 17 years old and above
- X** : Adult only

- 7 Press **SETUP/TV MENU** twice to return to the LOCKS menu, then press **▲** or **▼** to select "V-CHIP".

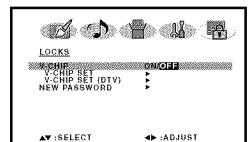

- 8 Press **◀** or **▶** to select "ON". Your settings are now set into memory.



- 9 Press **EXIT** to return to the normal screen.

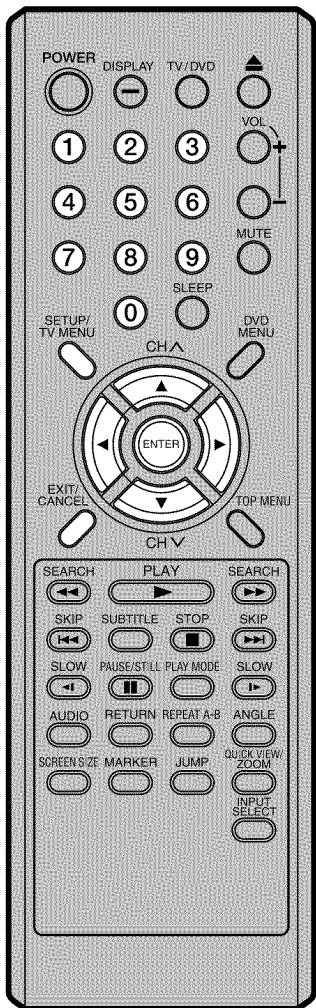

To change the password

1 Press **SETUP/TV MENU** in the TV mode.
The TV menu screen will appear.

2 Press **◀** or **▶** to select 
(LOCKS) menu.

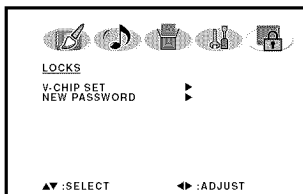

3 Press **▲** or **▼** to display the password entering mode.
Use **Number buttons (0-9)** to enter your password, then press **ENTER**. The LOCKS menu appears.

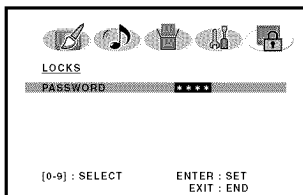

4 Press **▲** or **▼** to select "NEW PASSWORD", then press **◀** or **▶**.

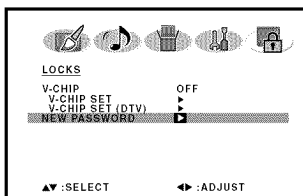

5 Enter a new password using **Number buttons (0-9)**, then press **ENTER**.

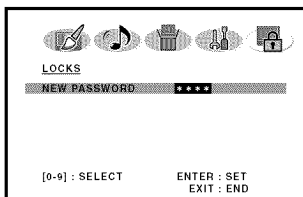

6 Enter the same password again to confirm, then press **ENTER**.

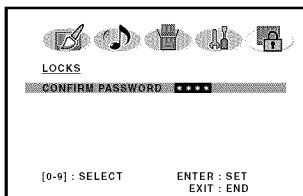

7 Press **EXIT** to return to the normal screen.

Labeling channels

Channel labels appear over the channel number display each time you turn on the TV, select a channel, or press DISPLAY. You can choose any four characters to identify a channel.

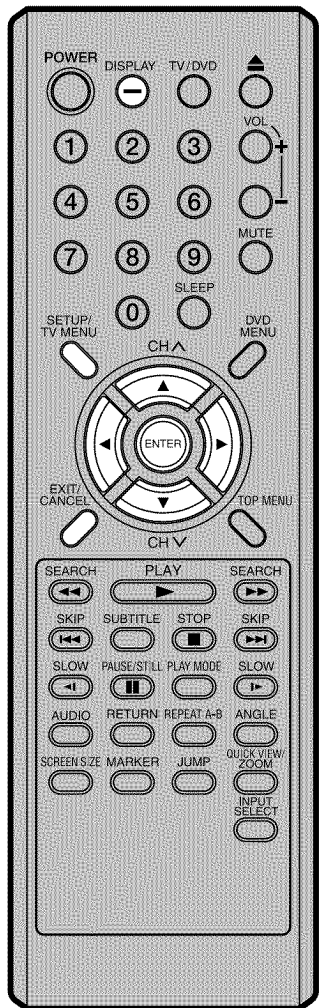

NOTE:

Select "RETURN" and press ◀ or ▶ to return from CH LABEL menu to OPTION menu.

To create channel labels

- 1 Select a channel you want to label.
- 2 Press **SETUP/TV MENU** in the TV mode, then press ◀ or ▶ to select  (OPTION) menu. Press ▲ or ▼ to select "CH LABEL", then press ◀ or ▶. The CH LABEL menu will appear.
- 3 Press ▲ or ▼ to select "SET/CLEAR". Press ◀ or ▶ to select "SET".
- 4 Press **ENTER** to select "LABEL". Then press ◀ or ▶ to enter a character in the first space. Press the button repeatedly until the character you want appears on the screen.

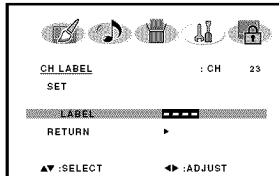
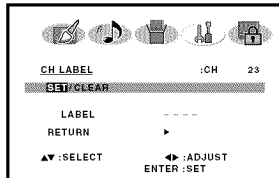
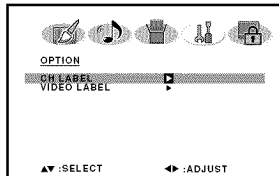

The characters rotation as follows:

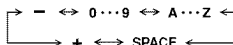

If the character which you desire appears, press **ENTER**. Repeat this step to enter the rest of the characters. If you would like a blank space in the label name, you must choose the empty space from the list of characters; otherwise, a dash will appear in that space. When you finish inputting the label name, press **ENTER**.

- 5 Press **EXIT** to return to the normal screen.
- 6 Repeat steps 1-5 for other channel. You can assign a label to each channel.

To erase channel labels

- 1 Select a channel with a label which you want remove.
- 2 Press **SETUP/TV MENU**, then press ◀ or ▶ to select  (OPTION) menu. Press ▲ or ▼ to select "CH LABEL", then press ◀ or ▶ to display the CH LABEL menu.
- 3 Press ▲ or ▼ to select "SET/CLEAR". Press ◀ or ▶ to select "CLEAR", then press **ENTER**.
- 4 Press **EXIT** to return to the normal screen.
- 5 Repeat steps 1 - 4 to erase other channel labels.

Selecting the video input source/ Labeling the video input source

Selecting the video input source

Press **INPUT SELECT** to view a signal from another device connected to your TV, such as a VCR or DVD player. You can select ANT, VIDEO1, VIDEO2, COMPONENT, HDMI or PC depending on which input jacks you used to connect your devices.

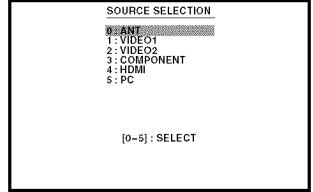

Pressing **INPUT SELECT** on the remote control displays the current signal source. To change the video input source, press **INPUT SELECT** again or 0-5.

Labeling the video input source

The video label feature allows you to label each input source for your unit.

- 1 Press **SETUP/TV MENU** in the TV mode. Then press **◀** or **▶** to select **OPTION** (OPTION) menu. Press **▲** or **▼** to select "VIDEO LABEL". Press **◀** or **▶**. The VIDEO LABEL menu will appear.

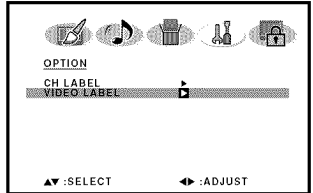

- 2 Press **▲** or **▼** to select the video source you want to label.

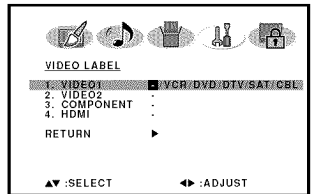

- 3 Press **◀** or **▶** to select the desired label for that input source.

– : Uses the default label name

VCR : Video cassette recorder

DVD : DVD video

DTV : Digital TV set-top box

SAT : Satellite box

CBL : Cable box

HD : HDMI device (only HDMI)

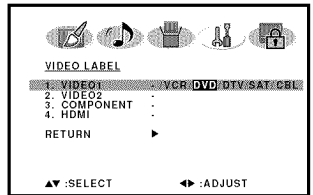

- 4 Press **EXIT** to return to the normal screen.

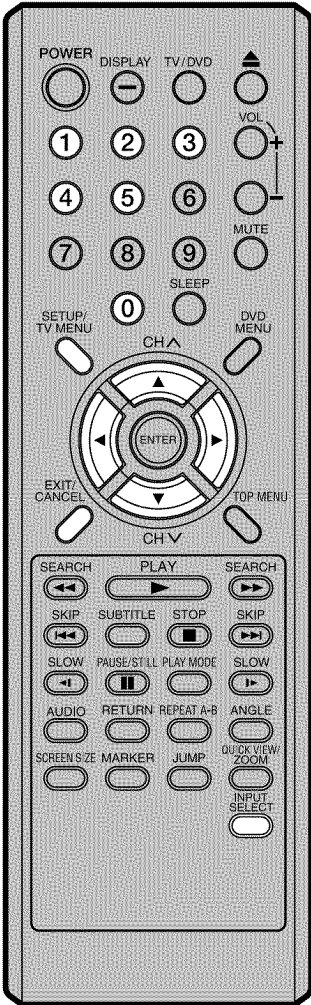

NOTE:

Select "RETURN" and press **◀** or **▶** to return from VIDEO LABEL menu to OPTION menu.

Setting the picture size

You can view 480i and 480p format programs in a variety of picture sizes—NATURAL, CINEMA WIDE1, CINEMA WIDE2, CINEMA WIDE3, and FULL.

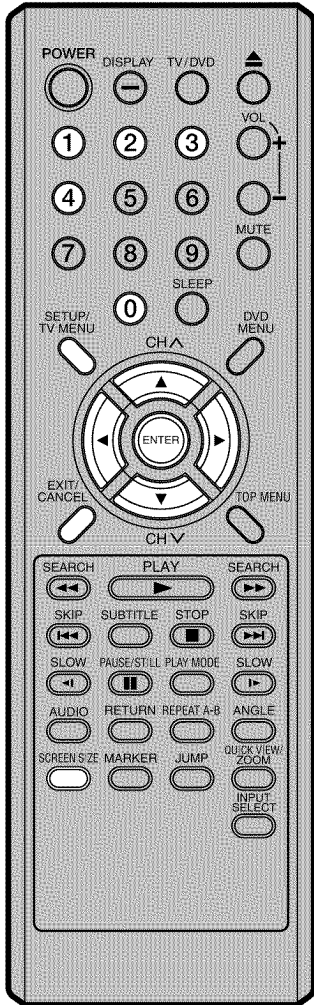

Selecting the picture size

1 Press **SETUP/TV MENU**. Press **◀** or **▶** to select  (SETUP) menu. Press **▲** or **▼** to select "PICTURE SIZE".

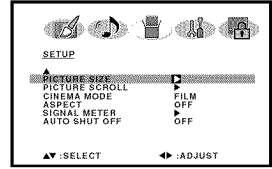

2 Press **◀** or **▶**. The PICTURE SIZE menu will appear. Press **▲/▼** or a **Number button (0-4)** to select the desired picture size, as described below and on the next page, then press **ENTER**.



3 Press **EXIT** to return to the normal screen.

NOTE:

You can also display the PICTURE SIZE menu by pressing the **SCREEN SIZE** button on the remote control.

NATURAL picture size

In some cases, this image will display the size of standard 4:3 with a black side bar.

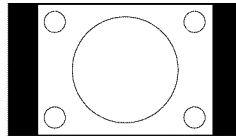

CINEMA WIDE1 picture size (for 4:3 format programs)

To fill the screen, the right and left edges are extended, however; the center of the picture remains near its former ratio.

The top and bottom edges of the picture may be hidden.

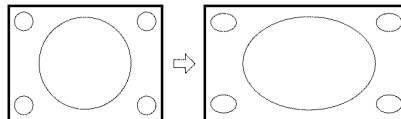

NOTE:

Some High Definition and/or Digital broadcasts may not allow you to change the picture size.

NOTES:

- In HDMI or COMPONENT mode with a scanning rate of 720p or 1080i, only the CINEMA WIDE2 and FULL PICTURE SIZE feature are available.
- The PICTURE SIZE feature is in the PC mode only for NATURAL or FULL.
- In CINEMA WIDE2 picture size, some of the on screen display items may be positioned off the visible portion of the screen. You can use Picture Scroll, as explained on the right, to view off screen items.

CINEMA WIDE2 picture size (for letter box programs)

The entire picture is uniformly enlarged—it is stretched the same amount both wider and taller (retains its original proportion).

The top and bottom edges of the picture may be hidden. To view the hidden areas, it is possible to make the picture scroll (see page 28).

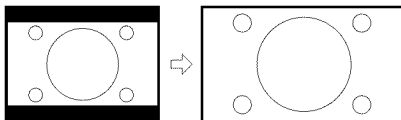

CINEMA WIDE3 picture size (for letter box programs with subtitles)

To fill the width of the screen, it is extended horizontally. However, it is only slightly extended at the top and the bottom.

The top and bottom edges of the picture may be hidden. To view the hidden areas (such as subtitles or captions), it is possible to make the picture scroll (see page 28).

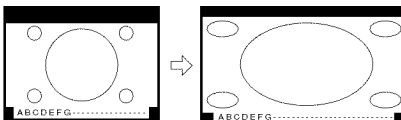

FULL picture size (for 16:9 source programs)

FULL will display the picture at the maximum size.

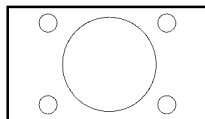

Setting the picture scroll

You can scroll the picture in CINEMA WIDE2 and CINEMA WIDE3

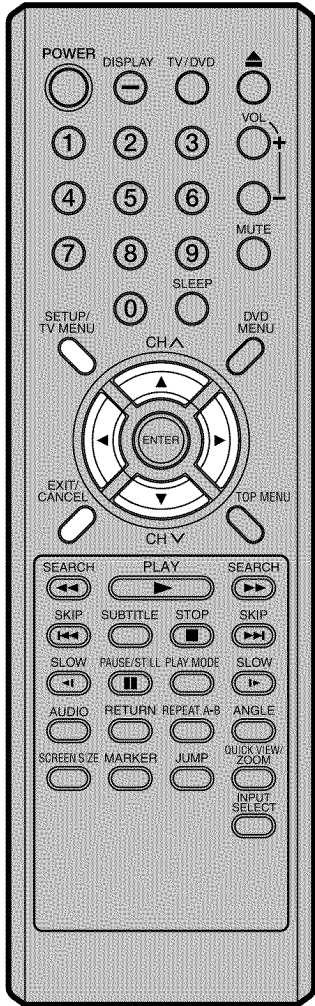

NOTE:

The scroll adjustments are as follows:

- 480i/480p signal source:
 CINEMA WIDE1 : Not adjustable
 CINEMA WIDE2 : -10 to +10
 CINEMA WIDE3 : -10 to +10

- 1 Press **SETUP/TV MENU** in CINEMA WIDE2 or CINEMA WIDE3 mode. Then press **◀** or **▶** to select **SETUP** (SETUP) menu.

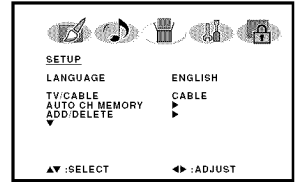

- 2 Press **▲** or **▼** to select "PICTURE SCROLL".

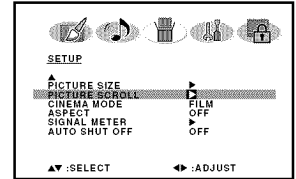

- 3 Press **◀** or **▶** to display the SCROLL ADJUSTMENT mode.

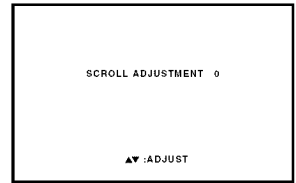

- 4 Press **▲** or **▼** to adjust the vertical position of the picture.

Normal (center) position

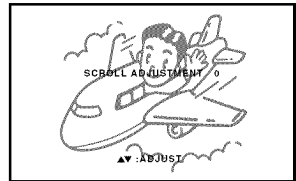

To raise the picture, press **▲**.

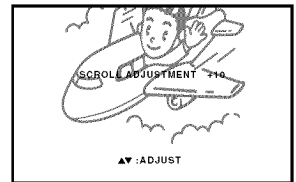

To lower the picture, press **▼**.



- 5 Press **EXIT** to return to the normal screen.

Selecting the cinema mode/Using the aspect feature

Selecting the cinema mode

A smoother motion may be obtained by setting the Picture Mode to Film when you view a DVD.

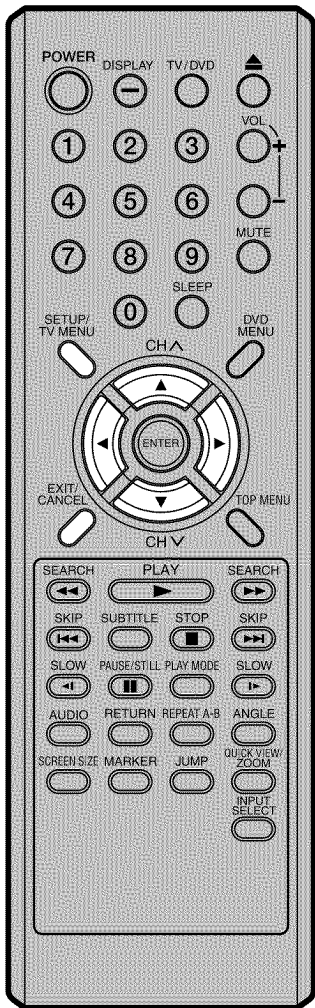

- 1 Press **SETUP/TV MENU** in the TV mode, then press ◀ or ▶ to select (SETUP) menu.

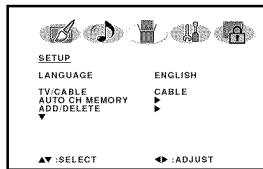

- 2 Press ▲ or ▼ to select **CINEMA MODE**, then press ◀ or ▶ to select "FILM".

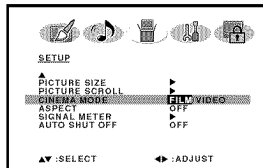

- 3 Press **EXIT** to return to the normal screen.

To set the **CINEMA MODE** to **VIDEO** :

Press ◀ or ▶ to select "VIDEO" in step 2 above.

Using the aspect feature

When the **ASPECT** feature is set to **ON** and the unit receives a 480i signal, the picture size is automatically selected (as described in the following table).

- 1 Press **SETUP/TV MENU** in the TV mode, then press ◀ or ▶ to select (SETUP) menu.

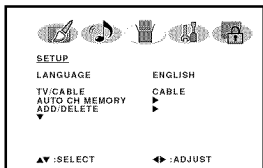

- 2 Press ▲ or ▼ to select "ASPECT", then press ◀ or ▶ to select "ON" or "OFF".

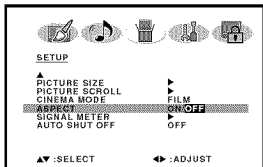

- 3 Press **EXIT** to return to the normal screen.

NOTES:

- CINEMA MODE is available only for 480i mode.
- If the signal does not include aspect information, the picture size you selected on page 26 is displayed.

Aspect ratio of signal source	Automatic aspect size (When ASPECT is ON)
4:3 Normal	NATURAL
16:9 Full	FULL
4:3 Letter box	CINEMA WIDE
Not defined	User-set mode

Adjusting the picture preference/Picture control adjustment

You can select four picture modes—SPORTS, STANDARD, MOVIE, and MEMORY—as described in the following table:

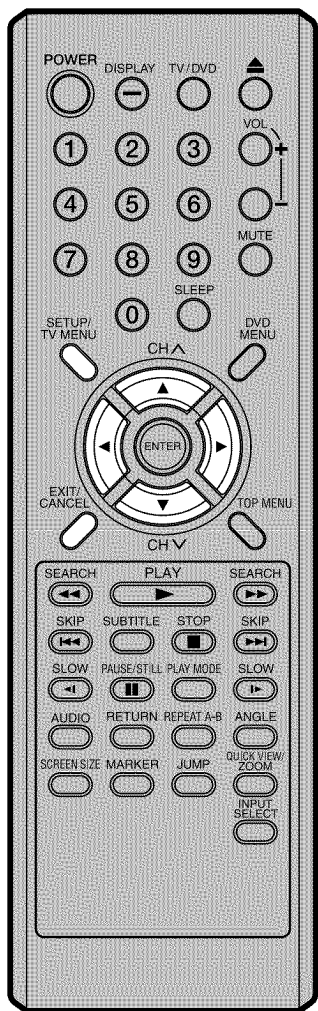

Adjusting the picture preference

1 Press **SETUP/TV MENU** in the TV mode, then press ◀ or ▶ to select (PICTURE) menu.

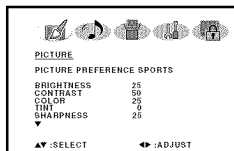

2 Press ▲ or ▼ to select "PICTURE PREFERENCE".

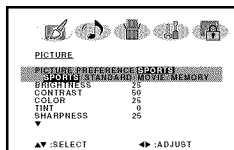

3 Press ◀ or ▶ to select the item you want to adjust.

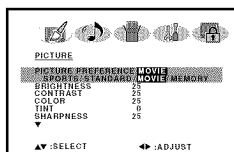

Mode	Picture Quality
SPORTS	Bright and dynamic picture (factory-set)
STANDARD	Standard picture quality (factory-set)
MOVIE	Movie-like picture setting (factory-set)
MEMORY	Your personal preferences (set by you; see "Picture control adjustment" below).

4 After your desired setting, press **EXIT** to return to the normal screen.

Picture control adjustment

1 Press **SETUP/TV MENU** in the TV mode, then press ◀ or ▶ to select (PICTURE) menu.

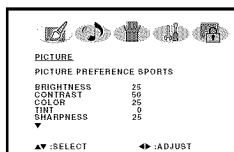

2 Press ▲ or ▼ to select the item you want to adjust. Press ◀ or ▶ to adjust the setting.

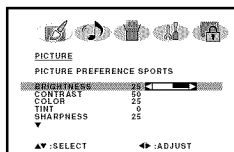

	◀	▶
BRIGHTNESS	decrease brightness	increase brightness
CONTRAST	decrease contrast	increase contrast
COLOR	be pale color	be brilliant color
TINT	be reddish color	be greenish color
SHARPNESS	makes picture softer	makes picture clearer

3 After your desired setting, press **EXIT** to return to the normal screen.

NOTE:

The **CONTRAST** default setting is set to maximum at the factory.

Selecting the color temperature/Adjusting the back lighting feature/Resetting your picture adjustments

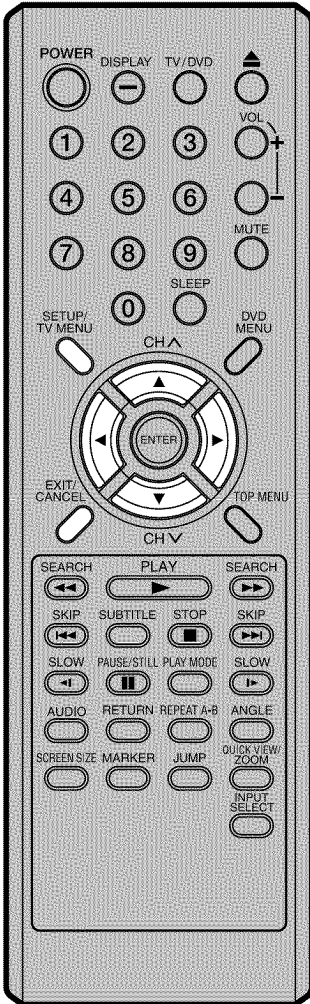

Selecting the color temperature

Change the picture quality by selecting from three preset color temperatures—COOL, MEDIUM, and WARM:

- 1 Press **SETUP/TV MENU** in the TV mode, then press ◀ or ▶ to select (PICTURE) menu.
- 2 Press ▲ or ▼ to select "COLOR TEMPERATURE". Press ◀ or ▶ to select the mode you prefer.

Mode	Picture Quality
COOL	Blueish
MEDIUM	Neutral
WARM	Reddish

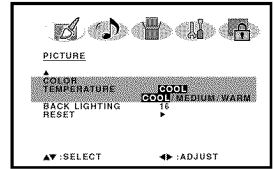

- 3 Press **EXIT** to return to the normal screen.

Adjusting the back lighting feature

If your unit is in a bright room, the screen image may be difficult to see. You can use the **BACK LIGHTING** feature to adjust the screen brightness for improved picture clarity.

- 1 Press **SETUP/TV MENU** in the TV mode, then press ◀ or ▶ to select (PICTURE) menu.
- 2 Press ▲ or ▼ to select "BACK LIGHTING".

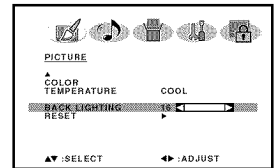

- 3 Press ◀ or ▶ to adjust the screen brightness.
- 4 Press **EXIT** to return to the normal screen.

Resetting your picture adjustments

The **RESET** function returns your picture quality adjustments to the following factory settings:

PICTURE PREFERENCE SPORTS TINT center (0)
 BRIGHTNESS center (25) SHARPNESS center (25)
 CONTRAST max (50) COLOR TEMPERATURE COOL
 COLOR center (25)

- 1 Press **SETUP/TV MENU** in the TV mode, then press ◀ or ▶ to select (PICTURE) menu.
- 2 Press ▲ or ▼ to select "RESET", and then press ◀ or ▶.

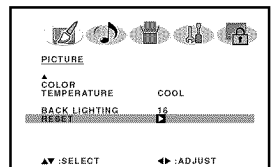

Closed Caption

WHAT IS CLOSED CAPTIONING?

This television has the capability to decode and display Closed Captioned television programs. Closed Captioning will display text on the screen for hearing impaired viewers or it will translate and display text in another language.

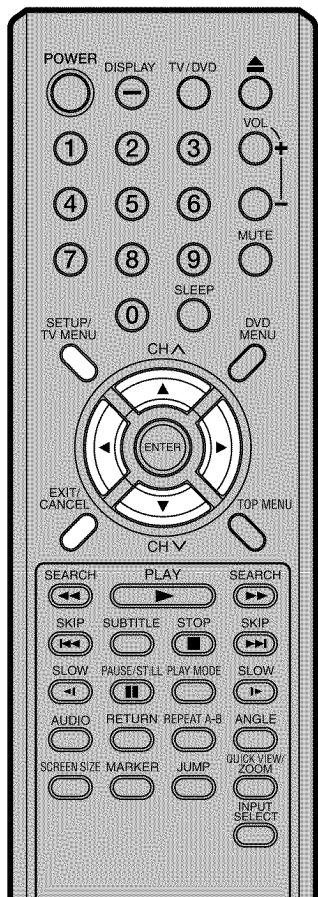

Captions: This Closed Caption Mode will display text on the screen in English or another language. Generally, Closed Captions in English are transmitted on C1 and Closed Captions in other languages are transmitted on C2.

Text: The Text Closed Caption Mode will usually fill 1/2 of the screen with a programming schedule or other information.

- 1 Tune the TV to the desired program.
- 2 Press **SETUP/TV MENU** in the TV mode, then press ◀ or ▶ to display the  (SETUP) menu.
- 3 Press ▲ or ▼ to select "CLOSED CAPTION".

When an Analog signal is received, you can choose C1, C2, T1, T2 and OFF.

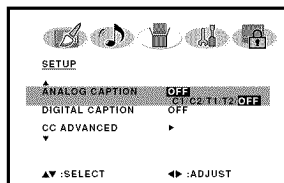

When a Digital signal is received, you can choose from CS1, CS2, CS3, CS4, CS5, CS6 and OFF.

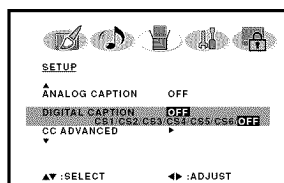

NOTE: Depending on the broadcast signal, some Analog Captions will function with a Digital broadcast signal.

- 4 Press ◀ or ▶ to select the desired Closed Caption mode.

NOTE: To turn the Closed Caption feature off, select "OFF".

- 5 Press **EXIT** to return to the normal screen.

NOTES:

- If the program or video you selected is not closed-captioned, no captions will display on-screen.
- If text is not available in your viewing area, a black rectangle may appear on-screen. If this happens, set the Closed Caption feature to "OFF".
- When selecting Closed Captions, the captioning will be delayed approx. 10 seconds.
- If no caption signal is received, no captions will appear, but the television will remain in the Caption Mode.
- Misspellings or unusual characters may occasionally appear during Closed Captioning. This is normal with Closed Captioning, especially with live programs. This is because during live programs, captions are also entered live. These transmissions do not allow time for editing.
- When Captions are being displayed, on-screen displays, such as volume and mute may be seen but may interfere with Closed Captions.
- Some cable systems and copy protection systems may interfere with the Closed Captioned signal.
- If using an indoor antenna or if TV reception is very poor, the Closed Caption Decoder may not appear or may appear with strange characters or misspelled words. In this case, adjust the antenna for better reception or use an outdoor antenna.
- After selecting C1/C2 closed captions will be displayed while in the DVD mode. To turn off closed captioning, select TV mode and set closed caption to OFF.

Closed Captions are factory preset however you can adjust them individually as follows:

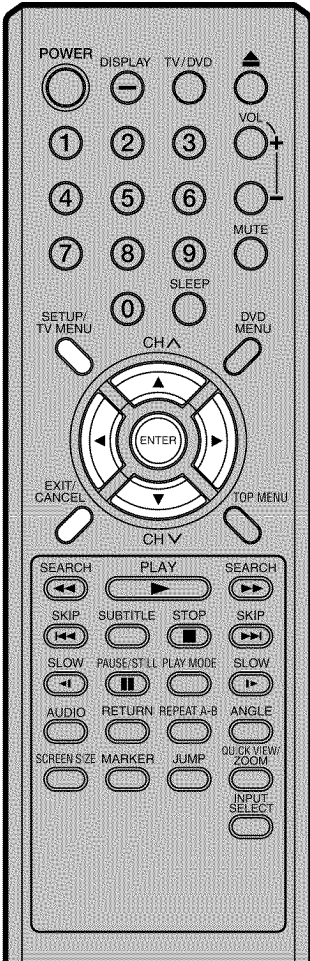

This feature is designed to customize Digital Captions only.

1 Press **SETUP/TV MENU**. The menu screen will appear.

2 Press **◀** or **▶** to select (SETUP) menu.

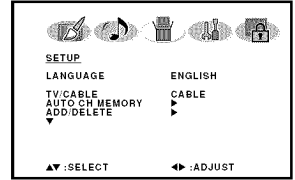

3 Press **▲** or **▼** to select "CC ADVANCED", then press **◀** or **▶**. The CC ADVANCED menu will appear.

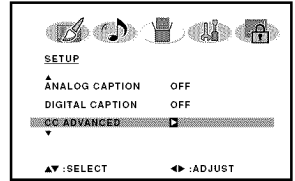

4 Press **▲** or **▼** to select the item you want to adjust, then press **◀** or **▶**.

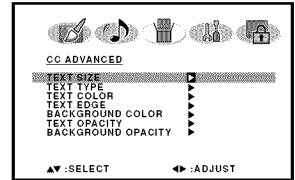

5 Press **▲** or **▼** to select desired setting, then press **ENTER**.

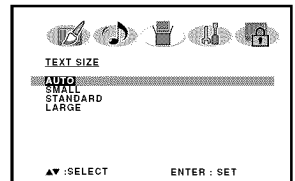

You can select from among the following items and parameters.

TEXT SIZE: AUTO, SMALL, STANDARD, LARGE

TEXT TYPE: AUTO, DEFAULT, MONO W. SERIF, PROP. W. SERIF, MONO W/O SERIF, PROP. W/O SERIF, CASUAL, CURSIVE, SMALL CAPITALS

TEXT COLOR: AUTO, BLACK, WHITE, RED, GREEN, BLUE, YELLOW, MAGENTA, CYAN

TEXT EDGE: AUTO, NONE, RAISED, DEPRESSED, UNIFORM, LEFT DROP SHADOW, RIGHT DROP SHADOW

BACKGROUND COLOR: AUTO, BLACK, WHITE, RED, GREEN, BLUE, YELLOW, MAGENTA, CYAN

TEXT OPACITY: AUTO, TRANSPARENT, TRANSLUCENT, SOLID, FLASHING

BACKGROUND OPACITY: AUTO, TRANSPARENT, TRANSLUCENT, SOLID, FLASHING

NOTES:

- Do not set the Closed Caption "TEXT COLOR" and "BACKGROUND COLOR" as the same color or you will not be able to see the text.
- Do not set both the "TEXT OPACITY" and the "BACKGROUND OPACITY" to "TRANSPARENT" or you will not be able to see the text.

6 Press **EXIT** to return to the normal screen.

Selecting Stereo/Second Audio Program (SAP)/ Sound control adjustment

The multi-channel TV sound (MTS) feature provides high-fidelity stereo sound. MTS also can transmit a second audio program (SAP) containing a second language or other audio information.

When the TV receives a stereo or SAP broadcast, the word "STEREO" or "SAP" displays on-screen every time you turn the TV on, change the channel, or press DISPLAY.

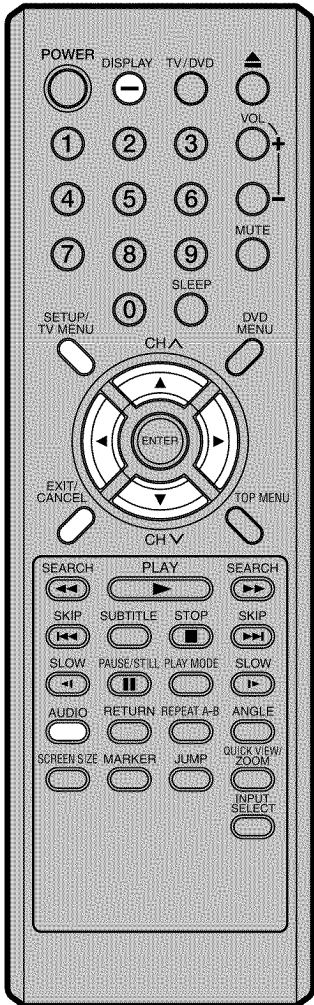

Selecting Stereo/Second Audio Program (SAP)

1 Press **SETUP/TV MENU** in the TV mode, then press **◀** or **▶** to select **(AUDIO)** menu.

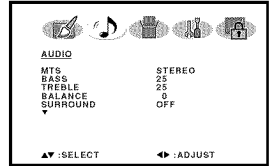

2 Press **▲** or **▼** to select "MTS". Press **◀** or **▶** to select "STR (Stereo)".

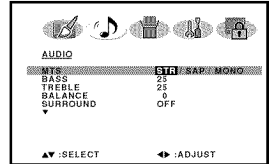

3 Press **EXIT** to return to the normal screen.

NOTES:

- Generally you can leave your TV in stereo mode because the TV automatically outputs the type of sound being broadcast (stereo or mono).
- If the stereo sound is noisy, select MONO to reduce the noise.
- You can also display the AUDIO menu by pressing the **AUDIO** button on the remote control.

To listen to a second audio program (SAP)

Press **◀** or **▶** to select "SAP" in step 2 above. The TV speakers will output the second audio program instead of normal audio.

Sound control adjustment

1 Press **SETUP/TV MENU** in the TV mode, then press **◀** or **▶** to select **(AUDIO)** menu.



2 Press **▲** or **▼** to select the item you want to adjust.

BASS: Press **◀** or **▶** to adjust the bass sound.

TREBLE: Press **◀** or **▶** to adjust the treble sound.

BALANCE: Press **◀** or **▶** to obtain an equal sound level from both speakers.

SURROUND:

Press **◀** or **▶** to select "ON" or "OFF".

ON: The dynamic presence and sound created offers a thoroughly enjoyable listening experience.

OFF: Normal sound.

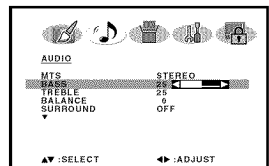

3 After your desired setting, press **EXIT** to return to the normal screen.

Selecting the HDMI audio input source/ Selecting the audio language

Selecting the HDMI audio input source

When you use HDMI AUDIO IN jacks with HDMI or DVI device, you must select HDMI audio input source from "HDMI" or "DVI".

- 1 Press **SETUP/TV MENU** in the TV mode. Then press ◀ or ▶ to select  (AUDIO) menu.
- 2 Press ▲ or ▼ to select "HDMI", then press ◀ or ▶ to select "HDMI" or "DVI".

HDMI: When you connect the HDMI device to the TV, select this setting.

DVI: When you connect the DVI device to the TV with analog audio cords, select this setting.

- 3 Press **EXIT** to return to the normal screen.

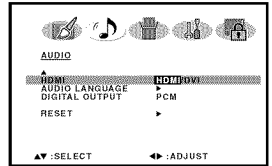
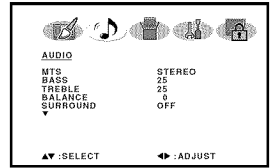

Selecting the audio language

When two or more audio languages are included in a digital signal, you can select one of the audio language.

- 1 Press **SETUP/TV MENU**, then press ◀ or ▶ to select  (AUDIO) menu.
- 2 Press ▲ or ▼ to select "AUDIO LANGUAGE". Then press ◀ or ▶ to display the AUDIO LANGUAGE menu.
- 3 Press ▲ or ▼ to select your desired language, then press **ENTER**.
- 4 Press **EXIT** to return to the normal screen.

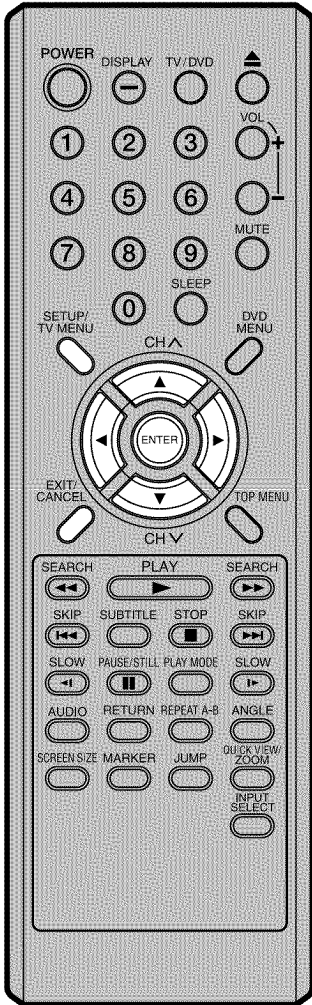
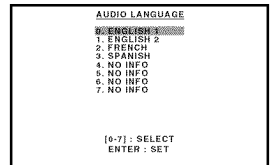
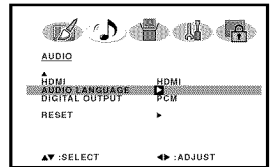
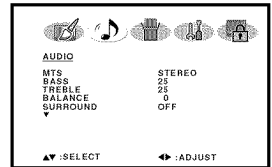

Selecting the digital output/Resetting your audio adjustments

Selecting the digital output

You can choose the format of the digital audio output signal.

- 1 Press **SETUP/TV MENU**, then press ◀ or ▶ to select  (AUDIO) menu.

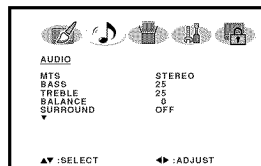

- 2 Press ▲ or ▼ to select "DIGITAL OUTPUT", then press ◀ or ▶ to select "PCM" or "DOLBY DIGITAL".

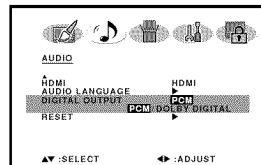

- 3 Press **EXIT** to return to the normal screen.

Resetting your audio adjustments

The RESET function returns the audio adjustments to the following factory settings:

BASS center (25)
TREBLE center (25)
BALANCE center (0)

- 1 Press **SETUP/TV MENU** in the TV mode, then press ◀ or ▶ to select  (AUDIO) menu.

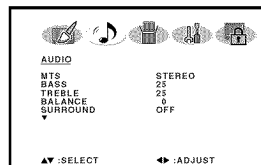

- 2 Press ▲ or ▼ to select "RESET", and then press ◀ or ▶.

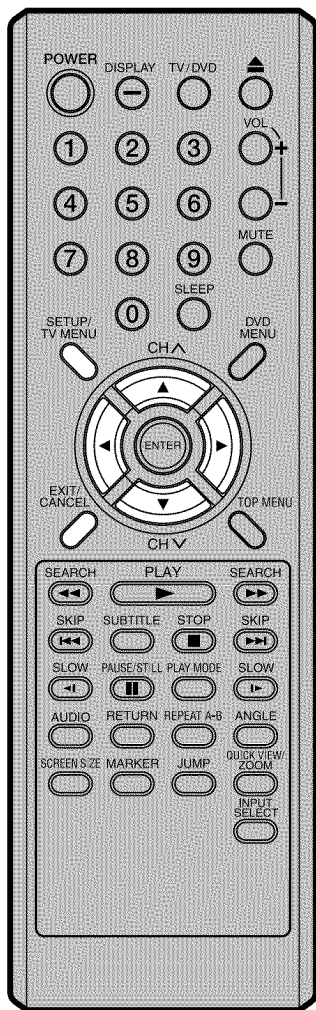
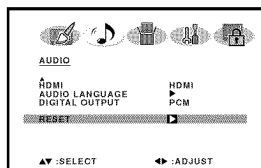

Checking the Digital-signal strength/Setting the auto shut off

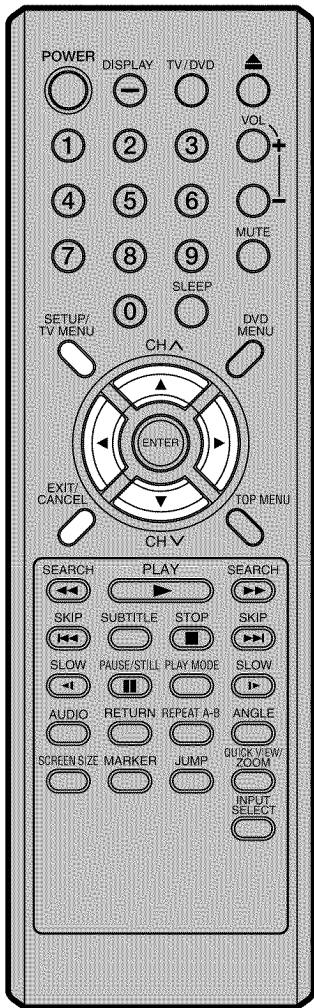

NOTES:

- Signal meter feature is not available for analog channels.
- After 240 seconds, SIGNAL METER screen will return to normal TV-operation automatically.

Checking the Digital-signal strength

This unit will allow you to view the digital signal meter for digital channels.

1 Press **SETUP/TV MENU**, then press **◀** or **▶** to select (SETUP) menu.

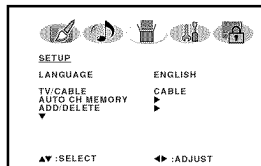

2 Press **▲** or **▼** to select "SIGNAL METER".

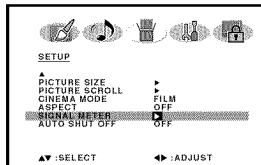

3 Press **◀** or **▶** to check the Digital-signal strength.

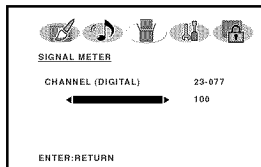

4 Press **EXIT** to return to the normal screen.

Setting the auto shut off

If the **AUTO SHUT OFF** feature is **ON**, and a station being viewed stops broadcasting, the TV will automatically shut itself off after 15 minutes.

1 Press **SETUP/TV MENU**, then press **◀** or **▶** to select (SETUP) menu.

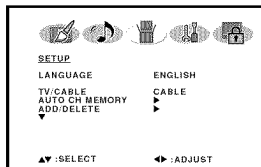

2 Press **▲** or **▼** to select "AUTO SHUT OFF".

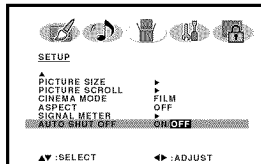

3 Press **◀** or **▶** to select "ON" or "OFF".

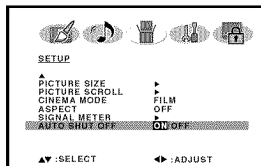

4 Press **EXIT** to return to the normal screen.

Picture/Audio control adjustment in the PC mode

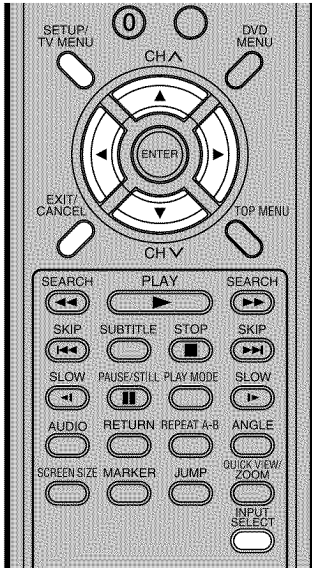

NOTES:

- If you wish to change the on-screen language, follow the steps 1 - 7 on page 16.
- If no buttons are pressed for more than approx. 60 seconds, the PC Monitor Menu-screen will return to normal Monitor-screen automatically.
- The PC Monitor Menu settings are not effective for normal mode, or external input mode.

PC Monitor Menu

There are a number of picture and audio settings you can adjust to optimize the performance of the TV in PC mode.

Press **INPUT SELECT** repeatedly to select PC mode.
Press **SETUP/TV MENU**. The PC Monitor Menu will appear.

PICTURE Menu

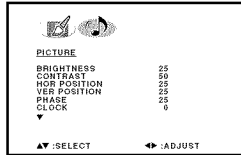

AUDIO Menu

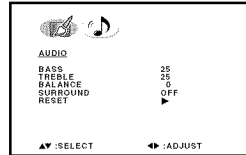

Example: Adjust the contrast.

- 1 Press **SETUP/TV MENU** during PC mode, then press ◀ or ▶ to select  (PICTURE) menu.
- 2 Press ▲ or ▼ to select **CONTRAST**.
- 3 Press ◀ or ▶ to adjust the setting.
- 4 Press **EXIT** to return to the normal screen.

Picture menu setting:

- BRIGHTNESS:** To adjust the brightness of PC Monitor-screen.
- CONTRAST:** To adjust the contrast of PC Monitor-screen.
- HOR POSITION:** To adjust the horizontal position of the image on the PC Monitor-screen.
- VER POSITION:** To adjust the vertical position of the image on the PC Monitor-screen.
- PHASE:** This must be adjusted after the frequency of your PC has been set to 60Hz to optimize picture quality (page 63).
- CLOCK:** To minimize any vertical bars or stripes visible on the screen background.
- RED/GREEN/BLUE:** To adjust the color temperature of PC monitor-screen
- WXGA INPUT:** Set to ON, when you select the WXGA mode on the PC.
- BACK LIGHTING:** To adjust the screen brightness for improved picture clarity.

Audio menu setting:

- BASS/TREBLE/BALANCE:** To adjust the sound quality of PC mode.
- SURROUND:** To turn on or off the surround effect in PC mode.

Picture/Audio control adjustment in the PC mode

Resetting your picture/audio adjustment in the PC mode

The RESET function returns your picture/audio adjustment to the following factory settings:



PICTURE menu

BRIGHTNESS center (25)
CONTRAST max (50)
RED center (25)
GREEN center (25)
BLUE center (25)

AUDIO menu

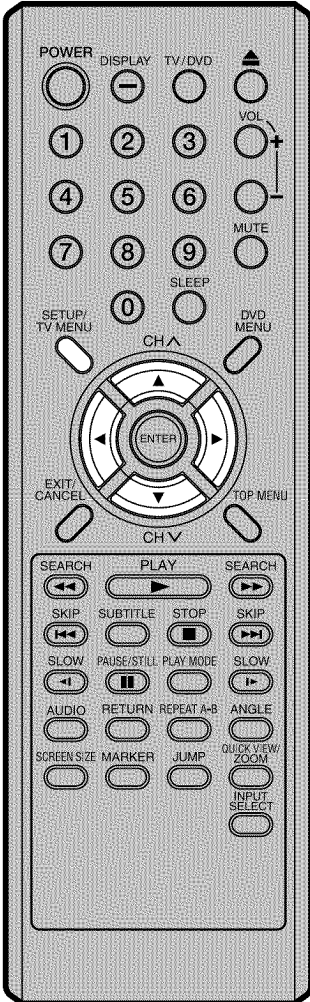
BASS center (25)
TREBLE center (25)
BALANCE center (0)



- 1 Press **SETUP/TV MENU** during PC mode, then press ◀ or ▶ to select  (PICTURE) or  (AUDIO) menu.

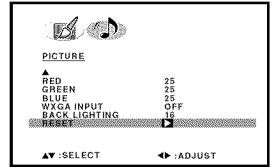

- 2 Press ▲ or ▼ to select "RESET", then press ◀ or ▶.

Preparation/Status display of disc

The following pages describe the setup/operation in DVD mode.

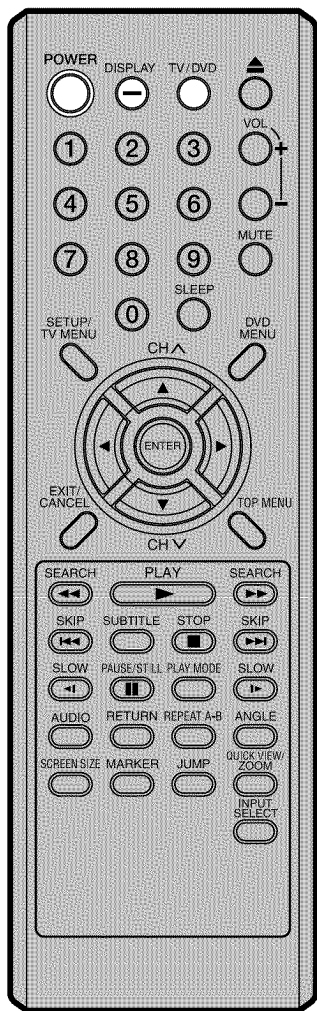

Preparation

Before DVD/CD operation, please make the following preparations.

- 1 Insert the AC cord plug into a standard 120V 60Hz polarized AC outlet.
 - If the AC cord plug is plugged in for the first time, wait for about 5 seconds before pressing **POWER**.

NOTE: When connecting to other equipment, unplug the unit from the AC outlet.
- 2 Press **POWER** on the unit or on the remote control to turn on the unit. The POWER indicator will light.
 - Each time you turn the unit ON, the TV/DVD starts from the TV mode.
 - When using an amplifier, switch on the amplifier.
- 3 Press **TV/DVD** to select DVD mode.
The DVD startup screen will appear on the screen.



Status display of disc

Press **DISPLAY**. The status display of the disc will appear on the screen.

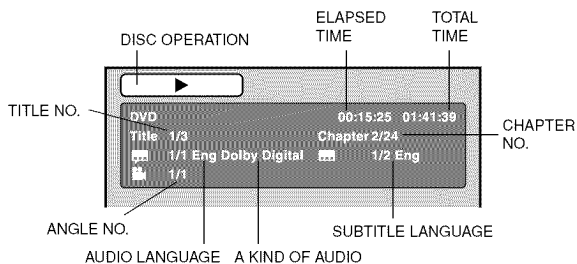

To make the status display screen disappear, press **DISPLAY** again.

NOTE:

If the unit does not operate properly:
Static electricity, etc., may affect the player's operation. Disconnect the AC power cord once, then connect it again.

Playback procedure

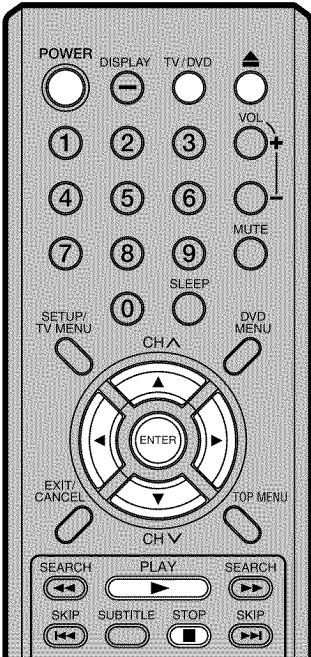

NOTES:

- If a non-compatible disc is loaded, "Incorrect Disc", "Region Code Error" or "Parental Error" will appear on the TV screen according to the type of loaded disc. If these appear, check your disc again (see pages 9 and 57).
- Some discs may take a minute or so to start playback.
- If an 8 cm disc is placed into the disc slot and picture playback or menu display does not begin automatically, press **PLAY**.
- A "Prohibition" symbol "X" may appear at the upper left of the screen. This symbol means either the feature you tried is not available on the disc, or the unit cannot access the feature at this time. This does not indicate a problem with the unit.
- If you place a single-faced disc label backwards (i.e. the wrong way) "Reading" will appear in the display and then "Incorrect Disc" will be displayed.
- Some playback operations of DVDs may be intentionally fixed by software producers. Since this unit plays DVDs according to the disc content recorded, some playback features may not be available. Also refer to the instructions supplied with the DVDs.

1 Press **TV/DVD** to select DVD mode.

2 Place the disc in the disc slot with the label side facing forward. (If the disc has a label.) Hold the disc without touching either of its surfaces, align it with the guides, and place it in position.

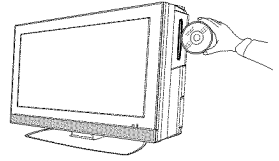

3 On the screen, "▲" changes to "Reading" and then playback will commence.

- A menu screen may appear on the TV screen, if the disc has a menu feature. In this case, press ▲, ▼, ◀, ▶ or **ENTER** to operate a menu feature.

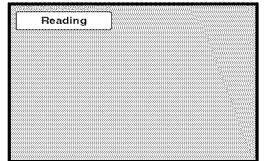
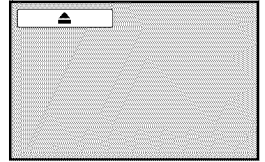

4 Press **STOP** to end playback.

- The unit memorizes the stopped point, depending on the disc. "■" appears on the screen. Press **PLAY** to resume playback (from the scene point).
- If you press **STOP** again ("■" appears on the screen) or unload the disc, the unit will clear the stopped point.

5 Press **▲ (EJECT)**.

Remove the disc and then press **POWER**. The unit turns off.

When you eject the disc, you may hear mechanism noise, but it is not malfunction.

Special playback

NOTE: There may be a slight delay between when you press the button and the function activating.

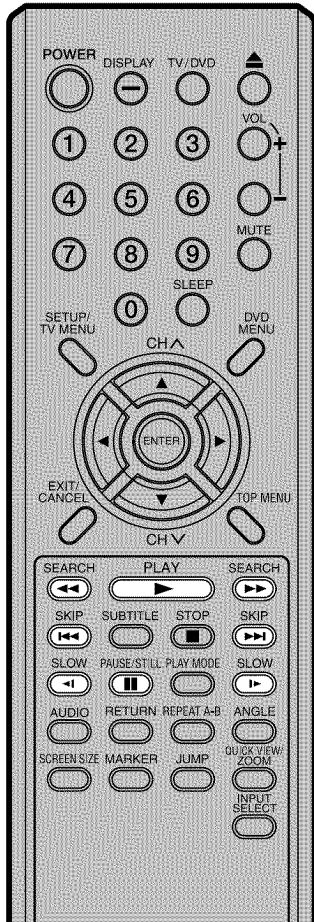

NOTE:

The unit is capable of holding a still video image or On screen display image on your television screen indefinitely. If you leave the still video image or On screen display image displayed on your TV for an extended period of time, you risk permanent damage to your television screen.

Fast Forward Playback

Press **SEARCH** **▶▶** during normal playback. Each press of **SEARCH** **▶▶** will increase the speed of the search **▶▶** (x 2), **▶▶▶** (x 4), **▶▶▶▶** (x 8), **▶▶▶▶▶** (x 15). (CD: **▶▶** (x 2), **▶▶▶** (x 4), **▶▶▶▶** (x 8), **▶▶▶▶▶** (x 20))

- To resume normal playback, press **PLAY**.

Review Playback

Press **SEARCH** **◀◀** during normal playback. Each press of **SEARCH** **◀◀** will increase the speed of the search **◀◀** (x 2), **◀◀◀** (x 4), **◀◀◀◀** (x 8), **◀◀◀◀◀** (x 15). (CD: **◀◀** (x 2), **◀◀◀** (x 4), **◀◀◀◀** (x 8), **◀◀◀◀◀** (x 20))

- To resume normal playback, press **PLAY**.

Still Playback

Press **PAUSE/STILL** during normal playback to pause playback.

- To resume normal playback, press **PLAY**.

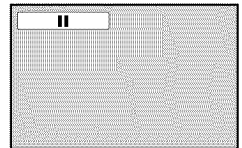

Frame Advance

Press **PAUSE/STILL** during still playback. One frame is advanced each time you press **PAUSE/STILL**.

- To resume normal playback, press **PLAY**.

Slow-motion Playback

Press **SLOW** **◀** Reverse or **SLOW** **▶** Forward during normal playback or still playback. Each press of **SLOW** will change the speed of the slow x1/2, x1/4, x1/6, x1/7.

- To resume normal playback, press **PLAY**.
- To resume the still playback, press **PAUSE/STILL**.

Locating a chapter or track

Press **SKIP** **▶▶▶** Forward or **SKIP** **◀◀◀** Reverse during playback to locate a chapter that you want to watch. Each time you press the button, a chapter or track is skipped.

MP3/WMA/JPEG and Audio CD playback

This player can play back MP3/WMA/JPEG-data which has been recorded on CD-R or CD-RW. To produce MP3/WMA/JPEG-data, you need a Windows-PC with CD-ROM drive and MP3/WMA/JPEG-encoding software (not supplied).

The Apple-HFS-System cannot be played.

MP3/WMA/JPEG CD information Limitations on MP3/WMA/JPEG CD playback

- MP3/WMA/JPEG CD is the disc that is standardized by ISO9660, its file name must include 3-digit extension letters, "mp3", "wma", "jpg".
- The directory and file names of MP3/WMA/JPEG CD must correspond to ISO standardized files.
- This unit can read 2000 files per disc. If one directory has more than 2000 files, it reads up to 2000 files, the remaining files will be omitted.
- MP3/WMA CDs cannot be used for playback for the purpose of recording.
- If the CD has both audio tracks and MP3/WMA/JPEG files, only audio tracks are played.
- It may take more than one minute for this unit to read MP3/WMA/JPEG files depending on its structure.
- Music recorded by "Joliet Recording Specification" can be played back.
- The music files recorded by "Hierarchical File System" (HFS) cannot be played.
- The unit can play back baseline and progressive JPEG files.

Limitations on display

- The maximum number for display is 15 characters. Long file names will be condensed.
- Available letters for display are the following: capital or lowercase letters A through Z, numbers 0 through 9, and _ (under score).
- Other letters than those above are replaced by a hyphen.

Notes on MP3/WMA/JPEG files

To play back MP3/WMA/JPEG CD in the recorded order,

1. Use MP3/WMA/JPEG software that records data alphabetically or numerically.
2. Name each file including a two-digit or three-digit number (e.g. "01" "02" or "001" "002").
3. Refrain from making too many sub-folders.

CAUTION:

- Some MP3/WMA/JPEG CDs cannot be played back depending on the recording conditions.
- The CD-R/RW that has no music data or non-MP3/WMA/JPEG files can not be played back.

MP3 CD/WMA and Audio CD playback

- 1 Load a MP3/WMA/JPEG CD or an Audio CD in the disc slot.
- 2 "Reading" will appear on the TV screen. Reading time will depend on the number of files on the disc.
- 3 A file browser screen will appear on the TV screen.

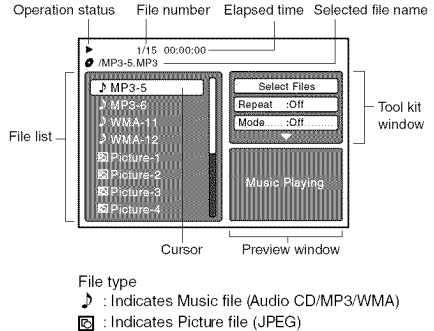

- In case the current directory includes 9 files or more, press **▲** or **▼** to scroll in the file list.
- To see contents in folder, select the folder and then press **ENTER**. To return to the parent directory, select "Go Up ..." then press **ENTER**.
- In case of a CD containing a mixture of MP3, WMA and JPEG files, the files are played back by selecting them from the file browser.

- 4 Press **▲** or **▼** to select the desired file.

When **PLAY** is pressed after displaying file browser, or when the disc tray is closed by pressing **PLAY**, playback begins

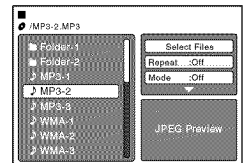

automatically starting from the first file. In this case, if the first file is an MP3/WMA file, only MP3/WMA files are played back in order. If the first file is a JPEG file, the first JPEG file is played back. If there is no file at a root directory, playback does not begin automatically.

- 5 Press **ENTER**.
The selected file starts playing back.

- 6 Press **STOP** to end playback.
 - The unit records the stopped point. "■" appears on the screen. Press **PLAY** to resume playback (from the scene point).
 - If you press **STOP** again or unload the disc, the unit will clear the stopped point.

NOTES:

- During MP3/WMA/JPEG-Playback, you cannot use JUMP and A-B Repeat functions.
- You can use Repeat (Track or All), Random functions and Program playback for MP3/WMA/JPEG and Audio CD Playback (see pages 46 and 47).

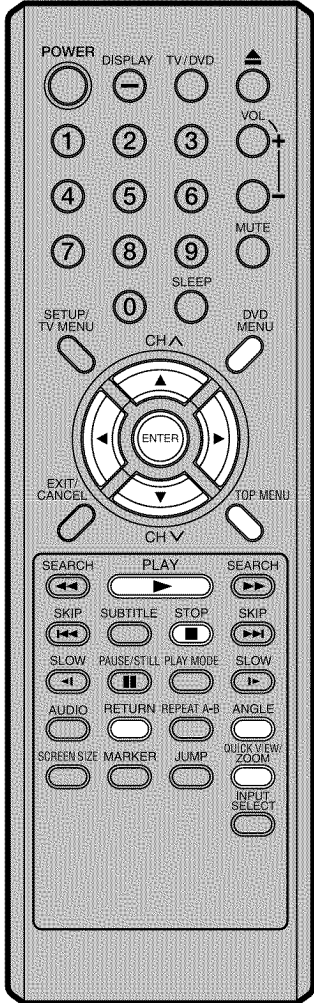

- 1 In the file browser, press ▲/▼ to select the desired JPEG file. To display a thumbnail list, press **DVD MENU**. Press ▲/▼/◀/▶ to select the desired file. (To return to the file browser, press **TOP MENU**.)

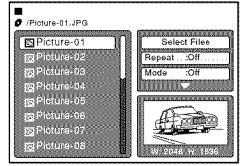

When **PLAY** is pressed after displaying the file browser, or when the disc tray is closed by pressing **PLAY**, playback begins automatically starting from the first file. In this case, if the first file is a JPEG file, the first JPEG file is played back. If the first file is an MP3/WMA file, only MP3/WMA files are played back in order. If there is no file at a root directory, playback does not begin automatically.

- 2 Press **ENTER**. The selected picture appears on the TV screen.

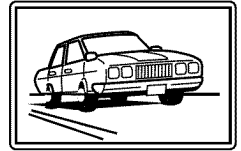

Rotating an image

You can rotate an image by 90 degrees.

Press **ANGLE** during playback of the image.

“”, “”, “” or “” appears on the screen.

Zooming an image

Zoom function also can be used in viewing JPEG files.

Press **ZOOM** (See “Zooming” on page 48).

- 3 Press **STOP** to end playback. The file browser appears on the TV screen. If you want to watch the other file, repeat steps 1-2.

Select Files

The file type to make it display in the file browser can be chosen.

- 1 Press ◀/▶ to select “Select Files” at right column in the file browser.
 - Press **ENTER**, then press ▲/▼ to select file type from the list (Music or Picture).
- 2 Press **ENTER** to add/remove check mark. Checked file type will be displayed in the file browser.
- 3 Press **RETURN** to save the setting.

NOTE:
MP3 or WMA files on the KODAK Picture CD are not recognized on this unit.

Setting the JPEG interval

You can continuously play back all JPEG files automatically.

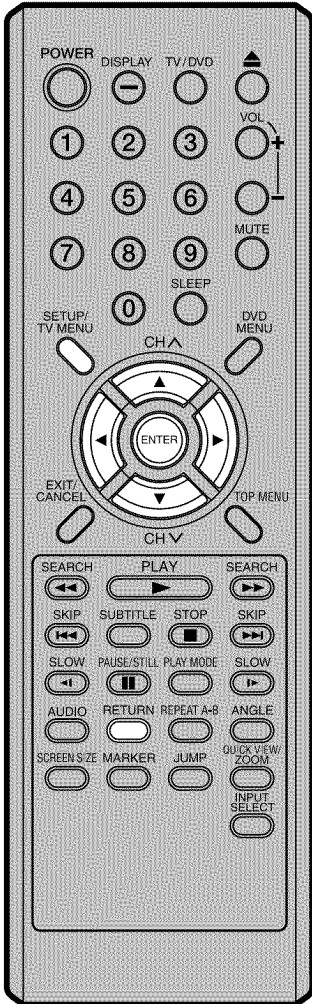

1 Press **SETUP/TV MENU** in the stop mode.
Press **▲** or **▼** to select  option, then press **◀/▶** or **ENTER**.

2 Press **▲** or **▼** to select
“JPEG Interval”, then press **▶**
or **ENTER**.

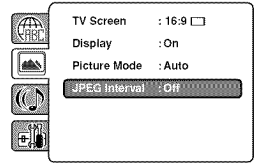

3 Press **▲** or **▼** to select your
desired time, then press
ENTER.

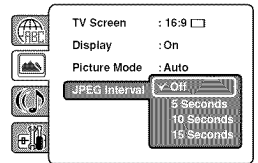

Off:

Plays back one file at a time.

5 Seconds:

Plays back images in the form of a slide show at 5 second intervals.

10 Seconds:

Plays back images in the form of a slide show at 10 second intervals.

15 Seconds:

Plays back images in the form of a slide show in 15 second intervals.

4 Press **SETUP/TV MENU** or **RETURN** to remove the Menu screen.

Program playback (CD)

You can arrange the order of tracks on the disc.

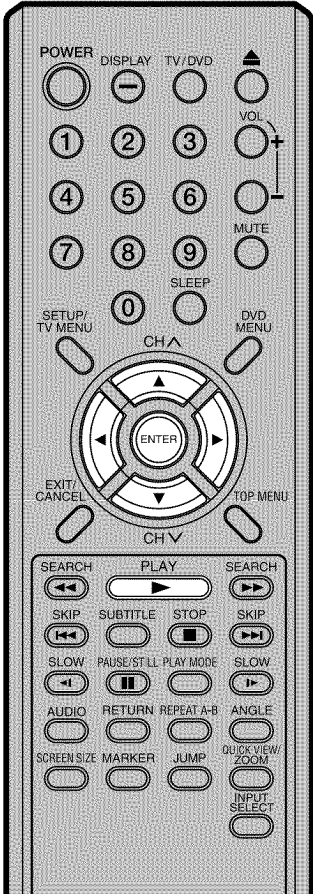

- 1 In the file browser, press ▲/▼/◀/▶ to select “Edit Mode”, then press **ENTER**.

When “Edit Mode” is black color, you can mark the files which you want to add into Program list.

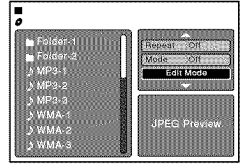

- 2 Press ▲/▼/◀/▶ to select the file you want to add into the program list.

Press **ENTER**. Selected file was marked. Repeat this procedure to select the other files.

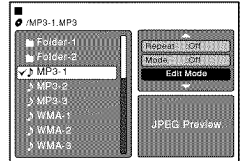

- 3 Press ▲/▼/◀/▶ to select “Add To Program”. Then press **ENTER**. All marked files are added into the program list.

When you finish storing the files you want into the Program list, select “Edit Mode” again and press **ENTER** to release edit mode.

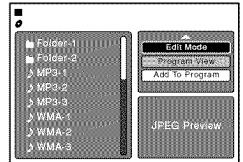

- 4 Press ▲/▼ to select “Program View”, then press **ENTER**. Program View shows only the programmed files that you have added in Step 2.

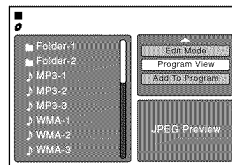

Browser View

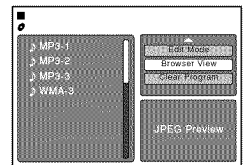

Program View

- 5 In the Program View, press **PLAY**. The files start to playback in programmed order that were added by you.

To remove file from program list in stop mode

In the Edit Mode, switch to Program View. Select the files you want to remove, then press **ENTER**. Select “Clear Program” and press **ENTER**. Marked file is removed from program list.

NOTE:

The program is cancelled when you eject the disc or turn the power off.

Repeat playback (CD)/Random playback (CD)

Repeat playback

- 1 In the file browser, press ▲/▼/◀/▶ to select "Repeat" during stop mode.

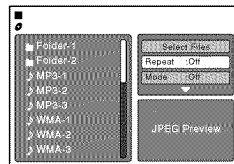

- 2 Press **ENTER** repeatedly to select "Track" or "All".

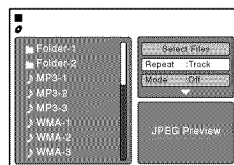

- 3 Press **PLAY**.
The unit automatically starts repeat playback after finishing the current track.

To resume normal playback, select Repeat : "Off" in step 2.

Random playback

- 1 In the file browser, press ▲/▼/◀/▶ to select "Mode" during stop mode.

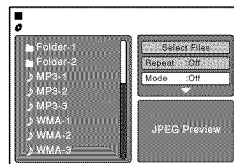

- 2 Press **ENTER** to select "Random".

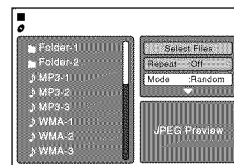

- 3 Press **PLAY**.
The Random playback will start.

To resume normal playback, select Repeat : "Off" in step 2.

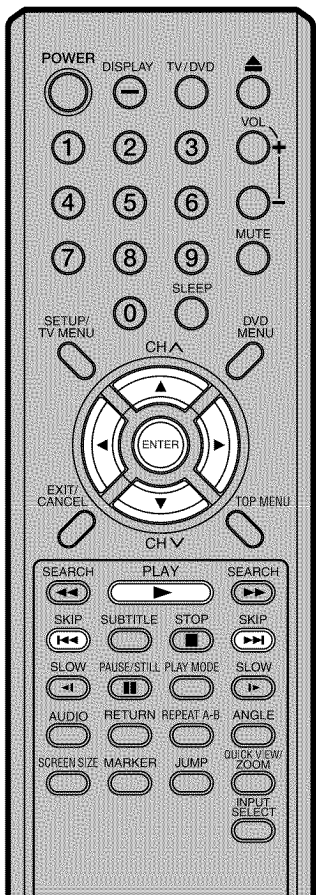

NOTES:

- The repeat or random function is canceled when you open the disc tray or turn the power off.
- The track repeat function is canceled when **SKIP** ◀◀ or ▶▶ is pressed.
- In case of Audio CD, the function of A-B Repeat also can be used. See "A-B Repeat playback" 49 .

Zooming/Locating desired scene

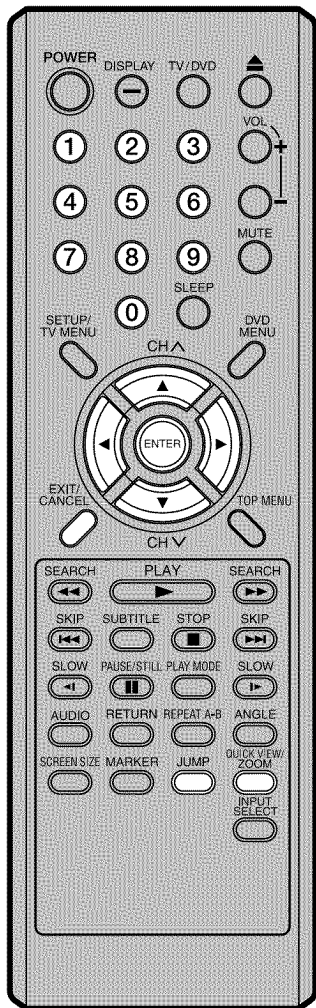

Zooming

This unit will allow you to zoom in on the frame image. You can then make selections by switching the position of the frame.

- 1 Press **ZOOM** during playback. The center part of the image will be zoomed in. Each press of **ZOOM** will change the ZOOM magnification **Q1** (x 1.3), **Q2** (x 1.5) and **Q3** (x 2.0).

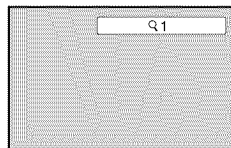

- 2 Press **▲/▼/◀/▶** to view a different part of the frame. You may move the frame from the center position UP, DOWN, LEFT or RIGHT.
- 3 In the zoom mode press **ZOOM** repeatedly to return to a 1:1 view (**Q Off**).

Locating desired scene

Use the title, chapter and time recorded on the disc to locate the desired point to playback.

- 1 Press **JUMP** during playback or resume stop mode.

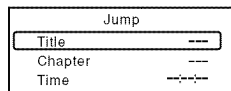

- 2 Press **▲** or **▼** to select the "Time", "Title/track" or "Chapter".

- 3 Press **Number buttons (0-9)** to input the number.

- If you input a wrong number, press **CANCEL**.
- Refer to the package supplied with the disc to check the numbers.

- 4 Press **ENTER**.

- Playback starts.
- When you change the title, playback starts from Chapter 1 of the selected title.
- Some discs may not work in the above operation.

NOTES:

- You can select the Pause, Slow or Search playback in the zoom mode.
- Some discs may not respond to zoom feature.

Repeat playback

Title, Chapter, Track Playback

1 Press **PLAY MODE** during playback or stop mode.

2 Press **ENTER** repeatedly to select “Chapter” or “Title”.
The unit automatically starts repeat playback after finishing the current title or chapter.



- If you set the repeat mode during stop mode, press **PLAY** to start Repeat playback.

3 Press **PLAY MODE** again to make the screen disappear.

- Press **PLAY** to start Repeat playback.
- To resume normal playback, select Repeat “Off” in step 2.

A-B Repeat Playback

A-B repeat playback allows you to repeat material between two selected points.

1 Press **REPEAT A-B** during playback.
The start point is selected.

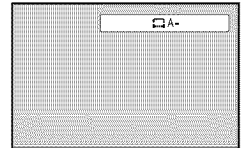

2 Press **REPEAT A-B** again.
The end point is selected.
Playback starts at the point that you selected. Playback stops at the end point, returns to Point A automatically, then starts again.

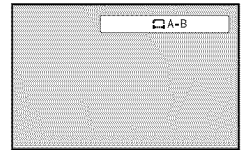

To resume normal playback press **REPEAT A-B** again.
“Off” appears on the screen.

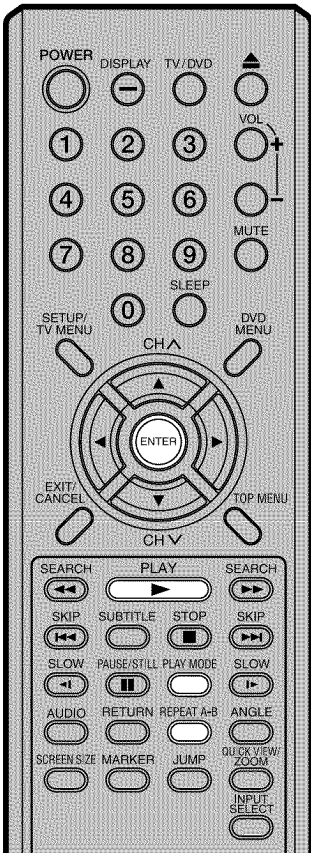

NOTES:

- Some discs may not work with the repeat operation.
- In A-B repeat mode, subtitles near point A or B may not appear.
- During the A-B Repeat Playback the ANGLE feature will not operate.
- You may not be able to set A-B Repeat, depending on the scenes of the DVD.
- A-B Repeat does not work with an interactive DVD, MP3/MPEG/WMA/JPEG-CD.

Marking desired scenes

The TV/DVD stores the points that you want to watch again. You can resume playback from that scene.

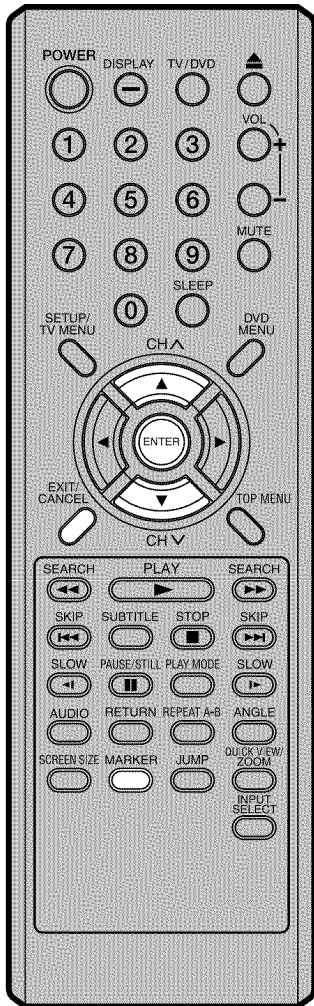

NOTES:

- The marking is canceled when you eject the disc or turn the power off.
- Some subtitles recorded around the marker may fail to appear. [DVD]

Marking the Scenes

1 Press **MARKER** during playback.

Marker 1	--:--:--
Marker 2	--:--:--
Marker 3	--:--:--

2 Select the blank Marker using **▲** or **▼**, then press **ENTER** at the desired scene.

Marker 1	00:27:54
Marker 2	--:--:--
Marker 3	--:--:--

- Up to 3 scenes can be selected.
- Repeat this procedure to set the other 2 scenes.

3 Press **MARKER** to remove this display.

Returning to the Scenes

1 Press **MARKER** during playback or stop mode.

Marker 1	00:27:54
Marker 2	01:16:25
Marker 3	02:08:31

2 Press **▲** or **▼** to select the Marker 1-3.

Marker 1	00:27:54
Marker 2	01:16:25
Marker 3	02:08:31

3 Press **ENTER**.
Playback starts from the marked scene.

To Cancel the Mark

1 Press **MARKER**.

2 Press **▲** or **▼** to select the Marker 1-3.

3 Press **CANCEL**.
Press **MARKER** to remove this display.

Changing soundtrack language/Subtitles

Changing soundtrack language

You can select the language when you play a multilingual disc.

- 1 Press **AUDIO** during playback.

The current soundtrack language will appear.

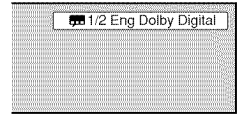

- 2 Press **AUDIO** repeatedly until the desired language is selected.

The on-screen display will disappear after a few seconds.



Subtitles

Turning the subtitles on and off

When playing back a disc recorded with subtitles, you can turn the subtitles on or off.

- 1 Press **SUBTITLE** during playback until "Off" appears.

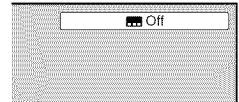

Changing the subtitle language

You can select the language when playing back a disc recorded with multi-lingual subtitles.

- 1 Press **SUBTITLE** repeatedly during playback until your desired language appears.



- 2 The on-screen display will disappear after a few seconds.

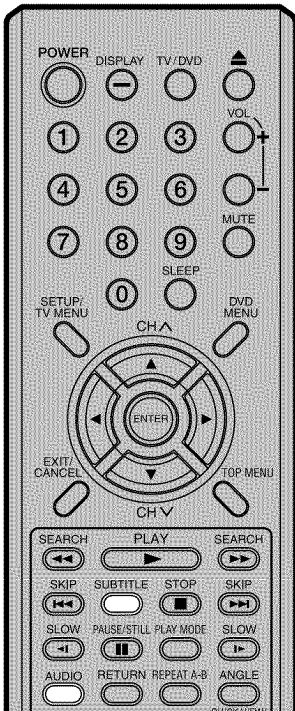

NOTES:

- If the desired language is not heard after pressing **AUDIO** several times, the language is not recorded on the disc.
- Changing soundtrack language is cancelled when you eject the disc.
The initial default language or available language will be heard if the disc is played back again.
- Changing subtitle language is cancelled when you eject the disc.
- Some functions may not work on some DVDs. You may not be able to turn subtitles on or off or change subtitles.
While playing the DVD, the subtitle may change when:
 - you eject the disc.
 - you change the title.
- In some cases, the subtitle language is not changed to the selected one immediately.

Changing angles/Title selection/DVD menu

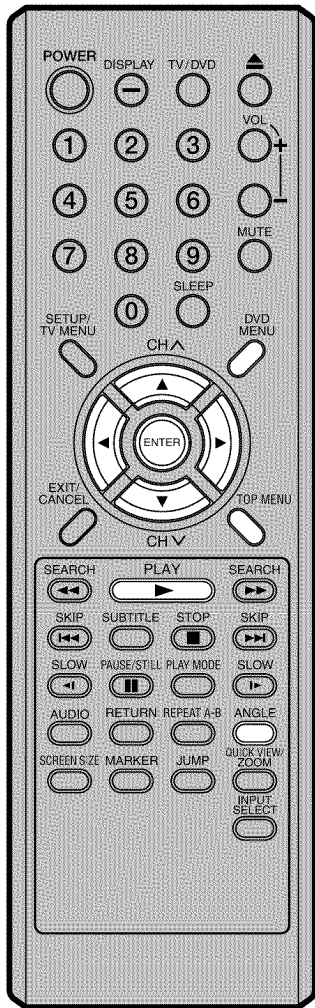

Changing angles

When playing back a disc recorded with multi-angle facility, you can change the view angle.

- 1 Press **ANGLE** during playback.

The current angle will appear.

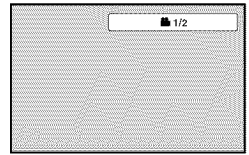

- 2 Press **ANGLE** repeatedly until the desired angle is selected.

Title selection

Two or more titles are recorded on some discs. If the title menu is recorded on the disc, you can select the desired title.

- 1 Press **TOP MENU** during playback. Title menu appears on the screen.
- 2 Press **▲/▼** or **◀/▶** to select the desired title.
- 3 Press **ENTER** or **PLAY**. The playback of the selected title will start.

DVD menu

Some DVDs allow you to select the disc contents using the menu.

When you play back these DVDs, you can select the subtitle language and soundtrack language, etc. using the DVD menu.

- 1 Press **DVD MENU** during playback. The DVD menu appears on the screen.
 - Press **DVD MENU** again to resume playback at the scene when you pressed **DVD MENU**.
- 2 Press **▲/▼** or **◀/▶** to select the desired item.
- 3 Press **ENTER**. The menu continues to another screen. Repeat steps 2 and 3 to set additional items if any.

NOTES:

- Depending on the DVD, you may not be able to change the angles even if multi-angles are recorded on the DVD.
- Depending on the DVD, you may not be able to select the title. Depending on the DVD, a "title menu" may simply be called a "menu" or "title" in the instructions supplied with the disc.

Setting the language

You can select the language of "Menu", "Subtitle" and "Audio" if more than one languages are recorded onto the disc.

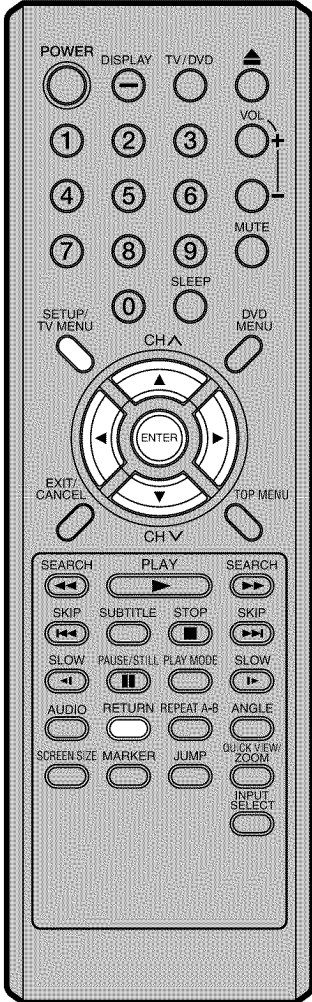

- 1 Press **SETUP/TV MENU** in the stop mode. Press **▲** or **▼** to select  option, then press **◀/▶** or **ENTER**.
- 2 Press **▲** or **▼** to select desired option, then press **▶** or **ENTER**.

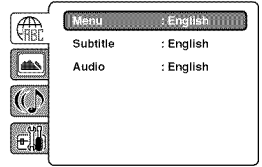

- 3 Press **▲** or **▼** to select your desired language (e.g. English).

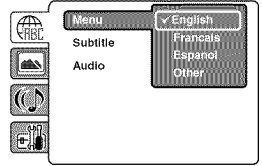

English, Francais, Espanol :

The selected language will be heard or seen.

Other:

Other language can be selected (see the "Language code list" on page 60).

Original (Audio):

The unit will select the first priority language of each disc.

Off (Subtitle):

Subtitles do not appear.

- 4 Press **SETUP/TV MENU** or **RETURN** to remove the Menu screen.

NOTE:

If the selected language is not recorded on the disc, the first priority language is selected.

Setting the aspect ratio of TV screen/Setting on screen display

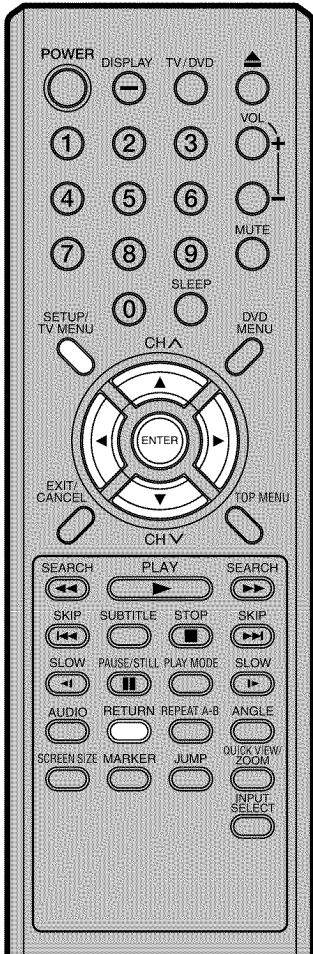

NOTE:

It is not always possible for the DVD disc to display the picture as per your preferred picture setting - for example, if you select "4:3 Panscan", the disc may not offer this option. In this case the picture would display the format the disc is capable of playing back.

Setting the aspect ratio of TV screen

You can select the aspect ratio of the picture.

- 1 Press **SETUP/TV MENU** in the stop mode or No Disc. Press **▲** or **▼** to select  option, then press **◀/▶** or **ENTER**.
- 2 Press **▲** or **▼** to select "TV Screen", then press **▶** or **ENTER**.
- 3 Press **▲** or **▼** to select your desired screen type, then press **ENTER**.

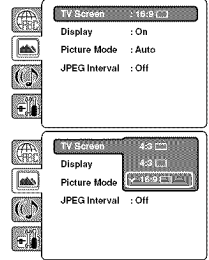

You have the following screen sizes to choose from:

4:3 Letterbox

When playing back a wide screen DVD disc, it displays the wide picture with black bands at the top and bottom of screen.

4:3 Panscan

It displays the wide picture on the whole screen with left and right edges automatically cut off.

16:9 Wide

A wide screen picture is displayed full size.

- 4 Press **SETUP/TV MENU** or **RETURN** to remove the Menu screen.

Setting on screen display

On screen display can be switched on or off when you press the **DISPLAY** button.

- 1 Press **SETUP/TV MENU** in the stop mode or No Disc. Press **▲** or **▼** to select  option, then press **◀/▶** or **ENTER**.
- 2 Press **▲** or **▼** to select "Display", then press **▶** or **ENTER**.
- 3 Press **▲** or **▼** to select "On" or "Off", then press **ENTER**.

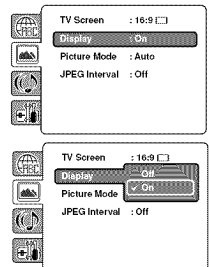

On: On screen displays appear when you press the buttons (factory setting).

Off: On screen displays do not appear when you press any buttons except **SUBTITLE**, **PLAY MODE**, **MARKER** and **DISPLAY**.

- 4 Press **SETUP/TV MENU** or **RETURN** to remove the Menu screen.

Setting the picture mode

There are two types of source content in pictures recorded in DVD video discs: film content (pictures recorded from films at 24 frames per second) and video content (video signals recorded at 30 frames per second). Make this selection according to the type of content being viewed.

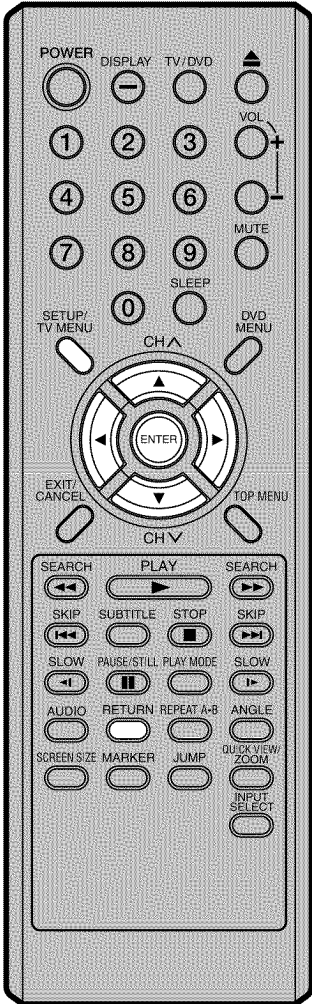

Setting the picture mode

1 Press **SETUP/TV MENU** in the stop mode or No Disc. Press **▲** or **▼** to select  option, then press **◀/▶** or **ENTER**.

2 Press **▲** or **▼** to select "Picture Mode", then press **▶** or **ENTER**.

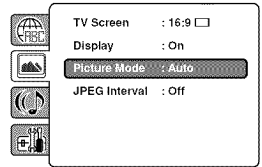

3 Press **▲** or **▼** to select your desired picture mode, then press **ENTER**.

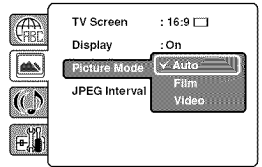

Auto:

Select this position normally. The DVD player automatically detects source content, film or video, of playback source.

Film:

Suitable for playback of film content pictures.

Video:

Suitable for playback of video content pictures.

4 Press **SETUP/TV MENU** or **RETURN** to remove the menu screen.

NOTE:

Depending on the disc, pictures may be cut off or doubled. In this case, select "Video".

Night Mode/Digital Out

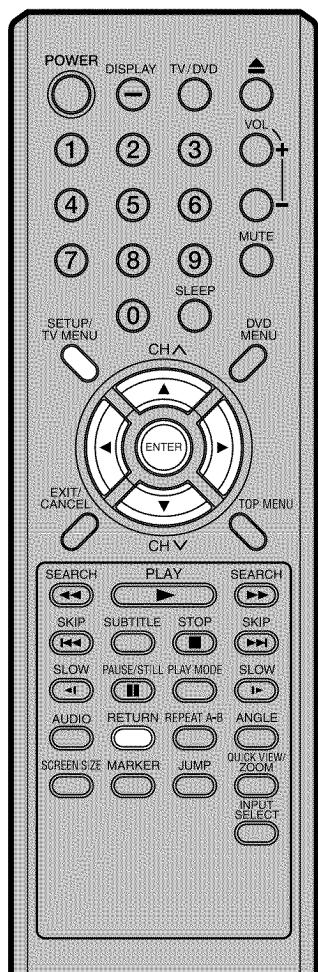

Night Mode

Night Mode enables you to control the dynamic range so as to achieve a suitable sound for your equipment.

1 Press **SETUP/TV MENU** in the stop mode or No Disc. Press **▲** or **▼** to select  option, then press **◀/▶** or **ENTER**.

2 Press **▲** or **▼** to select "Night Mode", then press **▶** or **ENTER**.

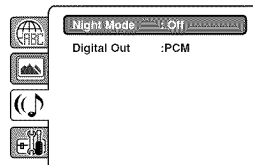

3 Press **▲** or **▼** to select "On" or "Off", then press **ENTER**.

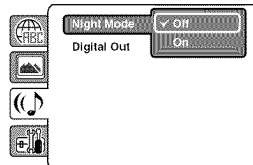

On : Loud sound such as explosion or similar is toned down slightly when play back. This makes it suitable for when it is connected to a stereo.

Off : It plays back at the recording level on the disk.

4 Press **SETUP/TV MENU** or **RETURN** to remove the Menu screen.

Digital Out

You can select the digital output sound format corresponding to your system connection.

1 Press **SETUP/TV MENU** in the stop mode or No Disc. Press **▲** or **▼** to select  option, then press **◀/▶** or **ENTER**.

2 Press **▲** or **▼** to select "Digital Out", then press **▶** or **ENTER**.

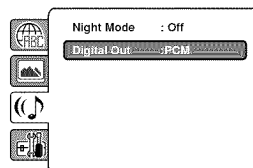

3 Press **▲** or **▼** to select "PCM", "Bitstream" or "Off", then press **ENTER**.

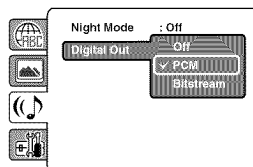

PCM: Change Dolby Digital to PCM for the output. Select when connected to a 2 channel digital stereo amplifier.

Bitstream: Disc audio bitstream data will be output.

Off: There is no sound output from DIGITAL AUDIO OUT jack.

4 Press **SETUP/TV MENU** or **RETURN** to remove the Menu screen.

NOTES:

- This function works only during playback of Dolby Digital recorded discs.
- The level of Dynamic Range Reduction may differ depending on DVD video disc.
- Even if you select "Bitstream", MPEG audio will be output in PCM format.

Parental control setting

Some discs are specified not suitable for children. Such discs can be limited not to play back with the unit.

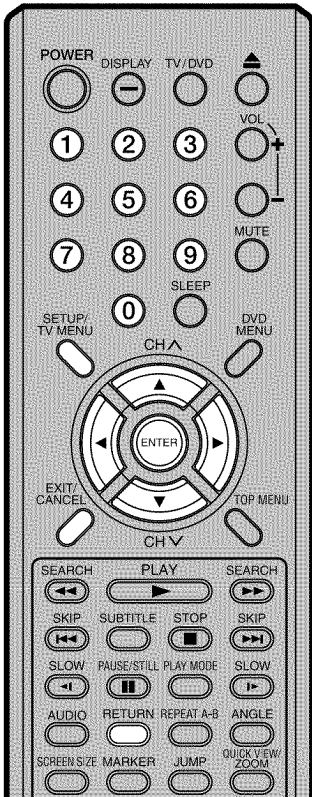

NOTES:

- If each setup (P.53~58) has been completed, the unit can always be operated under the same conditions (especially with DVD discs). Each setup will be retained in the memory when you turn the power off.
- Depending on the discs, the unit cannot limit playback.
- Some discs may not be encoded with specific rating level information though its disc jacket says "adult". For those discs, the age restriction will not work.
- After the rating is locked, the setting cannot be changed unless you enter the correct password.

1 Press **SETUP/TV MENU** in the stop mode or No Disc. Press **▲** or **▼** to select  option. Then press **◀/▶** or **ENTER**.

2 Press **▲** or **▼** to select "Parental", then press **▶** or **ENTER**. "Enter Password" screen will appear.

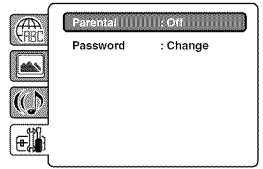

3 Press "0000" using **Number buttons (0-9)**. (Please note, this pre-setting password of this unit). Then press **ENTER**. The parental level list will appear.

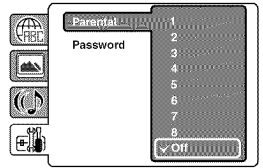

- **Level Off** : The parental control setting does not function.
- **Level 8** : Virtually all DVD software can be played back.
- **Level 1** : DVD software for adults cannot be played back.

• Select from level 1 to level 8. The limitation will be more severe as the level number decreases.

• If you input a wrong number, press **CANCEL**.

4 Press **▲** or **▼** to select the level 1 to level 8. The limitation will be more severe as the level is lower. Then press **ENTER**.

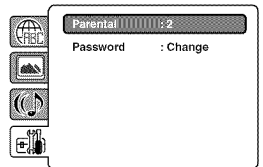

5 Press **SETUP/TV MENU** or **RETURN** to remove the Menu screen.

Setting the new password

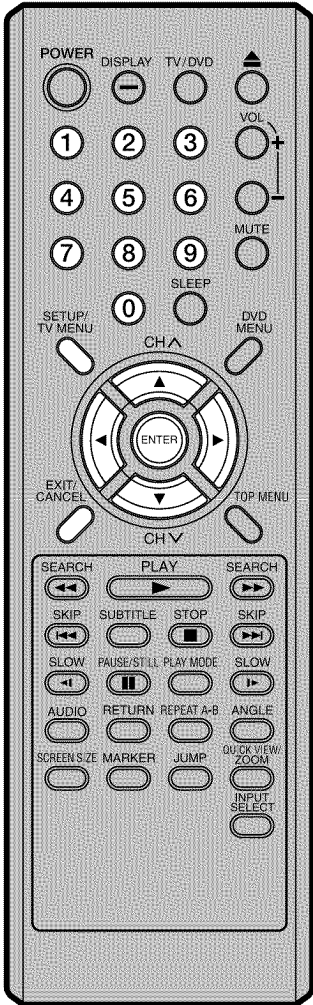

1 Press **SETUP/TV MENU** in the stop mode or No Disc. Press **▲** or **▼** to select option. Then press **◀/▶** or **ENTER**.

2 Press **▲** or **▼** to select "Password", then press **▶** or **ENTER**. "Enter Current Password" screen will appear.

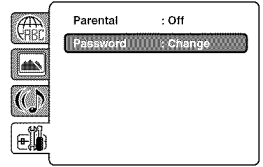

3 Press **Number buttons (0-9)** to enter the password you have stored.

- If you input a wrong number, press **CANCEL**.

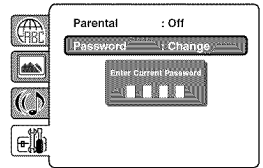

4 Then press **ENTER**. "Enter New Password" screen will appear. Press **Number buttons (0-9)** to input the new password.

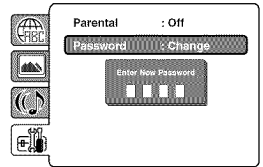

5 Press **ENTER**. Now your new password has been set. Be sure to remember this number!

NOTE:

Do not forget the password. If you forget the password, contact Customer Service at 1-800-289-0980. The original remote control will be required.

Temporary disabling of rating level by DVD disc

Depending on the DVD disc, the disc may try to temporarily cancel the rating level that you have set. It is up to you to decide whether to cancel the rating level or not.

- 1 Load a DVD disc (see page 41).

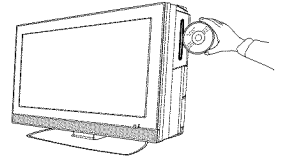

- 2 If the DVD disc has been designed to temporarily cancel the Rating level, the screen which follows the "Reading" screen will change, depending on which disc is played. If you select "YES" with **ENTER** key, password input screen will then appear.

- 3 Enter the password with **Number buttons (0-9)**. Then press **ENTER**.

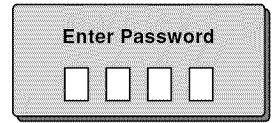

- If you interrupt the entering, press **RETURN**.

- 4 Playback will commence if the entered password was correct.

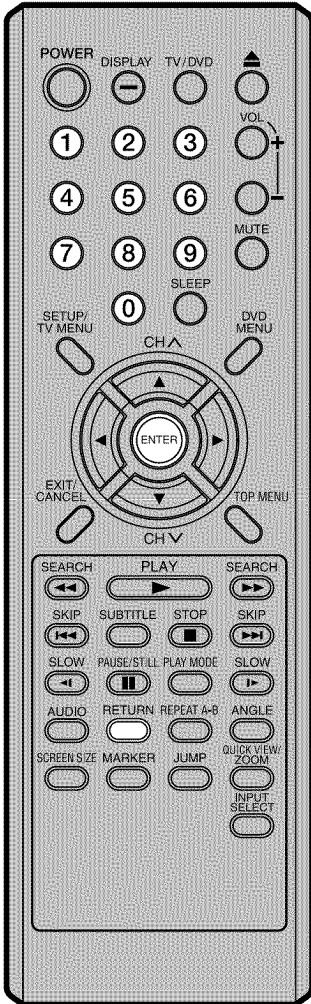

NOTE:

This temporary cancellation of the rating level will be kept until the disc is ejected. When the disc is ejected, the original rating level will be set again automatically.

Language code list

Enter the appropriate code number for the initial settings “Menu”, “Subtitle” and/or “Audio” (see page 53).

Language Name Code	Language Name Code	Language Name Code	Language Name Code
Abkhazian 1112	Fiji 1620	Lingala 2224	Singhalese 2919
Afar 1111	Finnish 1619	Lithuanian 2230	Slovak 2921
Afrikaans 1116	French 1628	Macedonian 2321	Slovenian 2922
Albanian 2927	Frisian 1635	Malagasy 2317	Somali 2925
Amharic 1123	Galician 1722	Malay 2329	Spanish 1529
Arabic 1128	Georgian 2111	Malayalam 2322	Sundanese 2931
Armenian 1835	German 1415	Maltese 2330	Swahili 2933
Assamese 1129	Greek 1522	Maori 2319	Swedish 2932
Aymara 1135	Greenlandic 2122	Marathi 2328	Tagalog 3022
Azerbaijani 1136	Guarani 1724	Moldavian 2325	Tajik 3017
Bashkir 1211	Gujarati 1731	Mongolian 2324	Tamil 3011
Basque 1531	Hausa 1811	Nauru 2411	Tatar 3030
Bengali; Bangla 1224	Hebrew 1933	Nepali 2415	Telugu 3015
Bhutani 1436	Hindi 1819	Norwegian 2425	Thai 3018
Bihari 1218	Hungarian 1831	Oriya 2528	Tibetan 1225
Breton 1228	Icelandic 1929	Panjabi 2611	Tigrinya 3019
Bulgarian 1217	Indonesian 1924	Pashto, Pushto 2629	Tonga 3025
Burmese 2335	Interlingua 1911	Persian 1611	Turkish 3028
Byelorussian 1215	Irish 1711	Polish 2622	Turkmen 3021
Cambodian 2123	Italian 1930	Portuguese 2630	Twi 3033
Catalan 1311	Japanese 2011	Quechua 2731	Ukrainian 3121
Chinese 3618	Javanese 2033	Rhaeto-Romance 2823	Urdu 3128
Corsican 1325	Kannada 2124	Romanian 2825	Uzbek 3136
Croatian 1828	Kashmiri 2129	Russian 2831	Vietnamese 3219
Czech 1329	Kazakh 2121	Samoan 2923	Volapük 3225
Danish 1411	Kirghiz 2135	Sanskrit 2911	Welsh 1335
Dutch 2422	Korean 2125	Scots Gaelic 1714	Wolof 3325
English 1524	Kurdish 2131	Serbian 2928	Xhosa 3418
Esperanto 1525	Laothian 2225	Serbo-Croatian 2918	Yiddish 2019
Estonian 1530	Latin 2211	Shona 2924	Yoruba 3525
Faroese 1625	Latvian, Lettish 2232	Sindhi 2914	Zulu 3631

Connections to other equipment

The exact arrangement you use to interconnect various video and audio components to this unit is dependent on the model and features of each component. Check the Owner's Manual provided with each component for the location of video and audio inputs and outputs.

To connect the LCD TV/DVD to a VCR

Left side of the unit

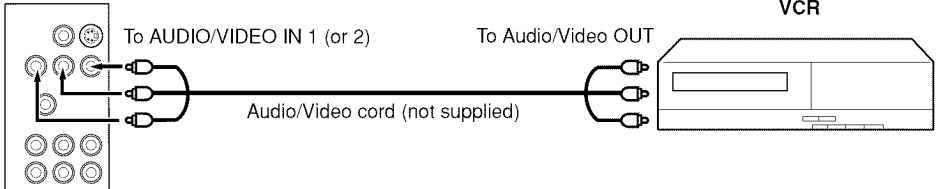

To connect the LCD TV/DVD to a VCR with an S-Video cord

If you connect a VCR with a S-VIDEO cable to the S-VIDEO IN jack on the rear lower right of the unit, you must also connect the audio cables to the AUDIO IN jacks on the rear lower right of the unit.

The S-VIDEO cable only carries the video signal. The audio signal is separate.

NOTE:

When the S-video cable and the standard video cable are connected at the same time, the S-video cable takes precedence.

Left side of the unit

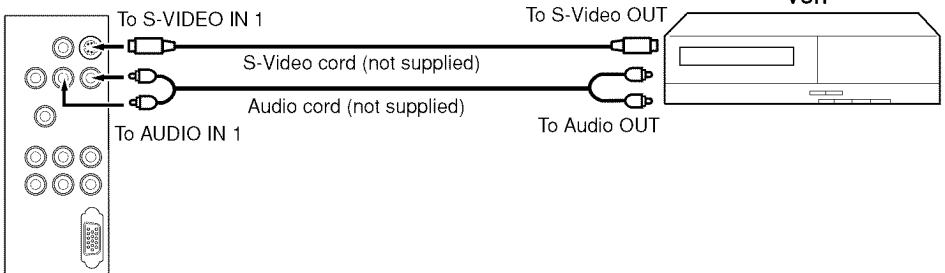

To connect to a DVD player with Component Video Input

You can enjoy a high quality picture by connecting the unit's COMPONENT VIDEO OUT jacks of your DVD player with the COMPONENT video cables (not supplied).

Left side of the unit

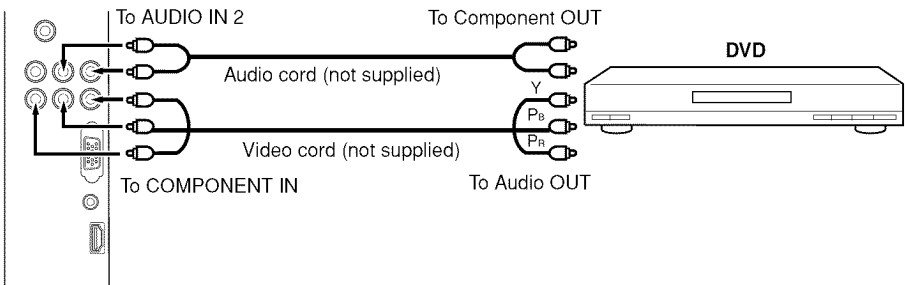

NOTE:

Component Video input of the unit are for use with a device which output 480i/1080i interlaced signals and 480p/720p progressive signals.

To connect a HDMI or a DVI device to the unit

The HDMI input receives digital audio and uncompressed video from a HDMI device or uncompressed digital video from a DVI device.

When you connect to a DVI device with a HDMI-to-DVI adapter cable, it transfers only video signal. Separate analog audio cords required.

Left side of the unit

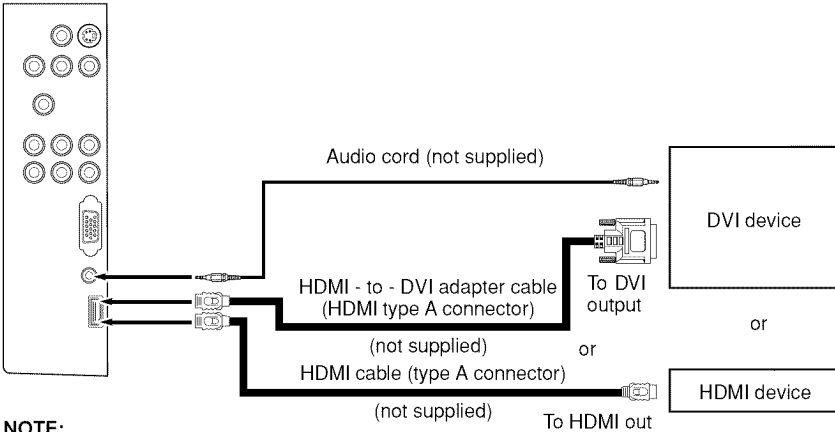

NOTE:

You must choose an appropriate setting for each connection (see page 35. "Selecting the HDMI audio input source").

Using an AV Amplifier with built-in digital surround

If you are using an Amplifier with built-in digital surround sound, you can enjoy various audio systems including Dolby Digital Surround audio that sounds just like the movie.

Connect an AV amplifier with built-in Dolby Digital decoder, DTS decoder, or MPEG decoder etc. as shown below.

Left side of the unit

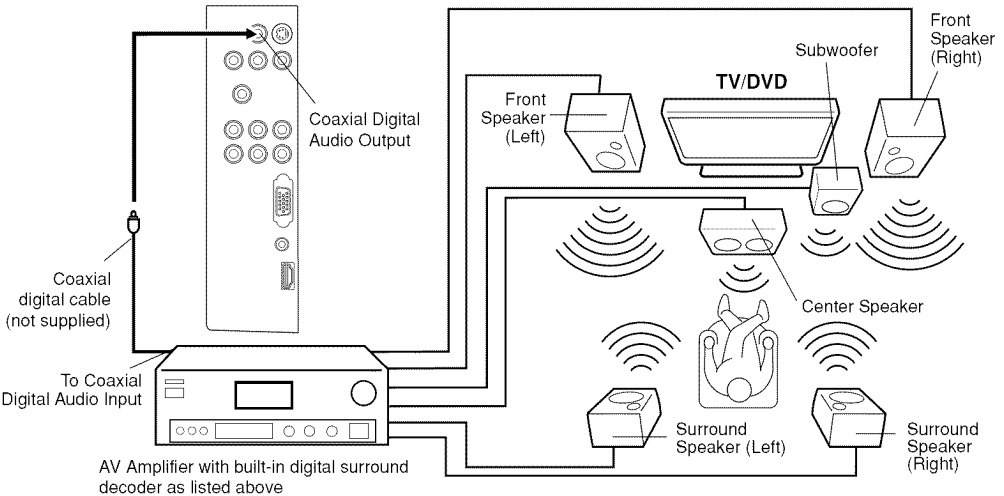

NOTES:

- This unit will not work in conjunction with DTS audio. There will be no sound output if connected to an AV amplifier with a built-in DTS decoder.
- Coaxial digital audio output is active only when receiving digital broadcasting, not when receiving analog broadcasting.

To connect the TV/DVD to a camcorder, or a TV Game

To playback from a camcorder, connect the camcorder to the unit as shown.

This unit can also be used as a display device for many video games. However, due to the wide variety of signals generated by these devices and subsequent hook-up variations required, they have not all been included in the suggested connection diagrams. You'll need to consult each component's Owner's Manual for additional information.

Left side of the unit

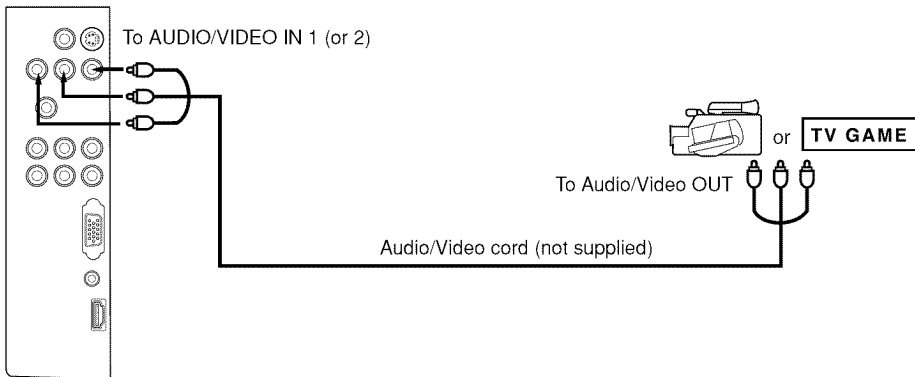

To connect the TV/DVD to a PC (Personal Computer)

Before you connect this TV/DVD to your PC, change the adjustment of your PC's Resolution and Refresh rate (60 Hz).

Connect one end of a (male to male) VGA cable to the video card of the computer and the other end to the VGA connector PC MONITOR on the back of the TV/DVD. Attach the connectors firmly with the screws on the plug. In case of a Multimedia computer, connect the audio cord to the audio output of your Multimedia computer and to the AUDIO connector of the PC/HDMI AUDIO IN jacks of the TV/DVD.

Press **INPUT SELECT** on the remote control to select PC mode.

Switch on the computer. The TV/DVD can operate as the computer monitor.

Left side of the unit

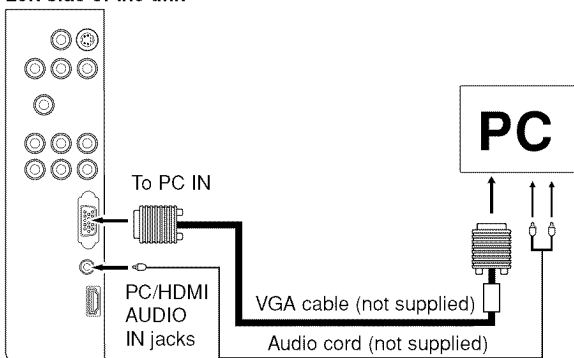

Monitor Display modes

MODE	Resolution	Refresh rate
VGA	640x480	60Hz
VGA	720x400	70Hz
WVGA	848x480	60Hz
SVGA	800x600	60Hz
XGA	1024x768	60Hz
WXGA	1280x768	60Hz
WXGA	1280x720	60Hz

To return to normal mode

Press **INPUT SELECT** again.

NOTES:

- The on-screen displays will have a different appearance in PC mode than in TV mode.
- When you select WXGA or WVGA mode, see the WXGA INPUT to ON in the PC PICTURE menu (see page 38).
- If there is no video signal from the PC when the unit is in PC mode, "NO SIGNAL" will appear on the TV-screen.

Reception disturbances

Most types of television interference can be remedied by adjusting the height and position of the VHF/UHF antenna. Outdoor antennas are recommended for best results. The most common types of television interference are shown below. If one of these symptoms appear when the TV/DVD is connected to a Cable TV system, the disturbance may be caused by the local Cable TV company broadcast.

IGNITION

Black spots or horizontal streaks may appear, the picture may flutter or drift. Usually caused by interference from automobile ignition systems, neon lamps or AC powered tools and appliances such as drills or hair dryers.



GHOSTS

Ghosts are caused by the television signal following two paths. One is the direct path and the other is reflected by tall buildings, hills or other large objects. Changing the direction or position of the antenna may improve the reception.



SNOW

If the TV/DVD is located far from the TV station, in a fringe reception area where the signal is weak, small dots may appear in the picture. If the signal is extremely weak, the installation of a larger external antenna may be necessary.



RADIO FREQUENCY INTERFERENCE (RFI)

Caused by two-way radios, this type of interference produces moving ripples or diagonal streaks in the picture. Some cases may cause a loss of contrast in the picture. Changing the direction and position of the antenna or installing an RFI filter may improve the picture.

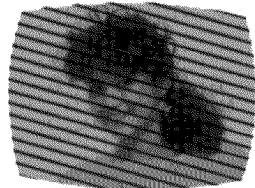

PICTURE SIZE VARIATION

A slight picture size variation is normal when you adjust the CONTRAST or BRIGHTNESS settings.



CARE AND MAINTENANCE

To prevent fire or shock hazard, disconnect the TV/DVD from the power source before cleaning. Clean the LCD using a dry soft cloth such as gauze.

The finish on the cabinet may be cleaned with mild soap and a soft, damp cloth and cared for as other furniture. Use caution when cleaning or wiping the plastic parts.

Problems and troubleshooting

Use the following check list for troubleshooting when you have problems with your TV/DVD. Consult your local dealer or service outlet if problems persist.

Be sure all connections are properly made when using with other units.

SYMPTOMS	POSSIBLE SOLUTIONS	PAGE
POWER		
TV/DVD does not operate.	<ul style="list-style-type: none"> • Make sure the power cord is plugged in. • Power is off, check fuse or circuit breaker. • Unplug unit, then plug it back in. 	13
TV BROADCAST RECEPTION		
Poor sound or no sound.	<ul style="list-style-type: none"> • Station or Cable TV experiencing problems, tune to another station. • Check Volume adjustments. • Check for sources of possible interference. 	17 17,18 64
Poor picture or no picture.	<ul style="list-style-type: none"> • Station or Cable TV experiencing problems, tune to another station. • Check antenna or Cable TV connections, reorient antenna. • Check for sources of possible interference. • Check picture control adjustments. 	17 14,15 57 30
Poor reception on some channels.	<ul style="list-style-type: none"> • Station or Cable TV experiencing problems, tune to another station. • Station signal is weak, reorient antenna to receive stronger station. • Check for sources of possible interference. 	17 14 64
Poor color or no color.	<ul style="list-style-type: none"> • Station or Cable TV experiencing problems, tune to another station. • Make sure channels are set into memory. • Check picture control adjustments. • Check antenna or Cable TV connections, reorient antenna. • Check for sources of possible interference. 	17 20 30 14,15 64
Picture wobbles or drifts.	<ul style="list-style-type: none"> • Station or Cable TV experiencing problems, tune to another station. • Make sure channels are set into memory. • Cable TV company is scrambling signal. • Check antenna orientation. 	17 20 – 14
No Cable TV reception.	<ul style="list-style-type: none"> • Check all Cable TV connections. • Set TV/CABLE menu option to the "CABLE" mode. • Station or Cable TV system problems, try another station. 	15 19 17
Horizontal or diagonal bars on screen.	<ul style="list-style-type: none"> • Check antenna connections, reorient antenna. • Check for sources of possible interference. 	14 64
No reception above channel 13.	<ul style="list-style-type: none"> • Make sure TV/CABLE menu option is in the appropriate mode. • If using antenna, check UHF antenna connections. 	19 14
TV shuts off.	<ul style="list-style-type: none"> • No broadcast on station tuned. • Sleep Timer is set. • Power interrupted. 	17 18 –
Closed - Caption is not activated.	<ul style="list-style-type: none"> • TV station experiencing problems or program tuned is not closed captioned. Try another channel. • Check Cable TV connection or VHF/UHF antenna, reposition or rotate antenna. • Set Closed Caption decoder in the menu. 	17 14,15 32
Display is not shown in your language.	<ul style="list-style-type: none"> • Select proper language in the menu options. 	16
Digital broadcasting screen problem.	<ul style="list-style-type: none"> • Check digital signal strength. 	37

- The LCD panel is a very high technology product, giving you fine picture details. Occasionally, a few non-active pixels may appear on the screen as a fixed point of blue, green or red. Please note that this does not affect the performance of your product.

SYMPTOMS	POSSIBLE SOLUTIONS	PAGE
DVD		
Playback doesn't start.	<ul style="list-style-type: none"> • No disc is inserted. • The disc may be dirty. Clean up the disc. • The unit cannot play CD-ROMs, etc. 	41 9 9
No picture.	<ul style="list-style-type: none"> • TV/DVD selector is not set correctly. 	40
No sound.	<ul style="list-style-type: none"> • Check the input selector of the amplifier is set properly. • The unit is in the Special playback mode. • Select the correct Audio Output position on AV amplifier. 	– 42 62
Picture is distorted during CUE or REVIEW.	<ul style="list-style-type: none"> • The picture will be distorted occasionally. 	–
Stopping playback, search, slow-motion play, repeat play, or program play, etc. cannot be performed.	<ul style="list-style-type: none"> • Some discs may not allow some functions. 	–
No 4:3 (16:9) picture.	<ul style="list-style-type: none"> • The setup does not match your TV. 	26,27,54
No on-screen display.	<ul style="list-style-type: none"> • Select Display On. 	54
No surround sound.	<ul style="list-style-type: none"> • The setup does not match your stereo system. 	62
The unit or remote operation key is not functioning.	<ul style="list-style-type: none"> • Turn off the unit and unplug the AC power cord for several minutes, then replug it. 	16
Playback does not start when the title is selected.	<ul style="list-style-type: none"> • Check the RATING LEVEL setup. 	57,58
Audio soundtrack and/or subtitle language is not changed when you play back a DVD.	<ul style="list-style-type: none"> • Multilingual language is not recorded on the DVD disc. 	51
No subtitle.	<ul style="list-style-type: none"> • Some discs have no subtitles. • Subtitles are cleared. Press SUBTITLE. 	51
Angle cannot be changed.	<ul style="list-style-type: none"> • Multi-angles are not recorded on the DVD disc. 	52
"X" appears on the screen.	<ul style="list-style-type: none"> • The function is prohibited with the unit or the disc. 	41
REMOTE CONTROL		
The remote control does not function.	<ul style="list-style-type: none"> • Aim at the remote control at the remote sensor. • Operate within Approx. 5 Meters or reduce the light in the room. • Clear the path of the beam. • The batteries are weak. Replace the batteries. • Check the batteries are inserted correctly. 	13



FOR CUSTOMER SERVICE, ADDITIONAL SET-UP AND OPERATING ASSISTANCE, OR TO ORDER ACCESSORIES PLEASE CALL:

1-800-289-0980

WHEN CALLING CUSTOMER SERVICE – PLEASE HAVE YOUR MODEL NUMBER READY

OR WRITE TO:
ORION SALES, INC.
 3471 N. UNION DR.
 OLNEY, ILLINOIS 62450

FOR INFORMATION ON OUR OTHER PRODUCTS, OR TO ORDER ACCESSORIES ONLINE, PLEASE VISIT OUR WEBSITE AT
www.orionsalesinc.com

Specifications

GENERAL

Power supply:	AC 120V 60Hz
Power consumption:	Operation: 130W Stand by: 1W
Weight:	12.7 kg (28.0 lbs)
Dimensions:	Width : 633 mm (24-15/16 inches) Height : 495 mm (19-1/2 inches) Depth : 211 mm (8-5/16 inches)
Operating temperature:	5°C - 40°C
Operating humidity:	Less than 80%

TELEVISION

Type:	26.01 inches (660.5 mm diagonal)
Display method:	Transmission TFT color LCD panel
Number of Pixels:	1366 (H) x 768 (V)
Viewing angle:	Left/Right: 80/80 degree Up/Down: 80/80 degree
Tuner type:	NTSC standard ATSC standard (8VSB), QAM
Receiving channels:	VHF 2-13 UHF 14-69 CATV 14-36 (A)-(W) 37-59 (AA)-(WW) 60-85 (AAA)-(ZZZ) 86-94 (86)-(94) 95-99 (A-5)-(A-1) 100-125 (100)-(125) 01 (5A)
Input:	S-Video: Y-Input: 1.0 V (p-p), 75 ohms C-Input: 0.3 V (p-p), 75 ohms Video: (RCA) 1 V p-p/75 ohms Audio: (RCA) -8 dBm/50K ohms
Digital audio out:	0.5 Vp-p 75 ohms terminated
Component video input:	(Y) 1 V (p-p), 75 ohms (Pb)/(Pr) 0.7 V (p-p), 75 ohms
HDMI input:	HDMI compliant (type A connector) HDCP compliant E-EDID compliant Suggested scan rates: 1080i, 480p, 480i, 720p HDMI Audio: 2-channel PCM 32/44.1/48 kHz sampling frequency 16/20/24 bits per sample
PC Monitor input:	Mini-Dsub 15pin x 1
Antenna input:	VHF/UHF In 75 ohms coaxial
Speaker:	41 mm x 122 mm (1-5/8 inches x 4-13/16 inches), 4 ohms x 2
Audio output power:	5.0W + 5.0W
DVD/CD player	
Signal system:	NTSC
Applicable disc:	1. DVD (12 cm, 8 cm) 2. CD (12 cm, 8 cm)
Pickup:	CD: Wavelength: 790 nm Maximum output power: 7 mW DVD: Wavelength: 655 nm Maximum output power: 5 mW
ACCESSORIES:	Remote control Batteries (UM-4) x 2 AC Cord

Designs and specifications are subject to change without notice.

SANSUI® *limited* **WARRANTY**

LCD TV WITH DVD PLAYER

ORION warrants this product to be free from manufacturing defects in material and workmanship under normal use and conditions for a period of 1 year from date of original purchase in the United States.

Should service be necessary under this warranty for any reason due to a manufacturing defect or malfunction during the first 12 months from date of original purchase, ORION will provide carry-in service by an ORION authorized Independent Service Center at no charge. Also, if an original part fails due to manufacturing defect in material and workmanship within one year from date of original purchase we will replace the defective part, provided the defect or malfunction is verified along with dated proof of purchase.

There are ORION authorized Independent Service Centers located throughout the country. For the one nearest you, DIAL TOLL FREE: 1-800-289-0980 or visit our website at www.orionsalesinc.com. This product is eligible for CARRY-IN service only. ORION will not be liable for damages incurred in shipment of the unit. If there are no ORION authorized Independent Service Centers in your area please call - 1-888-296-7466 for assistance.

Note: This warranty is void if the product is:

- (a) Damaged through negligence, misuse, abuse, or accident.
- (b) Used in a commercial application or rentals.
- (c) Modified or repaired by anyone other than an Independent Service Center authorized by ORION to effect warranty repairs to the class of product or by the ORION Factory Service Center.
- (d) Damaged because it is improperly connected to the equipment of other manufacturers.

This warranty does not cover:

- (a) Damage to video disc.
- (b) Damage to equipment not properly connected to the product.
- (c) Costs incurred in the shipping of the product to an ORION authorized Independent Service Center or ORION Factory Service Center.
- (d) Damage or improper operation of unit caused by customer abuse, misuse, negligence, or failure to follow operating instructions provided with the product.
- (e) Ordinary adjustments to the product which can be performed by customer as outlined in the owner's manual.
- (f) Signal reception problems caused by external antenna or cable systems.

THIS WARRANTY IS NON TRANSFERABLE AND APPLIES ONLY TO THE ORIGINAL PURCHASER AND DOES NOT EXTEND TO SUBSEQUENT OWNERS OF THE PRODUCT. ANY APPLICABLE IMPLIED WARRANTIES, INCLUDING THE WARRANTY OF MERCHANTABILITY, ARE LIMITED IN DURATION TO A PERIOD OF THE EXPRESS WARRANTY AS PROVIDED HEREIN BEGINNING WITH THE DATE OF ORIGINAL PURCHASE AT RETAIL AND NO WARRANTIES, WHETHER EXPRESS OR IMPLIED SHALL APPLY TO THIS PRODUCT THEREAFTER. ORION MAKES NO WARRANTY AS TO THE FITNESS OF THE PRODUCT FOR ANY PARTICULAR PURPOSE AND USE.

UNDER NO CIRCUMSTANCES SHALL ORION BE LIABLE FOR ANY LOSS, DIRECT, INDIRECT, INCIDENTAL, SPECIAL, OR CONSEQUENTIAL DAMAGE ARISING OUT OF OR IN CONNECTION WITH THE USE OF THIS PRODUCT.

THIS WARRANTY IS VALID ONLY IN THE UNITED STATES OF AMERICA. THIS WARRANTY GIVES YOU SPECIFIC LEGAL RIGHTS, HOWEVER, YOU MAY HAVE OTHER RIGHTS WHICH MAY VARY FROM STATE TO STATE. SOME STATES DO NOT ALLOW LIMITATION ON IMPLIED WARRANTIES OR EXCLUSION OF CONSEQUENTIAL DAMAGE, THEREFORE THESE RESTRICTIONS MAY NOT APPLY TO YOU.

ORION SALES, INC.
3471 N. UNION DR.
OLNEY, ILLINOIS 62450