

Electric Front Load Dryers

EWMED65H TS, EWMED65H SS, EWMED65H IW

Wave-Touch™ Electronic Controls Featuring Perfect Steam™

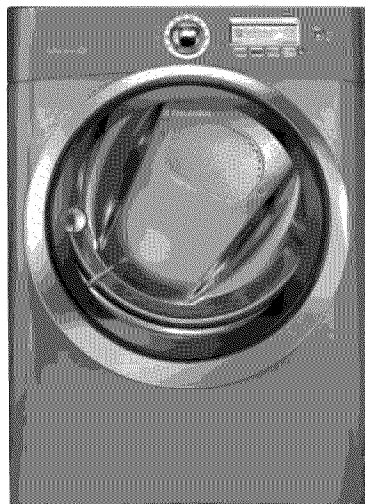

Turquoise Sky
EWMED65H TS



Silver Sands
EWMED65H SS



Island White
EWMED65H IW

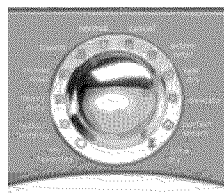

Wave-Touch™ Controls

Endless options for perfect results. More custom cycles than any other dryer,¹ including three “My Favorite” settings. Fastest dry time.²

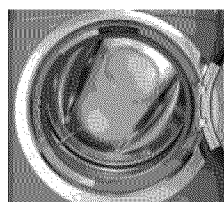

Largest Capacity Dryer³

Dry the most in one load with our 8.0 cubic foot dryer.

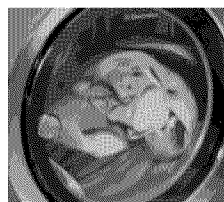

Perfect Tumble™ Dry System

Our technology gently removes wrinkles and freshens clothes.

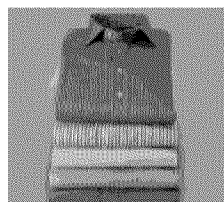

Perfect Steam™ Dry System

The latest technology removes wrinkles and freshens clothes. Exclusive “Add Steam” option is the ideal finish for your clothes and even helps eliminate static electricity.

27" ELECTRIC FRONT LOAD DRYERS

Capacity IEC	8.0 Cu. Ft.
NSF® Certified	Yes

Features

Signature Soft-Arc Door Design	Yes
Wave-Touch™ Electronic Controls with LCD Display	Yes
Perfect Steam™ Dry System	Yes
Perfect Tumble™ Dry System	Yes
Luxury-Quiet™ Sound Package	Yes
Luxury-Design™ Lighting	Yes
Luxury-Dry™ System	Yes
Touch-2-Open™/(Close) Door	Yes
Exact Dry™ Moisture Sensor	Yes
Stainless Steel Dryer Drum	Yes
Tumble Speed (RPM)	50
Reversible Door	Yes
Adjustable Leveling Legs	Yes

Cycles

Fast Dry, My Favorites (3), Heavy Duty, Bulky/Bedding, Mixed Load, Towels, Normal, Active Wear, Casual, Delicate, Perfect Steam™, Timed Dry	14
Individual Custom Options (3) - Additional user settings, each with 11 cycles and 3 My Favorites (14)	42
Total Cycles Available	56

Options

Temperature Selections	7
Electronic Auto Dry System	Yes
Manual Timed Dry Selections	6
End-of-Cycle Chime	Adjustable

Installation Options

Freestanding	Yes
Under Counter*	Yes
Stacked (Above Washer)	Yes
Pedestal	Yes
Hidden (In Closet)	Yes
Second Floor	Yes

Accessories

Luxury-Glide™ Touch-2-Open™/(Close) Pedestal - Turquoise Sky (EPWD15TS), Silver Sands (EPWD15SS), Island White (EPWD15IW)	Optional
Dryer Stacking Kit - (134700400)	Included
Mobile Home Installation Kit - (137067200)	Optional
Drying Rack - (134912700)	Included

Specifications

Color -	
Turquoise Sky	TS
Silver Sands	SS
Island White	IW
Overall Exterior Dimensions -	
Height (Without 15" Pedestal)	38"
Height (With 15" Pedestal)	53"
Width	27"
Depth (to Center of Arc Including Door and Exhaust) (with 90° Door Open)	31-1/2" 50-5/8"
Power Supply Connection Location	Bottom Right Rear
Voltage Rating	240V/60Hz/30A
Connected Load (kW Rating) @ 240 Volts	6.48
Amps @ 240 Volts	27
Heating Element @ 240 Volts (Watts)	5500
Shipping Weight	140 Lbs.

*Side-by-Side units in under-counter installation require custom-built countertop and/or cabinetry.

NOTE: Always consult local and/or national electric codes. Refer to Product Installation Guide for detailed installation instructions on the web at electroluxappliances.com.

Specifications subject to change.

¹Based on manufacturer specifications.

²Fastest time based on smallest load/ Fast Dry cycle selected for various load compositions.

³Based on manufacturer specifications.

⁴Lowest cloth temperature on 8 lb. permanent press load.



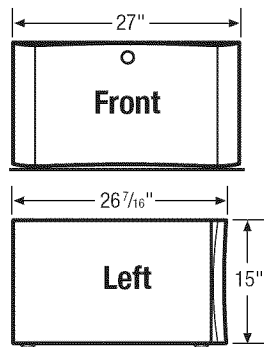
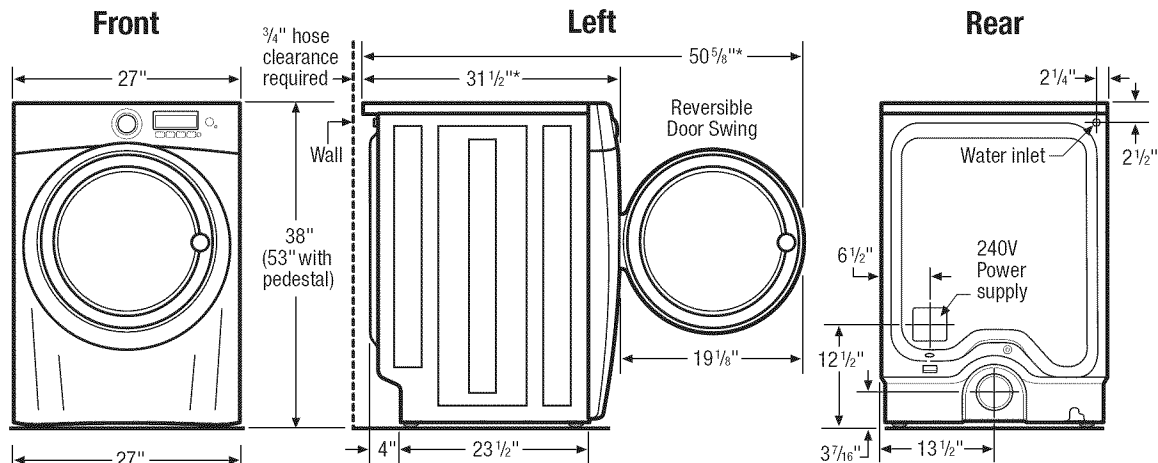

15" Drawer Pedestal Installation

Elevates dryer height to 53". For detailed pedestal installation, refer to instructions included with pedestal or on web. **Note:** Pedestal Installation requires modified utility hookup locations. For details, refer to Product Installation Guide on web.

Built-In Installations

For built-in installations, 3/4" steam hose clearance required at back of dryer, NO minimum clearance required around sides of units. For closet installation, allow 1" clearance between fronts of units and door. Location of plumbing, exhaust and utility hookups MUST be considered in built-in installations. For additional installation details, refer to Product Installation Guides on web.

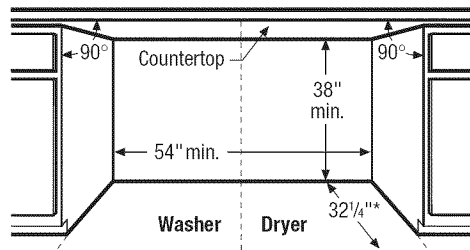

Side-by-Side Units in Under-Counter Installation

Requires custom-built countertop and/or cabinetry.

* To achieve minimal depth dimensions or clearances, dryer MUST be vented straight back or with quick-turn 90° elbow.

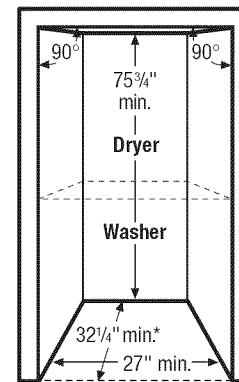

Stacked Units in Recessed or Closet Installation

For detailed stacked installation, refer to instructions included with Stacking Kit or on web. **Note:** Stacked installation requires modified utility hookup locations for dryer. For details, refer to Product Installation Guide on web.

Electric Dryer Specifications

- Product Weight – 130 Lbs.
- Voltage Rating – 240V/60Hz/30 Amps
- Single phase 3- or 4-wire cable, 240 Volt, 60 Hertz AC only electrical supply with ground required on separate circuit fused on both sides of line. (Do not use same circuit as washer.)
- Connected Load (kW Rating) @ 240 Volts = 6.48kW
- Amps @ 240 Volts = 27 Amps
- Dryer MUST employ a 3-conductor NEMA 10-30 type SRDT or 4-conductor NEMA 14-30 type SRDT or ST (as required), rated at 240 volt AC minimum, 30 amp power supply cord marked for use with clothes dryers (not supplied).
- Grounding through neutral link prohibited in specific applications and certain locales, requiring use of 4-wire system. (For detailed electrical requirements, refer to Product Installation Guide on web.)
- Always consult local and/or national electric codes.
- Can be installed alone, with or without optional 15" drawer pedestal, or stacked above matching Electrolux Washer, which requires stacking kit included with dryer. (For installation details, refer to instructions included with optional pedestal or stacking kit or on web.)
- Can be built in with matching Electrolux Washer in under-counter, recessed or closet installation. Installations requiring countertop and/or cabinetry will require custom building. (Refer to Built-In Installations on this page for cutout dimensions. For additional installation details, refer to Product Installation Guide on web.)

- Closet installation requires vented door with 2 unobstructed louvered openings, minimum 60 sq. in. each, located 3" from top and bottom of door. Full-length 120 sq. in. opening also acceptable. Allow 1" clearance between door and fronts of units.
- Do NOT install in area exposed to dripping water or outdoor weather conditions, or where gasoline or other flammables, including automobiles, are kept or stored.
- Floor MUST be solid with 1" maximum slope. To ensure vibration or movement does not occur, reinforcement of floor may be necessary. Do NOT install on carpeted surface.
- Dryer MUST exhaust to outside of building, NOT into any concealed space.
- Exhaust installation requires minimum 4"-diameter rigid or flexible metal duct with approved vent hood having swing-out damper(s). Do NOT use flexible plastic or metal foil duct and use shortest run possible.
- Leveling legs supplied to level dryer properly and reduce excessive noise and vibration.
- Water inlet hose for steam setting connects to cold water supply with "Y" connector and requires 3/4" clearance between back of unit and wall.

Note: For planning purposes only. Refer to Product Installation Guide on the web at electroluxappliances.com for detailed instructions.

Optional Accessories

- Drawer Pedestals – Turquoise Sky (EPWD15TS), Silver Sands (EPWD15SS), Island White (EPWD15IW).
- Mobile Home Installation Kit – (137067200).



Electrolux Major Appliances, N.A.

USA • 250 Bobby Jones Expressway • Augusta, GA 30907 • 1-877-4electrolux (1-877-435-3287) • electroluxappliances.com
 CANADA • 5855 Terry Fox Way • Mississauga, ON L5V 3E4 • 1-800-265-8352 • electroluxappliances.ca