

Owner's Manual



POWER MISER™ 9 GAS WATER HEATER

FOR POTABLE WATER HEATING ONLY.
NOT SUITABLE FOR SPACE HEATING.
NOT FOR USE IN MOBILE HOMES.

MODEL NO.

153.339270 40 Gallon Short
153.339492 40 Gallon Tall
153.339530 50 Gallon Tall

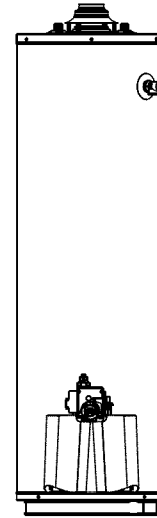

- Safety Instructions
- Installation
- Operation
- Care and Maintenance
- Troubleshooting
- Parts List



For Your Safety

AN ODORANT IS ADDED TO THE GAS USED BY THIS WATER HEATER.

This water heater complies with ANSI Z21.10.1-current edition regarding the accidental or unintended ignition of flammable vapors, such as those emitted by gasoline.



⚠ WARNING

Read and understand instruction manual and safety messages before installing, operating or servicing this water heater.

Failure to follow instructions and safety messages could result in death or serious injury.

Instruction manual must remain with water heater.

ADVERTENCIA

Si no puede leer o entender el inglés y necesita el manual de instrucciones en español, puede solicitarlo al 1-800-821-2017. NO TRATE DE INSTALAR U OPERAR ESTE CALENTADOR DE AGUA SI NO ENTIENDE LAS INSTRUCCIONES. No hacer caso de esta advertencia podría originar lesiones graves o mortales.

WARNING: If the information in these instructions is not followed exactly, a fire or explosion may result causing property damage, personal injury or death.





- Do not store or use gasoline or other flammable vapors and liquids in the vicinity of this or any other appliance.
- **WHAT TO DO IF YOU SMELL GAS:**
 - Do not try to light any appliance.
 - Do not touch any electrical switch; do not use any phone in your building.
 - Immediately call your gas supplier from a neighbor's phone. Follow the gas supplier's instructions.
 - If you cannot reach your gas supplier, call the fire department.
- Installation and service must be performed by a qualified installer, service agency or the gas supplier.

Sears, Roebuck and Co., Hoffman Estates, IL 60179 U.S.A

SAFE INSTALLATION, USE AND SERVICE

Your safety and the safety of others is extremely important in the installation, use and servicing of this water heater.

Many safety-related messages and instructions have been provided in this manual and on your own water heater to warn you and others of a potential injury hazard. Read and obey all safety messages and instructions throughout this manual. It is very important that the meaning of each safety message is understood by you and others who install, use or service this water heater.

	This is the safety alert symbol. It is used to alert you to potential personal injury hazards. Obey all safety messages that follow this symbol to avoid possible injury or death.
	DANGER indicates an imminently hazardous situation which, if not avoided, could result in death or injury.
	WARNING indicates a potentially hazardous situation which, if not avoided, could result in death or injury.
	CAUTION indicates a potentially hazardous situation which, if not avoided, may result in minor or moderate injury.
	CAUTION used without the safety alert symbol indicates a potentially hazardous situation which, if not avoided, could result in property damage.

All safety messages will generally tell you about the type of hazard, what can happen if you do not follow the safety message and how to avoid the risk of injury.

The California Safe Drinking Water and Toxic Enforcement Act requires the Governor of California to publish a list of substances known to the State of California to cause cancer, birth defects, or other reproductive harm, and requires businesses to warn of potential exposure to such substances. **WARNING:** This product contains a chemical known to the State of California to cause cancer, birth defects, or other reproductive harm. This appliance can cause low-level exposure to some of the substances included in the Act.

IMPORTANT DEFINITIONS

- **Qualified Technician:** A qualified technician must have ability equivalent to a licensed tradesman in the fields of plumbing, air supply, venting, and gas supply, including a thorough understanding of the requirements of the National Fuel Gas Code as it relates to the installation of gas fired water heaters. The qualified technician must also be familiar with the design features and use of flammable vapor ignition resistant water heaters, and have a thorough understanding of this instruction manual.
- **Service Agency:** A service agency also must have ability equivalent to a licensed tradesman in the fields of plumbing, air supply, venting and gas supply, including a thorough understanding of the requirements of the National Fuel Gas Code as it relates to the installation of gas fired water heaters. The service agency must also have a thorough understanding of this instruction manual, and be able to perform repairs strictly in accordance with the service guidelines provided by the manufacturer.
- **Gas Supplier:** The natural gas or propane utility or service who supplies gas for utilization by the gas burning appliances within this application. The gas supplier typically has responsibility for the inspection and code approval of gas piping up to and including the natural gas meter or propane storage tank of a building. Many gas suppliers also offer service and inspection of appliances within the building.

SAFETY PRECAUTIONS

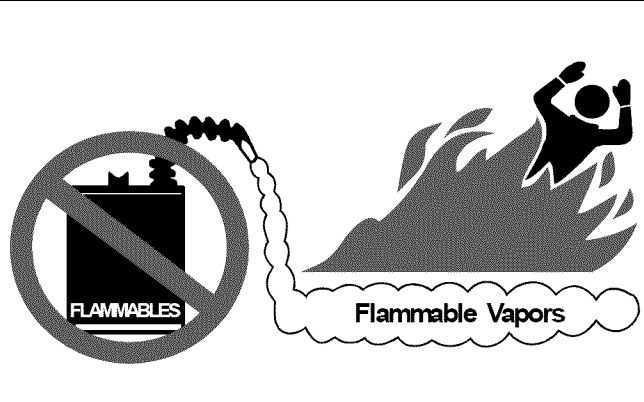
	<h3 style="text-align: center;">⚠️ WARNING</h3> <p style="text-align: center;">FIRE AND EXPLOSION HAZARD Can result in serious injury or death</p> <p>⚠️ Do not store or use gasoline or other flammable vapors and liquids in the vicinity of this or any other appliance. Storage of or use of gasoline or other flammable vapors or liquids in the vicinity of this or any other appliance can result in serious injury or death.</p>
<p>Read and follow water heater warnings and instructions.</p>	



⚠ WARNING

Read and understand instruction manual and safety messages before installing, operating or servicing this water heater.

Failure to follow instructions and safety messages could result in death or serious injury.

Instruction manual must remain with water heater.



⚠ WARNING

Fire Hazard

For continued protection against risk of fire:

- Do not install water heater on carpeted floor.
- Do not operate water heater if flood damaged.

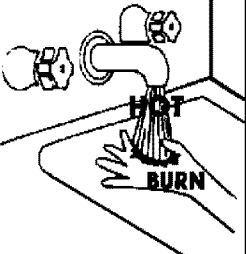

⚠ DANGER

Water temperature over 125°F (52°C) can cause severe burns instantly resulting in severe injury or death.

Children, the elderly, and the physically or mentally disabled are at highest risk for scald injury.

Feel water before bathing or showering.

Temperature limiting valves are available.

Read instruction manual for safe temperature setting.

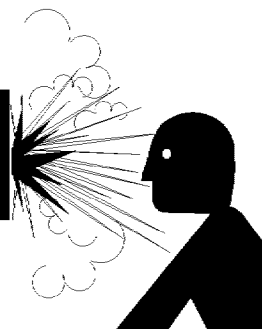

⚠ WARNING

Explosion Hazard



- Overheated water can cause watertank explosion.
- Properly sized temperature and pressure relief valve must be installed in opening provided.

⚠ WARNING

Fire or Explosion Hazard

- Do not store or use gasoline or other flammable vapors and liquids in the vicinity of this or any other appliance.
- Avoid all ignition sources if you smell Natural or LP gas.
- Do not expose water heater control to excessive gas pressure.
- Use only gas shown on rating plate.
- Maintain required clearances to combustibles.
- Keep ignition sources away from faucets after extended period of non-use.

Read instruction manual before installing, using or servicing water heater.

⚠ WARNING

Breathing Hazard - Carbon Monoxide Gas

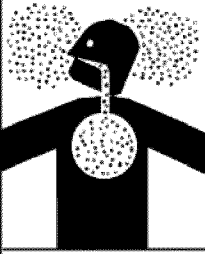

- Install vent system in accordance with codes.
- Do not operate water heater if flood damaged.
- High altitude orifice must be installed for operation above 7,700 feet (2,347m).
- Do not operate if soot is present.
- Do not obstruct water heater air intake with insulating jacket.
- Do not place chemical vapor emitting products near water heater.
- Gas and carbon monoxide detectors are available.

Breathing carbon monoxide can cause brain damage or death. Always read and understand instruction manual.

CAUTION

Improper installation and use may result in property damage.

- Do not operate water heater if flood damaged.
- Inspect and replace anode.
- Install in location with drainage.
- Fill tank with water before operation.
- Be alert for thermal expansion.

Refer to instruction manual for installation and service.

TABLE OF CONTENTS

SAFE INSTALLATION, USE AND SERVICE	2
SAFETY PRECAUTIONS	2-3
PRODUCT WARRANTY	6
CUSTOMER RESPONSIBILITIES	7
PRODUCT SPECIFICATIONS	8
MATERIALS AND BASIC TOOLS NEEDED	9
TYPICAL INSTALLATION	10
IMPORTANT INFORMATION ABOUT THIS WATER HEATER	11
Installation Checklist	11
INSTALLATION INSTRUCTIONS	12-15
Removing the Old Water Heater	12
Location Requirements	13
Site Location	13
Insulation Blankets	14
Clearances and Accessibility	14-15
Filling the Water Heater	15
GAS SUPPLY	15-16
Gas Requirements	15
Gas Piping	15
Gas Pressure	16
Gas Pressure Testing	16
LP Gas Only	16
COMBUSTION AIR SUPPLY & VENTILATION	17-20
Unconfined Space	17
Confined Space	17
All Air from Inside the Building	17-18
All Air from Outdoors	18
Louvers and Grilles	18-19
Vent Pipe System	19
Draft Hood Installation	19
Vent Pipe Size	19
Vent Connectors	19-20
Chimney Connection	20
Vertical Exhaust Gas Vent	20
WATER SYSTEM PIPING	21-22
Piping Installation	21
Closed System/Thermal Expansion	22
Temperature and Pressure Relief Valve	22
T&P Relief Valve and Pipe Insulation	22

OPERATING YOUR WATER HEATER	23-25
Lighting Instructions	23
Checking the Draft	24
Burner Flames	24
Emergency Shut Down	24
Water Temperature Regulation	24-25
SERVICE AND ADJUSTMENT	26-28
Tank (Sediment) Cleaning	26
Vent System Inspection	26
Burner Inspection	26
Burner Cleaning	26
Housekeeping	27
Anode Rod Inspection	27
Temperature-Pressure Relief Valve Operation	27
Draining and Flushing	27-28
Service	28
MAINTENANCE OF YOUR WATER HEATER.....	29-32
Replacement Parts	29
External Inspection & Cleaning of the Base-Ring Filter	29
Removing the Manifold/Burner Assembly	29
Removing the Burner from the Manifold/Burner Assembly	29
Replacing the Thermocouple	29-30
Replacing the Pilot/ Pilot Tube Assembly	30
Cleaning the Combustion Chamber and Flame-arrestor	30
Replacing the Manifold/Burner Assembly	31
Piezoelectric Igniter System	31
Testing the Igniter System	32
Removing and Replacing the Gas Control Valve/Thermostat	32
FVIR System Operational Checklist	32
TROUBLESHOOTING GUIDE	33-35
Start Up Conditions	33-34
Operational Conditions	34-35
TROUBLESHOOTING CHART	36-37
PILOT LIGHT TROUBLESHOOTING FLOWCHART	38
PARTS ORDER LIST	39

PRODUCT WARRANTY

9 - YEAR LIMITED WARRANTY ON WATER HEATER

For nine years from the date of purchase, if this water heater is installed and operated in a single-family home in accordance with the owner's manual instructions and all local applicable plumbing codes, Sears will:

1. Supply free water heater parts for those that are defective in material or workmanship.
2. Supply a free water heater for one that develops a leak.

For the second through the ninth year from the purchase date, you must pay the labor cost for installation of parts or water heater.

For commercial, institutional, industrial or residential use by two or more families, the above limited warranty is only for two years. During the second year you must pay the labor cost for parts or water heater installation.

1 - YEAR EXCLUSIVE KENMORE LABOR WARRANTY

For the first year from the date of purchase, Sears will, free of charge, supply and install new water heater parts for defective ones or a new water heater for one that develops a leak.

WARRANTY SERVICE

To obtain warranty service, call 1-800-4-MY-HOME® (1-800-469-4663).

This warranty applies only while this product is in use in the United States.

This warranty gives you specific legal rights, and you may also have other rights which vary from state to state.

SEARS, ROEBUCK AND CO., Dept.817WA, Hoffman Estates, IL 60179

The price of your water heater does not include a free checkup service call. On water heater installations arranged by Sears, Sears warrants the installation.

A charge will be made on service calls due to poor or incomplete installation. These include:

- a. Adjusting thermostat
- b. Condensation
- c. Leaks in pipes or fittings

Master Protection Agreements

Congratulations on making a smart purchase. Your new Kenmore® product is designed and manufactured for years of dependable operation. But like all products, it may require preventive maintenance or repair from time to time. That's when having a Master Protection Agreement can save you money and aggravation.

The Master Protection Agreement also helps extend the life of your new product. Here's what the Agreement* includes:

- **Parts and labor** needed to help keep products operating properly **under normal use**, not just defects. Our coverage goes **well beyond the product warranty**. No deductibles, no functional failure excluded from coverage— **real protection**.
- **Expert service** by a force of more than **10,000 authorized Sears service technicians**, which means someone you can trust will be working on your product.
- **Unlimited service calls and nationwide service**, as often as you want us, whenever you want us.
- **"No-lemon"** guarantee – replacement of your covered product if four or more product failures occur within twelve months.
- **Product replacement** if your covered product can't be fixed.
- **Annual Preventive Maintenance Check** at your request – no extra charge.
- **Fast help by phone** – we call it **Rapid Resolution** – phone support from a Sears representative on all products. Think of us as a "talking owner's manual."
- **Power surge protection** against electrical damage due to power fluctuations.

- **\$250 Food Loss Protection** annually for any food spoilage that is the result of mechanical failure of any covered refrigerator or freezer.
- **Rental reimbursement** if repair of your covered product takes longer than promised.
- **10% discount** off the regular price of any non-covered repair service and related installed parts.

Once you purchase the Agreement, a simple phone call is all that it takes for you to schedule service. You can call anytime day or night, or schedule a service appointment online.

The Master Protection Agreement is a risk free purchase. If you cancel for any reason during the product warranty period, we will provide a full refund. Or, a prorated refund anytime after the product warranty period expires. Purchase your Master Protection Agreement today!

Some limitations and exclusions apply. For prices and additional information in the U.S.A. call 1-800-827-6655.

*** Coverage in Canada varies on some items. For full details, call Sears Canada at 1-800-361-6665.**

Sears Installation Service

*For Sears professional installation of home appliances, garage door openers, water heaters, and other major home items, in the U.S.A. or Canada call **1-800-4-MY-HOME®**.*

CUSTOMER RESPONSIBILITIES

Thank You for purchasing a Kenmore water heater. Properly installed and maintained, it should give you years of trouble free service. If you should decide that you want the new water heater professionally installed by Sears call 1-800-4-MY-HOME®. They will arrange for prompt, quality installation by Sears authorized contractors.

Abbreviations Found In This Instruction Manual:

- CSA - Canadian Standards Association
- ANSI - American National Standards Institute
- NFPA - National Fire Protection Association
- ASME - American Society of Mechanical Engineers
- GAMA - Gas Appliance Manufacturers Association

Important Information About This Water Heater:

This gas water heater was manufactured to voluntary safety standards to reduce the likelihood of a flammable vapor ignition incident. New technology used in meeting these standards makes this product more sensitive to installation errors or improper installation environments. Please review the Installation Checklist found at the end of the installation instructions section and make any required installation upgrades or changes.

This manual contains instructions for the installation, operation, and maintenance of the gas-fired water heater. It also contains warnings throughout the manual that you must read and be aware of. All warnings and all instructions are essential to the proper operation of the water heater and your safety. Since we cannot put everything on the first few pages, **READ THE ENTIRE MANUAL BEFORE ATTEMPTING TO INSTALL OR OPERATE THE WATER HEATER.**

- The installation must conform with these instructions and the local code authority having jurisdiction. In the absence of local codes, installations shall comply with the following:

In the United States: The National Fuel Gas Code ANSI Z223.1/ NFPA 54. This publication is available from the Canadian Standards Association, 8501 East Pleasant Valley Rd, Cleveland Ohio 44131, or The National Fire Protection Association, 1 Batterymarch Park, Quincy, MA 02269.

- If after reading this manual you have any questions or do not understand any portion of the instructions, call the Sears Service Center.
- Carefully plan the place where you are going to put the water heater. Correct combustion, vent action, and vent pipe installation are very important in preventing death from possible carbon monoxide poisoning and fires. See Figure 1.
- Examine the location to ensure the water heater complies with the *Installation Instructions* section in this manual.
- For California installation, this water heater must be braced, anchored, or strapped to avoid falling or moving during an earthquake. See instructions for correct installation procedures. Instructions may be obtained from California's Office of the State Architect, 1102 Q Street, Suite 5100, Sacramento, CA 95811. Instructions can also be downloaded to your computer at www.dsa.dgs.ca.gov/Pubs.

- Massachusetts Code requires this water heater to be installed in accordance with Massachusetts 248-CMR 2.00: State Plumbing Code and 248-CMR 5.00.
- Complies with 40 Ng/J NOx requirements of Texas and most California AQM Districts.



IMPORTANT: Do not remove any permanent instructions, labels, or the data label from either the outside of the water heater or on the inside of water heater panels.

- Remove exterior packaging and place installation components aside.
- Inspect all parts for damage prior to installation and start-up.
- Completely read all instructions before attempting to assemble and install this product.
- After installation, dispose of/recycle all packaging materials.

PRODUCT SPECIFICATIONS

MODEL NUMBER	TANK CAPACITY IN GALS (LTRS)	TYPE OF GAS	INPUT RATE (Btu/hr)	RECOVERY RATE GALS. PER HOUR @ 90°F RISE	MINIMUM VENT PIPE DIA. INCHES (mm)	DIAMETER INCHES (mm)	DIMENSIONS INCHES (mm) HEIGHT TO JACKET TOP
153.339270	40 (151)	Natural	40,000	40.9	3 (76) OR 4 (102)	22 (559)	47.75 (1213)
153.339492	40 (151)	Natural	40,000	40.9	3 (76) OR 4 (102)	20 (508)	58.14 (1477)
153.339530	50 (189)	Natural	40,000	40.9	3 (76) OR 4 (102)	22 (559)	57.28 (1455)

MATERIALS AND BASIC TOOLS NEEDED

MATERIALS NEEDED

To simplify the installation Sears has available the installation parts shown below. You may or may not need all of these materials, depending on your type of installation.

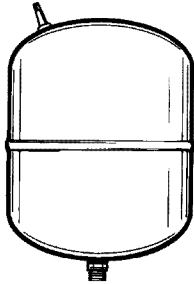

EXPANSION TANKS FOR THERMAL EXPANSION CONDITIONS AVAILABLE IN 2 GALLONS (7.6 LITERS) AND 5 GALLONS (18.9 LITERS) CAPACITY THROUGH LOCAL SEARS STORE OR SERVICE CENTER.

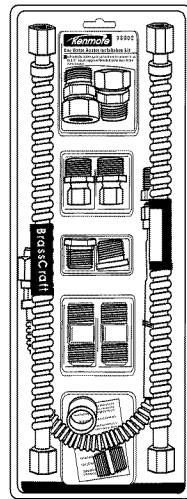

WATER HEATER INSTALLATION KIT WITH FLEXIBLE CONNECTORS FOR 3/4" (19.05 mm) OR 1/2" (12.7 mm) THREADED OR COPPER PLUMBING AND FLEXIBLE WATER HEATER GAS CONNECTOR WITH FITTINGS.

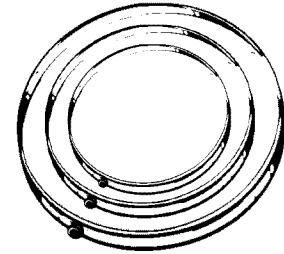

DRAIN PANS AVAILABLE IN 20" (508 mm) DIAMETER FOR WATER HEATERS HAVING A DIAMETER 18" (457 mm) OR LESS, 24" (610mm) DIAMETER FOR WATER HEATERS HAVING A DIAMETER 22" (559 mm) OR LESS AND AVAILABLE IN 28" (711 mm) DIAMETER FOR WATER HEATERS HAVING A DIAMETER 26" (660 mm) OR LESS.

BASIC TOOLS

You may or may not need all these tools, depending on your type of installation. These tools can be purchased at your local Sears Store.

- Pipe Wrenches (2) 14" (356 mm)
- Screwdriver
- Tin Snips
- 6' (1.82 m) Tape or Folding Ruler
- Garden Hose
- Drill
- Pipe Dope or Teflon Tape



SLOT-HEAD SCREWDRIVER



PHILLIPS SCREWDRIVER



ROLL OF TEFLON TAPE (USE ONLY ON WATER CONNECTIONS)



GARDEN HOSE

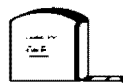

6 FOOT TAPE



TIN SNIPS



PIPE DOPE (SQUEEZE TUBE) USE FOR WATER AND GAS CONNECTIONS



PIPE WRENCH

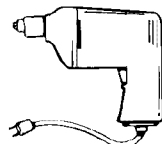

DRILL

ADDITIONAL TOOLS NEEDED WHEN SWEAT SOLDERING

- Tubing Cutters or Hacksaw
- Propane Tank
- Soft Solder
- Solder Flux
- Emery Cloth
- Wire Brushes



TUBING CUTTER



PROPANE TORCH

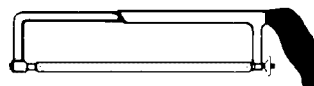

HACKSAW



ROLL OF EMERY CLOTH



3/4" (19 mm) WIRE BRUSH



1/2" (13 mm) WIRE BRUSH



ROLL OF LEAD-FREE SOFT SOLDER



SOLDER FLUX

TYPICAL INSTALLATION

GET TO KNOW YOUR WATER HEATER - GAS MODELS

- | | | |
|-----------------------------|-------------------------------------|-------------------------|
| A Vent Pipe | J Inner Door | S Thermostat |
| B Draft Hood | K Outer Door | T Drain Valve |
| C Anode (Not Shown) | L Union | U Pilot and Main Burner |
| D Hot Water Outlet | M Inlet Water Shut-off Valve | V Flue |
| E Insulation | N Cold Water Inlet | W Drain Pan |
| F Gas Supply Piping | O Inlet Dip Tube | X Piezo Igniter |
| G Manual Gas Shut-off Valve | P Temperature-Pressure Relief Valve | Y Base-Ring Filter |
| H Ground Joint Union | Q Rating Plate | |
| I Drip Leg (Sediment Trap) | R Flue Baffle | |

* INSTALL IN ACCORDANCE WITH LOCAL CODES.

* DRIP LEG AS REQUIRED BY LOCAL CODES.

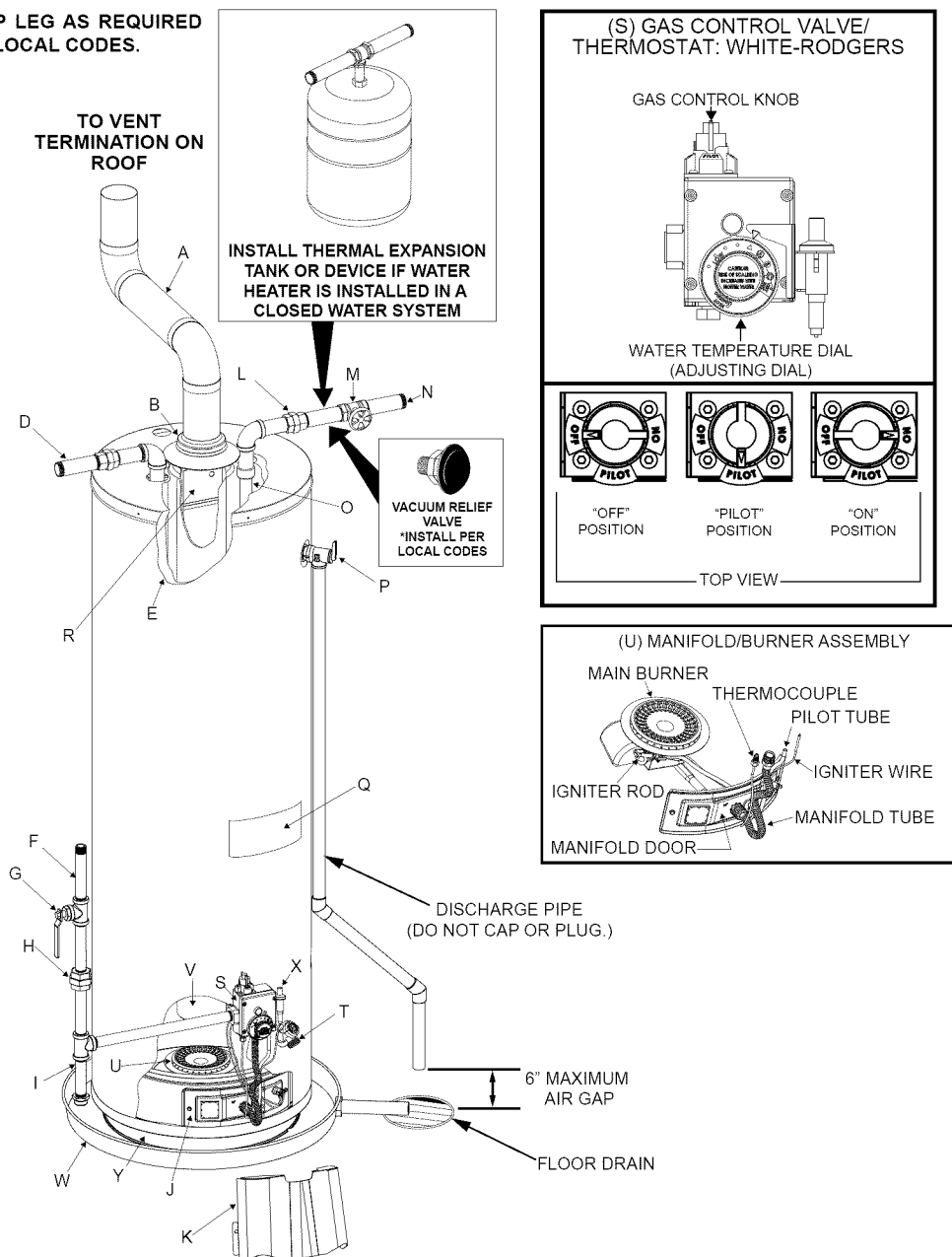

* ALL PIPING MATERIALS TO BE SUPPLIED BY CUSTOMERS.

FIGURE 1.

IMPORTANT INFORMATION ABOUT THIS WATER HEATER

This gas water heater was manufactured to voluntary safety standards to reduce the likelihood of a flammable vapor ignition incident. The new technology used in meeting these standards makes this product more sensitive to installation errors. Please review the following checklist and make any required installation upgrades or changes.

Questions? Contact Sears at 1-800-4-MY-HOME (1-800-469-4663).

Installation Checklist

Water Heater Location

Water heater location is important and can affect system performance. Please check the following:

- Installation area free of corrosive elements and flammable materials.
- Centrally located with the water piping system (For new installations). Located as close to the gas piping and vent pipe system as possible.
- Located indoors and in a vertical position. Protected from freezing temperatures.
- Proper clearances from combustible surfaces maintained and not installed directly on a carpeted floor.
- Provisions made to protect the area from water damage. Metal drain pan installed and piped to an adequate drain.
- Sufficient room to service the water heater. See Clearances and Accessibility section of this manual.
- Water heater not located near an air moving device.
- Is the installed environment dirty (excessive amounts of lint, dirt, dust, etc.)? If so, the base-ring filter located on the bottom of the water heater will need to be cleaned periodically. Refer to the "Maintenance of your Water Heater" section of this manual for information on cleaning the base-ring filter.

Combustion Air Supply and Ventilation

Check for sufficient combustion air supply. Insufficient air for the combustion of gas will result in the flame becoming "lazy", thereby allowing heat to build up in the combustion chamber. This excessive heat will cause a thermal switch on the door assembly to trip. Is the water heater installed in a closet or other small, enclosed space? If so:

- Are there openings for make-up air to enter and exit the room/area?
- Are the openings of sufficient size? Remember, if there are other gas-fired or air-consuming appliances in the same room, you need more make-up air. Refer to the "Installation Instructions" and "Combustion Air Supply and Ventilation" sections for specific requirements.
- Make sure that fresh air is not taken from areas that contain negative pressure producing devices such as exhaust fans, dryers, fireplaces, etc.
- Is there a furnace/air handler in the same room space as the water heater? If so, has a return air duct system been attached that exits the room? If so, check for leaks on the air duct system. If no air duct system is present, correct immediately by contacting a local Heating, Ventilation, Air-Conditioning & Refrigeration (HVAC-R) authorized service provider.
- Use a fresh air supply that is free of corrosive elements and flammable vapors.

- Fresh air openings must be sized correctly with consideration given to the blocking effect of louvers and grilles.
- Ductwork must be the same cross-sectional area as the openings.

Vent Pipe System

Check for proper drafting at the water heater draft hood. Refer to the "Checking the Draft" section of this manual for the test procedure. If the procedure shows insufficient draft is present, please check the following:

- Draft hood properly installed.
- Vent connectors securely fastened with screws and supported properly to maintain six inch clearance.
- Vent connector made of approved material and sized correctly.
- Vent pipe system installed according to all local and state codes or, in the absence of local and state codes, the "National Fuel Gas Code", ANSI Z223.1(NFPA 54)-current edition.
- Flue baffle properly positioned in the flue tube.
- Check the vent system for restrictions/obstructions and check the vent termination height. Refer to the "Combustion Air Supply and Ventilation" section of this water heater manual for specific requirements.
- Recheck for sufficient combustion air supply.

Water System Piping

- Temperature and pressure relief valve properly installed with a discharge line run to an open drain and protected from freezing.
- All piping properly installed and free of leaks.
- Heater completely filled with water.
- Closed system pressure build-up devices installed.
- Mixing valve (when applicable) installed per manufacturer's instructions (See "Water Temperature Regulation" section).

Gas Supply and Piping

- Gas type is the same as that listed on the water heater rating plate.
- Gas line equipped with shut-off valve, union, and drip leg.
- Use pipe joint compound or teflon tape marked as being resistant to the action of petroleum [Propane (L.P.)] gases.
- Adequate pipe size and approved pipe material.
- An approved noncorrosive leak detection solution used to check all connections and fittings for possible gas leaks. Correct any leak found.

INSTALLATION INSTRUCTIONS

Removing the Old Water Heater

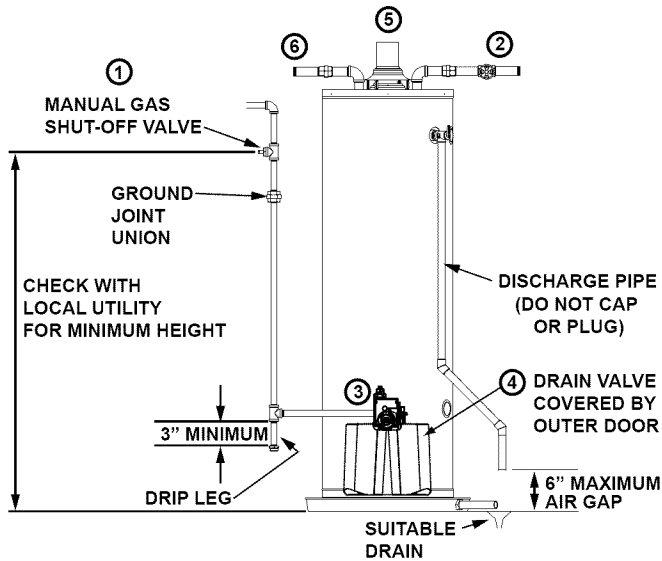

FIGURE 2.

- ① Turn "OFF" the gas supply to the water heater.

If the main gas line shutoff valve serving all gas appliances is used, also shut "OFF" the gas at each appliance. Leave all gas appliances shut "OFF" until the water heater installation is completed. See Figures 2 and 3.

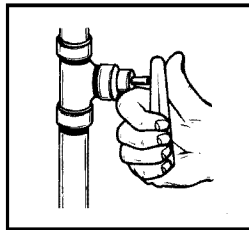

FIGURE 3.

- ② Turn "OFF" the water supply to the water heater at the water shut off valve or water meter. Some installations require that the water be turned off to the entire house. See Figures 2 and 4.

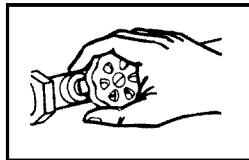

FIGURE 4.

- ③ Check again to make sure the gas supply is "OFF" to the water heater. Then disconnect the gas supply connection from the gas control valve.

⚠ DANGER

- Burn hazard
- Hot water discharge.
- Keep hands clear of drain valve discharge.

- ④ Attach a hose to the water heater drain valve and put the other end in a floor drain or outdoors. (See Figures 2 and 5.) Open the water heater drain valve. Open a nearby hot water faucet which will relieve pressure in the water heater and speed draining. The water passing out of the drain valve may be extremely hot. To avoid being scalded, make sure all connections are tight and that the water flow is directed away from any person.

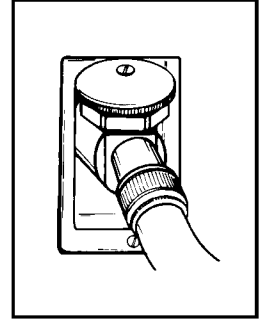

FIGURE 5.

- ⑤ Disconnect the vent pipe from the draft hood where it connects to the water heater. In most installations the vent pipe can be lifted off after any screw or other attached devices are removed. Dispose of the draft hood. The new water heater has a draft hood which must be used for proper operation.

- ⑥ If you have copper piping to the water heater, the two copper water pipes can be cut with a hacksaw approximately four inches away from where they connect to the water heater. See Figure 6. This will avoid cutting off pipes too short. Additional cuts can be made later if necessary. Disconnect the temperature-pressure relief valve drain line. When the water heater is drained, disconnect the hose from the drain valve. Close the drain valve. The water heater is now completely disconnected and ready to be removed.

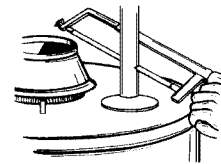

FIGURE 6.

If you have galvanized pipes to the water heater, loosen the two galvanized pipes with a pipe wrench at the union in each line. Also disconnect the piping remaining to the water heater. See Figure 7. These pieces should be saved since they may be needed when reconnecting the new water heater. Disconnect the temperature-pressure relief valve drain line. When the water heater is drained, disconnect the hose from the drain valve. Close the drain valve. The water heater is now completely disconnected and ready to be removed. Mineral buildup or sediment may have accumulated in the old water heater. This causes the water heater to be much heavier than normal and this residue, if spilled out, could cause staining.

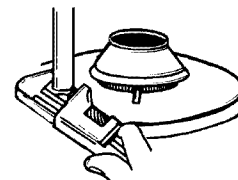
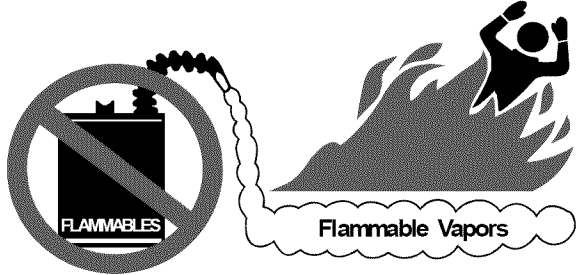

FIGURE 7.

Location Requirements

⚠ WARNING
Carbon Monoxide Poisoning Hazard
Do not install in a mobile home.
Doing so can result in carbon monoxide poisoning and death.

The FVIR System is designed to reduce the risk of flammable vapor-related fires. The patented system protects your family by trapping the burning vapors within the water heater combustion chamber through the special flame-arrestor. The burning vapors literally “burn themselves out” without escaping back into the room. In the event of a flammable vapor incident, the FVIR System disables the water heater by shutting off the gas supply to the water heater’s burner and pilot, preventing re-ignition of any remaining flammable vapors in the area. This will not prevent a possible fire/explosion if the igniter is depressed and flammable vapors have accumulated in the combustion chamber with the pilot light off. If you suspect a flammable vapor incident has occurred, do not use this appliance. Do not attempt to light this appliance, or depress the igniter button if you suspect flammable vapors have accumulated inside or outside the appliance. Immediately call a qualified technician to inspect the appliance. Water heaters subjected to a flammable vapors incident will show a discoloration on the flame-arrestor and require replacement of the entire water heater.

⚠ WARNING

FIRE AND EXPLOSION HAZARD Can result in serious injury or death
⚠ Do not store or use gasoline or other flammable vapors and liquids in the vicinity of this or any other appliance. Storage of or use of gasoline or other flammable vapors or liquids in the vicinity of this or any other appliance can result in serious injury or death.
Read and follow water heater warnings and instructions.

Do not use or store flammable products such as gasoline, solvents, or adhesives in the same room or area near the water heater. If such flammables must be used, all gas burning appliances in the vicinity must be shut off and their pilot lights extinguished. Open the doors and windows for ventilation while flammable substances are in use.

If flammable liquids or vapors have spilled or leaked in the

area of the water heater, leave the area immediately and call the fire department from a neighbor’s home. Do not attempt to clean the spill until all ignition sources have been extinguished.

⚠ WARNING
Fire or Explosion Hazard
<ul style="list-style-type: none">• Read instruction manual before installing, using or servicing water heater.• Improper use may result in fire or explosion.• Maintain required clearances to combustibles.

Keep combustibles such as boxes, magazines, clothes, etc. away from the water heater area.

Site Location

- Select a location near the center of the water piping system. The water heater must be installed indoors and in a vertical position on a level surface. DO NOT install in bathrooms, bedrooms, or any occupied room normally kept closed.
- Locate the water heater as close to the chimney or gas vent as practical. Consider the vent system piping and combustion air supply requirements when selecting the water heater location. The venting system must be able to run from the water heater to termination with minimal length and elbows.
- Locate the water heater near the existing gas piping. If installing a new gas line, locate the water heater to minimize the pipe length and elbows.
- The water heater should be located in an area not subject to freezing temperatures. Water heaters located in unconditioned spaces (i.e., attics, basements, etc.) may require insulation of the water piping and drain piping to protect against freezing. The drain and controls must be easily accessible for operation and service. Maintain proper clearances as specified on the rating plate.
- Do not locate the water heater near an air-moving device. The operation of air-moving devices such as exhaust fans, ventilation systems, clothes dryers, fireplaces, etc., can affect the proper operation of the water heater. Special attention must be given to conditions these devices may create. Flow reversal of flue gases may cause an increase of carbon monoxide inside of the dwelling (Figure 8).
- If the water heater is located in an area that is subjected to lint and dirt, it may be necessary to periodically clean the base-ring filter and flame-arrestor (see External Inspection & Cleaning of the Flame-arrestor).
- This water heater is **not** for use in manufactured (mobile) homes or outdoor installation.

NOTE: This water heater must be installed according to all local and state codes or, in the absence of local and state codes, the “National Fuel Gas Code”, ANSI Z223.1(NFPA 54)-current edition.

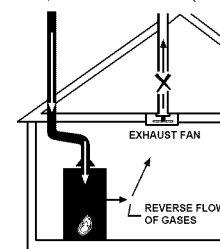

FIGURE 8

CAUTION

Property Damage Hazard

- All water heaters eventually leak
- Do not install without adequate drainage.

IMPORTANT: The water heater should be located in an area where leakage of the tank or connections will not result in damage to the area adjacent to the water heater or to lower floors of the structure. Due to the normal corrosive action of water, the tank will eventually leak after an extended period of time. Also any external plumbing leak, including those from improper installation, may cause early failure of the tank due to corrosion if not repaired. If the homeowner is uncomfortable with making the repair a qualified technician should be contacted. A suitable metal drain pan should be installed under the water heater as shown below, to help protect the property from damage which may occur from condensate formation or leaks in the piping connections or tank. The pan must limit the water level to a maximum depth of 1-3/4" and be two inches wider than the heater and piped to an adequate drain. NOTE: The pan must not restrict combustion air flow. Locate the water heater near a suitable indoor drain. Outside drains are subject to freezing temperatures which can obstruct the drain line. The piping should be at least 3/4" ID and pitched for proper drainage.

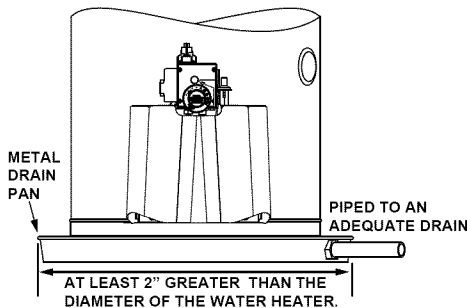

FIGURE 9.

Water heater life depends upon water quality, water usage, water temperature and the environment in which the water heater is installed. Water heaters are sometimes installed in locations where leakage may result in property damage, even with the use of a drain pan piped to a drain. However, unanticipated damage can be reduced or prevented by a leak detector or water shut-off device used in conjunction with a piped drain pan. These devices are available from some plumbing supply wholesalers and retailers, and detect and react to leakage in various ways:

- Sensors mounted in the drain pan that trigger an alarm or turn off the incoming water to the water heater when water is detected.
- Sensors mounted in the drain pan that turn off the water supply to the entire home when water is detected in the drain pan.
- Water supply shut-off devices that activate based on the water pressure differential between the cold water and hot water pipes connected to the water heater.
- Devices that will turn off the gas supply to a gas water heater while at the same time shutting off its water supply.

Insulation Blankets

Insulation blankets available to the general public for external

use on gas water heaters are not necessary with Kenmore products. The purpose of an insulation blanket is to reduce the standby heat loss encountered with storage tank heaters. Your Kenmore water heater meets or exceeds the National Appliance Energy Conservation Act standards with respect to insulation and standby loss requirements, making an insulation blanket unnecessary.

WARNING

Breathing Hazard - Carbon Monoxide Gas

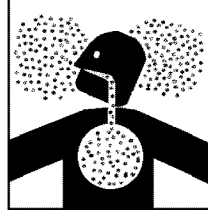

- Do not obstruct water heater air intake with insulating blanket.
- Gas and carbon monoxide detectors are available.
- Install water heater in accordance with the instruction manual.

Breathing carbon monoxide can cause brain damage or death. Always read and understand instruction manual.

WARNING

Should you choose to apply an insulation blanket to this heater, you should follow these instructions (See Figure 1 for identification of components mentioned below). Failure to follow these instructions can restrict the air flow required for proper combustion, potentially resulting in fire, asphyxiation, serious personal injury or death.

- **Do not** apply insulation to the top of the water heater, as this will interfere with safe operation of the draft hood.
- **Do not** cover the outer door, thermostat or temperature & pressure relief valve.
- **Do not** allow insulation to come within 2" (50.8 mm) of the floor to prevent blockage of combustion air flow to the burner.
- **Do not** cover the instruction manual. Keep it on the side of the water heater or nearby for future reference.
- **Do** obtain new warning and instruction labels from Sears for placement on the blanket directly over the existing labels.
- **Do** inspect the insulation blanket frequently to make certain it does not sag, thereby obstructing combustion air flow.

Clearances and Accessibility

NOTE: Minimum clearances from combustible materials are stated on the label adjacent to the gas control valve/thermostat of the water heater. The water heater is certified for installation on a combustible floor.

- **IMPORTANT:** If installing over carpeting, the carpeting must be protected by a metal or wood panel beneath the water heater. The protective panel must extend beyond the full width and depth of the water heater by at least three inches (76.2mm) in any direction; or if in an alcove or closet installation, the entire floor must be covered by the panel.
- Figure 10 may be used as a reference guide to locate the specific clearance locations. A minimum of 24 inches of front clearance should be provided for inspection and service.

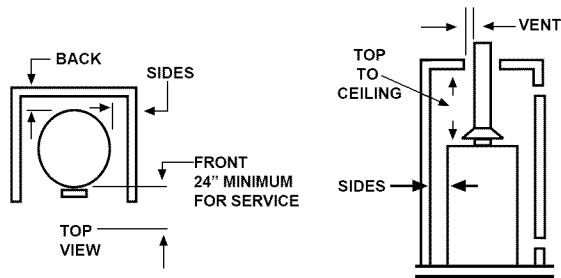

FIGURE 10.

Filling the Water Heater

Never use this water heater unless it is completely full of water. To prevent damage to the tank, the tank must be filled with water. Water must flow from the hot water faucet before turning "ON" gas to the water heater. To fill the water heater with water:

- Close the water heater drain valve by turning the handle to the right (clockwise). The drain valve is on the lower front of the water heater.

- Open the cold water supply valve to the water heater. **NOTE: The cold water supply valve must be left open when the water heater is in use.**
- To ensure complete filling of the tank, allow air to exit by opening the nearest hot water faucet. Allow water to run until a constant flow is obtained. This will let air out of the water heater and the piping.
- Check all water piping and connections for leaks. Repair as needed.

CAUTION
Property Damage Hazard
<ul style="list-style-type: none"> • Avoid water heater damage. • Fill tank with water before operating.

GAS SUPPLY

⚠ WARNING
Explosion Hazard
<ul style="list-style-type: none"> • Use a new CSA approved gas supply line. • Install a shut-off valve. • Do not connect a natural gas water heater to an L.P. gas supply. • Do not connect an L.P. gas water heater to a natural gas supply. • Failure to follow these instructions can result in death, explosion, or carbon monoxide poisoning.

codes or, in the absence of local and state codes, the "National Fuel Gas Code", ANSI Z223.1(NFPA 54)-current edition.

Tables 1 and 2 on the following page provide a sizing reference for commonly used gas pipe materials. Consult the "National Fuel Gas Code" for the recommended gas pipe size of other materials.

NOTE: Use pipe joint compound or teflon tape marked as being resistant to the action of petroleum [Propane (L.P.)] gases. (See Figure 11.)

1. Install a readily accessible manual shut-off valve in the gas supply line as recommended by the local utility. Know the location of this valve and how to turn off the gas to this unit.
2. Install a drip leg (if not already incorporated as part of the water heater) as shown. The drip leg must be no less than three inches long for the accumulation of dirt, foreign material, and water droplets.
3. Install a ground joint union between the gas control valve/thermostat and the manual shut-off valve. This is to allow easy removal of the gas control valve/ thermostat.
4. Turn the gas supply on and check for leaks. Test all connections by brushing on an approved noncorrosive leak-detection solution. Bubbles will show a leak. Correct any leak found.

Gas Requirements

IMPORTANT: Read the rating plate to be sure the water heater is made for the type of gas you will be using in your home. This information will be found on the rating plate located near the gas control valve/thermostat. If the information does not agree with the type of gas available, do not install or light. Call your dealer.

NOTE: An odorant is added by the gas supplier to the gas used by this water heater. This odorant may fade over an extended period of time. Do not depend upon this odorant as an indication of leaking gas.

Gas Piping

The gas piping must be installed according to all local and state

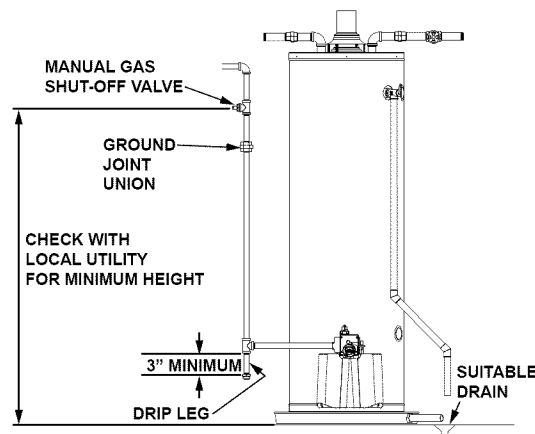



FIGURE 11.

Gas Pressure

⚠ WARNING



Explosion Hazard

- Gas leaks can not always be detected by smell.
- Gas suppliers recommend that you use a gas detector approved by UL or CSA.
- For more information, contact your gas supplier.
- If a gas leak is detected, follow the "What to do if you smell gas" instructions on the cover of this manual.

IMPORTANT: The gas supply pressure must not exceed the maximum supply pressure as stated on the water heater's rating plate. The minimum supply pressure is for the purpose of input adjustment.

Gas Pressure Testing

IMPORTANT: This water heater and its gas connection must be leak tested before placing the appliance in operation.

- If the code requires the gas lines to be tested at a pressure exceeding 14" W.C., the water heater and its manual shut-off valve must be disconnected from the gas supply piping system and the line capped.
- If the gas lines are to be tested at a pressure less than 14" W.C., the water heater must be isolated from the gas supply piping system by closing its manual shut-off valve.

NOTE: Air may be present in the gas lines and could prevent the pilot from lighting on initial start-up. The gas lines should be purged of air by a qualified technician after installation of the gas piping system. While purging the gas piping system of air, ensure that

the fuel is not spilled in the area of the water heater installation, or any source of ignition. If the fuel is spilled while purging the piping system of air follow the "WHAT TO DO IF YOU SMELL GAS" instructions on the cover of this manual.

LP Gas Only

⚠ WARNING



Explosion Hazard

Have a qualified person make sure L.P. gas pressure does not exceed 13" water column.

Examples of a qualified person include: licensed plumbers, authorized gas company personnel, and authorized service personnel.

Failure to do so can result in death, explosion, or fire.

Liquefied petroleum gas is over 50% heavier than air and in the occurrence of a leak in the system, the gas will settle at floor level. Basements, crawl spaces, closets and areas below ground level will serve as pockets for the accumulation of gas. Before lighting an L.P. gas water heater, smell all around the appliance at floor level. If you smell gas, follow the instructions as given in the warning on the front page.

When your L.P. tank runs out of fuel, turn off the gas at all gas appliances including pilot lights. After the tank is refilled, all appliances must be re-lit according to their manufacturer's instructions.

Table 1 Natural Gas Pipe Capacity Table (Cu. Ft./Hr.) Capacity of gas pipe of different diameters and lengths in cu. ft. per hr. with pressure drop of 0.3 in. and specific gravity of 0.60 (natural gas).														
Nominal Iron Pipe Size, in.	Length of Pipe, Feet													
	10	20	30	40	50	60	70	80	90	100	125	150	175	200
1/2	132	92	73	63	56	50	46	43	40	38	34	31	28	26
3/4	278	190	152	130	115	105	96	90	84	79	72	64	59	55
1	520	350	285	245	215	195	180	170	160	150	130	120	110	100
1-1/4	1050	730	590	500	440	400	370	350	320	305	275	250	225	210
1-1/2	1600	1100	890	760	670	610	560	530	490	460	410	380	350	320

After the length of pipe has been determined, select the pipe size which will provide the minimum cubic feet per hour required for the gas input rating of the water heater. By formula:

$$\text{Cu. Ft. Per Hr. Required} = \frac{\text{Gas Input of Water Heater (BTU/HR)}}{\text{Heating Value of Gas (BTU/FT}^3\text{)}}$$

The gas input of the water heater is marked on the water heater data plate. The heating value of the gas (BTU/FT³) may be determined by consulting the local natural gas utility.

Table 2 LP Gas Capacity Table Maximum capacity of pipe in thousands of BTU per hour of undiluted liquefied petroleum gases (at 11 inches water column pressure). Based on a pressure drop of 0.5 inch water column.													
Nominal Iron Pipe Size, in.	Length of Pipe, Feet												
	10	20	30	40	50	60	70	80	90	100	125	150	175
1/2	275	189	152	129	114	103	96	89	83	78	69	63	63
3/4	576	393	315	267	237	217	196	185	173	162	146	132	132
1	1071	732	590	504	448	409	378	346	322	307	275	252	252
1-1/4	2205	1496	1212	1039	913	834	771	724	677	630	567	511	511

Example: Input BTU requirement of the water heater 100,000 BTUH.
Total pipe length, 80 feet = 3/4" IPS required.

Additional tables are available in the latest edition of the "National Fuel Gas Code", ANSI Z223.1.

COMBUSTION AIR SUPPLY & VENTILATION

⚠️ WARNING

Carbon Monoxide Warning

Follow all the local and state codes or, in the absence of local and state codes, the “National Fuel Gas Code”, ANSI Z223.1 (NFPA 54)- current edition to properly install vent system.

Failure to do so can result in death, explosion, or carbon monoxide poisoning.

IMPORTANT: Air for combustion and ventilation must not come from a corrosive atmosphere. Any failure due to corrosive elements in the atmosphere is excluded from warranty coverage.

The following types of installation (not limited to the following) will require outdoor air for combustion due to chemical exposure and may reduce but not eliminate the presence of corrosive chemicals in the air:

- beauty shops
- photo processing labs
- buildings with indoor pools
- water heaters installed in laundry, hobby, or craft rooms
- water heaters installed near chemical storage areas

Combustion air must be free of acid-forming chemicals such as sulfur, fluorine, and chlorine. These elements are found in aerosol sprays, detergents, bleaches, cleaning solvents, air fresheners, paint, and varnish removers, refrigerants, and many other commercial and household products. When burned, vapors from these products form highly corrosive acid compounds. These products should not be stored or used near the water heater or air inlet.

Combustion and ventilation air requirements are determined by the location of the water heater. The water heater may be located in either an open (unconfined) area or in a confined area or small enclosure such as a closet or small room. Confined spaces are areas with less than 50 cubic feet for each 1,000 BTUH of the total input for all gas-using appliances.

Unconfined Space

A water heater in an unconfined space uses indoor air for combustion and requires at least 50 cubic feet for each 1,000 BTUH of the total input for all gas appliances. The table below shows a few examples of the minimum square footage (area) required for various BTUH inputs.

BTUH Input	Minimum Square Feet with 8' Ceiling	Typical Room with 8' Ceiling
30,000	188	9 x 21
45,000	281	14 x 20
60,000	375	15 x 25
75,000	469	15 x 31
90,000	563	20 x 28
105,000	657	20 x 33

120,000	750	25 x 30
135,000	844	28 x 30

IMPORTANT:

- The area must be open and be able to provide the proper air requirements to the water heater. Areas that are being used for storage or contain large objects may not be suitable for water heater installation.
- Water heaters installed in open spaces in buildings with unusually tight construction may still require outdoor air to function properly. In this situation, outside air openings should be sized the same as for a confined space.
- Modern home construction usually requires supplying outside air into the water heater area.

Confined Space

For the correct and proper operation of this water heater, ample air must be supplied for the combustion, ventilation, and dilution of flue gases. Small enclosures and confined areas must have two permanent openings so that sufficient fresh air can be drawn from outside of the enclosure. One opening shall be within 12 inches of the top and one within 12 inches of the bottom of the enclosure as shown in Figure 12.

The size of each opening (free area) is determined by the total BTUH input of all gas utilization equipment (i.e., water heaters, furnaces, clothes dryers, etc.) and the method by which the air is provided. The BTUH input can be found on the water heater rating plate. Additional air can be provided by two methods:

1. All air from inside the building.
2. All air from outdoors.

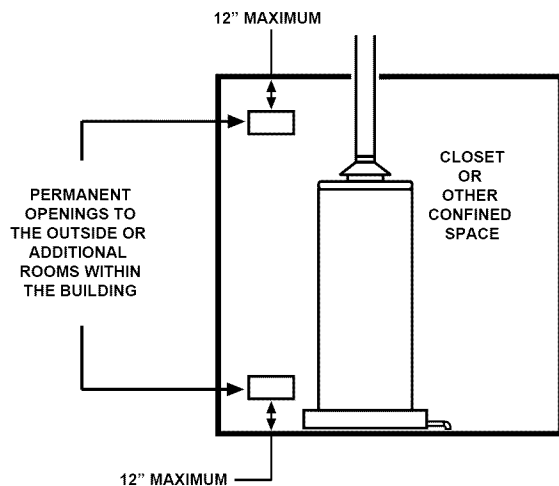

FIGURE 12.

All Air from Inside the Building

When additional air is to be provided to the confined area from additional room(s) within the building, the total volume of the room(s) must be of sufficient size to properly provide the necessary amount of fresh air to the water heater and other

gas utilization equipment in the area. If you are unsure that the structure meets this requirement, contact your local gas utility company or other qualified agency for a safety inspection. Each of the two openings shall have a minimum free area of 1 square inch per 1,000 BTUH of the total input rating of all gas utilization equipment in the confined area, but not less than 100 square inches (Figure 13).

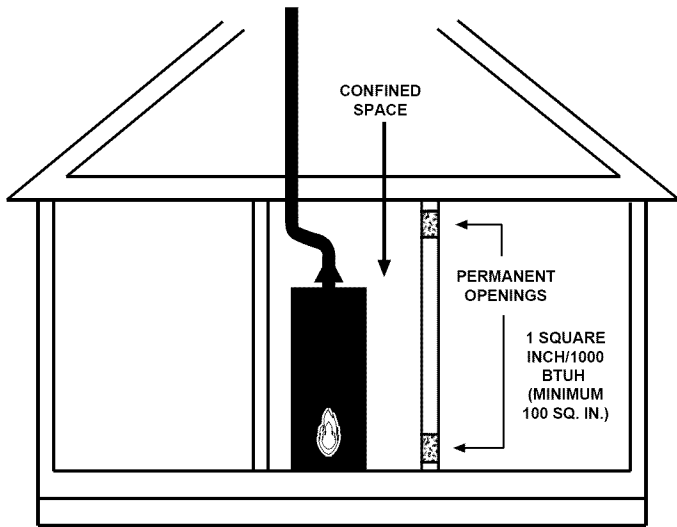

FIGURE 13.

All Air from Outdoors

Outdoor fresh air can be provided to a confined area either directly or by the use of vertical and horizontal ducts. The fresh air can be taken from the outdoors or from crawl or attic spaces that freely communicate with the outdoors. Attic or crawl spaces cannot be closed and must be properly ventilated to the outside.

Ductwork must be of the same cross-sectional area as the free area of the opening to which they connect. The minimum dimension of rectangular air ducts cannot be less than three inches.

The size of each of the two openings is determined by the method in which the air is to be provided. Refer to Table 4 to calculate the minimum free area for each opening. Figures 14, 15, 16 and 17 are typical examples of each method.

Louvers and Grilles

In calculating free area for ventilation and combustion air supply openings, consideration must be given to the blocking effect of protection louvers, grilles, and screens. These devices can reduce airflow, which in turn may require larger openings to achieve the required minimum free area. Screens must not be smaller than 1/4" mesh. If the free area through a particular design of louver or grille is known, it should be used in calculating the specified free area of the opening. If the design and free area are not known, it can be assumed that most wood louvers will allow 20 - 25% of free area while metal louvers and grilles will allow 60 - 75% of free area.

Louvers and grilles must be locked open or interconnected with the equipment so that they are opened automatically during equipment operation.

Keep louvers and grilles clean and free of debris or other obstructions.

TABLE 4		
Minimum Free Area of Permanent Openings for Ventilation and Combustion Air Supply - All Air from Outdoors Only.		
Based on total BTUH input rating for all utilizing equipment within the confined space.		
Opening Source	Minimum Free Area Per Opening (sq. in.)	Reference Drawing
*Direct to outdoors	1 sq. in. per 4000 BTUH	Figure 14
Vertical Ducts	1 sq. in. per 4000 BTUH	Figure 15
Horizontal Ducts	1 sq. in. per 2000 BTUH	Figure 16
Single Opening	1 sq. in. per 3000 BTUH	Figure 17

Example: A water heater with an input rating of 50,000 BTUH using horizontal ducts would require each opening to have a minimum free area of 25 square inches.

Minimum free area = 50,000 BTUH x 1 sq. in. / 2000 BTUH = 25 sq. in.

* These openings connect directly with the outdoors through a ventilated attic, a ventilated crawl space, or through an outside wall.

Consult the local codes of your area for specific ventilation and combustion air requirements.

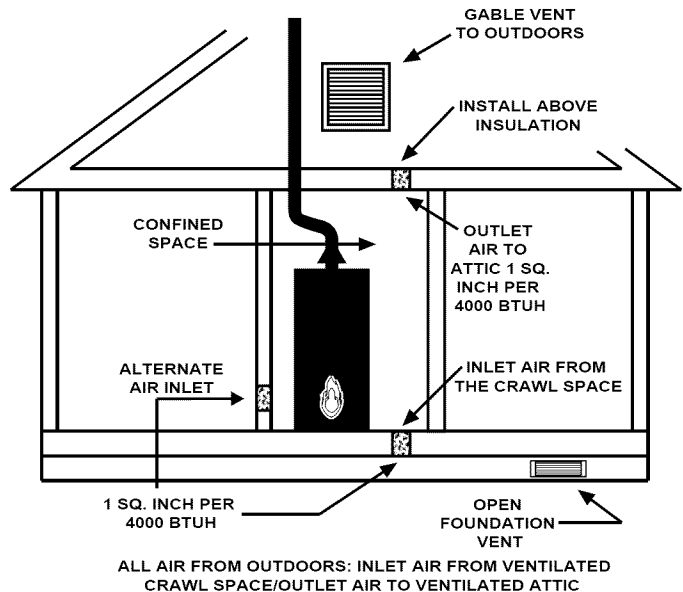

FIGURE 14.

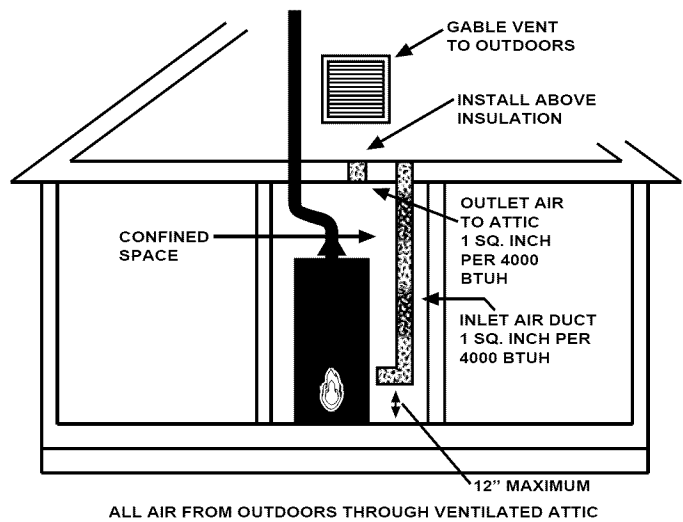

FIGURE 15.

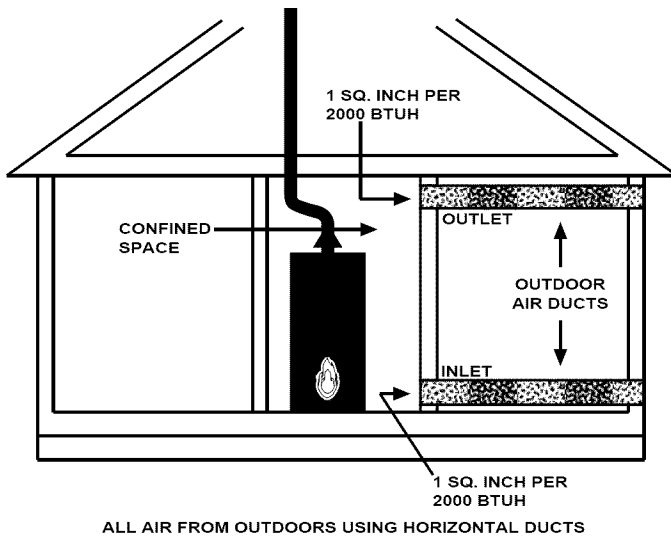

FIGURE 16.

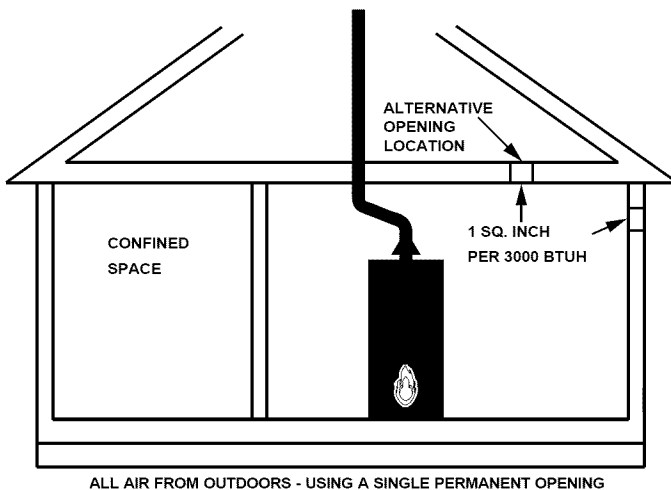

FIGURE 17.

Vent Pipe System

This water heater uses a non-direct, single-pipe vent system to remove exhaust gases created by the burning of fossil fuels. Air for combustion is taken from the immediate water heater location or is ducted in from the outside (see “Combustion Air Supply and Ventilation”).

This water heater must be properly vented for the removal of exhaust gases to the outside atmosphere. Correct installation of the vent pipe system is mandatory for the proper and efficient operation of this water heater and is an important factor in the life of the unit.

The vent pipe must be installed according to all local and state codes or, in the absence of local and state codes, the “National Fuel Gas Code”, ANSI Z223.1(NFPA 54)-current edition. The vent pipe installation must not be obstructed so as to prevent the removal of exhaust gases to the outside atmosphere.

IMPORTANT: The use of vent dampers is not recommended by the manufacturer of this water heater. Although some vent dampers are certified by CSA International, this certification applies to the vent damper device only and does not mean they are certified for use on this water heater.

U.L. recognized fuel gas and carbon monoxide (CO) detectors are recommended in all applications and should be installed

using the manufacturer’s instructions and local codes, rules, or regulations.

IMPORTANT: If you lack the necessary skills required to properly install this venting system, you should not proceed, but get help from a qualified technician.

Draft Hood Installation

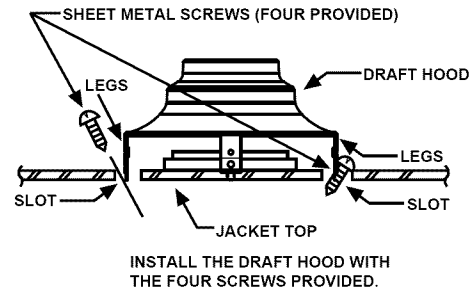

FIGURE 18.

Align the legs of the draft hood with the slots provided. Insert the legs and secure the draft hood to the water heater’s top with the four screws provided as shown in Figure 18. Do not alter the draft hood in any way. If you are replacing an existing water heater, be sure to use the draft hood supplied with this water heater.

Vent Pipe Size

It is important that you follow the guidelines in these instructions for sizing a vent pipe system. If a transition to a larger vent size is required, the vent transition connection must be made at the draft hood outlet.

Vent Connectors

1. Type B, Double wall, U.L. Listed Vent Pipe.
2. Single wall Vent Pipe.

Maintain the manufacturer’s specified minimum clearance from combustible materials when using type B double wall vent pipe.

Vent connectors made of type B, double wall vent pipe material may pass through walls or partitions constructed of combustible material if the minimum listed clearance is maintained.

Maintain a six inch minimum clearance from all combustible materials when using single wall vent pipe.

IMPORTANT: Single wall vent pipe cannot be used for water heaters located in attics and may not pass through attic spaces, crawl spaces or any confined or inaccessible location. A single wall metal vent connector cannot pass through any interior wall.

When installing a vent connector, please note the following (See Figures 19-21):

- Install the vent connector avoiding unnecessary bends, which create resistance to the flow of vent gases.
- Install without dips or sags with an upward slope of at least 1/4-inch per foot.
- Joints must be fastened by sheet metal screws or other approved means. It must be supported to maintain clearances and prevent separation of joints and damage.
- The length of the vent connector cannot exceed 75% of the vertical vent height.

- The vent connector must be accessible for cleaning, inspection, and replacement.
- Vent connectors cannot pass through any ceiling, floor, firewall, or fire partition.
- It is recommended (but not mandatory) that a minimum 12 inches of vertical vent pipe be installed on the draft hood prior to any elbow in the vent system.

IMPORTANT: Existing vent systems must be inspected for obstructions, corrosion, and proper installation.

Chimney Connection

IMPORTANT: Before connecting a vent to a chimney, make sure the chimney passageway is clear and free of obstructions. The chimney must be cleaned if previously used for venting solid fuel appliances or fireplaces. Also consult local and state codes for proper chimney sizing and application or, in the absence of local and state codes, the “National Fuel Gas Code”, ANSI Z223.1(NFPA 54)-current edition.

- The connector must be installed above the extreme bottom of the chimney to prevent potentially blocking the flue gases.
- The connector must be firmly attached and sealed to prevent it from falling out.
- To aid in removing the connector, a thimble or slip joint may be used.
- The connector must not extend beyond the inner edge of the chimney as it may restrict the space between it and the opposite wall of the chimney (Figure 19).

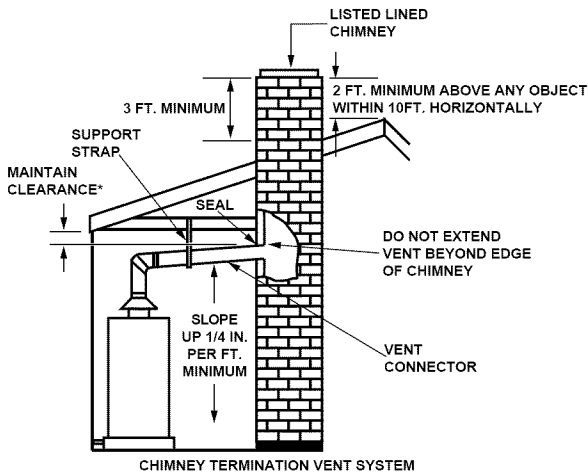

FIGURE 19.

Do not terminate the vent connector in a chimney that has not been certified for this purpose. Some local codes may prohibit the termination of vent connectors in a masonry chimney.

Vertical Exhaust Gas Vent

Vertical exhaust gas vents must be installed with U.L. listed type B vent pipe according to the vent manufacturer’s instructions and the terms of its listing.

It must be connected to the water heater’s draft hood by a listed vent connector or by directly originating at the draft hood opening.

Vertical gas vents must terminate with a listed cap or other roof assembly and be installed according to their manufacturer’s instructions.

Gas vents must be supported to prevent damage, joint

separation, and maintain clearances to combustible materials (Figures 20 and 21).

IMPORTANT: This gas vent must be terminated in a vertical position to facilitate the removal of the burnt gases.

An unused chimney flue or masonry enclosure may be used as a passageway for the installation of a gas vent (Figure 21).

Common (combined) venting is allowable with vertical type B vent systems and lined masonry chimneys as long as proper draft for the water heater is established under all conditions of operation. **CAUTION: DO NOT** common vent this water heater with any power vented appliance.

Figures 19-21 are examples of vent pipe system installations and may or may not be typical for your specific application. Consult the “National Fuel Gas Code”, NFPA 54, ANSI Z223.1-current edition and the guidelines set forth by prevailing local codes.

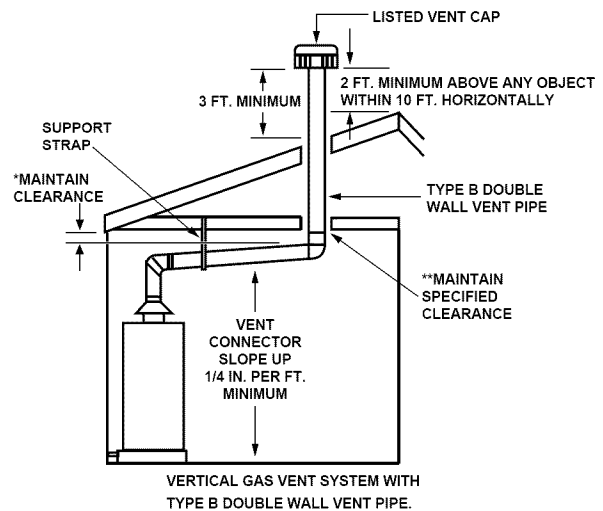

FIGURE 20.

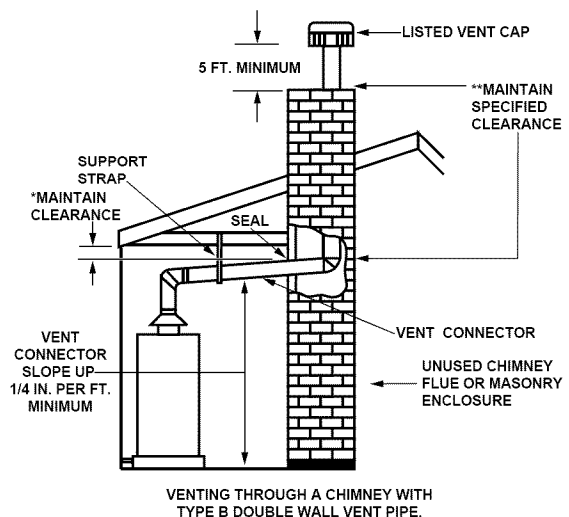

FIGURE 21.

* Maintain vent pipe clearance requirements to local, state and/or the “National Fuel Gas Code”, ANSI Z223.1(NFPA 54)-current edition.

** NFPA 211, Standard for Chimneys, Fireplaces, Vents, and Solid Fuel-Burning Appliances states that these chimneys are intended to be installed in accordance with the installation instructions provided with each chimney support assembly. Minimum air space clearance to combustible materials should be maintained as marked on the chimney sections.

WATER SYSTEM PIPING

Piping Installation

Piping, fittings, and valves should be installed according to the installation drawing (Figure 22). If the indoor installation area is subject to freezing temperatures, the water piping must be protected by insulation.

The water supply pressure should not exceed 80 psi. If this occurs, a pressure reducing valve with a bypass may need to be installed in the cold water inlet line. This should be placed on the supply to the entire house in order to maintain equal hot and cold water pressures.

IMPORTANT: Heat cannot be applied to the water fittings on the heater as they may contain nonmetallic parts. If solder connections are used, solder the pipe to the adapter before attaching the adapter to the hot and cold water fittings.

IMPORTANT: Always use a good grade of joint compound and be certain that all fittings are drawn up tight.

1. Install the water piping and fittings as shown in Figure 22. Connect the cold water supply (3/4" NPT) to the cold water inlet fitting. Connect the hot water supply (3/4" NPT) to the hot water outlet fitting.

IMPORTANT: Some models may contain energy saving heat traps to prevent the circulation of hot water within the pipes. Do not remove the inserts within the heat traps.

2. The installation of unions in both the hot and cold water supply lines is recommended for ease of removing the water heater for service or replacement.
3. The manufacturer of this water heater recommends installing a mixing valve or an anti-scald device in the domestic hot water line as shown in Figure 23. These valves reduce the point-of-use temperature of the water by mixing cold and hot water and are readily available for use.
4. If installing the water heater in a closed water system, install an expansion tank in the cold water line as specified under "Closed System/Thermal Expansion."
5. Install a shut-off valve in the cold water inlet line. It should be located close to the water heater and be easily accessible. Know the location of this valve and how to shut off the water to the heater.
6. A temperature and pressure relief valve must be installed in the opening marked "Temperature and Pressure (T & P) Relief Valve" on the water heater. A discharge line must be added to the opening of the T&P Relief Valve. Follow the instructions under "Temperature and Pressure Relief Valve."
7. After piping has been properly connected to the water heater, remove the aerator at the nearest hot water faucet. Open the hot water faucet and allow the tank to completely fill with water. To purge the lines of any excess air, keep the hot water faucet open for 3 minutes after a constant flow of water is obtained. Close the faucet and check all connections for leaks.

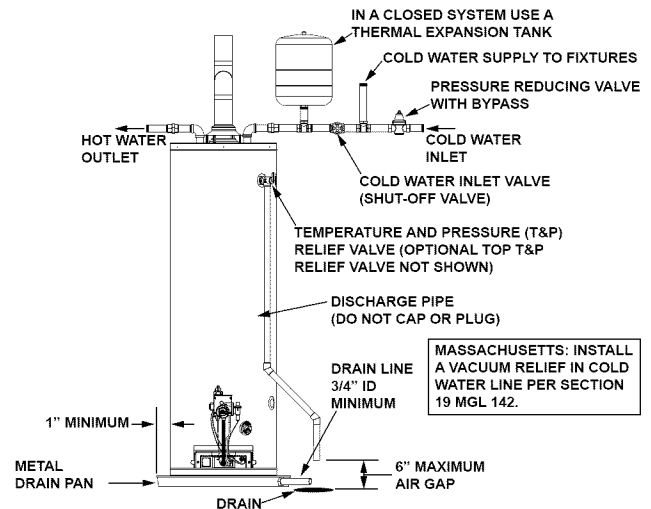

FIGURE 22.

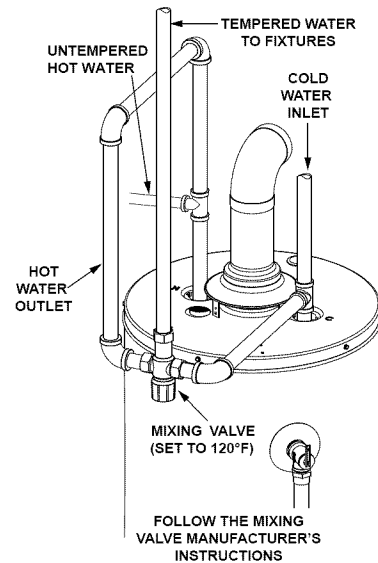

FIGURE 23.

Please note the following:

- The system should be installed only with piping that is suitable for potable (drinkable) water such as copper, CPVC, or polybutylene. This water heater must not be installed using iron piping or PVC water piping.
- Use only pumps, valves, or fittings that are compatible with potable water.
- It is recommended that only full flow ball or gate valves are used in water piping installations. The use of valves that may cause excessive restriction to water flow is not recommended.
- Use only 95/5 tin-antimony or other equivalent solder. Any lead based solder must not be used.
- Piping that has been treated with chromates, boiler seal, or other chemicals must not be used.
- Chemicals that may contaminate the potable water supply must not be added to the piping system.

Closed System/Thermal Expansion

CAUTION

Property Damage Hazard

- All water heaters eventually leak
- Do not install without adequate drainage.

As water is heated, it expands (thermal expansion). In a closed system, the volume of water will grow. As the volume of water grows, there will be a corresponding increase in water pressure due to thermal expansion. Thermal expansion can cause premature tank failure (leakage). This type of failure is not covered under the limited warranty. Thermal expansion can also cause intermittent temperature-pressure relief valve operation: water discharged from the valve due to excessive pressure build up. The temperature-pressure relief valve is not intended for the constant relief of thermal expansion. This condition is not covered under the limited warranty.

A properly sized thermal expansion tank should be installed on all closed systems to control the harmful effects of thermal expansion. Thermal expansion tanks are available from Sears stores and through the Sears Service Centers. Contact the local plumbing inspector, water supplier and/or the Sears Service Center for assistance in controlling these situations. (For additional information, see the Troubleshooting Guide later in this manual.)

Temperature and Pressure Relief Valve

WARNING

Explosion Hazard

- Temperature-pressure relief valve must comply with ANSI Z21.22-CSA 4.4 and ASME code.
- Properly sized temperature-pressure relief valve must be installed in opening provided.
- Can result in overheating and excessive tank pressure.
- Can cause serious injury or death.

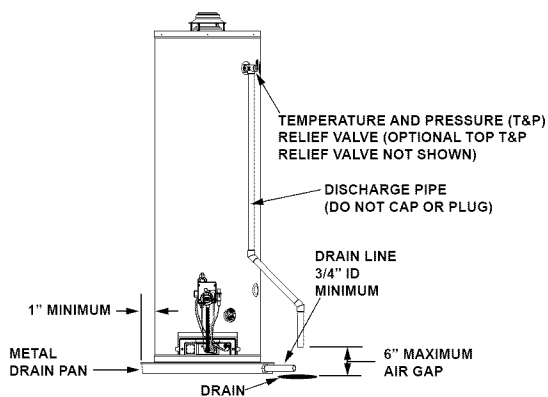
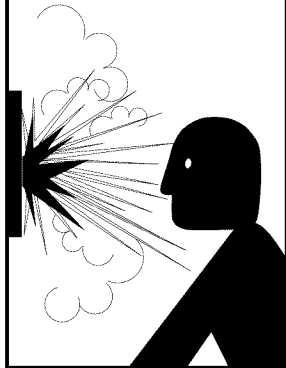

FIGURE 24.

For protection against excessive pressures and temperatures, a temperature and pressure relief valve must be installed in the opening marked "T & P RELIEF VALVE." (See Figure 24). This valve must be design certified by a nationally recognized testing laboratory that maintains periodic inspection of the production of listed equipment or materials as meeting the requirements for Relief Valves for Hot Water Supply Systems, ANSI Z21.22. The function of the temperature and pressure relief valve is to discharge water in large quantities in the event of excessive temperature or pressure developing in the water heater. The valve's relief pressure must not exceed the working pressure of the water heater as stated on the rating plate.

IMPORTANT: Only a new temperature and pressure relief valve should be used with your water heater. Do not use an old or existing valve as it may be damaged or not adequate for the working pressure of the new water heater. Do not place any valve between the relief valve and the tank.

The Temperature & Pressure Relief Valve:

- Must not be in contact with any electrical part.
- Must be connected to an adequate discharge line.
- Must not be rated higher than the working pressure shown on the rating plate of the water heater.

The Discharge Line:

- Must not be smaller than the pipe size of the relief valve or have any reducing coupling installed in the discharge line.
- Must not be capped, blocked, plugged or contain any valve between the relief valve and the end of the discharge line.
- Must terminate a maximum of six inches above a floor drain or external to the building.
- Must be capable of withstanding 250°F (121°C) without distortion.
- Must be installed to allow complete drainage of both the valve and discharge line.

T&P Relief Valve and Pipe Insulation

1. Locate the T&P Relief Valve on the water heater.
2. Locate the slit running the length of the insulation.
3. Spread this slit open and slip it up under the T&P Relief Valve. See Figure 25. Apply gentle pressure to the insulation to ensure it is fully seated on the T&P Relief Valve. Once sealed secure the insulation with a section of tape. **IMPORTANT:** The insulation or tape should not block or cover the T&P Relief Valve drain opening. Also the insulation or tape should not block or hinder access to the T&P Relief Valve manual relief lever.
4. Next locate the hot water (outlet) & cold water (inlet) pipes to the water heater.
5. Select one of the sections of pipe insulation and locate the slit that runs the length of the insulation.
6. Spread the slit open at the base of the insulation and slip it over the cold water (inlet) pipe. Apply gentle pressure along the length of the insulation to ensure it is fully seated around the cold water pipe. Also ensure that the base of insulation is flush with the water heater. Once seated, secure the insulation with a section of tape.
7. Repeat steps 5 through 6 for the hot water (outlet) pipe.

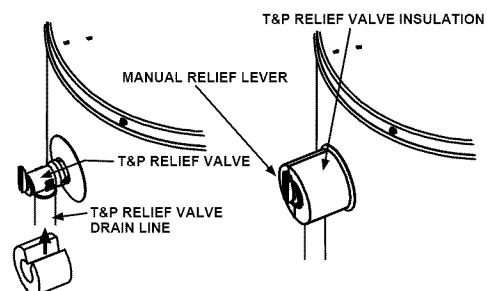



FIGURE 25.

OPERATING YOUR WATER HEATER

Lighting Instructions

Read and understand these directions thoroughly before attempting to light or re-light the pilot. Make sure the view port is not missing or damaged. (See Figure 32.) Make sure the tank is completely filled with water before lighting the pilot. Check the rating plate near the gas control valve/thermostat for the correct gas. Do not use this water heater with any gas other than the one listed on the rating plate. If you have any questions or doubts, consult your gas supplier or gas utility company.



⚠ WARNING

Explosion Hazard

Replace view port if glass is missing or damaged.

Failure to do so can result in death, explosion or fire.

FOR YOUR SAFETY READ BEFORE LIGHTING





WARNING: If you do not follow these instructions exactly, a fire or explosion may result causing property damage, personal injury or loss of life.



FLAMMABLE

BEFORE LIGHTING: ENTIRE SYSTEM MUST BE FILLED WITH WATER AND AIR PURGED FROM ALL LINES

A. This appliance has a pilot which is lit by a piezo-electric spark gas ignition system. Do not open the inner door of the appliance and try to light the pilot by hand.

B. BEFORE LIGHTING smell all around the appliance area for gas. Be sure to smell next to the floor because some gas is heavier than air and will settle on the floor.

WHAT TO DO IF YOU SMELL GAS

- Do not try to light any appliance.
- Do not touch any electric switch; do not use any phone in your building.
- Immediately call your gas supplier from a neighbor's phone. Follow the gas supplier's instructions.
- If you cannot reach your gas supplier, call the fire department.

C. Use only your hand to push in or turn the gas control knob. Never use tools. If the knob will not push in or turn by hand, don't try to repair it, call a qualified service technician. Force or attempted repair may result in a fire or explosion.

D. Do not use this appliance if any part has been under water. Immediately contact a qualified installer or service agency to replace a flooded water heater. Do not attempt to repair the unit! It must be replaced!

E. DO NOT USE THIS APPLIANCE IF THERE HAS BEEN AN IGNITION OF VAPORS. Immediately call a qualified service technician to inspect the appliance. Water heaters subjected to a flammable vapors ignition will show a discoloration on the air intake grid and require replacement of the entire water heater.

LIGHTING INSTRUCTIONS

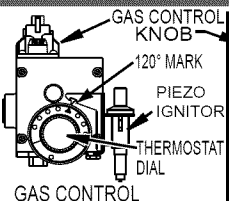

GAS CONTROL KNOB
120° MARK
PIEZO IGNITOR
THERMOSTAT DIAL
GAS CONTROL

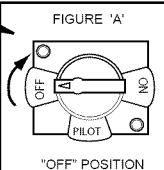

FIGURE 'A'
"OFF" POSITION

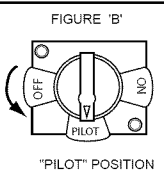

FIGURE 'B'
"PILOT" POSITION

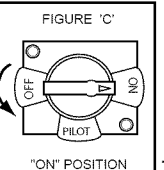
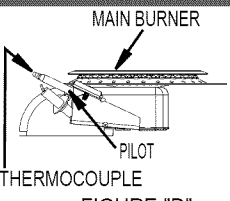









FIGURE 'C'
"ON" POSITION



MAIN BURNER
PILOT
THERMOCOUPLE
FIGURE "D"

1.  **STOP!** Read the safety information above on this label.
2. Set the thermostat to lowest setting (PILOT LIGHTING). Turn thermostat dial fully clockwise  until it stops.
3. Push the gas control knob down slightly and turn clockwise  to "OFF". SEE FIGURE 'A'. NOTE: Knob cannot be turned from "PILOT" to "OFF" unless knob is pushed down slightly. Do not force.
4. Remove the outer burner door located below the gas control.
5. Wait ten (10) minutes to clear out any gas. If you then smell gas,  **STOP!** Follow "B" in the safety information above on this label. If you don't smell gas,  go to next step.
6. This unit is equipped with a push button pilot ignitor, which is used to light the pilot. Locate the ignitor on the gas control.
7. Turn gas control knob counterclockwise  to "PILOT". SEE FIGURE 'B'.
8. The pilot is located on the left side of the burner. It can be located by looking through the glass view port while pressing the piezo ignitor button several times. Look for a spark at the pilot location, Figure "D".
9. Once the pilot has been found, push the gas knob all the way down. Immediately press the pilot ignitor button rapidly (4) to (5) times. If the pilot will not light, repeat step (3) through (9).
10. Continue to hold the gas control knob down for about one (1) minute after the pilot is lit. Release the gas control knob and it will pop back up. Pilot should remain lit. If it goes out, repeat step (3) through (9). It may take several minutes for air to clear the lines before the pilot will light.
 - If knob does not pop up when released, stop and immediately call your service technician or gas supplier.
 - If the pilot will not stay lit after several tries, turn the gas control knob clockwise  to 'OFF' and call your service technician or gas supplier. SEE FIGURE 'A'.
11. Once the pilot flame is established replace the outer burner door.
12. At arm's length away, turn gas control knob counterclockwise  to 'ON'. SEE FIGURE 'C'.
13. Set thermostat to desired setting.

⚠ DANGER: Hotter water increases the risk of scald injury. Consult the instruction manual before changing temperature.

TO TURN OFF GAS TO APPLIANCE

1. Set the thermostat to lowest setting (PILOT LIGHTING).
2. Push gas control knob down slightly and turn clockwise  to "OFF". Do not force. SEE FIGURE 'A'.

Checking the Draft

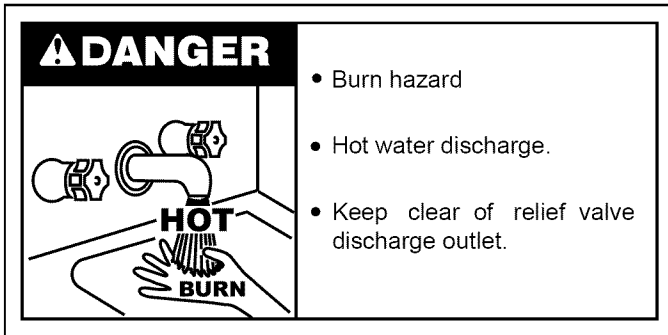

After successfully lighting the water heater, allow the unit to operate for 15 minutes and check the draft hood relief opening for proper draft (Figure 26). Make sure all other appliances in the area are operating and all doors are closed when performing the draft test. Pass a match flame around the relief opening of the draft hood. A steady flame drawn into the opening indicates proper draft.

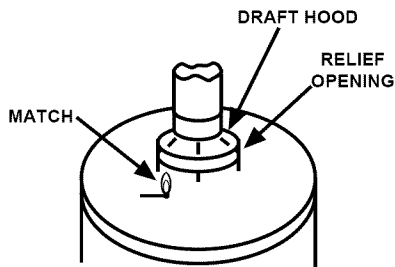

FIGURE 26.

If the flame flutters or is blown out, combustion products are escaping from the relief opening. If this occurs, do not operate the water heater until proper adjustments or repairs are made to the vent pipe system and/or air supply requirements.

Burner Flames

Inspect the burner flames through the viewport and compare them to the drawing in Figure 27. A properly operating burner should produce a soft blue flame. Blue tips with yellow inner cones are satisfactory. The tips of the flame may have a slight yellow tint. The flame should not be all yellow or have a sharp blue-orange color. Contaminated air may cause an orange colored flame. Contact a qualified technician if the flame is not satisfactory.

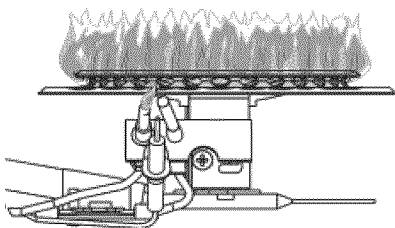
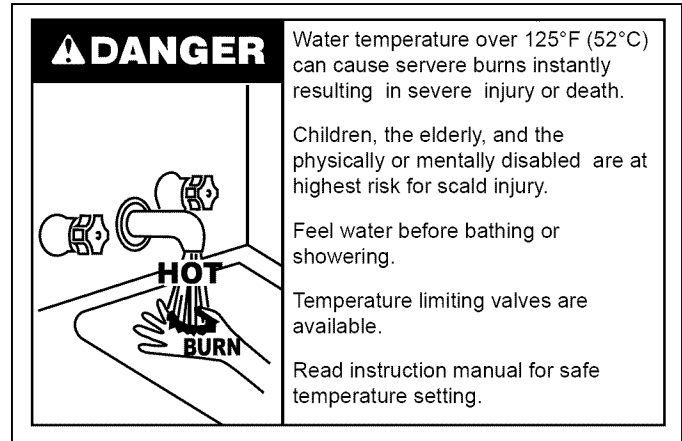

FIGURE 27.

Emergency Shut Down

IMPORTANT: Should overheating occur or the gas supply fails to shut off, turn off the water heater's manual gas control valve and call a qualified technician.

Water Temperature Regulation



Due to the nature of the typical gas water heater, the water temperature in certain situations may vary up to 30°F (16.7 °C) higher or lower at the point of use such as, bathtubs, showers, sink, etc.

HOTTER WATER CAN SCALD: Water heaters are intended to produce hot water. Water heated to a temperature which will satisfy space heating, clothes washing, dish washing, and other sanitizing needs can scald and permanently injure you upon contact. Some people are more likely to be permanently injured by hot water than others. These include the elderly, children, the infirm, or physically/mentally handicapped. If anyone using hot water in your home fits into one of these groups or if there is a local code or state law requiring a certain temperature water at the hot water tap, then you must take special precautions. In addition to using the lowest possible temperature setting that satisfies your hot water needs, a means such as a mixing valve should be used at the hot water taps used by these people or at the water heater. Mixing valves are available at plumbing supply or hardware stores. See Figure 23. Follow manufacturer's instructions for installation of the valves. Before changing the factory setting on the thermostat, see Figure 28. Using the lowest hot water temperature that meets your needs will also provide the most energy efficient operation of the water heater.

Never allow small children to use a hot water tap, or to draw their own bath water. Never leave a child or handicapped person unattended in a bathtub or shower.

NOTE: A water temperature range of 120°F-140°F (49°C-60°C) is recommended by most dishwasher manufacturers.

The thermostat of this water heater has been factory set at its lowest position. It is adjustable and must be reset to the desired temperature setting to reduce the risk of scald injury. The ▲ mark is indicative of approximately 120°F (49°C) and is the preferred starting point. See Figure 28 on the next page. Some states have a requirement for a lower setting.

Turn the water temperature dial clockwise (↻) to decrease the temperature, or counterclockwise (↻) to increase the temperature.

Should overheating occur or the gas supply fail to shut off, turn off the manual gas control valve to the appliance.

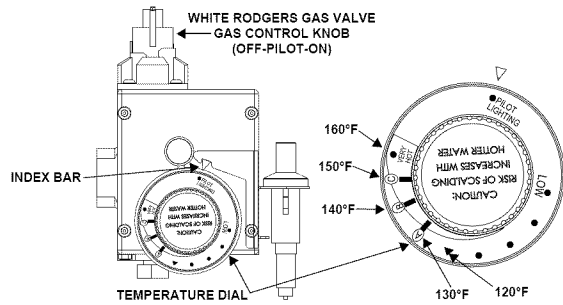

Temperature Settings	Time to Produce 2nd & 3rd Degree Burns on Adult Skin
VERY HOT= approx. 160°F (71°C)	About 1/2 second
C = approx. 150°F (66°C)	About 1-1/2 seconds
B = approx. 140°F (60°C)	Less than 5 seconds
A = approx. 130°F (54°C)	About 30 seconds
▲ = approx. 120°F (49°C)	More than 5 minutes
LOW = approx. 80°F (27°C)	-----

FIGURE 28.

NOTE: During low demand periods when hot water is not being used, a lower thermostat setting will reduce energy losses and may satisfy your normal hot water needs. If hot water use is expected to be more than normal, a higher thermostat setting may be required to meet the increased

demand. When leaving your home for extended periods (vacations, etc.) turn the temperature dial to its lowest setting. This will maintain the water at low temperatures with minimum energy losses and prevent the tank from freezing during cold weather.

SERVICE AND ADJUSTMENT

Tank (Sediment) Cleaning

Sediment build-up on the tank bottom may create varying amount of noise, and if left in the tank will cause permanent tank failure. In some water areas, you may not be able to drain all sediment deposits by simply draining the tank. In these cases, Mag-Erad (part no. 23600) can be used to help remove the sediment deposits. This may be ordered from the Sears Service Center. For ordering, refer to the "Parts Order List" section.

Vent System Inspection

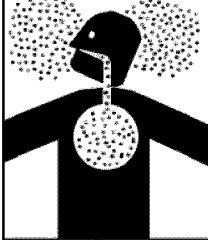
⚠ WARNING	
Carbon Monoxide and Fire Hazard	
	<ul style="list-style-type: none">• Flue gases may escape if vent pipe is not connected.• Be alert for obstructed, sooted or deteriorated vent system to avoid serious injury or death.• Do not store corrosive chemicals in vicinity of water heater.• Chemical corrosion of flue and vent system can cause serious injury or death
Breathing carbon monoxide can cause brain damage or death. Always read and understand instruction manual.	

At least once a year, a visual inspection should be made of the venting system. You should look for:

- Obstructions which could cause improper venting. The combustion and ventilation air flow must not be obstructed.
- Damage or deterioration which could cause improper venting or leakage of combustion products.
- Rusted flakes around top of water heater.

Be sure the vent piping is properly connected to prevent escape of dangerous flue gasses which could cause deadly asphyxiation.

Obstructions and deteriorated vent systems may present serious health risk or asphyxiation.

Chemical vapor corrosion of the flue and vent system may occur if air for combustion contains certain chemical vapors. Spray can propellants, cleaning solvents, refrigerator and air conditioner refrigerants, swimming pool chemicals, calcium and sodium chloride, waxes, bleach and process chemicals are typical compounds which are potentially corrosive.

If when inspecting the vent system you find sooting or deterioration, something is wrong. Call the local gas supplier to correct the problem and clean or replace the flue and venting before resuming operation of the water heater.

Burner Inspection

Flood damage to a water heater may not be readily visible or immediately detectable. However, over a period of time a flooded water heater will create dangerous conditions which can cause **DEATH, SERIOUS BODILY INJURY, OR PROPERTY DAMAGE.** Contact a Sears Service Center to replace a flooded water heater. Do not attempt to repair the unit! It must be replaced!

At least once a year, a visual inspection should be made of the main burner and pilot burner. See Figure 29.

You should check for sooting. Soot is not normal and will impair proper combustion.

Soot build-up indicates a problem that requires correction before further use. Turn "OFF" gas to water heater and leave off until repairs are made, because failure to correct the cause of the sooting can result in a fire causing death, serious injury, or property damage.

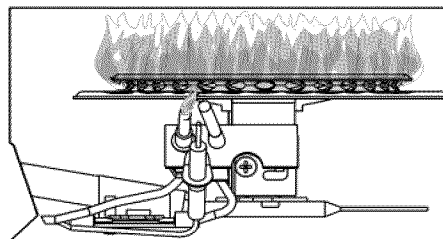



FIGURE 29.

Burner Cleaning

⚠ DANGER	
Fire or Explosion Hazard	
Failure to properly reseal the combustion chamber will disable the flammable vapor ignition resistance feature of this water heater, which could result in death or serious injury. Contact your local Sears Service Center for assistance.	
	Read instruction manual before installing, using or servicing water heater.
	

In the event your burner needs cleaning, follow these instructions:

If inspection of the burner shows that cleaning is required, turn the gas control knob clockwise (↻) to the "OFF" position, depressing slightly.

NOTE: The knob cannot be turned from "PILOT" to "OFF" unless knob is depressed slightly. DO NOT FORCE.

The burner needs to be removed for cleaning. Call the Sears Service Center to remove and clean the burner and correct the problem that required the burner to be cleaned.

Housekeeping

Vacuum around base of water heater for dust, dirt, and lint on a regular basis.

	⚠ DANGER
	Fire and Explosion Hazard <ul style="list-style-type: none"> • Do not obstruct combustion air openings at the bottom of the water heater. • Do not use or store flammable vapor products such as gasoline, solvents or adhesives in the same room or area near water heater or other appliance. • At least annually, check the base-ring filter and flame arrester for any dust, lint, or debris that may have accumulated. Clean as necessary. • Can cause serious injury or death.

AT LEAST ANNUALLY, A VISUAL INSPECTION SHOULD BE MADE OF THE BASE-RING FILTER AND FLAME ARRESTER. CLEAN IF LINT ACCUMULATIONS ARE NOTICED.

INSTALLED IN SUITABLE AREA: To ensure sufficient ventilation and combustion air supply, proper clearances from the water heater must be maintained. See "Installation Instructions." Combustible materials such as clothing, cleaning materials, or flammable liquids, etc. must not be placed against or adjacent to the water heater because they could catch on fire.

Anode Rod Inspection

CAUTION
Property Damage Hazard
<ul style="list-style-type: none"> • Avoid water heater damage. • Inspection and replacement of anode rod required.

The anode rod is used to protect the tank from corrosion. Most hot water tanks are equipped with an anode rod. The submerged rod deteriorates to protect the tank. Instead of corroding the tank, water ions attack and eat away the anode rod. This does not affect the water's taste or color. The rod must be maintained to keep the tank in operating condition.

Anode deterioration depends on water conductivity, not necessarily water condition. A corroded or pitted anode rod indicates high water conductivity and should be checked and/or replaced more often than an anode rod that appears to be intact. Replacement of a depleted anode rod can extend the life of your water heater. Inspection should be conducted by calling the Sears Service Center for an authorized contractor. At a minimum, the anode(s) should be checked annually after the warranty period.

Temperature-Pressure Relief Valve Operation

The temperature-pressure relief valve must be manually operated at least once a year.

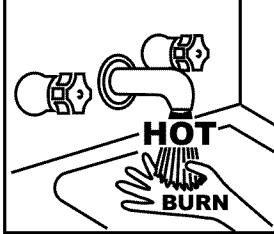
	⚠ DANGER
	<ul style="list-style-type: none"> • Burn hazard • Hot water discharge. • Keep clear of relief valve discharge outlet.

When checking the temperature-pressure relief valve operation, make sure that (1) no one is in front of or around the outlet of the temperature-pressure relief valve discharge line, and (2) that the water discharge will not cause any property damage, as the water may be extremely hot. See Figure 30.

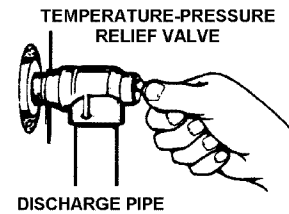
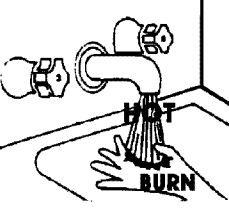

FIGURE 30.

If after manually operating the valve, it fails to completely reset and continues to release water, immediately close the cold water inlet to the water heater, follow the draining instructions, and replace the temperature-pressure relief valve with a new one.

If the temperature-pressure relief valve on the appliance weeps or discharges periodically, this may be due to thermal expansion. You may have a check valve installed in the water line or a water meter with a check valve. Consult the Sears Service Center for further information. Do not plug the temperature-pressure relief valve.

Draining and Flushing

	⚠ DANGER
	<ul style="list-style-type: none"> • Hot water discharge burn hazard. • Keep clear of relief valve discharge unit. • Temperature limiting valves are available. • Read instruction manual for safe temperature setting.

It is recommended that the tank be drained and flushed every 6 months to remove sediment which may build up during operation. The water heater should be drained if being shut

down during freezing temperatures. To drain the tank, perform the following steps:

1. Turn off the gas to the water heater at the manual gas shut-off valve.
2. Close the cold water inlet valve.
3. Open a nearby hot water faucet.
4. Connect a hose to the drain valve and terminate it to an adequate drain.

NOTE: The drain hose should be rated for at least 200°F. If the drain hose does not have this rating, open the cold water inlet valve and a nearby hot faucet until the water is no longer hot.

5. Open the water heater drain valve and allow all the water to drain from the tank. Flush the tank with water as needed to remove sediment.
6. Close the drain valve, refill the tank, and restart the heater as directed under the "Operating Your Water Heater" section.

If the water heater is going to be shut down for an extended

period, the drain valve should be left open.

IMPORTANT: Condensation may occur when refilling the tank and should not be confused with a tank leak.

Service

Before calling for repair service, please read the Troubleshooting Guide in this manual.

If a condition persists or you are uncertain about the operation of the water heater, let the Sears Service Center check it out.

Contact Sears Service Center at:

1-800-4-MY-HOME® (1-800-469-4663).

MAINTENANCE OF YOUR WATER HEATER

Replacement Parts

IMPORTANT: The following maintenance procedures are for the FVIR System components and should be performed by a qualified technician.

Replacement parts may be ordered from Sears Parts and Service Centers or by calling 1-800-4-MY-HOME (1-800-469-4663). When ordering replacement parts, always have the following information ready:

1. model, serial, and product number
2. type of gas
3. item number
4. parts description

See the Parts Order List section for a list of available repair parts.

External Inspection & Cleaning of the Base-Ring Filter

1. At least annually, check the base-ring filter (Figure 38) for any dust or debris that may have accumulated on the filter screen. **NOTE:** If the water heater is located in an area that is subjected to lint and dirt, it may be necessary to check the base-ring filter more frequently.
2. Follow the Lighting Instructions to turn off the water heater and allow it to cool for 10 minutes before attempting to clean the base-ring filter.
3. Use a vacuum cleaner with a hose attachment to remove any dust or debris that may have accumulated on the filter. **NOTE:** If unable to inspect or clean the base-ring filter, follow the "Cleaning the Combustion Chamber and Flame-arrestor" instructions.
4. After the base-ring filter has been cleaned, follow the Lighting Instructions to return the water heater to service.

Removing the Manifold/Burner Assembly

1. Turn off the gas supply to the water heater at the manual gas shut-off valve. This valve is typically located beside the water heater (Figure 11). Note the position of the shut-off valve in the open/on position then proceed to turn it off.
2. On the lower front of the water heater, locate the gas control valve/thermostat (see Figure 32). Before performing any maintenance, it is important to turn the temperature dial on the gas control valve/thermostat to its lowest setting.
3. On top of the gas control valve/thermostat, turn the gas control knob to the "OFF" position.

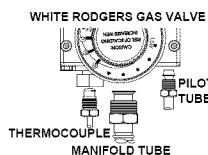

FIGURE 31.

4. Remove the outer door.
5. Remove the two screws securing the manifold door assembly to the combustion chamber (Figure 32).

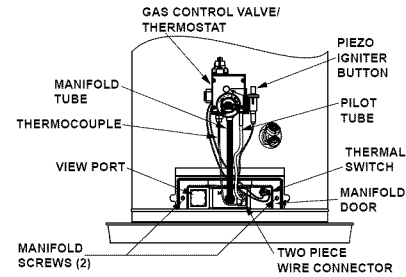

FIGURE 32.

6. Disconnect the thermocouple (right-hand thread), pilot tube, the igniter wire from the igniter button, the two connectors attached to the thermal switch, and manifold tube at the gas control valve/thermostat. (Figures 31 & 32.) **NOTE:** L.P. Gas systems use reverse (left-hand) threads on the manifold tube.
7. Grasp the manifold tube and push down slightly to free the manifold, pilot tube, and thermocouple.
8. Carefully remove the manifold/burner assembly from the burner compartment. **NOTE:** Be sure not to damage internal parts.

Removing the Burner from the Manifold/Burner Assembly

Natural Gas (Low Nox) & L.P. Gas Burner

1. Take off the burner by removing the two (2) screws located underneath the burner.
2. Check the burner to see if it is dirty or clogged. The burner may be cleaned with soap and hot water (Figure 33).

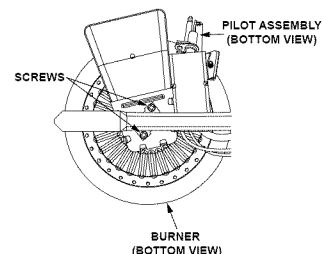

FIGURE 33.

Replacing the Thermocouple

1. Remove the manifold/burner assembly as directed previously.
2. Lift the retainer clip straight up from the back of the two piece wire connector (using a flat-blade screwdriver), then remove the two piece wire connector from the manifold door (Figure 34.)
3. Remove the burner. See "Removing the Burner from the Manifold/Burner Assembly."
4. Pull the thermocouple from the pilot assembly (Figure 35).

IMPORTANT: Be careful not to bend or alter the position of the pilot assembly components.

5. Insert the thermocouple tip into the holes provided in the pilot bracket until it clicks into place. **NOTE:** The base of the thermocouple must be flush with the base of the pilot bracket.

- Position the new thermocouple through the bottom opening of the two piece wire connector (Figure 34). Be sure igniter wire is positioned through the small opening of the two piece wire connector.
- Re-attach the burner. Note the orientation of the burner (Figure 33.)
- See "Replacing the Manifold/Burner Assembly."

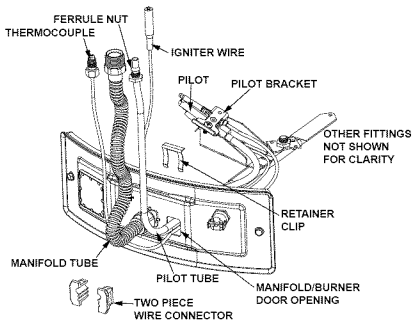

FIGURE 34.

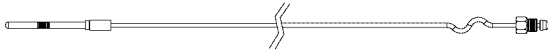

FIGURE 35.

Replacing the Pilot/ Pilot Tube Assembly

- Remove the manifold/burner assembly. See "Removing the Manifold/Burner Assembly."
- Lift the retainer clip straight up from the back of the two piece wire connector (using a flat-blade screwdriver), then remove the two piece wire connector from the manifold door (Figure 34.)

IMPORTANT: Be careful not to bend or alter the position of the pilot tube. It will be used as a bending template for the new pilot assembly.

- Take off the burner by removing the two (2) screws located underneath the burner. See Figure 33.
- Remove and keep the screw securing the pilot assembly to the pilot bracket. (Figure 36)
- Remove and keep the old pilot/pilot tube assembly.
- Using the old pilot/pilot tube assembly as a guide, bend the new pilot tube and new thermocouple to match the old ones. **NOTE:** Make only the bends closest to the pilot before going to the next step. (Figure 36)

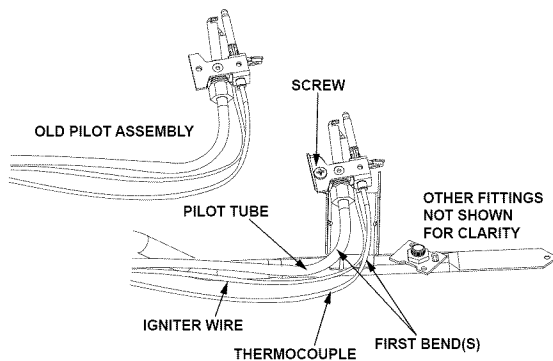

FIGURE 36.

- Route the new pilot tube, thermocouple, and igniter wire through the manifold/burner door opening. (Figure 34)
- Re-attach the pilot assembly to the pilot bracket and secure using the screw removed earlier.
- Position the new pilot tube through the largest opening of the two piece wire connector. **NOTE:** The largest opening should be located at the top position. The igniter wire should be located in the middle opening and thermocouple in the bottom opening. (Figure 37)

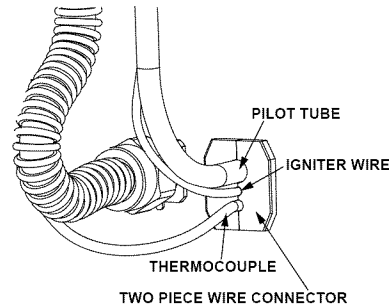

FIGURE 37.

- Reposition the two piece wire connector in the manifold door opening and secure it with the retainer clip.
- Carefully bend the new pilot tube and thermocouple to match the bend of the manifold tube. **NOTE:** When bending, **DO NOT** crimp or crease the pilot tube or thermocouple. (Figure 34)
- Before you proceed to the next step, install the new brass ferrule nut in the gas control valve/thermostat's pilot tube opening. **HAND TIGHTEN ONLY.**
- See "Replacing the Manifold/Burner Assembly."

Cleaning the Combustion Chamber and Flame-arrestor

- Follow procedure outlined in "Removing the Manifold/Burner Assembly."
- Use a vacuum cleaner/shop vac to remove all loose debris in the combustion chamber (Figure 38). Use compressed air to clear any dust or debris that may have accumulated in the flame-arrestor.

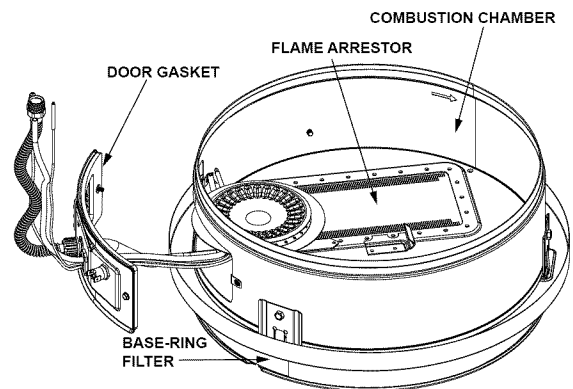

FIGURE 38.

- Reassemble by following the procedure under "Replacing the Manifold/Burner Assembly."

Replacing the Manifold/Burner Assembly

⚠ WARNING



Explosion Hazard

- Tighten both manifold door screws securely.
- Remove any fiberglass between gasket and combustion chamber.
- Replace viewport if glass is missing or damaged.
- Replace two piece wire connector if missing or removed.
- Replace door gasket if damaged.
- Failure to follow these instructions can result in death, explosion, or fire.

1. Check the door gasket for damage or imbedded debris prior to installation.
2. Inspect the view port for damage and replace as required.
3. Insert the manifold/burner assembly into the burner compartment, making sure that the tip of the manifold tube engages in the slot of the bracket inside the combustion chamber (Figures 39 & 40).
4. Inspect the door gasket and make sure there is no fiberglass insulation between the gasket and the combustion chamber.
5. Replace the two screws, which secure the manifold/burner assembly door to the combustion chamber and tighten securely. Once the manifold/burner assembly door is tightened, visually inspect the door gasket between the manifold/burner assembly door and the combustion chamber for spaces or gaps that would prevent a seal. **IMPORTANT:** Do not operate the water heater if the door gasket does not create a seal between the manifold door and the combustion chamber.
6. During the following procedure, do not cross-thread or apply any thread sealant to any of the fittings listed below. First, reconnect the manifold tubing to the gas control valve/thermostat. **NOTE:** L.P. gas systems use reverse (left-hand) threads on the manifold tube.

NOTE: If a ferrule nut needs to be installed for the pilot tube, locate the one provided with your parts kit. Install it in the gas control valve/thermostat at the pilot location, hand tight only.

Next, insert the pilot tube into the ferrule nut until it bottoms out. **NOTE:** Hold the tube in this position. Tighten the ferrule nut with a wrench until the crimp connection seals to the pilot tube. Continue to tighten until the nut is tight in the gas

control valve/thermostat. Finally, start the thermocouple nut and turn it all the way in by hand. An additional quarter turn with a 3/8" open-end wrench will then be sufficient to seat the lockwasher. When you are finished, connect the two wire leads that go to the thermal switch.

7. Reconnect the igniter wire.
8. Turn gas supply on and refer to the Lighting Instructions.
9. With the burner lit, check the gas control valve/thermostat supply line, two piece wire connector, manifold tube, and pilot tube connections for leaks. Check for leaks by brushing on an approved noncorrosive leak detection solution. Bubbles forming indicate a leak. Correct any leak found. **IMPORTANT:** All leaks must be fixed immediately.
10. Replace the outer door.

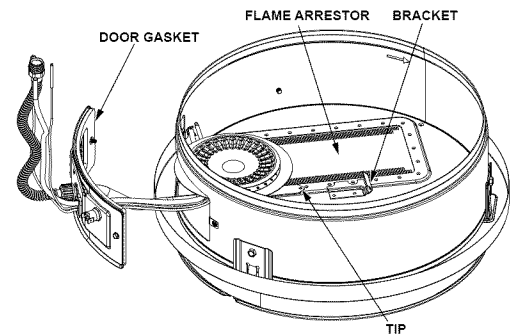

FIGURE 39.

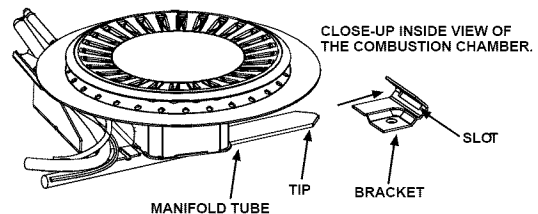
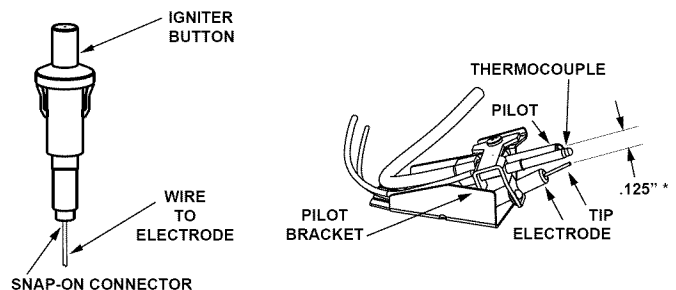

FIGURE 40.

Piezoelectric Igniter System

The piezoelectric igniter system consists of the igniter button, electrode, and wire. The pilot is ignited by an electric spark generated when the igniter button is pressed. The spark gap of 0.125 inch is set when the electrode is installed at the factory. (Figure 41). Use only factory authorized piezoelectric igniter parts for replacement.



* NOTE: SPARK GAP DISTANCE MEASURED FROM ELECTRODE TIP TO PILOT.

FIGURE 41.

Testing the Igniter System

Turn off the gas to the water heater at the manual gas shut-off valve. Watch the electrode tip while activating the igniter. A visible spark should jump from the electrode. To avoid shock, do not touch the burner or any metal part on the pilot or pilot assembly. If no spark is visible, check the wire connections and make sure the electrode is not broken. Replace the igniter if defective. Dirt and rust on the pilot or electrode tip can prevent the igniter spark. Wipe clean with a damp cloth and dry completely. Rust can be removed from the electrode tip and metal surfaces by lightly sanding with an emery cloth or fine grit sandpaper.

Removing and Replacing the Gas Control Valve/Thermostat

IMPORTANT: This water heater has a resettable thermal switch installed. Do not attempt to disable or modify this feature in any way. Use only factory authorized replacement parts.

Removing the Gas Valve:

1. Turn off the gas supply to the water heater at the manual gas shut-off valve. This valve is typically located beside the water heater. Note the position of the shut-off valve in the open/on position then proceed to turn it off (Figure 11).
2. On the lower front of the water heater, locate the gas control valve/thermostat (see Figure 32). Before performing any maintenance, it is important to turn the temperature dial on the gas control valve/thermostat to its lowest setting.
3. On top of the gas control valve/thermostat, turn the gas control knob to the "OFF" position. See Lighting Instructions on the water heater.
4. Drain the water heater. Refer to the section of "Draining and Flushing" section and follow the procedure.
5. Disconnect the igniter wire from the igniter. NOTE: There are two types of igniters. If you have the square igniter, slide the igniter bracket backwards away from the gas valve to remove it. If you have the round igniter, first remove the igniter from the bracket by depressing front and rear holding tabs and lift. Next, remove the igniter bracket from the gas valve. Disconnect the thermocouple (right-hand threads), pilot tube, and manifold tube at the gas control valve/thermostat (Figure 31). NOTE: L.P. gas systems use reverse (left-hand) threads on the manifold tube.
6. Refer to "Gas Piping" section (Figure 11) and disconnect the ground joint union in the gas piping. Disconnect the remaining pipe from the gas control valve/thermostat.
7. To remove the gas control valve/thermostat, thread a correctly sized pipe into the inlet and use it to turn the gas control valve/thermostat (counterclockwise.) Do not use a pipe wrench or equivalent to grip body. Damage may result, causing leaks.

Do not insert any sharp objects into the inlet or outlet connections. Damage to the gas control valve/thermostat may result.

Replacing the Gas Valve:

1. To replace the gas control valve/thermostat, reassemble in reverse order. When replacing the gas control valve/thermostat, thread a correctly sized pipe into the inlet and use it to turn the gas valve (clockwise.) DO NOT OVER TIGHTEN or damage may result. NOTE: Use an approved

TEFLON® tape or pipe compound only on the threaded section of the gas control valve/thermostat that screws into the tank.

2. Reconnect the gas piping to the gas control valve/thermostat. NOTE: Use an approved Teflon tape or pipe compound on the gas piping connections.
3. Attach the igniter and bracket to the new gas control valve/thermostat, clipping it at the back edge of thermostat and snapping it into place. NOTE: Do not use the (pilot) ferrule nut supplied with the new gas control valve/thermostat, unless the existing nut is not usable. Reconnect the pilot tube, manifold tube, igniter wire, and thermal switch wires. NOTE: L.P. gas systems use reverse (left-hand) threads on the manifold tube.
4. Fill the tank completely with water. NOTE: To purge the lines of any excess air, keep the hot water faucet open for 3 minutes after a constant flow of water is obtained.
5. Turn on the gas supply and test the gas supply connections by brushing on an approved noncorrosive leak detection solution. Bubbles forming indicate a leak. Correct any leak found.
6. Check the operation of the burner by following the lighting instructions on the front of the water heater. With the burner lit, check the gas control valve/thermostat supply line, manifold tube and pilot tube connections for leaks.
7. Verify proper operation and then replace the outer door.
8. If additional information is required, contact Residential Technical Assistance by referencing the number on the water heater.

TEFLON® is a registered trademark of E.I. Du Pont De Nemours and Company.

FVIR System Operational Checklist

1. Manifold gasket properly sealed.
2. Viewport not damaged or cracked.
3. Flame-arrestor free of debris and undamaged.
4. Two piece wire connector properly installed.
5. No leaks at pilot and manifold connection.
6. Manifold door screws securely tightened.
7. Depress the button on the thermal switch.

TROUBLESHOOTING GUIDE

Start Up Conditions

Thermal Expansion

CAUTION

Property Damage Hazard

- Avoid water heater damage.
- Install thermal expansion tank or device if necessary.
- Contact qualified installer or service agency.

As water is heated, it expands (thermal expansion). In a closed system, the volume of water will grow. As the volume of water grows, there will be a corresponding increase in water pressure due to thermal expansion. Thermal expansion can cause premature tank failure (leakage). This type of failure is not covered under the limited warranty. Thermal expansion can also cause intermittent temperature-pressure relief valve operation: water discharged from the valve due to excessive pressure build up. The temperature-pressure relief valve is not intended for the constant relief of thermal expansion. This condition is not covered under the limited warranty.

A properly sized thermal expansion tank should be installed on all closed systems to control the harmful effects of thermal expansion. Thermal expansion tanks are available from Sears stores and through the Sears Service Centers. Contact the local plumbing inspector, water supplier and/or the Sears Service Center for assistance in controlling these situations. See Figure 42.

TABLE 5
Thermal Expansion Tank Specifications

Model Number	Tank Capacity In Gallons	Dimensions in Inches		Pipe Fitting On Tank
		Diameter	Length	
153.331020	2	8 (203 mm)	12-3/4 (323 mm)	3/4" Male
153.331050	5	11 (279 mm)	14-3/4 (375 mm)	3/4" Male

TABLE 6
Expansion Tank Sizing Chart

Expansion Tank Capacity Needed	Inlet* Water Pressure	Water Heater Capacity (Gallons)				
		30	40	50	66	82
	40psi	2	2	2	5	5
	50psi	2	2	2	5	5
	60psi	2	2	5	5	5
	70psi	2	2	5	5	5
	80psi	2	5	5	5	5

*Highest recorded inlet water pressure in a 24 hour period or regulated water pressure.

NOTE: Expansion tanks are pre-charged with a 40 psi air charge. If the inlet water pressure is higher than 40 psi, the expansion tank's air pressure must be adjusted to match that pressure, but must not be higher than 80 psi.

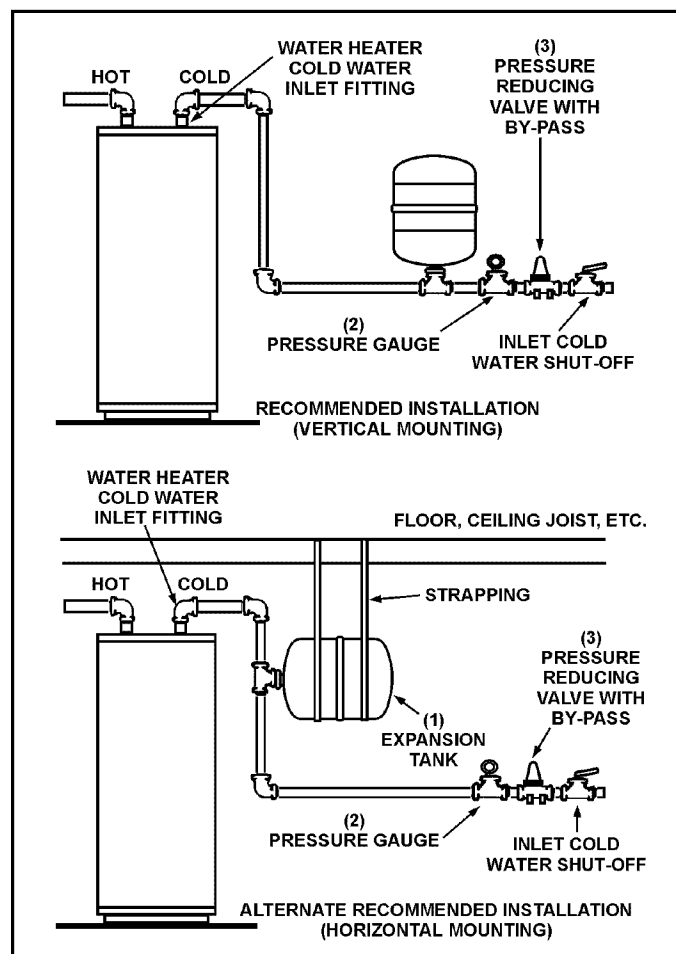

FIGURE 42.

Strange Sounds

Possible noises due to expansion and contraction of some metal parts during periods of heat-up and cool-down do not represent harmful or dangerous conditions.

Condensation causes sizzling and popping within the burner area during heating and cooling periods and should be considered normal. See "Condensation" section.

Draft Hood Operation

Check draft hood operation by performing a worst case depressurization of the building. With all doors and windows closed, and with all air handling equipment and exhaust fans operating such as furnaces, clothes dryers, range hoods and bathroom fans, a match flame should still be drawn into the draft hood of the water heater with its burner firing. If the flame is not

drawn toward the draft hood, shut off water heater and make necessary air supply changes to correct.

Condensation

Whenever the water heater is filled with cold water, some condensate will form while the burner is on. A water heater may appear to be leaking when in fact the water is condensation. This usually happens when:

- A new water heater is filled with cold water for the first time.
- Burning gas produces water vapor. In water heaters, particularly high efficiency models where flue temperatures are lower.
- Large amounts of hot water are used in a short time and the refill water in the tank is very cold.

Moisture from the products of combustion condense on the cooler tank surfaces and form drops of water which may fall onto the burner or other hot surfaces to produce a “sizzling” or “frying” noise.

Excessive condensation can cause pilot outage due to water running down the flue tube onto the main burner and putting out the pilot.

Because of the suddenness and amount of water, condensation water may be diagnosed as a “tank leak”. After the water in the tank warms up (about 1-2 hours), the condition should disappear.

Do not assume the water heater is leaking until there has been enough time for the water in the tank to warm up.

An undersized water heater will cause more condensation. The water heater must be sized properly to meet the family’s demands for hot water including dishwashers, washing machines and shower heads.

Excessive condensation may be noticed during the winter and early spring months when incoming water temperatures are at their lowest.

Good venting is essential for a gas fired water heater to operate properly as well as to carry away products of combustion and water vapor.

Smoke Odor

It is not uncommon to experience a small amount of smoke and odor during the initial start-up. This is due to burning off of oil from metal parts, and will disappear in a short while.

Operational Conditions

Smelly Odor

In each water heater there is installed at least one anode rod (see parts section) for corrosion protection of the tank. Certain water conditions will cause a reaction between this rod and the water. The most common complaint associated with the anode rod is one of a “rotten egg smell”. This odor is derived from hydrogen sulfide gas dissolved in the water. The smell is the

result of four factors which must all be present for the odor to develop:

- a concentration of sulfate in the supply water.
- little or no dissolved oxygen in the water.
- a sulfate reducing bacteria within the water heater. (This harmless bacteria is non-toxic to humans.)
- an excess of active hydrogen in the tank. This is caused by the corrosion protective action of the anode.

Smelly water may be eliminated or reduced in some water heater models by replacing the anode(s) with one of less active material, and then chlorinating the water heater tank and all hot water lines. Contact Sears Service for further information concerning this chlorination treatment and an anode replacement kit #9001453. (For short heaters, use anode replacement kit #9006299.) Anode replacement and chlorination of the tank are not covered by the water heater’s limited warranty.

If the smelly water persists after the anode replacement and chlorination treatment, it may be necessary to chlorinate or aerate your water supply to eliminate the problem.

Do not remove the anode, leaving the tank unprotected. By doing so, all warranty on the water heater tank is voided.

“AIR” In Hot Water Faucets

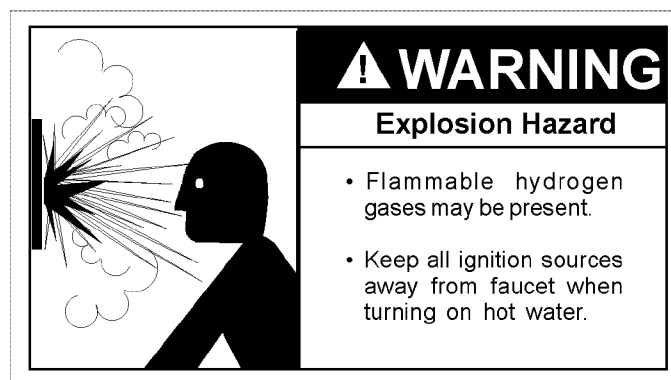

HYDROGEN GAS: Hydrogen gas can be produced in a hot water system that has not been used for a long period of time (generally two weeks or more). Hydrogen gas is extremely flammable and explosive. To prevent the possibility of injury under these conditions, we recommend the hot water faucet, located farthest away, be opened for several minutes before any electrical appliances which are connected to the hot water system are used (such as a dishwasher or washing machine). If hydrogen gas is present, there will probably be an unusual sound similar to air escaping through the pipe as the hot water faucet is opened. There must be no smoking or open flame near the faucet at the time it is open.

Safety Shut-off and Thermal Switch

This water heater is designed to automatically shut-off in the event of the following:

1. The pilot flame is extinguished for any reason.
2. The water temperature exceeds 195°F (91°C).
3. Excessive build up of dust on the base ring filter or flame arrestor. See Maintenance of your Water Heater Section.
4. The ignition of flammable vapors.

A thermocouple is used to determine if a pilot flame is present, and will shut off the gas supply to the main burner and the pilot

if the flame is absent. This unit is also equipped with a thermal switch, designed to shut off the gas supply in the event the water heater has been exposed to flammable vapors (e.g., spilled gasoline), poor combustion caused by a blocked vent or insufficient combustion air. If the thermal switch opens:

1. Check the flame-arrestor for signs of high temperature (blue or black discoloration). See Figure 38.
2. If there are signs of high temperature or that the thermal switch has opened, inspect your installation for problems with venting, combustion air supply, or a possible flammable vapor event. (See "Pilot Light Troubleshooting Flowchart" section.) Correct any issues prior to resetting the thermal switch. If you suspect a flammable vapor incident has occurred, do not use this appliance. Immediately call a qualified technician to inspect the appliance. Water heaters subjected to a flammable vapors ignition will require replacement of the entire water heater.
3. Reset the thermal switch by depressing the small button in the center of the thermal switch. Follow the Lighting Instructions found on the front of your water heater. A high temperature limit switch or ECO (Energy Cut Off) in the tank is used to shut off the unit if the water temperature exceeds 195°F (91°C). The ECO is a single-use switch, which, if activated, requires complete replacement of the entire gas control valve/thermostat. If the ECO should activate, the water heater cannot be used until the gas control valve/thermostat is replaced by a qualified technician. Contact Sears at 1-800-4-MY-HOME (1-800-469-4663) to request service.

Leakage Checkpoints

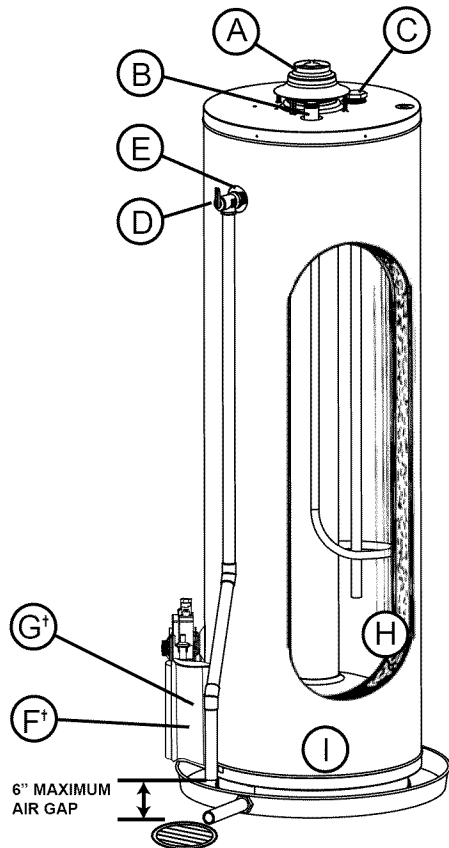

† DRAIN VALVE LOCATED BEHIND OUTER DOOR.

FIGURE 43.

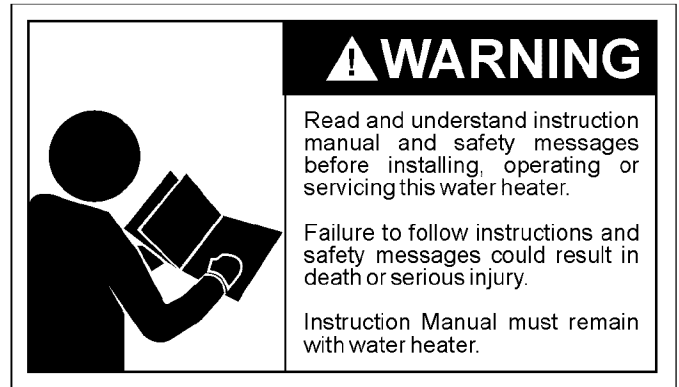

Read this manual first. Then, before checking the water heater, make sure the gas supply has been turned "OFF", and never turn the gas "ON" before the tank is completely full of water.

Never use this water heater unless it is completely filled with water. To prevent damage to the tank, the tank must be filled with water. Water must flow from the hot water faucet before turning "ON" gas to the water heater.

- A. Water at the draft hood is water vapor which has condensed out of the combustion products. This is caused by a problem in the vent. Contact a qualified technician.
- B. *Condensation may be seen on pipes in humid weather or pipe connections may be leaking.
- C. *The anode rod fitting may be leaking.
- D. Small amounts of water from temperature-pressure relief valve may be due to thermal expansion or high water pressure in your area.
- E. *The temperature-pressure relief valve may be leaking at the tank fitting.
- F. Water from a drain valve may be due to the valve being slightly opened.
- G. *The drain valve may be leaking at the tank fitting.
- H. Combustion products contain water vapor which can condense on the cooler surfaces of the tank. Droplets form and drip onto the burner or run on the floor. This is common at the time of start-up after installation and when incoming water is cold.
- I. Water in the water heater bottom or on the floor may be from condensation, loose connections, or the relief valve. DO NOT replace the water heater until a full inspection of all possible water sources is made and necessary corrective steps taken.

Leakage from other appliances, water lines, or ground seepage should also be checked.

* To check where threaded portion enters tank, insert cotton swab between jacket opening and fitting. If cotton is wet, follow draining instructions in the "Draining and Flushing" section and then remove fitting. Put pipe dope or teflon tape on the threads and replace. When you are finished, follow the steps in "Filling the Water Heater" in the Installation Instructions earlier in this manual.

TROUBLESHOOTING CHART

PROBLEM	POSSIBLE CAUSE(S)	CORRECTIVE ACTION
BURNER WILL NOT IGNITE	<ol style="list-style-type: none"> Pilot not lit Thermostat set too low No gas Dirt in the gas lines Pilot line clogged Main burner line clogged Non-functioning thermocouple Non-functioning thermostat Heater installed in a confined area 	<ol style="list-style-type: none"> Light pilot Turn temp. dial to desired temperature Check with gas utility company Notify utility-install trap in gas line Clean, locate source and correct Clean, locate source and correct Replace thermocouple Replace thermostat Provide fresh air ventilation
SMELLY WATER	<ol style="list-style-type: none"> Sulfides in the water 	<ol style="list-style-type: none"> Replace the anode with a special anode
BURNER FLAME YELLOW-LAZY	<ol style="list-style-type: none"> Insufficient secondary air Low gas pressure Water heater flue or vent system blocked Main burner line clogged Heater installed in a confined area Obstruction in main burner orifice 	<ol style="list-style-type: none"> Provide ventilation to water heater Check with gas utility company Clean, locate source and correct Clean, locate source and correct Proper fresh air ventilation Clean or replace orifice
PILOT WILL NOT LIGHT OR REMAIN LIT	<ol style="list-style-type: none"> Non-functioning igniter The thermal switch tripped Wire lead connection at thermal switch loose Thermocouple connection loose Air in gas line Low gas pressure No gas Dirt in gas lines Cold drafts Thermostat ECO switch open Pilot line or orifice clogged Non-functioning thermocouple Air for combustion obstructed Flammable vapors incident, FVIR function actuated Base-ring filter obstructed 	<ol style="list-style-type: none"> Replace igniter pilot assembly See Pilot Light Troubleshooting Flowchart section Remove and reconnect the wire leads at thermal switch, confirm connections are tight and not loose Finger tighten; then 1/4 turn with wrench Bleed the air from the gas line Check with gas utility company Check with gas utility company Notify utility-install dirt trap in gas line Locate source and correct Replace thermostat Clean, locate source and correct Replace thermocouple See maintenance section for inspection and cleaning of flame arrester Replace water heater, eliminate flammable vapors source. Contact Sears Service. Inspect and clean base-ring filter. See "External Cleaning & Inspection of the Base-Ring Filter."
HIGH OPERATION COSTS	<ol style="list-style-type: none"> Thermostat set too high Sediment or lime in tank Water heater too small for job Wrong piping connections Leaking faucets Gas leaks Wasted hot water Long runs of exposed piping Hot water piping in exposed wall 	<ol style="list-style-type: none"> Set temperature dial to lower setting Drain/flush-provide water treatment if needed Install adequate heater Correct piping-dip tube must be in cold inlet Repair faucets Check with utility-repair at once Advise customer Insulate piping Insulate piping
INSUFFICIENT HOT WATER	<ol style="list-style-type: none"> Thermostat set too low Sediment or lime in tank Water heater too small Wrong piping connections Leaking faucets Wasted hot water Long runs of exposed piping Hot water piping in outside wall Low gas pressure 	<ol style="list-style-type: none"> Turn temperature dial to desired setting Drain/flush-provide water treatment if needed Install adequate heater Correct piping-dip tube must be in cold inlet Repair faucets Advise customer Insulate piping Insulate piping Check with gas utility company
SLOW HOT WATER RECOVERY	<ol style="list-style-type: none"> Insufficient secondary air Water heater flue or vent system blocked Low gas pressure Improper calibration Thermostat set too low Water heater too small Wrong piping connections Wasted hot water 	<ol style="list-style-type: none"> Provide ventilation to water heater. Check flue way, flue baffle, and burner Clean flue, locate source and correct Check with gas utility company Replace thermostat Turn temperature dial to desired setting Install adequate heater Correct piping-dip tube must be in cold inlet Advise customer
DRIP FROM RELIEF VALVE	<ol style="list-style-type: none"> Excessive water pressure Heater stacking Closed water system 	<ol style="list-style-type: none"> Use a pressure reducing valve and relief valve Lower the thermostat setting See "Closed System/Thermal Expansion"

TROUBLESHOOTING CHART (CONTINUED)

PROBLEM	POSSIBLE CAUSE(S)	CORRECTIVE ACTION
THERMOSTAT FAILS TO SHUT-OFF	<ol style="list-style-type: none"> 1. Thermostat not functioning properly 2. Improper calibration 	<ol style="list-style-type: none"> 1. Replace thermostat 2. Replace thermostat
COMBUSTION ODORS	<ol style="list-style-type: none"> 1. Insufficient secondary air 2. Water heater flue or vent system blocked 3. Heater installed in a confined area 	<ol style="list-style-type: none"> 1. Provide ventilation to water heater. Check flue way, flue baffle, and burner 2. Clean, locate source and correct 3. Provide fresh air ventilation
SMOKING AND CARBON FORMATION (SOOTING)	<ol style="list-style-type: none"> 1. Insufficient secondary air 2. Low gas pressure 3. Water heater flue or vent system blocked 4. Thermostat not functioning properly 5. Heater installed in a confined area 6. Burner flame yellow-lazy 	<ol style="list-style-type: none"> 1. Provide ventilation to water heater. Check flue way, flue baffle, burner 2. Check with gas utility company 3. Clean, locate source and correct 4. Replace thermostat 5. Provide fresh air ventilation 6. See "Burner Flame Yellow-Lazy"
CONDENSATION	<ol style="list-style-type: none"> 1. Temperature setting too low 	<ol style="list-style-type: none"> 1. Increase the temperature setting. Refer to the "Condensation" sub-section of this manual's Troubleshooting Guide.
BURNER FLAME FLOATS AND LIFTS OFF PORTS	<ol style="list-style-type: none"> 1. Orifice too large 2. High gas pressure 3. Water heater flue or vent system blocked 4. Cold drafts 	<ol style="list-style-type: none"> 1. Replace with correct orifice 2. Check with gas utility company 3. Clean flue and burner-locate source and correct 4. Locate source and correct
BURNER FLAME TOO HIGH	<ol style="list-style-type: none"> 1. Orifice too large 	<ol style="list-style-type: none"> 1. Replace with correct orifice
FLAME BURNS AT ORIFICE	<ol style="list-style-type: none"> 1. Thermostat not functioning properly 2. Low gas pressure 	<ol style="list-style-type: none"> 1. Replace thermostat 2. Check with gas utility company
PILOT FLAME TOO SMALL	<ol style="list-style-type: none"> 1. Pilot line or orifice clogged 2. Low gas pressure 	<ol style="list-style-type: none"> 1. Clean, locate source and correct 2. Check with gas utility company

PILOT LIGHT TROUBLESHOOTING FLOWCHART

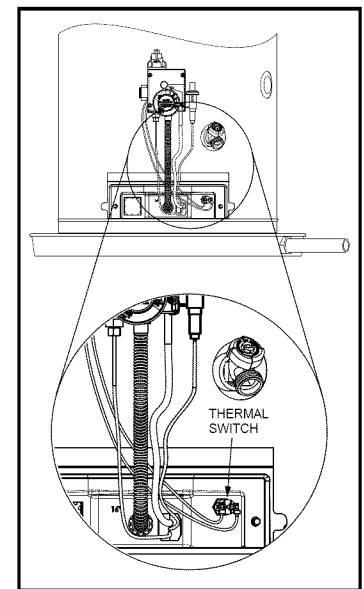
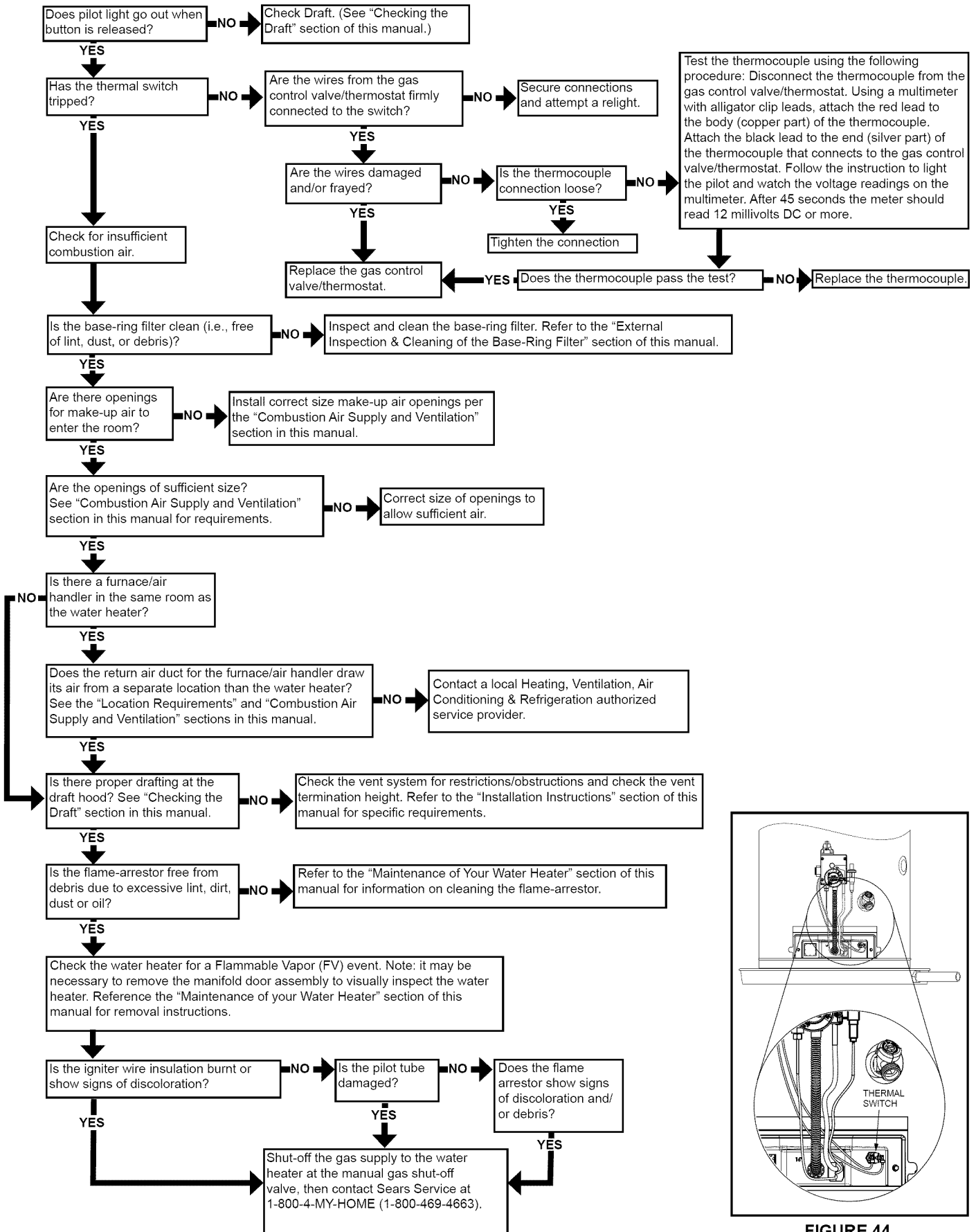

FIGURE 44.

PARTS ORDER LIST

POWER MISER™ 9 GAS WATER HEATER

MODEL NUMBERS

153.339270	40 Gallon Short (Natural)
153.339492	40 Gallon Tall (Natural)
153.339530	50 Gallon Tall (Natural)

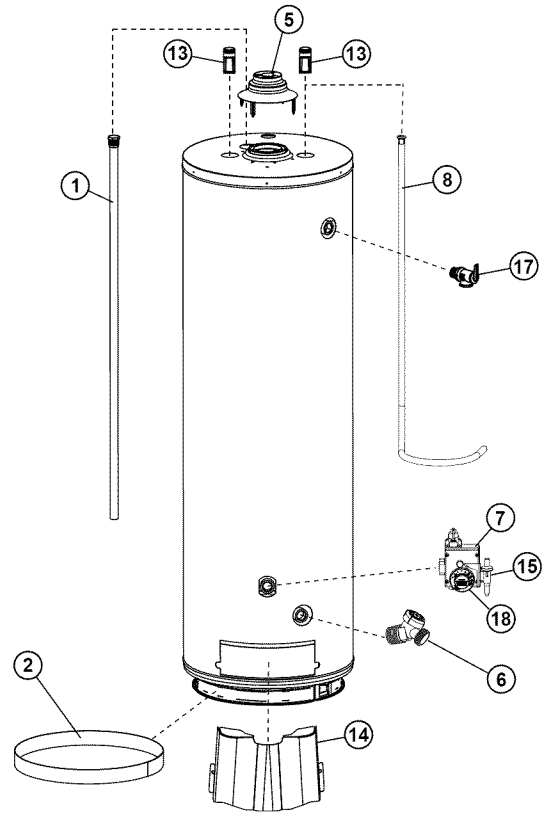
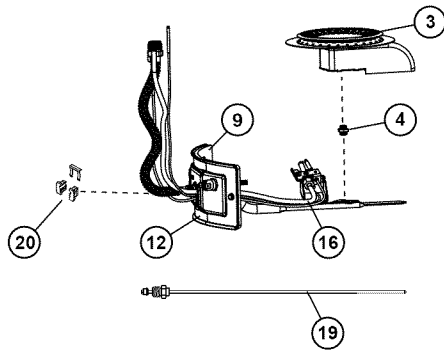

Key No.	Part Description	153.339270	153.339492	153.339530
1	Anode Rod	9003721	9003721	9001829
2	Base-Ring Filter	9006660	9006616	9006660
3	Burner Head	9006136	9006136	9006136
4	Burner Orifice	9006698	9006698	9006698
5	Draft Hood	9006647	9006647	9006647
6	Drain Valve	9000058	9000058	9000058
7	Gas Control Valve	F145-1554	F145-1554	F145-1554
8	Inlet Tube w/ Gasket	9006803	9006798	9006804
9	Inner Door Gasket	9006141	9006141	9006141
10	Instruction Manual *	315424-000	315424-000	315424-000
11	Mag-Erad *	23600	23600	23600
12	Manifold Door Assembly - Contains: Manifold Tube, Gasket, Door, Pilot Tube, Thermocouple, Two-Piece Wire Connector w/ Clip, Thermal Switch and Pilot Assembly.	9006619	9006620	9006621
13	Nipple w/Heat Trap	9003719	9003719	9003719
14	Outer Door	9006649	9006649	9006649
15	Piezo Igniter w/ Clip	9006143	9006143	9006143
16	Pilot Assembly w/ Tubing and Fittings	9006666	9006666	9006666
17	T & P Relief Valve	9000728	9000728	9000728
18	Temperature Adjustment Knob	F145-1280	F145-1280	F145-1280
19	Thermocouple	9000056	9000056	9000056
20	Two-Piece Wire Connector w/ Clip	9006449	9006449	9006449

* Not Shown.

Now that you have purchased your gas water heater, should a need ever exist for repair parts or service, simply contact any Sears Service Center or call 1-800-4-MY-HOME® (1-800-469-4663). Be sure to provide all pertinent facts when you call or visit.

- MODEL NUMBER
- SERIAL NUMBER
- TYPE GAS - NATURAL OR PROPANE (L.P.)
- PART DESCRIPTION

WHEN ORDERING REPAIR PARTS, ALWAYS GIVE THE FOLLOWING INFORMATION:

THIS IS A REPAIR PARTS LIST, NOT A PACKING LIST.

Get it fixed, at your home or ours!

Your Home

For expert troubleshooting and home solutions advice:

manage my home

www.managemyhome.com

For repair – **in your home** – of **all** major brand appliances, lawn and garden equipment, or heating and cooling systems, **no matter who made it, no matter who sold it!**

For the replacement parts, accessories and owner's manuals that you need to do-it-yourself.

For Sears professional installation of home appliances and items like garage door openers and water heaters.

1-800-4-MY-HOME® (1-800-469-4663)

Call anytime, day or night (U.S.A. and Canada)

www.sears.com www.sears.ca

Our Home

For repair of carry-in items like vacuums, lawn equipment, and electronics, call anytime for the location of your nearest

Sears Parts & Repair Service Center

1-800-488-1222 (U.S.A.)

www.sears.com

1-800-469-4663 (Canada)

www.sears.ca

To purchase a protection agreement on a product serviced by Sears:

1-800-827-6655 (U.S.A.)

1-800-361-6665 (Canada)

Para pedir servicio de reparación a domicilio, y para ordenar piezas:

1-888-SU-HOGAR®

(1-888-784-6427)

Au Canada pour service en français:

1-800-LE-FOYER^{MC}

(1-800-533-6937)

www.sears.ca

Sears