



GAS RANGE

Slide-in models

Use & Care Guide

ESTUFA A GAS

Modelos deslizables

Manual del Usuario

Models, modelos 790.3103*, 790.3104*

*** = color number, número de color**

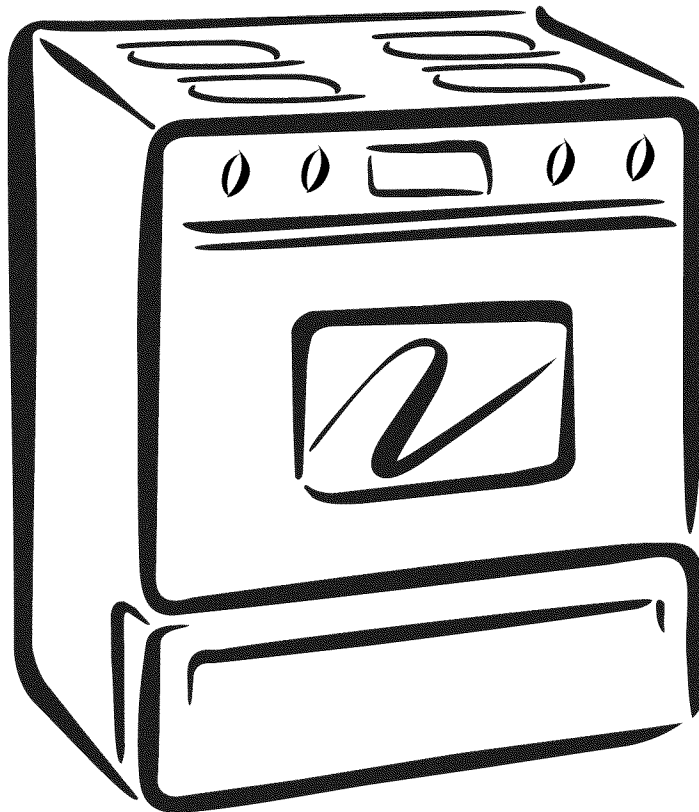

ENGLISH

ESPAÑOL

Table of Contents

Slide-in Range Warranty	2	Surface Cooking	13-14
IMPORTANT SAFETY INSTRUCTIONS	3-5	Before Setting Oven Controls	14-15
Product Record	5	Air Circulation in the Oven	15
Serial Plate Location	5	Control Pad Features	16
Protection Agreements	6	Minimum and Maximum Control Pad Settings	16
Grounding Instructions	7	Setting Oven Controls	17-35
Conversion to Liquefied Petroleum Gas	7	Setting Warmer Drawer Controls	36-37
Range Features	8	Self-Cleaning	38-41
Before Setting Surface Controls	9-10	Adjusting Oven Temperature	41
Setting Surface Controls	11-12	General Care & Cleaning	42-45
		Before You Call	46-47
		Sears Service	48

Please carefully read and save these instructions

This Use & Care Manual contains general operating instructions for your appliance and feature information for several models. Your product **may not** have all the described features. The graphics shown are representative. The graphics on your appliance may not look exactly like those shown. Common sense and caution must be practiced when installing, operating and maintaining any appliance.

Kenmore Elite Warranty

When installed, operated and maintained according to all instructions supplied with the product, if this appliance fails due to a defect in material and workmanship within one year from the date of purchase, call 1-800-4-MY-HOME® to arrange for free repair.

This warranty applies for only 90 days from the date of purchase if this appliance is ever used for other than private family purposes.

This warranty covers only defects in material and workmanship. Sears will NOT pay for:

1. Cracks in a ceramic glass cooktop that are not a result of thermal shock.
2. Stains and scratches on a ceramic glass cooktop resulting from accident or improper operation or maintenance.
3. Expendable items that can wear out from normal use, including but not limited to filters, belts, light bulbs, and bags.
4. A service technician to instruct the user in correct product installation, operation or maintenance.
5. A service technician to clean or maintain this product.
6. Damage to or failure of this product if it is not installed, operated or maintained according to the all instructions supplied with the product.
7. Damage to or failure of this product resulting from accident, abuse, misuse or use for other than its intended purpose.
8. Damage to or failure of this product caused by the use of detergents, cleaners, chemicals or utensils other than those recommended in all instructions supplied with the product.
9. Damage to or failure of parts or systems resulting from unauthorized modifications made to this product.

Disclaimer of implied warranties; limitation of remedies

Customer's sole and exclusive remedy under this limited warranty shall be product repair as provided herein. Implied warranties, including warranties of merchantability or fitness for a particular purpose, are limited to one year or the shortest period allowed by law. Sears shall not be liable for incidental or consequential damages. Some states and provinces do not allow the exclusion or limitation of incidental or consequential damages, or limitation on the duration of implied warranties of merchantability or fitness, so these exclusions or limitations may not apply to you.

This warranty applies only while this appliance is used in the United States or Canada.

This warranty gives you specific legal rights, and you may also have other rights which vary from state to state.

Sears, Roebuck and Co., Hoffman Estates, IL 60179
Sears Canada Inc., Toronto, Ontario, Canada M5B 2B8

Important Safety Instructions



Read all instructions before using this appliance.
Save these instructions for future reference.

This manual contains many important safety messages. Always read and obey all safety messages.

The safety symbol  calls your attention to safety messages that inform you of hazards that can kill or hurt you or others, or cause damage to the product.

⚠ WARNING Indicates an imminently hazardous situation which, if not avoided may result in death or serious injury.

⚠ CAUTION Indicates an imminently hazardous situation which, if not avoided may result in minor or moderate injury, or product damage.

All safety messages will identify the hazard, tell you how to reduce the chance of injury, and tell you what can happen if the instructions are not followed.

⚠ WARNING If the information in this manual is not followed exactly, a fire or explosion may result causing property damage, personal injury or death.

FOR YOUR SAFETY:

- Do not store or use gasoline or other flammable vapors and liquids in the vicinity of this or any other appliance.
- **WHAT TO DO IF YOU SMELL GAS:**
 - Do not try to light any appliance.
 - Do not touch any electrical switch; do not use any phone in your building.
 - Immediately call your gas supplier from a neighbor's phone. Follow the gas supplier's instructions.
 - If you cannot reach your gas supplier, call the fire department.
- Installation and service must be performed by a qualified installer, servicer or the gas supplier.



⚠ WARNING

- All ranges can tip.
- Injury to persons could result.
- Install anti-tip device packed with range.
- See Installation Instructions.



⚠ WARNING

To reduce the risk of tipping, the range must be secured by properly installed anti-tip bracket(s) provided with the range. To check if the bracket(s) is installed properly, remove the lower panel or storage drawer and verify that the anti-tip bracket(s) is engaged. Refer to the Installation Instructions for proper anti-tip bracket(s) installation.

- **Remove all tape and packaging before using the range.** Destroy the carton and plastic bags after unpacking the range. Never allow children to play with packaging material.
- **Proper Installation—Be sure your appliance is properly installed and grounded by a qualified technician in accordance with the National Fuel Gas Code ANSI Z223.1 latest edition, and National Electrical Code ANSI/NFPA No. 70—latest edition, and local code requirements.** Install only per installation instructions provided in the literature package for this range.

Sears Parts & Repair is the recommended repair service for this appliance. Know how to disconnect the power to the range at the circuit breaker or fuse box and gas supply at the main shutoff valve in case of an emergency. Remove the drawer to access the valve.

- **User servicing—Do not repair or replace any part of the appliance unless specifically recommended in the manuals.** All other servicing should be done only by a qualified technician. This may reduce the risk of personal injury and damage to the range.
- **Never modify or alter the construction of a range by removing leveling legs, panels, wire covers, anti-tip brackets/screws, or any other part of the product.**

⚠ WARNING Stepping, leaning or sitting on the door or drawer of this range can result in serious injuries and

also cause damage to the range. Do not allow children to climb or play around the range. The weight of a child on an open door may cause the range to tip, resulting in serious burns or other injury. An open drawer, when hot, may cause burns.

⚠ WARNING Do not use the oven or warmer drawer (if equipped) for storage.

⚠ CAUTION Do not store items of interest to children in the cabinets above a range. Children climbing on the range to reach items could be seriously injured.

⚠ WARNING NEVER use this appliance as a space heater to heat or warm the room. Doing so may result in carbon monoxide poisoning and overheating of the oven.

- **Storage in or on Appliance—Flammable materials should not be stored in an oven, near surface burners or in the drawer (if equipped).** This includes paper, plastic and cloth items, such as cookbooks, plasticware and towels, as well as flammable liquids. Do not store explosives, such as aerosol cans, on or near the appliance. Flammable materials may explode and result in fire or property damage.
- **Do not leave children alone—Children should not be left alone or unattended in the area where appliance is in use.** They should never be allowed to sit or stand on any part of the appliance.
- **DO NOT TOUCH SURFACE BURNERS, AREAS NEAR THESE BURNERS, OVEN HEATING ELEMENTS OR**

Important Safety Instructions

INTERIOR SURFACES OF THE OVEN OR WARMER DRAWER (if equipped). Both surface burners and oven heating elements may be hot even though they are dark in color. Areas near surface burners may become hot enough to cause burns. During and after use, do not touch, or let clothing or other flammable materials touch these areas until they have had sufficient time to cool. Among these areas are the cooktop, surfaces facing the cooktop, the oven vent openings and surfaces near these openings, oven door and window.

- **Wear proper apparel—Loose-fitting or hanging garments should never be worn while using the appliance.** Do not let clothing or other flammable materials contact hot surfaces.
- **Do not use water or flour on grease fires—Smother the fire with a pan lid, or use baking soda, a dry chemical or foam-type extinguisher.**
- **When heating fat or grease, watch it closely.** Fat or grease may catch fire if allowed to become too hot.

⚠ WARNING In case of fire or gas leak, be sure to turn off the main gas shutoff valve.

- **Use only dry potholders—Moist or damp potholders on hot surfaces may result in burns from steam.** Do not let potholders touch hot heating elements. Do not use a towel or other bulky cloth instead of a potholder.
- **Do not heat unopened food containers—Buildup of pressure may cause container to burst and result in injury.**
- **Remove the oven door from any unused range if it is to be stored or discarded.**

IMPORTANT—Do not attempt to operate the oven during a power failure. If the power fails, always turn the oven off. If the oven is not turns off and the power resumes, the oven may begin to operate again. Food left unattended could catch fire or spoil.

⚠ WARNING Use proper flame size—Adjust flame size so it does not extend beyond the edge of the utensil. The use of undersize utensils will exposed a portion of the burner flame to direct contact and may result in ignition of clothing. Proper relationship of utensil to flame will also improve efficiency.

⚠ WARNING Do not use stove top grills on the burner grates of sealed gas burners. If you use a stove top grill on a sealed gas burner, it will cause incomplete combustion and can result in exposure to carbon monoxide levels above allowable current standards. This can be hazardous to your health.

⚠ CAUTION Electronic controllers can be damaged by cold temperatures. When you use your appliance for the first time, or if it has not been used for a long period of time, make sure that it has been exposed to a temperature above 0°C/32°F for at least 3 hours before

connecting it to the power supply.

IMPORTANT INSTRUCTIONS FOR USING YOUR COOKTOP

- **Know which knob controls each surface heating unit.** Always turn the knob to the LITE position when igniting the burners. Visually check that burner has lit. Then adjust the flame so it does not extend beyond the edge of the utensil.
- **Use proper pan size.** This appliance is equipped with one or more surface burners of different sizes. Select utensils having flat bottoms large enough to cover the surface burner. The use of undersized utensils will expose a portion of the surface burner to direct contact and may result in ignition of clothing. Proper relationship of utensil to the surface burner will also improve efficiency.
- **Utensil handles should be turned inward and not extend over adjacent surface burners—**To reduce the risk of burns, ignition of flammable materials, and spillage due to unintentional contact with the utensil. The handle of the utensil should be positioned so that it is turned inward, and does not extend over adjacent surface burners.
- **Never leave surface burners unattended at high heat settings—**Boilovers cause smoking and greasy spillovers that may ignite, or a pan that has boiled dry may melt.
- **Protective liners—**Do not use aluminum foil to line oven bottom or any other part of the appliance. Only use aluminum foil as recommended for baking if used as a cover placed on the food. Any other use of protective liners or aluminum foil may result in a risk of electric shock or fire or short circuit.
- **Glazed cooking utensils—**Only certain types of glass, glass/ceramic, ceramic, earthenware, or other glazed utensils are suitable for rangetop service without breaking due to the sudden change in temperature. Check the manufacturer's recommendations for rangetop use.
- **Do not use decorative surface burner covers.** If a burner is accidentally turned on, the decorative cover will become hot and possibly melt. Burns will occur if the hot covers are touched. Damage may also be done to the cooktop or burners because the covers may cause overheating. Air will be blocked from the burner and cause combustion problems.

FOR GLASS COOKTOPS ONLY

- **Do not clean or operate a broken cooktop—**If cooktop should break, cleaning solutions and spillovers may penetrate the broken cooktop and create a risk of electric shock. Contact a qualified technician immediately.
- **Clean cooktop glass with caution—**If a wet sponge or cloth is used to wipe spills on a hot cooking area, be

Important Safety Instructions

careful to avoid a steam burn. Some cleaners can produce harmful fumes if applied to a hot surface.

- **Avoid scratching the cooktop glass with sharp objects.**

IMPORTANT INSTRUCTIONS FOR USING YOUR OVEN

- **Use care when opening oven door or warmer drawer (if equipped)**—Stand to the side of the range when opening the door of a hot oven. Let hot air or steam escape before you remove or replace food in the oven/warmer drawer.
- **Keep oven vent ducts unobstructed.** The oven vent is located at the rear of the cooktop. Touching the surfaces in this area when the oven is operating may cause severe burns. Also, do not place plastic or heat-sensitive items on or near the oven vent. These items could melt or ignite.

⚠ WARNING NEVER cover any slots, holes or passages in the oven bottom or cover an entire rack materials such as aluminum foil. Doing so blocks air flow through the oven and may cause carbon monoxide poisoning. Aluminum foil linings may trap heat, causing a fire hazard.

- **Placement of oven/warmer drawer (if equipped) racks.** Always place oven racks in desired location while oven/warmer drawer (if equipped) is cool. If rack must be moved while oven is hot use extreme caution. Use potholders and grasp the rack with both hands to reposition. Do not let potholders contact the hot heating elements in the oven/warmer drawer (if equipped). Remove all utensils from the rack before moving.
- **Do not use the broiler pan without its insert.** The broiler pan and its insert allow dripping fat to drain and be kept away from the high heat of the broiler.
- **Do not cover the broiler insert with aluminum foil.** Exposed fat and grease could ignite.
- **Do not touch a hot light bulb with a damp cloth.** Doing so could cause the bulb to break. Disconnect the

appliance or turn off the power to the appliance before removing and replacing light bulb.

IMPORTANT INSTRUCTIONS FOR CLEANING YOUR RANGE

- **Clean the range regularly to keep all parts free of grease that could catch fire.** Exhaust fan ventilation hoods and grease filters should be kept clean. Do not allow grease to accumulate on hood or filter. Greasy deposits in the fan could catch fire. When you are flaming food under the hood, turn the fan on. Refer to the hood manufacturer's instructions for cleaning.

SELF CLEANING OVENS

- **In the self-Cleaning cycle only clean the parts listed in this Use and Care Guide.** Before self cleaning the oven, remove the broiler pan and any utensils or foods from the oven.
- **Do not use oven cleaners**—No commercial oven cleaner or oven liner protective coating of any kind should be used in or around any part of the oven.
- **Do not clean door gasket**—The door gasket is essential for a good seal. Care should be taken not to rub, damage or move the gasket.
- **Remove oven racks.** Oven racks color will change if left in the oven during a self-cleaning cycle.
- **⚠ CAUTION** The health of some birds is extremely sensitive to the fumes given off during the self-cleaning cycle of the range. Move the birds to another well ventilated room.

ENGLISH

Important Safety Notice

The California Safe Drinking Water and Toxic Enforcement Act requires the Governor of California to publish a list of substances known to the state to cause cancer, birth defects or other reproductive harm, and requires businesses to warn customers of potential exposure to such substances.

Product Record

In this space below, record the date of purchase, model and serial number of your product. You will find the model and serial number printed on the serial plate.

Model No. 790.

Serial No. _____

Date of purchase _____

Save these instructions and your sales receipt for future reference.

Serial Plate Location

You will find the model and serial number printed on the serial plate. The serial plate is located as shown below. Remember to record the serial number for future reference.

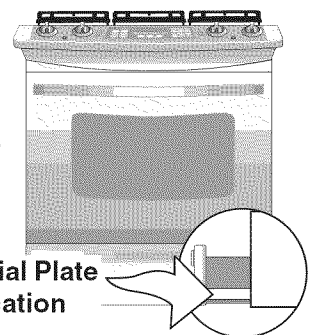

PROTECTION AGREEMENTS

Master Protection Agreements

Congratulations on making a smart purchase. Your new Kenmore® product is designed and manufactured for years of dependable operation. But like all products, it may require preventive maintenance or repair from time to time. That's when having a Master Protection Agreement can save you money and aggravation.

The Master Protection Agreement also helps extend the life of your new product. Here's what the Agreement* includes:

- ☑ **Parts and labor** needed to help keep products operating properly **under normal use**, not just defects. Our coverage goes **well beyond the product warranty**. No deductibles, no functional failure excluded from coverage – **real protection**.
- ☑ **Expert service** by a force of more than **10,000 authorized Sears service technicians**, which means someone you can trust will be working on your product.
- ☑ **Unlimited service calls and nationwide service**, as often as you want us, whenever you want us.
- ☑ **«No-lemon» guarantee** – replacement of your covered product if four or more product failures occur within twelve months.
- ☑ **Product replacement** if your covered product can't be fixed.
- ☑ **Annual Preventive Maintenance Check** at your request – no extra charge.
- ☑ **Fast help by phone** – we call it **Rapid Resolution** – phone support from a Sears representative on all products. Think of us as a «talking owner's manual».
- ☑ **Power surge protection** against electrical damage due to power fluctuations.
- ☑ **\$250 Food Loss Protection** annually for any food spoilage that is the result of mechanical failure of any covered refrigerator or freezer.
- ☑ **Rental reimbursement** if repair of your covered product takes longer than promised.
- ☑ **10% discount** off the regular price of any non-covered repair service and related installed parts.

Once you purchase the Agreement, a simple phone call is all that it takes for you to schedule service. You can call anytime day or night, or schedule a service appointment online.

The Master Protection Agreement is a risk free purchase. If you cancel for any reason during the product warranty period, we will provide a full refund. Or, a prorated refund anytime after the product warranty period expires. Purchase your Master Protection Agreement today!

Some limitations and exclusions apply. For prices and additional information in the U.S.A. call 1-800-827-6655.

*** Coverage in Canada varies on some items. For full details call Sears Canada at 1-800-361-6665.**

Sears Installation Service

*For Sears professional installation of home appliances, garage door openers, water heaters, and other major home items, in the U.S.A. or Canada call **1-800-4-MY-HOME**®.*

Acuerdos maestros de protección

Enhorabuena por haber hecho una compra inteligente. Su nuevo producto Kenmore® está diseñado y fabricado para brindarle años de funcionamiento fiable. Pero, como cualquier producto, puede necesitar mantenimiento preventivo o reparaciones periódicas. Es por eso que tener un Acuerdo maestro de protección podría ahorrarle dinero y molestias.

El Acuerdo maestro de protección también sirve para prolongar la durabilidad de su nuevo producto. El acuerdo* incluye lo siguiente:

- ☑ **Piezas y mano de obra** necesarias para contribuir a mantener el funcionamiento adecuado de los productos **utilizados en condiciones normales de uso**, no sólo en caso de defectos de los productos. Nuestra cobertura va **mucho más allá que la garantía del producto**. No se aplican deducibles ni exclusiones por fallas del funcionamiento: es decir, **verdadera protección**.
- ☑ **Servicio técnico por expertos** (más de **10000 técnicos autorizados de Sears**), lo cual significa que quien repare o realice el mantenimiento de su producto será un profesional de confianza.
- ☑ **Servicio técnico a escala nacional y número ilimitado de llamadas de solicitud de servicio técnico**: se puede poner en contacto con nosotros cuantas veces lo desee y cuando lo desee.
- ☑ **Garantía «sin sorpresas»**: se reemplaza el producto cubierto por el acuerdo si ocurren cuatro o más fallas del producto en un periodo de 12 meses.
- ☑ **Reemplazo del producto**: en caso de que no se pueda reparar el producto cubierto por el acuerdo.
- ☑ **Revisión anual preventiva de mantenimiento del producto**: puede solicitarla en cualquier momento, sin costo alguno.
- ☑ **Rápida asistencia telefónica**, la cual denominamos **Solución rápida**: es decir, asistencia telefónica a través de cualquiera de nuestros representantes de Sears, sobre cualquiera de nuestros productos. Piense en nosotros como en un «manual parlante del usuario».
- ☑ **Protección contra fallas eléctricas**, contra daños debidos a fluctuaciones de la corriente eléctrica.
- ☑ **\$250 al año para cubrir cualquier posible deterioro de alimentos** que haya tenido que desechar debido a una falla mecánica de cualquiera de nuestros refrigeradores o congeladores cubiertos por este acuerdo.
- ☑ **Devolución de gastos de alquiler de electrodomésticos** si la reparación de su producto asegurado toma más que el tiempo prometido.
- ☑ **10% de descuento** aplicable tanto a los costos del servicio de reparación, como de las piezas instaladas relacionadas que no hayan quedado cubiertos por este acuerdo.

Una vez que haya realizado el pago de este acuerdo, bastará una simple llamada telefónica para concertar una visita de servicio. Puede llamar a cualquier hora del día o de la noche, o bien concertar una visita de servicio por Internet.

La adquisición del Acuerdo maestro de protección es una inversión exenta de riesgos. Si por cualquier motivo decide cancelar dicho acuerdo durante el periodo de garantía del producto, le haremos un reintegro total del valor. O bien un importe proporcional si cancela el acuerdo en cualquier otro momento posterior al vencimiento del periodo de garantía del producto. ¡Adquiera hoy mismo su Acuerdo maestro de protección!

Algunas limitaciones y exclusiones podrían aplicarse. Para solicitar precios e información adicional, llame al 1-800-827-6655 (en los EE.UU.).

*** La cobertura en Canadá varía en el caso de algunos artículos. Para obtener detalles completos al respecto, llame al 1-800-361-6665 de Sears de Canadá.**

Servicio de instalación de Sears

*Para solicitar la instalación por profesionales de Sears de electrodomésticos, abridores de puertas de garaje, calentadores de agua y otros artículos de uso prioritario en el hogar, llame al **1-800-4-MY-HOME** en los EE.UU. o Canadá.*

Grounding Instructions

For personal safety, the cooktop must be properly grounded. For maximum safety, the power cord must be plugged into an electrical outlet that is correctly polarized and properly grounded.

DO NOT Operate the cooktop using a 2-prong adapter or an extension cord. If a 2-prong wall receptacle is the only available outlet, it is the personal responsibility of the consumer to have it replaced with a properly grounded 3-prong wall receptacle installed by a qualified electrician.

See the **INSTALLATION INSTRUCTIONS** packaged with this cooktop for complete installation and grounding instructions.

⚠ WARNING This appliance is equipped with a 3-prong grounding plug for your protection against shock hazard and should be plugged directly into a properly grounded receptacle. **DO NOT** cut or remove the grounding prong from this plug.

⚠ WARNING Personal injury or death from electrical shock may occur if the range is not installed by a qualified installer or electrician.

Grounding type wall receptacle

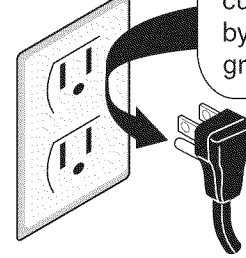

Do not, under any circumstances, cut, remove, or bypass the grounding prong.

Power supply cord with 3-prong grounding plug

⚠ WARNING Avoid fire hazard or electrical shock. **DO NOT** use an adapter plug, an extension cord, or remove grounding prong from electrical power cord. Failure to follow this warning can cause serious injury, fire or death.

Liquefied Petroleum (Propane) Gas Conversion (Only model 790-3103* can be converted)

Only model 790-3103* can be used with Natural Gas and Propane Gas.

All units are shipped from the factory for use with natural gas.

If you wish to convert your appliance for use with propane gas, use the instructions in the envelope attached, marked "FOR LP/PROPANE GAS CONVERSION".

Only a qualified service agent should perform the L. P. conversion. Contact the local gas provider for conversion.

An L. P. Conversion Kit is supplied with the model 790-3103 and is located on the main back of the range.

The kit contains installation instructions which must be read before and followed carefully when installing the kit.

⚠ WARNING To avoid serious injury, any additions, changes or conversions required in order for this appliance to satisfactorily meet the application needs must be made by a qualified service agent.

Range Features

Your Slide-In Range Features At a Glance

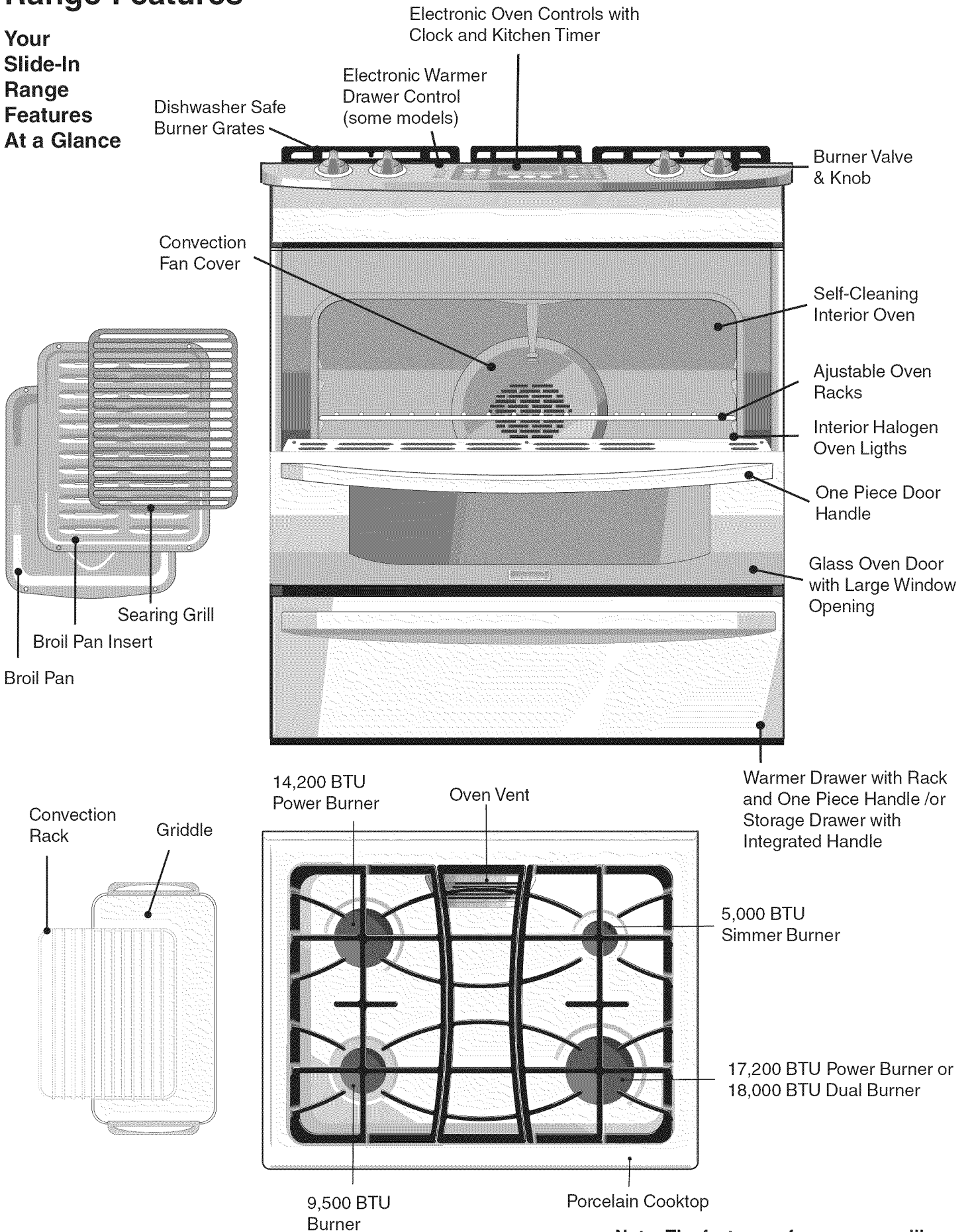

Note: The features of your range will vary according to model.

Before Setting Surface Controls

Assembly of the Surface Burner Heads, Burner Caps and Burner Grates for Regular Burners

It is very important to make sure that all of the Surface Burner Heads, Surface Burner Caps and Surface Burner Grates are installed correctly and at the correct locations.

1. Remove all packing tape from cooktop area. Remove all Burner Caps and Burner Heads.
2. Discard all packing material located under Burner Heads (if applicable).
3. To replace the Burner Heads & Caps, match the letters located under center of Burner Caps with the letters located inside Burner Heads (Figure 1).
4. Match Burner Skirts with Burner Heads and Burner Caps (see Figure 1). Replace the Burner Heads and Caps on cooktop (see Figure 2). Carefully align the Electrodes into slot or hole of each Burner Head (Figure 3). Note: The Burner Heads should sit flat on Cooktop Burner Skirts.
5. Place the removable oven vent cover over the fixed oven vent cover.
6. Unpack Burner Grates and position on the cooktop.

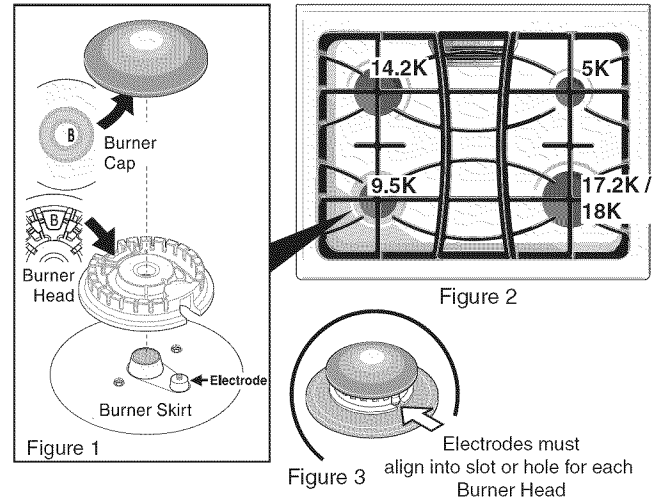

REMEMBER — DO NOT ALLOW SPILLS, FOOD, CLEANING AGENTS OR ANY OTHER MATERIAL TO ENTER THE GAS ORIFICE HOLDER OPENING. Always keep the Burner Caps and Burner Heads in place whenever the surface burners are in use.

Dual Burner Head Assembly (some models only)

Make sure that the Burner Head, Burner Caps and Burner Skirt are installed properly and at the correct locations.

1. Follow the Installation Instructions before installing and using your new range.
2. Remove all packing tape from cooktop and the dual burner.
3. Discard all packing material located under all Burners (if applicable).
4. To install Burner Head, Caps & Skirt, refer to figure 1 and follow the following steps:
 - Step 1: Align Burner Head Pin A on Burner Base Hole.
 - Step 2: Place Burner Skirt around Head and Base.
 - Step 3: Align the Burner Outer Cap Hole into Burner Head Pin B.
 - Step 4: Place Inner Burner Cap centered on Burner Base.
5. Put back the grates on the cooktop.

REMEMBER — DO NOT ALLOW SPILLS, FOOD, CLEANING AGENTS OR ANY OTHER MATERIAL TO ENTER THE GAS ORIFICE HOLDER OPENING. Always keep the Burner Caps and Burner Heads in place whenever the surface burners are in use.

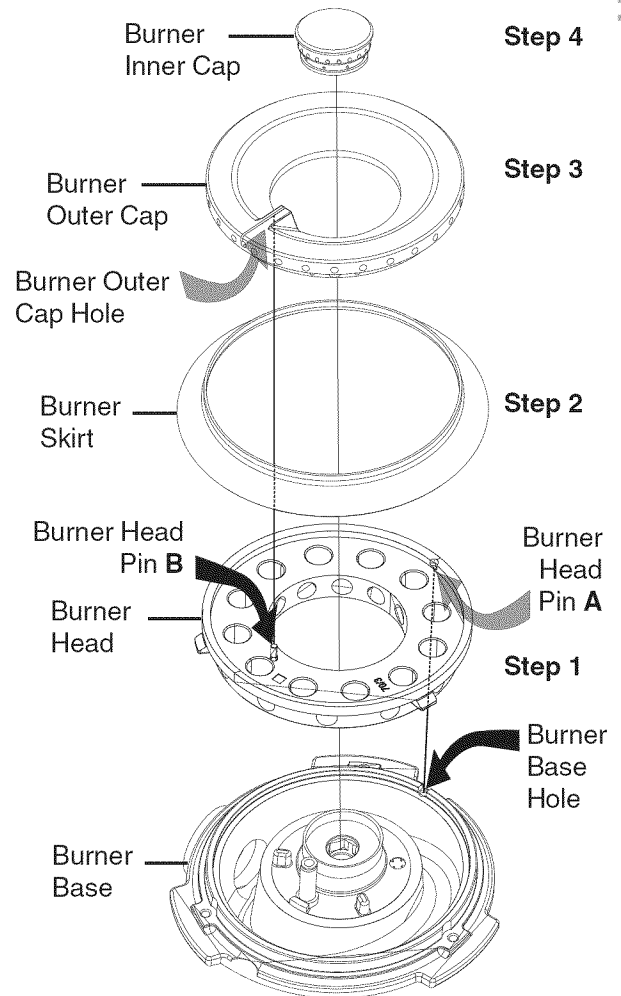

Figure 4

Before Setting Surface Controls

Locations of the Gas Surface Burners

Your range is equipped with gas surface burners with different BTU ratings. The ability to heat food quicker and in larger volumes increases as the burner size increases.

The small **SIMMER** burner is best used for simmering delicate sauces, etc. This burner is located at the right rear burner position on the cooktop.

The **STANDARD** burner can be used for most surface cooking needs. This standard burner is located at the left front position on the cooktop.

The **POWER** burners are best used for bringing large quantities of liquid rapidly up to temperature or when preparing larger quantities of food. The POWER burners are located at the right front (some models) and left rear positions on the cooktop.

The **DUAL** burner (some models) can be used as a standard burner or a power burner depending on the setting you are using. The DUAL burner is located at the right front on the cooktop.

Regardless of size, always select cookware that is suitable for the amount and type of food being prepared. Select a burner and flame size appropriate to the pan. Never allow flames to extend beyond the outer edge of the pan.



Figure 1

Setting Surface Controls

CAUTION Do not place plastic items such as salt and pepper shakers, spoon holders or plastic wrappings on top of the range when it is in use. These items could melt or ignite. Potholders, towels or wood spoons could catch fire if placed too close to a flame.

In the event of an electrical power outage, the surface burners can be lit manually. To light a surface burner, hold a lit match to the burner head, then rapidly turn the surface control knob to **Med.** After burner lights turn knob to desired setting. Use caution when lighting surface burners manually.

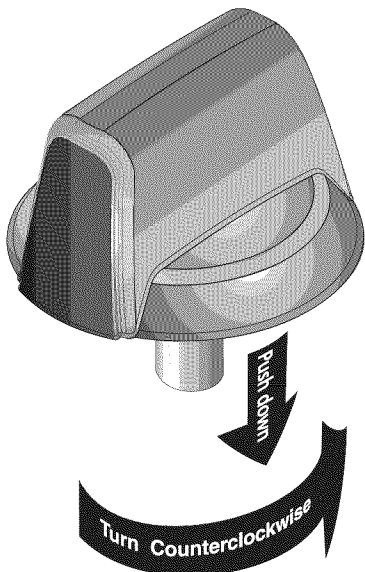

Figure 1

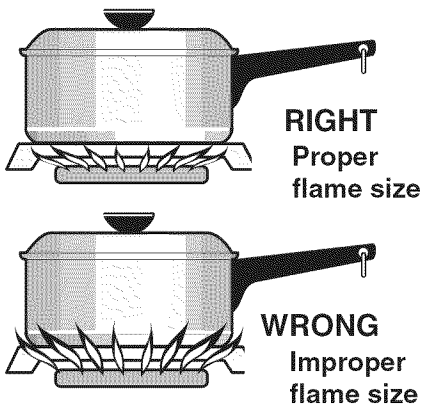

Figure 2

Operating the Gas Surface Controls:

1. Place cooking utensil on surface burner.
2. Push the surface control knob down and turn **counterclockwise** out of the OFF position (See Figure 1).
3. Release the knob and rotate to the LITE position. Note: All four electronic surface igniters will spark at the same time. However, only the burner you are turning on will ignite.
4. Visually check that the burner has a flame.
5. Turn the control knob **counterclockwise** to the desired flame size. The control knobs do not have to be set at a particular setting. Use the knob indicator settings to adjust the flame as needed. **DO NOT** cook with the surface control knob in the LITE position. (The electronic ignitor will continue to spark if the knob is left in the LITE position.)

Setting Proper Surface Burner Flame Size

For most cooking, start on the highest control setting and then turn to a lower one to complete the process. Use the recommendations below as a guide for determining proper flame size for various types of cooking. The size and type of utensil used and the amount of food being cooked will influence the setting needed for cooking.

*Flame Size	Type of Cooking
High Flame	Start most foods; bring water to a boil; pan broiling.
Medium Flame	Maintain a slow boil; thicken sauces, gravies; steaming.
Low Flame	Keep foods cooking; poach; stewing.

***These settings are based on using medium-weight metal or aluminum pans with lids. Settings may vary when using other types of pans.** The color of the flame is the key to proper burner adjustment. A good flame is clear, blue and hardly visible in a well-lighted room. Each cone of flame should be steady and sharp. Clean burner if flame is yellow-orange. Regardless of size, always select cookware that is suitable for the amount and type of food being prepared. Select a burner and flame size appropriate to the pan. Never allow flames to extend beyond the outer edge of the pan.

Never extend the flame beyond the outer edge of the utensil. A higher flame wastes heat and energy and increases your risk of being burned by the flame (Figure 2).

For deep fat frying, use a thermometer and adjust the surface control knob accordingly. If the fat is too cool, the food will absorb the fat and be greasy. If the fat is too hot, the food will brown quickly and the center will be undercooked. Do not attempt to deep fat fry too much food at once as the food will neither brown nor cook properly.

Setting Surface Controls

Setting the Dual Burner (SOME MODELS ONLY)

The Dual Burner has two rings of flame that you can control for two different heat levels, one for small and one for large cookware.

Large Cookware Operation (Figure 1; Zone A & B)

1. Place a large cooking utensil centered over the surface Burner Grate.
2. Push the surface control knob in and turn **counterclockwise** out of the OFF position (See Figures 2 & 3).
3. Release the knob and rotate to the **LITE** position. Note: All electronic surface ignitors will spark at the same time. However, only the dual Burner will ignite.
4. Visually check that zone A & B of dual burner are lit (Figure 4). Adjust the flame size by turning the control knob between the **HI and the 2nd dot settings (Figure 3)**. **DO NOT** cook with the surface control knob in the LITE position (The electronic ignitor will continue to spark if the knob is left in the LITE position).

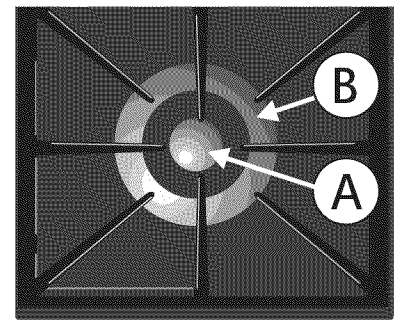

Figure 1

Small Cookware Operation (Figure 1; Zone A)

1. Place a small cooking utensil centered over the dual surface Burner Grate.
2. Push the surface control knob in and turn **counterclockwise** out of the OFF position.
3. Release the knob and rotate to the **LITE** position (Figures 2 & 3). Note: All electronic surface ignitors will spark at the same time. However, only the selected surface Burner will lite.
4. Visually check that zone A & B of the dual burner has lit.
5. Continue to rotate the gas control knob counterclockwise past the **2nd dot** setting; zone B flames will extinguish.
6. Visually check that only zone A is lit.
7. Continue to turn the control knob **counterclockwise** to adjust to the desired flame size for the zone A. Note: The markings between the **2nd dot and Lo** settings on the control knob adjust the flame size for the zone A (Refer to Figure 2 or 3). **DO NOT** cook with any of the surface control knobs in the LITE position (The electronic ignitor will continue to spark if the knob is left in the LITE position).

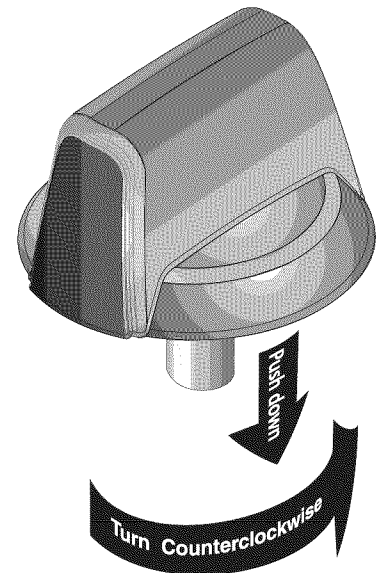

Figure 2

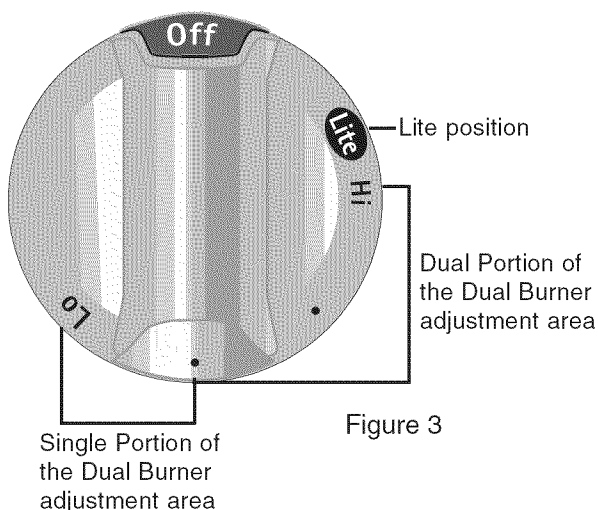

Figure 3

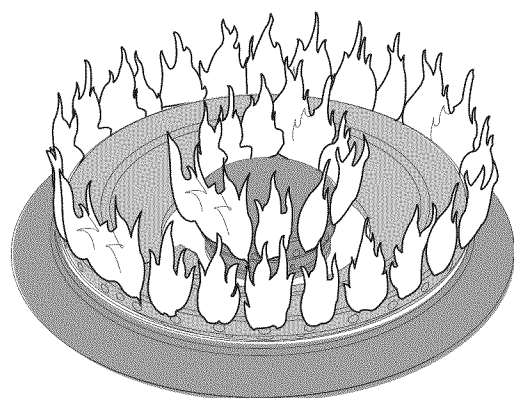

Figure 4

Surface Cooking Use Proper Cookware

Cookware should have flat bottoms that make good contact with the entire surface heating element. Check for flatness by rotating a ruler across the bottom of the cookware (See Figure 1). Be sure to follow the recommendations for using cookware as shown in Figure 2.

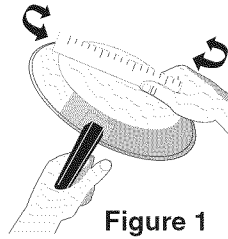
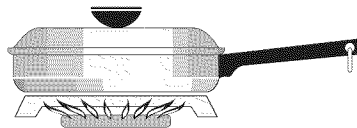

Figure 1

Note: The size and type of cookware used will influence the setting needed for best cooking results.

Note: Always use a utensil for its intended purpose. Follow manufacturer's instructions. Some utensils were not made to be used in the oven or on the cooktop.

CORRECT



- **Flat bottom** and straight sides.
- Tight fitting lids.
- Weight of handle does not tilt pan. Pan is well balanced.
- Pan sizes match the amount of food to be prepared.
- Made of material that conducts heat well.
- Easy to clean.

INCORRECT

- Curved and warped pan bottoms.

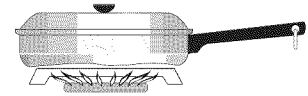

- Pan overhangs burner grate by more than 2.5 cm (1").

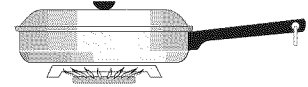

- Heavy handle tilts pan.

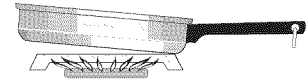

- Flame extends beyond pan.

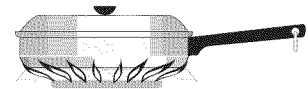
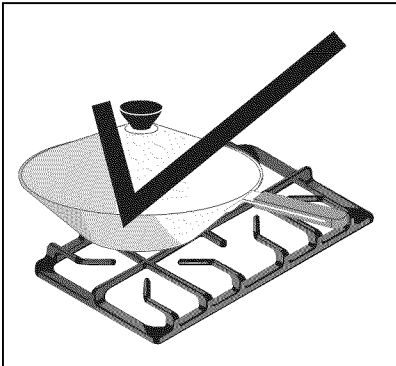

Figure 2

* Specialty pans such as lobster pots, griddles and pressure cookers may be used but must conform to the above recommended cookware requirements.

Using a wok (some models)



Woks with flat bottoms suitable for use on your cooktop are available in most cookshop or hardware stores. Round-bottomed woks (with a support ring that does not extend beyond the burner circumference) may also be used. The metal ring was designed to support the wok safely when it is filled with large amounts of liquids (soup making) or fat (frying).

Wire trivets: Do not use wire trivets. Cookware bottoms must be in direct contact with the grates.

DO NOT use a wok if it is equipped with a metal ring that extends beyond the burner circumference. Because this ring traps heat, the surface unit and cooktop surface could be damaged.

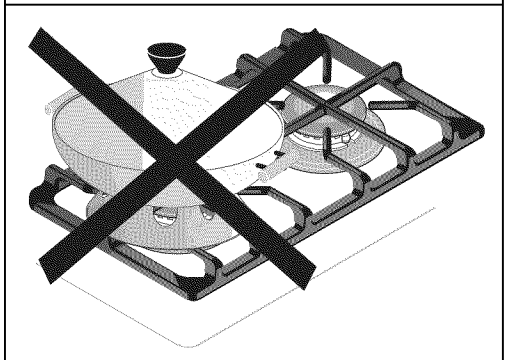

Surface Cooking (cont'd)

Care & Seasoning of the Griddle (some models)

Before first use:

- Wash Griddle in hot soapy water. Rinse and then dry completely.
- Apply a thin coat of vegetable oil to the entire surface (front and back of griddle).
- Preheat your oven to 350°F. Place the griddle on the upper rack in your oven.
- Bake griddle for 1 hour at 350°F, then turn oven OFF and let cool before removing.
- The surface may appear to have a tacky feel to it from the seasoning process. If desired, wash the griddle in hot soapy water, rinse well, and dry completely.

After each use:

- To prevent rusting, store in a dry place and keep uncovered.
- After each use, clean with a stiff brush and hot water only.
- **DO NOT CLEAN GRIDDLE IN DISHWASHER.**
- Dry Immediately and apply a light coating of vegetable oil to griddle before storing.

Using the Griddle:

- Place either side of the griddle centered over the left side gas burners or over the Bridge Burner. For location refer to Figure 1.
- Preheat the griddle for 5 minutes on medium to medium low setting. Slow preheat ensures even heat distribution during the cooking process.
- **DO NOT** preheat the griddle on HI setting. Preheating on HI may warp the griddle and prevent even heat distribution.

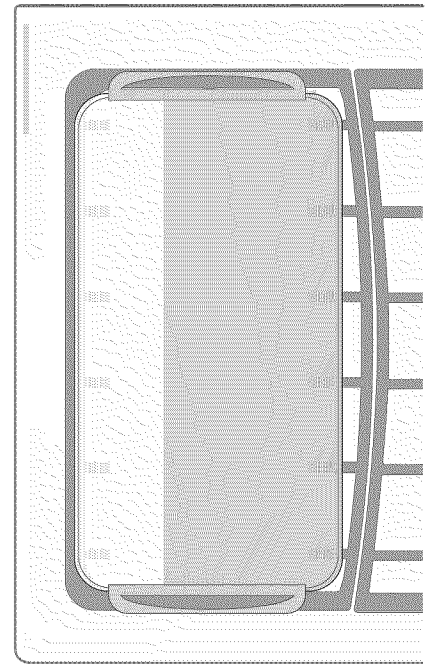

Figure 1

Before Setting Oven Controls

CAUTION This range has a fan that will turn “ON” and “OFF” by itself to keep the electronics cool. It may continue to run after the range has been turned “OFF”, but may also stop immediately and then turn “ON” after a while.

Oven Vent Location

The oven vent is located **in the center rear on the cooktop**. When the oven is on, warm air passes through the vent. This venting is necessary for proper air circulation in the oven and good baking results. **DO NOT BLOCK OVEN VENT.** Never close off the openings with aluminum foil or any other material.

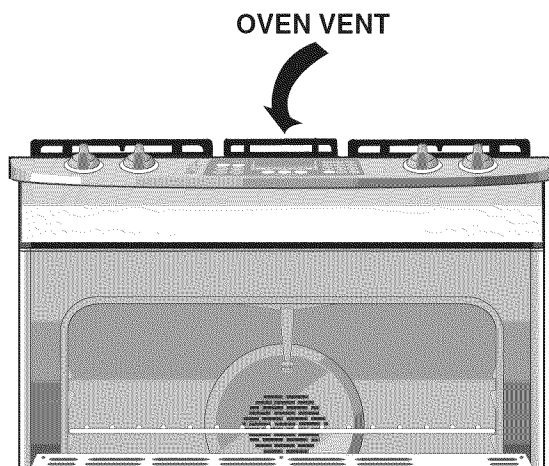

Removing and Replacing Oven Racks

To remove, pull the rack forward until it stops. Lift up front of rack and slide out. **To replace**, fit the rack onto the guides on the oven walls. Tilt the front of the rack upward and slide the rack back into place.

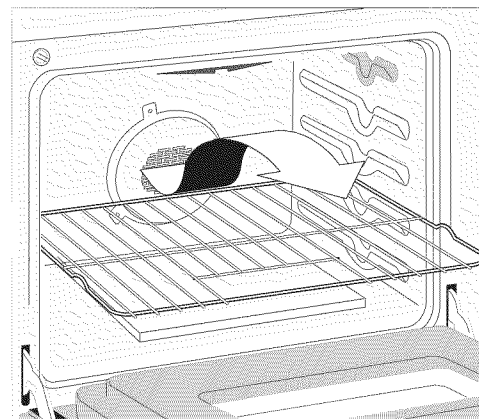

Before Setting Oven Controls (cont'd)

Arranging Oven Racks

ALWAYS ARRANGE OVEN RACKS WHEN THE OVEN IS COOL (PRIOR TO OPERATING THE OVEN). Always use oven mitts when the oven is hot.

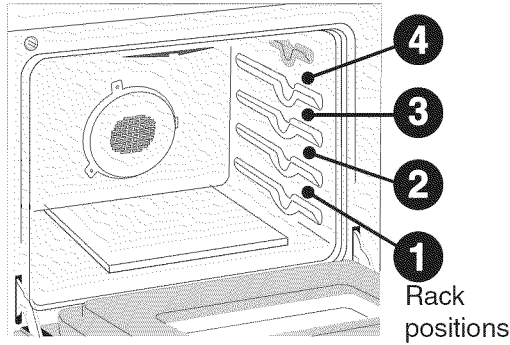

Figure 1

RECOMMENDED RACK POSITIONS FOR BROILING, BAKING & ROASTING

Food	Rack position
Broiling meats, chicken or fish	3 or 4
Cookies, cakes, pies, biscuits & muffins	
1 rack	2 or 3
Multiple racks	2 & 4
Frozen pies, angel food cake, yeast, bread, casseroles, small cuts of meat or poultry	1 or 2
Turkey, roast or ham	1

Note: Always use caution when removing food.

Types of Oven Racks

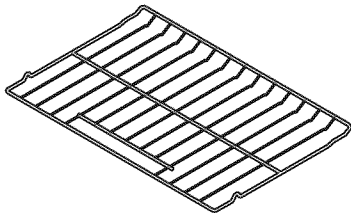

Flat Handle Oven Rack

Figure 2

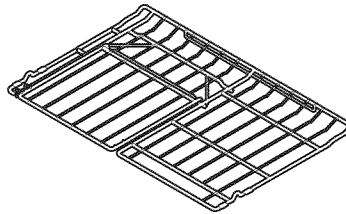

Flat Half Oven Rack (some models)

Figure 3

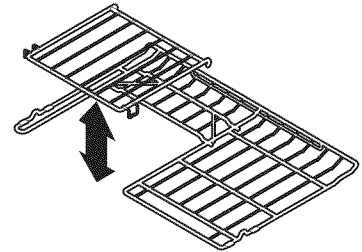

CAUTION Always use pot holders or oven mitts when adjusting the oven racks. Wait until the oven has completely cooled if possible. Oven racks may be HOT and may cause burns.

Your appliance may be equipped with one or more of the oven rack types shown; **Flat Handle Oven Rack** (Figure 2) and **Flat Oven Half Rack** (Figure 3).

The **Flat Half Rack** has a removable insert that can provide extra space for larger food items. The right half rack portion may still be used for other food items like a casserole dish (See Figure 3). To remove the insert, squeeze on the left front insert side (See Figure 4) of the rack and tilt out clockwise. To reinstall insert rear hooks at back of insert (See Figure 5) and lay insert down. Make sure both insert front hooks snap into rack (See Figure 5).



Figure 4

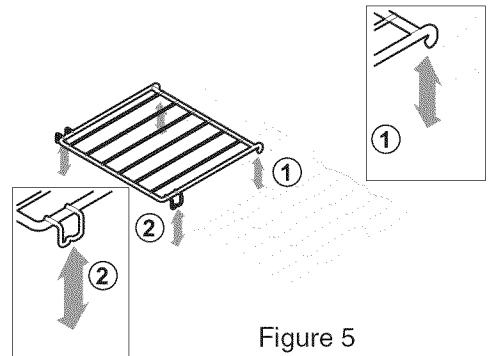
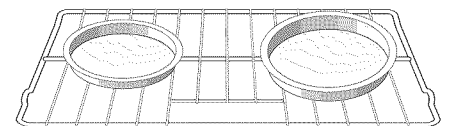

Figure 5

Do not use cookware that extends beyond the edge of the Flat Half Rack. For best results, allow 2 inches between the pan placed on the rack and oven side or rear walls.

Air Circulation in the Oven

For best air circulation and baking results allow 2-4" (5-10 cm) around the cookware for proper air circulation and be sure pans and cookware do not touch each other, the oven door, sides or back of the oven cavity. The hot air must circulate around the pans and cookware in the oven for even heat to reach around the food.



1 Oven Rack

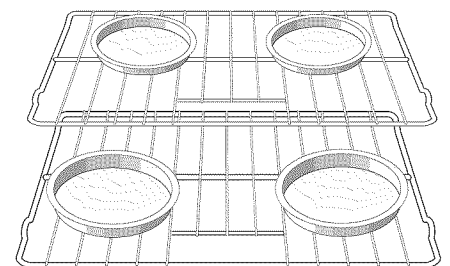

Multiple Oven Racks

ENGLISH

Control Pad Features

READ THE INSTRUCTIONS CAREFULLY BEFORE USING THE OVEN. For satisfactory use of your oven, become familiar with the various features and functions of the oven as described below. **Detailed instructions for each feature and function follow later in this Use & Care Guide.**

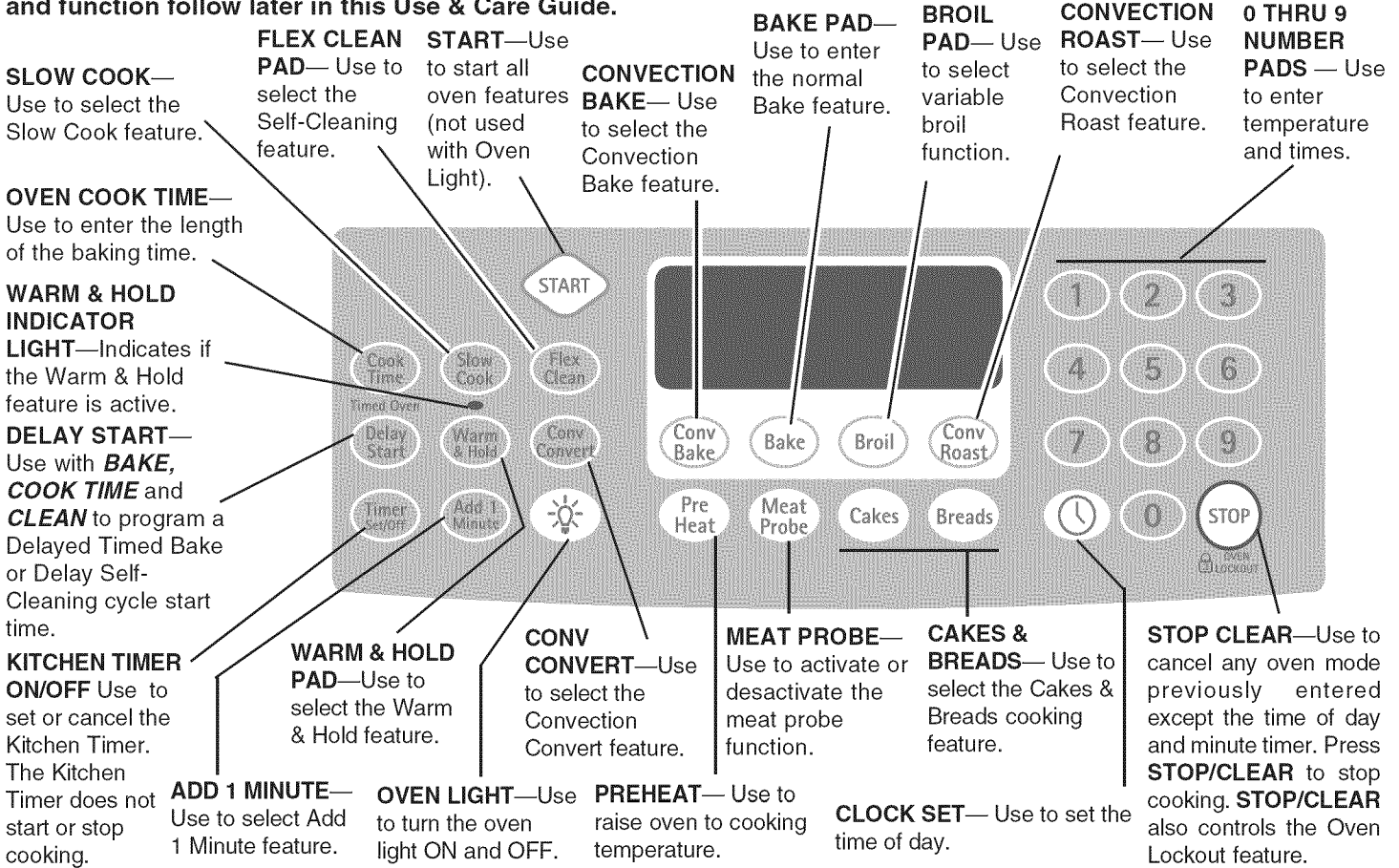

Minimum and Maximum Control Pad Settings

All of the features listed below have minimum and maximum time or temperature settings that may be entered into the control. An ENTRY acceptance beep will sound each time a control pad is touched (the Oven Lockout pad is delayed 3 seconds). An ENTRY ERROR tone (3 short beeps) will sound if the entry of the temperature or time is below the minimum or above the maximum settings for the feature.

FEATURE		MINIMUM TEMP. /TIME	MAXIMUM TEMP. /TIME
PREHEAT TEMP.		170°F/77°C	550°F/288°C
BAKE, CAKES, BREADS TEMP.		170°F/77°C	550°F/288°C
BROIL TEMP.		400°F/205°C	550°F/288°C
KITCHEN TIMER	12 Hr.	0:01 Min.	11:59 Hr./Min.
	24 Hr.	0:01 Min.	11:59 Hr./Min.
CLOCK TIME	12 Hr.	1:00 Hr./Min.	12:59 Hr./Min.
	24 Hr.	0:00 Hr./Min.	23:59 Hr./Min.
COOK TIME	12 Hr.	0:01 Min.	11:59 Hr./Min.
	24 Hr.	0:01 Min.	11:59 Hr./Min.
DELAY START	12 Hr.	1:00 Hr./Min.	12:59 Hr./Min.
	24 Hr.	0:00 Hr./Min.	23:59 Hr./Min.
CLEAN TIME		2 hours	4 hours
CONVECTION BAKE, ROAST		300°F/149°C	550°F/288°C
MEAT PROBE		130°F/54°C	210°F/99°C

Setting Oven Controls

Setting the Clock







The  pad is used to set the clock. The clock may be set for 12 or 24 hour time of day operation. The clock has been preset at the factory for the 12 hour operation. When the range is first plugged in, or when the power supply to the range has been interrupted, the timer in the display will flash (See Fig. 1).



Figure 1
DISPLAY

INSTRUCTIONS

To set the clock (example below for 1:30)

1. Press . "CLO" will appear in the display (Figure 2).
2. Press    pads to set the time of day to 1:30 (Figure 3). "CLO" will stay in the display. Press . "CLO" will disappear and the clock will start (Figure 4).

PRESS

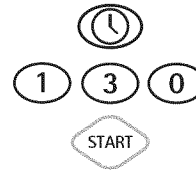

Figure 2



Figure 3

Changing between 12 or 24 hour time of day display





1. Press and hold  for 7 seconds. "CLO" will appear in the display. "12h" (Figure 5) or "24h" (Figure 6) appears in the display and the control beeps once.
2. Press  to switch between the 12 and 24 hour time of day display. The display will show either "12h" (Figure 5) or "24h" (Figure 6).
3. Press  to accept the change or press  to reject the change.
4. Reset the correct time as described in **To set the Clock** above. Please note that if the 24 hour time of day mode was chosen, the clock will now display time from 0:00 through 23:59 hours.



Figure 4

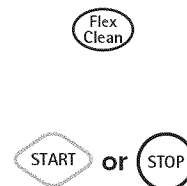

Figure 5





Figure 6

ENGLISH





Setting Oven Controls (con't)

Setting Continuous Bake or 12 Hour Energy Saving

The **TIMER**  and **FLEX CLEAN**  pads control the Continuous Bake or 12 Hour Energy Saving features. The oven control has a factory preset built-in 12 Hour Energy Saving feature that will shut off the oven if the oven control is left on for more than 11 hours and 59 minutes. The oven can be programmed to override this feature for Continuous Baking.

INSTRUCTIONS

To set the control for Continuous Bake or 12 Hour Energy Saving features

1. Press and hold  for 7 seconds (Figure 1). After 7 seconds "12h" or "-h" will appear in the display and the control will beep once.
2. Press  to switch between the 12 Hour Energy Saving and continuous bake features. Note: "12h" (Figure 2) in the display indicates the control is set for the 12 Hour Energy Saving mode and "-h" indicates the control is set for the Continuous Bake feature (Figure 3).
3. Press  to accept the change (Figure 4; display will return to time of day) or press  to reject the change.

PRESS

 for 7 seconds





or 

DISPLAY



Figure 1



Figure 2



Figure 3







Figure 4

Setting Kitchen Timer

The **TIMER**  pad controls the Kitchen Timer feature. The Kitchen Timer serves as an extra timer in the kitchen that will beep when the set time has run out. It does not start or stop cooking. The Kitchen Timer feature can be used during any of the other oven control functions. Refer to "Minimum and Maximum Control Pad Settings" for time amount settings.

INSTRUCTIONS

To set the Kitchen Timer (example for 5 minutes)

1. Press . "---" will appear and "TIMER" will flash in the display (Figure 5).
2. Press the number pads to set the desired time in the display (example ). Press . The time will begin to count down with "5:00" and "TIMER" will stay in the display (Figure 6). Note: If  is not pressed the timer will return to the time of day after 25 seconds.
3. When the set time has run out, "End" and "TIMER" will show in the display (Figure 7). The clock will sound with 3 beeps every 5 seconds until  is pressed.

PRESS





DISPLAY



Figure 5



Figure 6





Figure 7

To cancel the Kitchen Timer before the set time has run out

Press . The display will return to the time of day.

To Set Add 1 Minute Feature

The  ADD 1 MINUTE pad is used to set the Add 1 Minute feature. When the  pad is pressed, 1 minute is added to the Kitchen Timer feature if this feature is already active. If the Kitchen Timer feature is not active and the  pad is pressed, the Kitchen Timer feature will become active and will begin counting down from 1 minute.

Consumer Defined Control



Note: The Consumer Defined Control features are adjustments to the control that will not affect cooking results. These include the Oven Lockout, Temperature Display and Silent Control Operation features

Setting Oven Lockout Feature

The  pad controls the Oven Lockout feature. The Oven Lockout feature automatically locks the oven door and prevents the oven from being turned on. It does not disable the clock, Kitchen Timer or the interior oven lights.

INSTRUCTIONS

To activate the Oven Lockout feature

1. Press and hold  for 3 seconds.
2. After 3 seconds "Loc" and  will appear, a beep will sound and "DOOR LOCKED" will flash in the display. Once the oven door is locked the "DOOR LOCKED" indicator will stop flashing and remain on along with the "Loc" (Figure 1).

PRESS

 for 3 seconds

DISPLAY

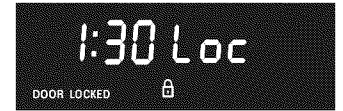



Figure 1

To reactivate normal oven operation:



1. Press and hold  for 3 seconds. A beep will sound. The "DOOR LOCKED" will flash in the display until the oven door has completely unlocked (Figure 2).
2. The wall oven is again fully operational.

 for 3 seconds





Figure 2

Setting Silent Control Operation



The **DELAY TIME**  and **FLEX CLEAN**  pads control the Silent Control operation feature. The Silent Control operation feature allows the oven control to be operated without sounds or beeps whenever necessary. If desired the control can be programmed for silent operation and later returned to operating with all the normal sounds and beeps.

INSTRUCTIONS

To change control from normal sound operation to silent control operation

1. To tell if your range is set for normal or silent operation press and hold . "--:--" will appear and "DELAY" will flash in the display (Figure 3). After 7 seconds "SP" (Speaker) will appear in the display. (Figure 4)
2. Press  to switch between normal sound operation and silent operation mode. The display will show either "SP" (Figure 4) or ":--" (Figure 5).

If "SP" appears (Figure 4), the control will operate with normal sounds and beeps. If ":--" appears (Figure 5), the control is in the silent operation mode.

3. Press  to accept the change or press  to reject the change.

PRESS

 for 7 seconds



DISPLAY



Figure 3



Figure 4





Figure 5

 or 

Note: The control will always beep at the end of a kitchen timer and will beep when a set temperature has been reached, even if the control is set to silent operation.

Consumer Defined Control Features

Setting Temperature Display — Fahrenheit or Celsius:





The **BROIL**  and **FLEX CLEAN**  pads control the Fahrenheit or Celsius temperature display modes. The oven control can be programmed to display temperatures in Fahrenheit or Celsius. The oven has been preset at the factory to display in Fahrenheit.

INSTRUCTIONS

PRESS

DISPLAY

To change display from Fahrenheit to Celsius or Celsius to Fahrenheit

1. To tell if the display is set for Fahrenheit or Celsius press  (Figure 1) and hold for 7 seconds; "550°" will appear and "BROIL" will flash in the display and a beep will sound. If "F" appears, the display is set to show temperatures in Fahrenheit (Figure 2). If "C" appears, the display is set to show temperatures in Celsius (Figure 3).
2. Press  to switch between Fahrenheit or Celsius display modes. The display will show either "F" (Figure 2) or "C" (Figure 3).
3. Press  to accept the change or press  to reject the change.

for 7seconds



 or 



Figure 1



Figure 2

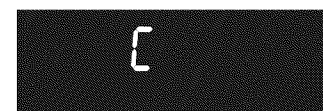

Figure 3

Setting Oven Controls

Important Things to Know Before Setting any Basic Oven Cooking Function

This appliance has been factory pre-set to start any **BAKE, CONV BAKE, CONV ROAST, PREHEAT, CAKE** or **BREAD** function with the oven set temperature automatically set for 350°F. However if desired, the oven set temperature may be adjusted at any time during the cooking process. You may also choose to add a **COOK TIME** or **DELAY START** with any of the functions listed above.

Temperature Visual Display

Your oven is equipped with a temperature visual display. When a cooking mode is set, the actual temperature will be shown in the display and will rise as the unit preheat. When the unit has reached its target temperature, a chime will sound to remind you to place the food in the oven. This feature will be active with some cooking modes; bake, convection bake, convection roast, cakes and breads.

NOTE: The lowest temperature that can be displayed is 100°F.







Setting Oven Controls

Setting Preheat

The **PREHEAT**  pad controls the Preheat feature. The Preheat feature will bring the oven up to temperature and then indicate when to place the food in the oven. Use this feature when recipes call for preheating. Preheating is not necessary when roasting or cooking casseroles. The oven can be programmed to preheat at any temperature between 170°F to 550°F.

INSTRUCTIONS

To set the Preheat temperature for 375°F





1. Arrange the interior oven racks.
2. Press . "350" and "BAKE" will appear in the display (Figure 1). Note that if a preheat of 350°F is needed, press .
3. Press   . "375°" and "BAKE" will appear in the display (Figure 2).
4. Press . "BAKE" will appear in the display. "PRE" and the actual oven temperature shown in the display will alternate as the oven heats and reaches 375°F (Figure 3).

Note: After the oven has reached the desired temperature (this example, 375°F) the control will beep and the "PRE" light will turn off and oven target temperature will be displayed (Figure 4). If you missed hearing the beep, you can tell that the oven has reached preheat temperature if you see the oven temperature showing in the oven display. Once the oven has preheated, **PLACE FOOD IN THE OVEN**. The "BAKE" light will stay on.

Press  when baking is complete or to cancel the preheat feature.

To change Preheat temperature while oven is preheating (example: changing from 375°F to 425°F)

If it is necessary to change the preheat temperature while the oven is preheating to the original temperature:

1. While preheating, press . "375" and "BAKE" will appear in the display (Figure 5)
2. Enter the new preheat temperature. Press   . "425°" and "BAKE" will appear in the display (Figure 6).
3. Press . "BAKE" will appear in the display. "PRE" and the actual oven temperature shown in the display will alternate as the oven heats and reaches 425°F (Figure 7).

Note: A beep will sound once the oven temperature reaches 425°F and the display will show "425°" and "BAKE" (Figure 8).

4. When baking is complete press .

Note: While in preheat mode, the convection fan will be activated during the first rise of temperature to allow the oven to reach its target temperature faster. The Bake, Broil and Convection elements will also cycle for a better heat distribution.

PRESS

DISPLAY



Figure 1



Figure 2



Figure 3



Figure 4



Figure 5



Figure 6



Figure 7





Figure 8

ENGLISH

Setting Oven Controls

Setting Bake







The **BAKE**  pad controls normal baking. If preheating is necessary, refer to the  Preheat Feature for instructions. The oven can be programmed to bake at any temperature from 170° F to 550° F (the sample shown below is for 350°F).

INSTRUCTIONS

PRESS





DISPLAY

To set the Bake Temperature to 375°F

1. Arrange interior oven racks and place food in oven.
2. Press , "350" will appear and "BAKE" will flash in the display (Figure 1). If a bake of 350°F is needed, press .
3. Press    (Figure 2). "BAKE" will continue to flash and "375" will appear in the display.
4. Press . The actual temperature will be displayed (Figure 3). A beep will sound once the oven temperature reaches 375°F and the display will show "375" and "BAKE" (Figure 4).

Pressing  will cancel the Bake feature at any time.

To change the Bake Temperature (example: changing from 375°F to 425°F)

1. After the oven has already been set to bake at 375°F and the oven temperature needs to be changed to 425°F, press  (Figure 5) and "375" will appear and "BAKE" will flash in the display.
2. Press    (Figure 6). "BAKE" will continue to flash and "425" will appear in the display.
3. Press .

Note: After 6 minutes of the first rise of temperature, the convection fan will be activated to allow the oven to reach its target temperature faster. The Bake and Broil burners and the Convection element will also cycle for a better heat distribution.



Figure 1



Figure 2



Figure 3



Figure 4



Figure 5



Figure 6

Setting Oven Controls (cont'd)

Oven Baking Information

For best results, preheat the oven before baking cookies, breads, cakes, pies or pastries, etc. There is no need to preheat the oven for roasting meat or baking casseroles.

The cooking times and temperatures needed to bake a product may vary slightly from your previously owned appliance. Refer to “Adjusting the Oven Temperature” section.

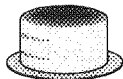
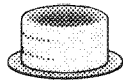
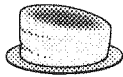
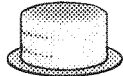
Baking problems and solutions		
Baking Problems	Causes	Corrections
Cookies and biscuits burn on the bottom. 	<ul style="list-style-type: none"> • Cookies and biscuits put into the oven before the preheating time is completed. • Oven rack overcrowded. • Dark pan absorbs heat too fast. 	<ul style="list-style-type: none"> • Allow oven to preheat to the selected temperature before placing food in oven. • Choose pan sizes that will permit 2" to 4" (5.1 cm to 10.2 cm) of air space on all sides when placed in the oven. • Use a medium-weight aluminum baking sheet.
Cakes too dark on top or bottom. 	<ul style="list-style-type: none"> • Cakes put into the oven before preheating time is completed. • Oven rack position too high or low. • Oven too hot. 	<ul style="list-style-type: none"> • Allow oven to preheat to the selected temperature before placing food in the oven. • Use proper rack position for baking needs. • Set oven temperature 25°F/12°C lower than recommended.
Cakes not done in the center. 	<ul style="list-style-type: none"> • Oven too hot. • Incorrect pan size. • Pan not centered in the oven. 	<ul style="list-style-type: none"> • Set oven temperature 25°F/12°C lower than recommended. • Use pan size suggested in recipe. • Use proper rack position and place pan so there is 2" to 4" (5.1 cm to 10.2 cm) of space on all sides of pan.
Cakes not level. 	<ul style="list-style-type: none"> • Range not level. • Pan too close to oven wall or rack overcrowded. • Pan warped. 	<ul style="list-style-type: none"> • Place marked glass measuring cup filled with water on the center of the oven rack. If water level is uneven, refer to the installation instructions for leveling the appliance. • Be sure to allow 2" to 4" (5.1 cm to 10.2 cm) of clearance on all sides of each pan in the oven. • Do not use pans that are dented or warped.
Foods not done when cooking time is up. 	<ul style="list-style-type: none"> • Oven too cool. • Oven overcrowded. • Oven door opened too frequently. 	<ul style="list-style-type: none"> • Set oven temperature 25°F /12°C higher than suggested and bake for the recommended time. • Be sure to remove all pans from the oven except the ones to be used for baking. • Open oven door only after shortest recommended baking time.

Setting Oven Controls

Setting Convection Bake

The **CONVECTION BAKE**  pad controls the Convection Bake feature.

Use the Convection Bake feature when cooking speed is desired. The oven can be programmed for Convection baking at any temperature between 300°F (149°C) to 550°F (288°C).

Convection baking uses a fan to circulate the oven's heat evenly and continuously within the oven (See Figure 1). This improved heat distribution allows for fast, even cooking and browning results. It also gives better baking results when using 2 or 3 racks at the same time. Breads and pastries brown more evenly. Convection bake cooks most foods faster and more evenly than conventional bake.

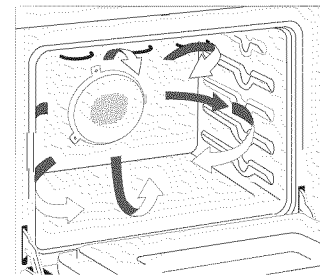

Air circulation during Convection Bake

Figure 1 4th Rack position

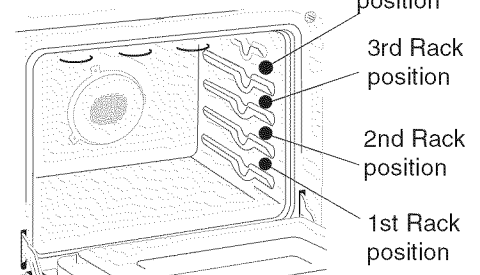

Figure 2

General Convection Bake Instructions







1. Time reductions will vary depending on the amount and type of food to be cooked. Cookies and biscuits should be baked on pans with no sides or very low sides to allow heated air to circulate around the food. Food baked on pans with a dark finish will cook faster.
2. Preheating is not necessary when cooking casseroles with Convection Bake.
3. When using Convection Bake with a single rack, place oven rack in position 2 or 3. If cooking on multiple racks, place the oven racks in positions 2 and 4.

Benefits of Convection Bake:

- Multiple rack baking.
- Some foods cook up faster, saving time and energy.
- No special pans or bakeware needed.

INSTRUCTIONS

To set the oven for Convection Bake and temperature to 375°F

1. Arrange interior oven racks and place food in oven.
2. Press . "CONV BAKE" will flash and "350" will appear in the display (Figure 3). If a Conv Bake of 350°F is needed, press .
3. Press   . "CONV BAKE" will keep flashing and "375" will appear in the display (Figure 4).
4. Press . The actual oven temperature will be displayed. "CONV BAKE" will stop flashing and the fan icon will appear in the display (Figure 5).

Note: The convection fan will start 6 minutes after the oven is set for Convection Bake. The display will show an icon of rotating fan within a square. This rotating fan icon indicates when the Convection Fan is operating. The Bake and Broil burners and the Convection element will also cycle for a better heat distribution.

Press  to stop Convection Bake or cancel Convection Bake at any time.

PRESS

DISPLAY



Figure 3



Figure 4



Figure 5









Setting Oven Controls

Setting Convection Roast









This method of cooking enables you to obtain the best results when roasting. The oven can be programmed to convection roast at any temperature from 300°F to 550°F (149°C to 288°C). Remember to use tested recipes with times adjusted for convection roasting when using the convection mode. Times may be reduced when using the convection feature.

INSTRUCTIONS

To Set the oven to Convection Roast at 375°F

1. Arrange oven racks.
2. Press ; "350" will be displayed; **CONV ROAST** will flash (Figure 1).
3. Enter the desired roasting temperature using the number pads      (Figure 2).
4. Press ; The actual oven temperature will be displayed, **CONV ROAST** and the fan icon will be displayed (Figure 3).

To Change the Convection Roast temperature (example: changing from 375°F to 425°F)

1. Press ; "375" will be displayed; **CONV ROAST** will flash (Figure 2).
2. Enter the desired roasting temperature using the number pads       (Figure 4).
3. Push ; the current oven temperature, **CONV ROAST** and the fan icon will be displayed.

After the oven has reached the desired temperature, the control will beep and **CONV ROAST** light will stay on. **Note:** The Bake and Broil burners and the Convection element will also cycle for a better heat distribution.

When convection roasting is complete press .

Setting Convection Convert

The  **CONV CONVERT** pad is used to automatically convert a standard **baking** recipe for convection baking. When set properly, this feature is designed to display the actual converted (reduced) temperature in the display.

Convection Convert may **ONLY** be used with a **Conv Bake**, **Timed Conv Bake** or a **Delay Start** (Delayed Timed Conv Bake) setting. When used with a Timed Bake or a Delay Start (Delayed Timed Bake) setting, the Convection Convert will display a "CF" for check food when the bake time is 75% complete (See Fig. 8). At this time the oven control will sound 3 long beeps at regular intervals until baking had finished. When the bake time has completely finished the control will

display "End" and will sound 3 long beeps every 30 seconds until the  pad is pressed.

To change from a normal bake recipe to a convection bake recipe (example: changing a 400°F normal bake recipe to a convection bake recipe)

When the conv bake mode is on at 400°F (Figure 6), press . "**CONV BAKE**" and the oven temperature **adjustment** will appear briefly in the display (for this example it is 375°F) (Fig. 7) then the actual oven temperature will be displayed. A beep will sound once the **adjusted** oven temperature is reached. The display will show "375°", "**CONV BAKE**" and the fan icon (Fig. 7).

NOTE: When using a Cook Time, the convection convert will not operate if you have a timed bake under 20 minutes.

PRESS

DISPLAY



Figure 1



Figure 2



Figure 3



Figure 4

ENGLISH



Figure 6



Figure 7



Figure 8

Setting Oven Controls

Setting the Slow Cook Feature

The  **SLOW COOK** pad is used to activate this feature. The Slow Cook feature may be used to cook foods more slowly, at lower oven temperatures and provides cooking results much the same way as a Slow Cooker or Crock-Pot. The Slow Cook feature is ideal for roasting beef, pork & poultry. Slow Cooking meats may result in the exterior of meats becoming dark but not burnt. This is normal.

There are 2 settings available, high (HI) or low (LO). The maximum cook time for the Slow Cook feature is 12 hours unless the oven control has been changed to the Continuous Bake mode or the Sabbath mode has been activated. This feature may be used with the additional settings of a **Timed Bake** Slow Cook (see **Timed Bake** beginning with step 5-7) or a **Delayed Start Bake** Slow Cook (see **Delayed Start Bake** steps 6-10).

Below is a list of preparation and cooking tips you should review for best possible results using Slow Cook:

- Completely thaw all frozen foods before cooking with the Slow Cook feature.
- When using a single rack, place in position 2 or 3 (see figure 1 on page 15).
- Position multiple racks to accommodate size of cooking utensils when cooking multiple food items.
- Do not open the oven door often or leave the door open when checking foods. If the oven heat escapes often, the Slow Cook time may need to be extended.
- Cover the foods to keep them moist or use a loose or vented type cover to allow foods to turn crisp or brown.
- Cook times will vary; depending on the weight, fat content, bone & the shape of the meat.
- Use the recipe's recommended food temperature and a food thermometer to determine when the food is done.
- Preheating the oven will not be necessary when using the Slow Cook feature.
- Add any cream or cheese sauces during the last hour of cooking.

INSTRUCTIONS

PRESS

DISPLAY

To Program the Oven to begin baking with the Slow Cook feature





1. Place the food in the oven.
2. Press . "SLO" and "HI" will appear in the display. The Slow Cook feature will be set to the high setting. This setting is best for cooking foods from a 4 to 5 hour time period (Figure 1).
4. Press again  to set the Slow Cook feature to the low setting (**Lo** will appear in the display). This setting is best for cooking foods from a 8 to 9 hour time period (Figure 2).
5. Press  (Figure 3).
6. If desired, add any **Timed Bake** or **Delayed Start Bake** settings at this time.
7. To cancel the Slow Cook feature press  at anytime.



Figure 1







Figure 2



Figure 3

Setting Oven Controls

Setting Timed Bake, Timed Convection Bake or Timed Convection Roast

The **BAKE**  or **CONVECTION BAKE**  or **CONVECTION ROAST**  and **OVEN COOK TIME**  pads control the Timed Bake feature. The automatic timer of the Timed Bake feature will turn the oven OFF after cooking for the desired amount of time you selected.

INSTRUCTIONS

PRESS

DISPLAY

To program the oven to begin baking immediately and to shut off automatically (example: BAKE at 350°F for 30 minutes)







1. Be sure the clock is set for the correct time of day.
2. Arrange interior oven rack(s) and place the food in the oven.
3. Press , "350" will appear and "BAKE" will flash in the display (Figure 1).
4. Press . "BAKE" and the actual oven temperature will appear in the display (See Figure 2).
5. Press . "TIMED" will flash; "BAKE", "--:--" and the actual temperature will appear in the display (Figure 3).
6. Enter the desired baking time by pressing   (Figure 4).
Note: Baking time can be set for any amount of time between 1 minute to 11 hours and 59 minutes.
7. Press . Both the "TIMED" and "BAKE" icons will remain on in the display and the actual oven temperature will be displayed (Figure 5). Once the Timed Bake feature has started, the current time of day will appear in the display.



Figure 1



Figure 2

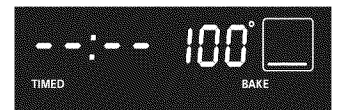

Figure 3



Figure 4



Figure 5



Note: After the Timed Bake feature has activated, press  to display the bake time remaining in the Timed Bake mode. Once Timed Bake has started baking, a beep will sound when the oven temperature reaches the set temperature.



Press  when baking has finished or at any time to cancel the Timed Bake feature.



Figure 6

When the timed bake finishes:

1. "End" and the time of day will show in display. The oven will shut off automatically (Figure 6).
2. The control will beep 3 times. The control will continue to beep 3 times every 30 seconds until  is pressed.







CAUTION Use caution with the **DELAY START** (Delayed Timed Bake) features. Use the automatic timer when cooking cured or frozen meats and most fruits and vegetables. Foods that can easily spoil such as milk, eggs, fish, meat or poultry, should be chilled in the refrigerator first. Even when chilled, they should not stand in the oven for more than 1 hour before cooking begins, and should be removed promptly when cooking is completed. Eating spoiled food can result in sickness from food poisoning.

ENGLISH

Setting Oven Controls

Setting Delayed Timed Bake or Delayed Timed Convection Bake













The **BAKE**  or **CONVECTION BAKE** , **OVEN COOK TIME**  and **DELAY START**  pads control the Delayed Time Bake feature. The automatic timer of the Delayed Time Bake will turn the oven **on and off** at the time you select in advance. **Note:** If your clock is set for normal 12 hour display mode the Delayed Timed Bake or Delayed Timed Convection Bake cycle can never be set to start more than 12 hours in advance. To set for Delayed Timed Bake or Delayed Timed Convection Bake 12-24 hours in advance set the control for the 24 hour time of day display mode.

INSTRUCTIONS

PRESS

DISPLAY

To program the oven for a delayed BAKE start time and to shut off automatically (example: baking at 350°F, starting at 5:30 and baking for 30 minutes)

1. Be sure that the clock is set with the correct time of day.
2. Arrange interior oven rack(s) and place the food in the oven.
3. Press . "350" will appear and "BAKE" will flash in the display (Figure 1).
4. Press . "BAKE" and the actual oven temperature will stay in the display (See Figure 2).
5. Press . "TIMED" will flash, "--:--" will appear and "BAKE" and the actual oven temperature will remain in the display (Figure 3).
6. Enter the desired baking time using the number pads by pressing   . "TIMED" will flash; "BAKE", "--:30" and the actual oven temperature will appear in the display (Figure 4). Note: Baking time can be set for any amount of time from 1 minute to 11 hours and 59 minutes.
7. Press . "TIMED", "BAKE" and the actual oven temperature will remain in the display (Figure 5).
8. Press . "DELAY" will flash in the display. Enter the desired start time using the number pads    (Figure 6).
9. Press . When Delayed Time Bake starts, the set oven temperature will appear, "DELAY", "BAKE" and the current time of day will appear in the display (Figure 7).
10. When the desired start time is reached, the actual oven temperature appears in display and "DELAY" disappears. Oven starts to bake at the previously selected temperature (Figure 8).

Note: Once Delayed Time Bake has started, press  to display the bake time remaining. Once the Delayed Timed Bake has started baking, a beep will sound when the oven temperature reaches the set temperature.

Press  when baking has completed or at any time to cancel the Delayed Time Bake feature.

When the set bake time runs out:

1. "End" will appear in the display and the oven will shut off automatically (Figure 9).
2. The control will beep 3 times. The control will continue to beep 3 times every 30 seconds until  is pressed.





Figure 1





Figure 2



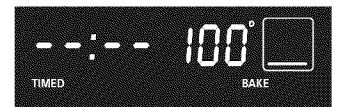

Figure 3



Figure 4





Figure 5





Figure 6





Figure 7





Figure 8







Figure 9



Setting Oven Controls (cont'd)

Setting the Food Categories Feature:

The **CAKES**  and **BREADS**  pads in the Food Categories feature are used when cooking certain food items. These pads have been designed to give optimum cook performance for the foods selected in each category.

The **CAKES** pad provides a preheat with a gentle cycling of heat giving cakes more volume and allowing delicate foods to cook more evenly.







The **BREADS** pad adds a preheat feature to the bake cycle to thoroughly heat the oven from top to bottom to give more evenly browned foods. Refer to (Figure 4) for foods to cook in each category.

INSTRUCTIONS

PRESS

DISPLAY

To set the Food Categories feature (example: for Cakes to cook at 375°F)

1. Arrange interior oven racks and place food in oven.
2. Press . "CAKES" will flash and "350°" will be displayed (See Figure 1). Note that if a bake temperature of 350°F is needed, simply press .
3. Press   . "CAKES" will flash and "375°" will appear in the display (See Figure 2).
4. Press . "CAKES" will stop flashing and "375°" will remain in the display (See Figure 3).

Press  to stop cooking Cakes or Breads, or to cancel cooking Cakes or Breads at any time.



Figure 1



Figure 2



Figure 3



ENGLISH

Recommended foods to be cooked in each category

<u>Cakes</u>	<u>Breads</u>
Cakes	Breads
Brownies	Rolls
Pies (fresh & frozen)	Biscuits
Baked Custards	Muffins
Cheesecake	Cornbread

Figure 4

Setting Oven Controls

Using and Setting Meat Probe

Checking the internal temperature of your food is the most effective way of insuring that your food has been properly cooked. When cooking meat such as roasts, hams or poultry you can use the meat probe to check the internal temperature without any guesswork. For some foods, especially poultry and roasts, testing the internal temperature is the best method to insure properly cooked meats.

Important things to consider:

- Use only the probe supplied with your appliance; any other may result in damage to the probe or the appliance.
- Handle the probe carefully when inserting and removing from the food or the receptacle.
- Do not use tongs to pull the cable when inserting or removing from the food or the receptacle.
- Defrost your food completely before inserting the probe to avoid damaging probe.
- Never leave or store the probe inside the oven when not in use.
- To prevent the possibility of burns, after cooking carefully unplug the probe using a pot holder.

Proper Meat Probe placement:

- Always insert the probe so that the tip rests in the center of the thickest part of the meat. Do not allow the probe to touch bone, fat, gristle or the pan.
- For bone-in ham or lamb, insert the probe into the center of the lowest large muscle or joint . For dishes such as meat loaf or casseroles, insert the probe into the center of the food. To find the center of the food visually measure with the probe (See Fig. 1). When cooking fish, insert the probe just above the gill.
- For whole poultry or turkey, insert the probe into the thickest part of the inner thigh, below the leg (See Fig. 2).

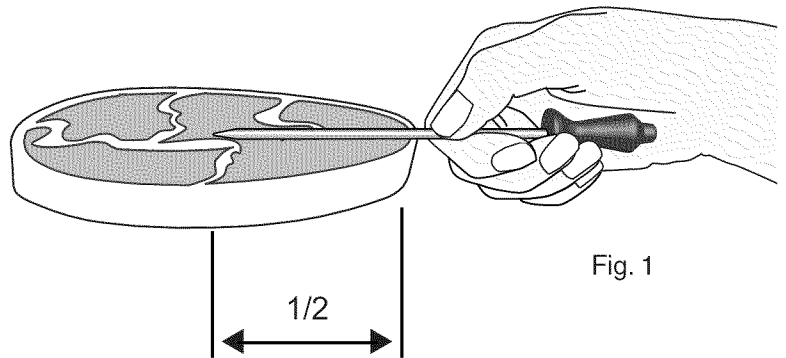

Fig. 1

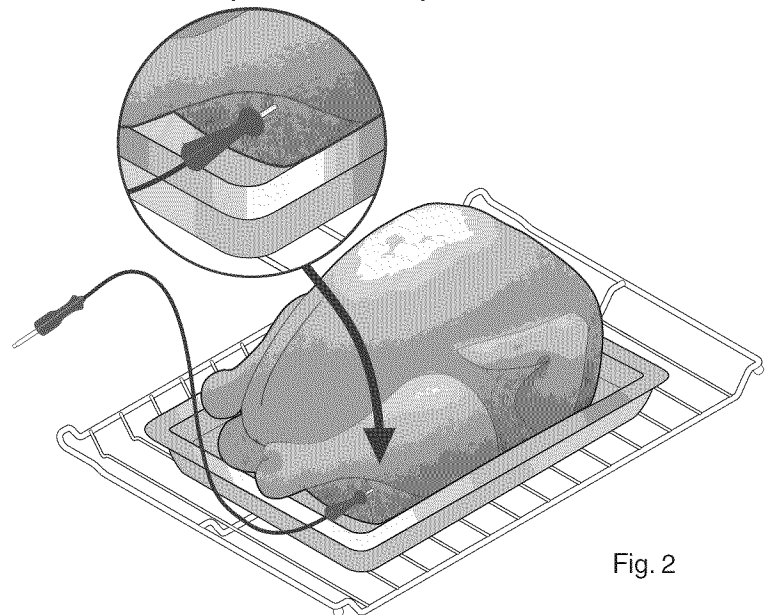

Fig. 2

USDA Minimum Recommended Internal Food Temperature









Fish	Beef, Veal, Lamb Steaks & Roasts	Pork	Egg Dishes	Beef, Veal, Lamb Ground	Turkey, Chicken & Duck Whole, Pieces & Ground
145°F 63°C	145°F 63°C	160°F 71°C	160°F 71°C	160°F 71°C	165°F 74°C

For more informations, visit: www.isitdoneyet.gov

Setting Oven Controls

Using and Setting Meat Probe

To use the meat probe:

1. Prepare the food and properly insert the temperature probe into the food. **DO NOT PREHEAT** or start cooking **before** properly inserting the meat probe. The probe should be inserted into the food and receptacle while the oven is still cool.
2. Place the prepared food on the desired oven rack position and slide into the oven.
3. Plug the meat probe into the probe receptacle located on the left front oven cavity side.
4. Close the oven door.
5. The oven control will detect if the meat probe is correctly plugged in and will illuminate with  icon in the display.
6. The actual meat probe temperature will appear in the display.
7. To set the target temperature press  pad once then enter the desired the desired target internal temperature using the numeric key pads (default setting is 170°F/77°C)[†]. Press  to accept the meat probe target temperature.
8. Set the oven control for ,  or  and the desired oven temperature. You may use the meat probe with some other baking features but cannot be set with **Broil** or **Flex-Clean**.
9. During the cooking process you may check the actual internal temperature by pressing the  key once. The actual temperature will display. After 8 seconds the display will return to the actual oven temperature.
10. If the target temperature needs to be changed during the cooking process, press  twice and use the numeric keypads to adjust the target temperature. Press the  key to accept the change.





[†] The U.S. Department of Agriculture states, "Rare fresh beef is popular, but you should know that cooking it to only 140°F/60°C means some food poisoning organisms may survive." (Source: Safe Food Book, Your Kitchen Guide, USDA Rev. June 1985.)

The lowest temperature recommended by the USDA is 145°F/63°C for medium rare fresh beef.

Setting the oven to automatically stop cooking after reaching meat probe target temperature:

The oven leaves the factory preset to alert you when the internal target temperature has been reached but to continue cooking at the oven set temperature. You may desire to change how your oven reacts when using the meat probe.

Note: Changing how the meat probe reacts must be done before starting the cooking process.

1. To set oven to shut-off automatically after reaching the Meat Probe target temperature press  and hold for 7 seconds then use the  key toggle to the message P CC (Probe, cancel cooking) then press  to accept.
2. Use the  key to toggle back to PnCC (Probe, no cancel cooking) and then press  to accept if you wish for the oven to continue cooking after the meat probe reaches the target temperature.

Setting Oven Controls (cont'd)

Setting the Warm & Hold™ Feature

The **Warm & Hold**  pad turns ON the Warm & Hold feature and will maintain an oven temperature of 170°F (77°C). The Warm & Hold feature will keep oven baked foods warm for serving up to 3 hours after cooking has finished. After 3 hours the Warm & Hold feature will shut the oven OFF. The Warm & Hold feature may be used without any other cooking operations or can be used after cooking has finished using BAKE, CONVECTION BAKE, CONVECTION ROAST.

The Warm & Hold feature may be used with TIMED BAKE if you wish to have the Warm & Hold feature turn ON automatically when cooking has finished. The Timed Bake features require you to set start time and the amount of cooking time. With this information the control can calculate the time when cooking will complete and can then start the Warm & Hold feature automatically.

INSTRUCTIONS

PRESS

DISPLAY

To set Warm & Hold



1. Arrange interior oven racks and place food in oven.
2. Press . "HLd" will appear in the display (Figure 1).
Note: If no pad is touched within 25 seconds the request to turn ON Warm & Hold feature will be cancelled.
3. Press . The oven icon will appear in the display (Figure 2).
4. To turn the Warm & Hold OFF at any time press .
Note: The Warm & Hold feature will automatically turn OFF after 3 hours.



Figure 1



Figure 2

To set Warm & Hold to turn ON automatically





1. Arrange interior oven racks and place food in oven. Set the oven properly for **Timed Bake or Delayed Timed Bake**.
2. Press  (Figure 3).
Note: If no pad is touched within 25 seconds the request to turn ON Warm & Hold feature all functions previously programmed will be cleared.
3. Press . "HLd" will disappear and the temperature will be displayed (Figure 4). The Warm & Hold mode is set to turn ON automatically after Timed Bake has finished (See Figure 2).
4. To turn the Warm & Hold feature OFF at any time press .
Note: The Warm & Hold feature will automatically turn OFF after 3 hours.



Figure 3



Figure 4

Pressing  at any time will stop all oven baking operations.



Setting Oven Controls

Setting Broil

The **Broil** pad controls the Broil feature. When broiling, heat radiates downward from the oven broiler for even coverage. The Broil feature temperature may be set between 400°F and 550°F. This appliance includes a Searing Grill for searing meats (Figure 5). The broil pan and broil pan insert used together allow dripping grease to drain and be kept away from the high heat of the oven broiler. **DO NOT** use the broil pan without the insert (See Figure 4). **DO NOT cover the broil pan insert with foil.** The exposed grease could catch fire.

⚠ WARNING Should an oven fire occur, leave the oven door closed and turn off the oven. If the fire continues, throw baking soda on the fire or use a fire extinguisher. **DO NOT** put water or flour on the fire. Flour may be explosive and water can cause a grease fire to spread and cause personal injury.

INSTRUCTIONS

To set the oven to broil at 500°F.

1. Place the broiler pan insert on the broiler pan. Then place the food on the broiler pan insert. **DO NOT** use the broiler pan without the insert. **DO NOT** cover the broiler insert with foil. The exposed grease could ignite.
2. Arrange the interior oven rack and place the broiler pan on the rack. Be sure to center the broiler pan directly under the broiler element.
3. Press **Broil**. "BROIL" will flash and "550" will appear (Figure 1).
4. Press **5 0 0**.
5. If a lower broil temperature is desired (minimum broil temperature setting is 400°F), press the desired temperature before continuing to step 6.
6. Press **START**. The oven will begin to broil. "BROIL" and "500°" will appear in the display (Figure 2).
7. Broil on one side until food is browned; turn and cook on the second side. Season and serve. **Note:** Always pull the rack out to the stop position before turning or removing food.
8. To cancel broiling press **STOP** (Figure 3).

PRESS

DISPLAY



Figure 1



Figure 2



Figure 3

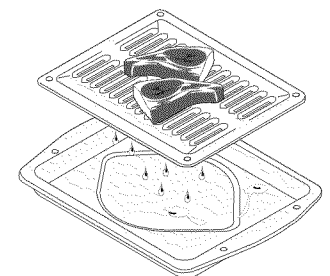
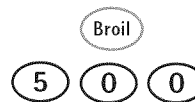
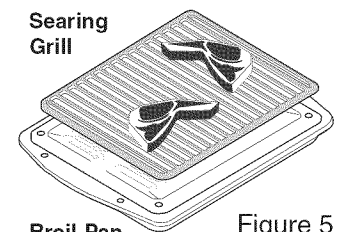

Figure 4



Broil Pan & insert

Figure 5

Broiling Times and Searing Grill

Use the following table for approximate broiling times. Increase or decrease broiling times, or move the broiling pan to a different rack position to suit for doneness. If the food you are broiling is not listed in the table, follow the instructions provided in your cookbook and watch the item closely. Use the Searing Grill for meats and steaks if desired. Before placing the meat, be sure to heat the Searing Grill using Broil for 10 minutes. Cook times should be reduced 1-2 minutes per side when cooking with the Searing Grill. Place Searing Grill on top of Broiler Pan and insert for meats and steaks (See Figure 5).

Electric Range Broiling Table Recommendations

Food Item	Rack Position	Temp Setting	Cook Time		Doneness
			1st side	2nd side	
Steak 1" thick	2nd	550° F	6:00	4:00	Rare
	2nd	550° F	7:00	5:00	Medium
Pork Chops 3/4" thick	2nd	550° F	8:00	6:00	Well
Chicken - Bone In	3rd	450° F	20:00	10:00	Well
Chicken - Boneless	2nd	450° F	8:00	6:00	Well
Fish	2nd	500° F	13:00	n/a	Well
Shrimp	3rd	550° F	5:00	n/a	Well
Hamburger 1" thick	2nd	550° F	9:00	7:00	Medium
	3rd	550° F	10:00	8:00	Well

Setting Oven Controls

To Set the Sabbath Feature (for use on the Jewish Sabbath & Holidays)

The ^{Timed Oven} **COOK TIME** and **DELAY START** pads are used to set the Sabbath feature. The Sabbath feature may only be used with the **Bake** pad. The oven temperature may be set higher or lower after setting the Sabbath feature (the oven temperature adjustment feature should be used only during Jewish Holidays), however the display will not visibly show or provide any audible tones indicating whether the change occurred correctly. Once the oven is properly set using Bake with the Sabbath feature active, the oven will remain continuously ON until cancelled. This will override the factory preset 12-Hour Energy Saving feature.

If the oven light will be needed during the Sabbath, press  before activating the Sabbath feature. Once the oven light is turned ON and the Sabbath feature is active, the oven light will remain ON until the Sabbath feature is turned OFF. If the oven light needs to be OFF, be sure to turn the oven light OFF before activating the Sabbath feature.

IMPORTANT NOTES: It is not advised to attempt to activate any other program feature other than **BAKE** while the Sabbath feature is active. ONLY the following key pads will function after setting the Sabbath feature; **0** to **9**,

Bake, **START** & **STOP**. ALL OTHER KEYPADS should not be used once the Sabbath feature is properly activated.

INSTRUCTIONS

To Program the Oven to Begin Baking Immediately & activate the Sabbath feature (example: baking at 350°F)

1. Be sure that the clock is set with the correct time of day.
2. Place the food in the oven.
3. Press **Bake**. "350°" appears in the display.
4. Press **START** (Figure 1).
5. If you desire to set the oven control for a **Timed Bake** or **Delayed Start Bake** do so at this time. If not, skip this step and continue to step 7. Refer to the **Timed Bake** (complete steps 5-7) / **Delayed Start Bake** (complete steps 6-10) section for complete instructions. Remember the oven will shut down after using **Timed Bake** or **Delay Start Bake** and therefore may only be used once during the Sabbath/Jewish Holidays. The maximum **Delayed Start Bake** time is 11 hours & 59 minutes.
6. The oven will turn ON and begin heating.
7. Press and hold both the ^{Timed Oven} **COOK TIME** and **DELAY START** pads for at least 3 seconds. **SAb** will appear in the display (Figure 2). Once **SAb** appears in the display the oven control will no longer beep or display any further changes and the oven is properly set for the Sabbath feature.

PRESS

DISPLAY



Figure 1



Figure 2

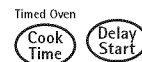

Note: You may change the oven temperature once baking has started by pressing **Bake**, the numeric key pads for the temperature you want (example for 425°C press **4**, **2**, **5**) and then pressing **START** TWICE (for Jewish Holidays only). Remember that **the oven control will no longer beep or display any further changes** once the oven is set for the Sabbath feature.

8. The oven may be turned OFF at any time by first pressing **STOP** pad (this will turn the oven OFF only). To turn OFF the Sabbath feature press and hold both the ^{Timed Oven} **COOK TIME** and **DELAY START** pads for at least 3 seconds. **SAb** will disappear from the display (Figure 3).

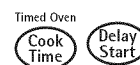



Figure 3

Setting Oven Controls

To Set the Sabbath Feature (for use on the Jewish Sabbath & Holidays) (continued)

Should you experience a power failure or interruption, the oven will shut off. When power is returned the oven will not turn back on automatically. If your food was nearly fully cooked, you may allow the trapped heat in the oven to finish the cooking process. Otherwise, you should remove the food when the power failure occurs, because you may only start the oven once during the Sabbath/Jewish Holidays. After the Sabbath observance turn OFF the Sabbath feature and the oven may be used with all normal functions.





After the Sabbath observance turn OFF the Sabbath feature. Press and hold both the  and  pads for at least 3 seconds. **SAb** will disappear from the display and the oven may be used with all normal functions. For further assistance, guidelines for proper usage, and a complete list of models with the Sabbath feature, please visit the web at <http://www.star-k.org>.

To Set the Recipe Recall Feature

This feature will ONLY recall a **Bake, Convection Bake, Convection roast, Slow Cook, Cakes, Breads, Timed Bake** or a **Timed Bake** with a **Warm & Hold** added setting. This feature will not work with any other function including a **Delayed Timed Bake**, a **Clean Cycle** or a **Broil** setting.

INSTRUCTIONS

To Program the Oven to Begin Baking Immediately and record a Recipe (example: for a Bake mode at 375°C)

1. Place the food in the oven.
2. Press . "350" appears and "BAKE" will flash in the display (Figure 1).
3. Enter the desired roasting temperature using the number pads    (Figure 2).
4. Press and hold  pad for at least 3 seconds or until a beep sounds. The beep indicates that this recipe has been recorded for future recall.

PRESS

DISPLAY





Figure 1

for 3 seconds.



Figure 2

To Program the Oven to Begin Baking with a stored Recipe



1. Place the food in the oven.
2. Press  " 375 " appears and "BAKE" will flash in the display (Figure 2) and  (Figure 3).









Figure 3

To Quickly Erase all Stored Recipes:

1. Press and hold the  key pad until the first single beep sounds (6 seconds).
2. After the first beep press the  key pad once. Any stored recipes will be erased. Please note: Clearing the recipes will also reset all other adjustments back to the factory settings. These include **12 or 24 Hour Time of Day Display, Continuous Bake or 12 Hour Energy Savings mode, Silent Control Operation, Fahrenheit or Celsius Temperature Display** and any Oven Temperature adjustments that are set.

Setting Warmer Drawer Controls (SOME MODELS ONLY)

Arranging Warmer (Warm & Ready™) Drawer Rack Positions

The rack can be used in 2 ways:

- In the **upright position** to allow low profile food items to be placed both under and on top of the rack (for example, rolls or biscuits on top of the rack and a casserole dish underneath).
- In the **downward position** to allow you to place light weight food items and empty dishware (for example, rolls or pastries and dinner plates) on the rack.

Set the Warmer Drawer Rack in either position as shown below (Figure 1).

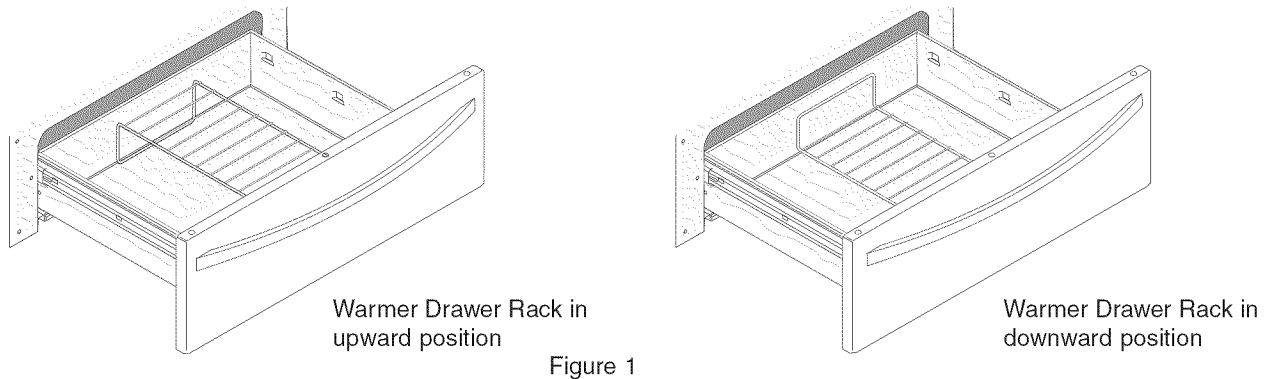

Operating the Warmer Drawer

The purpose of the Warmer Drawer is to keep hot cooked foods at serving temperature. Always start with hot food. It is not recommended to heat cold food in the Warmer Drawer. All food placed in the Warmer Drawer should be covered with a lid or aluminum foil to maintain quality. **Do not use plastic wrap to cover food. Plastic may melt onto the drawer and be very difficult to clean.** Use only utensils and cookware recommended for oven use in the Warmer Drawer.

CAUTION Always use potholders or oven mitts when removing food from the Warmer Drawer as cookware and plates will be hot and you can be burned.

Warmer Drawer Food Temperature Settings

Use the recommended settings in the Warmer Drawer settings table. If a particular food is not listed, start with the **MED** setting. If more crispness is desired, remove the lid or aluminum foil from the food. Most foods can be kept at serving temperatures on the **MED** setting. When a combination of foods are to be kept warm (for instance, meat with 2 vegetables and rolls), use the **HI** setting. To avoid heat loss, do not open the Warmer Drawer repeatedly while in use.

Warmer (Warm & Ready™) Drawer & Bread Proofing Indicator Lights

The control and indicator lights for the Warmer Drawer and Bread Proofing features are located on the control panel. The indicator lights will turn ON when the control is set, and remain ON until the controls are turned OFF.

Note: The warmer Drawer will not operate during the Self-Clean cycle.







Warmer Drawer Settings Table	
Food Item	Setting
Bacon	HI
Hamburger Patties	HI
Poultry	HI
Pork Chops	HI
Fried Foods	HI
Pizza	HI
Gravies	MED
Casseroles	MED
Eggs	MED
Roasts (Beef, Pork, Lamb)	MED
Vegetables	MED
Biscuits	MED
Rolls, hard	MED
Pastries	MED
Rolls (soft)	LO
Empty Dinner Plates	LO

Figure 2

Setting Warmer Drawer Controls (cont'd) (SOME MODELS ONLY)

To Set the Warmer Drawer & Bread Proof Controls:

The control and indicator lights for the Warmer Drawer Bread Proof features are located on the control panel. The temperatures are approximate, and are designated by **HI** (high), **MED** (medium) and **LO** (low) and **BREAD PROOF**.

1. Touch the **ON/OFF** pad at the Warmer Drawer control position. The Warmer Drawer indicator light will flash. **Note:** If no further pads are touched within 25 seconds the request to power the Warmer Drawer ON will clear.
2. Set the desired power level. Touch  once to turn ON the power level for HI (see Figure 2) or  to turn ON the power level for LO (see Figure 4). The Warmer Drawer indicator light located above the ON/OFF pad will turn ON steady.
3. Each touch of the  or  pads will decrease or increase through 6 power levels from **HI** (see Figure 2) to **MED** (see Figure 3) to **LO** (see Figure 4) and to the **Bread Proof** feature (see Figure 5). If the Warmer Drawer is set at the **LO** setting and the  pad is touched again the Bread Proof feature and indicator light will be set (see Figure 5 and bread dough preparation instructions on this page). To return to standard Warmer Drawer setting touch  pad at least once.

Note: For best results, preheat the Warmer Drawer before adding the food or bread dough. An empty drawer will preheat in approximately 15 minutes.
4. When the food is ready for removal, touch the **ON/OFF** pad once to turn the Warmer Drawer or bread Proof feature OFF. The Warmer Drawer indicator light will turn OFF.

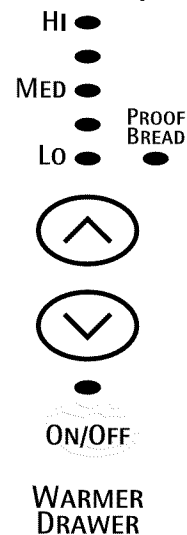
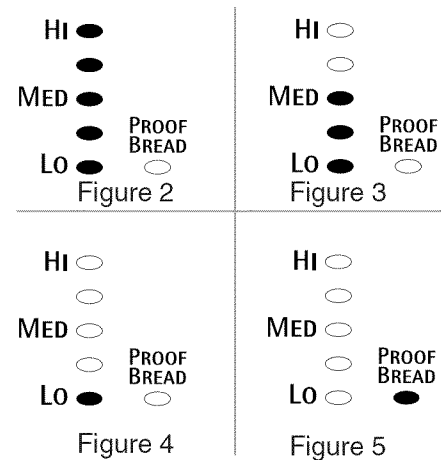

Figure 1



ENGLISH

Preparing Bread Dough for the Warmer Drawer

The Warmer Drawer has a "Proof Bread" feature that can be used to help prepare bread dough. The recommended length of time to keep bread dough in the Warmer Drawer is about 45-60 minutes. Be sure however to follow the recipe's recommended times.

The prepared bread dough should be placed in a large bowl since the dough will nearly double in volume. Arrange the Warmer Drawer Rack in the downward position (see Figure 6). Place the bowl in the Warmer Drawer and follow the Warmer Drawer and Bread Proof Control setting instructions at the top of this page.

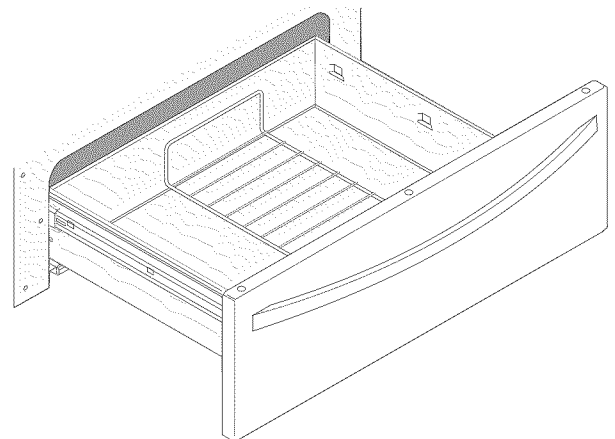

Figure 6

Self-Cleaning

CAUTION During the Self-Cleaning cycle, the outside of the range can become very hot to the touch. **DO NOT** leave small children unattended near the appliance.

CAUTION The health of some birds is extremely sensitive to the fumes given off during the Self-Cleaning cycle of any range. Move birds to another well-ventilated room.

CAUTION DO NOT line the oven walls, racks, bottom or any other part of the range with **aluminum foil**. Doing so will destroy heat distribution, produce poor baking results and cause permanent damage to the oven interior (aluminum foil will melt to the interior surface of the oven).

CAUTION DO NOT force the oven door open. This can damage the automatic door locking system. Use caution when opening the door after the Self-Cleaning cycle is completed. The oven may still be **VERY HOT**.

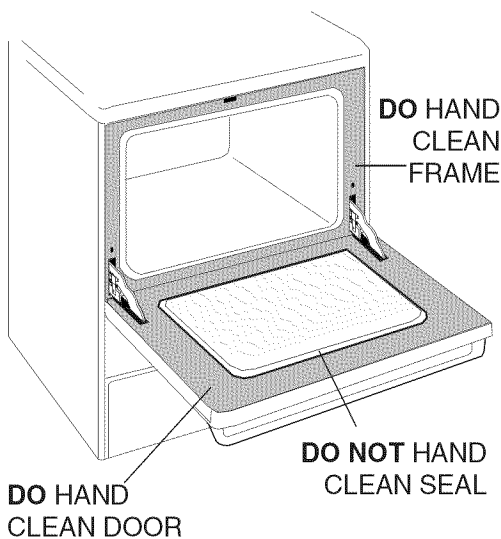

Note: See additional cleaning information for the oven door in the **General Care & Cleaning** section.

CAUTION To avoid possible burns use care when opening the oven door after the Self-Cleaning cycle. Stand to the side of the oven when opening the door to allow hot air or steam to escape.

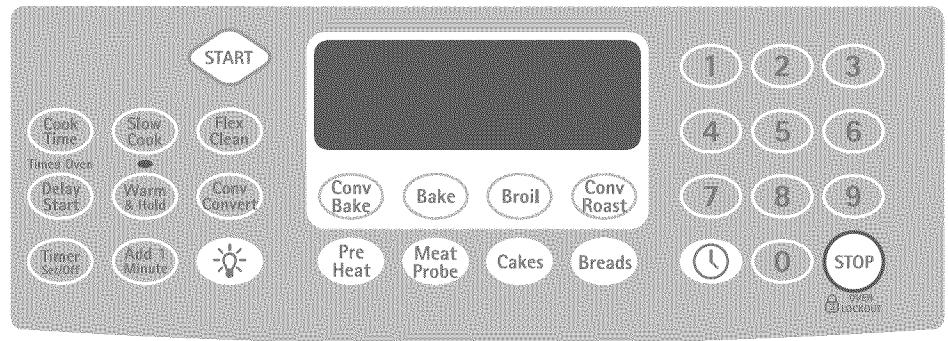

Self-Cleaning Oven

A Self-Cleaning oven cleans itself with high temperatures (well above cooking temperatures) which eliminate soils completely or reduces them to a fine powdered ash you can wipe away with a damp cloth.

Adhere to the following cleaning precautions:

- **DO NOT** use oven cleaners or oven protective coatings in or around any part of the Self-Cleaning oven.
- **DO NOT** clean the oven door gasket. The woven material of the oven door gasket is essential for a good seal. Care should be taken not to rub, damage or remove the gasket.
- **DO NOT** use any cleaning materials on the oven door gasket. Doing so could cause damage.
- **Remove the broiler pan and insert, all utensils and any aluminum foil. These items cannot withstand high cleaning temperatures.**
- Porcelain oven racks do not have to be removed. After the cycle is complete and the oven has cooled, rub the sides of the oven racks with wax paper or a cloth containing a small amount of salad oil (this will make the racks glide easier into the rack position).
- **Remove any excessive spillovers** in the oven cavity **before** starting the Self-Cleaning cycle. To clean, use hot, soapy water and a cloth. Large spillovers can cause heavy smoke or fire when subjected to high temperatures. **DO NOT** allow food spills with a high sugar or acid content (such as milk, tomatoes, sauerkraut, fruit juices or pie filling) to remain on the surface as they may leave a dull spot even after cleaning.
- Clean any soil from the oven frame, the door liner outside the oven door gasket and the small area at the front center of the oven bottom. These areas heat sufficiently to burn soil on. Clean with soap and water.

NOTE: Prior to setting the Self-Clean cycle, any spills remaining on the oven bottom should be removed.

What to Expect during Cleaning

While the oven is in operation, the oven heats to temperatures much higher than those used in normal cooking. Sounds of metal expansion and contraction are normal. Odor is also normal as the food soil is being removed. Smoke may appear through the oven vent.

If heavy spillovers are not wiped up before cleaning, they may flame and cause more smoke and odor than usual. This is normal and safe and should not cause alarm. If available, use an exhaust fan during the self-cleaning cycle.

Self-Cleaning

What to Expect during Cleaning

While the oven is in operation, the oven heats to temperatures much higher than those used in normal cooking. Sounds of metal expansion and contraction are normal. Odor is also normal as the food soil is being removed. Smoke may appear through the oven vent. If heavy spillovers are not wiped up before cleaning, they may flame and cause more smoke and odor than usual. This is normal and safe, and should not cause alarm. If available, use an exhaust fan during the self-cleaning cycle.

Self-Clean Cycle Time Length

The **FLEX CLEAN**  pad controls the Self-Cleaning feature. If you are planning to use the oven directly after a self-clean cycle remember to allow time for the oven to cool down and the oven door to unlock. This normally takes about one hour. So a 3 hour self-clean cycle will actually take about 4 hours to complete.









*It is recommend to use a 2 hour self-clean cycle for **light soils**, a 3 hour cycle for **average soils**, and a 4 hour cycle for **heavy soils** (to assure satisfactory results).

CAUTION To avoid possible burns use care when opening the oven door after the Self-Cleaning cycle. Stand to the side of the oven when opening the door to allow hot air or steam to escape.

CAUTION DO NOT force the oven door open. This can damage the automatic door locking system. Use caution and avoid possible burns when opening the door after the Self-Cleaning cycle has completed. The oven may still be VERY HOT.

INSTRUCTIONS

To set the controls for a 3 hour Self-Cleaning cycle to start immediately and shut off automatically

1. Be sure the clock is set with the correct time of day and the oven door is closed.
2. Press . "CLEAN" will flash and "3:00" HR will show in the display (Figure 1). The control will automatically clean for a 3 hour period (default self-cleaning cycle time). Note: If a 2 or 4 hour clean time is desired, press    for 2 hour or press    for a 4 hour clean time. Set the cleaning time based on the amount of soil: light, medium or heavy (* See above).
3. Press . The "DOOR LOCKED" icon will flash; "CLEAN" and the letters "CLn" will remain on in the display (Figure 2).
4. As soon as the control is set, the motor driven oven door lock will begin to close automatically. Once the door has been locked the "DOOR LOCKED" indicator light will stop flashing and remain on. Also, the oven icon will appear in the display (Figure 3).

Note: Allow about 15 seconds for the oven door lock to close.

When the Self-Clean Cycle is Completed

1. "HOT" will appear in the display. The time of day, the "DOOR LOCKED" and "CLEAN" icon will remain in the display (Figure 4).
2. Once the oven has cooled down for approximately 1 HOUR, and the "DOOR LOCKED" is longer displayed, the oven door can then be opened (Figure 5).

Stopping or Interrupting a Self-Cleaning Cycle

If it becomes necessary to stop or interrupt a self-cleaning cycle due to excessive smoke or fire in the oven:

1. Press .
2. The oven door can only be opened after the oven has cooled down for approximately 1 HOUR and the "DOOR LOCKED" icon is no longer displayed (Figure 5).

PRESS

DISPLAY

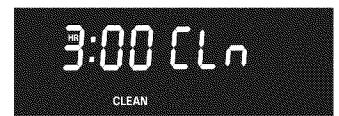
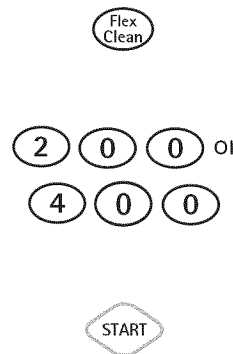

Figure 1



Figure 2



Figure 3





Figure 4



Figure 5













Self-Cleaning

To Start the delayed Self-Clean Cycle

The **FLEX CLEAN** , **DELAY START**  pads and length of clean cycle, controls the Delayed Self-Clean operation. The automatic timer will turn the oven **on and off** at the time you select in advance. Be sure to review **TO START THE SELF-CLEAN CYCLE** for recommended clean times.

INSTRUCTIONS

To set the control for the Self-Cleaning Cycle to start at a delayed time and shut off automatically (example: 3 hour self-clean cycle to start at 4:30)

1. Be sure the clock is set with the correct time of day and the oven door is closed.
2. Press . "CLEAN" will flash and "3:00" HR will show in the display (Figure 1). The control will automatically clean for a 3 hour period (default self-cleaning cycle time). Note: If a 2 or 4 hour clean time is desired, press    for 2 hour or press    for a 4 hour clean time. Set the cleaning time based on the amount of soil—light, medium or heavy (*See previous page).
3. Press . The "DOOR LOCKED" icon will flash; "CLEAN" and the letters "CLn" will remain on in the display (Figure 2).
4. Press . Enter the desired start time using the number pads    (Figure 3).
5. Press . "DELAY", "DOOR LOCKED" and "CLEAN" icons will remain on (Figure 4).
6. As soon as the control is set, the motor driven oven door lock will begin to close automatically. Once the door has been locked the "DOOR LOCKED" indicator light will quit flashing and remain on.
7. The control will start the self-cleaning at the set start time, for the period of time previously selected. At that time, the icon "DELAY" will go out; "CLn" and oven icon will appear in the display (Figure 5).

When the Self-Clean Cycle is Completed

1. "HOT" will appear in the display. The time of day, the "DOOR LOCKED" and "CLEAN" icon will remain in the display (Figure 6).
2. Once the oven has cooled down for approximately 1 HOUR, and the "DOOR LOCKED" is no longer displayed, the oven door can then be opened (Figure 7).

PRESS

DISPLAY



Figure 1

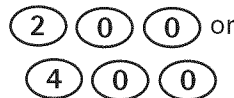

Figure 2



Figure 3

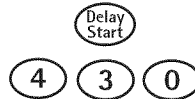

Figure 4



Figure 5



Figure 6



Figure 7

Self-Cleaning

INSTRUCTIONS

PRESS

DISPLAY

Stopping or Interrupting a Self-Cleaning Cycle

If it becomes necessary to stop or interrupt a self-cleaning cycle due to excessive smoke or fire in the oven:

1. Press .
2. Once the oven has cooled down for approximately 1 HOUR and the "DOOR LOCKED" icon is no longer displayed, the oven door can then be opened (Figure 1).



Figure 1

Note: Self-Clean cycle can never be set to start more than 12 hours in advance.

Adjusting Oven Temperature

The temperature in the oven has been pre-set at the factory. When first using the oven, be sure to follow recipe times and temperatures. If you think the oven is cooking too hot or too cool for the temperature you select, you can adjust the actual oven temperature to be more or less than what is displayed. Before adjusting, test a recipe by using a temperature setting that is higher or lower than the recommended temperature. The baking results should help you to decide how much of an adjustment is needed.

Note: The oven temperature adjustments made with this feature will not change the Self-Clean cycle temperature or the Broil temperature.

INSTRUCTIONS

PRESS

DISPLAY

To adjust the oven temperature higher





1. Press  for 6 seconds (Figure 2).
2. To increase the temperature use the number pads to enter the desired change (Example 30°F)   (Figure 3). The temperature may be increased as much as 35°F (19°C).
3. Press  to accept the temperature change and the display will return to the time of day (Figure 4). Press  to reject the change if necessary.



Figure 2



Figure 3



Figure 4

To adjust the oven temperature lower







1. Press  for 6 seconds. 0° will appear in the display (Figure 5).
2. To decrease the temperature use the number pads to enter the desired change (Example -30°F)   and then press  (Figure 6). The temperature may be decreased as much as 35°F (19°C).
3. Press  to accept the temperature change and the display will return to the time of day (Figure 7). Press  to reject the change if necessary.



Figure 5



Figure 6



Figure 7

Note: The oven temperature adjustments are permanent and will stay forever in the unit memory unless you manually change it again. Even a power outage will not reset these changes. Follow the same procedure again if you wish to change it to a different setting.

General Care & Cleaning

Cleaning Various Parts of Your Range

Before cleaning any part of the range, be sure all controls are turned OFF and the range is cool. Remove spillovers and heavy soiling as soon as possible. Regular cleanings will reduce the effort required for major cleanings later.

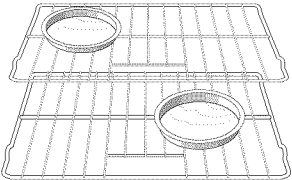
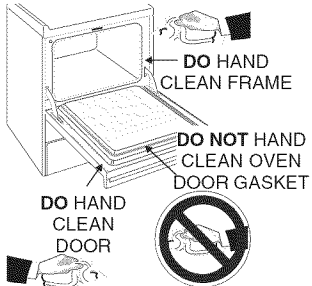
Surfaces	How to Clean
Aluminum & Vinyl Control Panel and Trim Pieces	<p>Use hot, soapy water and a cloth. Dry with a clean cloth.</p> <p>Before cleaning the control panel, turn all controls to OFF and remove the control knobs. To remove, pull each knob straight off the shaft. Clean using hot, soapy water and a dishcloth. Rinse with a clean water and a dishcloth. Be sure to squeeze excess water from the cloth before wiping the panel; especially when wiping around the controls. Excess water in or around the controls may cause damage to the appliance. Be sure to rinse the cleaners as bluish stains may occur during heating and cannot be removed. To replace knobs after cleaning, line up the flat sides of both the knob and the shaft; then push the knob into place.</p>
Glass, Painted and Plastic Body Parts, Control Knobs and Decorative Trim Pieces	<p>Using a soft cloth, clean with mild dish detergent and water or a 50/50 solution of vinegar and water. Follow by rinsing the area with clean water; dry and polish with a soft cloth. Glass cleaners may be used if sprayed on a soft cloth first. DO NOT spray liquids directly on the control pad and display area. Do not use large amounts of water on the control panel - excess water on the control area may cause damage to the appliance. Do not use other liquid cleaners, abrasive cleaners, scouring pads, or paper towels - they will damage the finish. To remove control knobs, turn to the OFF position; grasp firmly and pull straight off the shaft. To replace knobs after cleaning, line up the flat sides of both the knob and the shaft; then push the knob into place.</p>
Stainless Steel (some models) Oven door & drawer front panel	<p>Clean with hot, soapy water and dishcloth. Rinse with clean water and cloth. Do not use cleaners with high concentrations of chlorides or chlorines. Do not use harsh scrubbing cleaners. Only use kitchen cleaners that are especially made for cleaning stainless steel. Always be sure to rinse the cleaners off from the surface as bluish stains may occur during heating that cannot be removed.</p>
Oven Racks 	<p>This oven comes with lubricated porcelain oven racks, which can remain in the oven during the self-clean cycle. Do not clean this vegetable oil lubrication off the racks. It is important that the sides of the oven racks always have a light coating of vegetable oil. To maintain optimal rack performance, re-apply a thin layer of vegetable oil to the sides of the rack after every self-clean cycle or when the rack becomes difficult to slide.</p>
Porcelain Enamel Broiler Pan and Insert, Door Liner, Body Parts and Warmer Drawer and Drawer Cavity.	<p>Gentle scouring with a soapy scouring pad will remove most spots. Rinse with a 1:1 solution of clear water and ammonia. If necessary, cover difficult spots with an ammonia-soaked paper towel for 30 to 40 minutes. Rinse with clean water and a damp cloth, and then scrub with a soap-filled scouring pad. Rinse and wipe dry with a clean cloth. Remove all cleaners or the porcelain may become damaged during future heating. DO NOT use spray oven cleaners on the cooktop.</p>
Oven Door 	<p>Use soap & water to thoroughly clean the top, sides and front of the oven door. Rinse well. You may use a glass cleaner on the outside glass of the oven door. DO NOT immerse the door in water. DO NOT spray or allow water or the glass cleaner to enter the door vents. DO NOT use oven cleaners, cleaning powders or any harsh abrasive cleaning materials on the outside of the oven door.</p> <p>DO NOT clean the oven door gasket. The oven door gasket is made of a woven material, on Self-Cleaning models, which is essential for a good seal. Care should be taken not to rub, damage or remove this gasket.</p>
Cooktop, Burner Heads, Burner Caps & Grates	<p>See <i>Cleaning the Cooktop, Burner Caps, Burner Heads & Grates</i> in the General Care & Cleaning section for complete instructions.</p>

General Care & Cleaning (cont'd)

Cleaning the Cooktop, Burner Heads, Caps & Grates

The cooktop is designed to make cleaning easier. Because the gas Burners are sealed, cleanups are easy when spills are cleaned up immediately.

The cooktop, Burner Heads and Caps should be routinely cleaned. Keeping the Burner Head Ports clean will prevent improper ignition and an uneven flame. Refer to the following instructions:

THE COOKTOP IS NOT REMOVABLE. Do not attempt to remove or lift the cooktop.



THE FIXED OVEN VENT IS NOT REMOVABLE. Do not attempt to remove the fixed oven vent cover.

CAUTION Use caution when replacing the Burner Caps so the Electrodes are not damaged. This may cause a delayed ignition or prevent the burner from igniting.

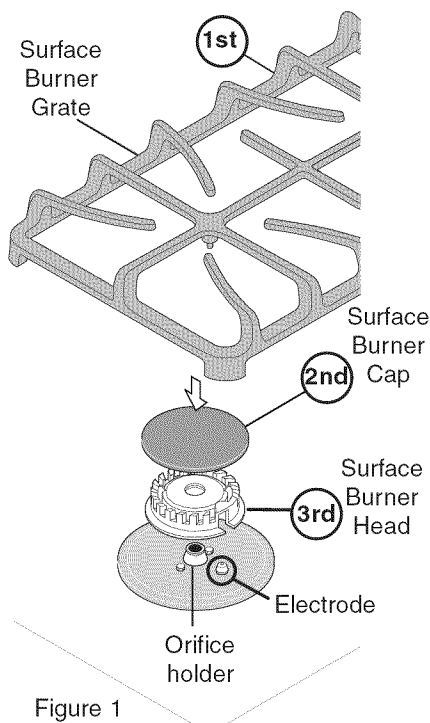

Figure 1

To Remove and Replace the Surface Burner Caps and Burner Heads -

Remove in the following order: (1st) surface Burner Grates, (2nd) Burner Caps and (3rd) Burner Heads. Replace in the following order: Burner Heads, Burner Caps and Burner Grates.

To Remove and Replace the Triple Burner Parts (some models only) -

Follow the steps described in the section Before Setting Surface Controls at page 9.

Do not remove any parts from the cooktop until they have completely cooled and are safe to handle. Do not operate the surface Burners without the Burner Caps and Burner Heads properly in place.

To Clean the surface Burner Caps and Burner Heads (all models)- Use a soap-filled scouring pad or a mild abrasive cleanser to clean the surface Burner Caps and Burner Heads. The ports (or slots) around the Burner Heads must be routinely cleaned. If residue still remains in these ports, use a small-gauge wire or needle to clean the slots or holes. For proper flow of gas and ignition of the burner—**DO NOT ALLOW SPILLS, FOOD, CLEANING AGENTS OR ANY OTHER MATERIAL TO ENTER THE GAS ORIFICE HOLDER OPENING.** **ALWAYS** keep the surface Burner Caps and Burner Heads in place whenever the gas Burners are in use.

To Clean the Burner Grates (all models)- The Burner Grates are dishwasher safe and may be cleaned in the dishwasher. Remove any excessive soils before placing in the dishwasher.

To Clean the Cooktop and contoured areas of the cooktop (all models)- If a spill occurs on the porcelain cooktop, blot up spill with an absorbent cloth. Rinse with a clean, damp cloth and wipe dry. Do not use harsh abrasive cleaners on the cooktop. They can scratch the porcelain. Completely rinse any mild cleaners used from the surface or the porcelain cooktop may become damaged during future heating. **DO NOT** use spray oven cleaners on the cooktop.

General Care & Cleaning (cont'd)



Do not use the following on the ceramic glass cooktop:

- Do not use abrasive cleaners and scouring pads, such as metal and some nylon pads. They may scratch the cooktop, making it more difficult to clean.
- Do not use harsh cleaners, such as chlorine bleach, ammonia or oven cleaners, as they may etch or discolor the cooktop.
- Do not use dirty sponges, cloths or paper towels, as they can leave soil or lint on the cooktop which can burn and cause discoloration.

Special Caution for Aluminum Foil and Aluminum Cooking Utensils

- **Aluminum foil**
Use of aluminum foil will damage the cooktop. Do not use under any circumstances.
- **Aluminum utensils**
Since the melting point of aluminum is much lower than that of other metals, care must be taken when aluminum pots or pans are used. Pans that boil dry may permanently damage cooktop by breaking, fusing to, or marking it.

Care and Cleaning of Stainless Steel (Stainless Steel models only)

Some models are equipped with stainless steel exterior parts. Special care and cleaning are **required** for maintaining the appearance of stainless parts. Please refer to the table provided at the beginning of the **General Care & Cleaning** section in this Use & Care Guide.

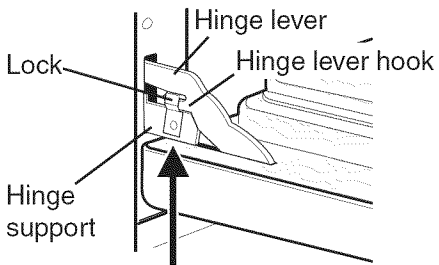

Lock engaged for door removal
Figure 1

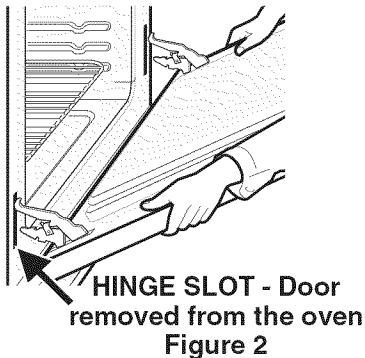

Removing and Replacing the Oven Door

CAUTION The door is heavy. For safe, temporary storage, lay the door flat with the inside of the door facing down.

To Remove Oven Door:

1. Open the door to the fully opened position.
2. Pull up the lock located on each hinge support and engage it onto the hinge lever hook (Figure 1). You may have to apply a little downward pressure on the door to pull the lock fully over the hinge lever hook.
3. Grab the door by the sides and pull the bottom of the door up and toward you to disengage the hinge supports. Keep pulling the bottom of the door toward you while rotating the top of the door toward the range to completely disengage the hinge levers (Figure 2).
4. To clean oven door, follow the instructions provided in the **General Care & Cleaning** table.

To Replace Oven Door:

1. Grab the door by the sides; place the hinge supports and levers into the hinge slots. Open the door to the fully opened position.
2. Disengage the lock from the hinge lever hooks on both sides (Figure 3).
Note: Make sure the hinge supports are fully engaged before unlocking the hinge levers.
3. Close the oven door.

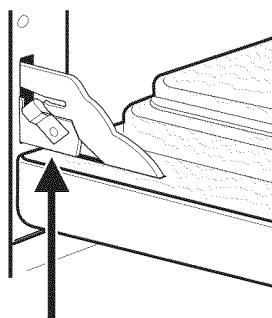

Lock in normal position
Figure 3

Special Door Care Instructions - CAUTION Most oven doors contain glass that can break.

Read the following recommendations:

1. Do not close the oven door until all the oven racks are fully in place.
2. Do not hit the glass with pots, pans, or any other object.
3. Scratching, hitting, jarring or stressing the glass may weaken its structure causing an increased risk of breakage at a later time.

General Care & Cleaning (cont'd)

Removing and Replacing Warmer (Warm & Ready™) Drawer



⚠ WARNING Electrical Shock Hazard can occur and result in serious injury or death. Disconnect appliance from electric power before cleaning and servicing the warmer drawer.

To Remove Warmer Drawer:

1. **⚠ CAUTION** Turn power off before removing the warmer drawer.
2. Open the drawer to the fully opened position.
3. Locate glide lever on each side of drawer, pull up on the left glide lever and push down on the right glide lever (See Figure 1).
4. Pull the drawer away from the range.

To Replace Warmer (Warm & Ready™) Drawer:

1. Pull the plastic slider to the front of the glide slots on each side of the drawer cavity (See Figure 2).
2. Align the glide on each side of the drawer with the drawer cavity glide slot.
3. Push the drawer into the drawer cavity until glide levers “click” (approximately 2”). **If you do not hear the glide levers “click” or the drawer does not feel seated remove the drawer and repeat steps 1 thru 3.**

Note: The Warmer Drawer will **NOT** operate while in the “Self-Clean” and “Oven Lockout” modes

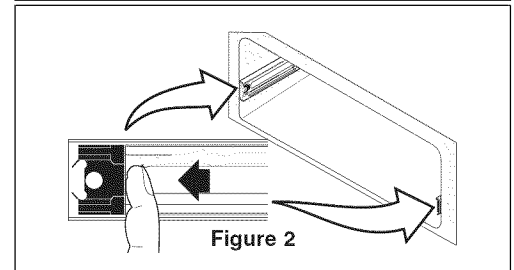
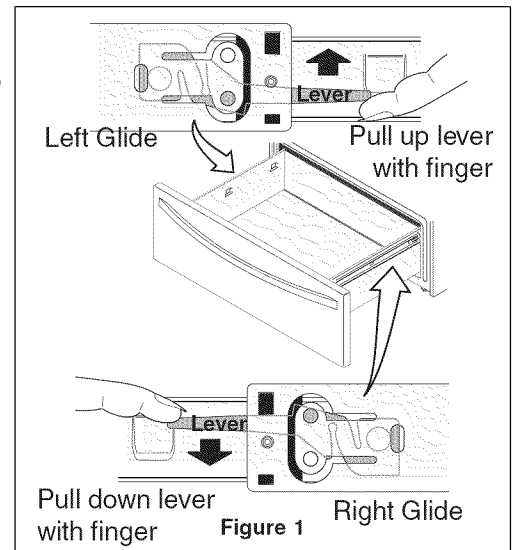

Changing the Halogen Oven Light (some models)

The oven lights will automatically turn ON when the oven door is opened. The oven lights may also be manually operated by pressing the  pad. The oven light bulb is covered with a glass shield. The glass shield can be removed to be cleaned manually or to change oven light. **THIS GLASS SHIELD MUST BE IN PLACE WHENEVER THE OVEN IS IN USE.**

To replace the light bulb:

CAUTION: BE SURE THE OVEN IS COOL.

1. Turn the power off at the main source.
2. Wear a leather-faced glove for protection against possible broken glass.
3. To remove the glass shield, lift up on side with gloved finger and use force to pull shield out.
4. Replace halogen light appliance bulb taking care not to touch the bulb with your bare fingers. Touching bulb with your skin can leave a film on the bulb that causes it to burn out quickly.
5. Replace glass shield in opposite order and manner of removal.

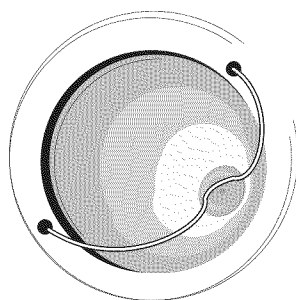
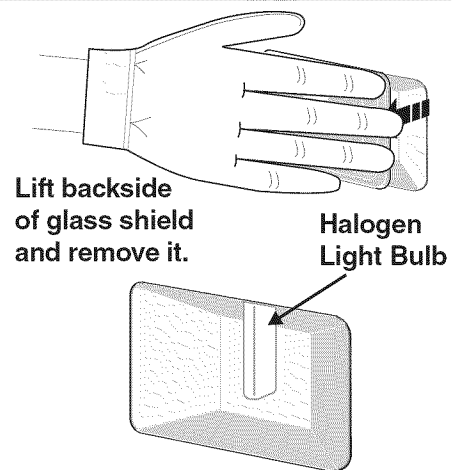

Changing the Oven Light (some models)

⚠ CAUTION Be sure the oven is unplugged and all parts are COOL before replacing the oven light bulb. Do not turn the oven light on during the self-cleaning cycle. High temperature will reduce lamp life.

The interior oven light will turn on automatically when the oven door is opened.

The oven lights may also be manually operated by pressing the  pad.

On a self clean oven the lamp is covered with a glass shield held in place by a wire holder. **THIS GLASS SHIELD MUST BE IN PLACE WHENEVER THE OVEN IS IN USE.**

To replace the light bulb:

CAUTION: BE SURE OVEN IS COOL

1. Turn the power off at the main source.
2. Wear a leather-faced glove for protection against possible broken glass.
3. Replace bulb with a 40 watt appliance bulb only.
4. For self-cleaning oven, press wire holder to one side to release glass shield, change bulb and be sure to replace glass shield.

ENGLISH

Before You Call

Solutions to Common Problems

Before you call for service, review this list. It may save you time and expense. The list includes common occurrences that are not the result of defective workmanship or materials in this appliance.

OCCURRENCE	POSSIBLE CAUSE/SOLUTION
Range is not level.	<p>Poor installation. Place oven rack in center of oven. Place a level on the oven rack. Adjust leveling legs at base of range until the rack is level. When range is level, cooktop may appear out of alignment if countertop is not level.</p> <p>Weak, unstable floor. Be sure floor is level and can adequately support range. Contact a carpenter to correct sagging or sloping floor.</p> <p>Kitchen cabinet misalignment may make range appear to be unlevel. Be sure cabinets are square and have sufficient room for range clearance.</p>
Cannot move appliance easily. Appliance must be accessible for service.	<p>Cabinets not square or are built in too tight. Contact a cabinet maker to correct the problem.</p> <p>Contact builder or installer to make appliance accessible.</p> <p>Carpeting interferes with range. Provide sufficient space so range can be lifted over carpet.</p> <p>Gas line is hard-plumbed. Have a flexible C.S.A international approved metal appliance connector installed.</p>
Entire range or oven does not operate.	<p>Make sure cord/plug is tightly into outlet.</p> <p>Service wiring is not complete. Call 1-800-4-MY-HOME® (See back cover).</p> <p>Electrical power outage. Check house lights to be sure. Call your local electric company for service. Surface burners can be lit manually.</p>
Surface burners do not light.	<p>Surface control knob has not been completely turned to LITE. Push in and turn the surface control knob to LITE until burner ignites and then turn the surface control knob to the desired flame size.</p> <p>Burner ports are clogged. Clean burners. See "Cleaning the Burner Grates, Burner Caps and Burner Heads" under General Cleaning.</p> <p>Range power is disconnected from outlet. Be sure cord is securely plugged into the outlet.</p> <p>Electrical power outage.</p> <p>Be sure the gas supply to the range is turned "ON".</p> <p>Burner ports are clogged. With the burner off, clean ports by using a small-gauge wire or needle.</p>
Surface burner flame burns half way around.	<p>Moisture is present after cleaning. Lightly fan the flame and allow burner to operate until flame is full. Dry the burners thoroughly following instructions in the "General Care & Cleaning" section.</p> <p>Dust particles in main line. Allow the burner to operate a few minutes until flame turns blue.</p>
Surface burner flame is orange.	<p>Salt air in coastal areas. A slightly orange flame is unavoidable.</p>
Scratches or abrasions on cooktop surface.	<p>Coarse particles such as salt or sand between cooktop and utensils can cause scratches. Be sure cooktop surface and bottoms of utensils are clean before usage. Small scratches do not affect cooking and will become less visible with time.</p> <p>Cleaning materials not recommended for ceramic-glass cooktop have been used. See "Ceramic Glass Cooktop Cleaning & Maintenance" section under General Care & Cleaning.</p>
Metalmarks.	<p>Cookware with rough bottom has been used. Use smooth, flat-bottomed cookware.</p> <p>Sliding or scraping of metal utensils on cooktop surface. Do not slide metal utensils on cooktop surface. Use a ceramic-glass cooktop cleaning cream to remove the marks. See "Ceramic Glass Cooktop Cleaning & Maintenance" section under General Care & Cleaning.</p>
Brown streaks or specks.	<p>Boilovers are cooked onto surface. Use razor blade scraper to remove soil. See "Ceramic Glass Cooktop Cleaning & Maintenance" section under General Care & Cleaning.</p>
Areas of discoloration with metallic sheen.	<p>Mineral deposits from water and food. Remove using a ceramic glass cooktop cleaning cream. Use cookware with clean, dry bottoms.</p>

*Oven control beeps and displays any F code error (for example F11)	Electronic control has detected a fault condition. Press STOP/CLEAR to clear the display and stop beeping. Reprogram oven. If fault recurs, record fault number. Press STOP/CLEAR and call 1-800-4-MY-HOME ® for assistance (See back cover).
Oven light does not work.	Replace bulb. See “ Changing Oven Light ” in this Use and Care Guide for instructions.
Poor baking results.	Many factors affect baking results. Make sure the proper rack position is used. Center food in the oven and space pans to allow air to circulate. If conventional baking, allow the oven to preheat to the set temperature before placing food in the oven. Try adjusting the recipe’s recommended temperature or baking time. If you feel the oven is too hot or cool, see “ Adjusting the Oven Temperature ” section in this Use and Care Guide.
Fan noise during cooking operation.	A cooling fan may automatically turn on and off to cool internal parts. It is normal, and the fan may continue to run after the range has been turned “OFF”, but may also stop immediately and then turn “ON” after a while.
Flames inside oven or smoking from vent.	Excessive spillovers in oven. Set self-clean cycle for a longer cleaning time. Excessive spillovers in oven. This is normal, especially for pie spillovers or large amounts of grease on the oven bottom. Wipe up excessive spillovers before starting the self-clean cycle. If flames or excessive smoke are present, stop the self-clean cycle and follow the steps under “ Stopping or Interrupting a Self-Cleaning Cycle ” in this Use and Care Guide.
Oven smokes excessively during broiling.	Control(s) not set properly. Follow instructions under “ Self-Cleaning ” in this Use and Care Guide. Meat is too close to the element. Reposition the rack to provide proper clearance between the meat and the oven broil element. The insert on broiler pan wrong side up and grease not draining. Always place insert on the broiler pan with ribs up and slots down to allow grease to drip into pan. Meat is not properly prepared. Remove excess fat from meat. Remove remaining fatty edges to prevent the meat from curling, but do not cut into the lean of the meat. Broiler pan used without the Broiler Pan Insert or insert is covered with foil. DO NOT use the Broiler Pan without the Broiler Pan Insert or cover the insert with foil. Broiler Pan or Broiler Pan Insert needs to be cleaned. Excessive smoking is caused by build-up of grease or food spatters. Clean the Broiler Pan and Insert on a regular basis. Oven door is open. Oven door should be closed when broiling.
Self-cleaning cycle does not work.	Control(s) not set properly. Follow instructions under “ Self-Cleaning ” in this Use and Care Guide. Self-cleaning cycle was interrupted. Stop time must be 3 to 4 hours past the start time. Follow steps under “ Stopping or Interrupting a Self-Cleaning Cycle ” in this Use and Care Guide.
Soil not completely removed after self-cleaning cycle.	Set Self-Clean cycle for a longer cleaning time. Hand clean bottom, front top of oven, frame or door area outside oven seal before the self-cleaning is started. These areas are not in the self-cleaning area, but get hot enough to burn on residue. Burned-on residue can be cleaned with a stiff nylon brush and water or nylon scrubber. Be careful not to damage the oven seal by attempting to clean it.
Excessive smoking from oven vent.	Excessive spillovers in oven, especially for pie spillovers or large amounts of grease on the oven bottom. Wipe up excessive spillovers before starting the Self-Clean cycle. If flames or excessive smoke are present, stop the Self-Clean cycle and follow the steps under “ Stopping or Interrupting the Self-Cleaning Cycle ” in this Use and Care Guide.

Get it fixed, at your home or ours!

Your Home

For expert troubleshooting and home solutions advice:

manage  my home

www.managemyhome.com

For repair – **in your home** – of **all** major brand appliances, lawn and garden equipment, or heating and cooling systems, **no matter who made it, no matter who sold it!**

For the replacement parts, accessories and owner's manuals that you need to do-it-yourself.

For Sears professional installation of home appliances and items like garage door openers and water heaters.

1-800-4-MY-HOME[®] (1-800-469-4663)

Call anytime, day or night (U.S.A. and Canada)

www.sears.com www.sears.ca

Our Home

For repair of carry-in items like vacuums, lawn equipment, and electronics, call anytime for the location of your nearest

Sears Parts & Repair Service Center

1-800-488-1222 (U.S.A.)

www.sears.com

1-800-469-4663 (Canada)

www.sears.ca

To purchase a protection agreement on a product serviced by Sears:

1-800-827-6655 (U.S.A.)

1-800-361-6665 (Canada)

Para pedir servicio de reparación a domicilio, y para ordenar piezas:

1-888-SU-HOGAR[®]

(1-888-784-6427)

Au Canada pour service en français:

1-800-LE-FOYER^{MC}

(1-800-533-6937)

www.sears.ca

Sears