

# SEARS

## Kenmore Refrigerator Owner's Manual

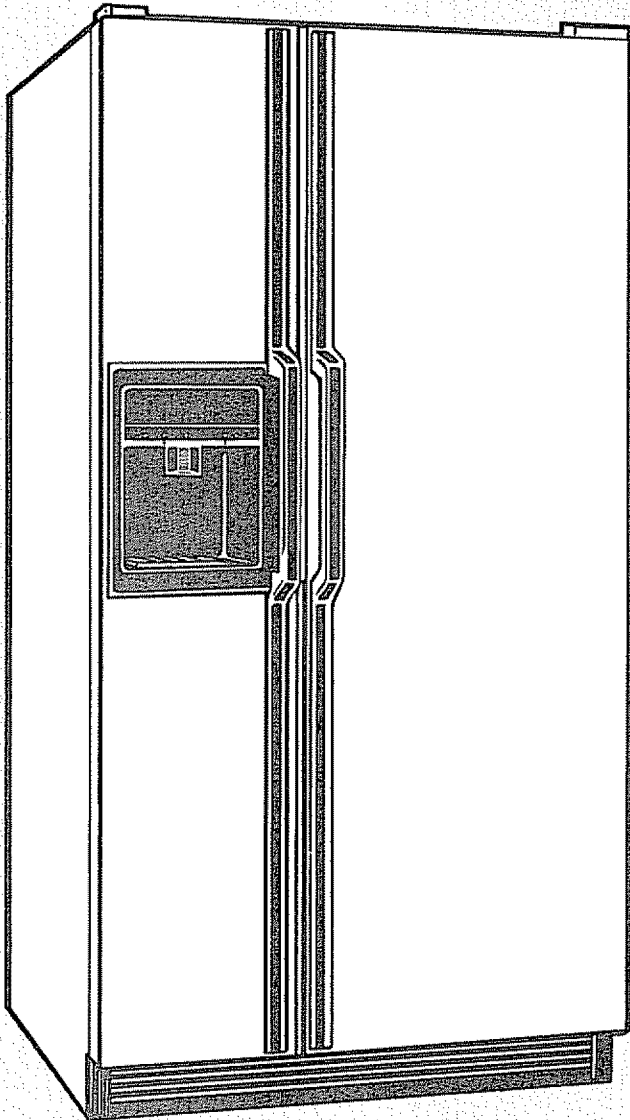

### Contents

- Safety Instructions ..... 2
- Grounding Requirements ..... 2, 3
- Starting the Refrigerator ..... 3
- Adjusting the Controls ..... 4
- Energy-Saving Tips ..... 4
- Food Storage Suggestions ..... 4-7
- Features ..... 8
- Ice & Water Dispenser ..... 9-11
- Care and Cleaning ..... 12, 13
- Before You Call for Service ..... 14, 15
- Vacation and Moving Precautions ..... 15
- Warranty ..... Back Cover

Please record the model number, serial number and date you purchased your Kenmore refrigerator in the space below. See page 8 for model and serial number location.

\_\_\_\_\_

Model Number

\_\_\_\_\_

Serial Number

\_\_\_\_\_

Date of Purchase

# IMPORTANT SAFETY INSTRUCTIONS

## Read all instructions before using this appliance.

**WARNING**— When using this appliance, always exercise basic safety precautions, including the following:

- **Use this appliance only for its intended purpose** as described in this Owner's Manual.
- **This refrigerator must be properly installed in accordance with the Attention Installer Instructions before it is used.** See grounding requirements below and on page 3.
- **Never unplug your refrigerator by pulling on the power cord.** Always grip plug firmly and pull straight out from the outlet.
- **Repair or replace immediately all electric service cords that have become frayed or otherwise damaged.** Do not use a cord that shows cracks or abrasion damage along its length or at either the plug or connector end.
- **When moving your refrigerator away from the wall, be careful not to roll over or damage the power cord.**
- **After your refrigerator is in operation, do not touch the cold surfaces in the freezer compartment, particularly when hands are damp or wet.** Skin may adhere to the extremely cold surfaces.
- **Do not place fingers or hands on the automatic icemaking mechanism while the refrigerator is plugged in.** This will help protect you from possible injury. It will also prevent interference with the moving parts of the ejector mechanism, or with the heating element that releases the cubes.
- **Do not store or use gasoline or other flammable vapors and liquids in the vicinity of this or any other appliance.**

• **Don't refreeze frozen foods which have thawed completely.** The United States Department of Agriculture in Home and Garden Bulletin No. 69 says:

"...You may safely refreeze frozen foods that have thawed if they still contain ice crystals or if they are still cold—below 40°F.

"...Thawed ground meats, poultry or fish that have any off-odor or off-color should not be refrozen and should not be eaten. Thawed ice cream should be discarded. If the odor or color of any food is poor or questionable, get rid of it. The food may be dangerous to eat.

"Even partial thawing and refreezing reduce the eating quality of foods, particularly fruits, vegetables and prepared foods. The eating quality of red meats is affected less than that of many other foods. Use refrozen foods as soon as possible to save as much of their eating quality as you can."

- **If your old refrigerator is still around the house but not in use, be sure to remove the doors.** This will reduce the possibility of danger to children.
- **Do not allow children to climb, stand or hang on the shelves in the refrigerator.** They could damage the refrigerator and seriously injure themselves.
- **Unplug your refrigerator before making any repairs.** Note: We strongly recommend that any servicing be performed by a qualified individual.
- **Before replacing a burned-out light bulb,** unplug the refrigerator or turn off power at the circuit breaker or fuse box in order to avoid contact with a live wire filament. (A burned-out light bulb may break when being replaced.) Note: Moving control to OFF position does not remove power to the light circuit.

## SAVE THESE INSTRUCTIONS

## Grounding Requirements Important—Please read carefully.

To connect electricity

**For personal safety, this appliance must be properly grounded.**

The power cord of this appliance is equipped with a three-prong (grounding) plug which mates with a standard three-prong (grounding) wall outlet (Fig. 1) to minimize the possibility of electric shock hazard from this appliance.

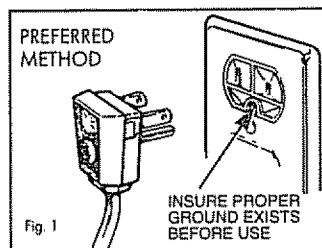

Have wall outlet and circuit checked by a qualified electrician to make sure outlet is properly grounded.

Where a standard two-prong wall outlet is encountered, it is your personal responsibility and obligation to have it replaced with a properly grounded three-prong wall outlet.

**DO NOT, UNDER ANY CIRCUMSTANCES, CUT OR REMOVE THE THIRD (GROUND) PRONG FROM THE POWER CORD.**

# Starting the Refrigerator

## Use of adapter plug

Because of potential safety hazards under certain conditions, we strongly recommend against use of an adapter plug. However, if you still elect to use an adapter, where local codes permit, a TEMPORARY CONNECTION may be made to a properly grounded two-prong wall outlet by use of a UL listed adapter (Fig. 2) available at most local hardware stores.

The larger slot in the adapter must be aligned with the larger slot in the wall outlet to provide proper polarity in the connection of the power cord.

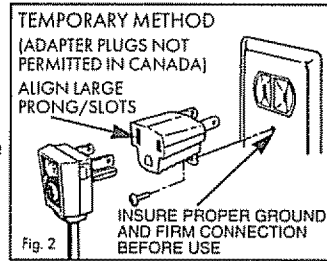

**CAUTION:** Attaching an adapter ground terminal to the wall outlet cover screw does not ground the appliance unless the cover screw is metal, and not insulated, and the wall outlet is grounded through the house wiring. You should have circuit checked by a qualified electrician to make sure the outlet is properly grounded.

**When disconnecting the power cord from the adapter,** always hold the adapter with one hand. If this is not done, the adapter ground terminal is very likely to break with repeated use.

**Should the adapter ground terminal break, DO NOT USE the appliance until a proper ground has again been established.**

## Use of Extension Cords

Because of potential safety hazards under certain conditions, we strongly recommend against the use of an extension cord. However, if you still elect to use an extension cord, it is absolutely necessary that it be a UL listed 3-wire grounding type appliance extension cord having a grounding type plug and outlet and that the electrical rating of the cord be 15 amperes (minimum) and 120 volts.

## Electrical Requirements

The refrigerator should always be plugged into its own individual electrical outlet which has a voltage rating that matches the rating plate. This provides the best performance and also prevents overloading house wiring circuits, which could cause a fire hazard from overheating wires.

## Location

- Install the refrigerator on a floor strong enough to support it when it is fully loaded.
- Do not install it where the temperature will be below 60°F because it will not run often enough to maintain proper temperatures.
- Do not install it next to your range, a heating vent or where the sun will shine directly on it.

## Clearances

Allow the following clearances for ease of installation, proper air circulation, and plumbing and electrical connections:

Sides ..... 5/8" Top ..... 0" Back ..... 1"  
(If built-in, allow 7/8" at top for hinge covers.)

Allow a 1½" door clearance at refrigerator side, 1¾" at freezer side.

## Rollers

Adjustable rollers behind the base grille enable you to move the refrigerator away from the wall for cleaning. These rollers should be set so the refrigerator rests firmly on the floor. To assure that the doors will close automatically from a halfway-open position, there is a built-in tilt from the front to the back of the cabinet. Side-by-side refrigerators also have specially designed door hinges that lift both doors slightly when opened, allowing the force of gravity to help close them securely.

### To adjust the rollers:

- Remove the base grille. Grasp it at the bottom and pull it out.
- Turn the roller adjusting screws **clockwise to raise** the refrigerator, **counter-clockwise to lower** it. Use an adjustable wrench or pliers on the 3/8" bolts. Both doors should close properly when bottom front edge of refrigerator cabinet is about 5/8" from the floor.

- **To replace the base grille,** line up the prongs on the grille with the clamps on the refrigerator and push back until the grille snaps into place.

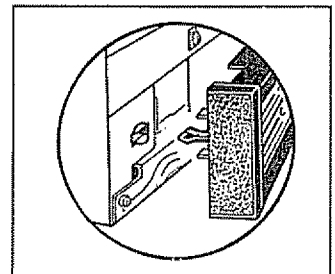
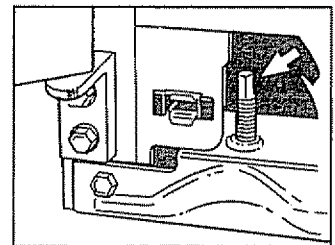
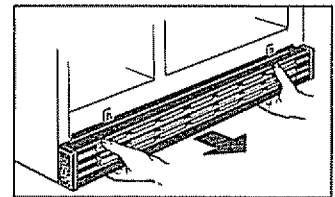

## Starting the Refrigerator (continued)

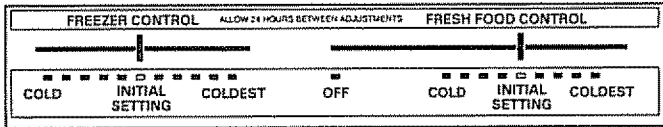

### Temperature Controls (appearance may vary)

Two controls let you regulate the temperature in the fresh food and freezer compartments.

At first, set the Fresh Food and Freezer controls at the center of the "INITIAL SETTING" range.

Allow 24 hours for the temperature to stabilize, whether you are setting the controls for the first time or adjusting them later. Then, if you want colder or warmer temperatures in either compartment, adjust the controls one letter or number at a time.

Note: Turning the Fresh Food control to OFF turns off cooling in both compartments—fresh food and freezer—but does not shut off power to the refrigerator.

### How to Test Temperatures

**Use milk test for fresh food compartment.** Place a container of milk on the top shelf in the fresh food compartment. Check it a day later. If the milk is too warm or too cold, adjust the temperature controls.

**Use ice cream test for freezer compartment.** Place a container of ice cream in the center of the freezer compartment. Check it after a day. If it's too hard or too soft, adjust the temperature controls.

### Turning your Household Thermostat Below 60°F. at Night?

You may want to move the Freezer control one step colder. Cooler temperatures in the house may cause the compressor to operate less frequently, thus allowing the freezer compartment to warm somewhat.

To protect your frozen food supply, leave your Freezer control at this new, colder setting for the entire winter or for as long as you keep your thermostat turned down.

Moving the Freezer control to a colder setting should have no effect on your fresh food compartment. However, if freezing occurs, turn the numbered control one step warmer.

When you stop turning the household thermostat down at night, turn the refrigerator temperature controls back to their regular settings.

## Energy-Saving Tips

- Don't open the doors more often than necessary.
- Close the doors as soon as possible, particularly in hot, humid weather.
- Be sure the doors are closed tightly. Before leaving the house or retiring for the night, check to be sure the doors haven't been left open accidentally.
- Store only those foods requiring refrigeration in your refrigerator.
- Wipe moisture from bottles and cartons before putting them in the refrigerator.
- Keep foods covered to reduce moisture buildup inside the refrigerator.
- If you turn the controls to the coldest position for quick chilling or freezing, be sure to turn them back to regular settings.
- Don't overcrowd your refrigerator. Overcrowding can require extra electrical energy to keep everything cool.

## Food Storage Suggestions

### Fresh Food Storage Tips

#### To store unfrozen meats, fish and poultry:

- Always remove store wrappings.
  - Rewrap in foil, plastic wrap or wax paper and refrigerate immediately.
- #### To store cheese,
- wrap well with wax paper or aluminum foil, or put in a plastic bag
- Carefully wrap to expel air and help prevent mold.
  - Store pre-packaged cheese in its own wrapping if you wish.

#### To store vegetables,

use the vegetable drawers—they've been designed to preserve the natural moisture and freshness of produce.

- Covering vegetables with a moist towel helps maintain crispness.
- As a further aid to freshness, pre-packaged vegetables can be stored in their original wrapping.

## Suggested Storage Times

Eating quality drops after time shown	DAYS IN REFRIGERATOR AT 35° to 40°F.	MONTHS IN FREEZER AT 0°F.
	<b>Fresh Meats</b>	
Roasts (Beef & Lamb)	3 to 5	6 to 12
Roasts (Pork & Veal)	3 to 5	4 to 8
Steaks (Beef)	3 to 5	6 to 12
Chops (Lamb)	3 to 5	6 to 9
Chops (Pork)	3 to 5	3 to 4
Ground & Stew Meats	1 to 2	3 to 4
Variety Meats	1 to 2	3 to 4
Sausage (Pork)	1 to 2	1 to 2
<b>Processed Meats</b>		
Bacon	7	1
Frankfurters	7	1/2
Ham (Whole)	7	1 to 2
Ham (Half)	3 to 5	1 to 2
Ham (Slices)	3	1 to 2
Luncheon Meats	3 to 5	Freezing not recom- mended.
Sausage (Smoked)	7	
Sausage (Dry & Semi-Dry)	14 to 21	
<b>Cooked Meats</b>		
Cooked Meats and		
Meat Dishes	3 to 4	2 to 3
Gravy & Meat Broth	1 to 2	2 to 3
<b>Fresh Poultry</b>		
Chicken & Turkey (Whole)	1 to 2	12
Chicken (Pieces)	1 to 2	9
Turkey (Pieces)	1 to 2	6
Duck & Goose (Whole)	1 to 2	6
Giblets	1 to 2	3
<b>Cooked Poultry</b>		
Pieces (Covered with Broth)	1 to 2	6
Pieces (Not Covered)	3 to 4	1
Cooked Poultry Dishes	3 to 4	4 to 6
Fried Chicken	3 to 4	4
<b>(Other than for meats &amp; poultry)</b>		
Most fruits and vegetables		8-12 months
Lean fish		6-8 months
Fatty fish, rolls and breads, soups, stew, casseroles		2-3 months
Cakes, pies, sandwiches, leftovers (cooked),		
Ice cream (original carton)		1 month max.

Meats, fish and poultry purchased from the store vary in quality and age; consequently, safe storage times in your refrigerator will vary.

New techniques are constantly being developed. Consult the College or County Extension Service or your local Utility Company for the latest information on freezing and storing foods.

## Tips on freezing foods

**1. Freeze only top-quality foods.** Freezing retains quality and flavor; it cannot improve quality.

**2. Freeze fruits and vegetables quickly after picking.** The sooner you do, the better the frozen product will be, with less culling and sorting to do.

**3. Use food wraps designed especially for freezing.**

**To freeze meat, fish and poultry,** wrap well in freezer-weight foil (or other heavy-duty wrapping material) forming it carefully to the shape of the contents. This expels air. Fold and crimp ends of the package to provide a good, lasting seal.

Don't refreeze meat that has completely thawed; meat, whether raw or cooked, can be frozen successfully only once.

**To store ice cream**—Fine-quality ice cream, with high cream content, will normally require slightly lower temperatures than more "airy" already-packaged brands with low cream content.

- It will be necessary to experiment to determine the freezer compartment location and temperature control setting to keep your ice cream at the right serving temperature.
- The rear of the freezer compartment is slightly colder than the front.

### For convenience...

- Store like things together. This saves both time and electricity because you can find foods faster.
- Place the oldest items up front so they can be used up promptly.
- Use bins on the door for most often used sauces and condiments.
- Use the meat drawer for meats you do not freeze.

### To save money in energy and food costs...

- Cover moist foods with tight lids, plastic film or foil.
- Leaf vegetables and fruits placed in drawers will last longer when stored in closed plastic containers or wrapped in plastic film.
- Do not overload your fresh food or freezer compartment with a lot of warm food at once.
- Open the doors the fewest times possible to save electrical energy.
- When going out of town for several days, leave as few perishables as possible in the refrigerator. If your refrigerator has an icemaker, move the icemaker feeler arm to the STOP (up) position and shut off water to the refrigerator.

# Shelves and Storage Drawers

## Adjustable Shelves

Shelves in the fresh food compartment are adjustable, enabling you to make efficient shelf arrangements.

### To remove a shelf:

Tilt the shelf up at front, then lift it up and out of the tracks on the rear wall of the refrigerator.

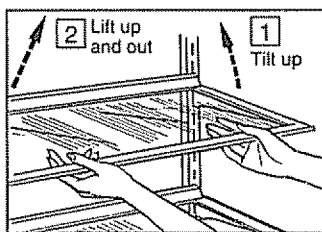

### To replace a shelf:

Select desired shelf height. With the shelf front raised slightly, engage the top lugs in the tracks at the rear of the cabinet. Then lower the front of the shelf until it locks into position.

## Handi Dishes

Cooking-serving-storage dishes with durable see-through lids fit into a rack that hangs on and can be relocated on the fresh food compartment door.

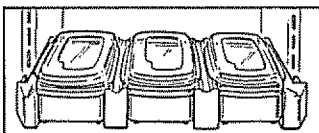

Dishes and lids are safe for use in microwave ovens, refrigerators, freezers, and are dishwasher-safe. The dishes should not be used for cooking high-fat foods such as bacon and high-sugar foods such as candy and syrup. The high temperatures of the fat and sugar can cause bubbles to form on the inside of the dish.

Caution: Dishes and lids are not designed for use in the regular oven, on the range-top or in the broiler. Such use can be hazardous.

## Removable Door Bins

**To remove bin:** Lift bin straight up until mounting hooks disengage.

**To relocate bin:** Select desired bin height, engage hooks in slots on the tracks of the door and push in. Bin will lock in place.

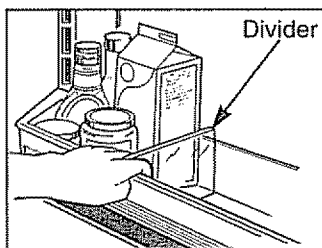

Dividers can be moved from side to side to keep items such as small jars and bottles so they won't tip, spill or slide.

## Storage Bin

This removable tilt-out bin on the fresh food compartment door has been designed for convenient storage of those frequently-used items that do not fit easily into a door bin or soon-to-be-used items that require covered storage to keep from drying out.

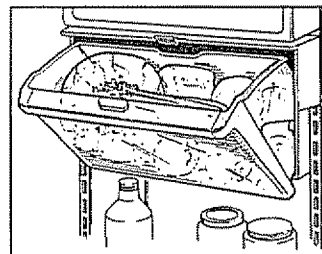
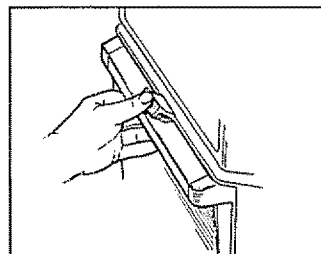
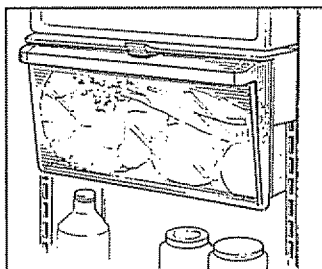

**To open,** push the latch up and pull the bin handle forward.

**To avoid damaging the refrigerator,** make sure the bin is closed and latched before closing the refrigerator door.

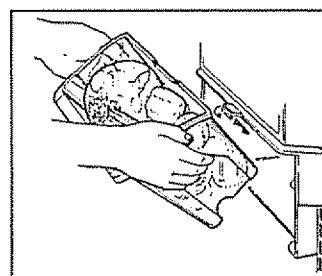
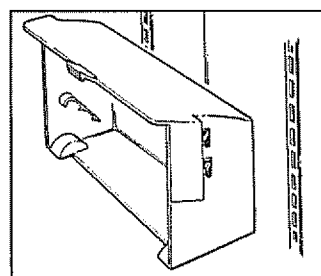

**To remove the bin,** lift it up and out of the bin housing.

**To relocate the Storage Bin,** grasp the upper sides of the bin housing and lift it up and out of the slots on the door. After moving the bin housing to the desired new location, lower the hooks on the housing into the slots on the door.

You do not have to remove the bin from the housing when relocating the Storage Bin.

## Deep Shelves on Freezer Compartment Door

Detachable shelf extenders deepen and enclose three fixed door shelves, providing more storage room and greater storage flexibility.

**To remove,** lift shelf extender straight up until mounting hooks come out of slots in door.

**To replace,** line up hooks with slots in door, then push in and down.

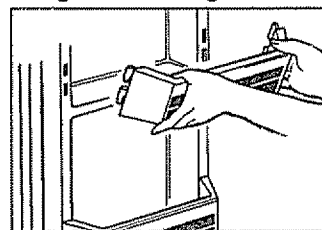

## Removable Freezer Basket Shelves

Shelves in the freezer compartment will stop before coming all the way out of the freezer to help prevent contents from spilling onto the floor. They can be removed easily by lifting up slightly and pulling past the "stop" location.

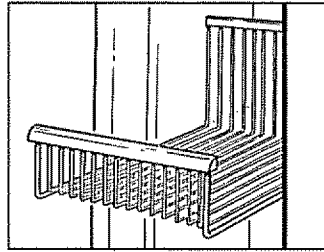

## Removable Wine Rack

The wine rack is designed to hold a bottle on its side and will fit on any shelf. To relocate it, pull it straight out, position its lip over either edge of the shelf you want to suspend it from, and push it all the way in.

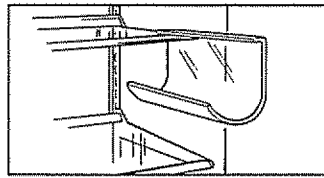

## Sealed Crisper Drawer

This sealed drawer is designed to keep unwrapped foods fresh by retaining the natural moisture content of foods such as:

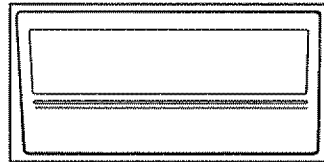

- Artichokes
- Asparagus
- Beets, topped
- Blueberries
- Carrots
- Celery
- Cherries
- Corn
- Currants
- Greens, leafy
- Lettuce
- Parsley
- Peas, green
- Plums
- Radishes
- Rhubarb
- Spinach
- Tomatoes, ripe

As in any refrigerated storage area, foods with strong odors should be stored wrapped—foods such as:

- Brussels Sprouts
- Broccoli
- Cabbage
- Cauliflower
- Green Onions
- Turnips
- Parsnips

## Temperature Controlled Meats Drawer

The convertible meat drawer has its own cold air duct to allow a stream of cold air from the freezer compartment to flow around the drawer.

The variable temperature control regulates the air flow from the freezer compartment

Set the control lever to MEATS—the coldest setting—to store fresh meats. If the lever is left in the meat position for a long period of time, some frost may form on the inside of the drawer.

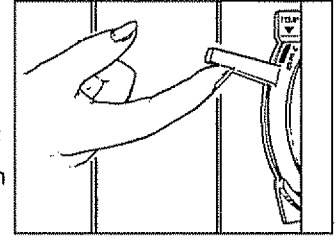

Set the control lever to VEG to convert the drawer to normal refrigerator temperature and provide extra vegetable storage space. The cold air duct is turned off.

Variable settings between these extremes can be selected.

## Deli Pan

The Deli Pan—and shelf to which it is attached—can be relocated within the Fresh Food compartment. The sealed drawer retains high humidity for convenient storage of lunch meats and cheese, hors d'oeuvres, spreads and snacks.

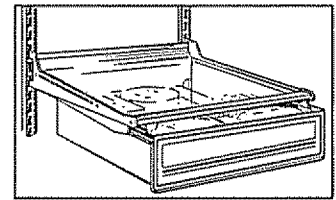

## Handi-Shelf Swing Down Shelf

(on some models)

This swing-down shelf provides extra shelf space when needed.

**When you want to use it,** pull the shelf forward as far as it goes, then lower it. Be careful not to force it down before it is pulled out all the way.

**To raise it back into position,** pull the shelf forward, push it up and slide it back fully until it stops.

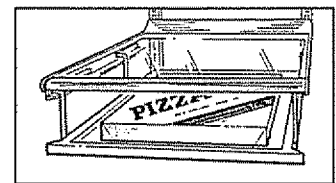
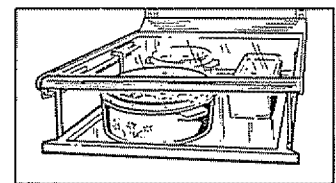
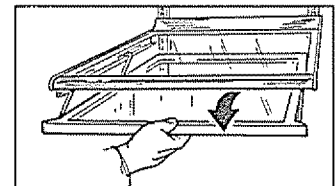

# Features

## ICE ACCESS DOOR

Lift it to turn icemaker on or off, or to level ice cubes in storage bin from time to time.

## ICE STORAGE COMPARTMENT

Ice is made and stored here until called for by the dispenser pad on front of door.

## WATER AND ICE DISPENSER

Located on outside of freezer compartment door, it dispenses ice cubes, crushed ice and chilled water through the door.

## FREEZER DOOR SHELVES

Door shelves keep frequently used frozen food items within easy reach.

## REMOVABLE FREEZER BASKET SHELVES

Pull a basket shelf forward to the "stop" position and food at the back becomes easier to reach. Lift the shelf up slightly and you can pull it all the way out and take it to the food preparation area to remove things from it or add things to it.

## DELI PAN

This drawer provides high humidity for convenient storage of meats and cheeses, bacon, hors d'oeuvres, spreads and snacks.

## FREEZER BIN

This slide-out bin holds bulky and odd-shaped food packages and makes them easily accessible without disturbing frozen food next to or on top of them.

## TEXTURED STEEL DOORS

Touch the textured doors; they won't show fingerprints

## MAGNETIC DOOR GASKETS

Doors close quietly, and gaskets seal tightly when the refrigerator is level—see "Starting the Refrigerator".

## DIVIDERS

Move them where needed on door bins to keep items such as small bottles and jars so they won't tip, spill or slide

## TEMPERATURE CONTROLS

Set both controls at "INITIAL SETTING." They may need adjusting later.

## UTILITY BIN

Dual-usage bin holds two dozen eggs in their cartons, or stores an extra supply of ice cubes in the freezer for special occasions.

## DAIRY BIN

Door stays open while bin is in use, provides easy access to dairy products

## USE AND CARE LABEL

Information you'll want to know is right on the refrigerator, including everyday care.

## HANDI-SHELF

This swing-down shelf provides extra shelf space when needed.

## DOOR BINS

Portable, lightweight bins adjust easily to accommodate items of various heights, can be used to carry contents directly to countertop or table for preparation or serving.

## HANDI DISHES

Cooking-serving-storage dishes with see-through lids fit into a removable rack that hangs on and can be relocated on the fresh food compartment door.

## WINE RACK

Holds a bottle on its side, will fit on any shelf.

## ADJUSTABLE TEMPERED GLASS SHELVES

These shelves let you arrange—and rearrange—the interior of your refrigerator to meet your everchanging food storage needs.

## STORAGE BIN

Removable tilt-out bin located on fresh food door, holds often-used items that do not fit easily in a door bin.

## MODEL AND SERIAL NUMBER LOCATION

You'll find these numbers either on the side wall or on the bottom front of the cabinet. To order repair parts, see the parts list that came with your refrigerator, or take these numbers to your nearest Sears Service Center and they will help you.

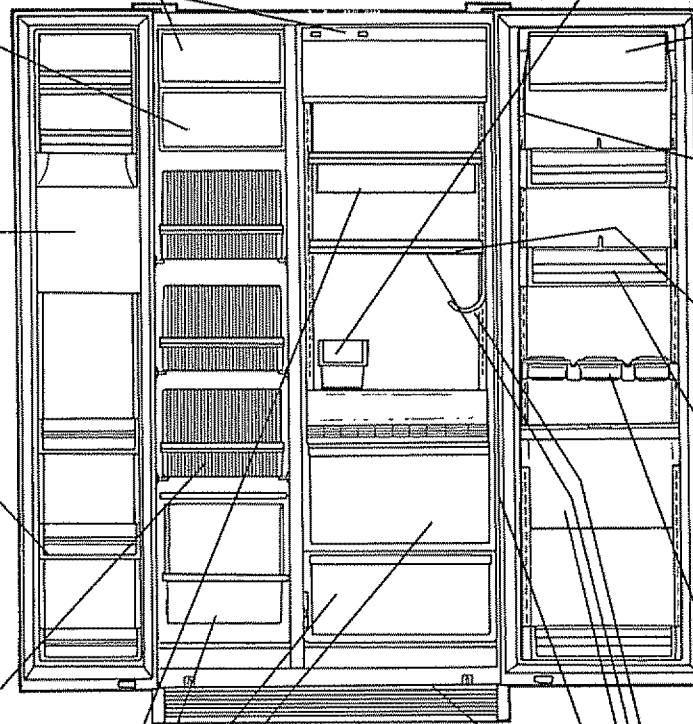

## SEALED CRISPER DRAWER

This roomy drawer has been specially designed to help preserve the natural goodness of fruits and vegetables.

## TEMPERATURE CONTROLLED MEATS DRAWER

The variable temperature control next to this drawer regulates the flow of cold air from the freezer.

## NO DEFROSTING

It is not necessary to defrost the freezer or fresh food compartments. Your refrigerator is designed and equipped to defrost itself automatically.

## AUTOMATIC ENERGY SAVER SYSTEM

Warm liquid from the refrigerator's condenser is automatically circulated around the front edge of the freezer compartment to help keep moisture from forming on the outside of the refrigerator during humid weather.



# Automatic Icemaker and Ice & Water Dispenser

## How it Works

Your refrigerator has an automatic icemaker and a dispenser that dispenses water, ice cubes and crushed ice (on some models) through the freezer compartment door. Here's how they work.

**Water flows from the household supply through a**

- (1) dual solenoid valve to the
- (2) water tubing and to the
- (3) automatic icemaker as needed.

**Water is frozen in the**

- (4) cube mold and ejected into the
- (5) storage bin where a motor-powered auger moves cubes forward.

Cubes dispense through the chute in the door when the pad is pressed.

**When the switch is moved to CRUSHED** (on some models), a baffle channels cubes through the crusher and crushed ice falls through a chute into the glass

**Water flows through the**

- (6) tubing in the door and is dispensed when the pad is pressed.
- (7) A light switch (on some models) turns the night light in the dispenser on or off. The light also comes on when the pad is pressed.

The light in the dispenser should be replaced with a 7 watt maximum bulb when it burns out

## Important Facts about Your Ice & Water Dispenser

- **If this is your first icemaker you'll hear occasional sounds that may be unfamiliar.** These are normal icemaking sounds and are not cause for concern.
- **Your icemaker will produce eight cubes per cycle—**approximately 120 cubes in a 24-hour period—depending on freezer compartment temperature, room temperature, number of door openings and other use conditions.
- **Intermittent dispensing of ice is normal.** If ice flow interruption is more than brief, ice clump(s) may be the cause and should be removed following instructions in this section.

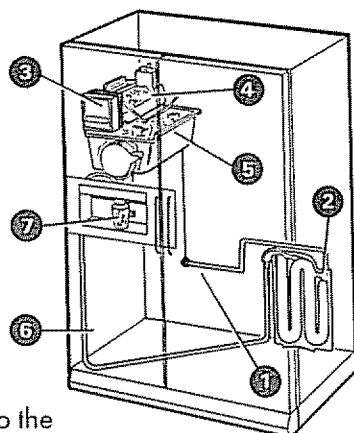

- **Avoid over filling glasses with ice and using narrow or extra-tall glasses.** This can jam the chute or cause the door in the chute to freeze shut. Periodically open the freezer compartment door and look down into the chute. If ice is blocking the chute, poke it through with a wooden spoon.
- **To help keep bits of ice from being sprayed beyond the glass,** place the glass close to the ice chute—but not so close that it blocks out coming ice.
- **Ice should not be dispensed into thin glasses, fine china or delicate crystal—**they can crack or chip from the combined pressure of your hand pressing them against the pad and ice dropping into the container.
- **Fill glasses with ice before adding soda or other beverage mixes.** This will prevent splashing which could cause the ice and water selector switch to stick.
- **Beverages and foods should not be quick-chilled in the ice storage bin.** Cans, bottles or food packages in the storage bin may cause the icemaker or auger to jam.
- **Do not add ice from trays or bags to the storage bin.** It may not crush or dispense well.

## Before Using Your Icemaker and Dispenser

If you use your refrigerator before the water connection is made, raise the ice access door and make sure the icemaker feeler arm is in the STOP (up) position.

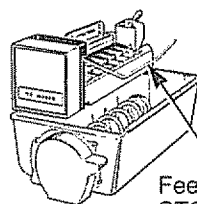
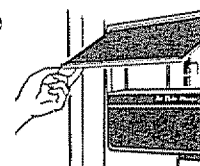

Feeler arm in STOP (up) position

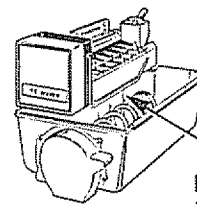

Feeler arm in ON (down) position

When the water supply has been connected to the icemaker, move the feeler arm to ON (down) position.

Select WATER then press the dispenser pad for about two minutes to remove trapped air from the water line and to fill the water reservoir. The ice cube mold automatically fills with water after cooling to freezing temperatures. First cubes normally freeze after several hours.

**NOTE:** With a newly-installed refrigerator, allow about 24 hours for the freezer compartment to cool down to the proper ice-making temperature.

# Automatic Icemaker and Ice & Water Dispenser (continued)

## Once Your Icemaker & Dispenser are in Operation

Throw away the first few batches of ice cubes (16 or 24 cubes). This will flush away any impurities in the water line. Do the same thing after vacations or extended periods when ice isn't used.

To clean out the line, pour the first six glassfuls of water in the kitchen sink. The first water through the system picks up a slight "plastic" taste from the water tubing.

**To make sure the bin fills with ice, level the cubes occasionally.** When cubes fall into the bin they may pile up close to the icemaker and push the feeler arm to the STOP position before the bin gets full. Keeping the cubes level allows the icemaker to fill the bin.

### Caution:

Under certain rare circumstances, ice cubes may be discolored, usually appearing with a green-bluish color. The cause of this unusual discoloration is apparently due to a combination of factors such as certain characteristics of local waters, household plumbing and the accumulation of copper salts in an inactive water supply line which feeds the icemaker. Continued consumption of such discolored ice cubes may be injurious to health. If such discoloration is observed, discard the ice cubes and contact your Sears Service Center.

## To Dispense Ice and Water

- Set the selector switch to CUBES, CRUSHED ICE (on some models) or WATER.
- Grip the glass or other container near the rim and press the rim against the center of the pad.

### When Dispensing Ice:

- Some crushed ice may be dispensed even though you selected CUBES. This happens occasionally when a few cubes get channeled to the crusher.
- Sometimes a mound of snow will form on the door in the ice chute. This condition is normal, and usually occurs when you have dispensed crushed ice repeatedly. The snow will eventually evaporate.

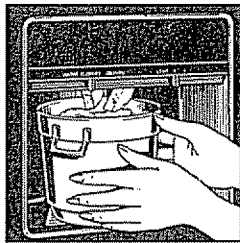

### When Dispensing Water:

- The first glass of water dispensed may be warmer than the following ones. This is normal.
- Dispensed water is cool, not iced. For colder water, simply add crushed ice or cubes before dispensing water.

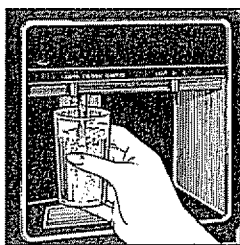

**CAUTION:** Never put fingers or other objects into the dispenser opening.

## To Stop Dispensing

Release pressure from the pad and wait a few seconds to catch the last bits of ice or drops of water. There may be some dripping after dispensing of crushed ice or water. If there is a lot of dripping, the spill should be wiped dry right away. Do not pour water in the spill shelf because it is not self draining—pour it in the kitchen sink. The shelf and its grille should be cleaned regularly according to Care and Cleaning instructions.

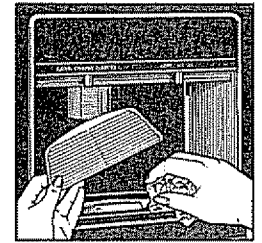

The grille is easily removed by pressing on the back right corner.

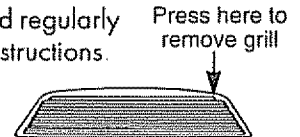

## If Ice Clumps Form in the Storage Bin...

The icemaker ejects cubes in groups of eight, and it is normal for several cubes to be joined together. However, if you don't use the ice very often ice clumps may form in the storage bin and can clog the dispenser. If this happens:

- Remove the storage bin from the freezer.
- Break up ice clumps with your hands. Throw away any clumps that you can't break up.
- Replace the bin before the remaining cubes melt and fuse together.

## To Remove Ice Storage Bin

Lift the left corner to free the bin from the shelf. Pull the bin straight out while supporting it at front and back.

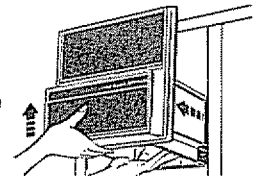

## To Replace Ice Storage Bin

Slide the bin back until the tab on the bin locks into the slot in the shelf.

If the bin does not go all the way back, remove it and turn the drive mechanism 1/4 turn. Then push the bin back again until the tab on the bin locks into the slot in the shelf.

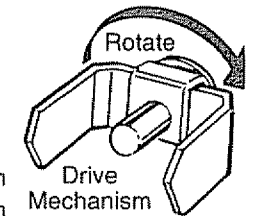

## If Ice Is Not Used Often...

"Old" ice cubes will become cloudy and taste stale. Empty ice storage bin periodically and wash it in lukewarm water. Be sure to allow storage bin to cool before replacing it—otherwise ice cubes will stick to the metal auger.

## Move Feeler Arm to STOP (up) Position when...

- Home water supply is to be turned off for several hours.
- Ice storage bin is to be removed for a period of time.
- Going away on vacation, at which time you should also turn off the valve in the water supply line to your refrigerator.

# Ice Service

## Icemaker Water Line Installation Requirements

You will need a shutoff valve, two 1/4" O.D. compression nuts, two compression sleeves and enough 1/4" O.D. copper tubing to connect refrigerator to water source. (Your Sears Store or Catalog Sales Office has a kit available with a saddle-type shutoff valve and copper tubing. Before purchasing, make sure a saddle-type valve complies with your local plumbing codes.)

**CAUTION:** Do not install icemaker tubing in areas where temperatures fall below freezing.

1. Find a 3/8" to 1" vertical COLD water pipe near the refrigerator. When it is necessary to connect into a horizontal water pipe, make the connection to the top or side, rather than at the bottom to avoid drawing off any sediment from the water pipe.

2. Measure from INLET on rear of refrigerator to water pipe. Add 7 feet to allow for moving refrigerator for cleaning. This is the length of 1/4" O.D. copper tubing you will need for the job (length from water valve to water pipe PLUS 7 feet). Be sure both ends of copper tubing are cut square.

3. Turn OFF main water supply. Turn on nearest faucet long enough to clear line of water.

**CAUTION:** When using any electrical device (such as a power drill) to facilitate installation, be sure the device is insulated or wired in a manner to prevent the hazard of electrical shock.

4. Using a grounded drill, drill a 3/16" hole in the vertical cold water pipe you have selected.

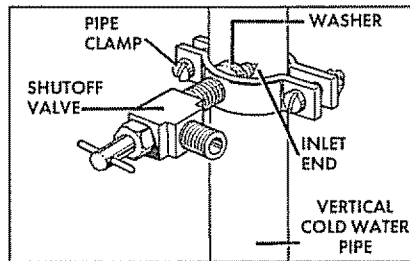

5. Fasten shutoff valve to cold water pipe with pipe clamp. Be sure inlet end is solidly in 3/16" drilled hole in water pipe and washer is under pipe clamp. Tighten packing nut. Tighten pipe clamp screws carefully and evenly so washer makes a watertight connection. Do not overtighten or you may crush copper tubing, especially if soft copper tubing is used. Now you are ready to connect the copper tubing.

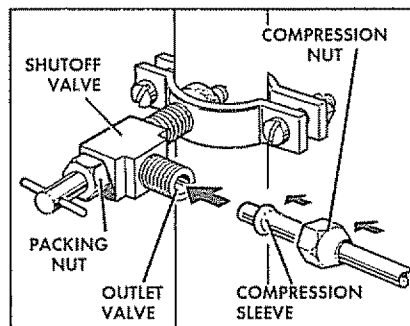

6. Slip compression sleeve and compression nut on copper tubing as shown above. Insert end of tubing into outlet end squarely as far as it will go. Screw compression nut to outlet end with adjustable wrench. Do not overtighten. Turn ON main water supply and flush out tubing until water is clear. Turn OFF shutoff valve on water pipe. You are now ready to connect other end of 1/4" copper tubing to water valve on back of refrigerator.

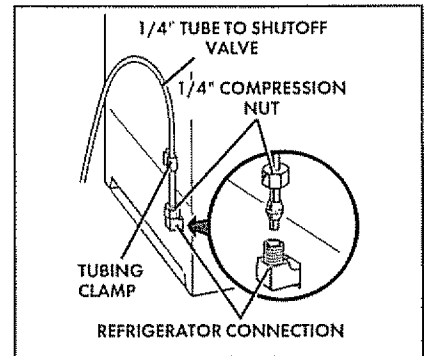

7. Your model has a water valve compression fitting coming through the rear wall of the refrigerator. Assemble compression nut on compression fitting as shown above. Insert end of tubing into connector and tighten compression nut. Be sure end of tubing is square in connector and is inserted as far as it will go. Do not overtighten. Be sure there is enough extra tubing (coiled into three turns of about 10" diameter) to allow refrigerator to move out from wall after installation. Secure tubing in metal clamp at top right corner of compressor compartment cover.

8. Turn shutoff valve ON. TIGHTEN ANY CONNECTIONS OR NUTS THAT LEAK.

9. Copper tubing may now be fastened to baseboard.

10. Your ice cubes can only be as fresh-tasting as the water that produces them. That's why it is a good idea to purify the water with a water filter. The water filter is an optional part at extra cost and is available from the Sears Service Center. Order Filter No. 978488 and install at the inlet water tube connection.

11. Water Pressure Limitations: Not below (15 P.S.I.) or above (125 P.S.I.). If a problem occurs, call your Utility Company.

**IMPORTANT:** It may take up to 24 hours for your icemaker to begin producing ice.

The first few batches of ice cubes should be thrown away, so that remaining impurities in the water line will be flushed out.

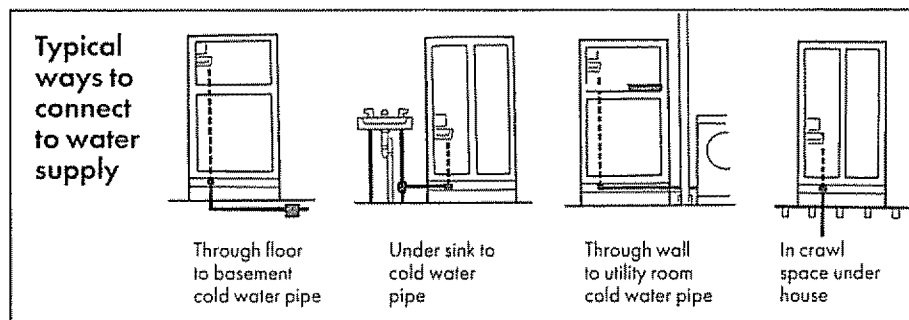

# Care and Cleaning

## Outside

The water and ice dispenser spill shelf should be wiped dry immediately to prevent spotting. Water left on the shelf may leave deposits that you can remove by soaking in undiluted vinegar. You can also use a paste of non-precipitating water softener (such as Calgon brand) and water, or one teaspoon of citric acid powder per pint of hot tap water. Soak until the deposit disappears or becomes loose enough to rinse away. Usually 30 minutes soaking time is adequate. Avoid using wax on the spill shelf and trim.

The soft door handles are easy to clean if they are waxed every few months. Use a household wax such as Pledge or Jubilee brand to coat the handles. Soil will then easily wash off with dish detergent and water or a non-abrasive all-purpose cleaner.

Keep the finish clean. Wipe with a clean cloth lightly dampened with kitchen appliance wax or mild liquid dishwashing detergent. Dry and polish with a clean, soft cloth. Do not wipe the refrigerator with a soiled dishwashing cloth or wet towel. These may leave a residue that can harm the paint. Do not use scouring pads, powdered cleaners, bleach or cleaners containing bleach because these products can scratch and weaken the paint finish.

Protect the paint finish. The finish on the outside of the refrigerator is a high quality, baked-on paint finish. With proper care, it will stay new-looking and rust-free for years. Apply a coat of kitchen/appliance wax when the refrigerator is new and then at least twice a year.

## Inside

The fresh food and freezer compartment interiors should be cleaned at least once a year. Unplug the refrigerator before cleaning. If this is not practical, wring excess moisture out of sponge or cloth when cleaning around switches, lights or controls.

Use warm water and baking soda solution—about a tablespoon of baking soda to a quart of water. This both cleans and neutralizes odors. Rinse thoroughly with water and wipe dry.

Other refrigerator parts—including door gaskets, meat and vegetable drawers, ice storage bin and all plastic parts—can be cleaned the same way. Do not use cleansing powders or other abrasive cleaners. Door gaskets are factory-lubricated with petroleum jelly on the hinge side. If the lubricant is excessive, wipe it off but leave a thin film on the gasket to help insure a proper hinge-side seal. When you clean the door gaskets, relubricate them. If the freezer baskets don't slide freely after cleaning, lubricate them with petroleum jelly.

To help prevent odors, leave an open box of baking soda in the rear of the refrigerator, on the top shelf.

Change the box every three months. In addition, put an open box of baking soda in the freezer to absorb stale freezer odors.

**Do not wash any plastic parts from your refrigerator in your automatic dishwasher.**

## Storage Drawers

Drawers at bottom of fresh food compartment will stop before coming all the way out of refrigerator to help prevent contents from spilling onto floor. The drawers can be removed easily by tilting up slightly and pulling past the "stop" location.

**To remove storage drawers when fresh food compartment door cannot be opened fully:**

1. Remove food from shelf above top drawer and take out shelf.

2. Take food off glass cover and out of drawer.

3. Grasp top of light panel above the top drawer, flex and rotate upper surface of panel until it clears the upper pin on each side wall. Then, keeping panel upright, pull bottom of panel toward you until it clears the lower side-wall pins.

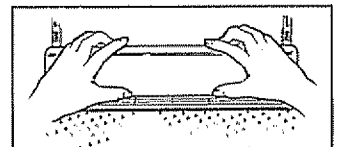

4. Put your fingers behind the gasket at the rear of the drawer and pull forward. Remove the gasket.

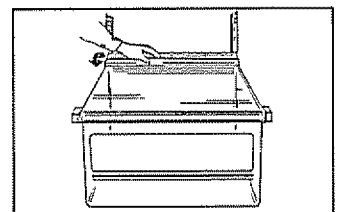

5. Pull the drawer partway out. Reach in, push the rear of the glass up; at the same time, push it back until it clears front-corner retainers.

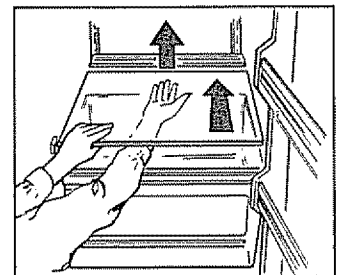

6. Tilt and remove the cover.

7. Pull the drawer forward, lift the front to clear stops, and pull the drawer out until it hits the door. Then lift the drawer up until it is higher than the drawer supports, tilt it and take it out.

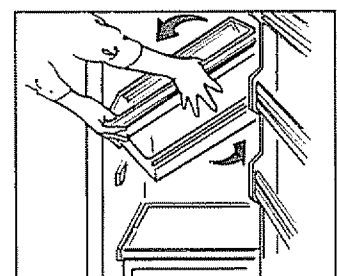

8. If tape holds bottom drawer cover to drawer supports, remove the tape. Pull drawer partway out. Reach in, push the rear of the glass up and, at the same time, back, until it clears front-corner retainers.

9. Tilt and remove the cover.

10. Tilt and remove the drawer.

After cleaning, replace drawers and covers in reverse order. Reinstall the gasket at the rear of the top drawer. Fit the end of the plastic drawer support into the slot on the gasket, with the rubber gasket flap facing you. Make sure the gasket snaps into place.

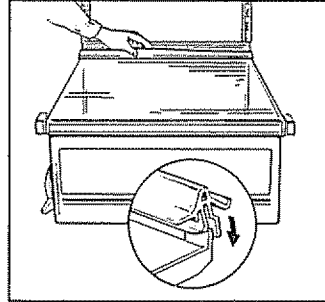

Then replace the light panel by hanging top of panel on upper pins and pushing in at bottom.

### Drain Opening in Freezer Compartment

When cleaning, remove the freezer bin and flush a solution of baking soda (one teaspoon) and two cups of hot (not boiling) water through the drain line with the help of a meat baster. This will help eliminate odor and reduce the likelihood of a clogged drain line.

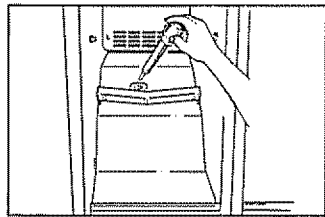

If drain becomes clogged, use a meat baster and baking-soda-and-water solution to force the clog through the drain line.

### Condenser

The condenser is located behind the base grille. For most efficient operation, remove the base grille (see page 3) and sweep away or vacuum up dust that is readily accessible. For best results, use a brush specially designed for this purpose. It is available at your Sears store or service center. This easy cleaning operation should be done at least once a year.

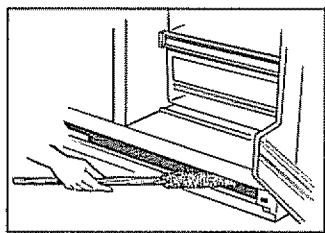

### Behind Refrigerator

Take care moving your refrigerator away from the wall. All types of floor coverings can be damaged, particularly cushioned coverings and those with embossed surfaces. Pull the refrigerator straight out and return it to position by pushing it straight in. Moving refrigerator in a side direction may damage floor covering or refrigerator.

When pushing the refrigerator back, make sure you don't roll over the power cord or icemaker supply line.

### Light Bulb Replacement

**Unplug refrigerator before changing a light bulb.**

#### Fresh Food Compartment—Upper Light

1. Pull off temperature control knobs.

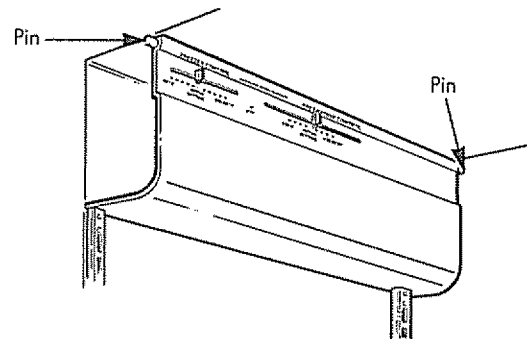

2. Pull the bottom of the light shield down and forward, then rotate the top up and off.

After replacing with same size bulb, reinstall light shield.

#### Fresh Food Compartment—Lower Light (on some models)

This light is located behind a shield at the rear of the fresh food compartment.

1. Grasp the top edge of the shield and lift it up and forward to free its top edge.

2. After replacing with same size bulb, hook the top of the shield back in place.

#### Freezer Compartment

1. Remove shelf just below light panel. (Shelf will be easier to remove if it is emptied first.)

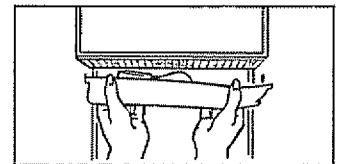

2. Pull plastic light panel toward you. (It will bend to free tabs from grooves.)

3. After replacing with same size bulb, reinstall panel and shelf.

# Before You Call for Service

Save time and money. Check this list of causes of minor operating problems you can correct yourself.

## Refrigerator does not operate

- May be in defrost cycle when motor does not operate for about 30 minutes
- Temperature control in OFF position.
- If interior light is not on, refrigerator may not be plugged in at wall outlet
- If plug is secure and refrigerator fails to operate, plug lamp into same outlet to determine if there is tripped circuit breaker or burned out fuse.

## Motor operates for long periods

- Modern refrigerators with more storage space and a larger freezer require more operating time
- Normal when refrigerator is first delivered to your home—usually requires 24 hours to completely cool down.
- Large amounts of food placed in refrigerator to be cooled or frozen
- Hot weather—frequent door openings
- Door left open
- Temperature controls set too cold
- Condenser needs cleaning
- Check ENERGY-SAVING TIPS.

## Operating sounds

- The high speed compressor motor required to maintain near zero temperatures in the large freezer compartment may produce higher sound levels than your old refrigerator
- Normal fan air flow—one fan blows cold air through the refrigerator and freezer compartments—another fan cools the compressor motor
- These NORMAL sounds will also be heard from time to time:
- Defrost timer switch clicks at defrost
- Defrost water dripping
- Temperature control clicks ON or OFF.
- Refrigerant boiling or gurgling
- Cracking or popping of cooling coils caused by expansion and contraction during defrost and refrigeration following defrost.
- Ice cubes dropping into the bin and water running in pipes as icemaker refills

## Motor starts & stops frequently

- Temperature control starts and stops motor to maintain even temperatures. This is normal

## Door not closing properly

- Door gasket on hinge side sticking or folding over. To correct, put a small amount of petroleum jelly on face of gasket.

## Vibration or rattling

- If refrigerator vibrates, more than likely it is not resting solidly on the floor. The front roller screws need adjusting, or floor is weak or uneven. Refer to Starting Your Refrigerator section.
- If dishes vibrate on shelves, try moving them. Slight vibration is normal.
- Icemaker supply line may be rattling, move the refrigerator 1/2" out from the wall

## Foods dry out

- Foods not covered, wrapped or sealed properly.

## Fresh food or freezer compartment temperature too warm

- Temperature control not set cold enough
- Warm weather—frequent door openings
- Door left open for long time
- Package may be holding door open

## Frost or ice crystals on frozen food

- Door may have been left ajar or package holding door open.
- Too frequent or too long door openings
- Frost within package is normal.

## Slow ice cube freezing

- Door may have been left ajar.
- Set temperature of freezer compartment colder.

## Ice cubes have odor/taste

- Old cubes need to be discarded. Empty ice bin every 30 days.
- Ice storage bin needs to be washed.
- Unsealed packages in refrigerator and/or freezer compartments may be transmitting odor/taste to ice cubes.
- Interior of refrigerator needs cleaning

## Automatic icemaker does not work

- Icemaker feeler arm in STOP (up) position.
- Water supply turned off or not connected
- Freezer compartment too warm
- Cubes too small—water shutoff valve connecting refrigerator to home water line may be clogged
- Sometimes cubes fuse to the side of the ice mold and hold the feeler arm in the STOP (up) position. Remove this ice to restart the icemaker
- Piled up cubes in storage bin may cause icemaker to shut off prematurely. With icemaker feeler arm in STOP (up) position, level cubes in bin by hand
- When leveling cubes by hand, you may have pushed the feeler arm into the STOP (up) position by mistake.

### Cube dispenser does not work

- No ice cubes Remove storage container. If cubes are frozen to wire arm, remove cubes
- No ice cubes Icemaker or water supply turned off.
- Irregular ice clumps in storage container. Break up as many as you can with fingertip pressure and discard the remaining clumps

### Water has poor taste/odor

If water dispenser has not been used for an extended period, dispense several glassfuls of water to eliminate taste temporarily imparted by the water line

- Poor-tasting incoming water Install a water filter

### Water dispenser does not work

- Water supply line turned off or not connected.
- Supply line may be clogged with sediment

### Moisture forms on outside of refrigerator

- Not unusual during periods of high humidity.

### Moisture collects inside

- Too frequent or too long door openings.
- In humid weather, air carries moisture into refrigerator when doors are opened.

### Water on floor

- The drain in the bottom of the freezer may be clogged. Remove any ice on the freezer bottom and clean the drain. Refer to Care and Cleaning section

### Hot air from bottom of refrigerator

- Normal air flow cooling motor In the refrigeration process, it is normal that heat be expelled in the area under the refrigerator. Some floor coverings will discolor at these normal and safe operating temperatures. Your floor covering supplier should be consulted if you object to this discoloration

### Interior light does not work

- No power at outlet
- Light bulb needs replacing. See Care and Cleaning section

### Refrigerator has odor

- Food with strong odors should be tightly covered.
  - Check for spoiled food
  - Interior needs cleaning Refer to Care and Cleaning section.
  - Defrost water system needs cleaning
  - Keep open box of baking soda in refrigerator; replace every three months.
- 

### Water Filter Accessory

(optional at extra cost)

Your ice cubes can only be as fresh-tasting as the water that produces them. That's why it's a good idea to purify the water with a water filter.

The water filter is an optional part at extra cost and is available from your Sears Service Center. Order Filter No. 978488 and it may be installed in minutes when attached to the inlet water tube connection.

### Water Supply Accessory Kit

(optional at extra cost)

A water supply kit containing copper tubing, shut-off valve, fittings and instructions needed to connect the icemaker to your cold water line is also available from your Sears store or Sears Service Center.

---

### Moving Precautions

Disconnect the power cord from the wall outlet, remove all food and clean and dry the interior. Secure all loose items by taping them securely in place. Keep the refrigerator in an upright position during actual moving and in the van. Secure the refrigerator in the van to prevent movement, and protect the outside with a blanket.

### Vacation Precautions

**For extended vacations or absences,** shut off power to the refrigerator, move the numbered control to the OFF position, and clean the interior with a baking soda solution of one tablespoon of baking soda to one quart of water. Wipe dry. To prevent odors, leave an open box of baking soda in the refrigerator. Leave the doors open.

**For shorter vacations,** remove perishable foods and leave controls at their regular settings. However, if room temperature is expected to drop below 60°F, follow the instructions in the Adjusting the Controls section.

Set icemaker to the STOP position and shut off water supply to refrigerator.

# SEARS

## FULL ONE YEAR WARRANTY ON REFRIGERATOR

For one year from date of purchase, when this refrigerator is operated and maintained according to instructions attached to or furnished with the product, Sears will repair this refrigerator, free of charge, if defective in material or workmanship.

## FULL FIVE-YEAR WARRANTY ON SEALED REFRIGERATION SYSTEM

For five years from date of purchase, when this refrigerator is operated and maintained according to owner's instructions attached to or furnished with the product, Sears will repair the sealed system (consisting of refrigerant, connecting tubing and compressor motor), free of charge, if defective in material or workmanship.

The above warranty coverage applies only to refrigerators which are used for storage of food for private household purposes.

WARRANTY SERVICE IS AVAILABLE BY CONTACTING THE  
NEAREST SEARS SERVICE CENTER/DEPARTMENT IN THE UNITED STATES.

This warranty applies only while this product is in use in the United States.

This warranty gives you specific legal rights,  
and you may also have other rights which may vary from state to state.

SEARS, ROEBUCK AND CO., Dept. 731CR-W, Sears Tower, Chicago, IL 60684

## SEARS SERVICE IS AT YOUR SERVICE

Your Kenmore has added value when you consider that Sears has nationwide service units staffed by Sears-trained technicians...professional technicians specifically trained to service SEARS appliances, having the parts, tools and equipment to insure that we meet our pledge to you..."We Service What We Sell."

### ADD TO THE VALUE OF YOUR KENMORE, BUY A SEARS MAINTENANCE AGREEMENT

Sears Kenmore refrigerators are designed, built and tested for years of dependable use. Yet any modern appliance may need service from time to time. The Sears warranty plus the Sears maintenance agreement give protection from unexpected repair bills. Contact your salesperson or nearest service center for details.

SEARS, ROEBUCK AND CO., Dept. 731CR-W, Sears Tower, Chicago, IL 60684

*This book is printed on recycled paper.*

Part No. SR6114

Printed in U.S.A.  
162D3810P008

53771 53775  
53772 53778