

SEARS

**USE & CARE
MANUAL**

**STOCK NO.
87561**

KNOW YOUR UNIT

Read this booklet so you will be able to enjoy all the features in your Kenmore Micro/Convection Oven.

Record in space provided below the Model No. and the Serial No. found on the labels on the inner left side of control panel.

Model No. _____

Serial No. _____

Retain this information for future reference.

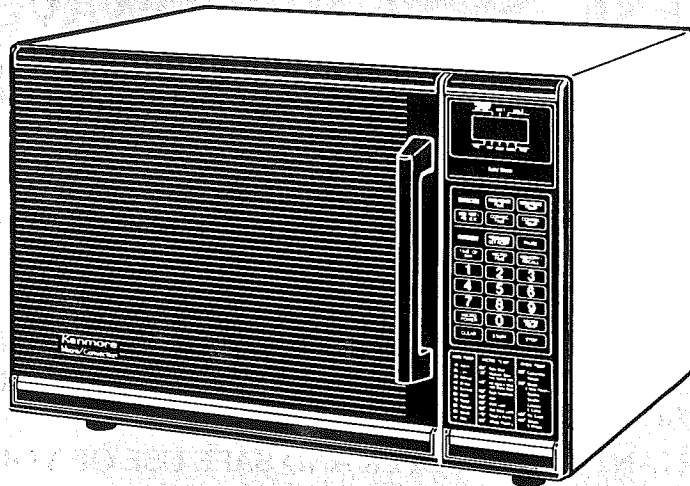

Kenmore

**MICRO/CONVECTION
OVEN**

Use and Care

YOUR SAFETY FIRST

The Sears Kenmore Microwave/Convection Oven, though simple to use, is not a toy. Respect it as an electric cooking appliance. Become familiar with microwave energy, its uses, and limitations.

PRECAUTIONS TO AVOID POSSIBLE EXPOSURE TO EXCESSIVE MICROWAVE ENERGY

- (a) DO NOT ATTEMPT to operate this oven with the door open since open-door operation can result in harmful exposure to microwave energy. It is important not to defeat or tamper with the safety interlocks.
- (b) DO NOT PLACE any object between the oven front face and the door or allow soil or cleaner residue to accumulate on sealing surfaces.
- (c) DO NOT OPERATE the oven if it is damaged. It is particularly important that the oven door close properly and that there is no damage to the:
 - (1) DOOR (bent)
 - (2) HINGES AND LATCHES (broken or loosened)
 - (3) DOOR SEALS AND SEALING SURFACES:
- (d) THE OVEN SHOULD NOT BE ADJUSTED OR REPAIRED BY ANYONE EXCEPT PROPERLY QUALIFIED SERVICE PERSONNEL.

IMPORTANT—FOR PROPER AND SAFE USE OF YOUR OVEN

- The oven must be level.
- The electrical power cord must be kept dry and must not be pinched or crushed in any way.
- The ceramic tray must be in the oven for the microwave or micro/convec cooking. However, the ceramic tray must be removed from oven for the convection cooking. (See Page 8 for detailed instructions.)
- The metal rack must be removed from oven when rack is not used for cooking.
- Place the cookware gently on the ceramic tray and handle the tray carefully to avoid breakage.
- When a browning dish is used, the browning dish bottom must be at least 3/16 in. above cooking tray. Carefully read and follow the instructions for the browning dish. Incorrect usage may cause the ceramic tray to break.
- The oven should be thoroughly checked by a trained service technician, should it be dropped or damaged, before it is operated again.
- The oven has several built-in safety switches to make sure the power remains off when the door is open. DO NOT try to defeat these switches.

DON'TS

- DO NOT attempt to operate this oven with the door open.
- DO NOT run the oven empty without food in it.
- DO NOT operate the oven empty with the temperature probe plugged in.
- DO NOT let the temperature probe touch the side walls, ceramic tray or door of the cavity when in use.
- DO NOT plug the pointed end of the temperature probe into the socket inside the cavity.
- DO NOT use the temperature probe in a regular oven. This probe is designed for microwave oven only.
- DO NOT use metal baking pan for microwave or micro/convec cooking.
- DO NOT cook bacon directly on the ceramic tray to avoid excessive local heating on the ceramic tray.
- DO NOT store burnable material, such as food, in your microwave/convection oven.
- DO NOT heat any types of baby bottles or baby food. Uneven heating may occur and possibly cause personal injury.
- DO NOT heat small-necked containers, such as syrup bottles, in the microwave oven.
- DO NOT use this microwave/convection oven for commercial purposes. This Sears Kenmore Microwave/Convection Oven is made for household use only.

SAFETY CERTIFICATION

The Sears Kenmore Microwave/Convection Oven is designed and thoroughly tested to meet exacting safety standards. It meets UL and FCC requirements and complies with safety performance standards of the U.S. Department of Health and Human Services.

IMPORTANT SAFETY INSTRUCTIONS

When using electrical appliances basic safety precautions should be followed, including the following:

WARNING—To reduce the risk of burns, electric shock, fire, injury to persons or exposure to excessive microwave energy:

1. Read all instructions before using the appliance.
2. Read and follow the specific “PRECAUTIONS TO AVOID POSSIBLE EXPOSURE TO EXCESSIVE MICROWAVE ENERGY” found on page 2.
3. As with most cooking appliances, close supervision is necessary to reduce the risk of a fire in the oven cavity.

NOTE: If a fire should start:

*KEEP THE OVEN DOOR CLOSED

*TURN THE OVEN OFF

*AND DISCONNECT THE POWER CORD OR SHUT OFF POWER AT THE FUSE OR CIRCUIT BREAKER PANEL.

- a. Do NOT grossly overcook foods. As many grossly overcooked foods will cause fires in the oven cavity, carefully attend the oven; especially, if paper, plastic, or other combustibles are placed inside the oven.
 - b. Do NOT store combustible items such as, bread, cookies, etc. inside the oven because if lightning strikes the power lines it may cause the oven to turn ON.
 - c. Do NOT use wire twist-ties in the oven. Be sure to inspect purchased items for wire twist-ties and remove them before the item is placed in the oven.
4. This appliance must be grounded. Connect only to properly grounded outlet. See “GROUNDING INSTRUCTIONS” found on page 6.

5. Install or locate this appliance only in accordance with the provided installation instructions.
6. Some products such as whole eggs, water with oil or fat, sealed containers and closed glass jars for example may explode and should not be heated in this oven.
7. Use this appliance only for its intended use as described in this manual.
8. As with any appliance, close supervision is necessary when used by children.
9. Do not operate this appliance if it has a damaged cord or plug, if it is not working properly or if it has been damaged or dropped.
10. This appliance should be serviced only by qualified service personnel. Contact nearest authorized service facility for examination, repair or adjustment.
11. Do not cover or block any openings on the appliance.
12. Do not use outdoors.
13. Do not immerse cord or plug in water.
14. Keep cord away from heated surfaces.
15. Do not let cord hang over edge of table or counter.
16. When cleaning surfaces of door and oven that come together on closing the door, use only mild, non-abrasive soaps or detergents applied with a sponge or soft cloth. (See “Care and Cleaning” instructions on page 35.)

SAVE THESE INSTRUCTIONS

TABLE OF CONTENTS

General Instructions

■ Location of Model Number Label	5
■ IMPORTANT—Electrical Grounding Instructions	6
■ Installation	7
■ Setting “Time of Day”	7
■ Names of Oven Parts	8
■ Oven Control Panel	9
■ How the Microwave/Convection Oven Works	10

Use Instructions

■ Easy Use Chart	11—12
■ Recall and Change of Settings	13
■ Pause between Stages	13
■ Regular Timer	13

Detailed Directions

■ Microwave Cooking	14—26
• Cooking Guide for Multi-Power Settings	14
• “HI-Power”/“Multi-Power” Cooking	15
• “Temperature Controlled” Cooking	16—18
• Temperature Controlled “HI-Power”/“Multi-Power” Cooking and Automatic “Hold Warm”	19
• Programmed Defrost	20—24
• Multi-Stage Cooking	25—26
• Delay Start Cooking	26
■ Convection Cooking	27—33
• Convection Cooking with Automatic Preheat	28
• Temperature Controlled Cooking Guide for Convection Cooking	29
• Temperature Probe Convection Cooking	30
• Micro/Convec Cooking	31
• Temperature Controlled Cooking Guide for Micro/Convec Cooking	32
• Temperature Probe Micro/Convec Cooking	33
Oven Utensils Guide	34
Care and Cleaning	35
Questions and Answers	36—37
Sears Service	38
Sears Warranty	Back Cover

SEARS KENMORE MICROWAVE/CONVECTION OVEN
"USE AND CARE MANUAL"—
MICROWAVE/CONVECTION OVEN USE INSTRUCTIONS

Enjoy a new cooking experience from Sears. Please read this booklet. It takes only a few minutes — time well spent to learn how to use all of the features.

Advice on the use and care of Sears appliances is always available at your nearest Sears store. When seeking information, be sure you have the complete model number which is located on the plastic label. See below for its location.

MODEL NUMBER

To make a request for service, information or replacement of parts, Sears will require the complete model number of you microwave/convection oven. The number is on the inner left side of the control panel. (You must open the door to see the number).

The number will look like this: 564.8000000.

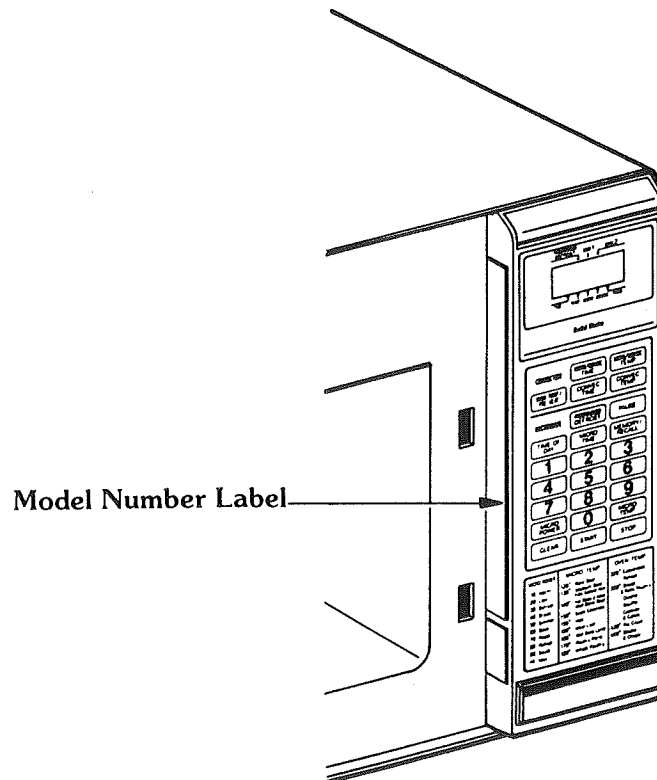

IMPORTANT— ELECTRICAL GROUNDING INSTRUCTIONS

This appliance must be grounded. In the event of an electrical short circuit, grounding reduces the risk of electric shock by providing an escape wire for the electric current. This appliance is equipped with a cord having a grounding wire with a grounding plug. The plug must be plugged into an outlet that is properly installed and grounded.

WARNING — Improper use of the grounding plug can result in a risk of electric shock.

Consult a qualified electrician or Sears Service Department if the grounding instructions are not completely understood, or if doubt exists as to whether the appliance is properly grounded.

A short power-supply cord is provided to reduce the risks resulting from becoming entangled in or tripping over a longer cord.

Longer cord sets or extension cords are available and may be used if care is exercised in their use.

If a long cord or extension cord is used, (1) the marked electrical rating of the cord set or extension cord should be at least as great as the electrical rating of the appliance*, (2) the extension cord must be a grounding-type 3 wire cord, and (3) the longer cord should be arranged so that it will not drape over the countertop or tabletop where it can be pulled on by children or tripped over accidentally. The electrical power cord must be kept dry and must not be pinched or crushed in any way.

*NOTE: Electrical Rating of the Oven; 1600 Watts, 13.3 Amperes

PROPERLY POLARIZED AND
GROUNDED OUTLET

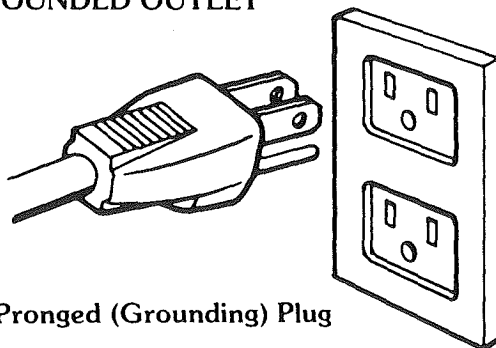

Three-Pronged (Grounding) Plug

INSTALLATION

Install your oven by following these four simple steps:

- Step 1:** Remove all packing material and accessories. Then remove the protection sheet on wrapper.
- Step 2:** Place the oven in the level location of your choice, but make sure there is at least one inch of space on the top and at the rear for proper ventilation. The top of the oven should be kept clear and the plastic feet must be kept on the oven so there is air flow ventilation. An exhaust outlet is at the rear of the oven. Blocking the outlet can damage the oven.
- Step 3:** Plug your oven into a Standard 120 volt household outlet. Be sure the electrical circuit is at least 15 amperes and that your microwave/convection oven is the only appliance on the circuit.
- Step 4:** When your microwave/convection oven is plugged in for the first time or when power resumes after a power interruption, the numbers in the display window will show "0:00" plus the hours and minutes that have elapsed since the oven was plugged in or the power was restored. This means that the TIME OF DAY clock must be set. Refer to "Setting Time of Day" below.

NOTE: If your oven does not operate properly, unplug the oven from the 120-volt household outlet and then plug it back in.
This unit is not designed for 50 Hz or any circuit other than a 120 volt/60 Hz AC circuit.

SETTING TIME OF DAY

- Touch CLEAR.
- Touch TIME OF DAY.
- Touch numbers indicating the correct time.
- Touch TIME OF DAY.

(This is also explained in the "Easy Use Chart" Time of Day Section on Page 11.)

DIMENSIONS

Height	14-9/16"
Width	20-1/2"
Depth	19-11/16"
Weight	53 lbs.

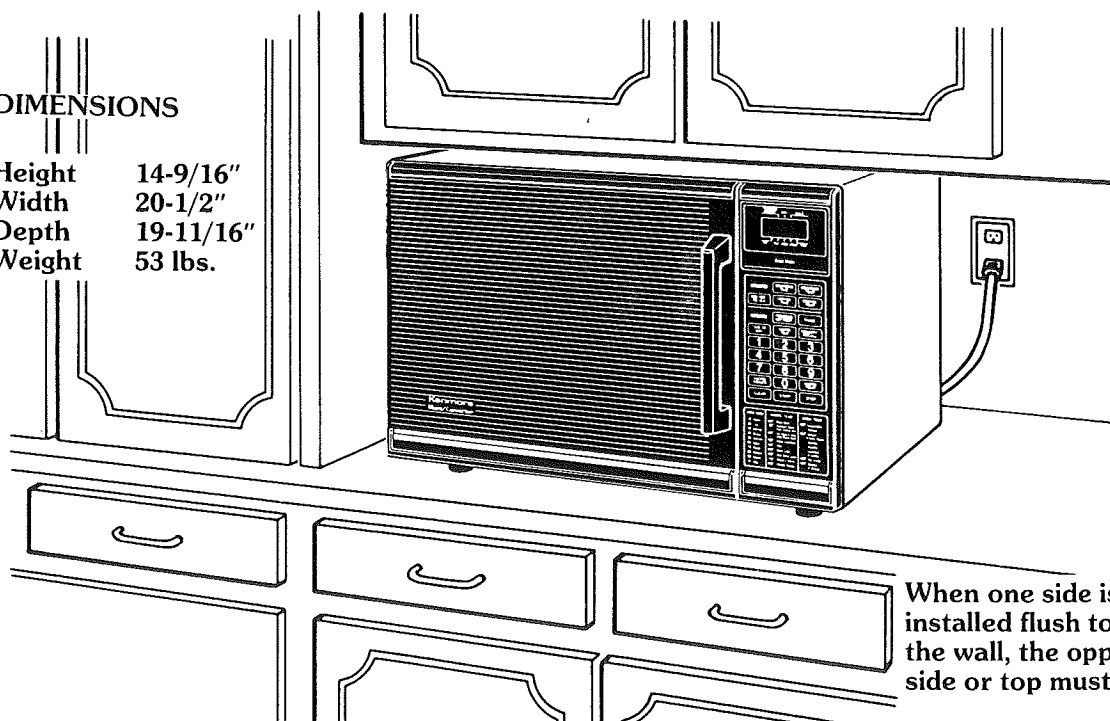

When one side is installed flush to the wall, the opposite side or top must be open.

NAMES OF OVEN PARTS

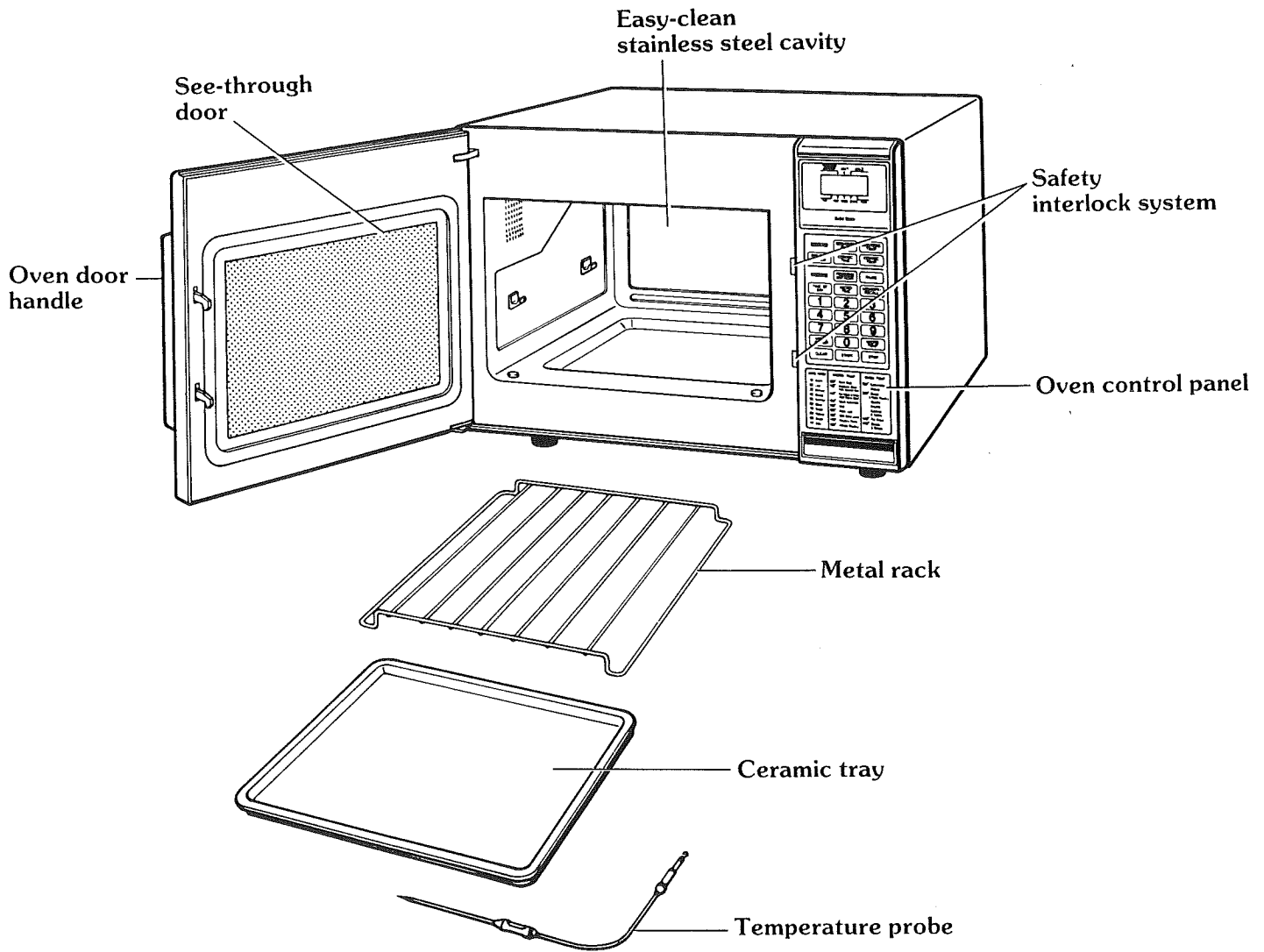

Remove your Sears Kenmore Microwave/Convection Oven and all items from the shipping carton. Your oven will be packed with the following items:

Ceramic Tray	1 each
Metal Rack	1 each
Temperature Probe	1 each
"Use and Care Manual"	1 each
"Easy Use Chart" Card	1 each
Cook Book	1 each

* The ceramic tray should always be in the oven when either the microwave or micro/convec cooking is used. Microwaves pass through the tray and are reflected by the oven bottom back up to the underside of the food. As a result, the food receives microwave energy on the bottom, top, and sides all at the same time. However, the tray must be removed for convection cooking. This is because, both the upper and lower heaters are in operation for convection cooking, and the ceramic tray shields heat from the lower heater.

* Do not use this Sears Kenmore Microwave/Convection Oven for commercial purposes. This microwave/convection oven is made for household use only.

OVEN CONTROL PANEL

Indicator Lights—Time, Temp, Micro, Convec and Programmed Defrost lights indicate which cooking operation is being used.

Micro/Convec Time—Used in setting Micro/Convec Cooking Time.

Convec Time—Used in setting Convection Cooking Time.

Oven Temp/Preheat—Used in setting the desired Oven Temperature, Preheat Temperature.

Programmed Defrost—Used in setting Programmed Defrost.

Micro Time—Used in setting Microwave Cooking Time.

Time of Day—Used in setting Time of Day.

Numbers—Used to enter the Time of Day, Delay Start Time, Cooking Times, Cooking Powers and Cooking Temperatures.

Micro Power—Used to select Microwave Cooking Power Levels.

Clear—Clears all entries except Time of Day. Once cooking has begun, however, CLEAR will function only after STOP has been touched.

Micro Power Guide—Lists the Types of Cooking that most often occur at these Microwave Cooking Power Levels.

Micro Temp Guide—Lists examples of food that are best cooked to these Microwave Cooking Temperatures.

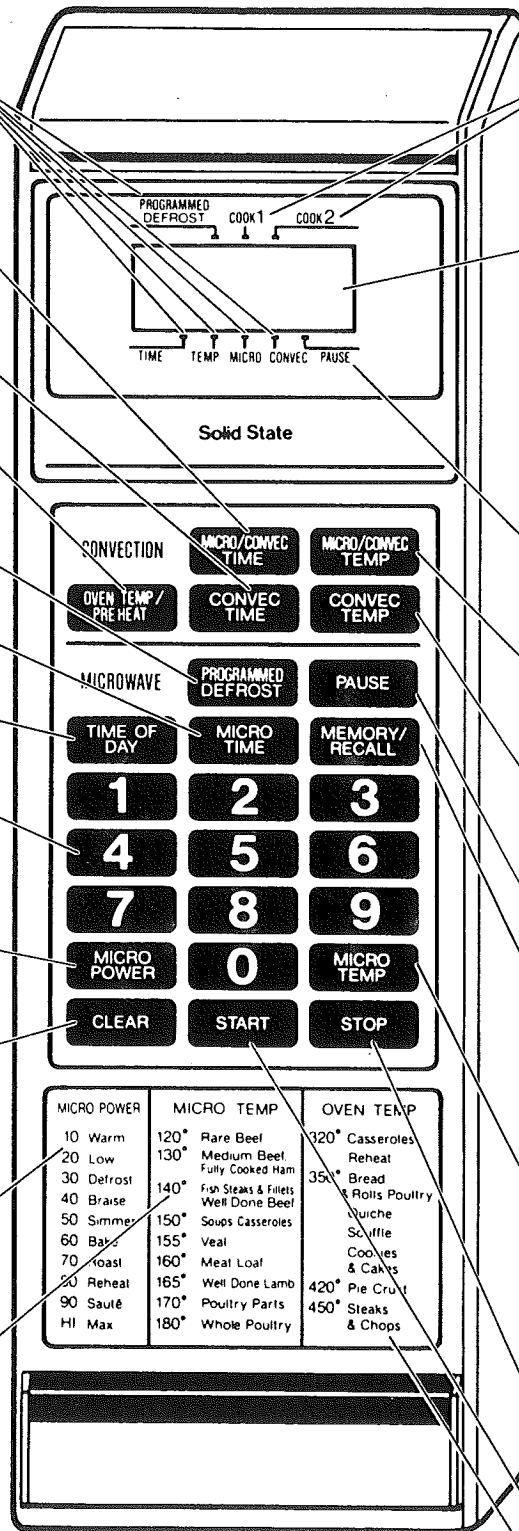

Stage Lights—When cooking stages are set, lights will go on indicating the stage in which your oven is cooking.

Display Window—Used to show:

- Time of Day
- Cooking Time
- Microwave Cooking Power Level
- Cooking Probe Temperature
- Oven Temperature
- Hold, End, Prob (Probe)

It also functions as countdown timer or temperature indicator when cooking.

Pause Light—Shows Oven has been set to pause between the Cooking Stages.

Micro/Convec Temp—Used in setting the desired Micro/Convec Cooking Temperature with Temperature Probe.

Convec Temp—Used in setting the desired Convection Cooking Temperature with Temperature Probe.

Pause—Used to stop Oven between the Cooking Stages.

Memory/Recall—Used in setting Cooking Time, Power Level and Temperature for Multi-Stage Cooking. Also used to recall each memory stage in a multiple stage program.

Micro Temp—Used in setting the desired Microwave Cooking Temperature. Temperature Controlled Cooking can be done only when the Temperature Probe is plugged into the socket inside the Oven.

Stop—Stops Oven.

Start—Starts Oven.

Oven Temp Guide—Lists examples of Oven Temperature for Convection Cooking.

NOTE: A “beep tone” sounds when a “pad” on the control panel is touched, to indicate a setting has been entered.

HOW THE MICROWAVE/CONVECTION OVEN WORKS

Microwave Cooking

Using the energy of microwaves only, food is heated quickly without altering the color or shape. Microwaves generated by a magnetron are uniformly distributed by the fan so that the food in the oven is heated and cooked. Microwave power can be adjusted in 99 steps, enabling the various kinds of foods to cook at most desirable cooking power for the best results.

Stirrer/Convection Fan

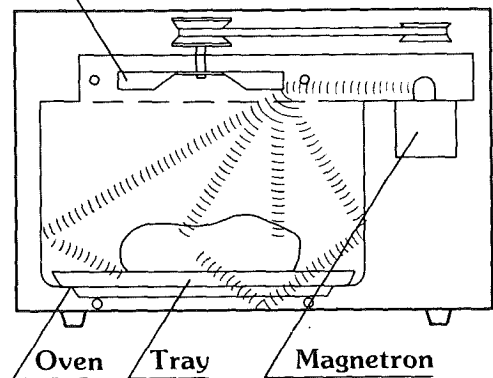

Convection Cooking

This is a way of cooking with the combination of hot air from the upper heater and thermal conduction from the lower heater that heats and cooks food from the outside. This method allows food to be browned evenly without losing any of the juices. Air heated by the top heater is uniformly circulated in the oven by a fan to enable the heating and cooking of food. Since hot air remains in the oven as it circulates, cooking is very efficient. And more, the lower heater cooks food from bottom side to provide the even cooking results. The temperature inside the oven can be controlled according to the type of food being cooked. Clicking sound of heater switching from lower to upper heating element and back again is a normal sound associated with this oven.

An "Oil Canning" noise may be heard when using the convection method. This is a normal sound caused by the cold oven floor reacting to the heating of the element below the oven floor surface or to the hot surface cooling down.

Stirrer/Convection Fan

Upper Heater

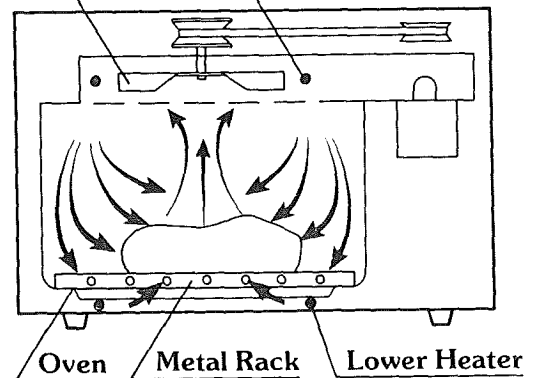

Micro/Convec Cooking

With both microwave energy and hot air utilized, this method cooks food much more quickly than any conventional method. The solid state control alternates cooking energy between microwave and hot air cycles to provide efficient cooking fully utilizing the advantages of both microwave and hot air cooking systems.

When foods with high moisture content are cooked on the micro/convec method, beads of water may accumulate on the top and/or sides of the oven door, but will dissipate after use.

Stirrer/Convection Fan

Heater

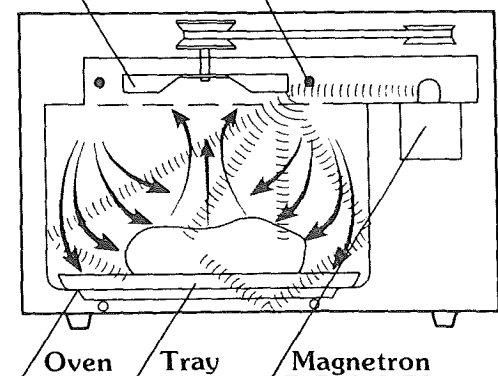

EASY USE CHART—MICROWAVE COOKING

Your new Solid State Control allows you to use your microwave/convection oven in many ways.

TIME OF DAY	TIMER	"HI-POWER"/"MULTI-POWER" COOKING
<p>To Set</p> <ol style="list-style-type: none"> 1. Touch CLEAR. 2. Touch TIME OF DAY. 3. Touch numbers for correct time of day. 4. Touch TIME OF DAY.* <p>* This "locks" in the time and starts the clock running.</p>	<p>To Set</p> <ol style="list-style-type: none"> 1. Touch CLEAR. 2. Touch MICRO TIME. 3. Touch correct numbers for the time. 4. Touch MICRO POWER. 5. Touch "0" (power level 0). 6. Touch START. <p>(See Page 13 for more detailed instructions.)</p>	<p>To Set</p> <ol style="list-style-type: none"> 1. Touch CLEAR. 2. Touch MICRO TIME. 3. Touch numbers for desired cooking time. 4. Touch MICRO POWER. 5. Touch numbers for desired cooking power level. 6. Touch START. <p>NOTE: It is not necessary to touch MICRO POWER when cooking with the highest power ("HI"). To set "HI-POWER" Cooking, skip steps 4 and 5 above.</p> <p>(See Page 15 for more detailed instructions.)</p>
TEMPERATURE CONTROLLED "HI-POWER"/"MULTI-POWER" COOKING	MULTI-STAGE COOKING	DELAY START COOKING
<p>To Set</p> <ol style="list-style-type: none"> 1. Plug in Temperature Probe. 2. Touch CLEAR. 3. Touch MICRO TEMP. 4. Touch numbers for desired food temperature. 5. Touch MICRO POWER. 6. Touch numbers for desired cooking power level. 7. Touch START. <p>NOTE: It is not necessary to touch MICRO POWER when cooking with the highest power ("HI"). To set "HI-POWER" Cooking, skip steps 5 and 6 above.</p> <p>(See Page 19 for more detailed instructions.)</p>	<p>To Set</p> <ol style="list-style-type: none"> 1. Touch CLEAR. 2. Touch MICRO TIME or MICRO TEMP. 3. Touch numbers for desired cooking time or temperature. 4. Touch MICRO POWER. 5. Touch numbers for desired cooking power level. 6. Touch MEMORY/RECALL or PAUSE and repeat steps 2-5 to set 2nd cooking stage. 7. Touch START. <p>(See Pages 25 and 26 for more detailed instructions.)</p>	<p>To Set</p> <ol style="list-style-type: none"> 1. Touch CLEAR. 2. Touch MICRO TIME. 3. Touch numbers for desired delay time. 4. Touch MICRO POWER. 5. Touch "0" (power level 0). 6. Touch MEMORY/RECALL. 7. Touch MICRO TIME or MICRO TEMP. 8. Touch numbers for desired cooking time or temperature. 9. Touch MICRO POWER. 10. Touch numbers for desired cooking power level. 11. Touch START. <p>NOTE: A preset delay time must be less than 99 minutes.</p> <p>(See Page 26 for more detailed instructions.)</p>
PROGRAMMED DEFROST		
<p>To Set</p> <ol style="list-style-type: none"> 1. Touch CLEAR. 2. Touch PROGRAMMED DEFROST. 3. Touch numbers for desired defrost time. 4. Touch START. <p>(See Pages 20 thru 24 for more detailed instructions.)</p>		

EASY USE CHART—CONVECTION COOKING

CONVECTION COOKING	AUTOMATIC PREHEAT	TEMPERATURE PROBE CONVECTION COOKING
<p>To Set</p> <ol style="list-style-type: none"> 1. Touch CLEAR. 2. Touch OVEN TEMP/PREHEAT. 3. Touch numbers for desired oven temperature. 4. Touch CONVEC TIME. 5. Touch numbers for desired cooking time. 6. Touch START. <p>(See Page 28 for more detailed instructions.)</p>	<p>To Set</p> <ol style="list-style-type: none"> 1. Touch CLEAR. 2. Touch OVEN TEMP/PREHEAT. 3. Touch numbers for desired oven temperature. 4. Touch START. <p>(See Page 28 for more detailed instructions.)</p>	<p>To Set</p> <ol style="list-style-type: none"> 1. Plug in Temperature Probe. 2. Touch CLEAR. 3. Touch OVEN TEMP/PREHEAT. 4. Touch numbers for desired oven temperature. 5. Touch CONVEC TEMP. 6. Touch numbers for desired food temperature. 7. Touch START. <p>(See Page 30 for more detailed instructions.)</p>
MICRO/CONVEC COOKING	TEMPERATURE PROBE MICRO/CONVEC COOKING	DELAY START COOKING
<p>To Set</p> <ol style="list-style-type: none"> 1. Touch CLEAR. 2. Touch OVEN TEMP/PREHEAT. 3. Touch numbers for desired oven temperature. 4. Touch MICRO/CONVEC TIME. 5. Touch numbers for desired cooking time. 6. Touch START. <p>(See Page 31 for more detailed instructions.)</p>	<p>To Set</p> <ol style="list-style-type: none"> 1. Plug in Temperature Probe. 2. Touch CLEAR. 3. Touch OVEN TEMP/PREHEAT. 4. Touch numbers for desired oven temperature. 5. Touch MICRO/CONVEC TEMP. 6. Touch numbers for desired food temperature. 7. Touch START. <p>(See Page 33 for more detailed instructions.)</p>	<p>To Set</p> <ol style="list-style-type: none"> 1. Touch CLEAR. 2. Touch MICRO TIME. 3. Touch numbers for desired delay time. 4. Touch MICRO POWER. 5. Touch "0" (power level 0). 6. Touch MEMORY/RECALL. 7. Touch CONVEC TEMP or MICRO/CONVEC TEMP. 8. Touch numbers for desired food temperature. 9. Touch START. <p>NOTE: A preset delay time must be less than 99 minutes.</p> <p>(See Page 26 for more detailed instructions.)</p>

RECALL AND CHANGE OF SETTINGS

To Recall a Setting

To recall (check) a setting **before you start the oven**, follow the directions below.

- To check the Setting for a given stage, touch MEMORY/RECALL once or more until the correct Stage Light and Indicator Light turn on. The set Time, Temperature or Oven Temperature for that stage will show in the display window.
- To check the Microwave Cooking Power level, touch MICRO POWER.
- To check the Oven Temperature, touch OVEN TEMP/PREHEAT.

To recall (check) a setting **while the oven is operating**, follow the directions below.

- To check settings while the oven is operating, touch the desired pad to recall the setting for the operating stage.
- To recall a future stage, touch STOP, follow the directions above for recalling (checking) a setting before starting the oven, and then touch START to continue cooking.
- To recall TIME OF DAY while the oven is running, touch TIME OF DAY. It will show momentarily in the display window.

To Change a Setting

Recall the Setting to be changed by following directions above and make the change as follows:

TIME (MICRO TIME, CONVEC TIME, MICRO/CONVEC TIME)	Touch "0" until only one "0" shows in the Display Window. Set Cooking Time.
TEMPERATURE CONTROL (MICRO TEMP, CONVEC TEMP, MICRO/CONVEC TEMP)	Set Cooking Probe Temperature.
MICRO POWER	Set Microwave Cooking Power Level. To reset to "HI", set "99".
OVEN TEMP/PREHEAT	Set Oven Temperature.

PAUSE BETWEEN STAGES

Some recipes require placing or removing of ceramic tray, stirring, turning and adding or removing of foods between stages. To set the oven to stop between stages, touch PAUSE rather than MEMORY/RECALL when setting the oven. If pause is set, the oven will automatically stop. After the pause, to restart the oven, touch START.

REGULAR TIMER

Your Oven also has a timer that can be used for non-cooking functions. When used as a regular timer, the Oven is not running. The timer is simply counting down in seconds. For detailed instructions on using this timer, see below.

To use the Regular Timer feature:

1. Touch CLEAR.
2. Touch MICRO TIME.
3. Touch numbers for the time.
4. Touch MICRO POWER.
5. Touch "0" (power level 0)
6. Touch START. The time will begin counting down in the display window with no cooking or heating in the oven.
A tone will sound and the word "End" will show in the display window for 2 seconds when the time is over.

COOKING GUIDE FOR “MULTI-POWER” SETTINGS

The “Multi-Power” feature lets you cook at the best power level for the food being cooked. Cooking directions can be found in the cookbook.

POWER LEVEL	POWER SETTINGS	EXAMPLES	MICROWAVE OUTPUT POWER*
10	WARM	<ul style="list-style-type: none"> • Softening cream cheese. • Keeping casseroles and main dishes warm. 	140
20	LOW	<ul style="list-style-type: none"> • Softening chocolate. • Heating breads, rolls, pancakes, tacos, tortillas and French toast. • Clarifying butter. • Taking the chill out of fruit. • Heating small amounts of food. 	200
30	DEFROST MED LOW	<ul style="list-style-type: none"> • Thawing meat, poultry and seafood. • Completing the cooking cycle of casseroles, stews and some sauces. • Cooking small quantities of most food. 	255
40	BRAISE	<ul style="list-style-type: none"> • Cooking less tender cuts of meat in liquid or slow cooking dishes. • Completing the cooking cycle of less tender roasts. 	315
50	SIMMER	<ul style="list-style-type: none"> • Cooking stews and soups after bringing to a boil. • Cooking baked custards and pasta. 	375
60	BAKE	<ul style="list-style-type: none"> • Cooking scrambled eggs. • Cooking cakes. 	430
70	ROAST MED HIGH	<ul style="list-style-type: none"> • Cooking rump roast, ham, veal, and lamb. • Cooking cheese dishes. • Cooking eggs and milk. • Cooking quick breads and cereal products. 	485
80	REHEAT	<ul style="list-style-type: none"> • Reheating precooked or prepared food quickly. • Heating sandwiches. 	540
90	SAUTÉ	<ul style="list-style-type: none"> • Cooking onions, celery and green peppers quickly. • Reheating meat slices quickly. 	595
100 (HI)	MAX POWER HIGH	<ul style="list-style-type: none"> • Cooking tender cuts of meat. • Cooking poultry, fish, vegetables and most casseroles. • Preheating the browning dish. • Boiling water. • Thickening some sauces. 	650

* Approximate watts as measured by 2-liter method.

As you get to know your microwave oven, you may find that a particular setting is too low or too high for the results you desire.

Multi-power control gives you the means to obtain greater precision in setting power levels. For instance, if you want a power level between ROAST and REHEAT, you would set the time as usual: touch MICRO POWER, and then touch “7” and “5”. The display window will show “75”, indicating that your oven is set to run at power level 75 — halfway between ROAST and REHEAT.

“HI-POWER”/“MULTI-POWER” COOKING

“HI” gives the highest power cooking possible with your oven. It is the recommended setting for cooking foods with high moisture content or for cooking foods that need fast cooking to maintain their natural flavor and texture. Many foods need slower cooking (at less than full power) in order to give you the best results. In addition to “HI” there are ninety-nine multi-power settings. The cookbook tells you which power setting is recommended for the food being cooked.

To Cook

1. Touch CLEAR, and a beep tone will be heard. The CLEAR erases all previous settings.
2. Touch MICRO TIME. The lights above TIME and MICRO, below COOK 1 will go on. (“0” will show in the display window.)
3. Touch the correct numbers on the control panel to set the cooking time. The time set will show in the display window at the top of the control panel. For example:
 - To set 30 seconds, you would touch “3” and then “0”.
 - To set 3 minutes, touch “3”, “0” and “0”.
 - To set 3-1/2 minutes, touch “3”, “3” and “0”.

Remember, the timer is a digital clock that is divided into 60 seconds. Therefore, 1/2 minute is equal to 30 seconds. Touch 30 and not 50 as with a calculator to indicate 1/2.

4. Touch MICRO POWER. The lights above MICRO and below COOK 1 will go on. Also, the word “HI” will show in the display window until a lower setting is entered. This is to tell you that the oven will be operating on “HI” unless a different power setting is chosen.
5. Touch numbers for desired cooking power level. For example, if the recipe calls for cooking at the “20 (LOW)” setting, you would touch “2” and “0”. The display window will show “20”. This means that in the LOW setting, the oven is cooking at power level 20.

NOTE: It is not necessary to touch MICRO POWER when cooking with the highest power (“HI”). To set “HI-POWER” cooking, skip steps 4 and 5 above. However, if MICRO POWER is touched, the light above MICRO will go on and the word “HI” will show in the display window. This is to let you know that the oven will be operating on “HI” power unless a different power setting is chosen.

6. Touch START. The oven begins to cook and the display window will show the time counting down. A tone will sound and the word “End” will show in the display window for two seconds when the cooking time is completed. Then the oven will shut itself off.

EXAMPLE: To warm 4 doughnuts, you would cook at power level 80 or “80 (REHEAT)” for 35 seconds. To do this, follow these six steps.

1. Touch CLEAR.
2. Touch MICRO TIME.
3. Set 35 seconds by touching “3” and then “5”. “35” will show in the display window.

CLEAR

MICRO TIME

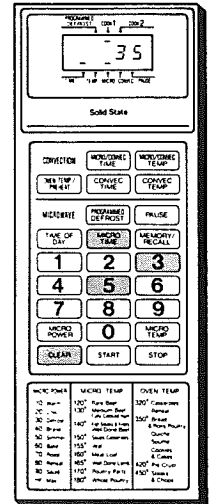

4. Touch MICRO POWER. The display window will show “HI”.

MICRO POWER

5. Choose the “80 (REHEAT)” setting by touching the numbers “8” and “0”. The display window will show “80”. This means the oven is cooking at power level 80.

8 0

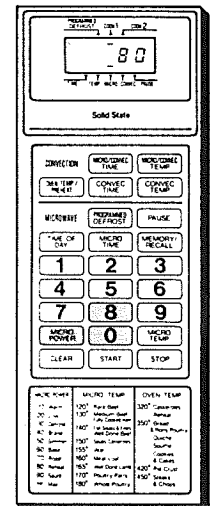

6. Touch START. The oven begins to cook and the time will begin to count down in the display window.

START

A tone will sound and the word “End” will show in the display window for 2 seconds when the 1-1/2 minutes are over. Then the oven will shut itself off.

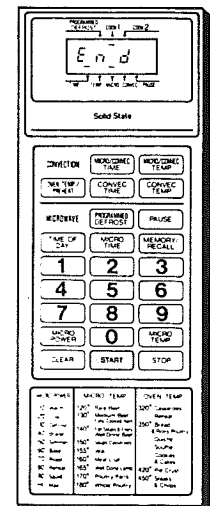

“TEMPERATURE CONTROLLED” COOKING

The temperature probe is used to judge doneness when cooking or reheating food. Set the desired food temperature with the MICRO TEMP, and the desired power level with the MICRO POWER.

When the food reaches the desired temperature, the oven will hold the food at the desired temperature up to one hour:

TEMPERATURE SETTING & DISPLAY TEMPERATURE

Temperatures from 115°F to 185°F can be chosen and set in the oven. The temperature should be set in five-degree increments. The display window will show the rise in food temperature in five-degree increments.

For example, when a temperature of 125°F is set, the display window will show the temperature as it rises from 115°F to 120°F and then to 125°F. The lowest temperature number that can be displayed is 115°F. Therefore, even though the food may be less than 115°F, the display will remain at 115°F until the food is heated to above 115°F.

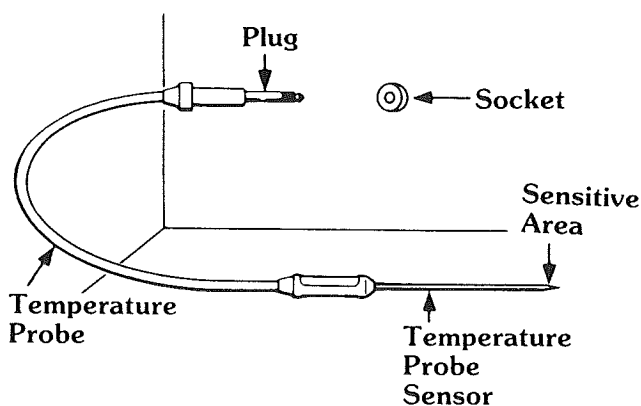

DEFINITIONS

TEMPERATURE PROBE SENSOR: The pointed metal portion of the probe which is placed into the food.

SENSITIVE AREA OF SENSOR: The first inch, or tip, of the temperature probe sensor.

PLUG: The end of the temperature probe that is plugged into the oven socket.

SOCKET: The outlet on the side of the oven wall.

CAUTION: Do not plug the pointed end of the temperature probe into the socket.

DISPLAY WINDOW: Shows the Cooking Temperature rising as the food is cooking. Chosen temperature may be seen during cooking by touching MICRO TEMP. When chosen temperature is reached the Display will show “Hold” for 60 minutes or until Door is opened or STOP is touched.

MEATS

- Choose only fresh, completely thawed meat.
- Place meat fat side down on the microwave roasting rack in a glass baking dish.
- Microwave cook on the first “multi-power” setting for half of the total cooking time. (See “Temperature Controlled” Meat Cooking Guide on Page 17.)
- Turn meat to fat side up and:
 1. Place the temperature probe sensor into the meat with the first inch of the sensor in the center of the meat. The sensor should not touch the bone or fat pocket. The sensor should be put in from the side or from the front — it should not be put in from the top of the meat.
 2. Plug the temperature probe into the socket on the side of the oven wall.
 3. Choose the doneness temperature from the chart on Page 17. Set the temperature with the MICRO TEMP.
 4. Microwave cook the meat on the second “multi-power” setting. The microwave oven will turn itself off when the preset temperature is reached. Take the food out of the oven as soon as the display window shows “End”.
 5. Remove the temperature probe sensor. Let the meat stand, covered with foil for about 10 minutes before serving. The temperature will rise about 15°F during standing time.

NOTE: It is normal for meats to become slightly over-cooked in a small circular area in the immediate vicinity of the hole made by the meat probe.

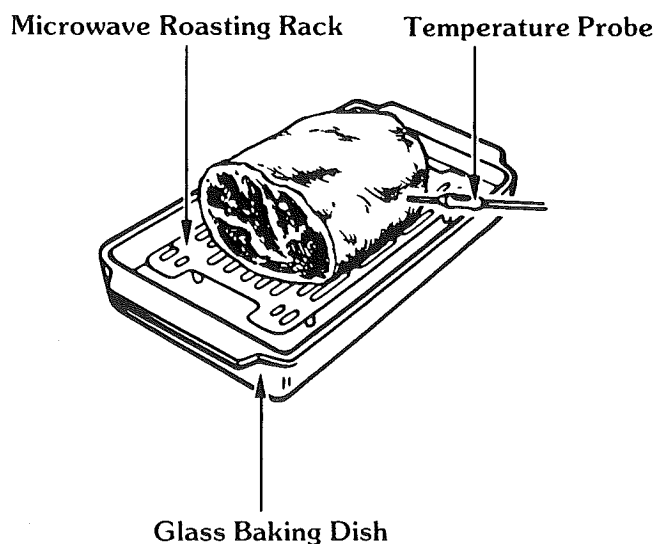

“TEMPERATURE CONTROL” POINTS TO REMEMBER

DO

- Place the temperature probe sensor into the thickest part of the meat or in the center of the food to be reheated. Avoid touching bone or fat.
- Check that the first inch of the sensor is in the densest part of the food to be cooked.
- Remove the temperature probe from the oven after use.
- Be sure to turn meat between first and second settings.
- Refer to cookbook for other information.

DO NOT

- Do not operate the oven empty with the temperature probe plugged in.
- Do not leave the temperature probe unplugged in the cavity when operating the oven.
- Do not let the temperature probe touch the side walls, ceramic tray or door of the cavity when in use.
- Do not plug the pointed end of the temperature probe into the socket inside the cavity.
- Do not use the temperature probe in a regular oven. This probe is designed for micro/convection oven only.

“TEMPERATURE CONTROLLED” MEAT COOKING GUIDE

Refer to “Meats” section on Page 16.

MEAT	FIRST SETTING	SECOND SETTING		STANDING TIME
	TIME	TIME	OR TEMPERATURE PROBE	
BEEF Meat Loaf 2 lbs.	HI (Max. Power) 12—14 min.		HI (Max. Power) 160°F	5—10 min.
Rib Roast, boneless	HI (Max. Power) Rare 4—5 min. per lb. Medium 5—6 min. per lb.	70 (Roast) Rare 3—4 min. per lb. Medium 5—6 min. per lb.	70 (Roast) 120°F 130°F	10 min. 10 min.
Rib Roast, with bone	HI (Max. Power) Rare 3—4 min. per lb. Medium 4—5 min. per lb. Well done 5—6 min. per lb.	70 (Roast) Rare 3—4 min. per lb. Medium 3—5 min. per lb. Well done 5—6 min. per lb.	70 (Roast) 120°F 130°F 140°F	10 min. 10 min. 10 min.
POULTRY Chicken, whole 3-1/2—5 lbs.	HI (Max. Power) 3—4 min. per lb.	HI (Max. Power) 4—5 min. per lb.	HI (Max. Power) 180°F	5 min.
Chicken, pieces 2-1/2—4 lbs.	HI (Max. Power) 10 min.	HI (Max. Power) 4—5 min. per lb.	HI (Max. Power) 170°F	5 min.
Duckling 4—5 lbs.	70 (Roast) 4 min. per lb.	70 (Roast) 4 min. per lb.	70 (Roast) 170°F	8—10 min.
Turkey breast 3—4 lbs.	HI (Max. Power) 7 min. per lb	70 (Roast) 5 min. per lb	70 (Roast) 170°	
PORK Pork Loin Roast, boneless 4—5 lbs.	HI (Max. Power) 5—7 min. per lb.	70 (Roast) 5—6 min. per lb.	70 (Roast) 165°F	10—15 min.
Pork Loin, center cut 4—5 lbs.	HI (Max. Power) 5—7 min. per lb.	70 (Roast) 4—5 min. per lb.	70 (Roast) 165°F	10—15 min.
Ham, boneless, precooked	70 (Roast) 5—6 min. per lb.	70 (Roast) 5—7 min. per lb.	70 (Roast) 130°F	5—10 min.
Center Cut Ham Slice 1—1-1/2 lbs.	70 (Roast) 4—5 min. per lb.	70 (Roast) 5—6 min. per lb.	70 (Roast) 130°F	5 min.
Canned Ham 3—5 lbs.	70 (Roast) 5—6 min. per lb.	70 (Roast) 5—6 min. per lb.	70 (Roast) 130°F	10 min.

REHEATING FOODS

- Place the temperature probe sensor into the food to be reheated with the first inch of the sensor in the center of the food.
- Plug the temperature probe into the socket on the side of the oven wall.
- Cover the food if desired.
- Set the temperature of the desired doneness. (See chart below.)
- Select “multi-power” setting as shown below.
- The microwave oven will stop cooking when the set temperature is reached and then it will be “Hold Warm”.
- Remove the temperature probe from the oven after use.

“TEMPERATURE CONTROLLED” REHEATING GUIDE

FOOD	SETTING	DONENESS	INSTRUCTIONS
Beverages	HI (MAX POWER)	150°F	Place the temperature probe sensor in the center of the beverage glass.
Soups	80 (REHEAT)	150°F	Place the temperature probe sensor into the center of the soup. Cover with casserole lid, waxed paper, or plastic wrap.
Precooked Casseroles	80 (REHEAT)	150°F	Place the temperature probe sensor into the center of the food. Cover with a casserole lid, waxed paper, or plastic wrap.
Canned Vegetables	80 (REHEAT)	150°F	Place the temperature probe sensor into the center of the food to be reheated. The sensitive area of the sensor should rest in the middle of the food.
Leftovers	80 (REHEAT)	150°F	Place the temperature probe sensor in the densest or largest amount of food.
Meat Sandwiches (Thick)	80 (REHEAT)	120°F	Place the temperature probe sensor into the thickest part of the sandwich to be warmed. The sensitive area of the sensor should be located in the sandwich filling.
Baked Foods	80 (REHEAT)	120°F	Place the temperature probe sensor into the center of the food to be reheated. The sensitive area of the sensor should rest in the middle of the food.
Syrup	70 (ROAST)	150°F	Place the temperature probe sensor into the center of the container.

CAUTION: From time to time, the same kind of foods may vary in shape, form and density, and, therefore will not produce the same results each time. For this reason, we do not recommend using the temperature controlled settings for thin food

items or for foods that require tenderizing by simmering. Also, in some cases the microwave oven may shut off prematurely. This means that either the temperature probe is not placed properly or that it should not be used with this type of food.

TEMPERATURE CONTROLLED "HI-POWER"/"MULTI-POWER" COOKING AND AUTOMATIC "HOLD WARM"

The "Temperature Controlled Meat Cooking Guide" and "Reheating Guide" on Pages 17 and 18 will show you which multi-power setting and temperature setting are recommended for the food you are cooking. When cooking with the temperature control settings, the timer is not used.

- Place the temperature probe into the food with the first inch of the sensor in the center of the food. The probe should be in a level direction or on an angle as shown. *It should NOT be put in from the top.*

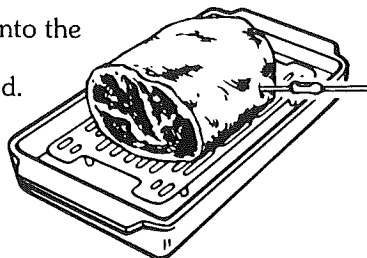

When you touch "7" and "0" the display window will show "70". This means that in the "70 (ROAST)" setting, the oven is at power level 70.

NOTE: You do not need to touch MICRO POWER when you are cooking with HI (max power). To set "HI-POWER" Cooking, skip steps 6 and 7 above. However, if MICRO POWER is touched, the light above MICRO will go on and the word "HI" will show in the display window. This is to tell you that the oven will work at HI (highest microwave power) unless a different power setting is chosen.

- Plug the temperature probe into the socket on the side of the oven. **CAUTION:** Do not plug the pointed end of the temperature probe into the socket.

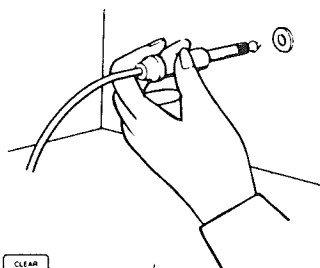

- Touch CLEAR.

CLEAR

- Touch MICRO TEMP. The lights above TEMP and MICRO, below COOK 1 will go on, and "F" will show in the display window.

MICRO TEMP

- Choose the food temperature and touch the corresponding numbers. For example, if the recipe calls for doneness at 165°F, you would touch numbers "1" "6" and "5". When you touch "165", the display window will show "165F". If the temperature probe is not plugged into the socket, the word "Prob" will flash and the oven will not work.

1 6 5

- Touch MICRO POWER. The word "HI" will show in the display window until you enter a lower power setting. This is to remind you that the oven will always operate at full power unless you set a lower power.

MICRO POWER

- Choose the power control setting you desire and touch the corresponding numbers. For example, if the recipe should call for cooking at the "70 (ROAST)" setting, you would touch numbers "7" and "0".

7 0

- Touch START. The oven will begin to cook and you will be able to see the temperature of the food rising in the display window.

START

- A tone will sound for one second when the temperature is reached. The oven will switch into "Hold Warm" to keep the food warm. The micro control setting automatically changes to "power level 1". The display window will show "Hold".

- To be sure the correct temperature is being held, you may touch MICRO TEMP. The "holding" temperature will show in the display window. The "Hold Warm" will continue for 60 minutes after the food reaches the chosen temperature or until the door has been opened or until STOP has been touched. If the door has been opened, the "Hold Warm" will stop. To reset, simply touch MICRO TEMP, the corresponding numbers and START.

NOTE: The highest temperature that can be set is 185°F.

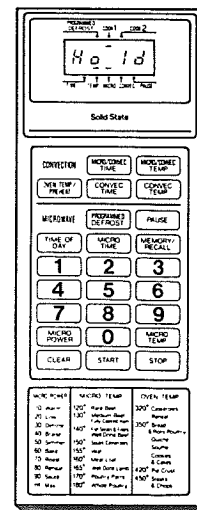
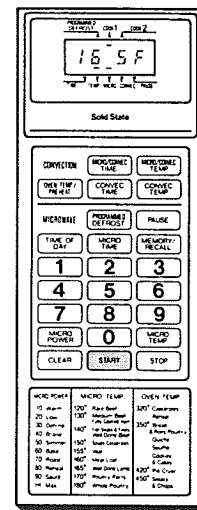
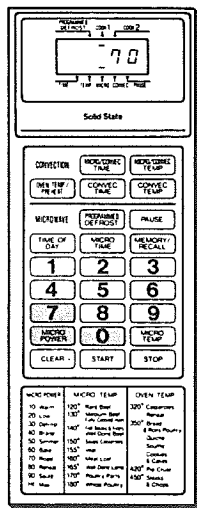
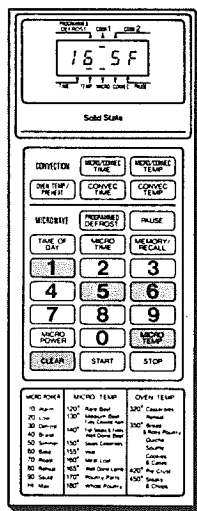

PROGRAMMED DEFROST

The power levels for defrosting are predetermined and programmed into this oven. The oven will defrost at "HI" power for the beginning of the chosen time and at power level 30 for the remaining period of time.

1. Touch CLEAR.
2. Touch PROGRAMMED DEFROST.
Lights above MICRO and below PROGRAMMED DEFROST will go on and "0" will show in the display window.
3. Set Defrosting Time by following the Programmed Defrost Chart on pages 21 through 24.
4. Touch START.

NOTE: If you plan to use additional cooking stages immediately following Programmed Defrost cycles, you must allow for standing time as recommended on the Programmed Defrosting Charts on Pages 21 through 24.

This can be accomplished as follows:

1. Touch PROGRAMMED DEFROST and enter the defrosting time.
2. Touch MEMORY/RECALL.
3. Touch MICRO TIME.
4. Enter standing time per charts (Pages 21 thru 24).
5. Touch MICRO POWER.
6. Enter "0".
7. Touch MEMORY/RECALL.
8. Set the next cooking stage per cookbook or USE AND CARE MANUAL.

The cooking process can be set for up to three stages when Programmed Defrost in one of the stages.

EXAMPLE: To defrost two pounds of ground beef, use the PROGRAMMED DEFROST cycle for 9 minutes, and the standing time of 5 minutes.

1. Touch CLEAR.
2. Touch PROGRAMMED DEFROST.
The lights above MICRO and below PROGRAMMED DEFROST will go on. The display window will read "0".
3. Set 9 minutes by touching "9", then "0" twice. "900" will show in the display window.

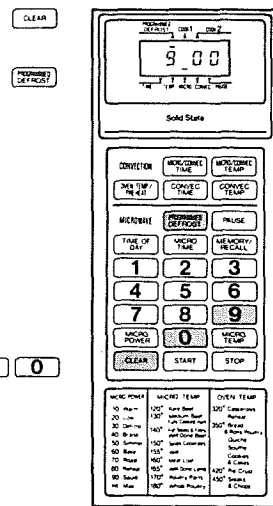

9 0 0

4. Touch MEMORY/RECALL.
The light below COOK 1 will go on. The display window will read "0".
5. Touch MICRO TIME.
The lights above TIME and MICRO will go on.
6. Enter standing time by touching "5" then "0" twice. "500" will show in the display window.

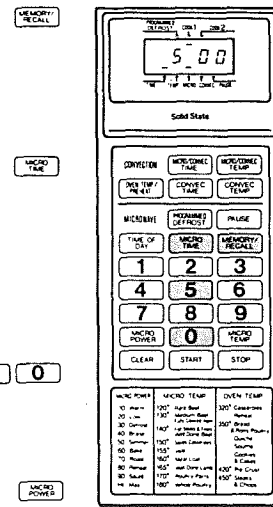

5 0 0

7. Touch MICRO POWER.
The display window will show "HI".
8. Touch "0" (power level 0).

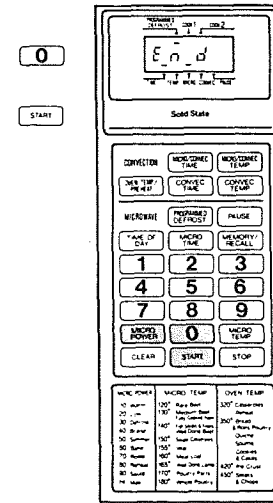

0

9. Touch START. The oven will begin to operate and time will begin to count down in the display window. When the 9 minutes are up, a tone will sound and the oven change into the second stage as standing time at power level 0. When the 5 minutes are up, a tone will sound and the word "End" will show in the display window for two seconds when time is over and the oven will shut itself off.

PROGRAMMED DEFROSTING CHART

The defrosting times in this chart have been made available specifically for use with the "Programmed Defrost" feature.

PROGRAMMED DEFROSTING INSTRUCTIONS:

- For best results, remove fish/seafood/meat/poultry from its original paper or plastic closed package (wrapper). Otherwise, the wrap will hold steam and juice close to the foods which can cause the outer surface of the foods to cook.
- When it is difficult to remove the wrap from the foods, defrost the wrapped food for about a quarter of the total defrost time, which is displayed at beginning of the defrost cycle. Remove the wrap from foods.
- Metal clip and pop-up timers may be left in poultry. Metal twistors must be removed from bags. They may be replaced with rubber bands.
- Place food in a flat glass baking dish to catch drippings.
- Use the "Programmed Defrost" setting to thaw fish, seafood, meat and poultry, according to the times in the chart below. Thaw completely before cooking.
- Food should still be somewhat icy in the center when removed from the oven.
- The chart gives you standing times and standing techniques needed to complete the thawing process.

IMPORTANT NOTE: The defrosting power setting (power level 30) should not be confused with this "Programmed Defrost." The defrost cooking level is a low-energy setting used to cook foods that need slow, gentle cooking. Use the defrost cooking level to reheat many frozen convenience foods and also to defrost small bread items.

CUT AND WEIGHT	PROGRAMMED DEFROSTING TIME	STANDING TIME	DIRECTIONS
FISH AND SEAFOOD			
FISH Fish fillets 1 lb. 2 lbs.	4 to 5 min. 5 to 6 min.	5 min. 5 min.	Defrost in package on dish. Turn over once.* After defrosting, carefully separate fillets under cold water.
Fish steaks 1 lb.	4 to 5 min.	5 min.	Defrost in package on dish. After defrosting, carefully separate steaks under cold running water.
Whole Fish 8 to 10 oz. 1-1/2 lb. to 2 lbs.	3 to 5 min. 4 to 6 min.	5 min. 5 min.	Use a shallow dish; the shape of the fish determines size. Cover the head with aluminum foil. Turn over once.* The fish should be icy when removed from oven. Finish thawing while standing at room temperature.
Lobster tails 8 oz. pkg.	4 to 6 min.	5 min.	Remove from package to baking dish.
Crab legs 8 to 10 oz.	4 to 6 min.	5 min.	Use a glass baking dish. Break the legs apart and turn over once.*
Crabmeat 6 oz.	3 to 4 min.	5 min.	Defrost in package on dish. Break apart and turn over once.*

*Turning or stirring should be done in the middle of the defrosting cycle.

PROGRAMMED DEFROSTING CHART (Cont'd)

CUT AND WEIGHT	PROGRAMMED DEFROSTING TIME	STANDING TIME	DIRECTIONS
Shrimp 1 lb.	2 to 3 min.	5 min.	Remove from package to dish. Spread loosely in baking dish and rearrange during thawing as necessary.
Scallops 1 lb.	7 to 9 min.	5 min.	Defrost in package, if in block; spread out on baking dish if in pieces. Turn over and rearrange during thawing as necessary.
Oysters 12 oz.	2 to 3 min.	5 min.	Remove from package to dish. Turn over and rearrange during thawing as necessary.
MEAT			
BEEF			
Ground beef 1 lb. 2 lbs.	4 to 4-1/2 min. 8 to 9 min.	5 min. 5 min.	Turn over once.* Remove thawed portions with fork. Return remainder into oven to defrost. (The best way to freeze ground beef is in a doughnut shape.)
Pot roast, chuck Under 4 lbs.	3 to 4 min. per lb.	10 min.	Turn over once.*
Rib roast, rolled 3 to 4 lbs.	5 to 7 min. per lb.	30-45 min.	Turn over once.*
Rump roast 3 to 4 lbs.	3 to 4 min. per lb.	30 min.	Turn over once.*
Round steak	3 to 4 min. per lb.	5-10 min.	Turn over once.*
Flank steak	3 to 4 min. per lb.	5-10 min.	Turn over once.*
Sirloin steak 1/2 inch thick	3 to 4 min. per lb.	5-10 min.	Turn over once.*
Tenderloin steak.	4 to 5 min. per lb.	10 min.	Turn over once.*
Stew beef 2 lbs.	3 to 4 min. per lb.	8-10 min.	Turn over once.* Separate.
LAMB			
Cubed for stew	6 to 7 min. per lb.	5 min.	Turn over once.* Separate.
Ground lamb Under 4 lbs.	3 to 4 min. per lb.	30-45 min.	Turn over once.*
Chops 1 inch thick	4 to 6 min. per lb.	15 min.	Turn over twice.*
Leg 5 to 8 lbs.	3 to 4 min. per lb.	15-20 min.	Turn over twice.*

* Turning or stirring should be done in the middle of the defrosting cycle.

PROGRAMMED DEFROSTING CHART (Cont'd)

CUT AND WEIGHT	PROGRAMMED DEFROSTING TIME	STANDING TIME	DIRECTIONS
MEAT			
PORK			
Chops 1/2 inch thick 1 inch thick	4 to 5 min. per lb. 5 to 6 min. per lb.	5-10 min. 10 min.	Separate chops halfway through defrosting time.
Spareribs, Country-style ribs 2 to 3 lbs.	4 to 6 min. per lb.	10 min.	Turn over once.*
Roast Under 4 lbs.	3 to 4 min. per lb.	30-45 min.	Turn over once.*
Bacon 1 lb.	1-1/2 to 2-1/2 min.	3-5 min.	Defrost until strips separate.
Sausage, bulk 1 lb.	1-1/2 to 2-1/2 min.	3-5 min.	Turn over once.* Remove thawed portions with fork. Return remainder into oven to defrost.
Sausage, links 1 lb.	2 to 4 min.	4-6 min.	Turn over once.* Defrost until pieces can be separated.
Hot dogs 1 lb.	4 to 5 min.	5 min.	
VEAL			
Roast 3 to 4 lbs.	4 to 6 min. per lb.	30 min.	Turn over once.*
Chops 1/2 inch thick.	3 to 5 min. per lb.	20 min.	Turn over once.* Separate chops and continue defrosting.
VARIETY MEAT			
Liver 1 lb.	4 to 5 min.	10 min.	Turn over once.*
Tongue 1 lb.	6 to 7 min.	10 min.	Turn over once.*

*Turning or stirring should be done in the middle of the defrosting cycle.

PROGRAMMED DEFROSTING CHART (Cont'd)

CUT AND WEIGHT	PROGRAMMED DEFROSTING TIME	STANDING TIME	DIRECTIONS
POULTRY			
Chicken Whole 2 to 3 lbs. Cut up 2 to 3 lbs.	5 to 7 min. per lb. 4 to 5 min. per lb.	25-30 min. 10-15 min.	Turn over once.* Immerse in cold water for standing time. Turn over once.* Separate pieces when partially thawed.
TURKEY			
Whole Under 8 lbs. Breast Under 4 lbs. Drumsticks 1 to 1-1/2 lbs. Roast, boneless 2 to 4 lbs.	3 to 4 min. per lb. 3 to 4 min. per lb. 4 to 5 min. per lb. 2-1/2 to 3 min. per lb.	60 min. 20 min. 15-20 min. 10 min.	Turn over once.* Immerse in cold water for standing time. Turn over once.* Turn over once.* Separate pieces when partially thawed. Remove from foil pan. Cover with waxed paper before defrosting.
CORNISH HENS			
Whole 1. 1 to 1-1/2 lbs. 2. 1 to 1-1/2 lbs. ea.	10 to 11 min. per lb. 9 to 10 min. per lb.	20 min. 20 min.	Turn over once.* Turn over once.*

*Turning or stirring should be done in the middle of the defrosting cycle.

MULTI-STAGE COOKING

Multi-Stage cooking allows you to set the oven to cook in one stage at a certain power level for a chosen time or temperature and then in a second stage at a different power level for a chosen time or temperature. The cooking process can be set for three memory stages when Programmed Defrost is included as the first stage. The stages are set before cooking and will sequence automatically when oven is started.

1. Touch CLEAR.
2. Touch MICRO TIME or MICRO TEMP. The lights above TIME or TEMP and MICRO, below COOK 1 will go on. The display window will show "0" or "F".
3. Touch the correct numbers for the time or temperature of the first cooking stage.
4. Touch MICRO POWER. The lights above MICRO and below COOK 1 will go on. The display window will show "HI".
5. Touch the correct numbers for the cooking power level of the first cooking stage (if other than "HI").
6. Touch MEMORY/RECALL or PAUSE. The light below COOK 2 will go on. The display window will show "0".
7. Touch MICRO TIME or MICRO TEMP.
8. Touch the correct numbers for the time or temperature of the second cooking stage.
9. Touch MICRO POWER. The display window will show "HI".
10. Touch the correct numbers for the cooking power level in the second cooking stage (if other than "HI").
11. Touch START.

MULTI-STAGE COOKING WITH PROGRAMMED DEFROST

If you want to cook after using the Programmed Defrost, before setting the above multi-stage cooking, set the Programmed Defrost and touch MEMORY/RECALL, then follow the above instructions numbered 2~11. See Pages 20 through 24 for the detailed instructions of Programmed Defrost. The cooking process can be set up to three stages when PROGRAMMED DEFROST is one of the stages.

• To pause between stages

To set the oven to stop between stages, touch PAUSE when setting the oven. See Page 13 for more detailed directions.

NOTE: If you touch MEMORY/RECALL instead of PAUSE, the oven will not stop but will remember the next stage and continue working.

EXAMPLE: In preparing a cake mix, the cookbook calls for a first stage of 7 minutes at the "50 (SIMMER)" power level followed by a second stage of 3 minutes at "HI". The following steps explain how to set the oven:

First Stage (7 minutes: power level 50 SIMMER)

1. Touch CLEAR.
2. Touch MICRO TIME.
3. Set 7 minutes by touching "7," "0" and "0." "700" will show in the display window.

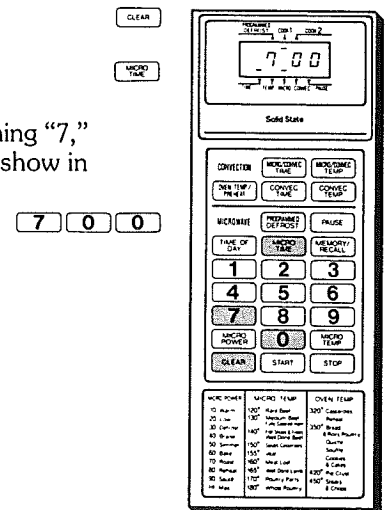

4. Touch MICRO POWER. "HI" will show in the display window to remind you that the oven will operate at highest power unless you enter a lower power setting.
5. Touch numbers "5" and "0." "50" will show in the display window (indicating that you have set the oven to operate at power level 50). The first stage has been set.

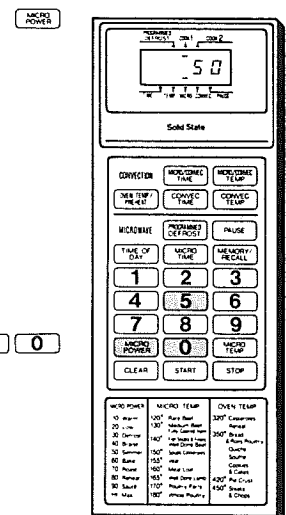

MULTI-STAGE COOKING (Cont'd)

Second Stage (3 minutes: "HI")

6. Touch MEMORY/RECALL. The light below COOK 2 will go on. The display window will show "0".

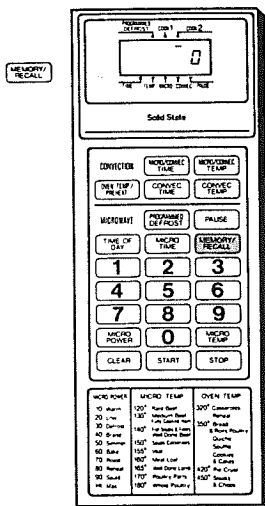

7. Touch MICRO TIME.

8. Set 3 minutes by touching "3," "0" and "0." "300" will show in the display window. (Power is on "HI".)

3 0 0

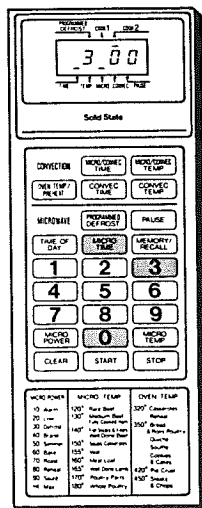

9. Touch START. The first stage will begin. "700" will show in the display window. The oven will begin to cook at "50 (SIMMER)" and the time will begin to count down in the display window. When the 7 minutes are over, a tone will sound and the oven will change itself into the second stage. The oven will begin to cook at "HI". When the 3 minutes are over, a tone will sound and the word "End" will show in the display window and the oven will shut itself off. The oven will have finished both stages.

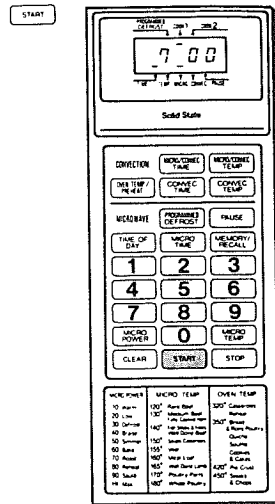

NOTE: When temperature controlled cooking is set in the second stage, the oven will switch into "Hold Warm" after cooking. The "Hold Warm" will continue for 60 minutes after the food reaches the chosen temperature or until the door has been opened or until STOP has been touched.

* The above directions show Microwave Cooking only. It is also possible to set a combination of Microwave and Convection Cooking in Multi-Stage Cooking.

DELAY START COOKING

Delayed cooking can be done by using the MULTI-STAGE COOKING feature. After counting down the preset delay time, the oven will cook for the chosen cooking time.

1. Touch CLEAR.
2. Touch MICRO TIME.
3. Touch the correct numbers for the desired delay time.
4. Touch MICRO POWER.
5. Touch "0" (power level 0).

6. Touch MEMORY/RECALL.
7. Touch MICRO TIME or MICRO TEMP.
8. Touch the correct numbers for the desired cooking time or food temperature.
9. Touch MICRO POWER.
10. Touch the correct numbers for the desired cooking power level.
11. Touch START.

NOTE: A preset delay time must be less than 99 minutes.

* The above directions show Microwave Cooking only. Also Convection and Micro/Convec Cooking can be set in Delay Start Cooking.

CONVECTION COOKING

The convection cooking will be best used for items like souffles, breads, angel food cakes, pizza, and for broiling meat and fish.

No special techniques are required to adapt your favorite oven recipes to convection cooking, although you may need to use lower temperatures by 25°F~35°F than in a conventional oven.

Because the convection cooking method is identical to a conventional oven except for increased efficiency of fan-circulated hot air.

When baking cakes, cookies, breads, rolls or other baked foods, some recipes occasionally call for preheating. Preheat the empty oven just as you do in the conventional oven. But heavier dense foods such as meats, casseroles, poultry can be started without preheating.

All heatproof cookware or metal utensils may be used in convection cooking.

CERAMIC TRAY

The ceramic tray should be removed from oven prior to convection cooking. This is because, both the upper and lower heaters are in operation for convection cooking and the ceramic tray prevents the efficient heating of the lower heater. Remove the ceramic tray for the best results.

METAL RACK

The metal rack has three positions; upper, lower and oven bottom. As conventional cooking, the distance of the food from heat sources (upper/lower heater) affects cooking results. Always consider the cooking method and desired results when deciding which cooking position to use.

There is no standard rule for rack position for every food type, therefore, please refer to the food charts in each chapter of your cookbook. Also, finding a similar recipe in the cookbook index and referring to the recipe's suggested position will be helpful.

Cooking Position	Recipe
Upper	Steak, Hamburger Patty, Pork Chops, Chicken Pieces
Lower	Beef Roast, Leg of Lamb, Whole Chicken, Cookies, Brownies, Biscuits
Oven Bottom	Pie Crust, Angel Food Cake, Apple Pie, Souffle

To change Metal Rack from upper to lower position, simply turn it over. For bottom position, metal rack rests directly on the oven floor.

The ceramic tray must always be removed for convection cooking.

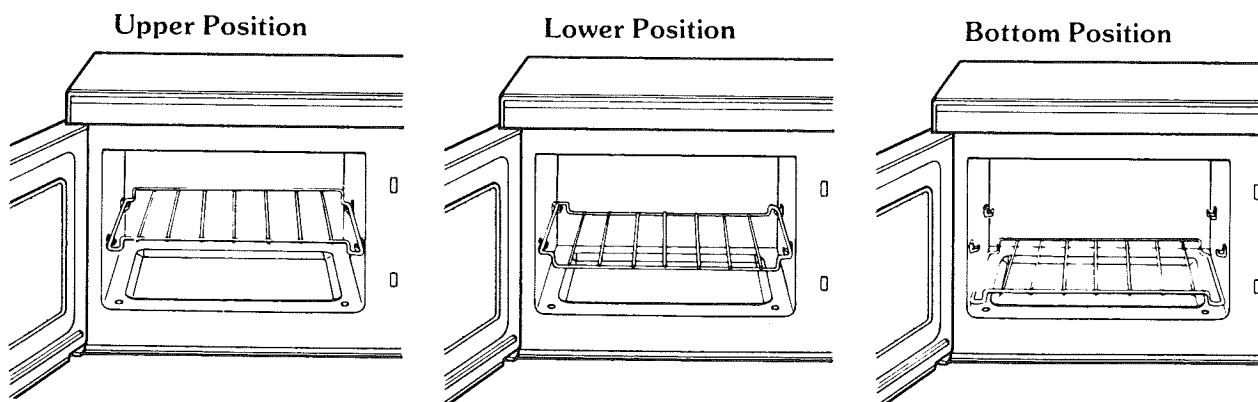

NOTE: The ceramic tray must always be in the oven for microwave or micro/convec cooking.

BAKING PAN/METAL UTENSILS

Any Baking Pan less than 12" × 12" can be used with this oven. The Baking Pan and metal utensils, should be placed on the Metal Rack.

The Baking Pan and metal utensils should only be used for convection cooking. Never use for microwave or micro/convec cooking since arcing may happen and damage to the oven may result.

CONVECTION COOKING WITH AUTOMATIC PREHEAT

The cookbook tells you which oven preheating temperature setting and convection cooking time setting are recommended for food you are cooking. The oven preheating temperature of 350°F for preheating the oven has been factory set into the oven.

1. Remove ceramic tray from oven. Set the metal rack in the desired cooking position; upper, lower or bottom.

2. Touch CLEAR then touch OVEN TEMP/PREHEAT. The light below COOK 1 will go on and "F" shows in the display window.

3. If you do not touch the numbers for the oven temperature, the oven starts preheating to the 350°F when the START is touched.

If you want to preheat the oven to the temperature other than the 350°F, touch the desired numbers, or example, to preheat the oven to 400°F, touch 4, 0 and 0. The "400F" will show in the display window.

*4. Touch PAUSE. Light below COOK 2 will go on and "0" shows in the display window.

5. Touch CONVEC TIME. Lights above TIME and CONVEC will go on and "0" shows in the display window.

6. Set the convection cooking time by touching the corresponding numbers as instructed in the Cookbook.

For example, set 45 minutes by touching the numbers for "4", "5", "0" and "0". "4500" then shows in the display window.

NOTE: During convection cooking, the oven keeps the same temperature in second stage as for preheating.

7. Touch START.

The oven is working when the oven light is on. Lights below COOK 1, above PAUSE and CONVEC will go on, and "200F" is shown in the display window.

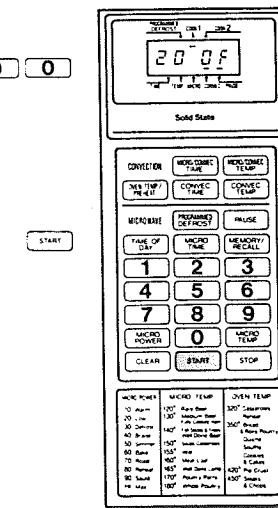
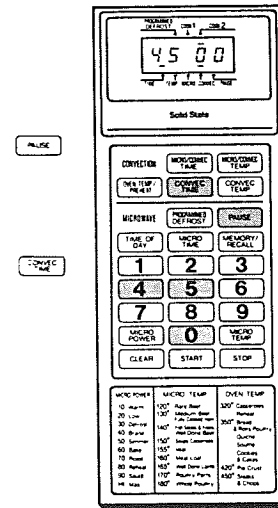
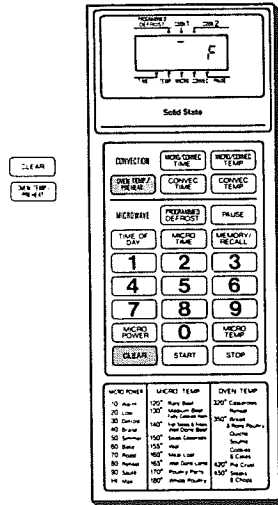

As the oven temperature rises above 200°F, the display temperature increases in 10°F (210F, 220F, 230F etc.). When the temperature in the oven reaches the preheat temperature, "350F" or the set temperature is displayed and a pulsating beep tone will sound to tell that the preheating is over.

8. **WARNING:** The temperature in the oven is quite high. Never touch the tray or flatware with bare hands. Open the door, the beep sound will stop and the temperature display will change to the time display for second stage. Place the food inside the oven as quickly as possible. While the door is open, the warmed air will escape from the oven and the oven temperature will drop.

9. Touch START again. The oven restarts, the oven light and the lights below COOK 2, above TIME and CONVEC are on. The time in the display window counts down.

A tone will sound and the word "End" will show in the display window for 2 seconds when the 45 minutes are over. Then the oven will shut itself off.

NOTE: To know the temperature of the oven during cooking, touch OVEN TEMP/PREHEAT to get "350F" or the other set temperature in the display window.

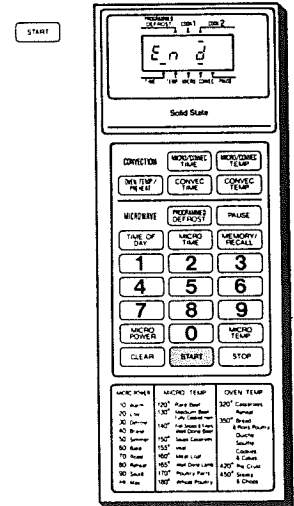

After preheating is over, the beep tone will last until either the door is opened or 30 minutes have elapsed.

The oven temperature should be chosen in ten-degree increments. For example, if a temperature of 325°F is programmed, the oven will stop at the temperature of 320°F, omitting the last digit 5°.

Avoid opening the door during the cooking often since the hot air will escape from the oven and the oven temperature drops very quickly, adversely affecting the cooking results.

* Use Pot holders to remove the Metal Rack after cooking as the Rack may get hot during cooking.

TEMPERATURE CONTROLLED COOKING GUIDE FOR CONVECTION COOKING

FOOD	OVEN TEMP	FIRST STAGE	SECOND STAGE		SPECIAL NOTES
		TIME	TIME	or PROBE TEMP	
BEEF Ground beef patties, 1—4, 4 oz, each	450°F	Rare: 7 min. Med: 8 min. Well: 9 min.	3 min. 4 min. 5 min.		Remove ceramic tray. Upper position. Preheat. Use broiling pan or aluminum tray.
Tenderloin roast, 2—3 lbs.	450°F	5 min. per lb. Turn over	5—10 min. per lb.	Rare: 120°F Med: 130°F Well: 140°F	Remove ceramic tray. Upper position. Preheat. In heatproof shallow baking dish. Let stand 5 min.
Rib eye or strip steak 1 in. thick	450°F	Rare: 4 min. Med: 5 min. Well: 6 min. Turn over	3—6 min. 4—7 min. 5—8 min.		Remove ceramic tray. Upper position. Preheat. Metal pan or foil tray.
LAMB Lamb chops, 3/4" thick	450°F	Rare: 4 min. Med: 5 min. Well: 7 min. Turn over	3—4 min. 4—5 min. 4—5 min.		Remove ceramic tray. Upper position. Preheat. Metal pan or foil tray.
VEAL Veal chops 1/2 in. thick	450°F	4 min. Turn over	3—4 min.		Remove ceramic tray. Upper position. Preheat. Metal pan or foil tray.
PORK Pork chops 1/2—3/4 in. thick	450°F	Med: 7 min. Well: 9 min. Turn over	4—6 min. 5—7 min.		Remove ceramic tray. Upper position. Preheat. Metal pan or foil tray.
BAKERY Angel food cake	350°F	50 min.			Remove ceramic tray. Oven bottom position. 10 inch metal tube pan. Let cake cool completely before removing from pan.
Refrigerated crescent, Butterflake rolls 8 oz.	380°F	10—13 min.			Remove ceramic tray. Oven bottom position. Preheat. Cookie sheet or foil tray.

TEMPERATURE PROBE CONVECTION COOKING

Before starting Temperature Probe Convection Cooking, choose the correct temperature by consulting with the "Temperature Controlled Cooking Guide" on page 29 in this manual or in the Cookbook.

The following directions show "One-Stage Cooking" only.

1. Remove ceramic tray. Set the metal rack in the desired positions; upper, lower or bottom, then place food on the metal rack. Before placing the food into the oven, put in the Temperature Probe in food, with the first inch of the Sensor in center of food. Probe should be in a level direction or an angle as shown.

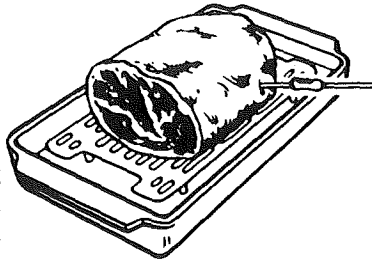

2. Plug Temperature Probe into socket on side of oven.

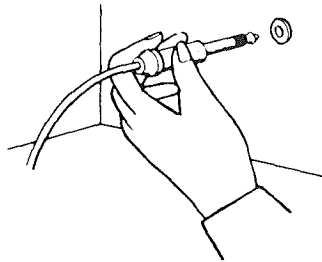

CAUTION: Do not plug the Pointed End of the Temperature Probe into the socket.

3. Touch CLEAR.
4. Touch OVEN TEMP/PREHEAT.

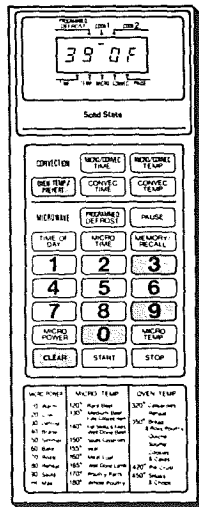

The light below COOK 1 will go on and "F" shows in the display window.

5. Set the oven temperature by touching the corresponding numbers. For example 390° is set by touching the numbers for "3", "9" and "0", "390F" then shows in the display window.

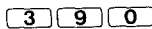

6. Touch CONVEC TEMP. Lights below COOK 1, above TEMP and CONVEC will go on and "F" shows in the display window.

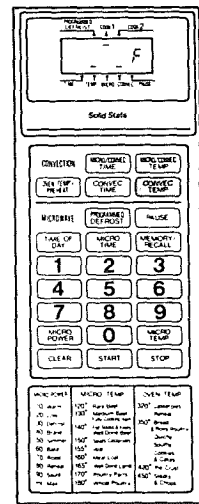

NOTES: The CONVEC TEMP means that the cooking is done by measuring and controlling the food temperature with the Temperature Probe.

The OVEN TEMP means that the cooking is done by measuring and controlling the oven temperature.

7. Set the desired food temperature for Temperature Probe by touching the corresponding numbers.

For instance, if 185°F is desired touch the numbers "1", "8" and "5".

"185F" then shows in the display window.

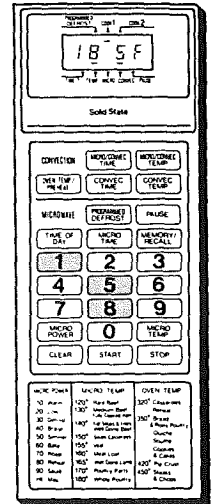
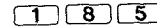

8. Touch START.



The oven is working when the oven light is on, and the lights below COOK 1, above TEMP and CONVEC will go on. The temperature of the food will be shown in the display window. When the temperature of the food reaches 185°F while the oven temperature is programmed for 390°F, a tone will sound and the word "End" will show in the display window for 2 seconds and the cooking is over.

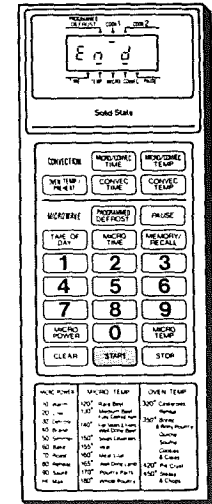

NOTES: See the explanation of "Temperature Controlled Cooking Guide" on page 29.

The oven temperature of 350°F is memorized in the oven.

This means that if the desired oven temperature is 350°F, you need not touch OVEN TEMP/PREHEAT or the numbers. Skip steps 4 and 5.

Avoid opening the door during the cooking often since the hot air will escape from the oven and the oven temperature drops very quickly, adversely affecting the cooking results.

*"Preheating" can be set as the directions on page 28. Follow the instructions numbered 1—4 on page 28, then follow the instructions beginning with step 4 in this page. During pause after preheating, place food and plug temperature probe as shown steps 1 and 2 above, and then touch START again.

*Use Pot holders to remove the Metal Rack after cooking as the Rack may get hot during cooking.

MICRO/CONVEC COOKING

Cooking is done by both microwave and hot air. Micro/Convec cooking is fast and efficient. The following directions show "One-Stage Cooking" only.

1. Touch CLEAR.

CLEAR

2. Touch OVEN TEMP/PREHEAT.

OVEN TEMP/PREHEAT

The light below COOK 1 will go on and "F" shows in the display window.

3. Set the desired oven temperature by touching the corresponding numbers. For example, 400°F is set by touching the numbers "4", "0" and "0". "400F" will then show in the display window.

4 0 0

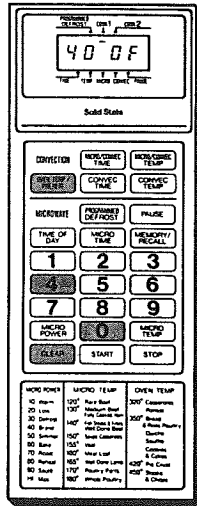

4. Touch MICRO/CONVECT TIME.

MICRO/CONVECT TIME

Lights below COOK 1, above TIME and MICRO and CONVEC will go on, and "0" shows in the display window.

5. Set the desired cooking time by touching the corresponding numbers. For example, to set 16 minutes and 30 seconds, touch numbers "1", "6", "3" and "0". "1630" then shows in the display window.

1 6 3 0

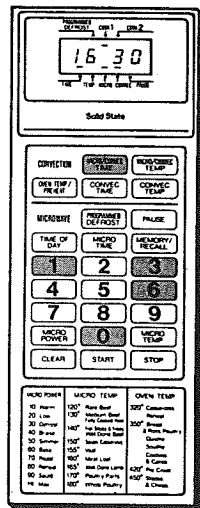

6. Touch START.

START

The oven is working when the oven light is on and the time in the display window begins counting down. When the figure in the display window counts down to "0" while the oven temperature is programmed for 400°F a tone will sound and the word "End" will show in the display window for 2 seconds and the cooking is over.

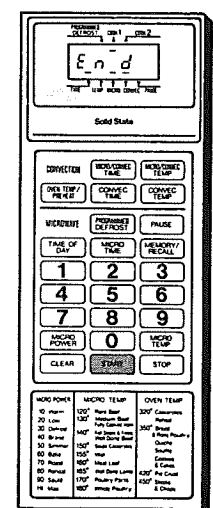

NOTES: The oven temperature of 350°F is memorized in the oven. This means that if the desired oven temperature is 350°F, you need not touch OVEN TEMP/PREHEAT or the numbers. Skip steps 4 and 5.

Avoid opening the door during the cooking often since the hot air will escape from the oven and the oven temperature drops very quickly, adversely affecting the cooking results.

*"Preheating" can be set as the directions on page 28. Follow the instructions numbered 1—4 on page 28, then follow the instructions beginning with step 2 in this page. During pause after preheating, place food in the oven, and then touch START again.

*Use Pot holders to remove the Metal Rack after cooking as the Rack may get hot during cooking.

*Ceramic tray should always be in the oven for micro/convec cooking.

TEMPERATURE CONTROLLED COOKING GUIDE FOR MICRO/CONVEC COOKING

FOOD	OVEN TEMP	FIRST STAGE	SECOND STAGE		SPECIAL NOTES	
		TIME	TIME	or PROBE TEMP		
BEEF Meat Loaf 1-1/2—1-3/4 lbs.	400° F		35 min.		160° F	Preheat. Let stand 5—10 min.
Beef rib roast, boneless	330° F	5 min. per lb. Turn over	6 min. per lb.		Rare: 120° F Med: 130° F	Lower position. In microproof and heatproof dish with trivet.
Beef rib roast, bone in. 5 lbs.	350° F	7 min. per lb. Fat side down Turn over	8 min. per lb.		Rare: 120° F Med: 130° F Well: 140° F	Lower position. In microproof and heatproof dish.
Beef pot roast, boneless, 3 lbs.	330° F	7 min. per lb. Turn over	8—10 min. per lb.		Med: 130° F Well: 140° F	Lower position. Covered microproof and heatproof casserole or cooking bag.
LAMB Lamp leg or shoulder roast, bone in. 6-1/2 lbs.	330° F	4 min. per lb. Fat side down Turn over	5—7 min. per lb.		Rare: 145° F Med: 155° F Well: 165° F	Lower position. In microproof and heatproof dish with trivet.
Lamb roast, boneless, 3—4 lbs.	330° F	5 min. per lb. Fat side down Turn over	4—6 min. per lb.		150° F	Lower position. In microproof and heatproof dish with trivet.
VEAL Shoulder or rump roast, boneless, 3—3-1/2 lbs.	330° F	4—5 min. per lb. Turn over	4—6 min. per lb.		155° F	Lower position. In microproof and heatproof dish with trivet.
PORK Pork loin roast, boneless, 4—5 lbs.	320° F	5—7 min per lb. Turn over	6—8 min. per lb.		165° F	Lower position. Microproof and heatproof baking dish.
Pork loin, center cut, 4—5 lbs.	320° F	5—7 min per lb. Turn over	6—8 min. per lb.		165° F	Lower position. Microproof and heatproof baking dish.

TEMPERATURE PROBE MICRO/CONVEC COOKING

Consult the "Temperature Controlled Cooking Guide" on page 32 before you start Temperature Probe Micro/Convec Cooking. The following directions show "One-Stage Cooking" only.

- Put in the Temperature Probe in food, with the first inch of the Sensor in center of food. Probe should be in a level direction or on an angle as shown.

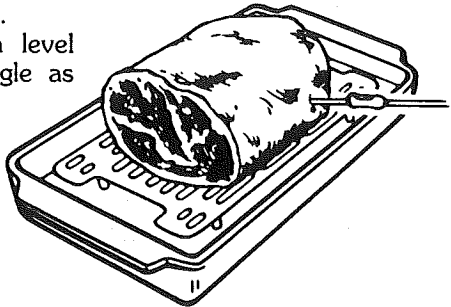

- Plug Temperature Probe into socket on side of oven.

CAUTION: Do not plug the Pointed End of the Temperature Probe into the socket.

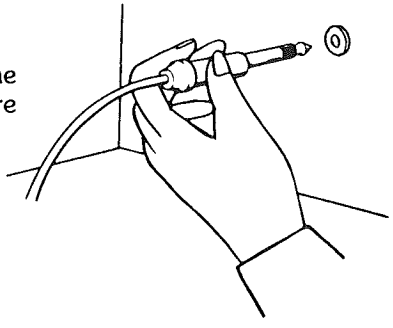

- Touch CLEAR.
- Touch OVEN TEMP/PREHEAT. The light below COOK 1 will go on and "F" shows in the display window.
- Set the oven temperature by touching the corresponding numbers. For example, set 390°F by touching numbers "3", "9" and "0". "390F" then shows in the display window.

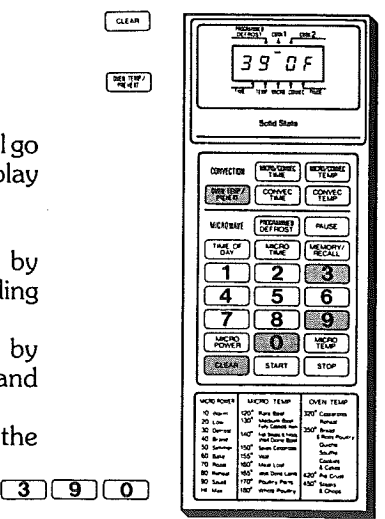

- Touch MICRO/CONVEC TEMP.

Lights below COOK 1, above TEMP and MICRO and CONVEC will go on and "F" shows in the display window.

MICRO/CONVEC TEMP

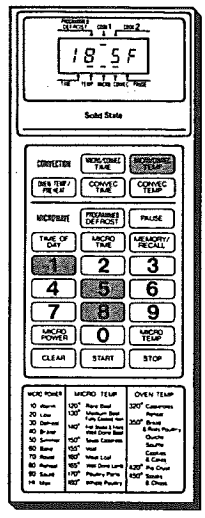

- Set the desired food temperature for Temperature Probe by touching the corresponding numbers. If 185°F is desired, for example, touch numbers "1", "8" and "5". "185F" then shows in the display window.

1 8 5

- Touch START.

The oven is working when the oven light is on. Lights below COOK 1, above TEMP and MICRO and CONVEC will go on and the food temperature is shown in the display window. When the temperature of the food reaches 185°F while the oven temperature is programmed for 390°F, a tone will sound and the word "End" will show in the display window for 2 seconds and the cooking is over.

START

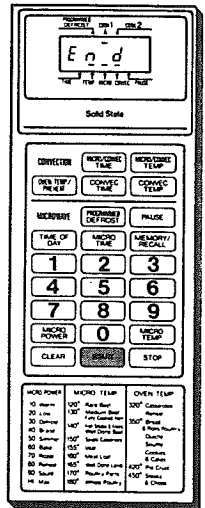

NOTES: The oven temperature of 350°F is memorized in the oven. This means that if the desired oven temperature is 350°F, you need not touch OVEN TEMP/PREHEAT or the numbers. Skip steps 4 and 5.

Avoid opening the door during the cooking often since the hot air will escape from the oven and the oven temperature drops very quickly, adversely affecting the cooking results.

*"Preheating" can be set as the directions on page 28. Follow the instructions numbered 1-4 on page 28, then follow the instructions beginning with step 4 in this page. During pause after preheating, place food and plug temperature probe as shown steps 1 and 2 above, and then touch START again.

*Use Pot holders to remove the Metal Rack after cooking as the Rack may get hot during cooking.

*Ceramic tray should always be in the oven for micro/convec cooking.

OVEN UTENSILS GUIDE

A variety of Utensils and Materials may be used for cooking in your microwave/convection oven. For your safety and to prevent damaging utensils and your oven, choose appropriate utensils and materials for each cooking method. The list below is a general guide for you to select utensils and materials.

Material	Utensils	Microwave Cooking	Micro/Convec Cooking	Convection Cooking
Ceramic & Glass	*Kenmore Ceramic Tray	OK	OK	NO
	Corning Ware	OK	OK	OK
	Heat resistant Glass Ware	OK	OK	OK
	Glass Ware with metal decoration	NO	NO	NO
	Lead Glass	NO	NO	NO
China	Without metal decoration	OK	OK	OK
Pottery		OK	OK	OK
Plastic	Regular Oven Heat-proof Ware	OK	OK	OK
	Plastic Wrap	OK	NO	NO
Metal	Metal Baking Pan	NO	NO	OK
	Aluminum Foil	OK	OK	OK
Paper	Cups, Plates, Towels	OK	NO	NO
Waxed Paper		OK	NO	NO
Wood		NO	NO	NO

OK: Utensils to use

NO: Utensils to avoid

NOTE: METAL RACK is provided for Convection or Micro/Convec cooking. Remove Metal Rack from oven when not being used for the cooking.

*The ceramic tray must be removed only for Convection cooking. However the tray should always be in the oven when either the Microwave or Micro/Convec cooking is used. This is because, both the upper and lower heaters are in operation for convection cooking and the ceramic tray shields heat from the lower heater.

CARE AND CLEANING

The oven cavity is made of stainless steel and should be cleaned with a detergent specially formulated for stainless steel.

After convection cooking in particular, the interior of the oven tends to be stained with spattered oil. It is recommended that the oven be cleaned each time after use before the oil spatters harden and become difficult to remove.

For best performance and safety, the inner door panel should be free of food or grease build-up. Wipe both often with a mild detergent, rinse, and wipe dry. Never use rough powders or pads.

After cleaning the control panel, touch CLEAR. This will clear any entries that might have been entered accidentally while cleaning the panel.

REMOVABLE PARTS

After each use of the Temperature Probe, it must be removed from the socket. Use pot holder, as the wire, plug and sensor sections may be hot. Wipe food or liquid from sensor with damp cloth.

The Ceramic Tray and Metal Rack can be removed for cleaning at the sink. Wipe up spillovers with paper towel or cloth before removal of tray.

Wash in warm soapy water and dry. Do not use rough cleaning powders, steel wool, or rough cleaning pads.

The fan cover (inside oven top) can be gently wiped in place or removed for washing with detergent in a sink. Handle with care when washing in a sink. The fan cover can be removed by taking out the two screws used to hold it in place and pushing the cover backward carefully. Avoid hitting or bending the metal stirrer blade, as this cause uneven cooking or microwave power loss. To replace, hook the cover to two studs with flange on the rear oven ceiling and pull the cover forward to end of its travel then secure it using the two screws at front.

SPECIAL CARE

For best performance and safety, the inner door panel and the oven front frame should be free of food or grease build-up. Wipe both often with a mild detergent. Then rinse and wipe dry. *Never use rough powders or pads.*

After cleaning the control panel, touch CLEAR. This will clear any entries that might have been entered accidentally while cleaning the panel.

CAUTION: Wipe the fan cover after each use to keep the food soils from falling onto the cooking tray. The fan cover is coated with Teflon* for easy cleaning. Do not apply abrasive powders, metal or nylon wash pads, nor any metal objects such as knives and forks to the fan cover. Hard objects and abrasive cleaners may scratch the coating. To clean, use only a foam sponge or wash cloth with a mild kitchen cleaner.

NOTE: Should the Teflon* coating be scratched off, the oven function will not be affected.

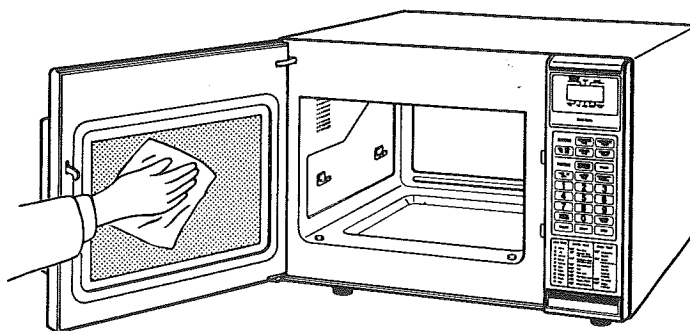
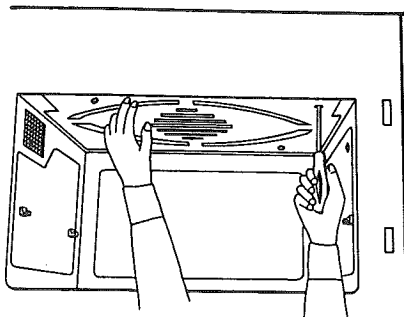

QUESTIONS AND ANSWERS

OPERATION

Q. What is wrong when the oven light will not glow during cooking or when the oven door is open?

- A. *There may be several reasons why the oven light will not glow. Perhaps:*
- *Door is not closed and locked. Push door firmly to be sure that door is locked properly.*
 - *The light bulb has burned out.*
-

Q. Why does steam come out of the air exhaust vent?

- A. *Steam is normally produced during cooking. This microwave/convec oven has been designed to vent this steam out the rear vent.*
-

Q. Will the microwave oven be damaged if it operates empty?

- A. *Yes. Never run it empty and without the ceramic tray for microwave or micro/convection cooking.*
-

Q. Does microwave energy pass through the viewing screen in the door?

- A. *No. The metal screen bounces back the energy back into the oven cavity. The holes (or ports) are made to allow light to pass through. They do not let microwave energy pass through.*
-

Q. Why does the “beep tone” sound when a “pad” on the control panel is touched?

- A. *The “beep tone” sounds to assure that the setting is being properly entered.*
-

Q. Why does the display show “0:00”?

- A. *This indicates that there has been a temporary loss of electrical power to the oven, and the TIME OF DAY must be reset.*
-

Q. Why does the smoke come out of the exhaust duct at the back of oven?

- A. *It is normal that the smoke may come out of the duct during convection cooking. The smoke will be produced when the food is over-cooked, and will be led to the duct.*
-

Q. Why does it take so long to preheat sometimes?

- A. *When the oven door is opened during the preheating, the hot air will escape from the oven and the oven temperature will drop, making the preheating time longer. Avoid opening the oven door during preheating, convection cooking or micro/convec cooking, whenever possible.*
-

Q. Why do I see light reflection around the outer case?

- A. *This light is from the oven light which is located outside the oven cavity.*
-

Q. Why is clicking (Mechanical switching) sound heard when operating in convection method?

- A. *The clicking sound is normal. Because when operating in convection method, upper and lower heating element are back and forth by a relay inside of the oven.*
-

Q. Is the moisture accumulation on the top and/or sides of the oven door normal when cooking in the Micro/Convection method?

- A. *Yes, when foods with high moisture content are cooked, water beads may form on the top and/or sides of the oven door, but will dissipate after use.*
-

Q. Why does the oven floor make an “oil canning” noise when cooking in the convection method?

- A. *This is a normal reaction of the cold oven floor to the heating of the lower element or to the hot oven floor cooling.*
-

QUESTIONS AND ANSWERS (Cont'd)

FOODS

Q. What is wrong when baked foods have a hard, dry, brown spot?

A. A hard, dry, brown spot shows overcooking. Shorten the cooking or reheating time.

Q. Why do eggs sometimes pop?

A. When baking, frying or poaching eggs, the yolk may pop due to steam build-up inside the yolk membrane. To prevent this, simply pierce the yolk with a toothpick before cooking it.

CAUTION: Never microwave cook eggs in the shell.

Q. Why are scrambled eggs sometimes a little dry after cooking?

A. Eggs dry out if they are overcooked. Though the same recipe is used each time, one may need to vary the cooking time for one of these reasons:

- Eggs vary in size.
 - Eggs are at room temperature one time and at refrigerator temperature another time.
 - The shapes of utensils vary, thereby making it necessary to vary the cooking time.
 - Eggs continue cooking during standing time.
-

Q. Is it possible to pop corn in a microwave oven?

A. Yes, if using one of the two methods described below.

- (1) Microwave-popping devices designed specifically for this type of microwave cooking or
- (2) Prepackaged commercial microwave popcorn that contains specific times and power outputs needed for an acceptable final product.

FOLLOW EXACT DIRECTIONS GIVEN BY EACH MANUFACTURER FOR THEIR POPCORN POPPING PRODUCT AND DO NOT LEAVE THE OVEN UNATTENDED WHILE THE CORN IS BEING POPPED.

IF CORN FAILS TO POP AFTER THE SUGGESTED TIMES, DISCONTINUE COOKING. OVERCOOKING COULD RESULT IN AN OVEN FIRE.

CAUTION: NEVER USE A BROWN PAPER BAG FOR POPPING CORN.

Q. What is wrong when three potatoes bake thoroughly and the fourth one is still not cooked?

A. The fourth potato may be slightly heavier than the others and should be cooked 30 to 60 seconds longer. Remember to allow space around each potato when baking. Also, for more even cooking, put potatoes in a circle.

Q. Why do baked apples sometimes burst during cooking?

A. The peeling has not been removed from the top half of each apple to allow for expansion of the interior of the apple during cooking. As in regular cooking methods, the interior of the apple expands during the cooking process.

Q. How are boil-overs avoided?

A. When cooking foods that tend to boil over, use a larger utensil than usual for cooking. If you open the oven door or touch STOP, the food will stop boiling. (Remember to touch START again after closing the door to restart the cooking cycle.)

Q. Why is a standing time recommended after microwave cooking is over?

A. Standing time is recommended after microwave cooking is over. This is to allow foods to continue cooking evenly throughout for a few moments after the actual microwave oven cooking cycle. The amount of standing time depends upon the density of the food.

Q. Why is an additional time required for cooking food stored in refrigerator?

A. As in conventional cooking, the initial temperature of food affects total cooking time. More time is needed to cook the food just taken out of a refrigerator than food at a room temperature.

SEARS SERVICE

WE SERVICE WHAT WE SELL

"We Service What We Sell" is our assurance to you that you can depend on Sears for service because Sears service is nationwide.

Your Kenmore Microwave/Convection Oven has added value when you consider that Sears has a service unit near you, staffed by Sears Trained Technicians — professional technicians specifically trained on Kenmore Microwave/Convection Ovens, having the parts, tools and equipment to ensure that we meet our pledge to you — "We Service What We Sell!"

TO FURTHER ADD TO THE VALUE OF YOUR MICROWAVE/CONVECTION OVEN, BUY A SEARS MAINTENANCE AGREEMENT.

Sears Microwave/Convection Ovens are designed, manufactured, and tested for years of dependable operation. Yet any modern appliance may require service from time to time. A Sears Maintenance Agreement is more than an extension of the Warranty. It provides complete protection from unexpected repair bills and undue inconvenience. It assures you of maximum efficiency from your Microwave/Convection Oven. Here's a comparative Warranty and Maintenance Agreement chart showing you the benefits of a Sears Microwave/Convection Oven Maintenance Agreement.

YEARS OF OWNERSHIP COVERAGE	1st Yr.	2nd Yr. thru 5th Yr.
1. Replacement of defective parts other than magnetron	W	MA
2. Replacement of magnetron	W	W
3. Annual preventative maintenance check at your request	MA	MA

W—WARRANTY
MA—MAINTENANCE AGREEMENT

Contact your Sears salesperson or local Sears Service Center today and purchase a Sears Maintenance Agreement.

SEARS

**USE & CARE
MANUAL**

**STOCK NO.
87561**

Kenmore

**MICRO/CONVECTION
OVEN**

WARRANTY

**FULL ONE YEAR WARRANTY ON
MICROWAVE/CONVECTION OVEN**

FOR ONE YEAR FROM THE DATE OF PURCHASE, IF THIS KENMORE MICROWAVE/CONVECTION OVEN FAILS DUE TO A DEFECT IN MATERIAL OR WORKMANSHIP, SEARS WILL REPAIR IT, FREE OF CHARGE.

FULL FIVE YEAR WARRANTY OF THE MAGNETRON

FOR FIVE YEARS FROM THE DATE OF PURCHASE, IF THE MAGNETRON IN THIS KENMORE MICROWAVE/CONVECTION OVEN FAILS DUE TO A DEFECT IN MATERIAL OR WORKMANSHIP, SEARS WILL REPAIR IT, FREE OF CHARGE.

THE ABOVE WARRANTY COVERAGE APPLIES ONLY TO MICROWAVE/CONVECTION OVENS WHICH ARE USED FOR PRIVATE HOUSEHOLD PURPOSES.

**WARRANTY SERVICE IS AVAILABLE BY SIMPLY
CONTACTING THE NEAREST SEARS STORE OR
SERVICE CENTER IN THE UNITED STATES.**

THIS WARRANTY APPLIES ONLY WHILE THIS PRODUCT IS IN USE IN THE UNITED STATES.

THIS WARRANTY GIVES YOU SPECIFIC LEGAL RIGHTS, AND YOU MAY ALSO HAVE OTHER RIGHTS WHICH VARY FROM STATE TO STATE.

**SEARS, ROEBUCK AND CO.
DEPT. 698/731A, SEARS TOWER, CHICAGO, IL. 60684**

Sears, Roebuck and Co., Chicago, IL 60684 U.S.A.