

# SHARP®

## BD-HP21U

BLU-RAY DISC PLAYER  
LECTEUR DE DISQUE BLU-RAY  
REPRODUCTOR DE DISCOS BLU-RAY

OPERATION MANUAL  
MODE D'EMPLOI  
MANUAL DE OPERACIÓN

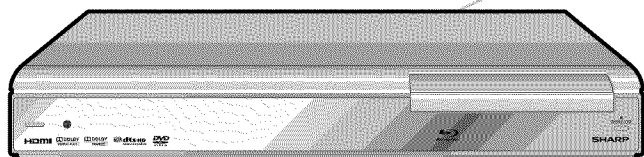

ENGLISH

FRANÇAIS

ESPAÑOL



AQUOS LINK



BD-Video



RW  
COMPATIBLE



**HDMI™**  
HIGH-DEFINITION MULTIMEDIA INTERFACE

x.v.Color



**DOLBY**  
DIGITAL PLUS

**DOLBY**  
TRUEHD



# OPERATION MANUAL ENGLISH

For future reference, record the model and serial number (located on the rear of the product) in the space provided.

Model No.: \_\_\_\_\_

Serial No.: \_\_\_\_\_

**WARNING: TO REDUCE THE RISK OF FIRE OR ELECTRIC SHOCK, DO NOT EXPOSE THIS APPLIANCE TO RAIN OR MOISTURE.**



**CAUTION**  
RISK OF ELECTRIC SHOCK  
DO NOT OPEN



**CAUTION:**  
TO REDUCE THE RISK OF ELECTRIC SHOCK, DO NOT REMOVE COVER. NO USER-SERVICEABLE PARTS INSIDE. REFER SERVICING TO QUALIFIED SERVICE PERSONNEL.



This symbol warns the user of uninsulated voltage within the unit that can cause dangerous electric shocks.



This symbol alerts the user that there are important operating and maintenance instructions in the literature accompanying this unit.

**“WARNING—FCC Regulations state that any unauthorized changes or modifications to this equipment not expressly approved by the manufacturer could void the user’s authority to operate this equipment.”**

## INFORMATION

This equipment has been tested and found to comply with the limits for a Class B digital device, pursuant to Part 15 of the FCC Rules. These limits are designed to provide reasonable protection against harmful interference in a residential installation. This equipment generates, uses and can radiate radio frequency energy and, if not installed and used in accordance with the instructions, may cause harmful interference to radio communications. However, there is no guarantee that interference will not occur in a particular installation. If this equipment does cause harmful interference to radio or television reception, which can be determined by turning the equipment off and on, the user is encouraged to try to correct the interference by one or more of the following measures:

- Reorient or relocate the receiving antenna.
- Increase the separation between the equipment and receiver.
- Connect the equipment into an outlet on a circuit different from that to which the receiver is connected.
- Consult the dealer or an experienced radio/TV technician for help.

## CAUTION:

THIS UNIT IS A CLASS 1 LASER PRODUCT.

USE OF CONTROLS OR ADJUSTMENTS OR PERFORMANCE OF PROCEDURES OTHER THAN THOSE SPECIFIED HEREIN MAY RESULT IN HAZARDOUS RADIATION EXPOSURE.

AS THE LASER BEAM USED IN THIS UNIT IS HARMFUL TO THE EYES, DO NOT ATTEMPT TO DISASSEMBLE THE CABINET.  
REFER SERVICING TO QUALIFIED PERSONNEL ONLY.

# Contents

## ① Introduction

Contents .....	2
What would you like to do with this Player? .....	3
DEAR SHARP CUSTOMER .....	4
IMPORTANT SAFETY INSTRUCTIONS... ..	4 – 6
About Discs.....	7 – 8
About Disc Contents.....	9
Important Information.....	10
Getting Started .....	11
Major Components.....	12 – 13

## ② Connection

Introduction to Connections .....	14
Video Connections .....	15 – 17
Connecting to the HDMI Terminal .....	15
Switching the video output between HDMI and Component video .....	15
Connecting to the Component Jacks .....	16
Connecting to the Video Jack.....	17
Audio Connections.....	18 – 19
Connecting to the Digital Audio Terminal.....	18
Connecting the Audio Jacks.....	19

## ③ Disc Playback

Before Starting Playback.....	20 – 23
Loading the Batteries in the Remote Control.....	20
Connecting the Power Cord .....	20
Setting the Remote Control Code.....	21
Operating a SHARP TV Using the Remote Control ...	21
Turning the Power On.....	22
Language Setting .....	22
Turning Off the LCD Backlight and Indications .....	23
Using AQUOS LINK.....	23
BD/DVD/CD Playback.....	24 – 27
Loading a Disc .....	24
BD/DVD Video Playback.....	24
BD/DVD Menus.....	24
BONUSVIEW	
Use of Picture in Picture function (secondary audio/video playback).....	25
Virtual Package .....	25
DVD-R/-RW Playback .....	26
Audio CD Playback .....	27

Playback Functions .....	28 – 30
Fast Forward/Reverse (Search).....	28
Skipping to the Next or the Start of the Current Chapter (Track).....	28
Pause/Frame Advance Playback .....	28
Slow Playback.....	28
Repeat Playback of a Title or Chapter (Repeat Playback).....	28
Partial Repeat Playback (Repeat Playback of a Specified Part) .....	29
Switching Audio .....	29
Switching Subtitles .....	29
Switching the Angle.....	30
Displaying the Angle Mark .....	30
JPEG File Playback .....	31
Settings During Playback .....	32 – 33
Function Control.....	32

## ④ Settings

SETTINGS.....	34 – 40
Basic Operation for PLAYBACK SETTING .....	34
AUDIO VIDEO SETTINGS .....	35
QUICK START .....	36
AUTO POWER OFF .....	36
AQUOS LINK.....	36
PLAYBACK SETTING .....	36
FRONT DISPLAY/LED .....	37
VERSION.....	37
SYSTEM RESET.....	37
USB MEMORY MANAGEMENT .....	38
SOFTWARE UPDATE .....	39 – 40

## ⑤ Appendix

Troubleshooting.....	41 – 42
On-screen Error Messages .....	42
Glossary .....	43 – 44
Specifications .....	45
LIMITED WARRANTY .....	46 – 47

\* The illustrations and on-screen displays in this operation manual are for explanation purposes and may vary slightly from the actual operations.

# What would you like to do with this Player?

## Watching high quality movies on Blu-ray discs

This Player offers full high-definition Blu-ray disc playback.

**BD/DVD/CD Playback (p. 24)**

## Enjoying different kinds of discs and contents

Use this Player to enjoy various types of optical discs such as DVDs and CDs that contain various multimedia content.

**About Discs (pp. 7–8)**

**BD/DVD/CD Playback (p. 24)**

## Simple connection and operation through HDMI

This Player is equipped with an HDMI terminal. You can connect it to the TV using HDMI and no other cable will be needed to enjoy movies. If your TV is compatible with AQUOS LINK, you can control both the TV and this Player with simple operations.

**Introduction to Connections (p. 14)**

**Video Connections (p. 15)**

## What to do first:

Refer to “Getting Started” (p. 11) to prepare for watching your discs.

### ① Introduction (pp. 1–13)

Explains the important operation information.

1

### ② Connection (pp. 14–19)

Shows the connecting options provided by this Player.

2

### ③ Disc Playback (pp. 20–33)

Shows simple playback and useful functions.

3

### ④ Settings (pp. 34–40)

Gives you more options to suit your circumstances.

4

### ⑤ Appendix (pp. 41–47)

Provides troubleshooting tips and more information.

5

# DEAR SHARP CUSTOMER

Thank you for your purchase of the SHARP Blu-ray Disc Player. To ensure safety and many years of trouble-free operation of your product, please read the Important Safety Instructions carefully before using this product.

## IMPORTANT SAFETY INSTRUCTIONS

Electricity is used to perform many useful functions, but it can also cause personal injuries and property damage if improperly handled. This product has been engineered and manufactured with the highest priority on safety. However, improper use can result in electric shock and/or fire. In order to prevent potential danger, please observe the following instructions when installing, operating and cleaning the product. To ensure your safety and prolong the service life of your Blu-ray Disc Player, please read the following precautions carefully before using the product.

- 1) Read these instructions.
- 2) Keep these instructions.
- 3) Heed all warnings.
- 4) Follow all instructions.
- 5) Do not use this apparatus near water.
- 6) Clean only with dry cloth.
- 7) Do not block any ventilation openings. Install in accordance with the manufacturer's instructions.
- 8) Do not install near any heat sources such as radiators, heat registers, stoves, or other apparatus (including amplifiers) that produce heat.
- 9) Do not defeat the safety purpose of the polarized or grounding-type plug. A polarized plug has two blades with one wider than the other. A grounding type plug has two blades and a third grounding prong. The wide blade or the third prong are provided for your safety. If the provided plug does not fit into your outlet, consult an electrician for replacement of the obsolete outlet.
- 10) Protect the power cord from being walked on or pinched particularly at plugs, convenience receptacles, and the point where they exit from the apparatus.
- 11) Only use attachments/accessories specified by the manufacturer.
- 12) Use only with the cart, stand, tripod, bracket, or table specified by the manufacturer, or sold with the apparatus. When a cart is used, use caution when moving the cart/apparatus combination to avoid injury from tip-over.
- 13) Unplug this apparatus during lightning storms or when unused for long periods of time.
- 14) Refer all servicing to qualified service personnel. Servicing is required when the apparatus has been damaged in any way, such as power-supply cord or plug is damaged, liquid has been spilled or objects have fallen into the apparatus, the apparatus has been exposed to rain or moisture, does not operate normally, or has been dropped.



### Additional Safety Information

- 15) Power Sources—This product should be operated only from the type of power source indicated on the marking label. If you are not sure of the type of power supply to your home, consult your product dealer or local power company. For products intended to operate from battery power, or other sources, refer to the operating instructions.
- 16) Overloading—Do not overload wall outlets, extension cords, or integral convenience receptacles as this can result in a risk of fire or electric shock.
- 17) Object and Liquid Entry—Never push objects of any kind into this product through openings as they may touch dangerous voltage points or short-out parts that could result in a fire or electric shock. Never spill liquid of any kind on the product.
- 18) Damage Requiring Service—Unplug this product from the wall outlet and refer servicing to qualified service personnel under the following conditions:
  - a) When the AC cord or plug is damaged,
  - b) If liquid has been spilled, or objects have fallen into the product,
  - c) If the product has been exposed to rain or water,
  - d) If the product does not operate normally by following the operating instructions.  
Adjust only those controls that are covered by the operating instructions as an improper adjustment of other controls may result in damage and will often require extensive work by a qualified technician to restore the product to its normal operation,
  - e) If the product has been dropped or damaged in any way, and
  - f) When the product exhibits a distinct change in performance - this indicates a need for service.
- 19) Replacement Parts—When replacement parts are required, be sure the service technician has used replacement parts specified by the manufacturer or have the same characteristics as the original part. Unauthorized substitutions may result in fire, electric shock, or other hazards.
- 20) Safety Check—Upon completion of any service or repairs to this product, ask the service technician to perform safety checks to determine that the product is in proper operating condition.
- 21) Wall or ceiling mounting—When mounting the product on a wall or ceiling, be sure to install the product according to the method recommended by the manufacturer.
- 22) The main AC plug is used as disconnect device and shall always remain readily operable.

# IMPORTANT SAFETY INSTRUCTIONS

- **Water and Moisture** — Do not use this product near water - for example, near a bath tub, wash bowl, kitchen sink, or laundry tub; in a wet basement; or near a swimming pool; and the like.

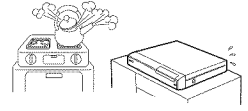

- **Stand** — Do not place the product on an unstable cart, stand, tripod or table. Placing the product on an unstable base can cause the product to fall, resulting in serious personal injuries as well as damage to the product. Use only a cart, stand, tripod, bracket or table recommended by the manufacturer or sold with the product. When mounting the product on a wall, be sure to follow the manufacturer's instructions. Use only the mounting hardware recommended by the manufacturer.

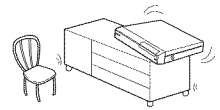

- **Selecting the location** — Select a place with no direct sunlight and good ventilation.

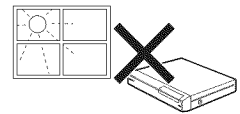

- **Ventilation** — The vents and other openings in the cabinet are designed for ventilation. Do not cover or block these vents and openings since insufficient ventilation can cause overheating and/or shorten the life of the product. Do not place the product on a bed, sofa, rug or other similar surface, since they can block ventilation openings. This product is not designed for built-in installation; do not place the product in an enclosed place such as a bookcase or rack, unless proper ventilation is provided or the manufacturer's instructions are followed.

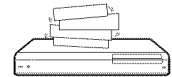

- **Heat** — The product should be situated away from heat sources such as radiators, heat registers, stoves, or other products (including amplifiers) that produce heat.

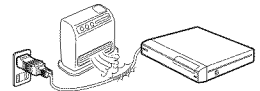

- **Lightning** — For added protection for this product during a lightning storm, or when it is left unattended and unused for long periods of time, unplug it from the wall outlet. This will prevent damage to the equipment due to lightning and power-line surges.

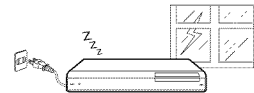

- To prevent fire, never place any type of candle or flames on the top or near the product.

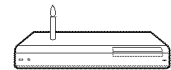

- To prevent fire or shock hazard, do not expose this product to dripping or splashing. No objects filled with liquids, such as vases, should be placed on the product.

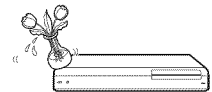

# IMPORTANT SAFETY INSTRUCTIONS

- To prevent fire or shock hazard, do not place the AC cord under the product or other heavy items.

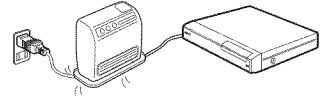

- Turn off the main power and unplug the AC cord from the wall outlet before handling.
- To clean the outer cabinet, periodically wipe it with a soft cloth.
- Do not use chemicals for cleaning. It may damage the cabinet finish.



# About Discs



## Blu-ray Disc

Blu-ray Disc is the ultimate next generation optical media format, offering the following key features:

- Largest capacity (25 GB single layer – 50 GB dual layer) – with over 5 times the amount of content possible with current DVDs, particularly well suited for high definition feature films with extended levels of interactive features
- Pristine picture quality with the capability for full high definition 1920 x 1080p resolution
- Best audio possible with uncompressed surround sound (higher quality than even theatre audio)
- Broadest industry support – ensuring more choice for consumers in the marketplace
- Hardware products will be backward compatible with DVDs, allowing continued enjoyment of existing DVD libraries.
- Disc Durability – new breakthroughs in hard coating technologies gives Blu-ray Discs the strongest resistance to scratches and finger prints.

## Types of Discs that Can Be Used with This Player

- The following discs can be played back in this Player. Do not use an 8 cm (3") to 12 cm (5") adapter.
- Use discs that conform to compatible standards as indicated by the presence of official logos on the disc label. Playback of discs not complying with these standards is not guaranteed. In addition, the image quality or sound quality is not guaranteed even if the discs can be played back.

Disc Type		Recording Format	Contents	Disc Size
BD video	Region code A/ALL 	—	Audio + Video (Movie)	12 cm (5")
BD-RE DL BD-R DL		BDMV format only		
DVD Video	Region code 1/ALL 	Video format	Audio + Video (Movie)	12 cm (5") 8 cm (3")
DVD+RW/DVD+R DVD-R DL DVD-RW/DVD-R		Video/VR format (finalized disc only)	Audio + Video (Movie)	12 cm (5") 8 cm (3")
Audio CD*1		Audio CD (CD-DA)	Audio	12 cm (5") 8 cm (3")
CD-RW/CD-R		Audio CD (CD-DA) JPEG*2	Audio Still image (JPEG file)	

\*1 This Player has been designed on the premise of playing back Audio CDs that comply with CD (Compact Disc) standards. CDs containing a signal for the purpose of protecting copyrights (copy control signal) may not be able to be played back with this Player.

- BD/DVD video players and discs have region codes, which dictate the regions in which a disc can be played. This Player's region code is **A** for BD and **1** for DVD. (Discs marked **ALL** will play in any player.)
- BD/DVD Video operations and functions may be different from the explanations in this manual and some operations may be prohibited due to disc manufacturer's settings.
- If a menu screen or operating instructions are displayed during playback of a disc, follow the operating procedure displayed.
- The audio component of a DVD video recorded at 96 kHz (Linear PCM) will be output as 48 kHz audio during playback.

### NOTE

- Playback for some of the discs in the left side column tables may not be possible depending on the disc.
- "Finalize" refers to a recorder processing a recorded disc so that it will play in other DVD players/recorders as well as this player. Only finalized DVD discs will play back in this player. (This player does not have a function to finalize discs.)

## Discs that Cannot Be Used with This Player

- **The following discs cannot be played back or will not play back properly on this Player. If such a disc is mistakenly played back, speaker damage may occur. Never attempt to play back these discs.**

CDG, Video CD, Photo CD, CD-ROM, CD-TEXT, SVCD, SACD, PD, CDV, CVD, DVD-RAM, DVD-Audio, BD-RE with the cartridge, CD-MP3, CD-WMA

- **Discs with unusual shapes cannot be played.**
  - Discs with unusual shapes (heart-shaped or hexagonal discs, etc.) cannot be used. The use of such discs will cause malfunction.
- **The following BD video discs cannot be played.**
  - Discs not displaying "A" or "ALL" for the region code (discs sold outside the authorized marketing area).\*
  - Discs produced illegally.
  - Discs recorded for commercial use.
  - \* The region code for this product is A.
- **The following DVD video discs cannot be played.**
  - Discs not displaying "1" or "ALL" for the region code (discs sold outside the authorized marketing area).\*
  - Discs produced illegally.
  - Discs recorded for commercial use.
  - \* The region code for this product is 1.
- **The following BD-RE/R, DVD-RW/R and DVD+RW/R discs cannot be played.**
  - Discs on which data has not been recorded cannot be played back.
- **The following Audio CD discs cannot be played.**
  - Discs containing a signal for the purpose of protecting copyrights (copy control signal) may not be played back with this Player.
  - This Player has been designed on the premise of playing back Audio CDs that comply with CD (Compact Disc) standards.
- **The following CD-RW/R discs cannot be played.**
  - Discs on which data has not been recorded cannot be played back.
  - Discs recorded in a format other than an Audio CD and JPEG file format\*2 cannot be played back.
  - Discs may not be played back depending on their recording status or the status of the disc itself.
  - Discs may not be played back depending on their compatibility with this Player.



# About Discs

## 2 About the JPEG file format

JPEG is a type of file format for storing still-image files (photos, illustrations, etc.). The Player lets you play JPEG format still-image files.

### ■ File formats that are not compatible.

- Still images in formats other than JPEG (such as TIFF) cannot be played.
- There may be some files that cannot be played even if they are in JPEG format.
- Progressive JPEG files cannot be played.
- Moving image files and audio files as well as Motion JPEG format files cannot be played, even though they are JPEG files.

### ■ Other files that cannot be played back.

- You may not be able to play some still images which you have created, touched up, copied or otherwise edited on your computer.

### ■ You may experience one or more of the following symptoms when playing files.

- It may take some time to play files depending on the number of folders, number of files and volume of data involved.
- EXIF information will not be displayed. EXIF stands for Exchangeable Image File Format, and is a standard for storing interchange information in image files, especially those using JPEG compression. (Refer to <http://exif.org> for more information.)

### ■ When using the unit to play a CD-RW/R disc with still images stored (recorded).

- With CD-RW/R discs on which still images are mixed in with music or movies, you will be able to play only the still images. You may not be able to play some of these discs at all.
- Multi-session discs cannot be played.
- You may not be able to play some still images you have processed (rotated or saved by overwriting other images) using image processing software or some still images you have imported from the Internet or e-mail.
- The discs which this Player can play back (recognize) are limited to the following properties:
  - Contains EXIF format files
  - Picture resolution: Between  $32 \times 32$  and  $7680 \times 4320$  pixels
  - Maximum number of folders: 64
  - Maximum number of files: 256
  - File size: 20MB or less

## ■ Structure of still images (JPEG) folders

You can play still images (JPEG) with this unit by making folder on disc as shown below.

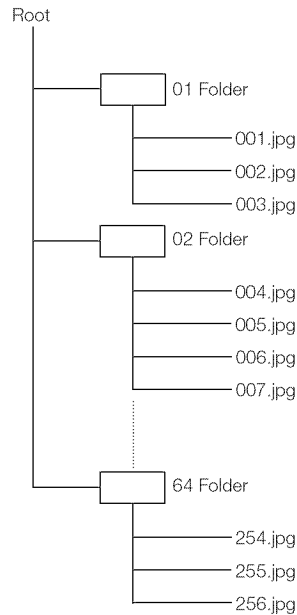

# About Disc Contents

## BD Video

- Enjoy Final Standard Profile functions (Page 25), such as picture-in-picture.  
The available functions differ depending on the disc.  
This is a new function of BD-Video that plays the primary video and secondary video simultaneously.  
For instance, the function is capable of playing the original movie as the primary video while playing video commentary from the film director on a small screen as a secondary video.

## Title, Chapter and Track

- Blu-ray discs and DVDs are divided into "Titles" and "Chapters". If the disc has more than one movie on it, each movie would be a separate "Title". "Chapters", on the other hand, are subdivisions of titles. (See Example 1.)
- Audio CDs are divided into "Tracks". You can think of a "Track" as one tune on an Audio CD. (See Example 2.)

Example 1: Blu-ray disc or DVD

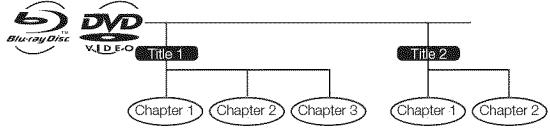

Example 2: Audio CD

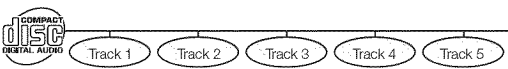

## Icons Used on DVD Video Disc Cases

The back of the case of a DVD that is commercially available usually contains various information about the contents of the disc.

<b>1</b>	<b>2</b>	
<p>1. English 2. Chinese</p>	<p>1. English 2. Chinese</p>	
<b>3</b>	<b>4</b>	<b>5</b>
<p>16:9 LB</p>	<p>2</p>	<p>1 2 3 4 5 6</p>

- 1 Audio tracks and audio formats**  
DVD discs can contain up to 8 separate tracks with a different language on each. The first in the list is the original track.  
This section also details the audio format of each soundtrack — Dolby Digital, DTS, MPEG etc.
- Dolby Digital**  
A sound system developed by Dolby Laboratories Inc. that gives movie theater ambience to audio output when the Player is connected to a Dolby Digital processor or amplifier.
- DTS**  
DTS is a digital sound system developed by DTS, Inc. for use in cinemas. This system uses 6 audio channels and provides accurate sound field positioning and realistic acoustics. (By connecting a DTS Digital Surround decoder, you can also listen to DTS Digital Surround sound.)

- Linear PCM**  
Linear PCM is a signal recording format used for Audio CDs and on some DVD and Blu-ray discs. The sound on Audio CDs is recorded at 44.1 kHz with 16 bits. (Sound is recorded between 48 kHz with 16 bits and 96 kHz with 24 bits on DVD video discs and between 48 kHz with 16 bits and 192 kHz with 24 bits on BD video discs.)
- 2 Subtitle languages**  
This indicates the kind of subtitles.
- 3 Screen aspect ratio**  
Movies are shot in a variety of screen modes.
- 4 Camera angle**  
Recorded onto some BD/DVD discs are scenes which have been simultaneously shot from a number of different angles (the same scene is shot from the front, from the left side, from the right side, etc.).
- 5 Region code**  
This indicates the region code (playable region code).

## The Icons Used in This Operation Manual

- BD VIDEO** ..... Indicates the functions that can be performed for BD Video discs.
- BD-RE** ..... Indicates the functions that can be performed for BD-RE discs.
- BD-R** ..... Indicates the functions that can be performed for BD-R discs.
- DVD VIDEO** ..... Indicates the functions that can be performed for DVD Video discs.
- DVD-RW** ..... Indicates the functions that can be performed for DVD-RW discs.
- DVD-R** ..... Indicates the functions that can be performed for DVD-R discs.
- AUDIO CD** ..... Indicates the functions that can be performed for Audio CDs.
- CD-R** ..... Indicates the functions that can be performed for CD-R discs in JPEG format.
- CD-RW** ..... Indicates the functions that can be performed for CD-RW discs in JPEG format.





# Important Information

## Disc Precautions

### Be Careful of Scratches and Dust

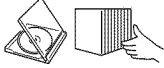
- BD, DVD and CD discs are sensitive to dust, fingerprints and especially scratches. A scratched disc may not be able to be played back. Handle discs with care and store them in a safe place.

### Proper Disc Storage

Place the disc in the center of the disc case and store the case and disc upright.	
Avoid storing discs in locations subject to direct sunlight, close to heating appliances or in locations of high humidity.	
Do not drop discs or subject them to strong vibrations or impacts.	
Avoid storing discs in locations where there are large amounts of dust or moisture.	

### Handling Precautions

- If the surface is soiled, wipe gently with a soft, damp (water only) cloth. When wiping discs, always move the cloth from the center hole toward the outer edge.

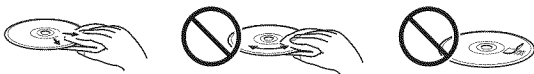

- Do not use record cleaning sprays, benzene, thinner, static electricity prevention liquids or any other solvent.
- Do not touch the surface.
- Do not stick paper or adhesive labels to the disc.
- If the playing surface of a disc is soiled or scratched, the Player may decide that the disc is incompatible and eject the disc tray, or it may fail to play the disc correctly. Wipe any dirt off the playing surface with a soft cloth.

### Cleaning the Pick Up Lens

- Never use commercially available cleaning discs. The use of these discs can damage the lens.
- Request the nearest service center approved by SHARP to clean the lens.

### Warnings about dew formation

- Condensation may form on pick up lens or disc in the following conditions:
  - Immediately after a heater has been turned on.
  - In a steamy or very humid room.
  - When the Player is suddenly moved from a cold environment to a warm one.

#### When condensation forms:

It becomes difficult for the Player to read the signals on the disc and prevents the Player from operating properly.



#### To remove condensation:

Take out the disc and leave the Player with the power off until the condensation disappears. Using the Player when there is condensation may cause malfunction.

## Copyright

- Audio-visual material may consist of copyrighted works which must not be recorded without the authority of the owner of the copyright. Refer to relevant laws in your country.
- This product incorporates copyright protection technology that is protected by U.S. patents and other intellectual property rights. Use of this copyright protection technology must be authorized by Macrovision, and is intended for home and other limited viewing uses only unless otherwise authorized by Macrovision. Reverse engineering or disassembly is prohibited.

**U.S. Patent Nos. 6,836,549; 6,381,747; 7,050,698; 6,516,132; and 5,583,936**

- Manufactured under license from Dolby Laboratories. "Dolby" and the double-D symbol are trademarks of Dolby Laboratories.
- Manufactured under license under U.S. Patent #: 5,451,942; 5,956,674; 5,974,380; 5,978,762; 6,487,535 & other U.S. and worldwide patents issued & pending. DTS is a registered trademark and the DTS logos, Symbol, DTS-HD and DTS-HD Advanced Digital Out are trademarks of DTS, Inc. ©1996-2007 DTS, Inc. All Rights Reserved.
-  is a trademark.
-  is a trademark of DVD Format/Logo Licensing Corporation.
- HDMI, the HDMI logo and High-Definition Multimedia Interface are trademarks or registered trademarks of HDMI Licensing LLC.
- "x.v.Color" and "x.v.Color" logo are trademarks.
- Java and all Java-based trademarks and logos are trademarks or registered trademarks of Sun Microsystems, Inc. in the United States and/or other countries.

# Getting Started

## Step 1: Unpacking

Make sure the following accessories are provided with the product.

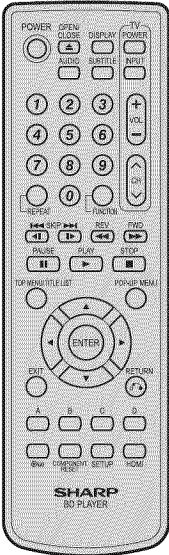
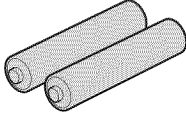
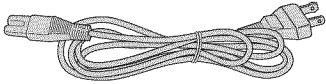
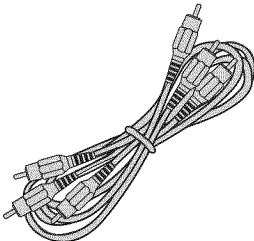
Remote control unit	"AA" size battery (×2)	AC cord
		
AV cable		

## Step 2: Selecting equipment to connect

Connection varies with the equipment used. Refer to Connection. (Pages 14–19)  
Turn off the devices before connecting.

## Step 3: Playing back discs

Play back a Blu-ray disc after connecting the Player to your favorite equipment.  
Refer to Disc Playback. (Pages 20–33)

## Step 4: Adjust settings

Adjust settings to enjoy various features and other functions for playing discs.  
Refer to Settings. (Pages 34–40)

# Major Components

## Main Unit (Front)

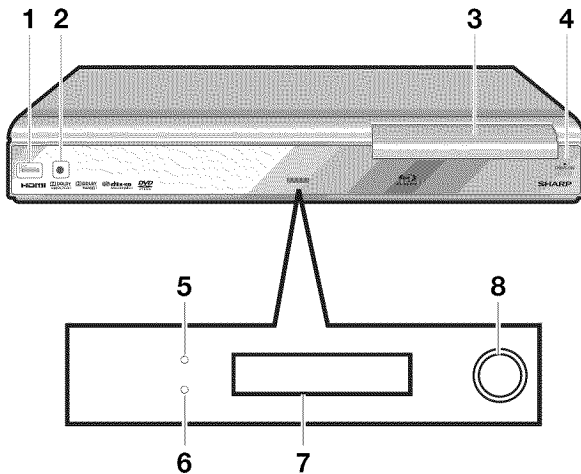

- 1 POWER (p. 22)
- 2 Remote control sensor (p. 20)
- 3 Disc tray (p. 24)
- 4 OPEN/CLOSE (p. 24)
- 5 ON indicator (p. 22)
- 6 STANDBY indicator (p. 22)
- 7 Front panel display (p. 22)
- 8 BD/DVD/CD mode indicator (p. 22)

## Main Unit (Rear)

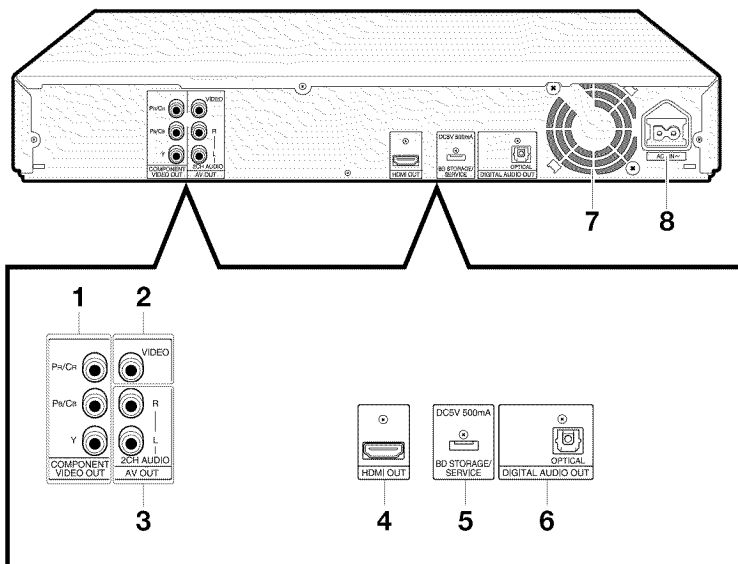

- 1 COMPONENT VIDEO OUT jacks (p. 16)
- 2 VIDEO output jack (p. 17)
- 3 2CH AUDIO output jacks (p. 19)
- 4 HDMI OUT terminal (p. 15)
- 5 BD STORAGE/SERVICE terminal  
BD STORAGE (pp. 25, 38)  
SERVICE for software (p. 39, 40)
- 6 DIGITAL AUDIO OUT OPTICAL terminal (p. 18)
- 7 Cooling fan  
The cooling fan operates while the power to the Player is on.
- 8 AC IN terminal (p. 20)

## Remote Control Unit

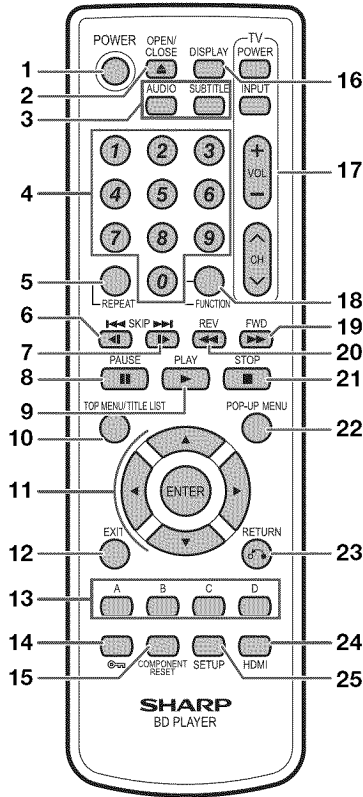

- 1 POWER (p. 22)
- 2 ▲ OPEN/CLOSE (p. 24)
- 3 AUDIO (p. 29), SUBTITLE (p. 29)
- 4 Number buttons (pp. 21, 33)
- 5 REPEAT (pp. 28, 29)
- 6 ⏮ SKIP/REWIND (pp. 26, 28)
- 7 ⏭ SKIP/PAUSE (pp. 26, 28)
- 8 ⏸ PAUSE (p. 28)
- 9 ▶ PLAY (p. 24)
- 10 TOP MENU/TITLE LIST (pp. 24, 26)
- 11 Cursor buttons (▲/▼/◀/▶), ENTER (pp. 22, 34)
- 12 EXIT (pp. 22, 34)
- 13 A (Red), B (Green), C (Blue), D (Yellow) (pp. 27, 31)
- 14 🔒 (Lock) (See below.)
- 15 COMPONENT RESET (p. 35)
- 16 DISPLAY (p. 21)
- 17 TV CONTROL buttons (p. 21)
- 18 FUNCTION (pp. 30, 32)
- 19 ⏩ FWD (p. 28)
- 20 ⏪ REV (p. 28)
- 21 ■ STOP (p. 24)
- 22 POP-UP MENU (p. 25)
- 23 ↶ RETURN (p. 28)
- 24 HDMI (p. 15)
- 25 SETUP (pp. 22, 34)

### Keylock function

You can set the keylock to prevent accidental operations. This function allows TVs compatible with AQUOS LINK to also perform a Key Lock on the player.

Press and hold 🔒 (Lock) for more than 5 seconds.

- Each time you perform this operation, the function is activated or deactivated.
- If you try to operate the Player while the keylock function is set, "Hold" blinks on the front display panel to indicate that the keylock function is set.

Hold

# Introduction to Connections

This Player is equipped with the terminals/jacks listed below. Find the corresponding terminal/jack on your video equipment. Using the supplied cable or commercially available cables, connect the video first. Then connect the audio.

## Video terminals/jacks on this Player

Higher Quality

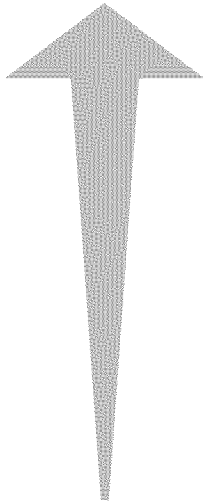

Standard Quality

① HDMI OUT terminal

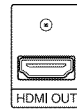

Page 15

② COMPONENT VIDEO OUT jacks

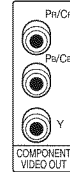

Page 16

③ VIDEO output jack



Page 17

## Audio terminals/jacks on this Player

### Digital audio connection

Higher Quality

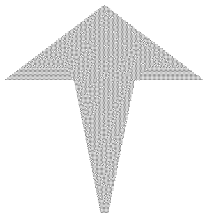

Standard Quality

① HDMI OUT terminal

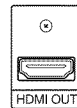

Page 15

② DIGITAL AUDIO OUT OPTICAL terminal

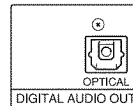

Page 18

### Analog audio connection

Standard Quality

2CH AUDIO output jacks

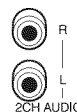

Page 19

# Video Connections

## Connecting to the HDMI Terminal

You can enjoy high quality digital picture and sound through the HDMI terminal. When you use AQUOS LINK, make sure to use a certified HDMI cable.

### STEPS

- 1: Be sure to turn off this Player and the equipment before making any connections.
- 2: Firmly connect an HDMI cable (commercially available) to the HDMI terminals (① and ②).

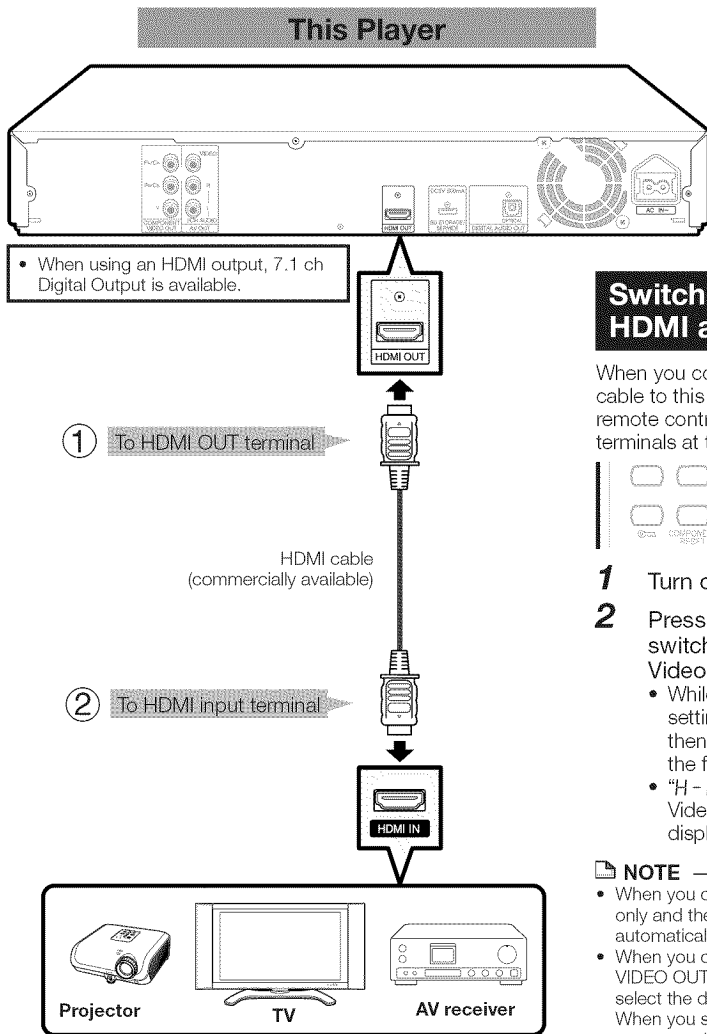

### CAUTION

- HDMI output and Component Video output can not be used at the same time.

### NOTE

- Audio transmitted in DTS-HD High Resolution Audio and DTS-HD Master Audio formats is output from the HDMI terminal as BITSTREAM. Connect an amplifier with a built-in decoder to enjoy the fine sound quality.

## Switching the video output between HDMI and Component video

When you connect both an HDMI cable and a component cable to this player, you can switch the outputs using the remote control. (The video signal is not output over both terminals at the same time.)

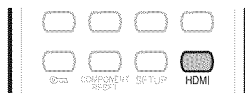

- 1 Turn on the power.
- 2 Press and hold **HDMI** button for 5 seconds to switch between “HDMI Out” and “Component Video Out”.
  - While you are holding the button, the current output setting will be shown with the display blinking, and then the switched output setting will be displayed on the front panel display.
  - “H - oP” (HDMI Out) or “C P - oP” (Component Video Out) is displayed alternately on the front panel display.

### NOTE

- When you connect the player to a SHARP TV with an HDMI cable only and the TV is turned on, the video output switches to HDMI automatically. (The above setting is unnecessary.)
- When you connect the player to a TV with an HDMI cable, HDMI VIDEO OUT is set to “AUTO”. If you don't get a stable image, select the desired resolution\*. When you set HDMI VIDEO OUT to a setting other than “AUTO”, you can only select resolutions\* that are compatible with the connected TV.
- \* Refer to “HDMI VIDEO OUT” on page 35 regarding the resolutions of the HDMI video output.

### CAUTION

- Even when there is no cable connected to the Component video out, switching the output to CP-oP (Component video out) is still possible. When CP-oP is selected, there will be no signal from the HDMI out.

## After connecting

- Load a disc and start playback. (Pages 24–27)
- If desired, connect audio equipment. (Pages 18–19)
- Refer to AQUOS LINK function. (Pages 23 and 36)

2

Connection



# Video Connections

## Connecting to the Component Jacks

You can enjoy accurate color reproduction and high quality images through the component jacks.

### STEPS

- 1: Be sure to turn off this Player and the equipment before making any connections.
- 2: Firmly connect a component video cable (commercially available) to the component jacks (1) and (2).

### CAUTION

- HDMI output and Component Video output can not be used at the same time.

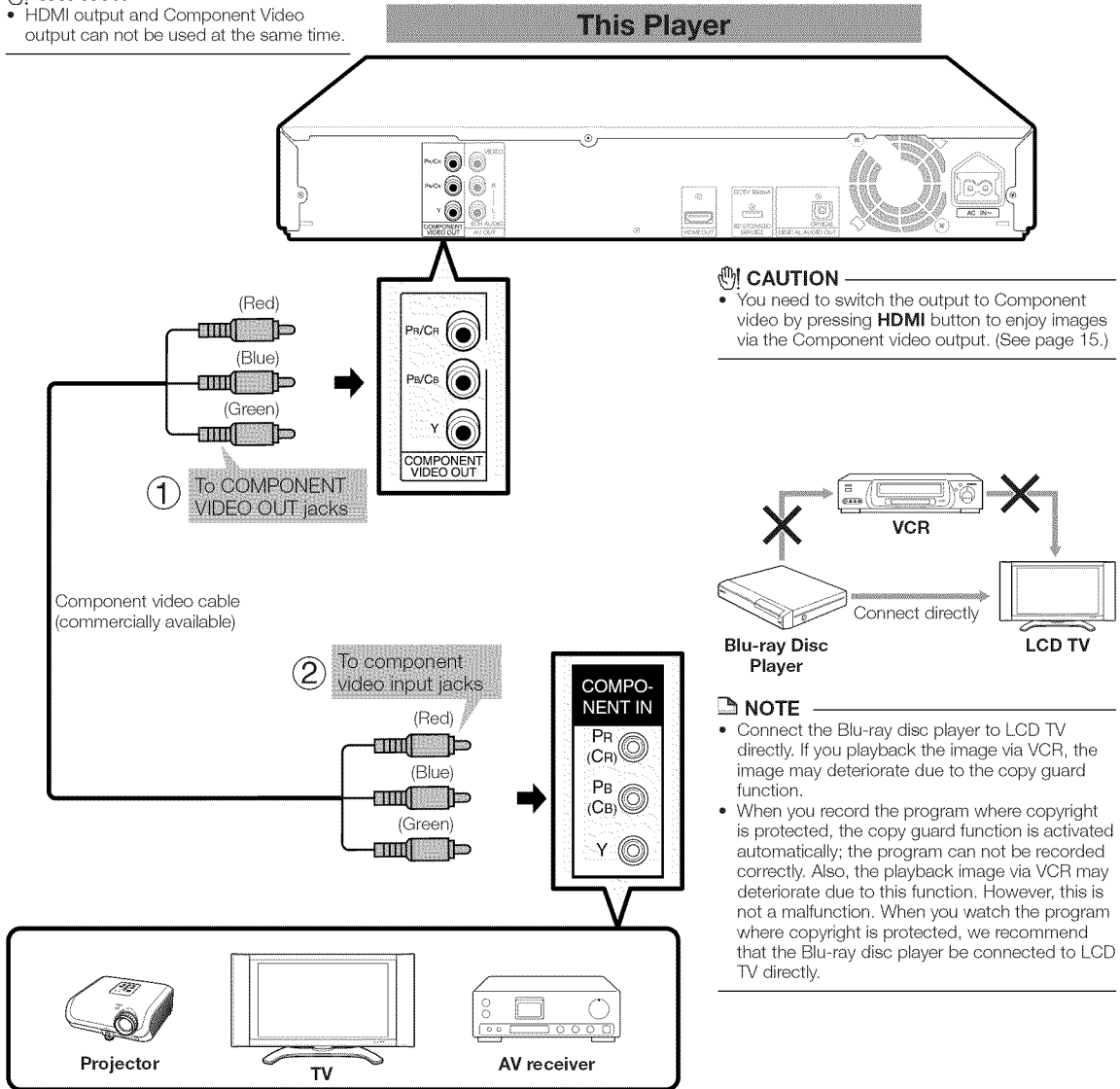

## Video equipment with component jacks

### After connecting

- Connect audio equipment or the audio terminals of the TV. (Pages 18–19)

## Connecting to the Video Jack

You can enjoy the images through the video jack.

### STEPS

- 1: Be sure to turn off this Player and the equipment before making any connections.
- 2: Firmly connect an AV cable (supplied) to the video jacks (① and ②).

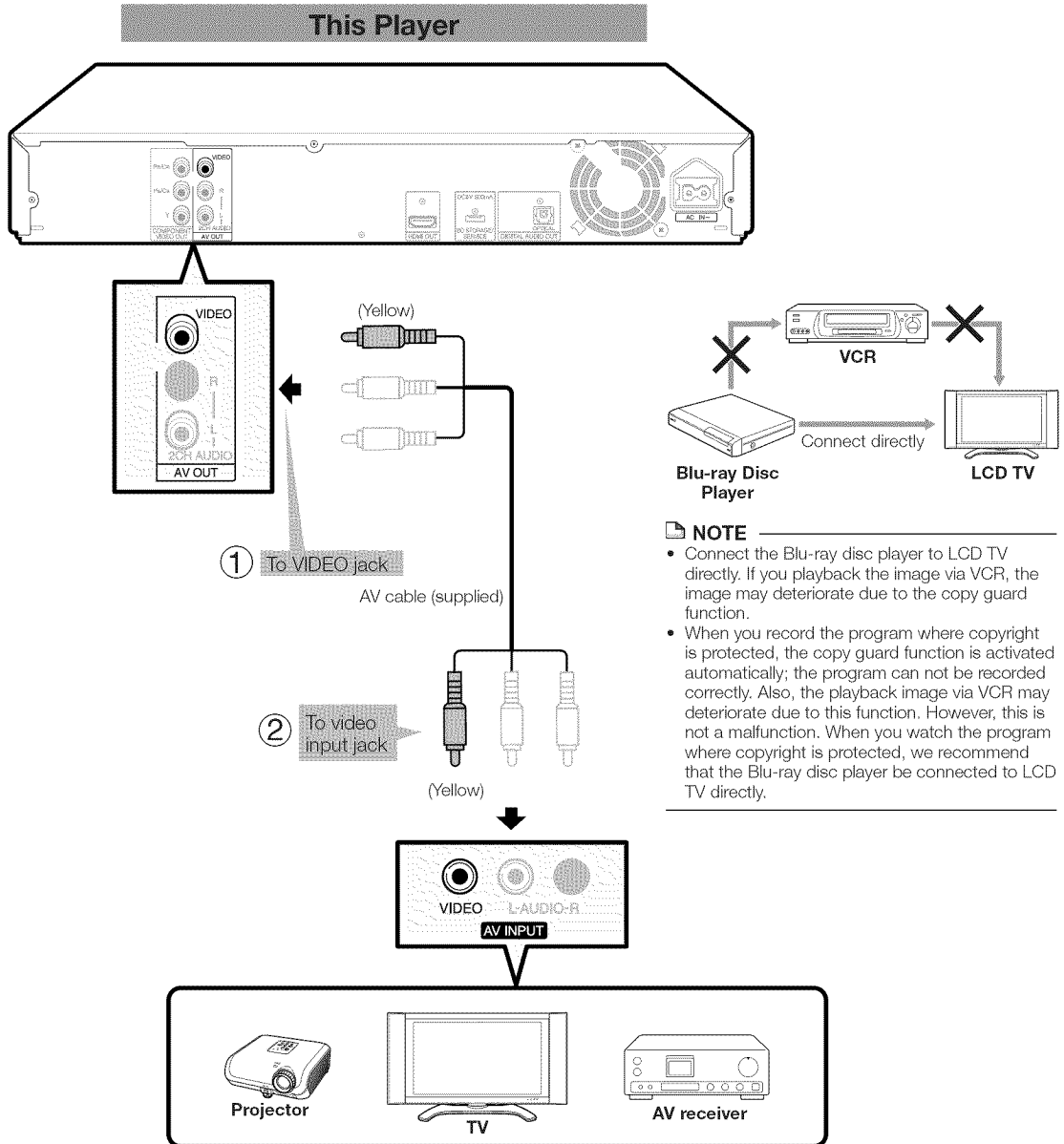

### Video equipment with a video jack

#### After connecting

- Connect audio equipment or the audio terminals of the TV. (Pages 18–19)



## Connecting the Audio Jacks

You can connect audio equipment or the TV to the 2CH AUDIO output jacks.

### STEPS

- 1: Be sure to turn off this Player and the equipment before making any connections.
- 2: Firmly connect the AV cable (supplied) to the audio jacks (① and ②).

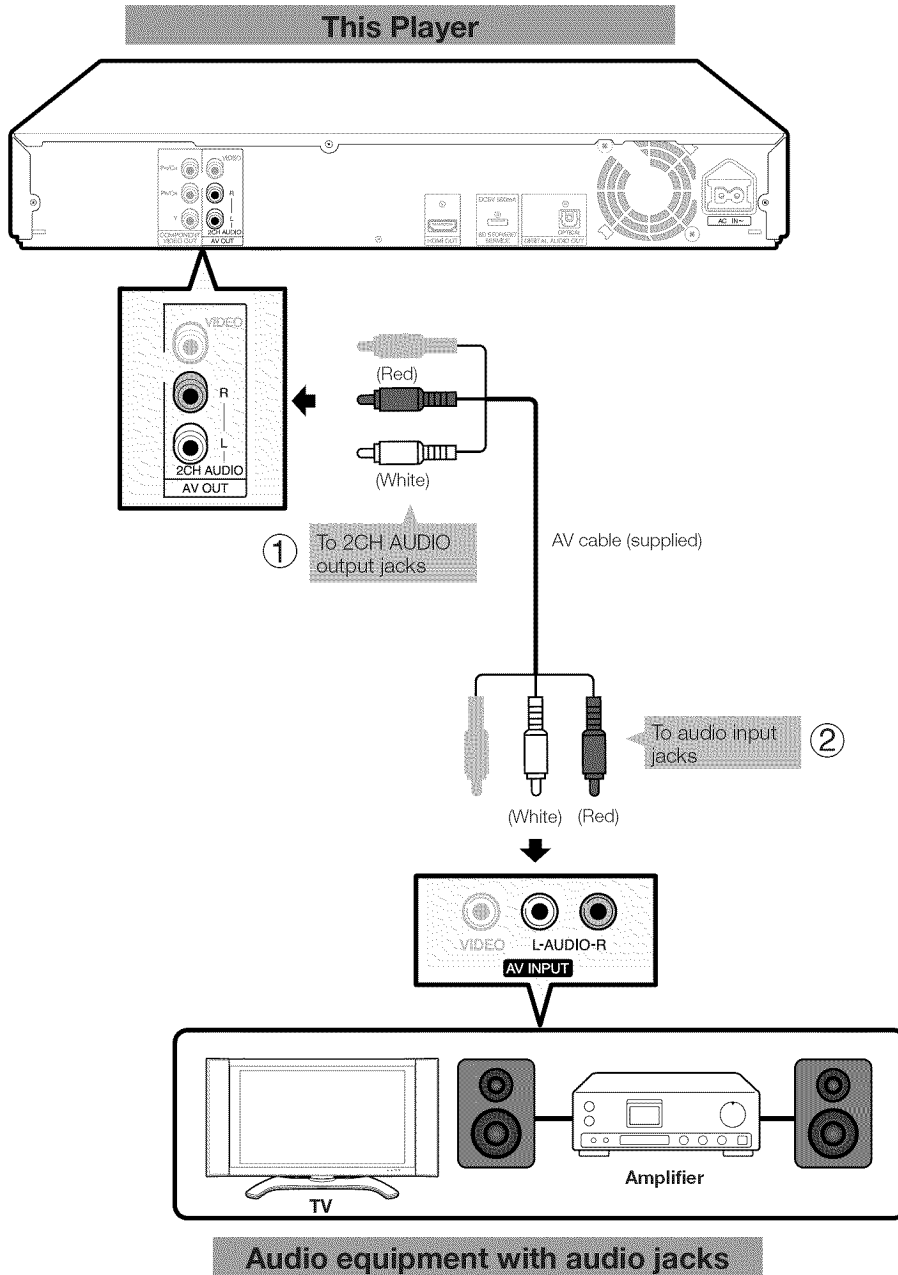

2 Connection

### After connecting

- Load a disc and start playback. (Pages 24–27)

# Before Starting Playback

## Loading the Batteries in the Remote Control

- 1 Hold in the tab on the battery cover and pull the cover towards the direction of the arrow.

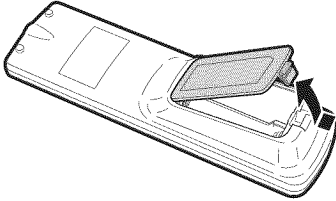

- 2 Load the two "AA" size batteries (R-06 size, UM/SUM-3). Place batteries with their terminals corresponding to the  $\oplus$  and  $\ominus$  indications in battery compartment.

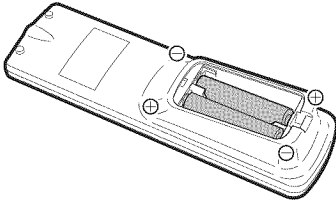

- 3 Insert the smaller tab of the battery cover into the opening ①, and press down on the cover until it clicks in place ②.

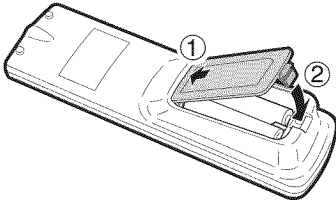

### NOTE

- Do not subject the remote control unit to shock, water or excessive humidity.
- The remote control unit may not function if the Player's remote sensor is in direct sunlight or any other strong light.
- Incorrect use of batteries may cause them to leak or burst. Read the battery warnings and use the batteries properly.
- Do not mix old and new batteries, or mix different brands.
- Remove the batteries if you will not use the remote control unit for an extended period of time.

## Approximate operating range of remote control

Remote control sensor

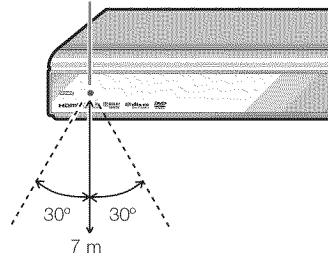

Remote control unit

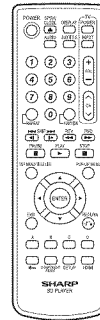

## Connecting the Power Cord

Plug the supplied AC cord into the AC IN terminal on the rear of the Player. Then plug into AC outlet.

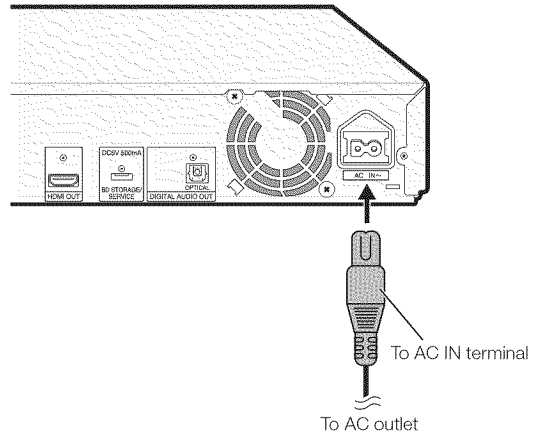

### NOTE

- Place the Player close to the AC outlet, and keep the power plug within reach.
- TO PREVENT RISK OF ELECTRIC SHOCK, DO NOT TOUCH THE UN-INSULATED PARTS OF ANY CABLES WHILE THE AC CORD IS CONNECTED.
- The STANDBY indicator blinks while the Player is preparing for starting up. You cannot turn the Player on until the STANDBY indicator stops blinking.

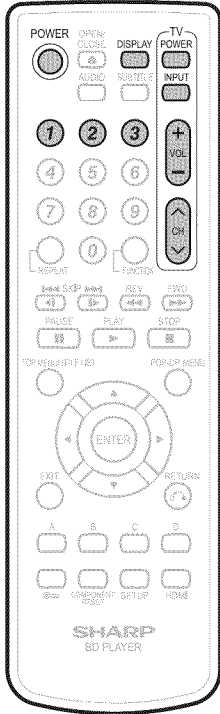

## Setting the Remote Control Code

- 3 types of remote control codes operate this Player: RC-1, RC-2 and RC-3. If you operate this Player by remote control along with another SHARP Blu-ray Disc Player or DVD Player placed next to it simultaneously, switching the remote control code (both the Player and remote control) to one of the signals (RC-1, RC-2 or RC-3) will let you operate only with this Player.
- Make sure to set the Player and remote control to the same remote code. You can not operate the Player if they are not set to the same code.

## Setting the Remote Control Code of the Remote

**Example:** Setting the code to "RC-3".

- 1** Press and hold **3** first and then **POWER** on the remote control together for more than 5 seconds.
- 2** Press **POWER** (on the player) to turn off the player.

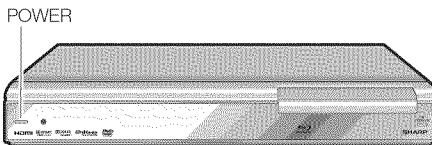

## Setting the Remote Control Code of the Player

- 3** Point the remote control at the player, then press and hold the **DISPLAY** button for more than 10 seconds.

Remote control sensor



- 4** Press **POWER** (on the remote control) to turn on the player.

## Operating a SHARP TV Using the Remote Control

The Universal Remote Control may operate the basic functions of the SHARP TV.

### TV function control

- TV Power: POWER
- TV Channel up/down: CH  $\wedge/\vee$
- TV Volume up/down: VOL +/-
- TV-AV Selector: INPUT

# Before Starting Playback

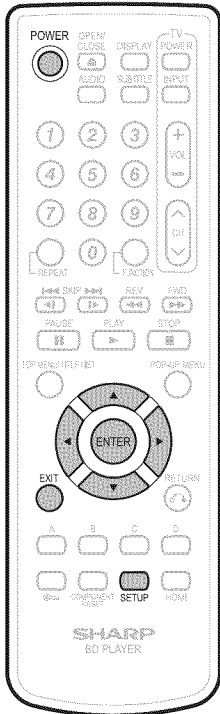

## Turning the Power On

### Turning the power on

Press **POWER** on the remote control or on the Player to turn on the power of the Player.



### Entering standby

Press **POWER** on the remote control or on the Player to enter standby.



- If you press **POWER** again immediately after entering standby, the Player may not turn on. If this happens, wait for 10 seconds or more and then turn on the power again.

#### NOTE

- When the STANDBY indicator is blinking (may take some time), the Player cannot be turned on.

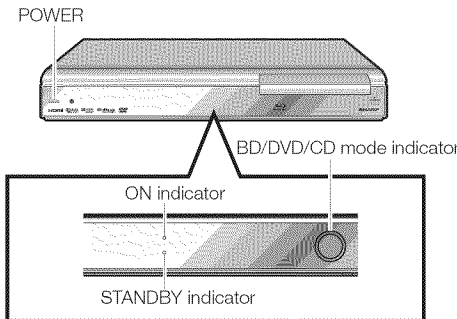

## Indicators on the Player

### ON indicator

Green on	Power on
----------	----------

### STANDBY indicator

Red blinks	Preparing for standby
Red on	Standby

### BD/DVD/CD mode indicator

Off	No disc
Blue on	Playing back
White on	Disc stopped
White blinks	Loading a disc

- When you turn on the **POWER**, the **MENU** screen automatically displays for a while. Press **EXIT** to erase the display.

## Language Setting

### Changing the on-screen display language

- 1 Press **SETUP** to display the **SETUP MENU** screen.



- 2 Press **▲/▼/◀/▶** to select "ON SCREEN LANGUAGE", then press **ENTER**.

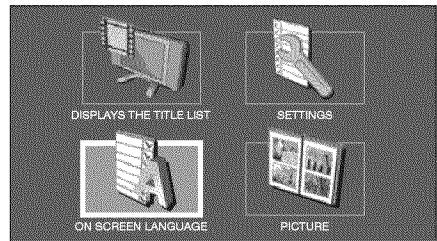

- 3 Press **▲/▼** to select the language you want to display on the screen, then press **ENTER**.

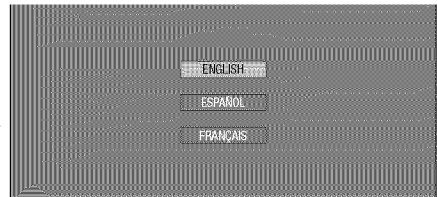

#### NOTE

- To select the DVD disc language, such as subtitle language, etc., see page 25.

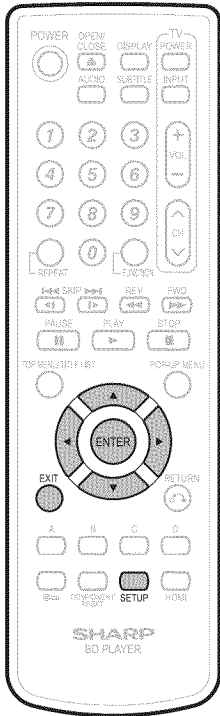

## Turning Off the LCD Backlight and Indications

If you feel that the indicators on the Player are too bright when watching movies, you can turn them off except for the ON indicator.

- 1 Press **SETUP** to display the SETUP MENU screen.
- 2 Press **▲/▼/◀/▶** to select "SETTINGS", then press **ENTER**.
- 3 Press **▲/▼** to select "FRONT DISPLAY/LED", then press **ENTER**.

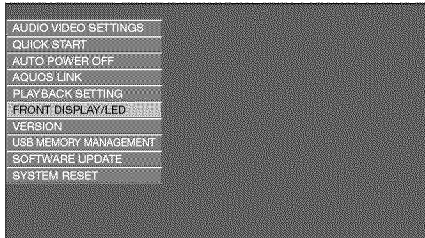

- 4 Press **◀/▶** to select "ON" or "OFF", then press **ENTER**.
- 5 Press **SETUP** or **EXIT** to exit.

## Using AQUOS LINK

### Controlling the Blu-ray disc player using AQUOS LINK

#### What is AQUOS LINK?

Using the HDMI CEC (Consumer Electronics Control), with AQUOS LINK you can interactively operate this player with your SHARP AQUOS TV.

#### What you can do with AQUOS LINK

When you connect this player to the LCD TV compatible with AQUOS LINK using an HDMI cable, you can perform the function listed below. (See page 15 for connecting to the HDMI terminal).

#### Playback function turns on the LCD TV immediately.

When you start to playback of this player, Power of LCD TV will be turned on and the playback image will appear on the screen.

#### Automatic input select function

When you start playback of this player, the input selector of the LCD TV will automatically switch to the LCD TV input terminal connected to the player and the playback image will appear on the screen, even if you are watching a TV program.

#### Automatic power off function

If you turn off the LCD TV when this player is in stop mode, the power of this player will be turned off automatically. (In the case, while playing back a disc, the power does not turn off.)

#### Automatic power on function

When you switch to the LCD TV input terminal connected to this player, the power of this player will be turned on automatically.

#### NOTE

- In order to make AQUOS LINK available, set up AQUOS LINK on the LCD TV that is connected to this player. See page 36 regarding the setup of this player.  
Refer to the Operation Manual of the TV for details regarding setup.



# BD/DVD/CD Playback

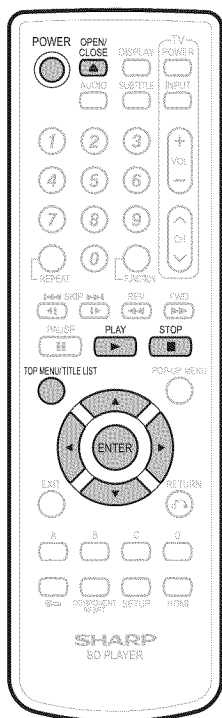

This section explains playback of commercially available BD Video and DVD Video discs (like movies), CDs, and recorded DVD-RW/R discs.

## Loading a Disc

- 1 Press **POWER** to turn on the power.
- 2 Press **OPEN/CLOSE** to open the disc tray.

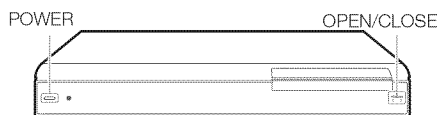

- 3 Load a disc on the disc tray.
  - Insert the disc with the label face up.
  - In case of disc recorded on both sides, face down the side to play back.

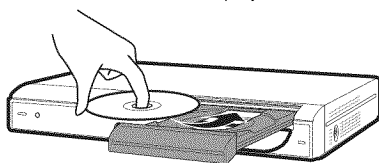

- 4 Press **OPEN/CLOSE** to close the disc tray.

## BD/DVD Video Playback

**BD VIDEO** **DVD VIDEO** **BD-RE** **BD-R**

- 1 Load a disc.
  - Playback may begin automatically, depending on the disc.
- 2 Press **▶ PLAY**.
  - Playback begins from the first title.
  - The menu may be displayed first, depending on the disc. Perform playback operation by following the directions on the screen.

**NOTE**  
• The disc load time may vary depending on the disc.

## To stop playback

Press **■ STOP**.

## Resume playback function

- If you press **▶ PLAY** next, playback will resume from the point where the Player was previously stopped. To playback from the beginning, cancel resume mode by pressing **■ STOP**, then press **▶ PLAY**. (This may not work depending on the type of disc. In this case, open the disc tray or enter standby.)

**NOTE**  
• Resume playback may not function depending on the disc.

## BD/DVD Menu

- This section explains how to play back a BD/DVD video disc with a top menu, disc menu or pop-up menu.
- The titles listed in the top menu and a disc guide (for options like subtitles and audio languages) are given in the disc menu.

## Start playback by selecting a title from the top menu

**BD VIDEO** **DVD VIDEO**

- 1 Press **TOP MENU/TITLE LIST**.
  - The top menu screen is displayed.

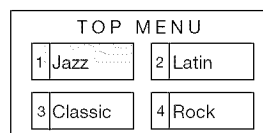

- 2 Press **▲/▼/◀/▶** to select the title, then press **ENTER**.
  - The selected title is played back.

**NOTE**  
• The procedure explained on this page is the basic operation procedure. Procedures vary depending on the BD/DVD video disc, so you may need to follow the instructions in the BD/DVD video disc manual or the instructions displayed on the screen.  
• A top menu is not displayed for a DVD-RW/R (Video format) if it has not been finalized.

## Top menu

- With some BD/DVD discs, the top menu may be referred to as the "Title Menu". Use **TOP MENU/TITLE LIST** on the remote control when the instructions refer to "Title Menu".
- If no top menu is available, the **TOP MENU/TITLE LIST** button will have no effect.

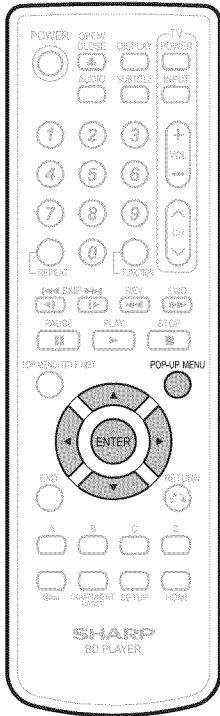

## Using the disc menu

### DVD VIDEO

**Example:** Select "SUBTITLE LANGUAGE".

- 1 Press **POP-UP MENU**.
  - The disc menu screen is displayed.
- 2 Press **▲/▼** to select "SUBTITLE LANGUAGE", then press **ENTER**.
  - The screen for selecting the subtitle language is displayed.

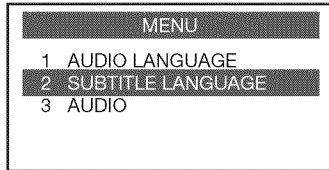

- 3 Press **▲/▼** to select the subtitle language, then press **ENTER**.
- 4 Press **POP-UP MENU** to exit.

## Using the pop-up menu

### BD VIDEO

- 1 Press **POP-UP MENU** during playback.
  - The pop up menu screen is displayed.
  - The menu contents displayed vary depending on the disc. For details on how to see and operate the pop-up menu, refer to the manual for the disc.

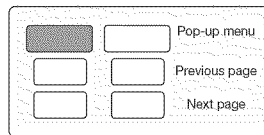

- 2 Press **▲/▼/◀/▶** to select the desired item, then press **ENTER**.
- 3 Press **POP-UP MENU** to exit.
  - The pop-up menu will automatically disappear for some discs.

## BONUSVIEW

### Use of Picture in Picture function (secondary audio/video playback)

#### BD VIDEO

BD-Video that includes secondary audio and video compatible with Picture in Picture can be played back with secondary audio and video simultaneously as a small video in the corner.



Primary audio/video

Secondary audio/video

- The secondary audio and video for Picture In Picture may automatically play back and be removed depending on the content. Also, playable areas may be restricted.

## Virtual Package

#### BD VIDEO

Some BD-Video discs are compatible with a function where data is copied to local storage (USB memory device, etc.) and played back along with the primary video as secondary video, secondary audio, subtitles, etc. This function is called Virtual Package. Virtual Package data is automatically copied to the local storage prior to playback. The playback methods vary depending on the disc. A variety of functions can be enjoyed during playback of BD-Video compatible with Virtual Package, which features data copied to the BD Local Storage separate from the BD Disc. This player uses a USB memory device for Local Storage.

Connect a USB memory device (USB2.0 256MB or greater) to the BD STORAGE/SERVICE terminal (page 12) on the back of this player.

- See the disc manual for required storage space and instructions on copying/playback.

#### NOTE

- If there is insufficient storage space, the data will not be copied. Delete unneeded data or use a new USB memory device.
- If a USB memory device containing other data (previously recorded) is used, the video and audio may not play back properly.
- If the USB memory device is disconnected from this player during playback of Virtual Package, playback of the disc will stop.
- Some time may be required for the data to load (read/write).

See page 38 for deletion of the Virtual Package data copied to the USB memory device.

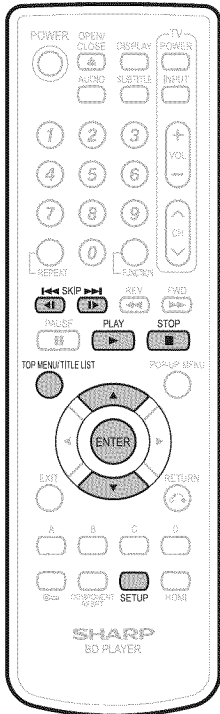

## DVD-R/-RW Playback

**DVD-R** | **DVD-RW**

You can play back a recorded disc (finalized disc only).

### Playback from the beginning

- 1 Load a recorded disc.
- 2 Press **▶ PLAY**.
  - Playback begins from title 1.

### Playback by selecting a title

- 1 Load a recorded disc.
- 2 Press **TOP MENU/TITLE LIST**.
  - The TITLE LIST screen is displayed.

#### NOTE

- If the TITLE LIST is not displayed, perform step 2 again after starting and then stopping playback.

- The TITLE LIST screen also can be displayed by pressing **ENTER** after choosing **"DISPLAYS THE TITLE LIST"** in SETUP MENU

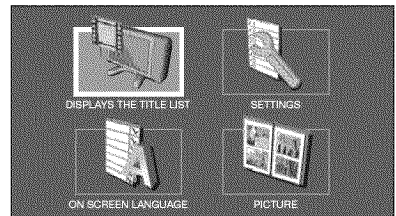

- When more than seven titles are displayed, switch pages by pressing **◀◀ SKIP/◀** or **▶▶ SKIP/▶**.

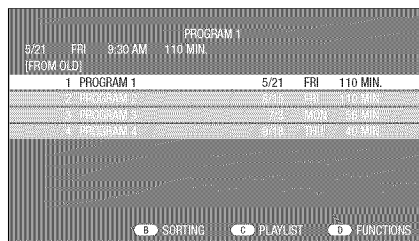

Information of selected title

Title Name  
Recording Date  
Recording Duration

Caption for Color Button

- 3 Press **▲/▼** to select the title, then press **ENTER**.
  - Playback of the selected title will begin.
  - You can playback by pressing **▶ PLAY** instead of pressing **ENTER**.
- 4 Press **■ STOP** to stop playback.

#### NOTE

- "Finalize" refers to a recorder processing a recorded disc so that it will play in other DVD players/recorders as well as this player. Only finalized DVD discs will play back in this player. (This player does not have a function to finalize discs.)

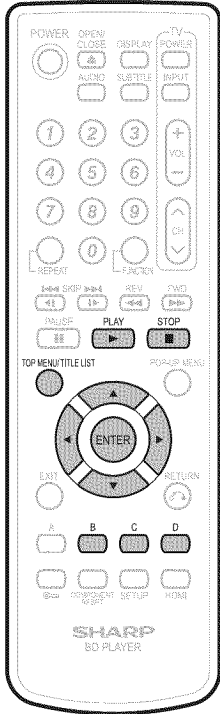

## Playback by selecting a PLAY LIST

- 1 Load a recorded disc.
- 2 Press **TOP MENU/TITLE LIST**.
  - The TITLE LIST screen is displayed.
- 3 Press **C (Blue)**, then press **ENTER**.
  - The PLAY LIST screen is displayed.

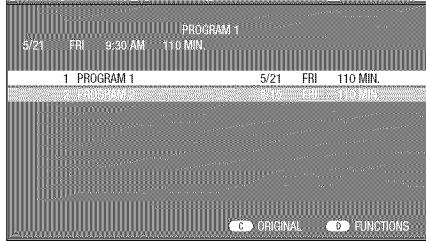

- 4 Press **▲/▼** to select the title, then press **ENTER**.
  - Playback of the selected title will begin.
- 5 Press **■ STOP** to stop playback.

## Sorting the titles

- 1 Press **B (Green)**, then press **ENTER** while the TITLE LIST screen is displayed.
- 2 Select the type of sorting by pressing **▲/▼**, then press **ENTER**.

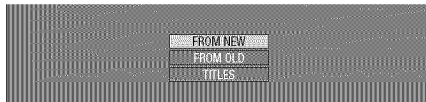

- The displayed titles are rearranged by selected sorting type.

## Playing back the title you stopped while being played.

- 1 Press **D (Yellow)** while the TITLE LIST screen is displayed.

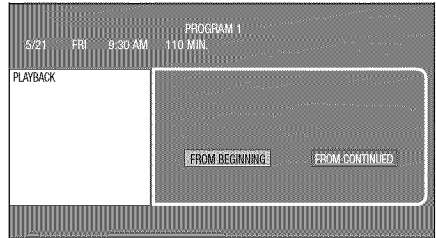

- 2 Press **◀/▶** to select the type of Playback, then press **ENTER**.
  - Playback of the title will begin.

### NOTE

- "Finalize" refers to a recorder processing a recorded disc so that it will play in other DVD players/recorders as well as this player. Only finalized DVD discs will play back in this player. (This player does not have a function to finalize discs.)

## Audio CD Playback

### AUDIO CD

## Playback from the beginning

- 1 Load an audio CD.
- 2 Press **▶ PLAY**.
  - Playback begins from the first track.
- 3 Press **■ STOP** to stop playback.

# Playback Functions

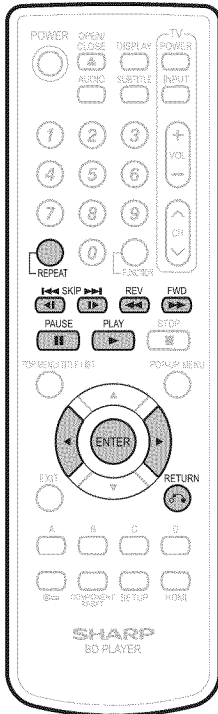

BD VIDEO    BD-R    BD-RE  
 DVD VIDEO    DVD-R    DVD-RW  
 AUDIO CD

## NOTE

- Some operations in the following playback functions cannot be performed depending on the specifications of the disc.

## Fast Forward/Reverse (Search)

Fast Forward/Reverse functions when **◀◀ REV** or **▶▶ FWD** is pressed during playback.

**Example:** When **▶▶ FWD** is pressed

- The search speed will cycle as follows each time you press the button.

### When playing back a DVD

- You cannot fast forward or fast reverse from one title and continue to another title (except when playing audio CDs).

## Skipping to the Next or the Start of the Current Chapter (Track)

Skipping (to the beginning of a chapter or track) functions when **◀◀ SKIP/◀** or **▶▶ SKIP/▶** is pressed during playback.

## Pause/Frame Advance Playback

- Pause functions when **⏸ PAUSE** is pressed during playback. (If you are playing back an audio CD, the CD will also pause.)
- Frame Advance Playback functions when **▶▶ SKIP/▶** is pressed during Pause.
- Frame Advance Playback may not function properly with discs other than DVD-RW (VR format).
- Some BD/DVD Video discs are not compatible with Pause/Frame Advance Playback.

## NOTE

- Frame Advance/Reverse Playback can be performed for DVD discs by pressing **▶▶ SKIP/▶** or **◀◀ SKIP/◀** during pause.

## Slow Playback

Slow Playback functions when **▶▶ SKIP/▶** or **◀◀ SKIP/◀** is pressed more than 2 seconds during pause.

- Press **▶ PLAY** to return to normal playback.

## NOTE

- This doesn't work for audio CDs.
- Reverse Slow Playback cannot be performed for BD video.

## Repeat Playback of a Title or Chapter (Repeat Playback)

- 1 Play back the title or chapter you want to repeat.
- 2 Press **REPEAT**.
- 3 Press **◀/▶** to select the type of Repeat Playback.
  - **PLAYBACK TITLE:** Repeats the title currently being played back.
  - **PLAYBACK CHAPTER:** Repeats the chapter currently being played back.
  - **SCENE SELECTION:** Repeats the specified scene of title or chapter.

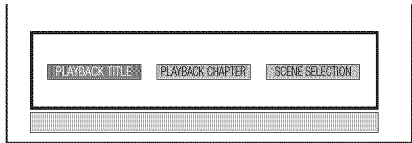

- Press **⏪ RETURN** to cancel without setting the type of Repeat Playback.
- For Audio CD, you can select "PLAYING DISC", "PLAYING TRACK" and "SPECIFY THE PART" as Repeat Playback options.

- 4 Press **ENTER**.

**Example:** Repeat playback of a title (TITLE)

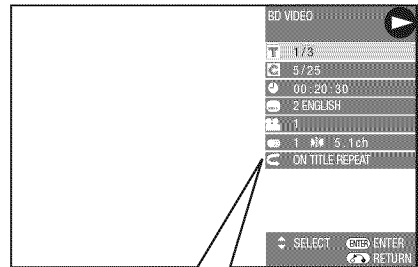

**◀ ON TITLE REPEAT**

- 5 Press **REPEAT** to return to normal playback.

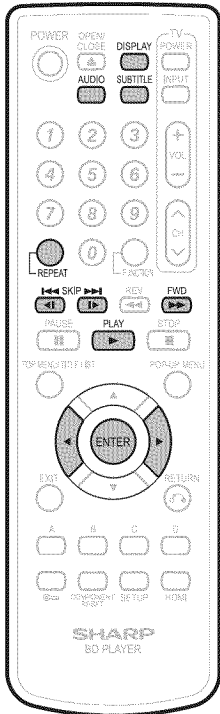

## Partial Repeat Playback (Repeat Playback of a Specified Part)

DVD VIDEO DVD-R DVD-RW  
AUDIO CD

### NOTE

- Some operations in the following playback function cannot be performed depending on the specifications of the disc.

- 1 Press **REPEAT** during playback.
- 2 Press **◀▶** to select "SCENE SELECTION", then press **ENTER**.

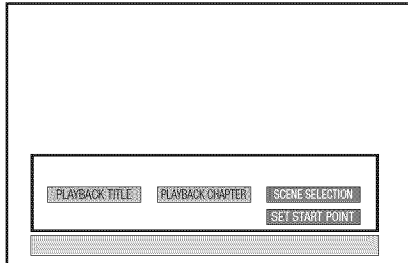

- 3 "SET START POINT" displays. Press **ENTER** at the scene where you want.
  - "SET END POINT" displays.
- 4 Press **ENTER** at the scene where you want to set the end point.
  - You can press **▶▶ FWD** to fast forward to the scene where you want to set the end point. When you reach the desired scene, simply press **▶ PLAY** and then **ENTER** to set the end point. To cancel Repeat Playback, press **REPEAT**.

### NOTE

- Press **▶▶▶ SKIP/▶**, the Repeat Playback is cancelled and the next chapter being play back.
- Press **◀◀◀ SKIP/◀** once, the Repeat Playback is cancelled and the player returns to the start of current chapter (track).
- If you press **◀◀◀ SKIP/◀** again (within about 5 seconds) the player will skip to the beginning of the previous chapter (track).
- For Partial Repeat Playback, set the start and end points within the same title.
- Repeat Playback may be forbidden depending on the disc.
- Partial Repeat Playback may not work in multi-angle scenes.
- If you press **DISPLAY**, you can confirm the Repeat Playback status.

## Switching Audio

You can change the audio output channel using **AUDIO**.

Each time **AUDIO** is pressed, the audio channels change as follows:

BD VIDEO DVD VIDEO

The audio track currently being played back will be displayed.

DVD-RW DVD-R

**When a recorded broadcast with stereo or monaural audio is played back:**

"Stereo" is displayed. (Audio cannot be switched.)

### NOTE

- When you play a program recorded in stereo or monaural, and if you are listening to the BITSTREAM sound via the digital output jack, you cannot select the audio channel. Set "AUDIO OUT" to "PCM" (Page 35), or if you want to change the audio channel, listen via the analog output jacks.

## Switching Subtitles

If subtitles are provided in multiple languages, you can switch between them.

Press **SUBTITLE** during playback.

- The display indicates the subtitle number currently being played back, and the subtitles appear. Each time **SUBTITLE** is pressed, the subtitles change.
- "--" is displayed if a disc has no subtitles.
- You can also select "OFF".

# Playback Functions

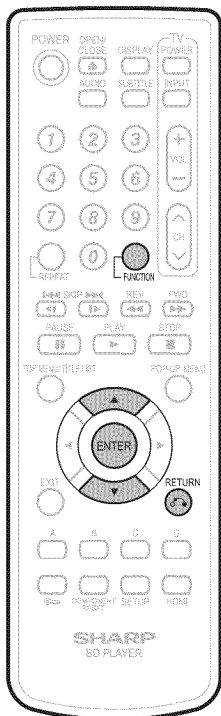

## Switching the Angle

If multiple angles are recorded, you can switch between them.

- 1 Press **FUNCTION** during playback.
  - The Function Control screen is displayed on the TV.

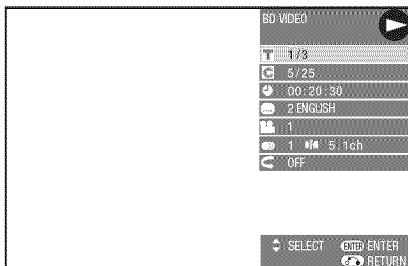

- 2 Press **▲/▼** to select the Angle Number column, then press **ENTER**.

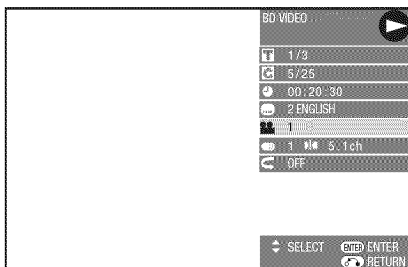

- 3 Press **▲/▼** to select the desired Angle Number, then press **ENTER**.
  - “-” is displayed if a disc is recorded with only one angle.

- 4 Press **RETURN** or **FUNCTION** to close the Function Control screen.

### NOTE

- The displayed items vary depending on the disc.
- If you access the Function Control screen during playback of a BD/DVD video, it may be impossible to operate the BD/DVD video playback. In cases like this, close the Function Control screen.

## Displaying the Angle Mark

You can change settings so that Angle Mark appears in the right bottom part of the screen when multiple angles are recorded. (The Angle Mark is only displayed for DVD video.) The settings can be changed in “SETTINGS” - “PLAYBACK SETTING” - “ANGLE MARK DISPLAY” (Page 36).

### NOTE

- Settings for audio and subtitles can be changed also in Function Control Screen (Page 32).
- The operations of subtitles, angle and audio differ according to each disc. You may need to refer to the operation manual of the disc.
- The following operations will not work when playing back an audio CD:
  - Slow Playback, Frame Advance

### Display of functions

- The display for subtitles, angle or audio automatically disappears after 5 seconds.

### Switching between functions

- You can switch the subtitles and audio at the Function Control screen (Page 32).
- The operation for each function varies depending on the disc. See the manual for the disc.

### Fast Forward/Reverse

- You cannot perform Fast Forward/Fast Reverse between titles. At the end or beginning of the title, Fast Forward/Fast Reverse will be cancelled and normal playback will automatically resume.
- Subtitles are not played back with BD/DVD video discs during Fast Forward and Fast Reverse.
- Depending on the disc and the scene being played back, the Player may not operate at the speed listed in this manual when performing Fast Forward.

### Slow Playback

- You cannot perform Slow Playback between titles. At the end of the title, Slow Playback will be cancelled and normal playback will automatically resume.

### Repeat Playback

- Repeat Playback may be forbidden depending on the disc.
- Partial Repeat Playback may not work in multi-angle scenes.
- For Partial Repeat Playback, set the start and end points within the same title.

# JPEG File Playback

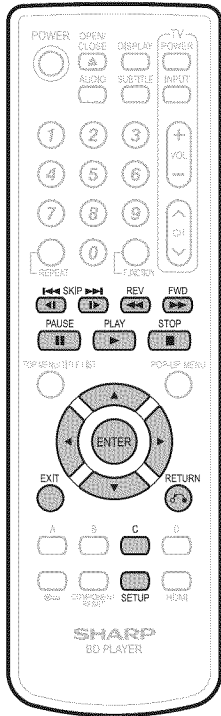

CD-R JPEG CD-RW JPEG

## NOTE

- This Player can play still images (JPEG files) that have been recorded on CD-RW/R discs. For details on the still images that you can play using this player, refer to "About the JPEG file format" on page 8.
- During "Normal play", still images are played one by one while during "Slide show", they are automatically replaced one after another.

## Playing back still images in sequence

- Load the disc containing the still images, and press **▶ PLAY**.
  - The first still image appears on the screen.
  - Press **◀◀ SKIP/◀** or **▶▶ SKIP/▶** to proceed to the next or previous still image. The same operation can be performed by pressing **◀▶** or **◀◀ REV/▶▶ FWD**.
- To stop the still image playback at any time, press **■ STOP**.

## Playing back still images in a selected folder

- Load the disc containing still images, then press **SETUP**.
- Press **▲/▼/◀/▶** to select "PICTURE", then press **ENTER**.

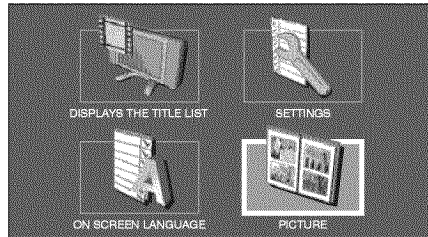

- Use **▲/▼/◀/▶** to select the folder whose still images are to be played, then press **ENTER**.

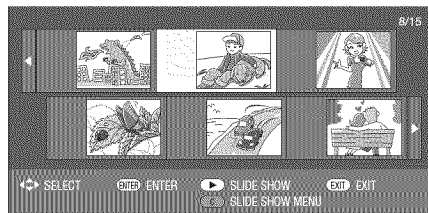

- Press **◀◀ SKIP/◀** or **▶▶ SKIP/▶** to replace one image with another.
  - The same operation can be performed by pressing **◀▶** or **◀◀ REV/▶▶ FWD**.
  - Press **↻ RETURN** if you wish to return to the folder selection screen.
- To stop the still image play at any time, press **■ STOP**.

## Playing back Slide Show

- In Step 2 of the left side "Playing back still images in a selected folder", press **▶ PLAY (SLIDE SHOW)**.
  - The still images inside the selected folder are played as a slide show.
- To pause the playback at any time, press **|| PAUSE**.
  - Press **▶ PLAY** to resume playback.
- To stop the play at any time, press **■ STOP**.
  - Press **↻ RETURN** to play a slide show of still images in another folder.

## Setting slide show speed/repeat playback

- Press **C (Blue) (SLIDE SHOW MENU)** during the folder selection screen.
  - The setting screen for SLIDE SHOW SPEED/ REPEAT MODE SETTING appears.
- Press **▲/▼** to select the SLIDE SHOW SPEED, then press **ENTER**.

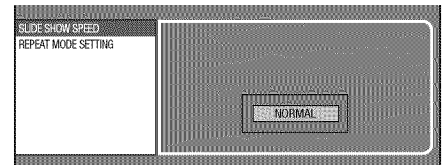

- The slide show speed may be selected from "FAST", "NORMAL", "SLOW1" and "SLOW2".
- Press **▲/▼** to select the desired speed, then press **ENTER**.
  - Press **▲/▼** to select the REPEAT MODE SETTING, then press **ENTER**.

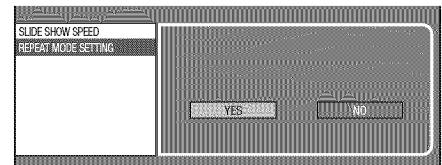

- Press **◀/▶** to select the desired item, then press **ENTER**.
- Press **EXIT** to exit.

3

Disc Playback



# Settings During Playback

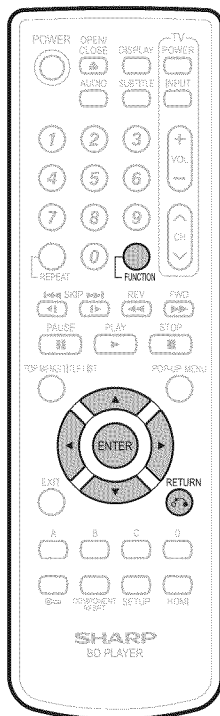

## Function Control

This allows you to adjust various settings at once, like subtitles, angle settings and the title selection for Direct Playback. You can adjust the video and audio to suit your preferences. The operations are the same for BD and DVD.

### Function control screen

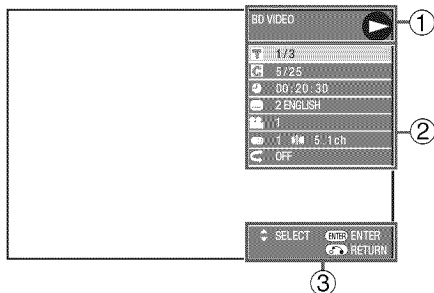

#### ① Playback status display

Shows the operation status and the disc type.

#### ② Setting items

Selects a title or chapter for playback, or performs video/audio settings.

- Title Number (Direct Title Skip)
- Chapter Number (Direct Chapter Skip)
- Playback Elapsed Time (Direct Time Skip)
- Subtitle Language
- Angle Number
- Audio
- Repeat

#### ③ Operation guide display

Provides help on remote control button operations.

## Function control operation procedure

### 1 Press **FUNCTION** during playback.

- The Function Control screen is displayed on the TV.

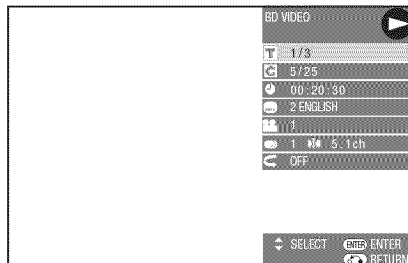

### 2 Press **▲/▼** to select the desired setting, then press **ENTER**.

- For a description of each setting, see "Functions which can be set" (Page 33).

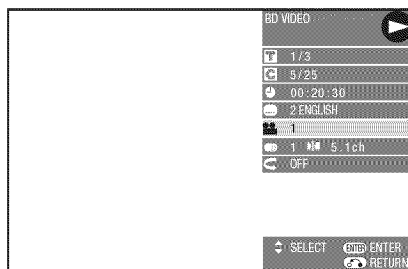

### 3 Press **▲/▼/◀/▶** to set, then press **ENTER**.

- Operations vary depending on the setting. Follow the operation instructions on the screen.

### 4 Press **○** **RETURN** or **FUNCTION** to close the Function Control screen.

#### NOTE

- If "—" is displayed for an option like title number or subtitles, the disc has no titles or subtitles which can be selected.
- The displayed items vary depending on the disc.
- If you access the Function Control screen during playback of a BD/DVD video, it may be impossible to operate the BD/DVD video playback. In cases like this, close the Function Control screen.

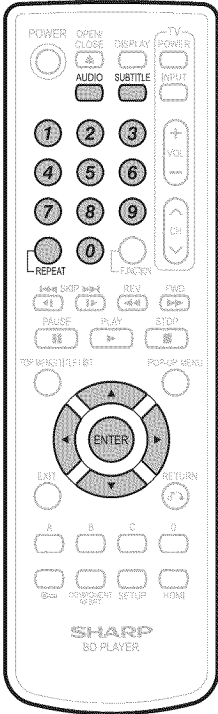

## Functions which can be set

### Title Number (Direct Title Skip)

- Shows the title number being played back. You can skip to the start of the title.
- To skip to the start of a selected title, press the **Number** buttons to enter the title number when this option is highlighted.

### Chapter Number (Direct Chapter Skip)

- Shows the chapter number being played back. You can skip to the start of the chapter.
- To skip to the start of a selected chapter, press the **Number** buttons to enter the chapter number when this option is highlighted.

### Playback Elapsed Time (Direct Time Skip)

- Shows the elapsed time from the beginning of the disc to the present. This lets you skip to a specific time.
- Press **◀▶** to select the Hour, Minute or Second, then press **▲▼** or the **Number** buttons to set the time. Press **ENTER** to start playback at the set time.

### Subtitle Language

- Shows the currently selected subtitle language. If subtitles are provided in other languages, you can switch to your preferred language.

### Angle Number

- Shows the currently selected angle number. If the video is recorded with multiple angles, you can switch the angle.

### Audio

- Shows the currently selected type of audio. You can select the desired type of audio.

### Repeat

- The current Title (or Chapter) or partial segments can be repeatedly played back. Repeat Playback is also possible with the **REPEAT** button on the remote control.

### NOTE

- These functions may not work with all discs.

# SETTINGS

## Common operations

The "MENU" enables various audio/visual settings and adjustments on the functions using the remote control unit. You need to call up the OSD to perform settings for this player. The following is the explanation for the basic operations of the "MENU".

**Example:** Setting "FRONT DISPLAY/LED"

**1** **Display the MENU Screen**

Press **SETUP** to display the SETUP MENU screen.  
Press **▲/▼/◀/▶** to select "SETTINGS", then press **ENTER**.

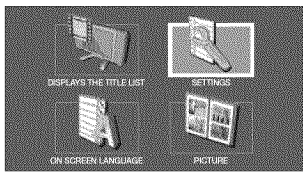

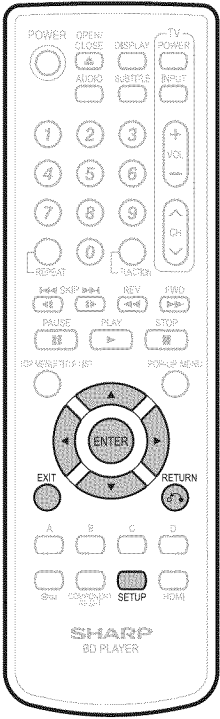

**3** **Select the next item**

Press **◀/▶** to select the desired item, then press **ENTER**.

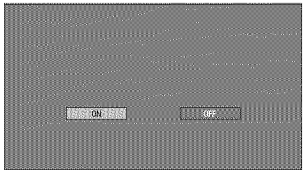

Press **◀** **RETURN** to return to the previous "MENU" page.

**2** **Select a menu item**

Press **▲/▼** to select "FRONT DISPLAY/LED", then press **ENTER**.

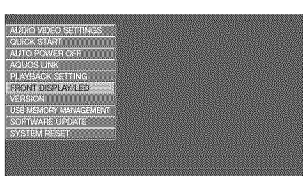

**4** **Exit the MENU screen**

Press **SETUP** or **EXIT** to exit.

## Basic Operation for PLAYBACK SETTING

**Example:** Setting "PARENTAL CONTROL" under "PLAYBACK SETTING".

- 1** Press **SETUP** to display the SETUP MENU screen.
- 2** Press **▲/▼/◀/▶** to select "SETTINGS", then press **ENTER**.
- 3** Press **▲/▼** to select "PLAYBACK SETTING", then press **ENTER**.

**When setting the password for the first time.**

- 1** Press **◀/▶** to select "YES" to enter the password setting menu, then press **ENTER**.
- 2** Enter the 4-digit number.
- 3** Press **ENTER** to move to the next setting screen.
- 4** Press **▲/▼** to select "PARENTAL CONTROL", then press **ENTER**.

- 5** Enter your 4-digit password.
  - You cannot move to the next setting screen until you can input the correct password.



- 6** Press **◀/▶** to select the parental control level for DVD video, BD-ROM, and then select the country code. Press **ENTER** after making each selection.

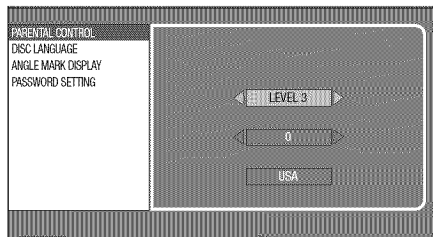

- 7** Press **SETUP** or **EXIT** to exit.

## AUDIO VIDEO SETTINGS

### TV ASPECT RATIO

You can set the screen aspect ratio of the connected TV, and adjust the video output.

If you switch your TV (i.e. because you have bought a new one) and the screen aspect ratio of the connected TV changes, you will have to change the "TV ASPECT RATIO" setting.

#### Item

**WIDE 16:9:** Select this when connecting to a TV with a 16:9 screen aspect ratio.  
**NORMAL 4:3:** Select this when connecting to a TV with a 4:3 screen aspect ratio.



<When selecting **NORMAL 4:3**>

#### Item

**LETTER BOX:** If you connect to a TV with a screen aspect ratio of 4:3 and playback a DVD with 16:9 video, the video will be played back with black bands at the top and bottom while maintaining the 16:9 ratio.  
**PAN SCAN:** If you connect to a TV with a screen aspect ratio of 4:3 and playback a DVD with 16:9 video, the video will be played back with the left and right sides of the image cut off to display in 4:3 screen aspect ratio. (This function works if the disc is labelled for 4:3PS.)

### COMPONENT VIDEO OUT

This sets the resolution of the component video output. Some TV are not fully compatible with the Blu-ray disc player, which may cause the image distortion. In this case, press **COMPONENT RESET** on the remote control for five seconds. Component video out will be reset to 480i (factory preset value).

#### Item

1080i, 720p, 480p, 480i

#### CAUTION

- HDMI output and Component video output can not be used at the same time.

### HDMI VIDEO OUT

This sets the resolution of the HDMI video output.

#### Item

AUTO, 1080p, 1080i, 720p, 480p

#### CAUTION

- HDMI output and Component video output can not be used at the same time.

#### NOTE

- When the BD player is connected to a 1080p 24Hz compatible TV and the HDMI VIDEO OUT is set to AUTO, 1080p 24Hz will automatically be displayed when compatible discs are played back.  
At this time, there is no output from the COMPONENT VIDEO OUT jacks and VIDEO output jack.

### HDMI AUTO DETECTION

This function enables the video output to switch to HDMI automatically when the player detects a TV connected with an HDMI cable.

#### Item

YES, NO

### SECONDARY AUDIO

This toggles the clicking sound on the menu and audio with secondary video in picture in picture mode for BD-Video.

- Select "OFF" when enjoying the high quality sounds of BD-Video.

#### Item

ON, OFF

### AUDIO OUT

You can set AUDIO OUT when connecting to SURROUND equipment.

- This sets the audio output connected to SURROUND equipment.

#### Item

**HDMI OUTPUT:** Select this when you connect using HDMI OUT terminal.  
**DIGITAL OUTPUT:** Select this when you connect using DIGITAL AUDIO OUT terminal (OPTICAL).  
**2ch AUDIO OUTPUT:** Select this when you do not use SURROUND sound equipment.

- You can set the audio output mode for each output terminal.

- This sets the audio output mode for HDMI OUT terminal when selecting **HDMI OUTPUT**.

#### NOTE

- When the secondary audio is set to "ON", PCM is automatically selected as the audio output mode.

#### Item

**BITSTREAM:**

- Select this when connecting to HDMI equipment with a built-in decoder for DOLBY DIGITAL, etc.
- Setting to BITSTREAM will output each audio signal by BITSTREAM.

**PCM (SURROUND):**

- Select this when connecting to multi-channel HDMI equipment.
- Setting to PCM (SURROUND) will output by LINEAR PCM by decoding audio signals recorded in each audio output mode such as DOLBY DIGITAL, DTS.

- This sets the audio output mode for DIGITAL AUDIO OUT (OPTICAL terminal) when selecting **DIGITAL OUTPUT**.

#### Item

**BITSTREAM:**

- Select this when connecting to SURROUND equipment with a built-in decoder for DOLBY DIGITAL, etc.
- Setting to BITSTREAM will output each audio signal by BITSTREAM.

**PCM:**

- Select this when connecting to 2 channel stereo audio equipment.
- Setting to PCM will output by converting each audio signal into PCM 2 channel audio signal.

#### NOTE

- See page 37 for information on output of next generation audio formats.

# SETTINGS

## DYNAMIC RANGE CONTROL

This lets you adjust the range between the loudest and softest sounds (dynamic range) for playback at average volume. Use this when it is hard to hear dialog.

### Item

**NORMAL:** The same audio output range is played as the original recorded audio output range.

**SHIFT\*:** When Dolby Digital audio is played back, the dynamic range of the audio is adjusted so that the dialog portion can be heard easily. (If the audio sounds abnormal, set to "NORMAL".)

**AUTO:** When you play back audio in the Dolby TrueHD format, the dynamic range is automatically adjusted.

- \* Lower the audio volume before setting. If you do not do so, the speakers may emit a loud sound or excessive output may be applied to the speakers.

## QUICK START

This turns the QUICK START function on and off. When the QUICK START function is on:

- The startup time of the Player is reduced when resuming playback from standby.
- However, power consumption will increase.

### Item

YES, NO

### NOTE

- When "QUICK START" is set to "YES", the Player requires some time to turn off.

## AUTO POWER OFF

This sets the Player so that power is automatically shut off if playback is stopped for about 10 minutes.

### Item

YES, NO

## AQUOS LINK

This lets you set the Player to receive the control signal from the AQUOS LINK remote control via the HDMI cable.

### Item

YES, NO

### NOTE

- For details, refer to the operation manual of TV.

## PLAYBACK SETTING

### PARENTAL CONTROL

This lets you set the Parental Control depending on the disc content. The available Parental Control Levels are shown below.

The 4-digit password number needs to be entered before the Parental Control Levels and the Country Code are set. The Parental Control Levels and the Country Code cannot be set if a password has not been created or the password is not entered.

#### Item (For DVD-video)

8 and OFF: All DVD-video can be played.

1-7: Prohibits play of DVD-video with corresponding ratings recorded on them.

#### Item (For BD-ROM)

NO LIMIT: All BD-video can be played.

0-99 year(s): Prohibits play of BD-video with corresponding ratings recorded on them.

#### Item (COUNTRY CODE)

Sets the Country Code. Refer to the Country Code List (page 37) because the ratings differ according to the country.

### NOTE

- Refer to "Basic Operation for PLAYBACK SETTING" on page 34 for details.

### DISC LANGUAGE (DISC PRIORITY LANGUAGE)

This lets you select the language for subtitles, audio and menus displayed on the screen.

#### Item (SUBTITLE)

Refer to the Language Code List. (Page 37)

#### Item (AUDIO)

Refer to the Language Code List. (Page 37)

#### Item (MENU)

Refer to the Language Code List. (Page 37)

### ANGLE MARK DISPLAY

This lets you turn the Angle Mark Display on or off when DVD video recorded with multiple angles is played back. (The Angle Mark is displayed in the lower right screen.)

#### Item

YES, NO

### PASSWORD SETTING

This sets the password for setting or changing the Parental Control Level.

#### Item

YES: Enter the 4 digit number.  
NO

### NOTE

- When you forget the password, you can reset the current password using SYSTEM RESET under SETTINGS. (See page 37.)
- You can also set the new password if desired.

## FRONT DISPLAY/LED

If you feel that the indicators on the Player are too bright when watching movies, you can turn them off except for the ON indicator.

Item

ON, OFF

## VERSION

When you select "VERSION", the system software version is displayed.

## SYSTEM RESET

You can reset all settings to the factory presets.

Item

RESET, NOT RESET

## Country Code List

USA / CANADA / JAPAN / GERMANY / FRANCE / UK / ITALY / SPAIN / SWISS / SWEDEN / HOLLAND / NORWAY / DENMARK / FINLAND / BELGIUM / HONG KONG / SINGAPORE / THAILAND / MALAYSIA / INDONESIA / TAIWAN / PHILIPPINE / AUSTRALIA / RUSSIA / CHINA

## Language Code List

**AA** Afar / **AB** Abkhazian / **AF** Afrikaans / **AM** Ameharic / **AR** Arabic / **AS** Assamese / **AY** Aymara / **AZ** Azerbaijani / **BA** Bashkir / **BE** Byelorussian / **BG** Bulgarian / **BH** Bihari / **BI** Bislama / **BN** Bengali, Bangla / **BO** Tibetan / **BR** Breton / **CA** Catalan / **CO** Corsican / **CS** Czech / **CY** Welsh / **DA** Danish / **DE** German / **DZ** Bhutani / **EL** Greek / **EN** English / **EO** Esperanto / **ES** Spanish / **ET** Estonian / **EU** Basque / **FA** Persian / **FI** Finnish / **FJ** Fiji / **FO** Faroese / **FR** French / **FY** Frisian / **GA** Irish / **GD** Scots Gaelic / **GL** Galician / **GN** Guarani / **GU** Gujarati / **HA** Hausa / **HI** Hindi / **HR** Croatian / **HU** Hungarian / **HY** Armenian / **IA** Interlingua / **IE** Interlingue / **IK** Inupiak / **IN** Indonesian / **IS** Icelandic / **IT** Italian / **IW** Hebrew / **JA** Japanese / **JI** Yiddish / **JW** Javanese / **KA** Georgian / **KK** Kazakh / **KL** Greenlandic / **KM** Cambodian / **KN** Kannada / **KO** Korean / **KS** Kashmiri / **KU** Kurdish / **KY** Kirghiz / **LA** Latin / **LN** Lingala / **LO** Laothian / **LT** Lithuanian / **LV** Latvian, Lettish / **MG** Malagasy / **MI** Maori / **MK** Macedonian / **ML** Malayalam / **MN** Mongolian / **MO** Moldavian / **MR** Marathi / **MS** Malay / **MT** Maltese / **MY** Burmese / **NA** Nauru / **NE** Nepali / **NL** Dutch / **NO** Norwegian / **OC** Occitan / **OM** Afan (Oromo) / **OR** Oriya / **PA** Panjabi / **PL** Polish / **PS** Pashto, Pushto / **PT** Portuguese / **QU** Quechua / **RM** Rhaeto-Romanic / **RN** Kirundi / **RO** Romanian / **RU** Russian / **RW** Kinyarwanda / **SA** Sanskrit / **SD** Sindhi / **SG** Sangho / **SH** Serbo-Croatian / **SI** Singhalese / **SK** Slovak / **SL** Slovenian / **SM** Samoan / **SN** Shona / **SO** Somali / **SQ** Albanian / **SR** Serbian / **SS** Siswat / **ST** Sesotho / **SU** Sundanese / **SV** Swedish / **SW** Swahili / **TA** Tamil / **TE** Telugu / **TG** Tajik / **TH** Thai / **TI** Tigrinya / **TK** Turkmen / **TL** Tagalog / **TN** Setswana / **TO** Tonga / **TR** Turkish / **TS** Tsonga / **TT** Tatar / **TW** Twi / **UK** Ukrainian / **UR** Urdu / **UZ** Uzbek / **VI** Vietnamese / **VO** Volapuk / **WO** Wolof / **XH** Xhosa / **YO** Yoruba / **ZH** Chinese / **ZU** Zulu

## About Output of Next Generation Audio Formats

Next generation audio formats	Maximum number of channels	HDMI		DIGITAL OUT	
		PCM	Bitstream	PCM	Bitstream
Dolby TrueHD	7.1ch (48KHz/96KHz)	7.1ch *3	7.1ch *4	2ch *2	5.1ch *1/3
	5.1ch (192KHz)	5.1ch *3	5.1ch *4	2ch *2	5.1ch *1/3
Dolby Digital PLUS	7.1ch (48KHz)	7.1ch *3	7.1ch *4	2ch *2	5.1ch *1/3
	5.1ch (192KHz)	5.1ch *1/3	5.1ch *4	2ch *2	5.1ch *1/3
DTS-HD Master Audio	7.1ch (48KHz/96KHz)	5.1ch *1/3	7.1ch *4	2ch *2	5.1ch *1/3
	5.1ch (192KHz)	5.1ch *1/3	5.1ch *4	2ch *2	5.1ch *1/3
DTS-HD High Resolution Audio	7.1ch (48KHz/96KHz)	5.1ch *1/3	7.1ch *4	2ch *2	5.1ch *1/3
LPCM	7.1ch (48KHz/96KHz)	7.1ch *3	—	2ch *2	—
	5.1ch (192KHz)	5.1ch *3	—	2ch *2	—

\*1 Core only

\*2 Down mixed

\*3 When SECONDARY AUDIO is set to "ON", the audio is output as 48KHz.

\*4 When SECONDARY AUDIO is set to "ON", the audio is output as PCM.

# SETTINGS

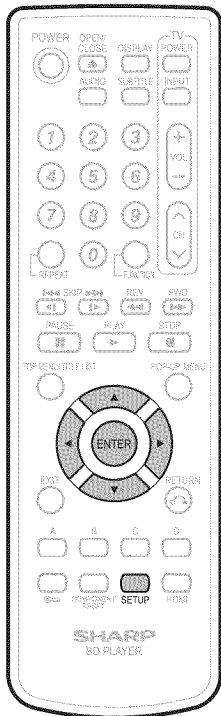

## USB MEMORY MANAGEMENT

The following instructions explain how to delete data such as the Virtual Package data copied to a USB memory device.

### CAUTION

- Do not remove the USB memory device or unplug the AC cord while the erase is being performed.

- 1 Insert the USB memory device into the BD STORAGE/SERVICE terminal on rear of this player.
- 2 Press **SETUP** to display the SETUP MENU screen.
- 3 Press **▲/▼/◀▶** to select "SETTINGS", then press **ENTER**.
- 4 Press **▲/▼** to select "USB MEMORY MANAGEMENT", then press **ENTER**.

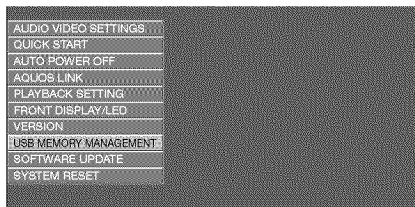

- "NO USB MEMORY!" appears when no USB memory is inserted.

- 5 Press **▲/▼**, select "ERASE" or "FORMAT", then press **ENTER**.

ERASE: Deletes only BD-VIDEO data contents.

FORMAT: Deletes all contents.

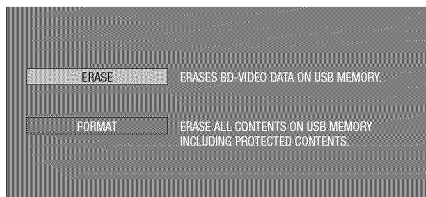

### NOTE

- Data which has been saved to the player's internal memory (game score, etc.) will also be deleted.

- 6 Press **◀▶**, select "YES", and press **ENTER**.

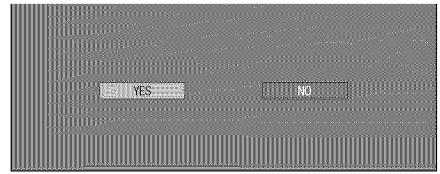

- 7 Start the process.
  - The screen for the current operation will display.



- 8 Press **ENTER**.

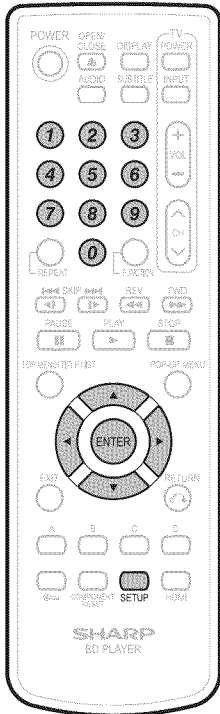

## SOFTWARE UPDATE

This function allows software updates by inserting a USB memory device with the update file into the BD STORAGE/SERVICE terminal on this player.

**Regarding how to obtain the software update file, please call 1-800-BE-SHARP.**

### CAUTION

- Do not remove the USB memory device or unplug the AC cord while the software is being updated.

- Insert the USB memory device with the update file into the BD STORAGE/SERVICE terminal on rear of this player.
- Press **SETUP** to display the SETUP MENU screen.
- Press **▲/▼/◀/▶** to select "SETTINGS", then press **ENTER**.
- Press **▲/▼** to select "SOFTWARE UPDATE", then **ENTER**.
  - If you have not yet set the password, go to step 6.

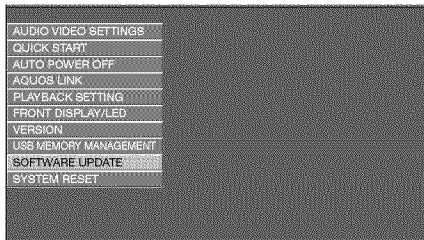

- Enter the 4-digit number using 0-9.

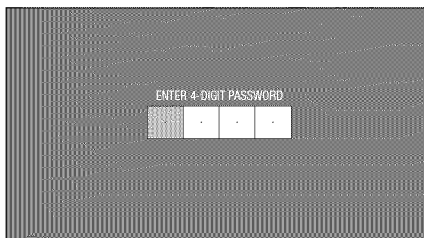

- Press **ENTER** to start checking data in the USB memory device.



- During the data checking, "Checking" blinks.

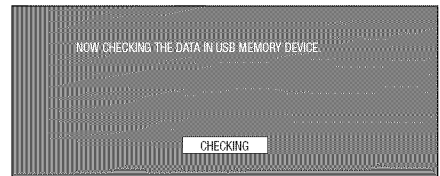

- The current version of this unit software and the version of the update file on the USB memory device are displayed. To update this player software with update file, select "YES", and press **ENTER**.

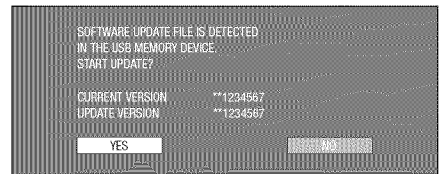

- If the USB memory device is not properly installed or the correct update file cannot be found on the USB memory device, an error message is displayed. Check the file on the USB memory device, and then reinsert the USB memory device correctly.





# SETTINGS

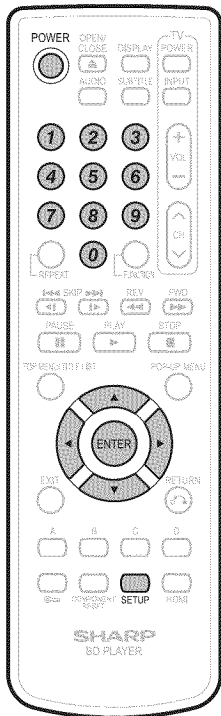

- 8** Press **ENTER** to start updating.
- The screen becomes dark for a while until the update screen can be displayed. Please wait for the update screen to appear. Do not unplug the AC cord.

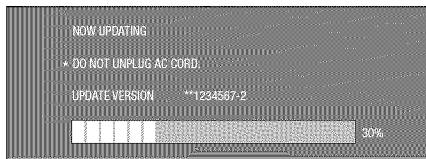

- 9** When the software is successfully updated, a screen is displayed indicating that the update process is completed.
- If the update has failed, check the file in the USB device and try Software Update again.

**10** Press **POWER** to turn off the player.

**11** Remove the USB memory device.

# Troubleshooting

The following problems do not always suggest a defect or malfunction of this Player. Refer to the problems and lists of possible solutions below before calling for service.

## The Player power cannot be turned on.

- Is the power cord firmly plugged into the AC outlet?
- When the power cord is plugged into an AC outlet, press and hold **POWER** on the Player until “**R E S E T**” appears on the front panel display. Then, after the **STANDBY** indicator is lit, turn on the power. (Page 42)
- Press **POWER** after the **STANDBY** indicator turns on.

## The disc is automatically ejected after closing the disc tray.

- Make sure that the disc is loaded properly (aligned in disc tray and label-side up).
- Take out the disc and clean it.
- Make sure that region code on the disc matches that of this Player.
- Make sure that the disc is playable.

## No picture.

- Make sure that the cables are connected correctly.
- Make sure that the connected TV or the AV receiver is set to the correct input.
- Take out the disc and clean it.
- Make sure that region code on the disc matches that of this Player.
- There is no picture from the HDMI output.
  - Are the settings performed correctly? Please check the settings.
- There is no picture from the component video output.
  - Are the settings performed correctly? Please check the settings.

## The Player cannot play a disc.

- Take out the disc and clean it.
- Make sure that the disc is loaded properly (aligned in disc tray and label-side up).
- Make sure that region code on the disc matches that of this Player.
- Allow any condensation in or near the Player to dry.
- Check that the disc is recorded in the compatible TV system (PAL or NTSC).
- The Player cannot play back video which was not recorded normally.
- Proper playback may be impossible due to the state of the disc recording, a scratched, warped or dirty disc, the state of the pick-up, or compatibility issues between this Player and the disc being used.
- When the recorded time of a disc is unusually short, playback may not be possible.
- BD-RE/R discs recorded in a format other than BDMV cannot be played back.

## The settings have been erased.

- If the Player is unplugged (or there is a power failure) for more than about 1 hour while its power is on, the settings will be lost. Make sure that you turn off the Player before unplugging the power cord.
- When there is a power interruption or the power cord is unplugged from the power outlet with the power on, all settings return to the factory preset values.

## The Player power is turned off.

- Is “**AUTO POWER OFF**” set to “**YES**”? When “**AUTO POWER OFF**” is set to “**YES**”, the power will be automatically turned off after 10 continuous minutes of inactivity (no playback).

## Audio is not output, or images are not played back properly.

- The audio may not be output or the images may not be played back properly for some discs in which copyright-protected contents are recorded.

## Screen freezes and operation buttons do not work.

- Press **STOP**, then restart playback.
- Turn off the power and turn on the power again.
- If the power is not turned off, perform a reset. (Page 42)
- Is the disc damaged or dirty? Check the condition of the disc. See page 10 for details about disc cleaning.

## The remote control does not work.

- Set the remote control and the Player to the same remote control code. (Page 21)
- Use the remote control within its operating range.
- Replace the batteries.

## No sound, or sound is distorted.

- If the volume of the TV or amplifier is set to minimum, turn the volume up.
- There is no sound during still mode, slow motion playback, fast forward and fast reverse.
- DVD audio recorded in DTS is only output from the **DIGITAL AUDIO OUT** terminal. Connect a DTS compatible digital amplifier or decoder to the **DIGITAL AUDIO OUT OPTICAL** terminal on this Player.
- Check that the audio cable is connected correctly.
- Check that the cable plugs are clean.
- Take out the disc and clean it.
- Audio may not be output depending on the audio recording status, such as when audio other than an audio signal or non-standard audio is recorded for the audio content of the disc.

## The playback screen will be disturbed if DVD video is recorded to a VCR, or played back through a VCR.

- This Player complies with analog copy protection. Some discs contain a copy prohibiting signal. If you try to play back such discs through a VCR, or record to a VCR and play back the signal, the copy protection will prevent normal playback.

## The TV operates incorrectly.

- Some TVs with wireless remote control capability may operate incorrectly when using the remote control of this Player. Use such TVs away from this Player.

## There is just audio with no video.

- Is the connection cable for video output connected properly?

## Widescreen video appears vertically stretched, or black bands appear at the top and bottom of the screen.

- Is “**TV ASPECT RATIO**” set to match the connected TV? (Page 35)
- If you are using a widescreen TV, is the “**TV ASPECT RATIO**” set to “**WIDE**”? (Page 35)

## Square noise (mosaic) appears on the screen.

- Blocks in images may be visible in scenes with rapid movement due to the characteristics of digital image compression technology.

## Video stops.

- Has the Player been subjected to shock or impact? Are you using it in an unstable location? The Player will stop if it senses shock or vibration.

## Troubleshooting

### Left and right channels of audio are reversed, or sound comes out of only one side.

- Are left and right audio cables connected to the opposite terminal, or is one side disconnected?

### Disc does not play back automatically.

- Have you set a disc that has an automatic playback function?

### The Player heats up during use.

- When using this Player, the console cabinet may heat up depending on the usage environment. This is not a malfunction.

### The Player makes a snapping sound when starting playback or loading a disc.

- The player may sometimes make a snapping sound when starting playback if it has not been operated in a while. These sounds are not malfunctions of the player but are normal operating conditions.

### Cannot operate the Player.

- Are you operating the Player within the specified operating temperature range? (Page 45)

### STANDBY indicator will remain lit.

- When the AC cord is removed from the outlet, the STANDBY indicator will remain lit for a short period. This is normal and is not a malfunction.

### NOTE

#### Reset

- If this Player receives strong interference from a source such as excessive static electricity, strong external noise, malfunction of power supply, or voltage caused by lightning during use or a wrong operation is sent to the Player, errors like the Player not accepting an operation may occur. Press and hold **POWER** on the Player until "RESET" appears on the front panel display when the Player does not operate properly even after the power has been turned off. Then, after the STANDBY indicator is lit, turn on the power.
- When a reset is performed while the power is on, the Player will turn off. Turn the power on again. At this point, it may take a few moments for the system processing to finish before the Player is ready for use. During the system processing, the BD/DVD/CD mode indicator on the front panel display of the Player will blink. Once the system processing has finished, the indicators will finish blinking and then light up normally. You can operate the Player when the BD/DVD/CD mode indicator is lit.
- Since all settings including the language setting stored in memory are also reset when a reset has been performed, they must be set again.
- When the problem persists even after performing a reset, unplug the AC cord and plug it in again. If this does not solve the problem, contact the nearest service center approved by SHARP.

## On-screen Error Messages

### Messages Relating to BD and DVD

- The following messages appear on the TV screen in case the disc you tried to playback is not appropriate or the operation is not correct.

Error message	Possible Error	Suggested Solution
CANNOT PLAY.	<ul style="list-style-type: none"><li>• The disc cannot be played back with this Player.</li></ul>	<ul style="list-style-type: none"><li>• Check the disc, and load it correctly.</li></ul>
INCOMPATIBLE DISC.	<ul style="list-style-type: none"><li>• If you load a disc which cannot be played with this Player (i.e. a scratched disc), or if you load a disc upside down, this message will appear, and the disc tray will automatically pop out.</li></ul>	<ul style="list-style-type: none"><li>• Remove the disc.</li></ul>
	<ul style="list-style-type: none"><li>• Occurs if the loaded disc cannot be played because it is a non-standard disc or scratched, etc.</li></ul>	
CANNOT OPERATE.	<ul style="list-style-type: none"><li>• Occurs if an operation is incorrect.</li></ul>	
THIS USB MEMORY IS NOT FORMATTED PROPERLY. PLEASE FORMAT THE MEMORY IN USB MEMORY MANAGEMENT.	<ul style="list-style-type: none"><li>• Occurs if there is a formatting error.</li></ul>	<ul style="list-style-type: none"><li>• Format the USB memory again.</li></ul>
THE CONNECTED USB MEMORY CANNOT BE USED. IT SHOULD BE COMPLIANT WITH USB2.0.	<ul style="list-style-type: none"><li>• Occurs if USB memory not compliant with USB 2.0 is used (i.e. USB 1.0/USB 1.1).</li></ul>	<ul style="list-style-type: none"><li>• Connect USB 2.0-compliant USB memory.</li></ul>

# Glossary

## BD-J application

The BD-ROM format supports Java for interactive functions. "BD-J" offers content providers almost unlimited functionality when creating interactive BD-ROM titles.

## BDMV (page 7)

BDMV (Blu-ray Disc Movie, BD-MV) refers to one of the application formats used for BD-ROM which is one of the Blu-ray Disc specifications. BDMV is a recording format equivalent to DVD-video of the DVD specification.

## BD-R (page 7)

A BD-R (Blu-ray Disc Recordable) is a recordable, write-once Blu-ray Disc. Since contents can be recorded and cannot be overwritten, a BD-R can be used to archive data or for storing and distributing video material.

## BD-RE (page 7)

A BD-RE (Blu-ray Disc Rewritable) is a recordable and rewritable Blu-ray Disc.

## BD-ROM

BD-ROMs (Blu-ray Disc Read-Only Memory) are commercially produced discs. Other than conventional movie and video contents, these discs have enhanced features such as interactive content, menu operations using pop-up menus, selection of subtitle display, and slide shows. Although a BD-ROM may contain any form of data, most BD-ROM discs will contain movies in High Definition format for playback on Blu-ray Disc players.

## Blu-ray Disc (BD) (page 7)

A disc format developed for recording/playing high-definition (HD) video (for HDTV, etc.), and for storing large amounts of data. A single layer Blu-ray Disc holds up to 25 GB, and a dual-layer Blu-ray Disc holds up to 50 GB of data.

## Chapter number (pages 32, 33)

Sections of a movie or a music feature that are smaller than titles. A title is composed of several chapters. Some discs may only be comprised of a single chapter.

## Copy guard

This function prevents copying. You cannot copy discs marked by the copyright holder with a signal which prevents copying.

## Disc menu (page 25)

This lets you select things like the subtitle language or audio format using a menu stored on the BD/DVD video disc.

## Dolby Digital

A sound system developed by Dolby Laboratories Inc. that gives movie theater ambience to audio output when the product is connected to a Dolby Digital processor or amplifier.

## Dolby Digital Plus

A sound system developed as an extension to Dolby Digital. This audio coding technology supports 7.1 multi-channel surround sound.

## Dolby TrueHD

Dolby TrueHD is a lossless coding technology that supports up to 8 channels of multi-channel surround sound for the next generation optical discs. The reproduced sound is true to the original source bit-for-bit.

## DTS

This is a digital sound system developed by DTS, Inc. for use in cinemas. This system uses 6 audio channels and provides accurate sound field positioning and realistic acoustics. (By connecting a DTS Digital Surround decoder, you can also listen to DTS Digital Surround sound.)

## DTS-HD High Resolution Audio

DTS-HD High Resolution Audio is a new technology developed for the next generation high definition optical disc format.

## DTS-HD Master Audio

DTS-HD Master Audio is a lossless audio compression technology developed for the next generation high definition optical disc format.

## DVD video (pages 7, 24)

A disc format that contains up to eight hours of moving pictures on a disc the same diameter as a CD. A single-layer single sided DVD holds up to 4.7 GB; a double layer single-sided DVD, 8.5 GB; a single layer double-sided DVD, 9.4 GB; double-layer double-sided DVD, 17 GB. The MPEG 2 format was adopted for efficient video data compression. It is a variable rate technology that encodes the data to according to the status of the video for reproducing high-quality images. Audio information is recorded in a multi-channel format such as Dolby Digital, allowing for a realistic audio presence.

## DVD+/-R (pages 7, 26)

A DVD+/-R is a recordable, write-once DVD. Since contents can be recorded and cannot be overwritten, a DVD+/-R can be used to archive data or for storing and distributing video material. The DVD+/-R has two different formats: VR format and Video format. DVDs created in Video format have the same format as a DVD video, while discs created in VR (Video Recording) format allow the contents to be programed or edited.

## DVD+/-RW (pages 7, 26)

A DVD+/-RW is a recordable and rewritable DVD. The re-recordable feature makes editing possible. The DVD+/-RW has two different formats: VR format and Video format. DVDs created in Video format have the same format as a DVD video, while discs created in VR (Video Recording) format allow the contents to be programed or edited.

## HDMI (page 15)

HDMI (High-Definition Multimedia Interface) is an interface that supports both video and audio on a single digital connection. The HDMI connection carries standard to high definition video signals and multi-channel audio signals to AV components such as HDMI equipped TVs, in digital form without degradation.

## Interlace format

Interlace format shows every other line of an image as a single "field" and is the standard method for displaying images on television. The even numbered field shows the even numbered lines of an image, and the odd numbered field shows the odd numbered lines of an image.

## JPEG (pages 7, 8, 31)

JPEG (Joint Photographic Experts Group) is a still image data compression format and is used in most of digital cameras.

## Letter Box (LB 4:3) (page 35)

A screen size with black bars on the top and bottom of the image to allow viewing of wide-screen (16:9) material on a connected 4:3 TV.

## Linear PCM Sound

Linear PCM is a signal recording format used for Audio CDs and on some DVD and Blu-ray discs. The sound on Audio CDs is recorded at 44.1 kHz with 16 bits. (Sound is recorded between 48 kHz with 16 bits and 96 kHz with 24 bits on DVD video discs and between 48 kHz with 16 bits and 192 kHz with 24 bits on BD video discs.)

## Glossary

---

### **MPEG-2**

MPEG-2 (Moving Picture Experts Group phase 2) is one of the video data compression schemes, which is adopted for DVD videos and digital broadcasts worldwide. Some Blu-ray Discs also use high bitrate MPEG-2.

### **Multi Angle (pages 30, 32)**

This is a feature of DVD and BD video discs. In some discs, the same scene is shot from different angles, and these are stored in a single disc so you can enjoy playback from each angle. (This function can be enjoyed if the disc is recorded with multiple angles.)

### **Multi Audio**

This is a feature of DVD and BD video discs. This function makes it possible to record different audio tracks for the same video, so you can enhance your enjoyment by switching the audio. (You can enjoy this function with discs recorded with multiple audio tracks.)

### **Pan Scan (PS 4:3) (page 35)**

A screen size that cuts off the sides of the image to allow viewing of wide-screen (16:9) material on a connected 4:3 TV.

### **Parental control (page 36)**

In some digital broadcasts and BD/DVD video discs, a control level for disc viewing is set depending on the age of the viewer. With this Player, you can set the control level for viewing such broadcasts and discs.

### **Pop-up menu (page 25)**

An enhanced menu operation available on BD video discs. The pop-up menu appears when **POP-UP MENU** is pressed during playback, and can be operated while playback is in progress.

### **Progressive format**

Compared to the Interlace format that alternately shows every other line of an image (field) to create one frame, the Progressive format shows the entire image at once as a single frame. This means that while the Interlace format can show 30 frames/60 fields in one second, the Progressive format can show 60 frames in one second. The overall picture quality increases and still images, text, and horizontal lines appear sharper.

### **Region code (page 7)**

Code identifying a geographic region of compatibility for a BD/DVD.

### **Remote control code (page 21)**

This is the type of the remote control signal for operating the Player. There are three types of remote control signals: "Remote Control No. 1" (RC-1), "Remote Control No. 2" (RC-2) and "Remote Control No. 3" (RC-3).

### **Resume playback (page 24)**

If you stop playback while it is in progress, the Player stores the stop position in memory, and this function lets you playback from that point.

### **Skip (page 28)**

This returns to the start of the chapter (or track) being played, or skips to the next chapter (or track).

### **Subtitles (pages 29, 32, 33)**

These are the lines of text appearing at the bottom of the screen which translate or transcribe the dialog. They are recorded on many DVD and BD video discs.

### **Time number**

This indicates the play time which has elapsed from the start of a disc or a title. It can be used to find a specific scene quickly. (It may not work with some discs.)

### **Title number (pages 32, 33)**

These numbers are recorded on DVD and Blu-ray discs. When a disc contains two or more movies, these movies are numbered as title 1, title 2, etc.

### **Top menu (page 24)**

In a BD/DVD video, this is the menu for selecting things like the chapter to be played back and the subtitle language. In some DVD videos, the top menu may be called the "Title Menu".

### **Track number**

These numbers are assigned to the tracks which are recorded on audio CDs. They enable specific tracks to be located quickly.

### **x.v.Color**

x.v.Color reproduces a greater range of color than before, showing almost all of the colors that the human eye can detect.

# Specifications

## General

Power supply	AC 120V, 60Hz
Power consumption (Normal)	23 W
Power consumption (Standby)	0.4 W (When "QUICK START" is set to "NO")
Dimensions	Approx. 16 <sup>59</sup> / <sub>64</sub> × 2 <sup>11</sup> / <sub>16</sub> × 13 <sup>9</sup> / <sub>16</sub> inch (W × H × D) Approx. 430 mm × 68 mm × 335 mm (W × H × D)
Weight	Approx. 8.8 lbs. (4.0 kg)
Operating temperature	41°F to 95°F (5°C to 35°C)
Storage temperature	-4°F to 131°F (-20°C to 55°C)
Operating humidity	10 % to 80 % (no condensation)
TV systems	NTSC system

## Playback

Playable discs	BD-ROM, BD-RE Dual Layer (BDMV format), BD-R Dual Layer (BDMV format), DVD Video, DVD+RW/+R/-RW/-R Dual Layer (Video/VR format), Audio CD (CD-DA), CD-RW/R (CD-DA, JPEG file format)
----------------	--

## Input/Output

HDMI	HDMI 19-pin standard connector (1080p 24Hz output) HDMI™ (V.1.3 with x.v.Color, Dolby TrueHD, DTS-HD Advanced Digital Out)
Component video output	Output level: Y: 1 Vp-p (75 ohms) Pb/Cb, Pr/Cr: 0.7 Vp-p (75 ohms) Jacks: RCA jack
Video output	Output level: 1 Vp-p (75 ohms) Jack: RCA-pin jack
Digital audio optical output	Terminal: Square Optical terminal
Audio output	Output level: 2 V rms (Output impedance: 1K ohms) Jacks: RCA jack
USB input	USB 2.0 correspondence (for Local storage/Software update)

Specifications are subject to change without notice.

# CONSUMER LIMITED WARRANTY

(Valid for warranty service in the U.S. and PUERTO RICO only)

## CONSUMER LIMITED WARRANTY

SHARP ELECTRONICS CORPORATION warrants to the first consumer purchaser that this Sharp brand product (the "Product"), when shipped in its original container, will be free from defective workmanship and materials, and agrees that it will, at its option, either repair the defect or replace the defective Product or part thereof with a new or remanufactured equivalent at no charge to the purchaser for parts or labor for the period(s) set forth below.

This warranty does not apply to any appearance items of the Product or if the serial number or model number affixed to the Product has been removed, defaced, changed, altered or tampered with. This warranty does not cover installation or signal reception problems. This limited warranty will not apply if the Product has been or is being used in a commercial setting or application; this warranty is meant solely for the non-commercial, household use of the Product by consumers in their home or residence.

In order to enforce the rights under this limited warranty, the purchaser should follow the steps set forth below and provide proof of purchase to the servicer.

To the extent permitted by applicable state law, the warranties set forth are in lieu of, and exclusive of, all other warranties, express or implied. Specifically ALL OTHER WARRANTIES OTHER THAN THOSE SET FORTH ABOVE ARE EXCLUDED, ALL EXPRESS AND IMPLIED WARRANTIES INCLUDING THE WARRANTIES OF MERCHANTABILITY, FITNESS FOR USE, AND FITNESS FOR A PARTICULAR PURPOSE ARE SPECIFICALLY EXCLUDED. IF, UNDER APPLICABLE STATE LAW, IMPLIED WARRANTIES MAY NOT VALIDLY BE DISCLAIMED OR EXCLUDED, THE DURATION OF SUCH IMPLIED WARRANTIES IS LIMITED TO THE PERIOD(S) FROM THE DATE OF PURCHASE SET FORTH BELOW. THIS WARRANTY GIVES YOU SPECIFIC LEGAL RIGHTS. YOU MAY ALSO HAVE OTHER RIGHTS WHICH VARY FROM STATE TO STATE.

The warranties given herein shall be the sole and exclusive warranties granted by Sharp and shall be the sole and exclusive remedy available to the purchaser and only for the time periods set forth herein. No other representations or promises made by anyone are permitted. Correction of defects, in the manner and for the period of time described herein, shall constitute complete fulfillment of all liabilities and responsibilities of Sharp to the purchaser with respect to the Product, and shall constitute full satisfaction of all claims, whether based on contract, negligence, strict liability or otherwise. Sharp does not warrant nor shall Sharp be liable, or in any way responsible, for Products which have been subject to abuse (including, but not limited to, improper voltage), accident, misuse, negligence, lack of reasonable care, alteration, modification, tampering, improper operation or maintenance or any damages or defects in the Product which were caused by repairs or attempted repairs performed by anyone other than a Sharp authorized servicer. Nor shall Sharp be liable or in any way responsible for any incidental or consequential economic or property damage. Some states do not allow limits on warranties or on remedies for breach in certain transactions; in such states, the limits herein may not apply.

THIS LIMITED WARRANTY IS VALID ONLY IN THE FIFTY (50) UNITED STATES, THE DISTRICT OF COLUMBIA. AND PUERTO RICO

### Model Specific Section

**Your Product Model Number & Description:**

BD-HP21U BLU-RAY DISC PLAYER

(Be sure to have this information available when you need service for your Product.)

**Warranty Period for this Product:**

One (1) year parts and labor from the date of purchase.

**Additional Item(s) Excluded from Warranty Coverage (if any):**

Non-rechargeable batteries.

**Where to Obtain Service:**

From a Sharp Authorized Servicer located in the United States. To find the location of the nearest Sharp Authorized Servicer, call Sharp toll free at 1-800-BE-SHARP.

**What to do to Obtain Service:**

Please transport the Product in its original packaging and ensure that the Product is covered to avoid scratches and damage. Sharp shall not be responsible for lost, stolen or misdirected mail or for damage to the product incurred during shipping.

TO OBTAIN PRODUCT INFORMATION, CALL 1-800-BE-SHARP OR VISIT [www.sharppusa.com](http://www.sharppusa.com)

# SHARP®

## LIMITED WARRANTY

### Consumer Electronics Products

### Congratulations on your purchase!

Sharp Electronics of Canada Ltd. (hereinafter called "Sharp") gives the following express warranty to the first consumer purchaser for this Sharp brand product, when shipped in its original container and sold or distributed in Canada by Sharp or by an Authorized Sharp Dealer:

Sharp warrants that this product is free, under normal use and maintenance, from any defects in material and workmanship. If any such defects should be found in this product within the applicable warranty period, Sharp shall, at its option, repair or replace the product as specified herein.

This warranty shall not apply to:

- (a) Any defects caused or repairs required as a result of abusive operation, negligence, accident, improper installation or inappropriate use as outlined in the owner's manual.
- (b) Any Sharp product tampered with, modified, adjusted or repaired by any party other than Sharp, Sharp's Authorized Service Centres or Sharp's Authorized Servicing Dealers.
- (c) Damage caused or repairs required as a result of the use with items not specified or approved by Sharp, including but not limited to head cleaning tapes and chemical cleaning agents.
- (d) Any replacement of accessories, glassware, consumable or peripheral items required through normal use of the product including but not limited to earphones, remote controls, AC adapters, batteries, temperature probe, stylus, trays, filters, belts, ribbons, cables and paper.
- (e) Any cosmetic damage to the surface or exterior that has been defaced or caused by normal wear and tear.
- (f) Any damage caused by external or environmental conditions, including but not limited to transmission line/power line voltage or liquid spillage.
- (g) Any product received without appropriate model, serial number and CSA/cUL markings.
- (h) Any products used for rental or commercial purposes.
- (i) Any installation, setup and/or programming charges.

Should this Sharp product fail to operate during the warranty period, warranty service may be obtained upon delivery of the Sharp product together with proof of purchase and a copy of this LIMITED WARRANTY statement to an Authorized Sharp Service Centre or an Authorized Sharp Servicing Dealer. In home warranty service may be provided at Sharp's discretion on any Sharp television with the screen size of 27" or larger and on any Sharp Over-the-Range Microwave Oven.

This warranty constitutes the entire express warranty granted by Sharp and no other dealer, service centre or their agent or employee is authorized to extend, enlarge or transfer this warranty on behalf of Sharp. To the extent the law permits, Sharp disclaims any and all liability for direct or indirect damages or losses or for any incidental, special or consequential damages or loss of profits resulting from a defect in material or workmanship relating to the product, including damages for the loss of time or use of this Sharp product or the loss of information. The purchaser will be responsible for any removal, reinstallation, transportation and insurance costs incurred. Correction of defects, in the manner and period of time described herein, constitute complete fulfillment of all obligations and responsibilities of Sharp to the purchaser with respect to the product and shall constitute full satisfaction of all claims, whether based on contract, negligence, strict liability or otherwise.

**WARRANTY PERIODS:**

	Parts & Labour (exceptions noted)
Audio Product	1 year
Camcorder	1 year
BD/DVD Product	1 year
Projector	1 year (lamp 90 days)
LCD TV	1 year
Microwave Oven	1 year (magnetron component-4 additional years)
Air Purifier	1 year
Portable Air Conditioner	1 year

To obtain the name and address of the nearest Authorized Sharp Service Centre or Dealer, please contact:  
 SHARP ELECTRONICS OF CANADA LTD. 335 Britannia Road East, Mississauga, Ontario L4Z 1W9

For more information on this Warranty, Sharp Extended Warranty Offers, Sharp Canada Products, Accessory Sales, Dealer or Service Locations, please call (905) 568-7140  
 Visit our Web site: [www.sharp.ca](http://www.sharp.ca)





**SHARP**®

SHARP ELECTRONICS CORPORATION

Sharp Plaza, Mahwah, New Jersey 07495-1163

SHARP CORPORATION

Printed in Malaysia  
Imprimé en Malaisie  
Impreso en Malasia

**TINS-D803WJQZ**®

08P07-MA-NG