

***Amana***<sup>®</sup>

**Over-the-Range  
Microwave Oven  
Owner's Manual**

**MVH230\***

\* Additional alphanumeric characters representing other models in the series may follow each model number.

Keep these instructions for future reference. If the oven changes ownership, be sure this manual accompanies oven.

# Contents

# Model Identification

Model Identification	
Asure™ Extended Service Plan .....	2
Oven Features .....	2
Important Safety Instructions	
Warning .....	3
Caution .....	4
Precautions to Avoid Possible Exposure to Excessive Microwave Energy .....	5
Grounding Instructions .....	5
Installation	
Unpacking Oven .....	6
Oven Placement .....	6
Radio Interference .....	6
Optional Accessories .....	6
Turntable .....	6
Rack .....	6
Control Panel .....	7
Operation	
Vent Fan .....	8
Surface Light .....	8
Display ON/OFF .....	8
Scroll Speed .....	8
Clock .....	8
Minute Timer .....	8
Reminder .....	8
Child Lock .....	8
Pause or Cancel Cycle .....	8
Complete Reminder .....	8
Program 1 Microwave Cooking .....	8
Program 2 Microwave Cooking .....	8
Changing Cookmatic® Power Level .....	9
One-Step Cook (1-6) .....	9
Auto Start .....	9
Auto Accu-Thaw® .....	10
Accu-Thaw® .....	10
Popcorn .....	11
Cook .....	11
Reheat .....	12
Add 30 Seconds .....	12
Care and Cleaning	
Interior, Exterior and Door .....	12
Turntable Roller and Glass Tray .....	12
Exhaust Maintenance .....	12
Charcoal Filter (recirculating installation only) .....	13
Replacing Light Bulbs .....	13
Before Calling for Service .....	15
Microwave Cooking	
Microwave Cooking Principles .....	16
Microwave Utensils .....	16
Preventing Excess Moisture .....	16
Using Rack .....	17
Cooking and Defrosting Guides	
Cooking Guide .....	18
Defrosting Guide .....	19
<b>Quick Reference Instructions .....</b>	<b>20</b>

Complete enclosed registration card and promptly return. If registration card is missing, call Consumer Affairs Department at 1-800-843-0304 inside U.S.A. 319-622-5511 outside U.S.A. When contacting Amana, provide product information. Record the following:

Model Number: \_\_\_\_\_  
Manufacturing Number: \_\_\_\_\_  
Serial or S/N Number: \_\_\_\_\_  
Date of purchase: \_\_\_\_\_  
Dealer's name and address: \_\_\_\_\_  
\_\_\_\_\_  
\_\_\_\_\_

Keep a copy of sales receipt for future reference or in case warranty service is required. Any questions or to locate an authorized servicer, call 1-800-NAT-LSVC (1-800-628-5782) inside U.S.A. 319-622-5511 outside U.S.A. Warranty service must be performed by an authorized servicer. Amana, also recommends contacting an authorized servicer if service is required after warranty expires.

## Asure™ Extended Service Plan

Amana offers long-term service protection for this new microwave oven. Asure™ Extended Service Plan is specially designed to supplement Amana's strong warranty. Asure™ provides budgetable protection for up to 3 additional years. This plan covers parts, labor, and travel charges. Call 1-800-528-2682 for information.

## Oven Features

- Over the range installation
- 900 watts of cooking power, based on IEC 705 test method
- 1.3 cu.ft. capacity
- Turntable
- Rack

# IMPORTANT SAFETY INSTRUCTIONS



Recognize this symbol as a **SAFETY** message



## WARNING

When using electrical equipment, basic safety precautions should be followed to reduce the risk of burns, electrical shock, fire, or injury to persons.

1. **READ** all instructions before using equipment.
2. **READ AND FOLLOW** the specific “**PRECAUTIONS TO AVOID POSSIBLE EXPOSURE TO EXCESSIVE MICROWAVE ENERGY**” on page 5.
3. This equipment **MUST BE GROUNDED**. Connect only to properly **GROUNDED** outlet. See “**GROUNDED INSTRUCTIONS**” on page 5.
4. Install or locate this equipment **ONLY** in accordance with the installation instructions in this manual.
5. Some products such as whole eggs and sealed containers, for example, closed glass jars may explode and **SHOULD NOT** be **HEATED** in this oven.
6. Use this equipment **ONLY** for its intended use as described in this manual. Do not use corrosive chemicals or vapors in this equipment. This type of oven is specifically designed to heat or cook. It is not designed for industrial or laboratory use.
7. As with any equipment, **CLOSE SUPERVISION** is necessary when used by **CHILDREN**.
8. **DO NOT** operate this equipment if it has a damaged cord or plug, if it is not working properly, or if it has been damaged or dropped.
9. This equipment, including power cord, must be serviced **ONLY** by qualified service personnel. Special tools are required to service equipment. Contact nearest authorized service facility for examination, repair, or adjustment.
10. **DO NOT** cover or block filter or other openings on equipment.

11. **DO NOT** store this equipment outdoors. **DO NOT** use this product near water – for example, near a kitchen sink, in a wet basement, or near a swimming pool, and the like.
12. **DO NOT** immerse cord or plug in water.
13. Keep cord **AWAY** from **HEATED** surfaces.
14. **DO NOT** let cord hang over edge of table or counter.
15. See door cleaning instructions in “Care and Cleaning” section of manual on page 12.



## WARNING

To avoid starting and spreading of accidental cooking fires while the vent fan is in use.

- Clean the underside of the microwave often. Do not allow grease to build up on the microwave or the fan filters.
- In the event of a grease fire on the surface units below the microwave oven, smother a flaming pan on the surface unit by covering the pan completely with a lid, a cookie sheet or a flat tray.
- Use care when cleaning the vent fan filters. Corrosive cleaning agents, such as lye-based oven cleaners, may damage the filters.
- When flaming foods under the microwave, turn the vent fan off. The fan, if operating, may spread the flame.
- Never leave surface units beneath your microwave oven unattended at high heat settings. Boilovers cause smoking and greasy spillovers that may ignite and spread if the microwave vent fan is operating. To minimize automatic fan operation, use adequate sized cookware and use high heat on surface units

## SAVE THESE INSTRUCTIONS

# IMPORTANT SAFETY INSTRUCTIONS



## CAUTION

To avoid personal injury or property damage observe the following:

1. Always press STOP/RESET before programming oven.
2. Do not deep fat fry in oven. Fat could overheat and be hazardous to handle.
3. Do not cook or reheat eggs in shell or with an unbroken yolk. Pressure may build up and erupt. Pierce yolk with a fork or knife before cooking. Do not reheat previously cooked eggs in the microwave oven unless finely chopped or scrambled.
4. Pierce skin of potatoes, tomatoes, or other foods with a "skin" before cooking in microwave oven. Piercing skin allows steam to escape during cooking.
5. Do not home can in microwave oven. Home canning is generally done with metal lids. Since metal lids reflect heat, product may not be heated uniformly to 212°F or above. Food could deteriorate. USDA extension specialists do not recommend home canning in microwave ovens.
6. Remove excess fat from meats and poultry to prevent splattering.
7. Do not heat baby bottles in microwave oven.
8. Briskly stir or pour liquids before heating to prevent spontaneous boiling or eruption. Do not overheat. If air is not mixed into a liquid, liquid can erupt in oven or after removal from oven.
9. All uncooked foods should be heated to a final internal temperature of at least 165°F. Some foods require higher temperatures. These recommended temperatures kill most food borne, disease causing organisms. Some common visual signs that indicate the cooking temperature has been reached:
  - Food steams throughout, not just around edges.
  - Center bottom of dish is very hot to the touch.
10. If using a microwave popcorn popper, use according to manufacturer's instructions. Do not continue to heat after popping has stopped. Popcorn will scorch or burn. Do not leave oven unattended.
11. Use only popcorn in packages designed and labeled for microwave use. Pop according to package directions, beginning with the minimum amount of time recommended. Use caution when handling hot popcorn bag.
12. Microwave convenience foods are often packaged in specially designed packaging. Special plates, lids, containers, or other unique packaging materials may be used. Susceptor packing material (a thin, metalized plastic film) is frequently used to help brown and make crisp foods such as microwave pizzas, French fries, or fish sticks. Be sure to follow food package instructions carefully. Contact convenience food manufacturer with questions concerning these products. Amana does not endorse any brand of microwave convenience foods, or any type of microwave food packaging.
13. Do not operate microwave oven empty. This could damage the oven.
14. Do not use regular cooking thermometers in oven. Most cooking thermometers contain mercury and may cause "arcing", malfunction, and/or damage to oven.
15. Metal or ceramic accessories which are designed to absorb microwave energy to provide heat should be used with caution. Test device before use (See "Microwave Utensils" on page 16). Read and follow manufacturer's instructions provided with the accessory. Contact accessory manufacturer with questions concerning these accessories. Amana does not endorse any brand of accessory.
16. Pierce or open plastic bags (and other airtight containers) before heating in microwave oven. This allows steam to escape during cooking.
17. Containers may become hot and pot holders may be needed.
18. Closely supervise any use by children. Make sure they can read instructions and reach controls. Never allow them to lean or swing on oven door.

## SAVE THESE INSTRUCTIONS

# IMPORTANT SAFETY INSTRUCTIONS

## CAUTION

To reduce the risk of fire in the oven cavity:

- DO NOT overcook food. Carefully attend appliance if paper, plastic, or other combustible materials are placed inside the oven to facilitate cooking.
- Remove wire twist-ties from paper or plastic bags before placing bag in oven.
- If materials inside the oven should ignite, keep oven door closed, turn oven off, and disconnect the power cord, or shut off power at the fuse or circuit breaker panel. **IF THE DOOR IS OPENED THE FIRE MAY SPREAD!**
- DO NOT use the cavity for storage purposes. DO NOT leave paper products, cooking utensils, or food in the cavity when not in use.

## ***PRECAUTIONS TO AVOID POSSIBLE EXPOSURE TO EXCESSIVE MICROWAVE ENERGY***

- DO NOT attempt to operate this oven with the door open since open-door operation can result in harmful exposure to microwave energy. It is important not to defeat or tamper with the safety interlocks.
- DO NOT place any object between the oven front face and the door or allow soil or cleaner residue to accumulate on sealing surfaces.
- DO NOT operate the oven if it is damaged. It is particularly important that the oven door close properly and that there is no damage to the: (1) door (bent), (2) hinges and latches (broken or loosened), (3) door seals and sealing surfaces.
- The oven should NOT be adjusted or repaired by anyone except properly qualified service personnel.

## Grounding Instructions

### WARNING

To avoid the risk of electrical shock or death, this oven must be grounded.

### WARNING

To avoid the risk of electrical shock or death, do not alter the plug.

This oven **MUST** be grounded. In the event of an electrical short circuit, grounding reduces the risk of electric shock by providing an escape wire for the electric current. This oven is equipped with a cord having a grounding wire with a grounding plug. The plug must be plugged into an outlet that is properly installed and grounded.

Consult a qualified electrician or servicer if grounding instructions are not completely understood, or if doubt exists as to whether the equipment is properly grounded.

Do not use an extension cord. If the product power cord is too short, have a qualified electrician install a three-slot receptacle. This oven should be plugged into a separate 60 hertz circuit with the electrical rating as shown in drawing. Oven requires a 120 supply voltage. When a microwave oven is on a circuit with other equipment, an increase in cooking times may be required and fuses can be blown.

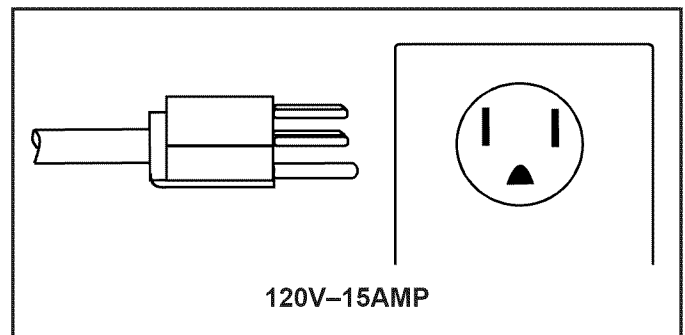

## SAVE THESE INSTRUCTIONS

# Installation

## Unpacking Oven

- Inspect oven for damage such as dents in door or dents inside oven cavity.
- Report any dents or breakage to source of purchase immediately. Do not attempt to use oven if damaged.
- Remove all materials from oven interior.
- If oven has been stored in extremely cold area, wait a few hours before connecting power.
- Glass tray and filters are located in packing material.

## Oven Placement

- This microwave oven is U.L. listed for installation over gas and electric ranges.
- Microwave oven should not be installed over a range wider than 42 inches.
- Do not mount this appliance over a sink.
- Install or locate this appliance only in accordance with the provided installation instructions.
- Do not cover or block any openings on this appliance.
- Do not store anything directly on top of microwave oven during oven operation.

## Radio Interference

Microwave operation may cause interference to radio, television, or similar equipment. Reduce or eliminate interference by doing the following:

- Clean door and sealing surfaces of oven according to instructions in "Care and Cleaning" section.
- Place radio, television, etc. as far as possible from oven.
- Use a properly installed antenna on radio, television, etc. to obtain stronger signal reception.

## Optional Accessories

- **Filler Panel kit:** If space between cabinets is greater than 30 inches, filler panel kit may be used to fill in gap between microwave oven and cabinets. Contact dealer to purchase filler panel kit.
- **Charcoal Filter kit:** Charcoal filter kit is needed for non-vented (ductless) installation. Contact dealer to purchase charcoal filter kit.

## Turntable

Turntable provides even cooking. Place turntable roller in oven cavity so wheels are in track. Place glass tray on roller. Turntable must be in place when operating.



To avoid burns, allow glass tray to cool or use dry oven mitts when handling. Tray can become hot during heating.

Turntable

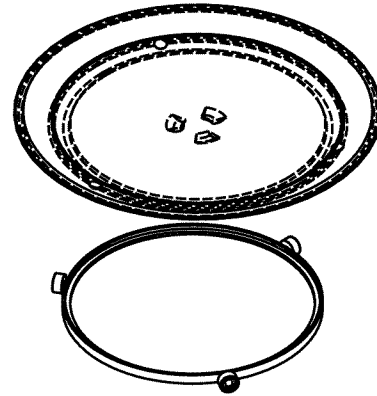

Roller

## Rack

Rack is packed in oven cavity. Unpack and store. Do not leave in oven while using. See "Using Rack" section.



# Control Panel

## DISPLAY

Displays time of day, cook time, power level, and cook mode instructions.

## PROGRAM 1 & 2

Use to enter time not in oven memory. Program 1 & 2 are set to power level 10 (High).

## ONE STEP COOK

Press number pads 1 through 6 for one to six minutes of cooking. No need to press *START*; oven will start immediately.

## ACCU-THAW®

Automatically sets power levels and defrosting time according to food weight.

## POPCORN

Cooks prepackaged microwave popcorn weighing 1.75 to 3.5 ounces.

## COOK

Cook feature automatically sets cooking times and power levels according to selected food type.

## REHEAT

Use to automatically reheat previously cooked food.

## ADD 30 SECONDS

Each time *ADD 30 SECOND* pad is pressed 30 seconds is added to cooking time. Press pad and oven will start immediately.

## COOKMATIC LEVEL

Programs cooking power level.

## NUMBER PADS

Press to enter cooking time, defrosting time, time of day, power level or food weights for Accu-Thaw®.

## AUTO START

Programs oven to begin cooking at preset time of day (up to 12-hour delay).

## STOP/RESET

Press to stop oven and erase all settings except time of day.

## START

Press to start oven.

## REMINDER

Reminder feature is used like alarm clock. While oven is cooking reminder can be set up to 24 hours later.

## AM/PM

Press when setting clock and Auto Start feature.

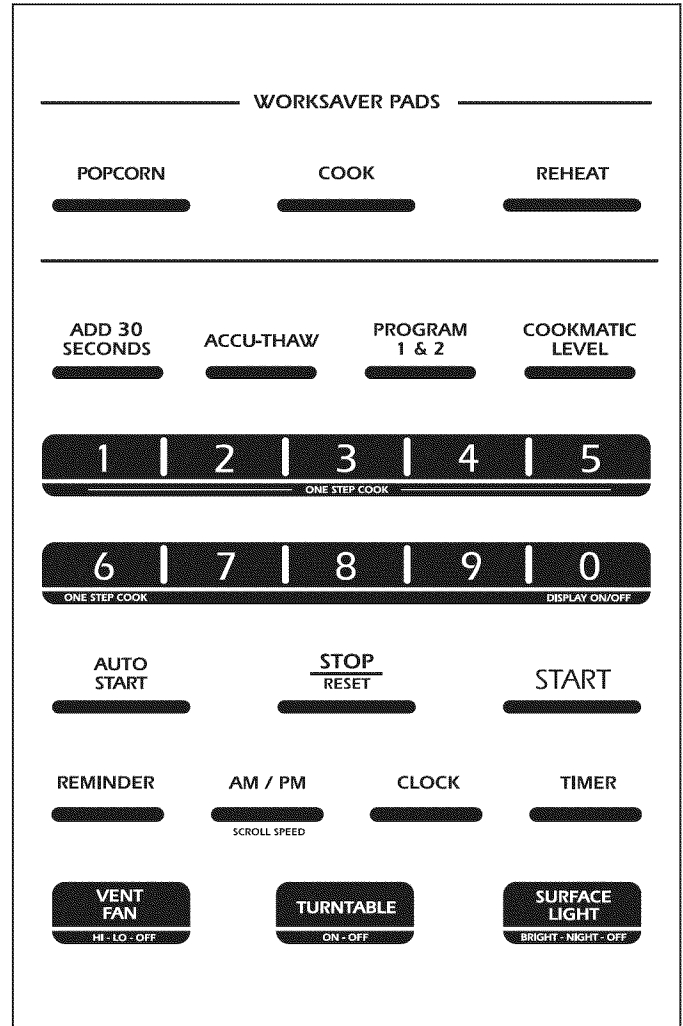

## CLOCK

Use to enter time of day or check time of day while heating.

## TIMER

Functions as either kitchen timer, holding period after defrost, or delay timer before Program I & II cooking. No microwave energy is generated when using timer feature.

## VENT FAN

Press *HI*, *LO* or *OFF* for different fan speeds.

## TURNTABLE

Allows or stops turn table from rotating. Stop turn table from rotating when using large rectangular dishes.

## SURFACE LIGHT

Press once for bright surface light, twice for softer night light or press 3 times to turn off.

## Display ON/OFF

Press and hold *0* pad for 3 seconds to turn display on or off. Display cannot be turned off while oven is in operation.

# Operation

---

## Vent Fan

Press *VENT FAN* pad to turn vent fan to *HI*, *LO*, and *OFF*. Vent fan protects microwave from excess heat rising from cooktop or range. Fan automatically turns on at low speed when excess heat is sensed. If excess heat is sensed fan can't be turned off manually until internal parts have cooled.

## Surface Light

Press once for bright surface light, twice for softer night light or press 3 times to turn off.

## Display ON/OFF

Press and hold *0* pad for 3 seconds to turn display on or off. Display cannot be turned off while oven is in operation.

## Scroll Speed

The display scroll speed can be changed. Press and hold *AM/PM* pad for 3 seconds to access display. Press number pad 1-5 to set scroll speed.

## Clock

1. Press *CLOCK*.
2. Enter time of day.
  - For example, for 10:35 (a.m or p.m.), press *1,0,3,5*.
3. Press *AM/PM* pad.
4. Press *CLOCK* pad. Clock is set.
  - Reset or change time by repeating above steps.

## Minute Timer

1. Press *TIMER* pad.
2. Press desired time.
  - For example, for 3 minutes, press *3,0,0*.
3. Press *TIMER* pad.
  - Display counts down.
  - Signal sounds and "End" displays at end of time period. Press *TIMER* pad again to return to time of day.

## Reminder

1. Press *REMINDER* pad.
2. Enter time of day you want the oven to signal.
  - Check clock for correct time of day.
3. Press *AM/PM* pad.
4. Press *REMINDER* pad.

## Child Lock

To lock or unlock control, press and hold *STOP/RESET* pad for about 3 seconds.

## Pause or Cancel Cycle

Open door or press *START* pad to pause. Press *STOP/RESET* pad to cancel cycle.

## Complete Reminder

Reminds user that there is food in oven. "FOOD IS READY" is displayed and oven signals once every minute until door is opened, or *STOP/RESET* pad is pressed. Complete Reminder is not adjustable.

## Program 1 Microwave Cooking

Set cooking time from 1 second, to 99 minutes 99 seconds. Cooks at 100% power unless cookmatic level is changed. See "Changing Cookmatic® Power Level" section.

1. Place food in oven. Close door.
2. Press *PROGRAM 1 & 2* pad.
3. Press number pad to select desired cooking time.
  - For example, for 1 minute, press *1,0,0*.
4. If power level other than 100% is desired, press *COOKMATIC LEVEL* pad and number pad.
  - For example, for 20% power, press *2 pad*.
5. Press *START* pad.
  - Oven stops, signals, and "FOOD IS READY" displays at end of cooking time. "READY" remains in display until door is opened or *STOP/RESET* pad is pressed.

## Program 2 Microwave Cooking

PROGRAM 2 feature is designed to set two timed cooking functions within one program.

1. Place food in oven and close door.
2. Press *PROGRAM 1 & 2* pad.
3. Press number pads to select first cook time.
  - For example, for 2 minutes 15 seconds, press *2,1,5*.
4. If power level other than 100% is desired, press *COOKMATIC LEVEL* pad and number pad.
  - For example, for 20% power, press *2 pad*.
5. Press *PROGRAM 1 & 2* pad.
6. Press number pads to select second cook time.
7. If power level other than 100% is desired, press *COOKMATIC LEVEL* pad and number pad.
  - For example, for 20% power, press *2 pad*.
8. Press *START* pad.
  - Oven stops, signals, and "FOOD IS READY" displays at end of cooking time. "READY" remains in display until door is opened or *STOP/RESET* pad is pressed.
  - If program cycles are interrupted, close door and press *START* pad to resume cooking.



## Changing Cookmatic® Power Level

Oven has ten power levels. When no power level is selected, oven operates at 100% power during cook mode or at power level 3 during defrost.

1. Place food in oven and close door.
2. Select cook or defrost program.
3. Enter numbers for cooking or defrosting time.
4. Press *COOKMATIC LEVEL* pad.
  - Power level displays.
5. Press number for desired power level. Number displays.
  - For example, to cook at power level eight, for 80% power, press 8.
6. Press *START*.
  - Oven operates, time counts down, and power level selected displays. Microwave power cycles on and off.
7. Oven stops, signals, and “FOOD IS READY” displays at end of cooking time. “READY” remains in display until door is opened or *STOP/RESET* pad is pressed.

Power Level	Use
10	Fish , bacon, vegetables, boiling liquids
7	Gentle cooking of meat or poultry, casseroles, reheating
5	Slow cooking and tenderizing stews or lesser cuts of meat
2 or 3	Defrosting without cooking, simmering, or delicate sauces
1	Keeping food warm or softening butter.

## One-Step Cook (1-6)

One-step process to program oven at full power for 1-6 minutes.

1. Place food in oven and close door.
2. To select 1 to 6 minutes of cooking time, press desired number pad (1-6).
  - For example, to cook for 2 minutes, press 2 pad. Oven will start immediately.
3. Oven stops, signals, and “FOOD IS READY” displays at end of cooking time. “READY” remains in display until door is opened or *STOP/RESET* pad is pressed.

## Auto Start



### CAUTION

To avoid risk of food poisoning, do not hold foods containing meat, dairy products or eggs in oven for over 1 hour before cooking.

Programs oven to begin cooking at preset time of day (up to 12 hour delay). Clock must be set to use feature. Ensure correct time of day is displayed.

1. Place food in oven and close door.
2. Press *AUTO START* pad.
3. Enter desired start time.
  - For example, for 2:30 (a.m or p.m.), press 2,3,0.
4. Press *AM/PM* pad.
5. Enter desired cook or defrost program.
6. Press *START* pad.
  - Oven will automatically start at programmed time. Programmed start time is displayed until reached.
7. Oven stops, signals, and “FOOD IS READY” displays at end of cooking time. “READY” remains in display until door is opened or *STOP/RESET* pad is pressed.

## Auto Accu-Thaw®

*Auto Accu-Thaw®* automatically sets defrosting times and power levels. Use to defrost meat, poultry, or fish. Enter food weight in pounds and tenths of pounds (see conversion guide below). Check weight guide located at front of oven for maximum and minimum weights for variety of foods.

1. Remove food from package, place in oven on microwave-safe dish and close door.
2. Press *ACCU-THAW®* pad.
3. Enter food weight.
  - For example, if food item weight is 2 pounds, 4 ounces, convert 4 ounces to pounds by using conversion guide below. Press 2,3 (2 represents 2 pounds, and 3 represents 4 ounces).
  - If ounces are not entered within three seconds, "PRESS START" displays. Press *STOP/RESET* pad and repeat steps 2 through 3.
4. Press *START* pad. Display counts down defrost time.
  - Twice during defrosting cycle, oven will beep 4 times and "TURN FOOD OVER" displays. Defrost continues while "TURN FOOD OVER" is displayed. After manipulating food, close door and press *START* pad.
5. Oven stops, signals, and "FOOD IS READY" displays at end of cooking time. "READY" remains in display until door is opened or *STOP/RESET* pad is pressed.
  - After Auto Accu-Thaw®, meat needs standing time to allow inside to defrost. Food may be taken out of oven for stand time.

## Accu-Thaw®

*Accu-Thaw®* automatically sets power level to defrost. Enter defrost time. Use to defrost bread, fruits, and baked goods.

1. Remove food from package, place in oven on microwave-safe dish and close door.
2. Press *ACCU-THAW®* pad twice.
3. Enter defrost time.
4. Press *START* pad. Display counts down defrost time.
  - After ½ of defrosting cycle passes, oven will beep and "TURN FOOD OVER" displays. Defrost continues while "TURN FOOD OVER" is displayed. After manipulating food, close door and press *START* pad.
5. Oven stops, signals, and "FOOD IS READY" displays at end of cooking time. "READY" remains in display until door is opened or *STOP/RESET* pad is pressed.
  - After Accu-Thaw®, meat needs standing time to allow inside to defrost. Food may be taken out of oven for stand time.

Conversion Guide	
If weight of food is stated in pounds and ounces, ounces must be converted to tenths (.1) of pounds.	
Ounces	Pounds
1-2	0.1
3	0.2
4-5	0.3
6-7	0.4
8	0.5
9-10	0.6
11	0.7
12-13	0.8
14-15	0.9

## Popcorn



### CAUTION

To avoid steam burns when opening bag, wear protective clothing like dry oven mitts and keep face away from bag opening. Escaping steam can burn.

Popcorn feature is designed to be used only with prepackaged microwave popcorn weighing 1.75 to 3.5 ounces. Use popcorn feature by observing the following:

1. Remove outer wrapper from microwave popcorn.
2. Open oven door and place package of popcorn in center of oven floor, as directed on popcorn package. Close oven door.
3. Press *POPCORN* pad. Oven will start immediately.
  - To increase cooking time, immediately after pressing *POPCORN* pad, press *9* pad. A plus sign appears in display behind “POP”. Plus sign indicates 20 seconds of additional cooking time. Press *9* pad twice to add 30 seconds to cooking time. If oven beeps before *9* pad is pressed, press *STOP/RESET* pad and start over.
  - To decrease cooking time, immediately after pressing *POPCORN* pad, press *1* pad. A minus sign appears in display behind “POP”. Minus sign indicates 20 seconds less cooking time. Press *1* pad twice to subtract 30 seconds from cooking time. If oven beeps before *1* pad is pressed, press *STOP/RESET* pad and start over.
  - Oven will start immediately.

## Cook

Cook feature automatically sets cooking times and power levels according to selected food type.

1. Place food in oven and close door.
2. Press *COOK* pad.
3. Press pad for desired food code. See table below.
  - For example, press *1* pad for canned vegetables.
4. Press number pads to enter food weight in ounces.
  - For example, for 18 ounces press *1,8*.
5. Press *START* pad. Oven will begin cooking.
  - Oven stops, signals, and “FOOD IS READY” displays at end of cooking time. “READY” remains in display until door is opened or *STOP/RESET* pad is pressed.

**Cook Pad Table**

Food Type	Weight (oz.)	Comments
<b>1 Canned Vegetables</b>	4-20	Use microwave-safe casserole or bowl. Cover with lid or plastic wrap.
<b>2 Frozen Vegetables</b>	4-20	Use microwave-safe casserole or bowl. Follow package instructions for adding water. Cover with lid or plastic wrap.
<b>3 Fresh Vegetables</b>	4-16	Use microwave-safe casserole or bowl. Add 2 tablespoons water for each serving. Cover with lid or plastic wrap.
<b>4 Potatoes</b>	8-40	Pierce skin with fork. Arrange in star pattern on oven floor or turntable.
<b>5 Fish</b>	4-16	Use oblong, square or round dish. Cover with plastic wrap.
<b>6 Chicken Pieces</b>	4-40	Use oblong, square or round dish. Cover with plastic wrap.
<b>7 Ground Meat</b> (Beef, pork, turkey)	8-48	Use round casserole dish. Crumble meat into dish. Do not cover dish. Drain and stir at signal.
<b>8 Bacon</b>	2-10	Layer strips on a plate, 4 to a layer. Cover each layer with a paper towel.
<b>9 Pizza</b> (frozen microwaveable)	4-16	Follow package instructions to prepare pizza for microwaving.

## Care and Cleaning

### Reheat

Reheat is a feature used to automatically reheat previously cooked food. Reheat food types 1 through 5 allow up to 3 servings to be heated at once.

1. Place food in oven and close door.
2. Press **REHEAT** pad.
3. Press number pad from 1 to 6 to select desired food type. See Reheat table below.
4. To reheat two servings press 2 pad. To reheat three servings press 3 pad. To reheat 1 serving, go to next step.
5. Press **START** pad.
  - Oven stops, signals, and "FOOD IS READY" displays at end of cooking time. "READY" remains in display until door is opened or **STOP/RESET** pad is pressed.

Pad	Food Type	Comments
1	Pasta	Cover with lid or plastic wrap.
2	Meats, casseroles, pizza	Cover with lid or plastic wrap.
3	Fruits, vegetables	Cover with lid or plastic wrap.
4	Beverages,	Use wide mouth mug. 8-10 oz.
5	Sauces, gravies	Cover with lid or plastic wrap.
6	Plate of leftovers	Cover with plastic wrap. 2-3 foods, 4 oz. each

### Add 30 Seconds

- Provides convenient way to extend cooking time by 30 seconds, while oven timer is counting down. Each time **ADD 30 SECOND** pad is pressed 30 seconds is added to cooking time.
- Pad may be used as express cook for 30 seconds. Press pad and oven will start immediately.

### Interior, Exterior and Door

If walls, floor, and door of microwave oven become splattered, wipe with paper towel or clean with mild detergent in warm water using soft sponge or cloth. Wring sponge or cloth to remove excess water before wiping oven. If desired, boil a cup of water in microwave oven to loosen soil before cleaning.

- Do not use cleaners containing ammonia. These cleaners could damage finish.
- Never pour water into microwave oven bottom.
- Do not use abrasives to clean inside of oven. Abrasives cleaners can damage oven finish.

### Turntable Roller and Glass Tray

Wash roller and glass tray in dishwasher or with mild detergent in warm water using soft sponge or cloth.

### Exhaust Maintenance

Exhaust hood is equipped with two metal filters which collect grease. Never operate oven without filters in place. In situations where flaming might occur on surfaces below hood, filters will stop entry of flames into oven. When fan is operated, air is drawn through filters. Depending on installation, air is either discharged through venting to outside or drawn through charcoal filter and recirculated.



To avoid personal injury, do not operate microwave oven without filters in place.

### Removing grease filters

1. Grasp tab on filter and slide to rear.
2. Pull filter downward to front. Filter will drop out.

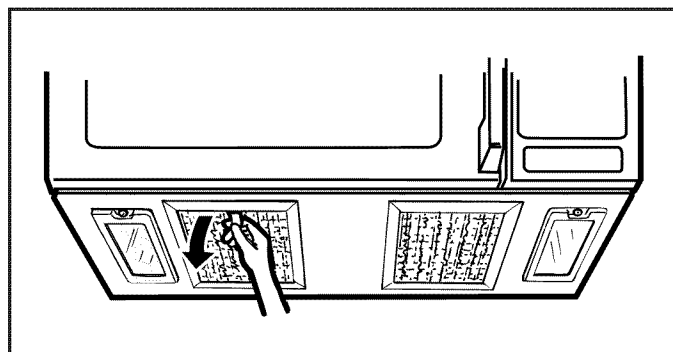

### Cleaning grease filters

Grease filters should be cleaned at least once a month to remove residue. Clean filters by soaking and agitating in warm sudsy water. Do not use ammonia or ammonia products, they will darken metal. Light brushing can be used to remove embedded dirt. Rinse, shake and remove moisture before replacing.

### Replacing grease filters

Do not operate vent hood with filters removed.

1. Slide filter into frame slot on back of opening.
2. Pull filter upward to front.
3. Lock in place.

### Charcoal Filter (recirculating installation only)

Microwave oven can be recirculated instead of being vented to outside. For recirculating installation, charcoal filter must be used. Charcoal filter removes smoke and odors caused by cooking on range top. Charcoal filter is disposable and should be replaced when it is noticeably dirty or discolored (approximately every 6 to 12 months, depending on usage). Charcoal filter may be purchased from dealer.

- Do not clean charcoal filter.
- Do not operate venthood with charcoal filter removed.

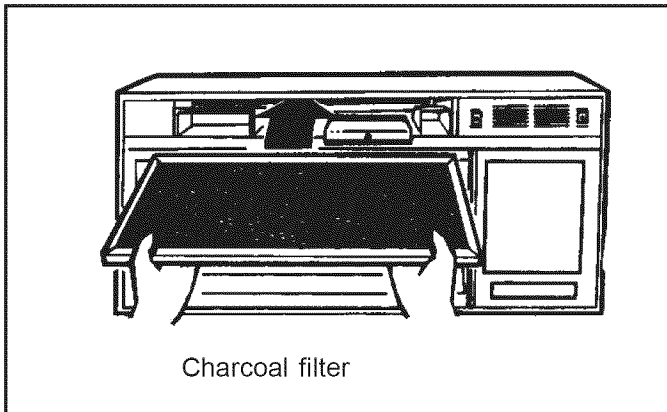

Charcoal filter

### To remove charcoal filter

1. Disconnect power at main fuse, circuit breaker panel or pull plug.
2. Remove two screws that hold grille in place.
3. Remove grille.
4. Grasp filter, slide toward front of oven and remove.

### To install new charcoal filter

1. Remove plastic and other outer wrapping from new filter.
2. Insert filter into top opening of oven as shown. Filter will rest at an angle, on two side support tabs.
3. Replace grille.
4. Replace two screws to secure grille.

### Replacing Light Bulbs

#### **WARNING**

To avoid electrical shock hazard unplug power cord or open circuit breaker to microwave oven before replacing light bulb.

#### **CAUTION**

Wear gloves or use clean cotton cloth to protect hands should light bulb break. If hot, allow bulb to cool.

#### Tools needed

- protective gloves
- phillips screwdriver
- two 120 volt, 40 watt, surface light bulbs available from Amana dealer, servicer, factory service center, or Amana Consumer Affairs (1-800-843-0304 if inside U.S.A. and 1-319-622-5511 if outside U.S.A.)
- 30 watt, oven light bulb available from Amana dealer, servicer, factory service center, or Amana Consumer Affairs (1-800-843-0304 if inside U.S.A. and 1-319-622-5511 if outside U.S.A.)

### Changing Oven Light Bulb

1. Unplug microwave oven.
2. Remove two screws holding grille in place and remove grille.

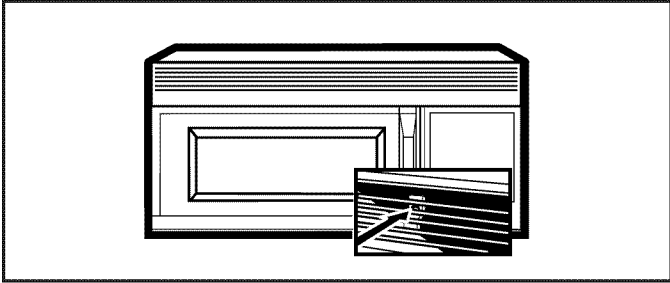

3. Remove 2 screws located above door near center of oven. Remove light bulb cover.

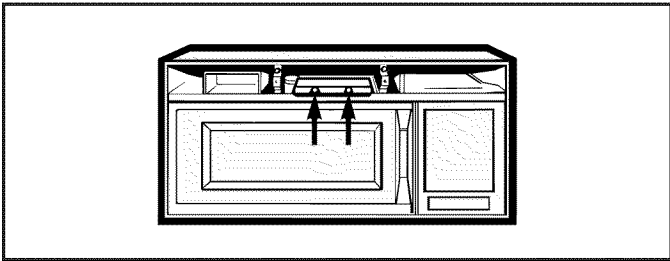

4. Remove bulb, being careful not to burn fingers or break bulb and replace 30 watt bulb.
5. Replace screws located above door near center of oven.
6. Replace grille and 2 screws.
7. Restore power to microwave oven.

### Changing Surface Light Bulb

1. Unplug microwave oven.
2. Remove screw in front of light compartment covers (underneath side of microwave oven).

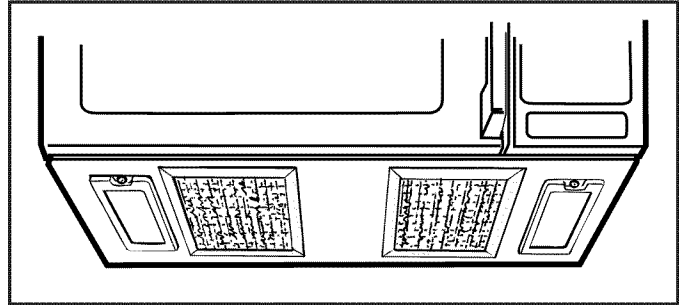

3. Lower cover until it stops.

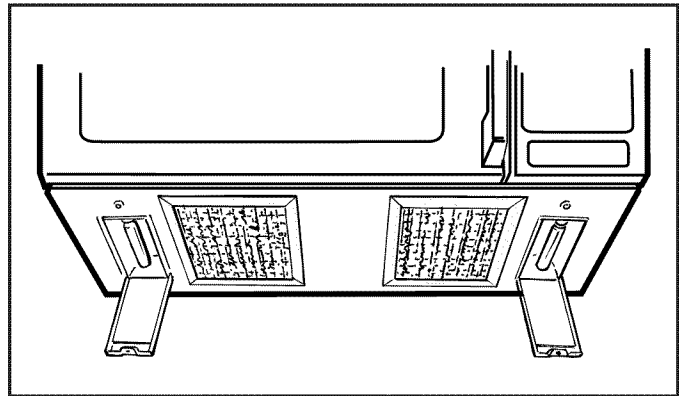

4. Remove bulb, being careful not to burn fingers or break bulb and replace two 40 watt bulbs.
5. Replace light compartment cover and screw. Do not operate oven without light compartment cover.
6. Restore power to microwave oven.

# Before Calling for Service

---



## WARNING

To avoid electrical shock which can cause severe personal injury or death, do not remove outer case at any time. Only authorized servicer should remove outer case.

If microwave oven does not operate:

- Confirm oven is plugged into dedicated circuit.
- Confirm oven is on grounded and polarized circuit.
- Check fuse or circuit breaker. Determine if circuit is operable by plugging another item in outlet.
- Confirm microwave oven door is securely closed.
- If condition remains unchanged, see “Unchanged Condition” instructions below.

If control will not accept instructions:

- For cooking by time, see “Unchanged Condition” instructions below.

If readout appears wrong:

- Press *STOP/RESET*.
- See “Unchanged Condition” instructions below.

If oven light does not work:

- Confirm light bulb is screwed in tightly.
- Confirm light bulb is not defective.

If room lights dim or pulse when oven is in use:

- Confirm microwave is on proper circuit. See “Grounding Instructions” section.

If oven operates, but will not heat food:

- Place one cup cool water in oven. Heat for one minute. If water temperature does not rise, oven is operating incorrectly.

If “RESET” appears in display:

- This is a power interruption signal and will appear whenever oven is initially plugged in or when power is interrupted. Set the clock to clear.

### Unchanged Condition

If condition remains unchanged, perform the following steps:

1. Check to see if fuse or circuit breaker is open.
2. Unplug oven.
3. Reconnect oven to wall outlet. “RESET” appears in display.
4. Press *STOP/RESET* or set clock.

### Normal Operation

- The oven floor is warm when the oven has not been operating. Oven light is on.
- Steam or vapor escaping around oven door.
- Dimming oven light or change in blower sound when heating at power level other than 100%. Dull thumping sound while oven is operating.

Keep a copy of sales receipt for future reference or in case warranty service is required. Any questions or to locate an authorized servicer, call 1-800-NAT-LSVC (1-800-628-5782) inside U.S.A. 319-622-5511 outside U.S.A. Warranty service must be performed by an authorized servicer. Amana, also recommends contacting an authorized servicer if service is required after warranty expires.

# Microwave Cooking

---

## Microwave Cooking Principles

**Decrease** cooking times when:

- Foods are high in fat and sugar.
- Foods are porous.
- Foods are flat, thin or prepared in shallow pan.

**Increase** cooking times when:

- Foods are thick and dense.
- Foods are frozen or refrigerator temperature.
- Food volume increases.

## Food Placement

Allow space between foods for proper cooking results. For best results, arrange thickest or hardest to cook portion of food toward outside of dish. Place smaller, easier to cook portions toward center.

## Reheating

When reheating food, cover dish loosely with plastic wrap. Heat at full power. Reheat porous items such as breads and cakes for a minimum amount of time. Stir soups, sauces and beverages vigorously before reheating.

## Browning

Some foods prepared in microwave will not brown the same as if done in conventional oven. This is particularly true for baked goods, such as breads and cakes.

## Shielding

Porous, thin and protruding portions of large food items, such as poultry drumsticks, can be covered with thin strips of foil to prevent overcooking.

## Piercing

Membranes or tight skins on foods, such as egg yolks, potatoes, tomatoes, and squash must be pierced. Piercing allows steam to escape during cooking.

## Defrosting

Frozen foods in paper or plastic can be defrosted in package. Slit, pierce, or vent sealed packages.

Foods that spoil easily like milk eggs, fish, stuffing, poultry, and pork should not be allowed to sit out for more than 1 hour after defrosting.

It is important that most foods, especially meats, be totally defrosted before cooking. Determine foods are totally defrosted, by inserting sharp knife in center of food and checking for remaining ice crystals. Turn large food items over during defrosting, for best results.

## Microwave Utensils

**Recommended** utensils include: glass, glass-ceramic, natural fiber cloth, non-recycled paper, plastic and wood.

**Not Recommended** utensils include: aluminum foil, grocery bags, lead crystal, metal, metallic trimmed china, newspapers and recycled paper.

## Utensil Check Test

Use the following test to check utensils for microwave safeness.

1. Place glass measuring cup of water next to empty dish to be tested in microwave oven.
2. Heat on full power for one minute.
3. Check temperature of dish and water.
  - If dish remains cool and water is hot, dish is microwave safe.
  - If dish is slightly warm, use for short term cooking only.
  - If dish is hot and water is cool, do not use. Dish remains cool if not absorbing microwaves and microwaves are being absorbed by water. Dish becomes hot if absorbing microwaves.

## Preventing Excess Moisture

When cooking foods in a microwave oven, a considerable amount of steam/water vapor can be generated and accumulate on foods and inside of oven. This is caused by hot moist air from food coming in contact with cool surfaces inside oven. Use the following procedures to help reduce moisture buildup.

- Cover foods before cooking in microwave.
- Cover potatoes and fresh vegetables with a microwave-safe paper towel before cooking to help absorb excess moisture. Remove paper towel immediately after cooking to prevent vegetables from reabsorbing moisture.
- Open microwave door immediately after cooking to reduce moisture inside oven.



## Using Rack

Food microwaves best when placed on the turntable or on the rack. For best cooking results, remove the rack unless you are cooking on two levels.

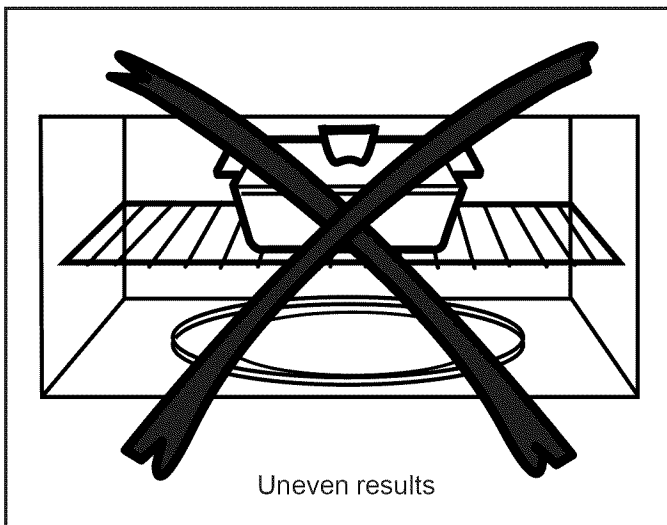
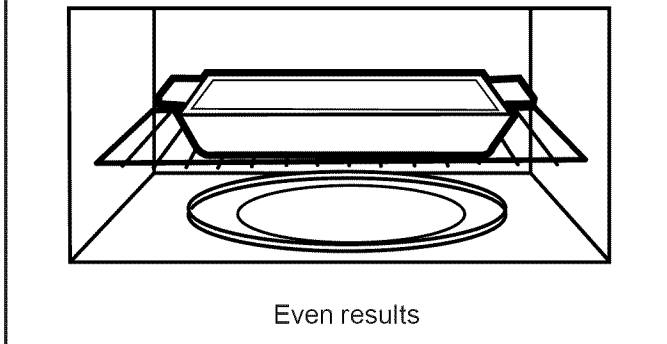
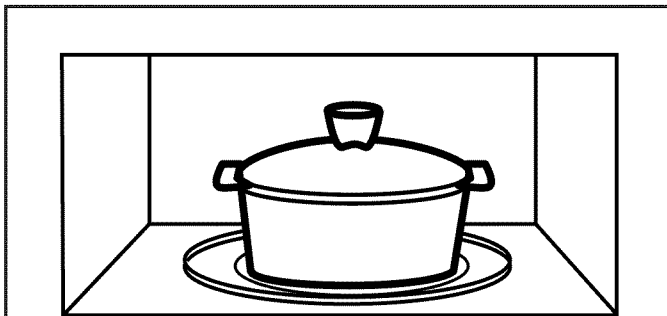
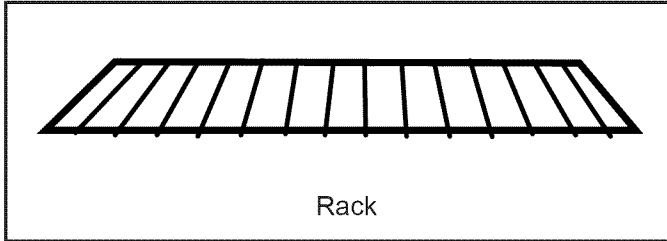

Rack provides a flat surface for placing dishes that may tilt if placed on the turntable.

Rack allows you to place 2 dishes side-by-side. This is helpful for casseroles or other cookware that may be too tall to cook on two levels.

Rack gives you the option to reheat or cook more than one dish of food at the same time.

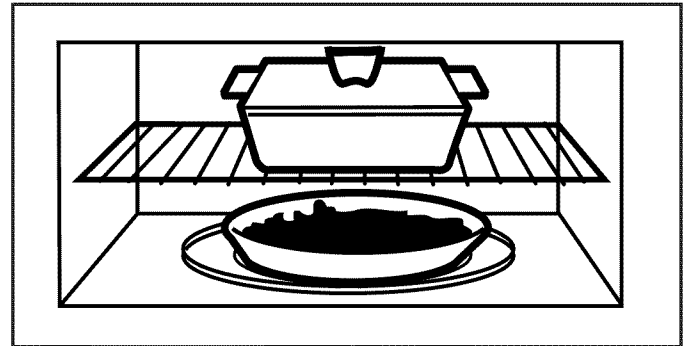

To cook on 2 levels or to cook 2 dishes:

1. Double the cooking time.
2. Switch places after  $\frac{1}{2}$  the time and give dishes  $\frac{1}{2}$  turn.
  - Place dense foods, or those that require a longer cook time, on the shelf first.

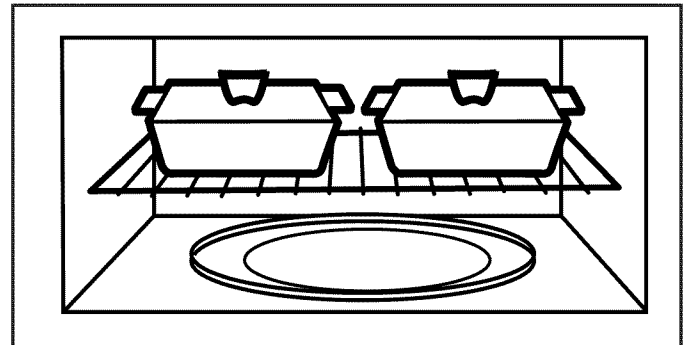

# Cooking and Defrosting Guides

## Cooking Guide

Vegetable	Quantity	Time (Min.)	Comments
<b>Asparagus</b>			
Fresh spears	1 lb.	7-9, level 7	1½ qt. oblong glass baking dish. Add ¼ cup of water.
Frozen spears	10 oz. pkg.	5-7	1 qt. casserole dish.
<b>Beans</b>			
Fresh green	1 lb. cut in half	10-12	1½ qt. casserole, place ½ cup water.
Frozen green	10 oz. pkg.	6-8	In 1 qt. casserole, place 2 tablespoons water.
Frozen lima	10 oz. pkg.	6-8	In 1 qt. casserole, place ¼ cup water.
<b>Beets</b>			
Fresh whole	1 bunch	18-22	In 2 qt. casserole, place ½ cup water.
<b>Broccoli</b>			
Fresh cut	1 bunch (1¼-1½ lbs.)	8-10	In 2 qt. casserole, place ½ cup water.
Fresh spears	1 bunch (1¼-1½ lbs.)	10-13	In 2 qt. oblong glass baking dish, place ¼ cup water. Rotate dish after half of time. (Turntable should be turned off.)
Frozen chopped	10 oz. pkg.	5-7	In 1 qt. casserole.
Frozen spears	10 oz. pkg.	5-7	In 1 qt. casserole, place 3 tablespoons water.
<b>Cabbage</b>			
Fresh	1 med. head (about 2 lbs.)	9-11	In 1½ or 2 qt. casserole, place ¼ cup water.
Wedges		8-10	In 2 or 3 qt. casserole, place ¼ cup water.
<b>Carrots</b>			
Fresh sliced	1 lb.	7-9	In 1½ qt. casserole, place ¼ cup water.
Frozen	10 oz. pkg.	5-7	In 1 qt. casserole, place 2 tablespoons water.
<b>Cauliflower</b>			
Flowerets	1 med. head	10-14	In 2 qt. casserole, place ½ cup water.
Fresh whole	1 med. head	10-17	In 2 qt. casserole, place ½ cup water.
Frozen	10 oz. pkg.	5-7	In 1 qt. casserole, place 2 tablespoons water.
<b>Corn</b>			
Frozen kernel	10 oz. pkg.	5-7	In 1 qt. casserole, place 2 tablespoons water.
<b>Corn on the cob</b>			
Fresh	1-5 ears	3-4 per ear	In 2 qt. oblong glass baking dish, place corn. If corn is in husk, use no water; if corn has been husked, add ¼ cup water. Rearrange after half of time. (Turntable should be turned off.)
Frozen	1 ear 2-6 ears	5-6 3-4 per ear	Place in 2 qt. oblong glass baking dish. Cover with vented plastic wrap. Rearrange after half of time. (Turntable should be turned off.)
<b>Mixed vegetables</b>			
Frozen	10 oz. pkg.	5-7	In 1 qt. casserole, place 3 tablespoons water.
<b>Peas</b>			
Fresh shelled	2 lbs. unshelled	10-12	In 1 qt. casserole, place ¼ cup water.
Frozen	10 oz. pkg.	5-7	In 1 qt. casserole, place 2 tablespoons water.
<b>Potatoes</b>			
Fresh cubed white	4 potatoes (6-8 oz. each)	10-12	Peel and cut into 1 inch cubes. Place in 2 qt. casserole with ½ cup water. Stir after half of time.
Fresh whole sweet or white	1 (6-8 oz.)	3-4	Pierce with cooking fork. Place in center of the oven. Let stand 5 minutes.

Use 100% power unless instructed otherwise.

<b>Vegetable</b>	<b>Quantity</b>	<b>Time (Min.)</b>	<b>Comments</b>
<b>Spinach</b> Fresh Frozen chopped and leaf	10-16 oz. 10 oz. pkg.	5-7 5-7	In 2 qt. casserole, place washed spinach. In 1 qt. casserole, place 3 tablespoons water.
<b>Squash</b> Fresh summer and yellow Winter acorn butternut	1 lb. sliced  1-2 squash (about 1 lb. each)	5-7  8-11	In 1½ qt. casserole, place ¼ cup water.  Cut in half and remove fibrous membranes. In 2 qt. oblong glass baking dish, place squash cut-side-down. Turn cut-side-up after 4 minutes. (Turntable should be turned off.)

Use 100% power unless instructed otherwise.

## Defrosting Guide

<b>Food</b>	<b>Quantity</b>	<b>Time (Min.)</b>	<b>Comments</b>
<b>Bread, Cakes</b> Bread, buns or rolls Sweet Rolls	1 piece approx. 12 oz.	1 3-5	
<b>Fish and Seafood</b> Fillets, frozen Shellfish, small pcs.	1 lb. 1 lb.	7-9 5-7	Place block in casserole. Turn over and break up after half the time.
<b>Fruit</b> Plastic pouch	1-2 10 oz. pkg.	3-6	
<b>Meat</b> Bacon  Franks  Ground meat Roast: beef, lamb, veal, pork Steaks, chops and cutlets	1 lb.  1 lb.  1 lb.	3-5  3-5  5-7 12-16 per lb.  6-8 per lb.	Place unopened package in oven. Let stand 5 minutes after defrosting. Place unopened package in oven. Microwave just until franks can be separated. Let stand 5 minutes, if necessary, to complete defrosting. Turn meat over after half the time. Use power level 1.  Place unwrapped meat in cooking dish. Turn over after half the time and shield warm areas with foil. When finished, separate pieces and let stand to complete defrosting.
<b>Poultry</b> Chicken, broiler- fryer cut up  Chicken, whole  Cornish hen  Turkey breast	2½-3 lbs.  2½-3 lbs.  4-6 lbs.	16-20  18-22  8-14 per lb.  6-10 per lb.	Place wrapped chicken in dish. Unwrap and turn over after half the time. When finished, separate pieces and microwave 2 to 4 minutes more, if necessary. Let stand to finish defrosting. Place wrapped chicken in dish. After half the time, unwrap and turn chicken over. Shield warm areas with foil. Finish defrosting. If necessary, run cold water in the cavity until giblets can be removed. Place unwrapped hen in the oven breast-side-up. Turn over after half the time. Run cool water in the cavity until giblets can be removed. Place unwrapped breast in dish breast-side-down. After half the time, turn over and shield warm areas with foil. Finish defrosting. Let stand 1 to 2 hours in refrigerator to complete defrosting.

# Quick Reference Instructions

---

## Vent Fan

Press *VENT FAN* pad to turn vent fan to *HI*, *LO*, and *OFF*.

## Surface Light

Press once for bright surface light, twice for dimmer night light or press 3 times to turn off.

## Display ON/OFF

Press and hold *0* pad for 3 seconds to turn display on or off. Display cannot be turned off while oven is in operation.

## Scroll Speed

The display scroll speed can be changed. Press and hold *AM/PM* pad of about 3 seconds to access display. Press number pad 1-5 to set scroll speed.

## Clock

1. Press *CLOCK*.
2. Enter time of day.
3. Press *AM/PM* pad.
4. Press *CLOCK* pad. Clock is set.

## Minute Timer

1. Press *TIMER* pad.
2. Press desired time.
3. Press *TIMER* pad.

## Reminder

1. Press *REMINDER* pad.
2. Enter time of day you want the oven to signal.
3. Press *AM/PM* pad.
4. Press *REMINDER* pad.

## Child Lock

TO lock or unlock control, press and hold *STOP/RESET* pad for about 3 seconds.

## Pause or Cancel Cycle

Open door or press *START* pad to pause. Press *STOP/RESET* pad to cancel cycle.

## Complete Reminder

Complete Reminder is not adjustable.

## Program 1 Microwave Cooking

1. Place food in oven. Close door.
2. Press *PROGRAM 1 & 2* pad.
3. Press number pad to select desired cooking time.
4. If power level other than 100% is desired, press *COOKMATIC LEVEL* pad and number pad.
5. Press *START* pad.

## Program 2 Microwave Cooking

1. Place food in oven and close door.
2. Press *PROGRAM 1 & 2* pad.
3. Press number pads to select first cook time.
4. If power level other than 100% is desired, press *COOKMATIC LEVEL* pad and number pad.
5. Press *PROGRAM 1 & 2* pad.
6. Press number pads to select second cook time.
7. If power level other than 100% is desired, press *COOKMATIC LEVEL* pad and number pad.
8. Press *START* pad.

## Changing Cookmatic® Power Level

1. Place food in oven and close door.
2. Select cook or defrost program.
3. Enter numbers for cooking or defrosting time.
4. Press *COOKMATIC LEVEL* pad.
5. Press number for desired power level. Number displays.
6. Press *START*.

## One Step Cook (1-6)

1. Place food in oven and close door.
2. To select 1 to 6 minutes of cooking time, press desired number pad (1-6).
3. Oven stops, signals, and "FOOD IS READY" displays at end of cooking time. "READY" remains in display until door is opened or *STOP/RESET* pad is pressed.

## Auto Start

1. Place food in oven and close door.
2. Press *AUTO START* pad.
3. Enter desired start time.
4. Press *AM/PM* pad.
5. Enter desired cook or defrost program.
6. Press *START* pad.

## Auto Accu-Thaw®

1. Remove food from package, place in oven on microwave-safe dish and close door.
2. Press *ACCU-THAW®* pad.
3. Enter food weight.
4. Press *START* pad.

## Accu-Thaw®

1. Remove food from package, place in oven on microwave-safe dish and close door.
2. Press *ACCU-THAW®* pad twice.
3. Enter defrost time.
4. Press *START* pad.

---

### **Popcorn**

1. Remove outer wrapper from microwave popcorn.
2. Open oven door, place package of popcorn in center of oven floor, and close oven door.
3. Press *POPCORN* pad. Oven will start immediately.

### **Cook**

1. Place food in oven and close door.
2. Press *COOK* pad.
3. Press pad for desired food code.
4. Press number pads to enter food weight in ounces.
5. Press *START* pad. Oven will begin cooking.

### **Reheat**

1. Place food in oven and close door.
2. Press *REHEAT* pad.
3. Press number pad from *1* to *6* to select desired food type.
4. Press *START* pad.

### **Add 30 Seconds**

Each time *ADD 30 SECOND* pad is pressed 30 seconds is added to cooking time. Press pad and oven will start immediately.





