

Sears
owners
manual

MODEL NO.
358.350842
358.350870
358.350880

CAUTION:
Read Rules for
Safe Operation
and Instructions
Carefully

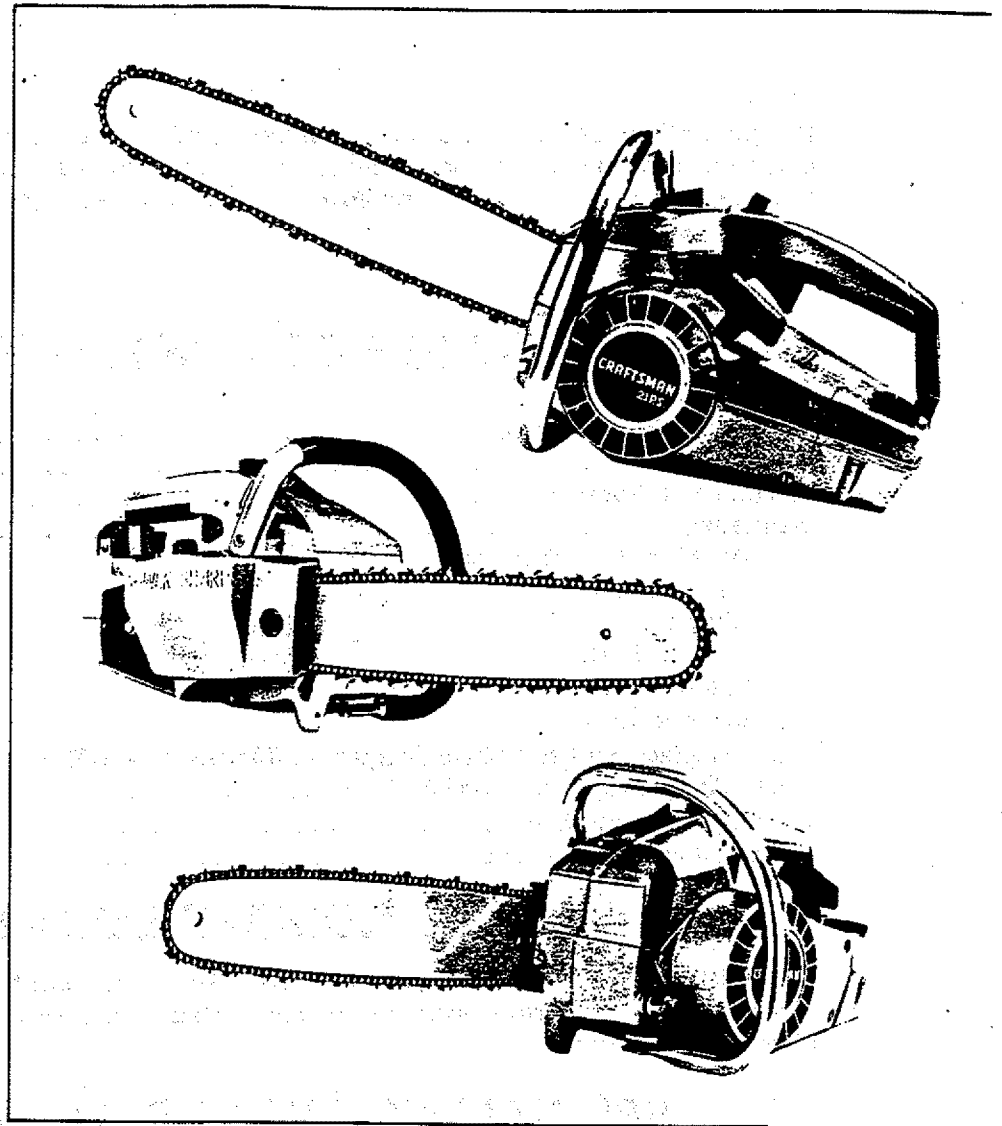

CRAFTSMAN

2.1 2.1PS 2.3PS/VL

CHAIN SAWS

- Assembly
- Operation
- Maintenance
- Repair Parts

Sears, Roebuck and Co., Chicago, Ill. 60684 U.S.A.
Simpsons-Sears Ltd., Toronto, Canada

Congratulations on your purchase of our new Craftsman gas chain saw. It is the finest gas chain saw available on the market today for the price you have paid. We ask that you take a few minutes to read the following instructions so you can enjoy the use of this new chain saw for many years to come.

TABLE OF CONTENTS

Bar and Chain Installation	1
Fuel and Oil	2
Starting and Stopping	3
Maintenance	4-8
Air Filter & Carburetor	
Fan Housing	
Clutch	
Exhaust Ports	
Spark Plug	
Bar and Chain	
Stone Replacement and Chain Sharpening (Models 358-350870 and 358-350880) .	7-10
Chain Sharpening (Model 358-350842)	11-12
Cutting With Your Saw	12-14
Parts List and Illustrations	15-30

MODEL NUMBER LOCATION

The Serial and Model Number of your chain saw is located on a flat surface under and in front of the throttle trigger.

Record the Serial Number and keep it in a safe place in case your saw is lost or stolen.

SPECIFICATIONS FOR ALL MODELS

Spark Plug:	Champion CJ8
Point Gap: (Ignition)	.017"
Spark Plug Gap:	.025"

Air Gap, Flywheel to Coil Lamination	.010"
Chain: 14" Bar ¼ Pitch-76 Drive Links	
Fuel: (½ pt.-8 oz.-SAE No. 30 Oil (SD) to 1 Gal. Gasoline)	16 to 1

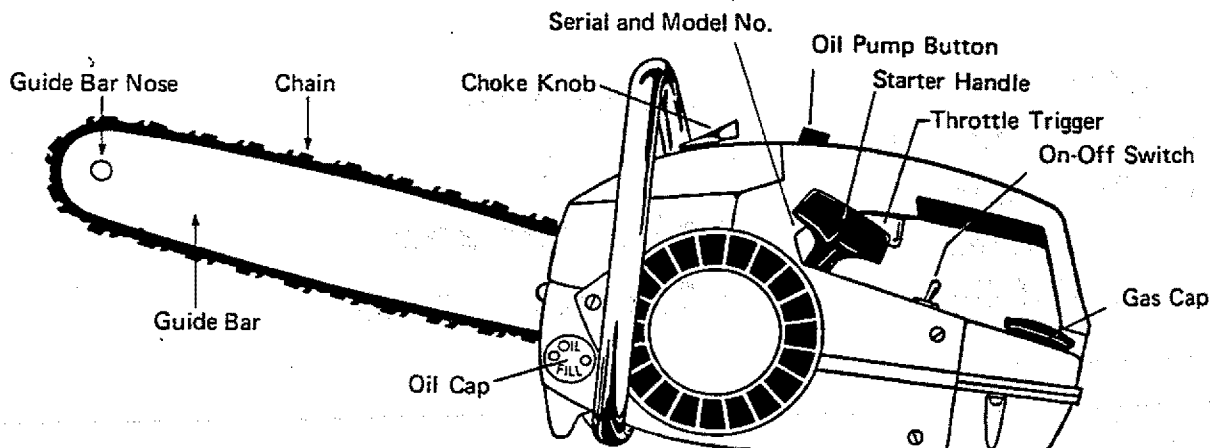

GUARANTEE

During the first ninety days, we will repair the Chain Saw, free of charge, if defective in material or workmanship.

If the Saw is used for commercial or rental purposes, the guarantee applies for thirty days.

This guarantee service is available by simply returning the Saw to any Sears store.

SEARS ROEBUCK AND CO. USA
SIMPSONS SEARS, LTD. CANADA

IMPORTANT rules for safe operation

1. Never operate a chain saw when you are fatigued.
2. Use safety footwear, snug-fitting clothing, and eye, hearing and head protection devices.
3. Always use caution when handling fuel. Move the chain saw at least 10 feet (3 m) from the fueling point before starting the engine.
4. Do not allow other persons to be near the chain saw when starting or cutting with the chain saw. Keep bystanders and animals out of the work area.
5. Never start cutting until you have a clear work area, secure footing, and a planned retreat path from the falling tree.
6. Always hold the chain saw firmly with both hands when the engine is running. Use a firm grip with thumbs and fingers encircling the chain saw handles.
7. Keep all parts of your body away from the saw chain when the engine is running.
8. Before you start the engine, make sure the saw chain is not contacting anything.
9. Always carry the chain saw with the engine stopped, the guide bar and saw chain to the rear, and the muffler away from your body.
10. Never operate a chain saw that is damaged, improperly adjusted, or is not completely and securely assembled. Be sure that the saw chain stops moving when the throttle control trigger is released.
11. Always shut off the engine before setting it down.
12. Use extreme caution when cutting small size brush and saplings because slender material may catch the saw chain and be whipped toward you or pull you off balance.
13. When cutting a limb that is under tension be alert for spring back so that you will not be struck when the tension in the wood fibers is released.
14. Keep the handles dry, clean and free of oil or fuel mixture.
15. Operate the chain saw only in well ventilated areas.
16. Do not operate a chain saw in a tree unless specifically trained to do so.
17. All chain saw service, other than the items listed in the Owner's Manual maintenance instructions, should be performed by competent chain saw service personnel. (e.g., if improper tools are used to remove the flywheel, or if an improper tool is used to hold the flywheel in order to remove the clutch, structural damage to the flywheel could occur which could subsequently cause the flywheel to burst.)
18. Guard against kickback. Kickback is the upward motion of the guide bar which occurs when the saw chain at the nose of the guide bar contacts an object. Kickback can lead to dangerous loss of control of the chain saw.

TO AVOID KICKBACK:

Hold the chain saw firmly with both hands. Don't over reach. Don't let the nose of the guide bar contact a log, branch, ground or any other obstruction. Cut at high engine speeds. Don't cut above shoulder height. Follow manufacturer's sharpening and maintenance instructions for the saw chain.

BAR AND CHAIN INSTALLATION

Model 358-350842 (Craftsman 2.1)
Model 358-350870 (Craftsman 2.1 PS)
Model 358-350880 (Craftsman 2.3 PS/VL)

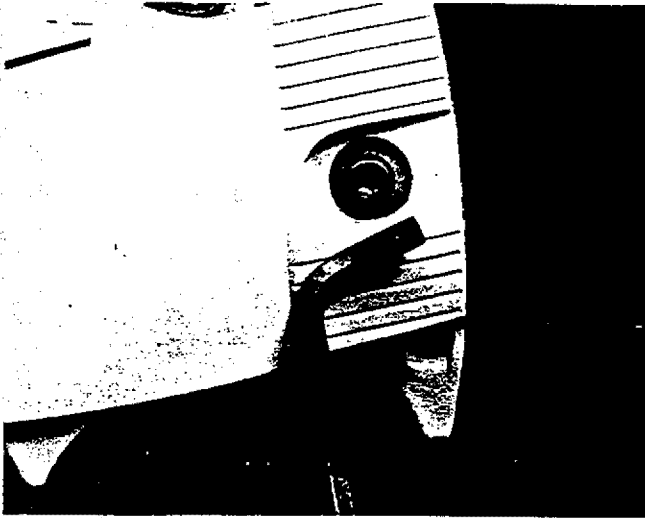

Fig. 1

1. Remove the bar mounting screw, washer, and bar clamp with the bar wrench supplied with your saw. Figure 1. After the bar clamp is removed there will be two guide plates mounted on the guide bar studs. Remove one of these plates only. After guide bar and chain have been installed, replace guide plate with bevel side to front of unit and with flange sides out (fig. 1A). Install bar clamp but do not tighten clamp screw beyond finger tight so chain adjustment can be made.

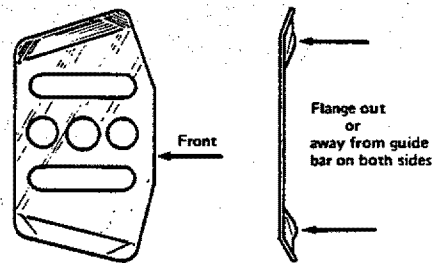

Fig. 1A

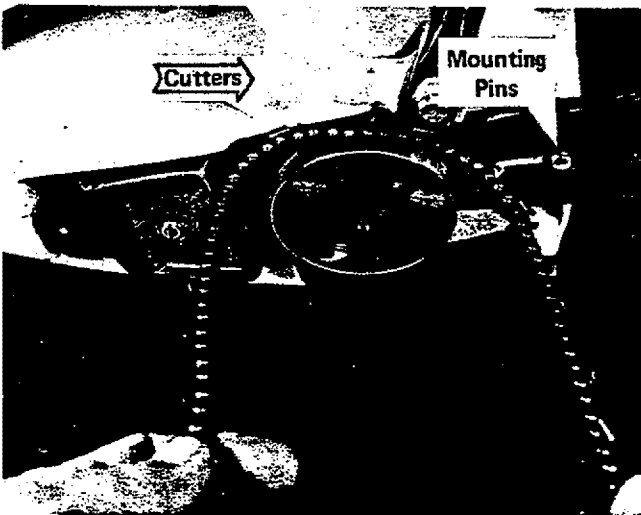

Fig. 2

2. Mount the slotted end of the bar over the mounting pins and slide bar to the rear. Figure 2.

3. Hold about 8" of chain between your hands, with sharp edge of cutters facing your right hand. Form an arc with the chain and place it (cutters first) over the top of clutch drum. Once the chain is over the clutch drum, turn the chain so the drive link tangs engage the sprocket teeth. Figure 2. On Model 358-350870 (Craftsman 2.1 PS) and model 358-350880 (Craftsman 2.3 PS/VL) engage chain drive links in groove of rim sprocket teeth. Chain travels in direction arrow indicates in Figure 2.

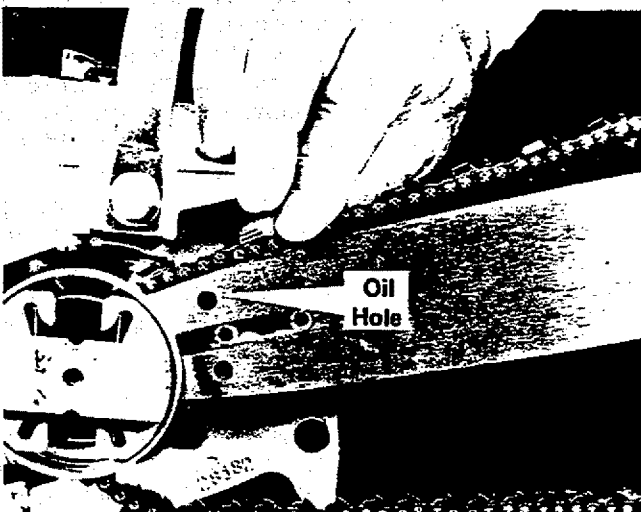

Fig. 3

4. Starting at the top of the bar, gradually work the chain into the groove of the bar until all drive links are engaged in the bar groove. Be sure cutters face forward on top of bar. Figure 3.

CHAIN INSTALLATION (CONT'D.)

Model 358-350842 (Craftsman 2.1)

Model 358-350870 (Craftsman 2.1 PS)

Model 358-350880 (Craftsman 2.3 PS/VL)

5. Slide bar forward and fit adjustment hole in bar over adjusting pin. If you have trouble fitting the adjusting pin into the hole, use a small ended screwdriver to guide the pin into the hole. The pin may have to be adjusted backwards or forwards with adjusting screw (Figure 4B) to line up with the hole in the bar. Figure 4A.

6. Replace outside guide plate, bar clamp, washer, and screw. Tighten bar clamp screw finger tight. Make sure hole in bar and adjusting pin are properly aligned.

7. Raise tip of bar and turn the adjusting screw clockwise to tension the chain. Figure 4B. There should be light tension in the chain, but the chain should move around the bar freely when pulled by hand.

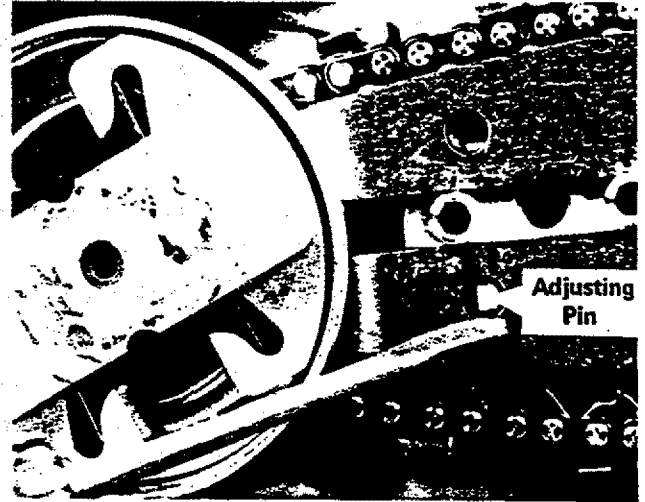

Fig. 4A

Be careful, the chain teeth are sharp! Continue to hold the nose of the bar up and tighten the bar clamp screw with the wrench provided. Now pull the chain along the bar to be sure you have the right tension. If the chain is too tight, loosen the bar clamp screw slightly, turn the adjusting screw counterclockwise a little and lift up on the chain. Then tighten bar clamp screw. Recheck chain tension. Lift the chain off of the middle of the length of the bar. If it is loose enough for the tangs to come out of the bar groove, the chain is too loose. You should only be able to lift the chain 1/8" from bar. Whenever using a new chain, check chain tension often, as new chain stretches. After the chain has been used for awhile, it is a good practice to check chain tension every time the gas tank is filled. Proper chain tension is very important to help insure maximum performance from your chain saw.

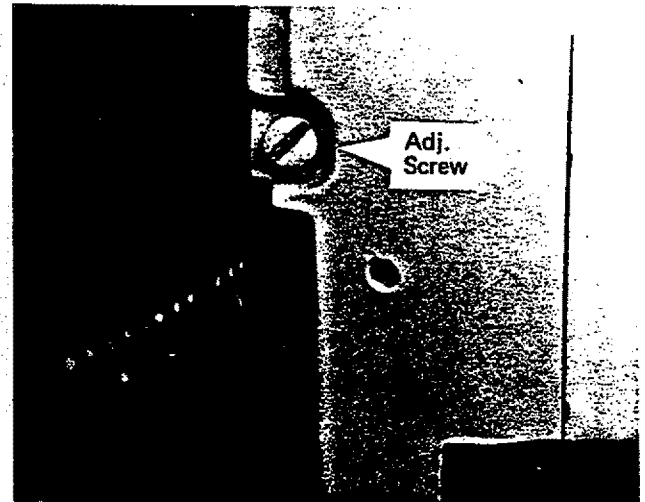

Fig. 4B

FUEL MIX

Model 358-350842 (Craftsman 2.1)

Model 358-350870 (Craftsman 2.1 PS)

Model 358-350880 (Craftsman 2.3 PS/VL)

Your chain saw is powered by a 2 cycle engine and requires a fuel mixture of gasoline and oil. The proper fuel mixture is 16 parts gasoline to 1 part oil, or 1/2 pint (8 oz.) Sears oil Cat. 32-36555 to one gallon or one imperial gallon of "regular" leaded gasoline. If Sears oil is not

available, use SAE No. 30 nondetergent oil (MS or better). Do not use multi-viscosity oils (10W-30) or reprocessed oils in your fuel mix. Prepare the mixture in a separate container and shake well to assure complete mixing. Do not use dirty oil or old (stale) gasoline.

CHAIN OIL

Model 358-350842 (Craftsman 2.1)

Model 358-350870 (Craftsman 2.1 PS)

Model 358-350880 (Craftsman 2.3 PS/VL)

Remove the oil fill cap and fill the oil tank with S.A.E. No. 30 (SD) oil. This oil is for chain and bar lubrication and is in no way connected with the fuel mix. The oil tank should be filled every time the fuel tank is filled. For cold weather operation. Above 40 degree F use SAE 30 oil: 40 to 0 (zero) degree use SAE 10: Below 0 degree F use 10% kerosene and 90% SAE 30. Be careful to keep the fuel mix

and oil free from contamination. Wipe off the saw after filling the fuel and oil tanks if either has been spilled. Under normal cutting conditions, push the oil button once every 10 seconds. Under heavy, or dirty cutting conditions, push the oil button once every 5 seconds. This will prevent the bar and chain from burning.

IMPORTANT

MODEL 358-350870 (Craftsman 2.1 PS)
MODEL 358-350880 (Craftsman 2.3 PS/VL)

Sears Models 358-350870 (Craftsman 2.1 PS) and 358-350880 (Craftsman 2.3 PS/VL) are equipped with both automatic and manual oiler for lubrication of the guide bar and chain. The automatic oiler operates when the saw is running and may be assisted by pushing the manual oiler button if additional oil is required for extreme cutting conditions.

1. Fill the oil tank. (see paragraph under CHAIN OIL) Fill oil tank each time fuel tank is filled.
2. Prime the oiler system before starting engine by pushing manual oiler button until oil is visible at top of bar.
3. Start engine. Check automatic oiling by pointing guide bar towards a clean surface with engine running at cutting speed. Oil should be seen on clean surface as it is thrown off end of guide bar. **WARNING: Tip of guide bar should be several inches away from clean surface — but do not let moving chain touch any kind of surface because saw could kick back and cause injury.**
4. Sears model 358-350842 has a manual oiler only. Push the oiler button every ten seconds during cutting to provide proper lubrication of bar and chain.

STARTING AND STOPPING

Model 358-350842 (Craftsman 2.1)
Model 358-350870 (Craftsman 2.1 PS)
Model 358-350880 (Craftsman 2.3 PS/VL)

NOTE: For your convenience, starting instructions are also printed on the saw below the handle, beside the "on"-"off" switch.

1. Fill oil and fuel tanks. Check chain tension. Pump oil button until oil appears on bar.
2. Push ignition switch forward to "on".
3. Push choke lever "on" (to right).
4. **STARTING** (This is the recommended starting position) See Figure 5. Hold saw away from body with right hand and elbow slightly bent, see Fig. 5. Squeeze trigger. Push saw straight away from body and at same time pull starter handle. Repeat action until engine fires. Push choke off (to left) and repeat starting procedure until engine runs. Hold on to starter handle while allowing the rope to rewind. **DO NOT PULL STARTER HANDLE OVER 12" TO 14" FROM ENGINE.**
5. Release trigger to idle engine.
6. If engine does not fire after 5 to 6 pulls, it may be flooded. Push choke off (clockwise) and pull starter several times while holding trigger at wide open throttle. If saw has run out of fuel, 8 to 10 pulls with choke on may be required to restart engine. When restarting a hot engine, or one which has just been refueled, you may have to

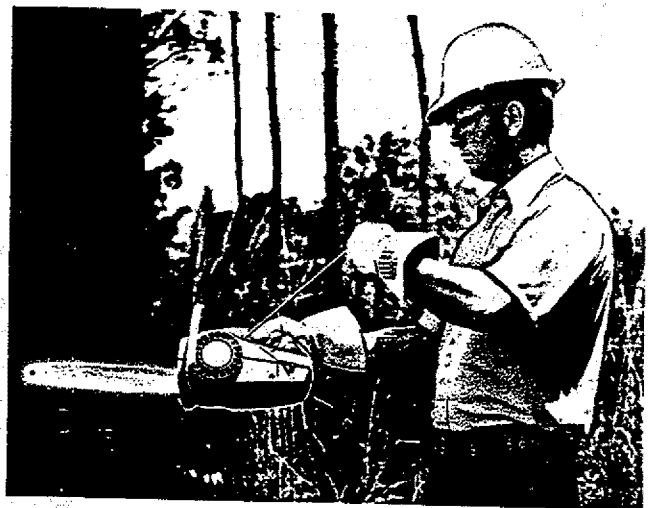

Fig. 5

use the choke in order to clear the vapors out of the carburetor.

7. To stop engine, pull switch back to "off" position. The engine may also be stopped by pushing the choke lever to the right (counter-clockwise).

CARE AND MAINTENANCE

Model 358-350842 (Craftsman 2.1) Model 358-350870 (Craftsman 2.1 PS) Model 358-350880 (Craftsman 2.3 PS/VL)

Follow these helpful hints on care and maintenance to get the best possible service from your saw, to prevent major breakdown and costly repair bills. Careful servicing of your saw is one of the most important steps in preven-

tive maintenance. Should your saw develop trouble that you are not prepared to handle, take it to a Sears Store for service.

AIR FILTER AND CARBURETOR

To clean the air filter or adjust the carburetor, loosen the filter cover screw (ahead of choke knob) and remove it and the air filter cover. The air filter element should be removed after every 10 hours use and rinsed out in gasoline or fuel and oil mix. Squeeze it out well and be sure the filter element fits into the cavity neatly without folds, and flush with the top surface. See figure 6. Allow filter element to dry before restarting engine or mixture will be too rich.

CARBURETOR ADJUSTMENTS

General:

Carburetor adjustments are made at our factory and will be correct for most applications. Further adjustments may be required due to altitudes above 4000 ft., brands/age of fuel used, and atmospheric conditions.

Caution:

The needles and associated parts will be damaged if over-tightened.

Adjustments:

Step 1. (Refer to Figure 7) — Remove carburetor cover. Turn high speed and low speed needles clockwise until they stop. Remember! Don't Over-Tighten.

Step 2. Turn high and low speed needles counterclockwise one full turn.

Step 3. Start engine in the same manner as described on page 3 under "Starting and Stopping". The chain saw engine should be run four or five minutes to bring it to operating temperature.

Step 4. (Low Speed Needle Adjustment) — Squeeze the throttle trigger and hold it in for five or six seconds. This should clear the combustion chamber of built up fuels.

Step 5. Squeeze throttle trigger quickly. The engine should accelerate smoothly. If it does not, turn low speed needle counterclockwise 1/16 of a turn and squeeze throttle quickly again. Continue turning low speed screw 1/16 of a turn at a time until smooth acceleration is accomplished.

Step 6. (High Speed Needle Adjustment) — Squeeze throttle trigger all the way in. Test cut a piece of wood.

Step 7. If engine speed begins to fade, turn high speed needle counterclockwise 1/16 of a turn and make another test cut. Continue this until fading is corrected.

Step 8. If there is an excessive amount of smoke in the exhaust, turn high speed needle 1/16 of a turn clockwise until excessive smoke is reduced.

Step 9. (Idle Speed Adjustment) — Turn the idle speed screw (Figure 7) clockwise until the chain begins to move. Now slowly turn idle speed screw counterclockwise until chain stops moving.

PLEASE NOTE: Observe "Rules For Safe Operation" when adjusting carburetor.

To adjust the high speed needle, first make a test cut with the saw. If the engine power seems to fade in the cut, the mixture is set too lean. Remove the saw from the cut. The high needle should be turned counterclockwise slightly. If there seems to be an excessive amount of smoke in the exhaust, the mixture is set too rich. Remove the saw from the cut. The high speed needle should be turned clockwise slightly. After each adjustment make a test cut to check performance.

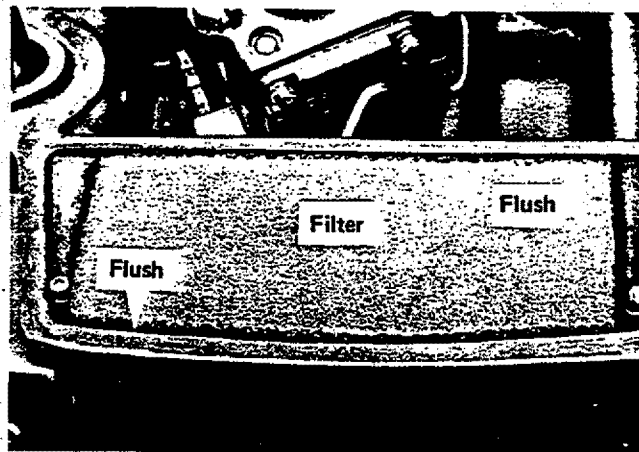

Fig. 6

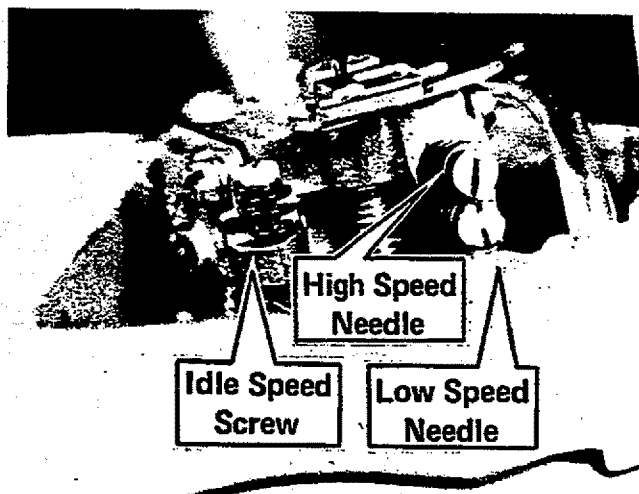

Fig. 7

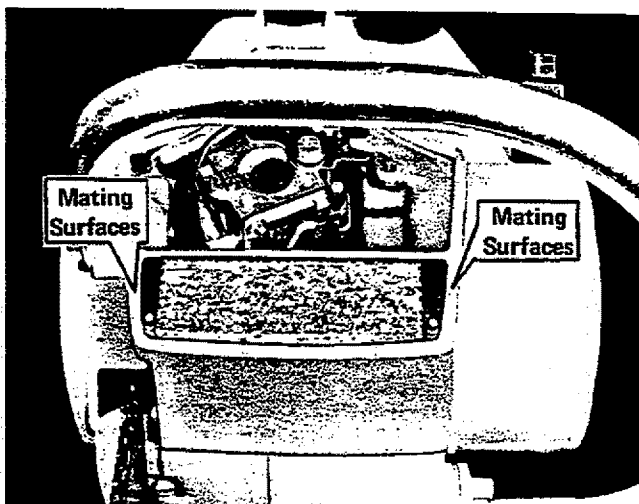

Fig. 8

AIR FILTER AND CARBURETOR (CONT'D)

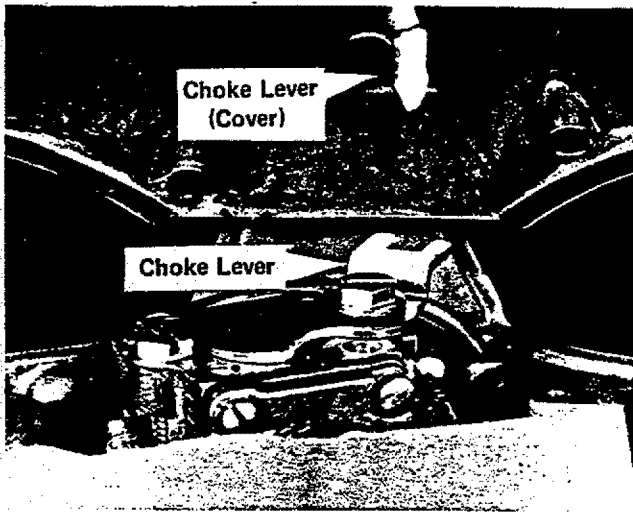

Fig. 9

When finally adjusted, the high speed needle will usually be $7/8$ to $1-1/8$ turns open (counterclockwise). Try to keep sawdust away from the carburetor when the filter cover is removed. Be sure to hold the saw firmly with both hands while cutting. Before replacing the air filter cover, be sure to clean off the mating surfaces of cover and carburetor box. See figure 8.

Turn choke knob to the right (counterclockwise) and close choke lever over carburetor so that the finger on the choke lever (cover underside) lines up with the slot in the choke lever over the carburetor. Replace the filter cover and tighten cover screw. Figure 9.

FAN HOUSING REMOVAL

Model 358-350842 (Craftsman 2.1)
Model 358-350870 (Craftsman 2.1 PS)
Model 358-350880 (Craftsman 2.3 PS/VL)

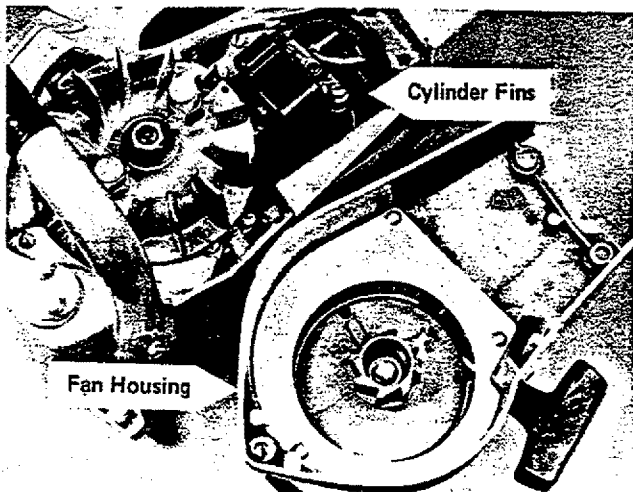

Fig. 10

Remove the three screws holding the fan housing to the saw. See Figure 10. Clean out any loose sawdust in fan housing. Clean out any chips and sawdust that have accumulated between the cylinder fins. Use compressed air if available. If cooling fins are blocked, the cylinder will run too hot and could adversely effect power and engine life.

REPLACING THE FAN HOUSING:

1. Move the housing into position, pulling the starter rope slightly to make sure the starter dogs are in position around the starter pulley notches.
2. Replace the three fan housing mounting screws, short screw to the front.

CLUTCH

Model 358-350842 (Craftsman 2.1)
Model 358-350870 (Craftsman 2.1 PS)
Model 358-350880 (Craftsman 2.3 PS/VL)

If the clutch must be removed from your saw, it is best to return the saw to your Sears Store, as they have the proper equipment to do the job. However, if you must remove the clutch, follow these instructions carefully.

1. Remove the bar and chain.
2. Remove the rubber connector from the spark plug.
3. Remove the fan housing, figure 10, and secure the flywheel from turning. This is best accomplished by wedging a socket wrench or an end wrench between the flywheel nut and the front handlebar. See Figure 11. Clutch removal should not be attempted without first removing the fan housing, as damage to the starter or flywheel could occur.

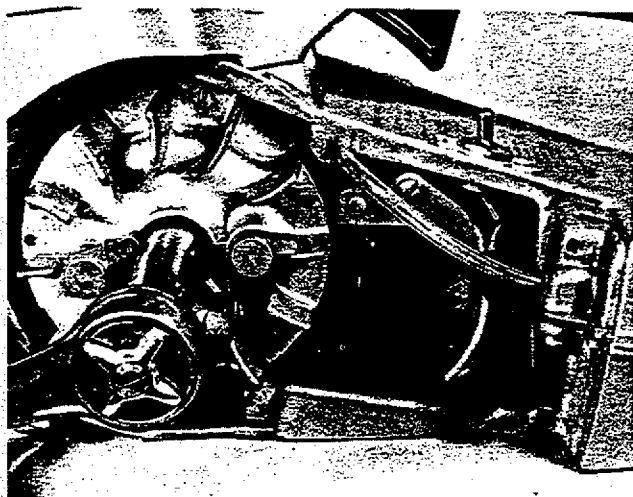

Fig. 11

CLUTCH (CONT'D)

4. Use a soft, blunt ended punch and hammer to turn the clutch spider off of the crankshaft. Use one of the two notches provided for this purpose and turn the clutch spider clockwise, as the threads are left-hand threads. See Figure 12. Do not pound directly on the ends of the spider, or clutch shoes, to turn it. Use only the notches provided. If the spider does not come loose after a few strokes, take the saw to your Sears Store and let them remove the spider. After the spider has been removed, the clutch drum and sprocket may be removed. All parts should be inspected for wear, especially the sprocket. If it is severely worn, have it replaced. It is the most economical in the long run if the chain and sprocket are replaced at the same time. When reinstalling the clutch drum, apply a coat of oil to the bearing in the clutch drum. Reinstall the spider, counterclockwise. Just a few taps with the hammer and punch are sufficient, as the spider will tighten itself when you start cutting wood with the saw.

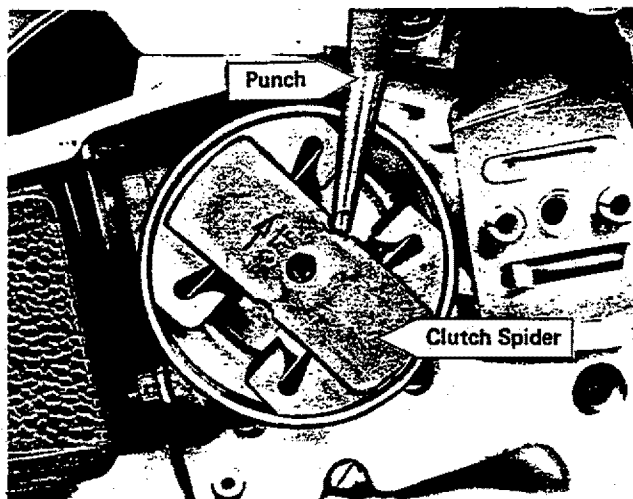

Fig. 12

Follow the instructions in "Bar and Chain Installation" for reinstalling the bar and chain. Replace the fan housing and reconnect the spark plug lead.

EXHAUST PORT CLEANING

Model 358-350842 (Craftsman 2.1) Model 358-350870 (Craftsman 2.1 PS) Model 358-350880 (Craftsman 2.3 PS/VL)

After lengthy running time, carbon deposits will build-up in the exhaust ports causing the engine to lose power. The exhaust ports should be cleaned every 25 to 30 hours. Pull the rubber connector from the spark plug and remove the spark plug. Remove the muffler. With the exhaust ports exposed, pull the starter rope until the piston moves far enough to close the exhaust ports. See Figure 13. Use a wooden stick, about ice cream bar stick size, to scrape the carbon deposits from the exhaust ports. Do not use a metallic scraping tool, as you may scratch the piston. Turn unit over and shake out all loose carbon. If compressed air is convenient, blow loose carbon from exhaust ports. After cleaning the ports, pull the starter rope to allow the piston to clear the cylinder of any material which may have fallen into the cylinder. Clean screen with wire brush and replace the muffler. Clean and gap the spark plug if necessary. Replace the spark plug and the rubber connector.

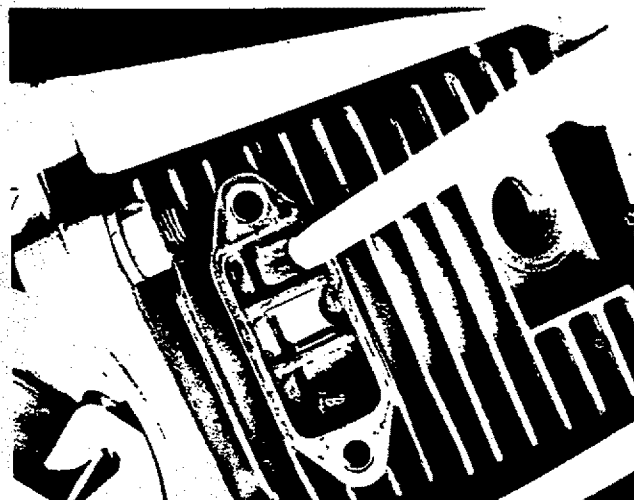

Fig. 13

SPARK PLUG

Model 358-350842 (Craftsman 2.1) Model 358-350870 (Craftsman 2.1 PS) Model 358-350880 (Craftsman 2.3 PS/VL)

If the spark plug is not clean and properly gapped, the engine will be hard to start and will not deliver the best performance. The spark plug should be cleaned and gapped every 25 hours. Remove the rubber connector on the spark plug and remove the spark plug. Use a wire brush or a pocket knife to clean deposits from the electrodes of the spark plug. Be careful when removing, cleaning, gapping, and replacing the spark plug. If it is damaged it will not work properly and must be replaced. The proper gap between the spark plug electrodes is .025". (use wire or flat gauge) Figure 14. After the spark plug has been cleaned and gapped, replace it in the cylinder and attach the rubber connector.

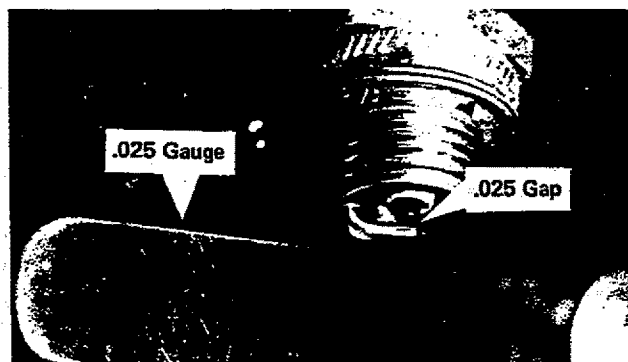

Fig. 14

Model 358-350880 (Craftsman 2.3 PS/VL)

The rubber vibration mounts are designed so that a failure of one of the mounts will not affect the safety of the saw. Operation of the saw with a broken rubber mount may cause excessive wear to other components, resulting in a hazardous situation. Should a rubber mount break, take it to a Sears Store immediately and have it replaced.

Check all vibration mount screws and nuts for tightness every two to three hours of operating time.

Craftsman 2.1 PS and Craftsman 2.3 PS/VL are equipped with a sprocket nose bar. The sprocket nose does not require grease. Bearings have been greased and sealed at the factory. Remember, keep the saw chain well oiled. A well oiled saw chain will greatly increase the life of saw chain, bar and saw chain drive sprocket.

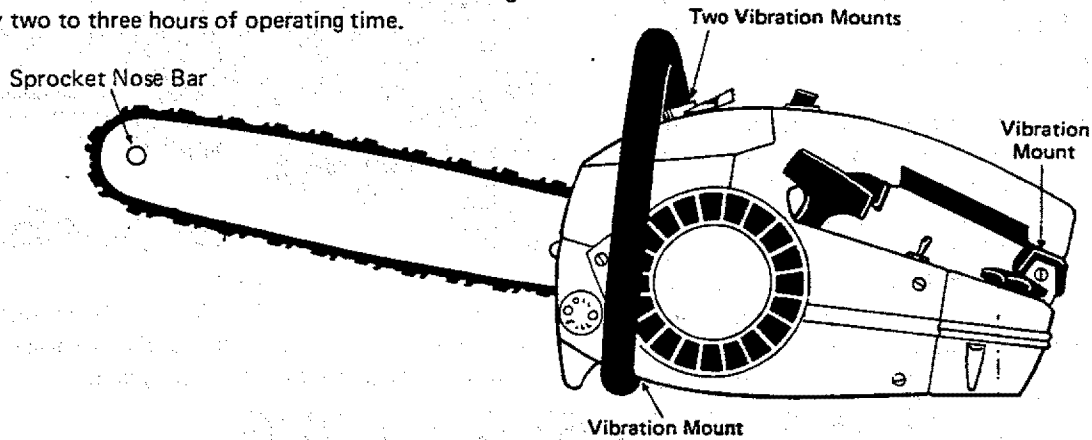

HOW TO SHARPEN YOUR CHAIN

Model 358-350870 (Craftsman 2.1 PS) Only

Model 358-350880 (Craftsman 2.3 PS/VL) Only

OPERATING—STONE REPLACEMENT AND CHAIN FILING WITH POWER SHARP

OPERATING INSTRUCTIONS

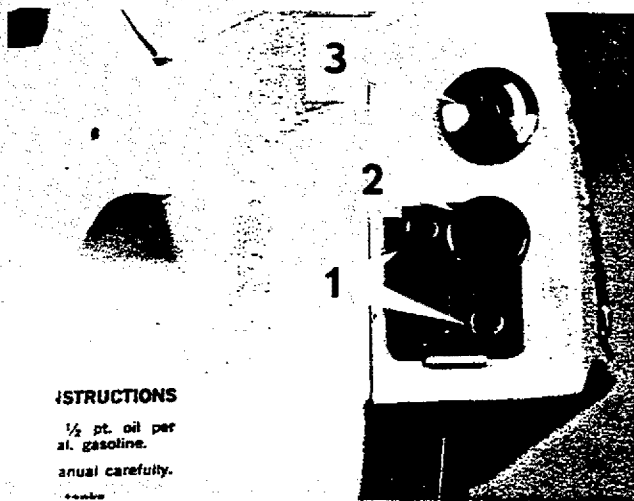

INSTRUCTIONS

1/2 pt. oil per
al. gasoline.
annual carefully.

Fig. 15

- Never advance the depth knob before checking contact between stone and chain. If stone is contacting the chain, the chain can, in most cases, be sharpened without advancing the knob.
- Never advance the depth knob more than one click at any one sharpening.
- After sharpening, push the oscillating knob forward and to the right and snap into the locking slot (No. 2, Figure 15).
- Do not loosen screws (No. 1, Figure 15). The two screws hold the aligning plate that has been properly adjusted at the factory.

Before sharpening chain, tension (tighten) to where all tie straps (no. 1, fig. 19) rest on guide bar. Pull chain upward from top of guide bar. The bottom of the drive links should be even with guide bar rails for proper tension (see arrow in Figure 19 page 9). Clean loose wood chips from around sharpening mechanism (see fig. 18). Rotate depth adjustment knob counterclockwise (opposite direction of arrow on knob) until tight (no. 3, fig. 15). Start engine and open throttle to about 1/2 open. Push oscillating knob (no. 2, fig. 15) to the extreme left out of locking slot and pull back on knob. If no sparks are visible coming from the top of the guide bar in front of the bar clamp, release oscillating knob and turn depth adjusting knob (no. 3, fig. 15) one click in direction of arrow. Pull back on oscillating knob again. Repeat until a small shower of sparks can be seen. When sharpening stone contacts chain (indicated by sparks), move the oscillating knob rapidly side to side. This side to side movement sharpens the chain and will also dress the stone with an even wear. Sharpening a dull chain should require about 5 to 10 seconds. Do not oversharpen.

When the chain needs sharpening again, the depth knob should not be turned more than one click. One click advances the stone sufficiently to sharpen the chain. This allows the operator to sharpen the chain without fear of grinding too much from the chain.

HOW TO REPLACE YOUR SHARPENING STONE

Model 358-350870 (Craftsman 2.1 PS) Only Model 358-350880 (Craftsman 2.3 PS/VL) Only

Figure 16, Remove guide bar screw and bar clamp. Loosen chain tension adjusting screw to relieve chain tension. Slip bar off adjusting pin and slide bar back towards sprocket as far as possible and remove chain.



Fig. 16

Figure 17, After guide bar clamp is removed, CLEAN inside of clamp thoroughly. Slide stone carrier assembly left to the sharpening position. Remove oscillating knob and stud (No. 1, Figure 17) by turning counterclockwise. Use a 5/16 open end wrench on flats located at extreme bottom end of oscillating knob. (Stud is threaded into stone carrier assembly.)

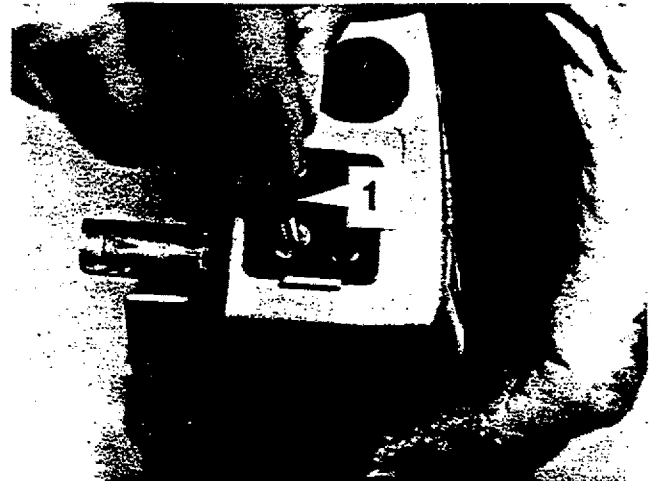

Fig. 17

Figure 18, Slide stone carrier (No. 1) out of bar clamp and off pivot pin (No. 2). Clean pivot pin and place two drops of oil on shaft and spread with finger. Replace new stone carrier (No. 1) on pivot pin (No. 2) and slide in position. Be sure that adjusting arm (No. 3) is placed under adjusting arm of depth adjusting block, (No. 4). Replace oscillating knob and stud and tighten securely. (Use 5/16 end wrench to tighten 1/4 turn after finger tight.) Flats located at extreme bottom of oscillating knob will accommodate 5/16 end wrench.

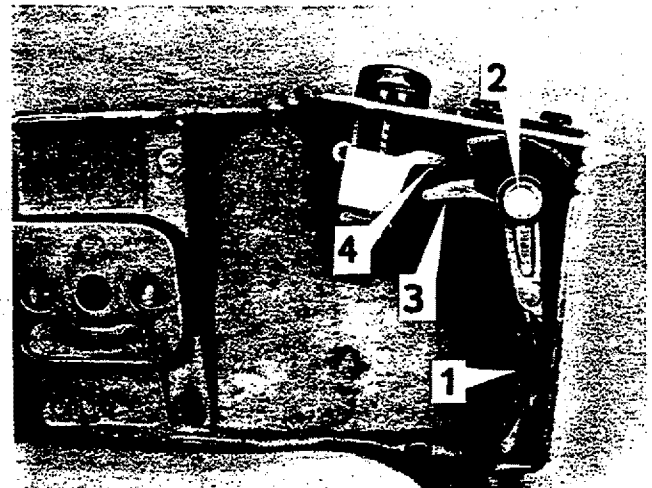

Fig. 18

SHARPENING STONE REPLACEMENT INSTRUCTIONS (CONT'D.)

Model 358-350870 (Craftsman 2.1 PS) Only
Model 358-350880 (Craftsman 2.3 PS/VL) Only

Before installing guide bar and new chain, clean sides of guide bar, side of guide bar mounting pad (where guide bar mounting studs are located) and inside mounting pad of bar clamp thoroughly. A wood chip or debris between guide bar and mounting pads could cause chain teeth to be sharpened long on one side and chain would cut side wise. A stone improperly aligned will cause the same problem.

Tighten chain tension until all tie straps (No. 1, Figure 19) rest on guide bar and when pulled at top, the bottom of the drive links will pull up even with guide bar rail (No. 2, Figure 19). Be sure chain has this tension anytime the chain is being sharpened. Under normal conditions your chain should be sharpened once after 2 or 3 tanks of fuel have been consumed.

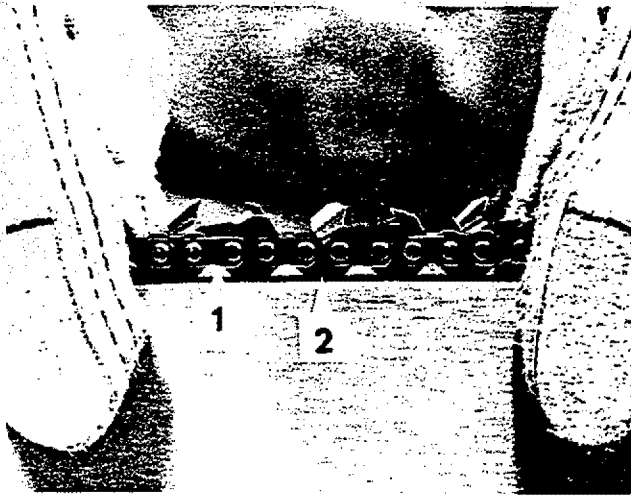

Fig. 19

FILING INSTRUCTIONS

Model 358-350870 (Craftsman 2.1 PS) – 358-350880 (Craftsman 2.3 PS/VL) Only

1/4" PITCH TYPE 89

(For use on chain saws with power sharp systems)

This chain was so designed that approx. 80% of the needed sharpening is accomplished by your saw's built-in-sharpener. While the chain is being sharpened by the built-in-sharpener, the cutting edges of the cutters are gradually being altered. 89 series chain is designed and engineered to efficiently cut wood. If rocks, nails, or other foreign materials are cut, more frequent sharpenings will be required.

Fig. 20

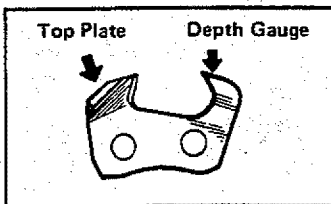

Fig. 21

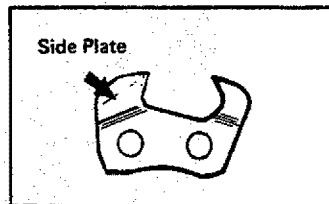

Fig. 20

Just before the 5th or 6th Power Sharp sharpening, the side plates should be filed. This task can be done easily and quickly with a Sears file and guide No. 32-36516.

Fig. 21

In abnormal use, in sand, rocks and abrasive materials, side plates should be checked more often. Damage to the cutters caused by abrasive materials usually results in "discoloration spots" where the chrome has been worn away. Cutter side plates should be filed until these spots are removed.

FILING INSTRUCTIONS (CONT'D.)

Model 358-350870 (Craftsman 2.1 PS) – 358-350880 (Craftsman 2.3 PS/VL) Only

TO SHARPEN SIDE PLATES

1. Tension chain so it will be snug, won't rock or wobble on the bar. Figure 22.
2. Place file and guide on top of chain, allowing guide to rest on top of cutter and depth gauge. Figure 23.
3. Determine filing direction. File stroke should be from inside to outside of cutter or away from yourself. Figure 24. Keep reference marks on file guide parallel with chain and chain guide bar. This will keep cutter angle at 22° . This is the same angle contained on a new cutter. Figure 24. Use long smooth filing strokes.
4. File all cutters on one side of chain, then move to the other side and file all cutters. This will save you time.

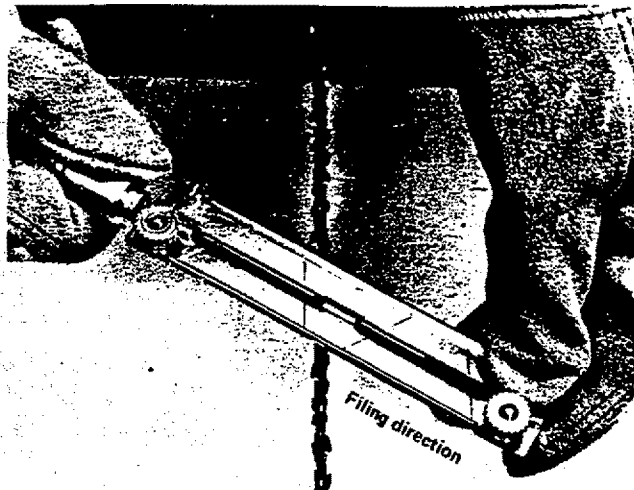

Fig. 22

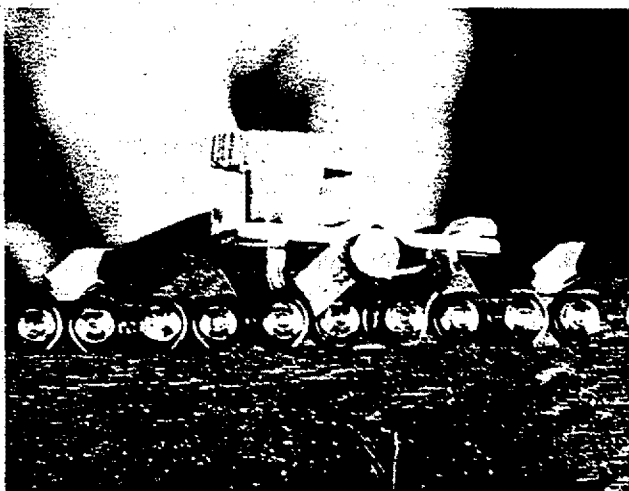

Fig. 23

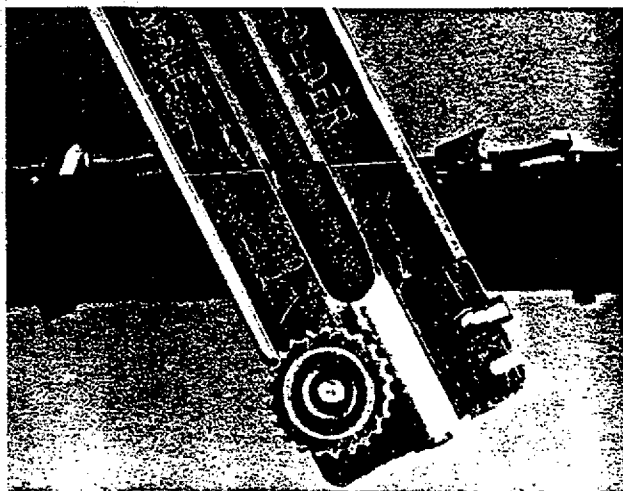

Fig. 24

If you have filed the cutters correctly, the cutters on your Power Sharp chain will look like top illustration. Figure 25. Correct filing will produce a small projection ($1/32''$). Use the notch and mark on either end of your file holder to check $1/32''$ projection. Figure 25.

SUGGESTIONS FOR OBTAINING SHARP CUTTING EDGES

1. Normal sharpening is accomplished by the built-in sharpener.
2. File cutters only when dull and attempt to keep all cutters the same length. The side plates should always be kept approximately $1/32$ of an inch longer than the top plate.
3. Preserve the original filing angles carefully and uniformly.
4. Care should be taken never to file into the bottom of the top plate. Keep guide lines on file guide aligned with chain and guide bar (Figure 24).

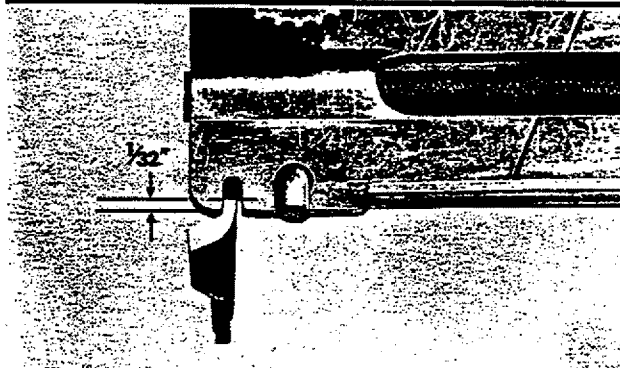
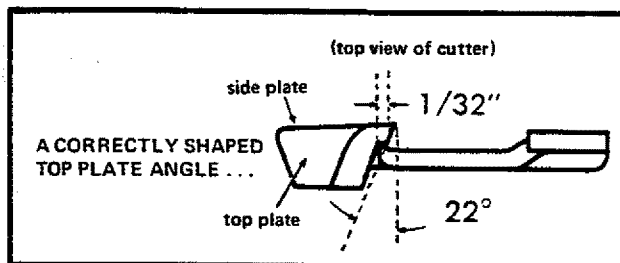

Fig. 25

FILING INSTRUCTIONS

Model 358-350842 (Craftsman 2.1)

Your wood cutting chores will be a lot easier if the chain is always properly sharpened and tensioned. If you notice cutting becoming difficult and you have to push on the saw to make it cut and you notice the chain "walking"

sideways in the cut, this is a good indication that the chain is dull and needs sharpening. Keep in mind that if you let the chain cut in the dirt you will dull it at once. Stop the engine and sharpen the chain. Cutting with a dull chain puts an excessive load on both the bar and chain and will greatly shorten their life. If you have never purchased a bar and chain, you will be surprised how costly they are.

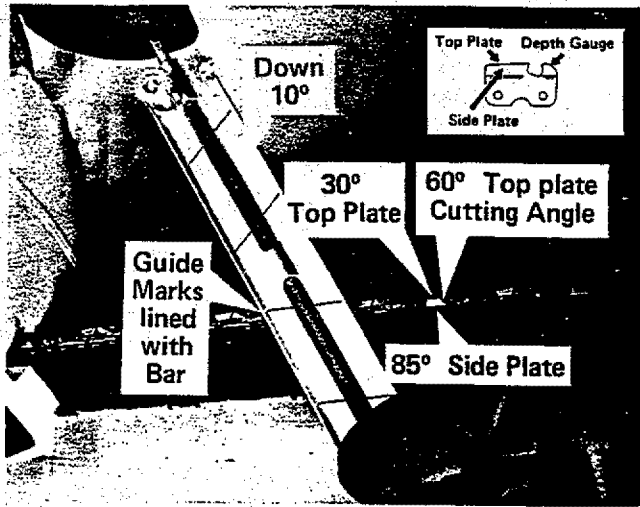

Fig. 26

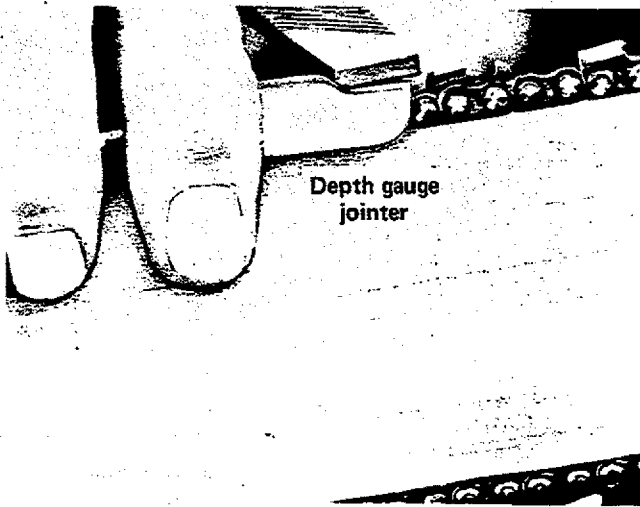

Fig. 27

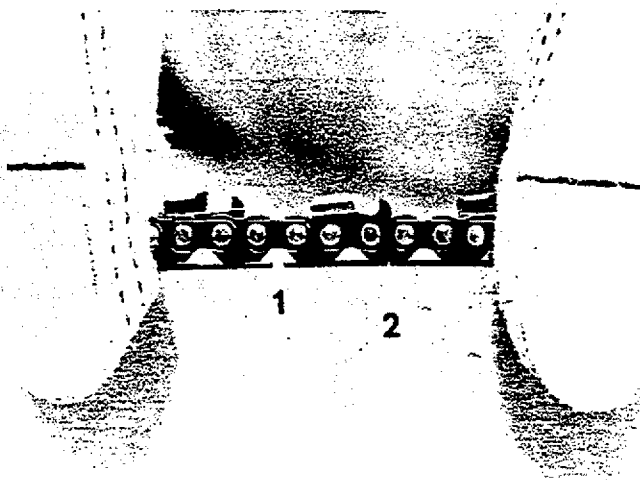

Fig. 28

To properly sharpen your chain, you will need a file holder, the correct size file (5/32" dia.), and .025 Depth Gauge jointer. (See page 29). Be careful when handling saw chain. Remember that even though the cutters are too dull to cut wood, they'll still cut fingers.

1. If possible, remove the chain from the saw and put it in a saw filing vise. If you do not have a filing vise, increase the chain tension on the bar and sharpen the chain while it is on the bar.
2. There are three angles that must be maintained for a properly sharpened chain. See Figure 26. All three of these angles can be maintained accurately by using a file holder and file.
3. Place the file holder so it rides on both cutter top plate and depth gauge (Fig. 26) with guide marks in line with the bar. File the cutters on the side of the chain away from the cutting edge. Apply pressure on the forward stroke only. See Figure 26.
4. Hold file handle down 10 degrees as you make a few firm strokes away from your self, applying pressure against the cutting edge. Apply pressure on the forward stroke only. See Figure 26.
5. Sharpen all cutters on one side of chain, then work from other side of chain and repeat sharpening procedure for opposite side cutters. Be sure to file all cutters uniformly.
6. To set all depth gauges at the same level, place the Depth Gauge jointer, Part No. 55005, over each depth gauge and file the depth gauge with a flat file until it is level with the jointer, then round off the leading edge of each depth gauge. See Figure 27. File the depth gauges after each four to five times the chain is filed. It is not necessary to file depth gauges after every chain sharpening. When sharpening the chain, also check the bar to see if there are any burrs on the rails of the bar, especially around the nose. File away the burrs with a flat file. Be sure to clean off filings.
7. After sharpening all teeth and setting all depth gauges, clean off the chain and re-set chain tension. Tighten chain tension until all tie straps (see no. 1, fig. 28) rest on

FILING INSTRUCTIONS (CONT'D.)

Model 358-350842 (Craftsman 2.1)

guide bar and, when pulled at top, the bottom of the drive links will pull up even with guide bar rail (no. 2, fig. 28). While pulling the chain around the bar, pump the oil pump button to re-lubricate the chain and at the same time, help flush fittings out of the groove in the bar. If the oil pump button becomes hard to push, check to see if the oil hole in the bar is plugged. (See Figure 3). This hole will occasionally become filled with dirt and sawdust, so check the oil hole regularly (each time chain is sharpened) to see that it is open. If it becomes plugged, remove the bar and clean out the oil passage. To equalize wear, the bar should be turned

over when reinstalled. If the chain becomes very dirty, remove it and wash it in kerosene, or solvent. Soak the chain thoroughly in S.A.E. No. 30 oil before installing it. This will relubricate it and prevent rust from forming.

If at any time your bar or chain shows signs of wear, or burning, take the saw to your Sears Store for attention. **Never use the bar as a pry bar or to force wood apart.** If the bar becomes lodged in a cut and cannot be moved, use wedges, or an axe to free the saw. If the bar becomes bent, replace it.

STORING YOUR CHAIN SAW

Model 358-350842 (Craftsman 2.1) Model 358-350870 (Craftsman 2.1 PS) Model 358-350880 (Craftsman 2.3 PS/VL)

Once you have finished using the saw and it is to be idle for several months, follow these steps before storing the saw.

1. Drain fuel from the tank.
2. Start Engine and allow to run at idle speed until all fuel is used.
3. Drain oil from oil tank.
4. Store in a dry area and cover to protect from dust.

CUTTING TIPS

Model 358-350842 (Craftsman 2.1) Model 358-350870 (Craftsman 2.1 PS) Model 358-350880 (Craftsman 2.3 PS/VL)

Before tackling big trees it is best if you cut a few branches, limbs, or a small log just to get the feel of the chain saw, and to become familiar with the controls. The accepted way to hold the saw is to stand to the left of the saw with your left hand on the front handlebar and your right hand on the rear handle so you can operate the throttle trigger with your right index finger. You should not stand directly behind the saw in case the chain catches in a cut and bucks backward. See Figure 29.

Start the engine, see that it is running properly, and pump the oil button a few times to be sure it is delivering oil to the bar and chain correctly. Squeeze the trigger to open the throttle wide open and start the cut. If the chain is properly sharpened, the cutting should be relatively effortless. It is not necessary to press down hard to make the saw cut. Pushing the saw too hard will slow the engine and cutting will actually be more difficult. (continued page 13)

CUTTING TIPS (CONT'D)

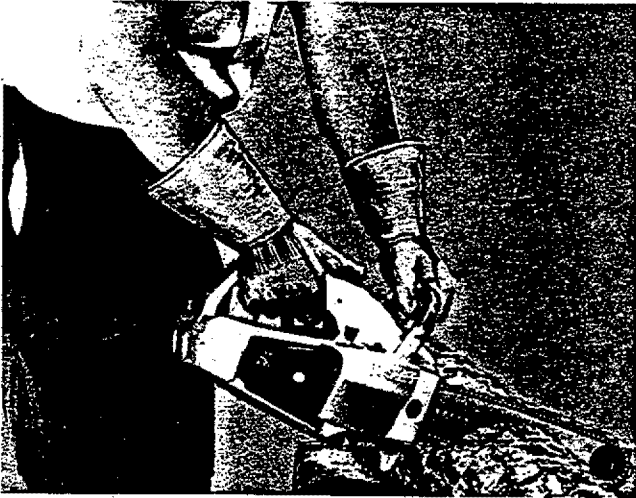

Fig. 29

Just as the chain completes the cut, let off of the throttle and let the engine idle. Cutting should always be done at full throttle. Do not, however, run the engine at full throttle out of the cut. Remember to push the oil button every 5 to 10 seconds while cutting with model 358-350840. Listed below are brief instructions on how to make the most common cuts with your chain saw.

FELLING

(CUTTING DOWN A TREE)

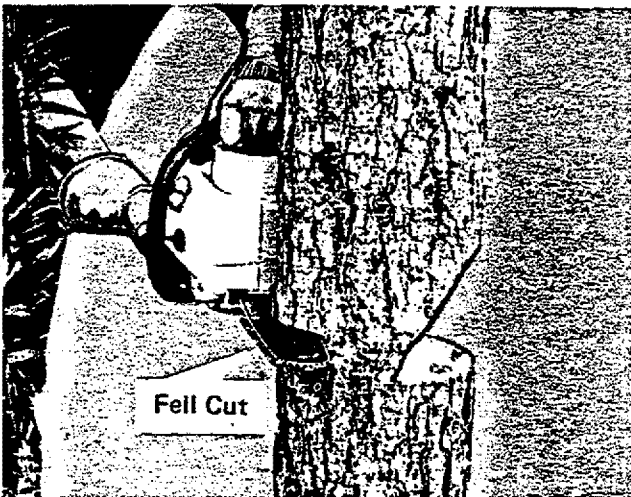

Fig. 30

Before felling a tree, select a safe path of retreat and clear a working area around the tree. Observe the way the tree is leaning, if at all, and then decide where you want the tree to fall. Trees of up to 6 or 7 inches in diameter can usually be cut through in one pass. Under-cutting is required on larger trees. See Figure 30.

To undercut, notch about 1/3 the way through the tree, on the side you want the tree to fall. Then make the felling cut about 2" above the notch and on the opposite side of the felling cut, don't cut all the way through to the undercut. This leaves a small section of wood to act as a hinge while the tree is falling, and allows the tree to fall in the desired direction. If the tree is larger in diameter than the length of the bar, the felling cut should be made from both sides of the tree.

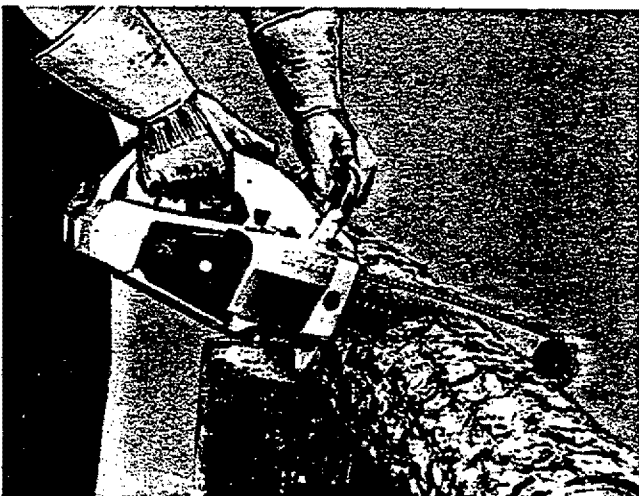

Fig. 31

BUCKING

If you have to cut in the middle of a log which is supported at both ends, cut halfway through the topside of the log, or until the saw cut begins to close, see Figure 31, then pull the guide bar out and undercut from the bottom side of log using the top edge of the guide bar. See Figure 32.

BUCKING (CONT'D)

This will keep the log from pinching the bar and chain. Be careful when undercutting that the chain does not cut into the ground. Make sure that you have good footing so you can get out of the way should the log begin to roll when finishing the cut. When possible stand on the uphill side of the log so the log will roll away from you when finishing the cut.



Fig. 32

Whenever possible, the log should be placed off the ground and supported by other logs, limbs, etc. See Figure 33. This will help keep the chain out of the dirt. When the chain is allowed to touch the ground, it will dull rapidly, requiring excess filing to keep chain sharp and excess wear to bar.

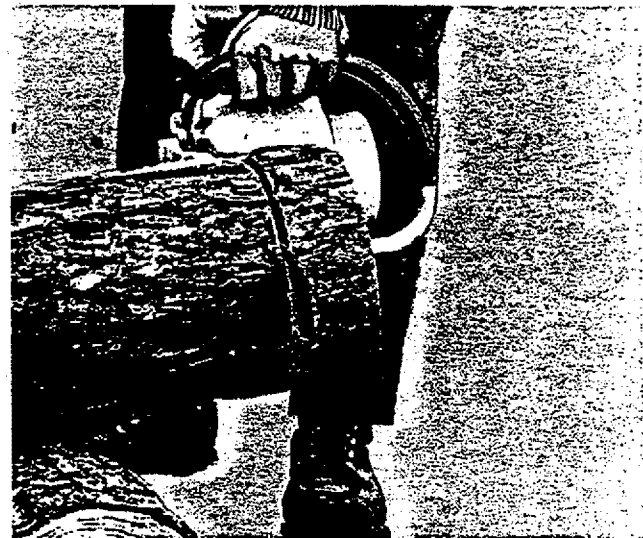

Fig. 33

PRUNING

(CUTTING LIMBS FROM STANDING TREE)

Small limbs can be cut in one cut. Larger limbs should be under cut first and then finish-cut from above. After the limb has been removed, another finishing cut may be made closer to the tree, if desired, for appearance. If you must cut higher limbs either by climbing the tree, or standing on a ladder, it is advisable to tie a length of rope from the tree to the saw handle so the saw cannot fall very far if you should drop it. Extreme care should be used in this type of cutting operation.

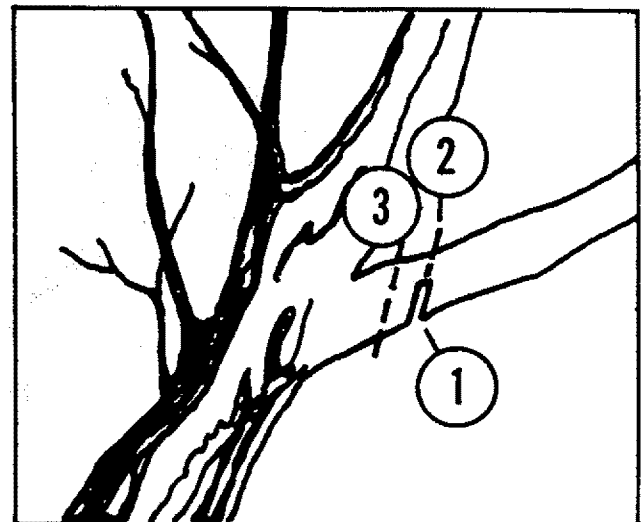
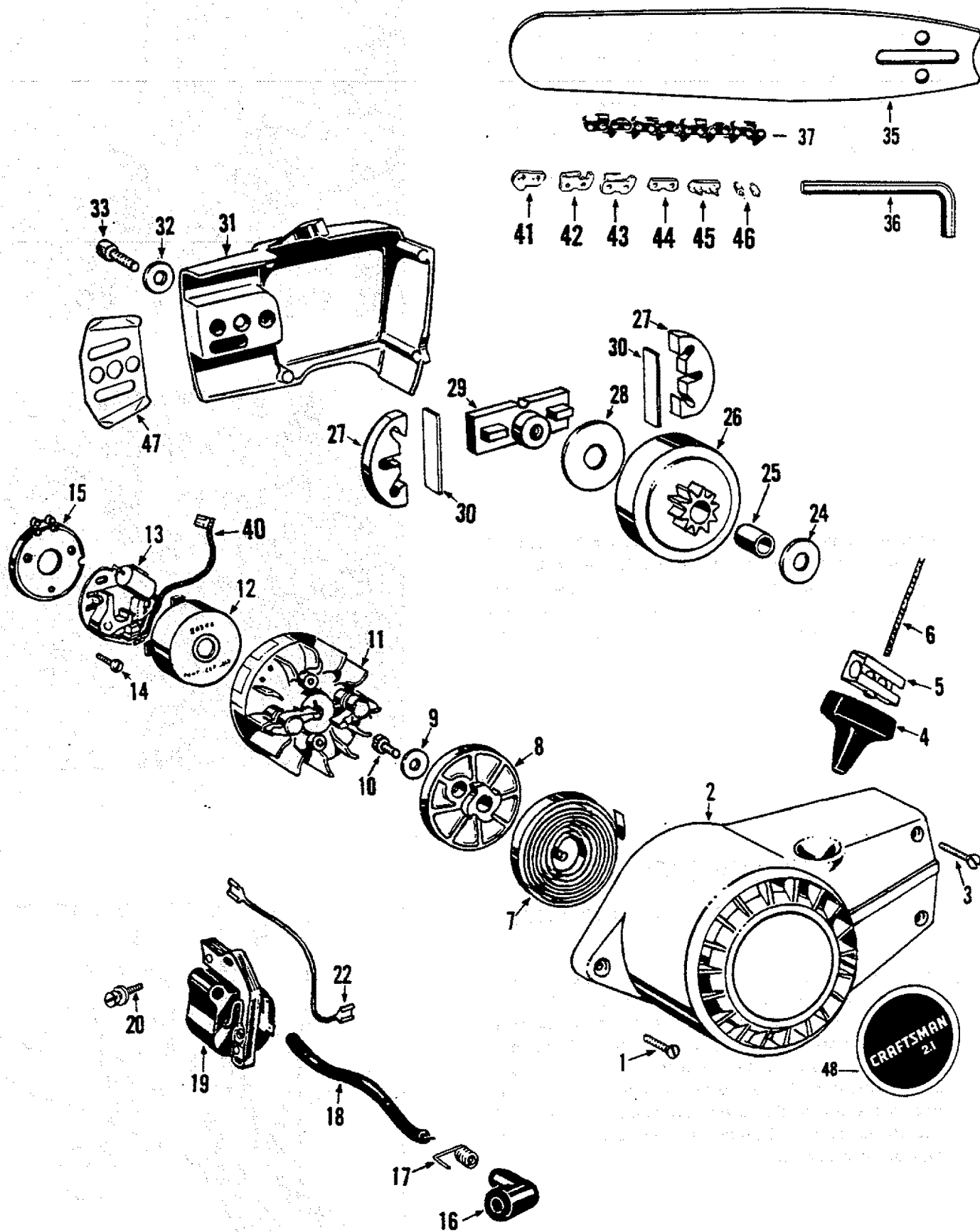

Fig. 34

SEARS CHAIN SAW—MODEL 358-350842 (Craftsman 2.1)

Fig. 1



SEARS CHAIN SAW—MODEL 358-350842 (Craftsman 2.1)

Fig. 1

Key No.	Part No.	Qty.	Description
1	15074	1	Screw - front fan housing
2	11243	1	Fan housing
3	15122	2	Screws - rear fan housing
4	42024	1	Handle - starter
5	4268	1	Rope - anchor
6	42034		Rope - starter
7	42023	1	Spring - starter
8	11214	1	Starter pulley
9	15123	1	Washer - starter pulley
10	1724	1	Screw - starter pulley
11	39027	1	Flywheel ass'y
12	23346	1	Cover - breaker points
13	39023	1	Breaker and condenser ass'y (includes Key No. 40)
14	15129	2	Screws - breaker mounting
15	23345	1	Plate - breaker mounting
16	3933	1	Boot - spark plug
17	3934	1	Spring - plug connector
18	39026	1	Lead - high tension
19	39022	1	Coil and lamination ass'y (includes 16,17,18)
20	15128	2	Screws - coil mounting
22	23587	1	Lead - stop switch
24	23378	1	Thrust washer - clutch
25	32022	1	Bushing - clutch
26	48011	1	Drum and sprocket ass'y (includes Key No. 25)
27	23379	2	Clutch shoes
28	23382	1	Clutch plate
29	22079	1	Clutch spider
30	23381	2	Clutch springs
31	11198	1	Bar clamp
32	15149	1	Washer - bar clamp
33	15183	1	Screw - bar clamp
35	44029	1	Bar 14"
36	31017	1	Bar wrench
37	51015	1	Chain 14"
40	39024	1	Lead - Point to Coil
41	52003	As Req.	Drive Link - Chain
42	52006	As Req.	Cutter LH - Chain
43	52007	As Req.	Cutter RH - Chain
44	52002	As Req.	Tie Strap - Chain
45	52004	As Req.	Pre-set Tie Strap - Chain
46	52005	As Req.	Rivet - Chain
47	23455	2	Plate - Guide Bar
48	23474	1	Decal - Craftsman 2.1
	63135		Owners manual

SEARS CHAIN SAW—MODEL 358-350870 (Craftsman 2.1 PS)
 MODEL 358-350880 (Craftsman 2.3 PS/VL)

Fig. 1

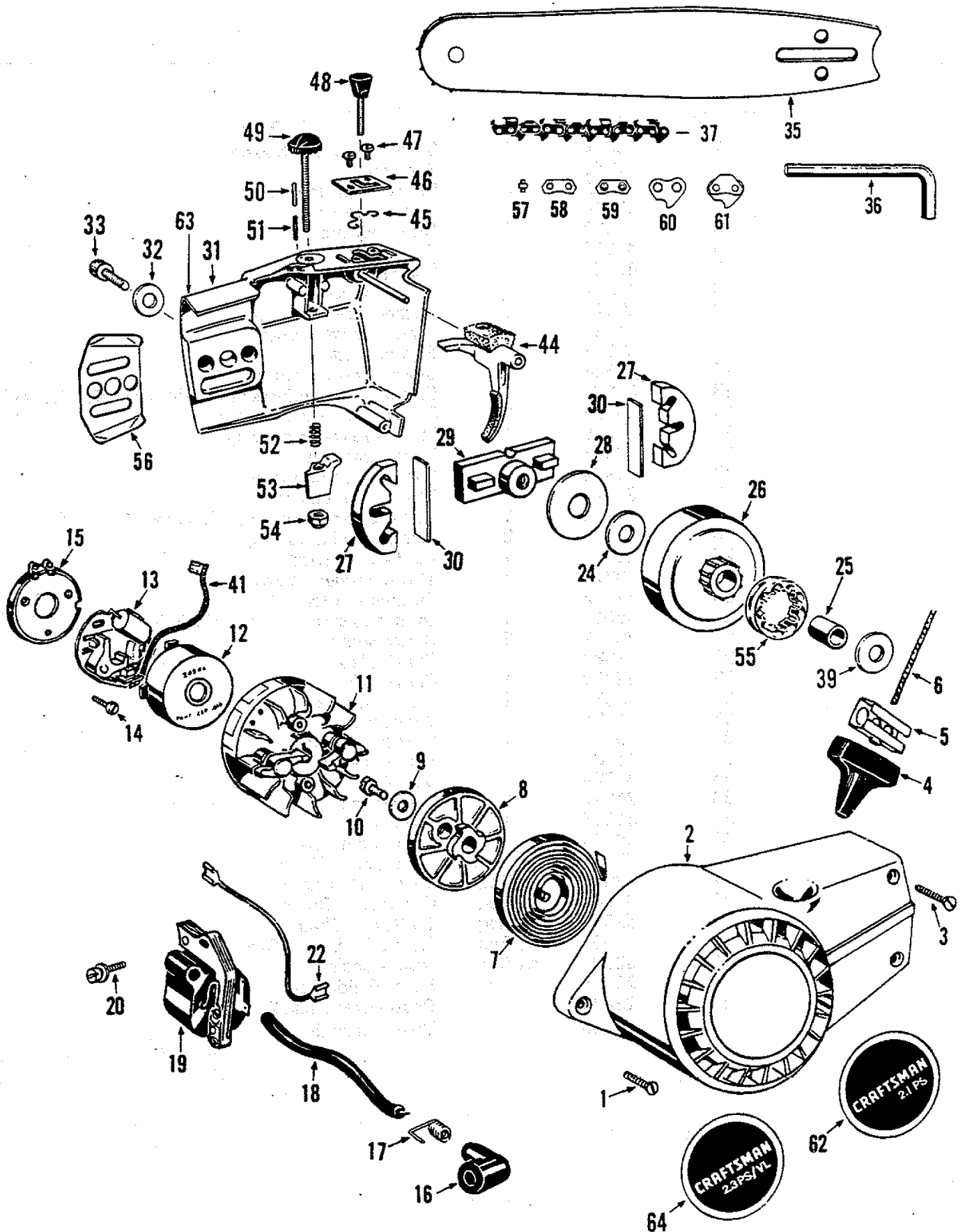

SEARS CHAIN SAW—MODEL 358-350870 (Craftsman 2.1 PS)
 MODEL 358-350880 (Craftsman 2.3 PS/VL)

Fig. 1

Key No.	Part No.	Qty.	Description
1	15074	1	Screw - front fan housing
2	11243	1	Fan housing
3	15122	2	Screws - rear fan housing
4	42024	1	Handle - starter
5	4268	1	Rope - anchor
6	42034	1	Rope - starter
7	42023	1	Spring - starter
8	11214	1	Starter pulley
9	15123	1	Washer - starter pulley
10	1724	1	Screw - starter pulley
11	39027	1	Flywheel assembly
12	23346	1	Cover - breaker points
13	39023	1	Breaker and condenser assembly (includes Key No. 41)
14	15129	2	Screws - breaker mounting
15	23345	1	Plate - breaker mounting
16	3933	1	Boot - spark plug
17	3934	1	Spring - plug connector
18	39026	1	Lead - high tension
19	39022	1	Coil and lamination assembly (includes 16, 17, 18)
20	15128	2	Screws - coil mounting
22	23587	1	Lead - stop switch
24	23461	1	Thrust Washer (silver)
25	32023	1	Bearing - Clutch Drum
26	48013	1	Drum
27	23379	2	Clutch shoes
28	23382	1	Clutch plate
29	22079	1	Clutch spider
30	23381	2	Clutch springs
31	11186	1	Bar clamp (model 358-350870 - Craftsman 2.1 PS)
32	15149	1	Washer - bar clamp
33	15183	1	Screw - bar clamp
35	44047	1	Bar 14" - sprocket nose
36	31017	1	Bar wrench
37	51023	1	Chain 14"
39	23445	1	Thrust washer (black)
41	39024	1	Lead - points to coil
44	10144	1	Stone & Arm
45	23438	1	Spring - arm retaining
46	23443	1	Plate - adj.
47	15004	2	Screw - adj. plate
48	23444	1	Knob - oscillating
49	23442	1	Knob - depth adj.
50	15157	1	Pin - indexing
51	23458	1	Spring - indexing pin
52	23439	1	Spring - depth adj.
53	23441	1	Follower - depth adj.
54	15064	1	Nut - depth adj.
55	48015	1	Sprocket - 9 tooth - 1/4 pitch
56	23455	2	Plate - Guide Bar
57	52024	As Req.	Rivet
58	52028	As Req.	Tie Strap
59	52027	As Req.	Pre-set Tie Strap
60	52025	As Req.	Drive link
61	52026	As Req.	Drive link - bumper
62	23632	1	Decal (model 358-350870 - Craftsman 2.1 PS)
63	11252	1	Bar clamp (model 358-350880 - Craftsman 2.3 PS/VL)
64	23633	1	Decal (model 358-350880 - Craftsman 2.3 PS/VL)
	63135		Owners manual

SEARS CHAIN SAW — MODEL 358-350842 (Craftsman 2.1)

Fig. 2

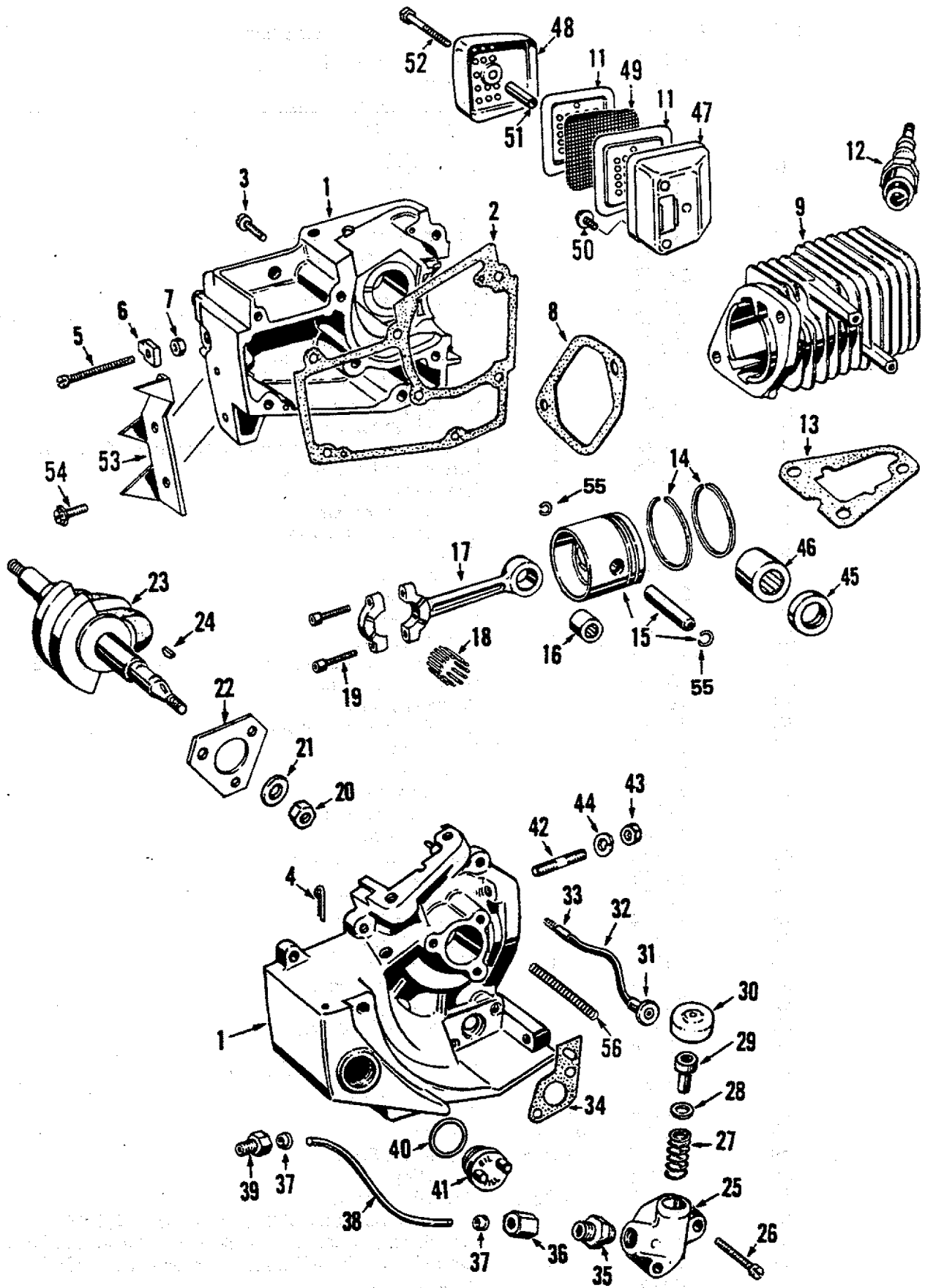

SEARS CHAIN SAW – MODEL 358-350842 (Craftsman 2.1)

Fig. 2

Key No.	Part No.	Qty.	Description
1	10151	1	Crankcase ass'y (includes Matching Half and Key Nos. 4, 5, 6, 7 & 42)
2	19044	1	Gasket - crankcase
3	15136	7	Screws - crankcase
4	15108	1	Cotter pin
5	15134	1	Screw - bar adjusting
6	23492	1	Pin - bar adjusting (use with 11198 Bar Clamp)
7	15135	1	Nut - bar adjusting
8	19043	1	Gasket - cylinder
9	11244	1	Cylinder
11	23591	2	Baffle
12	30005	1	Spark plug - Champion CJ-8
13	19049	1	Gasket - carburetor housing to c'case
14	23352	2	Piston rings
15	23389	1	Piston ass'y (includes Key No. 55)
16	32018	1	Piston pin bearing
17	22077	1	Connecting rod ass'y (includes Key No. 16 & 19)
18	32019	1	Crankpin rollers (28 Rollers in Strip)
19	1723	2	Screws - connecting rod
20	626605	1	Nut - flywheel
21	15127	1	Washer - flywheel
22	23354	2	Thrust washer - crankcase
23	22076	1	Crankshaft
24	15126	1	Key - flywheel
25	11141	1	Oil pump body
26	15137	2	Screws - oil pump
27	23358	1	Spring - oil pump
28	1952	1	O-Ring - plunger
29	23357	1	Plunger - oil pump
30	23356	1	Cap - oil pump
31	23148	1	Intake valve - oil pump
32	21012	1	Oil line
33	2589	1	Weight - oil pick up
34	19046	1	Gasket - oil pump body
35	23359	1	Discharge valve - oil pump
36	1629	1	Nut - 1/8" tubing
37	2464	2	Ferrule - 1/8" tubing
38	21013	1	Discharge line - oil pump
39	2615	1	Fitting - discharge line
40	1949	1	O-Ring - oil cap
41	2592	1	Oil cap
42	1674	2	Studs - cylinder
43	1660	2	Nut - cylinder
44	1677	2	Washer - cylinder
45	19051	2	Seal
46	32021	2	Bearing
47	23604	1	Body Spark arresting muffler
48	23589	1	Cover - muffler
49	23592	1	Screen - muffler
50	1709	2	Screws - Muffler Body
51	15187	2	Spacer - Muffler
52	15189	1	Screw - muffler cover
53	23387	1	Spur - optional
54	15036	2	Screws - spur, optional
55	15131	2	Retainer - Piston Pin
56	23456	1	Spring - oil line protector
	63135		Owners manual

SEARS CHAIN SAW—MODEL 358-350870 (Craftsman 2.1 PS)
MODEL 358-350880 (Craftsman 2.3 PS/VL)

Fig. 2

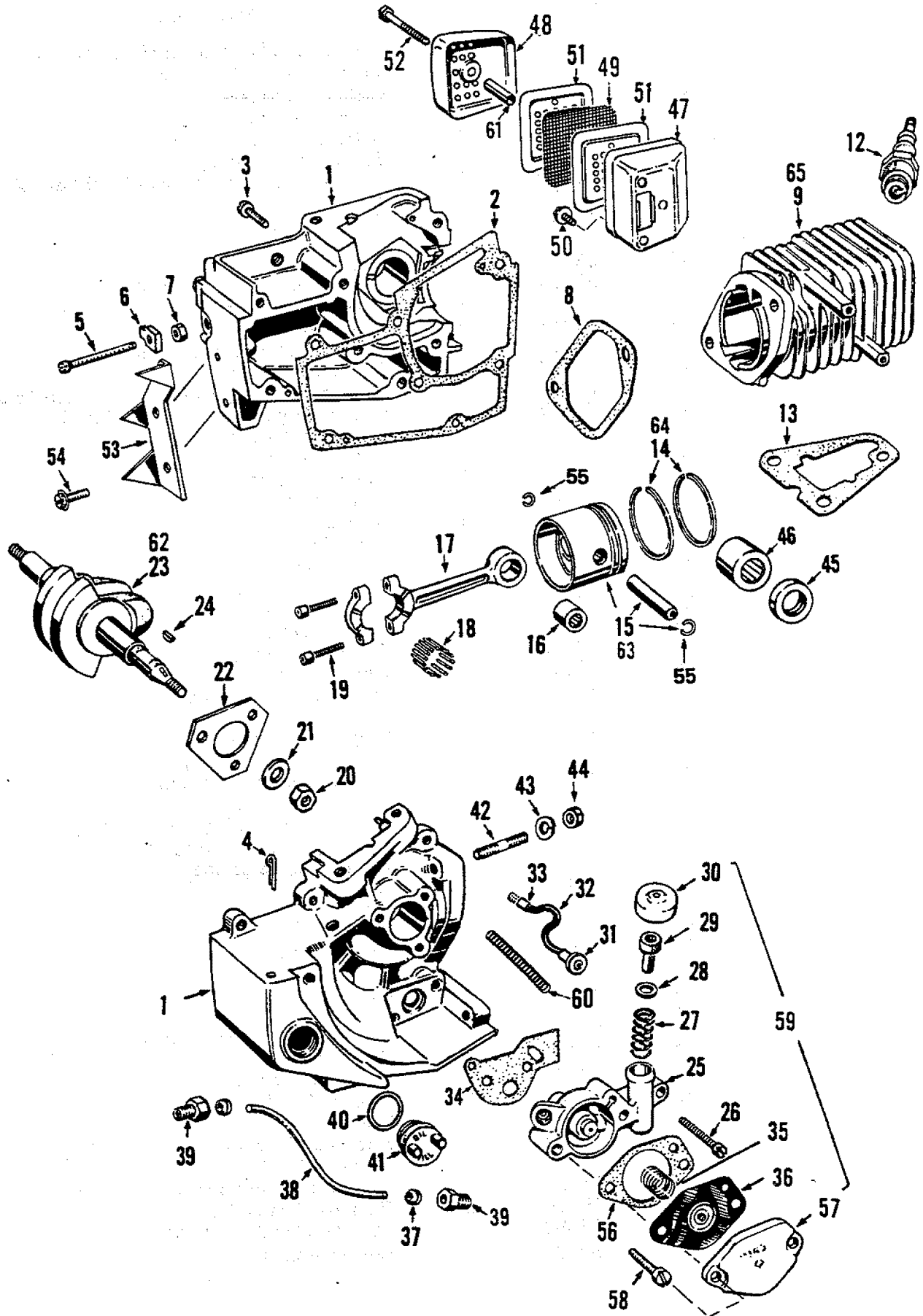

SEARS CHAIN SAW—MODEL 358-350870 (Craftsman 2.1 PS)
 MODEL 358-350880 (Craftsman 2.3 PS/VL)

Fig. 2

Key No.	Part No.	Qty.	Description
1	10153	1	Crankcase assembly (includes Matching Half and Key Nos. 4, 5, 6, 7 & 42)
2	19044	1	Gasket - crankcase
3	15136	7	Screws - crankcase
4	15108	1	Cotter pin
5	15134	1	Screw - bar adjusting
6	23492	1	Pin - bar adjusting
7	15135	1	Nut - bar adjusting
8	19043	1	Gasket - cylinder
9	11245	1	Cylinder (model 358-350880 - Craftsman 2.3 PS/VL)
12	30005	1	Spark plug - Champion CJ-8
13	19049	1	Gasket - carburetor housing to c'case
14	23485	2	Piston rings
15	23484	1	Piston assembly (includes Key No. 55) (model 358-350880 - Craftsman 2.3 PS/VL)
16	32018	1	Piston pin bearing
17	22077	1	Connecting rod assembly (includes Key Nos. 16 & 19)
18	32019	1	Crankpin rollers (strip of 28)
19	1723	2	Screws - connecting rod
20	626605	1	Nut - flywheel
21	15127	1	Washer - flywheel
22	23354	2	Thrust washer - crankcase
23	22076	1	Crankshaft (model 358-350870 - Craftsman 2.1 PS)
24	15126	1	Key - flywheel
25	10129	1	Oil pump body
26	15137	2	Screws - oil pump
27	23358	1	Spring - oil pump
28	19029	1	Quad Ring - plunger
29	23357	1	Plunger - oil pump
30	23356	1	Cap - oil pump
31	23148	1	Intake valve - oil pump
32	21012	1	Oil line
33	2589	1	Weight - oil pick up
34	19054	1	Gasket - oil pump body
35	23421	1	Spring - diaphragm
36	10131	1	Diaphragm Assembly
37	2464	2	Ferrule - 1/8" Tubing
38	21013	1	Discharge line - oil pump
39	2615	2	Fitting - discharge line
40	1949	1	O-Ring - oil cap
41	2592	1	Oil cap
42	1674	2	Studs - cylinder
43	1677	2	Washers - cylinder
44	1660	2	Nuts - cylinder
45	19051	2	Seal
46	32021	2	Bearing
47	23604	1	Body - Spark arresting muffler
48	23589	1	Cover - muffler
49	23592	1	Screen - muffler
50	1709	2	Screws - muffler body
51	23591	2	Baffle - muffler
52	15189	1	Screw - muffler cover
53	23387	1	Spur (optional)
54	15036	2	Screws - spur (optional)
55	15131	2	Retainer - Piston Pin
56	19053	1	Gasket - pump body cover
57	11163	1	Cover - oil pump assembly
58	15114	1	Screw - oil pump cover
59	10143	1	Complete Pump Assembly
60	23456	1	Spring - oil line
61	15187	1	Spacer - muffler cover
62	22103	1	Crankshaft (model 358-350880 - Craftsman 2.3 PS/VL)
63	23389	1	Piston ass'y (includes ref. 55) (model 358-350870 - Craftsman 2.1 PS)
64	23352	2	Piston ring (model 358-350870 - Craftsman 2.1 PS)
65	11244	1	Cylinder (model 358-350870 - Craftsman 2.1 PS)
	63135		Owners manual

SEARS CHAIN SAW—MODEL 358-350842 (Craftsman 2.1)
 MODEL 358-350870 (Craftsman 2.1 PS)

Fig. 3

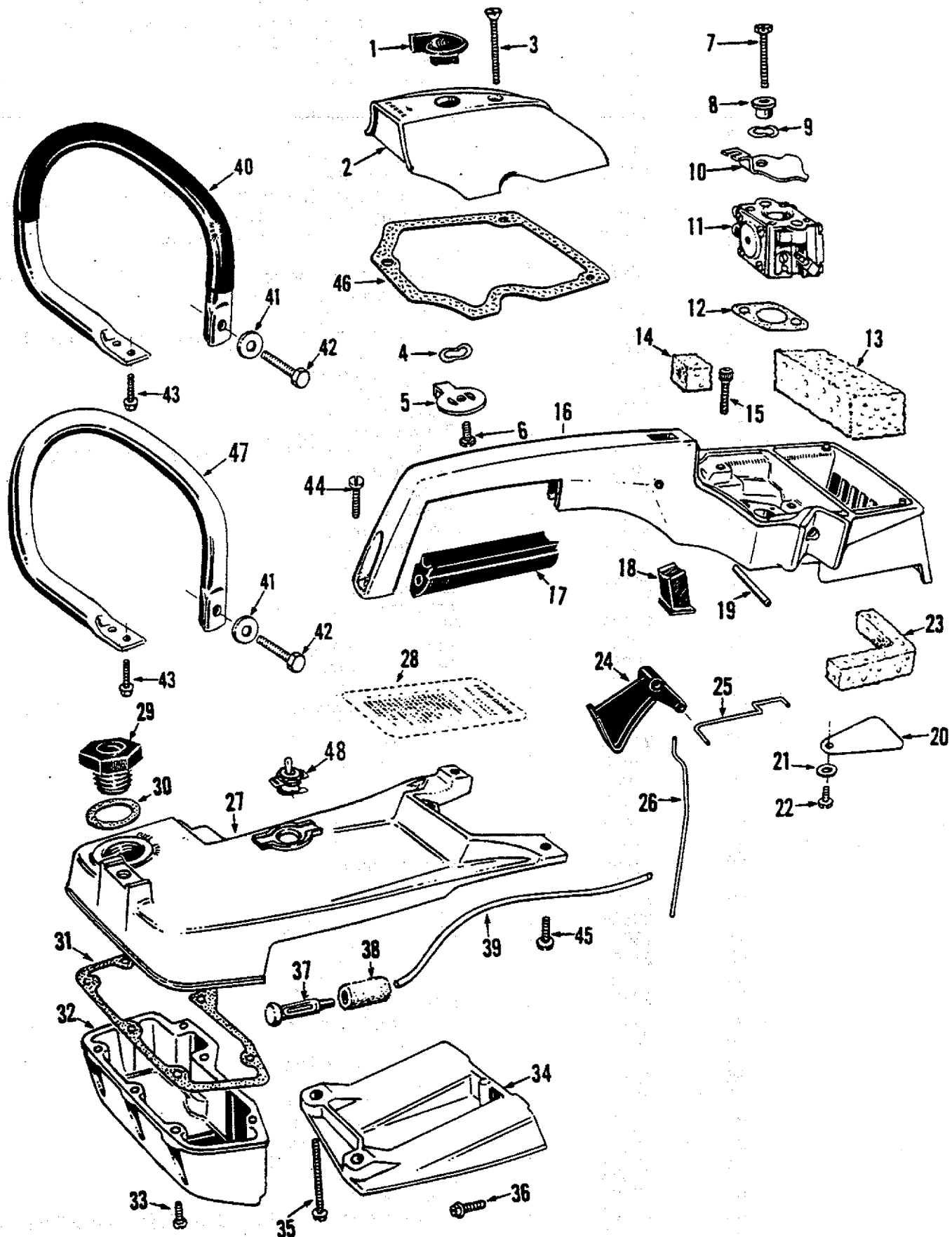

SEARS CHAIN SAW—MODEL 358-350842 (Craftsman 2.1)
 MODEL 358-350870 (Craftsman 2.1 PS)

Fig. 3

Key No.	Part No.	Qty.	Description
1	23376	1	Choke knob
2	11188	1	Carburetor cover
3	15165	1	Screw - Carburetor cover
4	15147	1	Wave washer - choke lever
5	23377	1	Choke lever
6	625712	1	Screw - Choke lever
7	15143	2	Screws - Carburetor
8	23375	1	Spacer - Choke
9	15146	1	Wave washer - Shutter
10	23581	1	Choke - Shutter
11	34034	1	Carburetor
12	19045	1	Gasket - Carburetor
13	23369	1	Air Filter
14	23373	1	Boot - Throttle wire
15	1636	3	Screws - Carburetor housing to C'case
16	11191	1	Handle and Carburetor housing
17	23493	1	Grip - handle
18	23362	1	Button - Oil pump
19	15145	1	Pin - Trigger
20	23366	1	Reed
21	23367	1	Reed Stop
22	15139	1	Screw - Reed
23	23388	1	Dust seal
24	23452	1	Trigger
25	23372	1	Throttle rod
26	23361	1	Push rod - Oil pump
27	11247	1	Gas tank top
28	23384	1	Decal - Instruction
29	10123	1	Gas cap assembly (includes Key No. 30)
30	19048	1	Gasket - Gas cap
31	19047	1	Gasket - Gas tank
32	11143	1	Gas tank bottom
33	15138	5	Screws - Gas tank
34	11147	1	Cylinder shroud
35	15152	2	Screws - Cylinder shroud - Rear
36	1709	2	Screws - Cylinder shroud - Front
37	23363	1	Weight - Fuel pick up
38	23364	1	Felt - Fuel pick up
39	21014	1	Line - Fuel pick up
40	22091	1	Front handle bar (model 358-350870 - Craftsman 2.1 PS, only)
41	15151	1	Washer - Handle bar
42	1648	1	Screw - Front Handle Bar - Top
43	15037	2	Screws - Front Handle Bar - Bottom
44	15141	1	Screw - Handle to gas tank - Rear
45	15129	2	Screws - Handle to gas tank - Front
46	19058	1	Gasket - Carburetor cover
47	22081	1	Front handle bar (model 358-350842 - Craftsman 2.1)
48	2582	1	Switch - on-off
	63135		Owners manual

SEARS CHAIN SAW—MODEL 358-350880 (Craftsman 2.3 PS/VL)

Key No.	Part No.	Qty.	Description
1	23376	1	Choke knob
2	11238	1	Carburetor cover
3	15144	1	Screw - carburetor cover
4	15147	1	Wave washer - choke lever
5	23377	1	Choke lever
6	625712	1	Screw - choke lever
7	15143	2	Screws - carburetor
8	23375	1	Spacer - choke
9	15146	1	Wave washer - shutter
10	23581	1	Choke - shutter
11	34034	1	Carburetor
12	19045	1	Gasket-carburetor
13	23369	1	Air filter
14	23373	1	Boot throttle wire
15	1636	3	Screws - carburetor housing to C'case
16	11237	1	Handle
17	23599	1	Grip - handle
18	23595	1	Button - oil pump
19	15193	1	Pin - trigger
20	23366	1	Reed
21	23367	1	Reed stop
22	15139	1	Screw reed
23	23388	1	Dust seal
24	23601	1	Trigger
25	23372	1	Throttle Rod
26	23594	1	Push rod - oil pump
27	11235	1	Gas tank top
28	23384	1	Decal - instruction
29	10123	1	Gas cap ass'y includes ref. 30
30	19048	1	Gasket - gas cap
31	19047	1	Gasket - gas tank
32	11143	1	Gas tank bottom
33	15138	5	Screws - gas tank
34	11147	1	Cylinder shroud
35	15152	2	Screws - cylinder shroud - rear
36	1709	2	Screws - cylinder shroud - front
37	23363	1	Weight - fuel pick up
38	23364	1	Felt - fuel pick up
39	21014	1	Line - fuel pick up (bulk no. 8133)
40	22104	1	Front handle bar
41	15194	1	Screw - top front handle
42	15196	1	Screw - front handle bar - top
43	15037	2	Screws - front handle bar - bottom
45	15129	2	Screws - handle to gas tank, front
47	2582	1	Switch - on-off
48	23597	2	Isolator mounting - handle to gas tank
49	15036	2	Screw - connection
50	23598	1	Bracket - isolator - gas tank
51	23611	1	Spacer - rear mounting
52	15192	2	Screw - rear mounting spacer
53	11236	1	Carburetor housing
54	23596	1	Isolator mounting - handle to carb.
55	15036	2	Screws - bracket to carb. housing
56	23612	1	Isolator - pad
57	23602	1	Isolator - front handle
58	23603	1	Bracket - front handle
59	1642	1	Lockwasher - front handle bracket
60	15197	1	Nut - front handle bracket
61	19074	1	Gasket - carb. cover
	63135		Owners manual

SEARS MODEL 358-350842 (Craftsman 2.1)
 SEARS MODEL 358-350870 (Craftsman 2.1 PS)
 SEARS MODEL 358-350880 (Craftsman 2.3 PS/VL)

Key No.	Part No.	Description
4	34042	*Body Channel Welch Plug
5	34043	Diaphragm Gasket
6	34044	*Diaphragm
7	34045	Diaphragm Cover
8	3717	Diaphragm Ret. Screw & Lockwasher
9	19045	Flange Gasket
10	34047	Fuel Pump Gasket
11	34048	*Fuel Pump Diaphragm
12	34049	Fuel Pump Body
13	34051	Fuel Pump Body Ret. Screw & Lockwasher
14	34052	Idle Mixture Screw
15	3429	*Idle Mixture Screw Spring
16	34053	*Idle Speed Screw
17	34054	*Idle Speed Screw Spring
18	34055	*Inlet Control Lever
19	34056	*Inlet Fulcrum Pin
20	3778	*Inlet Fulcrum Pin Ret. Screw
21	3779	Inlet Needle
22	3780	*Inlet Screen
23	34058	*Inlet Tension Spring
24	34059	High Speed Mixture Screw
25	3429	*High Speed Mixture Screw Spring
26	34066	Nozzle Check Valve Assembly
27	34061	Throttle Shaft & Lever
28	3783	Throttle Shaft Clip
29	3784	Throttle Shaft Clip Ret. Screw & Lockwasher
30	34062	*Throttle Return Spring
31	34063	Throttle Shutter
32	3784	*Throttle Shutter Screw & Lockwasher
33	34064	*Gasket Set
34	34065	Repair Parts Kit

(*) Indicates contents of Repair Parts Kit

maintenance kit

CHAIN SAW
MODEL NO.
358-350842 Craftsman 2.1

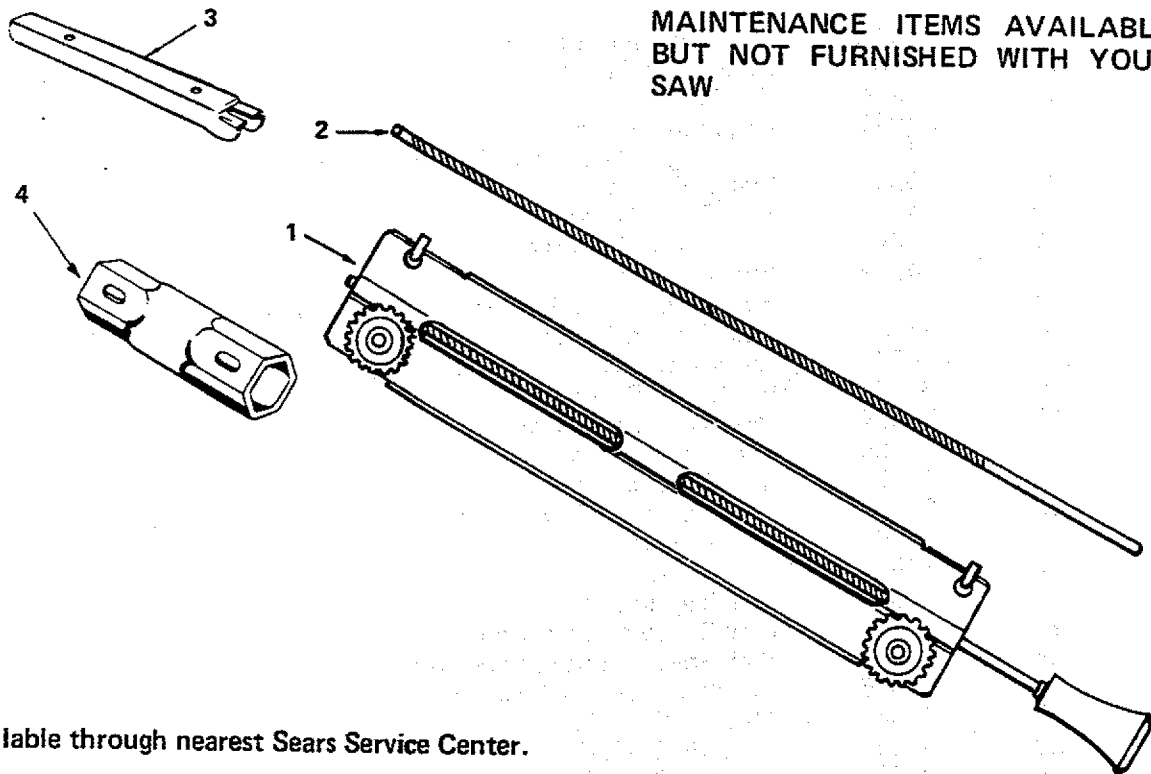

Available through nearest Sears Service Center.

KEY NO.	PART NO.	DESCRIPTION
1	55003	File Holder (includes file)
2	55004	5/32" File
3	55005	Jointer Depth Gauge
4	3157	Wrench - Spark Plug

Accessories available through your nearest Sears Store or Catalog outlet.

CATALOG NO.	DESCRIPTION
32-36516	File and guide
32-36545	File, 5/32"
32-3605	Replacement chain 1/4" pitch micro-chisel, type 25, 76 links
32-36393	Replacement guide bar, 14"
32-36608	Chain saw case
32-36513	Plastic chain guard
32-36403	Spark plug - Champion CJ8
32-36555	2 cycle chain saw engine oil

maintenance kit

CHAIN SAW
MODEL NOS.

358-350870 (Craftsman 2.1 PS)
358-350880 (Craftsman 2.3 PS/VL)

MAINTENANCE ITEMS AVAILABLE
BUT NOT FURNISHED WITH YOUR
SAW

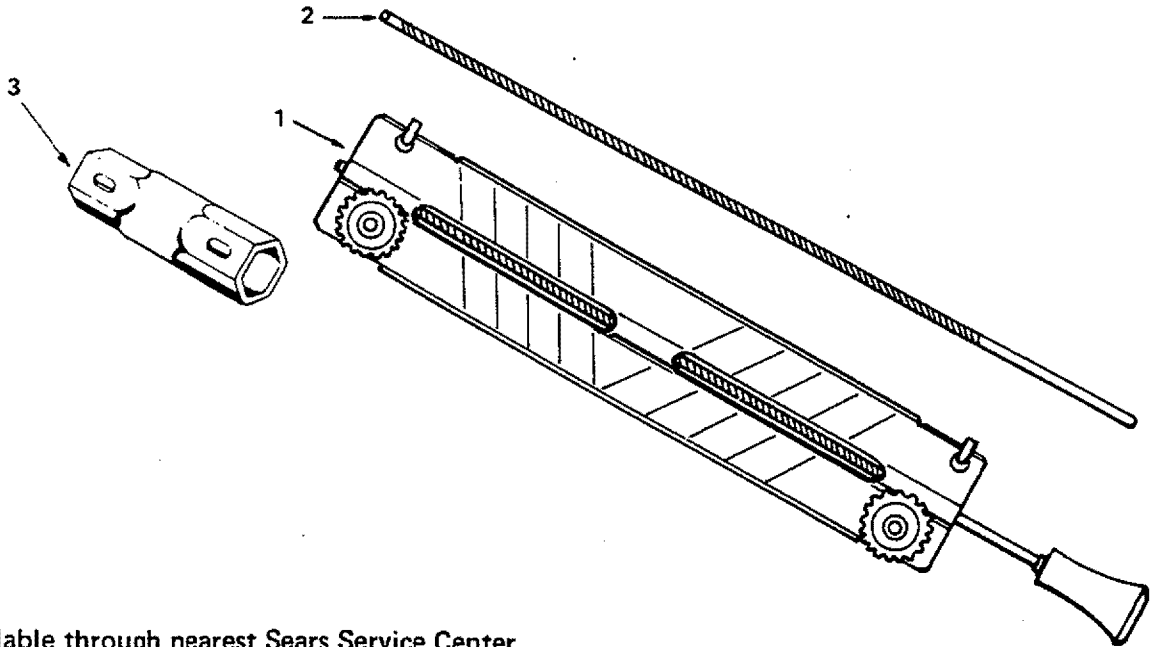

Available through nearest Sears Service Center.

KEY NO.	PART NO.	DESCRIPTION
1	55015	File Holder (includes file)
2	55004	5/32" File
3	3157	Wrench - Spark Plug

Accessories available through your nearest Sears Store or Catalog outlet.

CATALOG NO.	DESCRIPTION
32-36516	File and guide
32-36545	File, 5/32"
32-3606	Replacement chain, barracuda, 1/4" type 89, 76 links
32-36394	Replacement sprocket nose guide bar, 14"
32-36608	Chain saw case
32-36513	Plastic chain guard
32-36403	Spark plug - Champion CJ8
32-36555	2 cycle chain saw engine oil