

INSTALLATION INSTRUCTIONS FOR FREESTANDING DUAL FUEL

INSTALLATION AND SERVICE MUST BE PERFORMED BY A QUALIFIED INSTALLER. IMPORTANT: SAVE FOR LOCAL ELECTRICAL INSPECTOR'S USE. READ AND SAVE THESE INSTRUCTIONS FOR FUTURE REFERENCE.



⚠ WARNING

- ALL RANGES CAN TIP
- INJURY TO PERSONS COULD RESULT
- INSTALL ANTI-TIP DEVICE PACKED WITH RANGE
- SEE INSTALLATION INSTRUCTIONS



⚠ WARNING If the information in this manual is not followed exactly, a fire or explosion may result causing property damage, personal injury or death.

FOR YOUR SAFETY:

- Do not store or use gasoline or other flammable vapors and liquids in the vicinity of this or any other appliance.
- **WHAT TO DO IF YOU SMELL GAS:**
 - Do not try to light any appliance.
 - Do not touch any electrical switch; do not use any phone in your building.
 - Immediately call your gas supplier from a neighbor's phone. Follow the gas supplier's instructions.
 - If you cannot reach your gas supplier, call the fire department.
- Installation and service must be performed by a qualified installer, service agency or the gas supplier.

Clearances and Dimensions

Location: Check location where the range will be installed. Check for proper electrical and gas supply, and the stability of the floor.

Dimensions that are shown must be used. Given dimensions provide minimum clearance. Contact surface must be solid and level.



Refer to your serial plate for applicable agency certifications

Provide Proper Fuel Type

Before Proceeding: Your range is preset to operate on Natural Gas only.

Important Note to the Consumer

- Keep these instructions with your **Use & Care Guide** for future reference.
- As when using any appliance generating heat, there are certain safety precautions you should follow. These are listed in the **Use & Care Guide**, read it carefully.
- Be sure your range is installed and grounded properly by a qualified installer or service technician.
- Make sure the wall coverings around the range can withstand the heat generated by the range.
- To eliminate the need to reach over the surface elements or burners, cabinet storage space directly above the range should be avoided.

Important Notes to the Installer

- Read all instructions contained in these installation instructions before installing range.
- Remove all packing material from the oven compartments before connecting the gas and electrical supply to the range.
- Observe all governing codes and ordinances.
- Be sure to leave these instructions with the consumer.

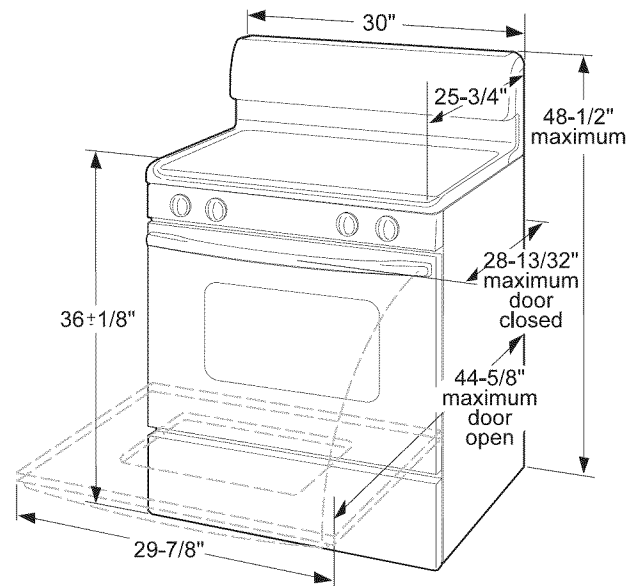

INSTALLATION INSTRUCTIONS FOR FREESTANDING DUAL FUEL

IMPORTANT SAFETY INSTRUCTIONS

Installation of this range must conform with local codes or, in the absence of local codes, with the National Fuel Gas Code ANSI Z223.1 — latest edition when installed in the United States.

When installed in a manufactured (mobile) home, installation must conform with the Manufactured Home Construction and Safety Standard, Title 24 CFR, Part 3280 [formerly the Federal Standard for Mobile Home Construction and Safety, Title 24, HUD (Part 280)] or, when such standard is not applicable, the Standard for Manufactured Home Installations, ANSI/NCSCS A225.1, or with local codes.

Proper Installation— Be sure your appliance is properly installed and grounded by a qualified technician in accordance with the National Fuel Gas Code ANSI Z223- latest edition, or in Canada CAN/CGA B149.1 and CAN/GGA B149.2, and the National Electrical Code ANSI/NFPA No.70-latest edition, or in Canada CSA Standard C22.1, Canadian Electrical Code, Part 1, and local code requirements. Install only per installation instructions provided in the literature package for this range.

This range has been design certified by CSA International. As with any appliance using gas and generating heat, there are certain safety precautions you should follow. You will find them in the Use & Care Guide, read it carefully.

Special instructions for appliances installed in the State of Massachusetts: This appliance can only be installed in the State of Massachusetts by a Massachusetts licensed plumber or gas fitter. When using a flexible gas connector, it must not exceed 3 feet (36 inches) in length. A "T" handle type manual gas valve must be installed in the gas supply line to this appliance.

- **Be sure your range is installed and grounded properly by a qualified installer or service technician.**
- **This range must be electrically grounded in accordance with local codes or, in their absence, with the National Electrical Code ANSI/NFPA No. 70 — latest edition when installed in the United States.** See "Grounding Instructions" on page 7-9 in the Installation Steps.
- **Before installing the range in an area covered with linoleum or any other synthetic floor covering, make sure the floor covering can withstand heat at least 90°F above room temperature without shrinking, warping or discoloring.** Do not install the range over carpeting unless you place an insulating pad or sheet of 1/4-inch thick plywood between the range and carpeting.

- **Make sure the wall coverings around the range can withstand the heat generated by the range.**
- **Do not obstruct the flow of combustion air at the oven vent nor around the base or beneath the lower front panel of the range.** Avoid touching the vent openings or nearby surfaces as they may become hot while the oven is in operation. This range requires fresh air for proper burner combustion.
- **Do not store items of interest to children in the cabinets above the range.** Children could be seriously burned climbing on the range to reach items.
- **To eliminate the need to reach over the surface burners, cabinet storage space above the burners should be avoided.**
- **Adjust surface burner flame size so it does not extend beyond the edge of the cooking utensil.** Excessive flame is hazardous.
- **Do not use the oven as a storage space.** This creates a potentially hazardous situation.
- **Never use your range for warming or heating the room.** Prolonged use of the range without adequate ventilation can be dangerous.
- **Do not store or use gasoline or other flammable vapors and liquids near this or any other appliance.** Explosions or fires could result.
- **Reset all controls to the "off" position after using a programmable timing operation.**

⚠ WARNING DO NOT MAKE ANY ATTEMPT TO OPERATE THE ELECTRIC IGNITION OVEN DURING AN ELECTRICAL POWER FAILURE. RESET ALL OVEN CONTROLS TO "OFF" IN THE EVENT OF A POWER FAILURE.

The electric ignitor will automatically re-ignite the oven burner when power resumes if the oven thermostat control was left in the "ON" position.

When an electrical power failure occurs during use, the surface burners will continue to operate.

During a power outage, the surface burners can be lit with a match. Hold a lighted match to the burner, then slowly turn the knob to the  (lite) position. Use extreme caution when lighting burners this way.

FOR MODELS WITH SELF-CLEAN FEATURE:

- **Remove broiler pan, food and other utensils before self-cleaning the oven.** Wipe up excess spillage. Follow the cleaning instructions in the Use & Care Guide.
- **Unlike the standard gas range, THIS COOKTOP IS NOT REMOVABLE.** Do not attempt to remove the cooktop.

INSTALLATION INSTRUCTIONS FOR FREESTANDING DUAL FUEL

Tools you will need

(Wear safety glasses when using tools):

For leveling legs and Anti-Tip Bracket:

- Adjustable wrench or channel lock pliers (Fig. 5).
- 1/4" & 5/16" Nutdriver or flat head screwdriver (Fig. 6).
- Electric drill & 1/8" dia. bit (5/32" Masonry drill bit if installing in concrete (Fig. 7).
- Level (Fig. 22).

For gas supply connection:

- Pipe wrench (Fig. 8).

For burner flame adjustment:

- Phillips head and small blade-type screwdrivers (Figs. 9 & 10).

For gas conversion (LP/Propane or Natural):

- Open end wrench - 1/2" (Fig. 11).

Additional materials you may need:

- Anti-Tip Template (Fig. 12), Anti-Tip bracket, 2 mounting screws (bracket and screws are supplied with range - Fig. 13) and masking tape (Fig. 14).
- Pipe joint sealant that resists action of LP/Propane gas (Fig. 15).
- Gas line manual shut-off valve (Fig. 16).
- 1/2" NPT 90° black pipe elbow (Fig. 17).
- A new flexible metal appliance conduit (1/2" NPT x 3/4" or 1/2" I.D.) must be design certified by CSA International (Fig. 18). Because solid pipe restricts moving the range we recommend using a new flexible conduit (**48" MAXIMUM LENGTH**) for each new installation and additional reinstalls.
- Always use the (2) new flare adapters (1/2" NPT x 3/4" or 1/2" I.D.) supplied with the new flexible appliance conduit for connection of the range (Fig. 19).
- Power cord (40/50 ampere rated Cord Kit - **48" MAXIMUM LENGTH** - Fig. 20).
- 4 or 3 wire, 40/50 ampere rated wall receptacle and mounting plate (Fig. 21).
- Copper electrical wiring and metal conduit (for hard wiring installation only).

Tools

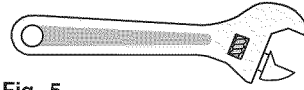

Fig. 5

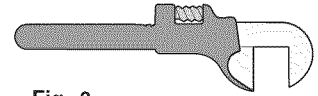

Fig. 8

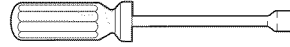

Fig. 6

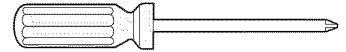

Fig. 9

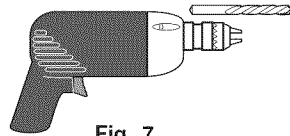

Fig. 7

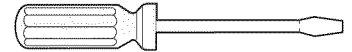

Fig. 10

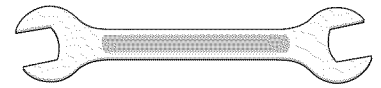

Fig. 11

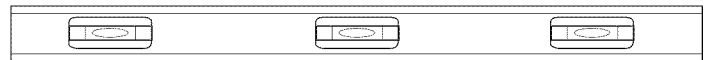

Fig. 22

Materials

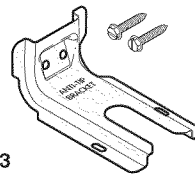

Fig. 13

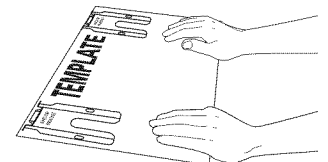

Fig. 12



Fig. 15

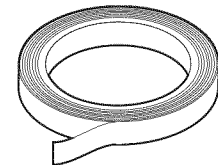

Fig. 14



Fig. 16



Fig. 17

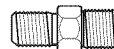

Fig. 19

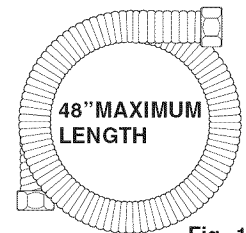

Fig. 18

4 or 3 Wire Cord Kit
48" MAXIMUM LENGTH

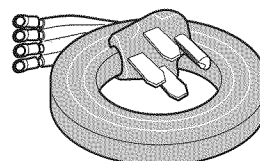

Fig. 20

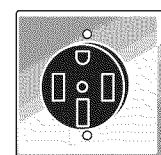

Fig. 21

INSTALLATION INSTRUCTIONS FOR FREESTANDING DUAL FUEL

Cabinet and countertop dimensions

- Check for wall and cabinet clearances where the range will be installed.
- Check the stability of the floor where the range will be installed.
- Check for proper electrical and gas supply.

Note: All dimensions provided are minimal unless otherwise stated.

To eliminate the risk of burns or fire by reaching over heated surface units, cabinet storage space located above the surface units should be avoided. If cabinet storage is to be provided, the risk can be reduced by installing a range hood that projects horizontally a minimum of 5" beyond the bottom of the cabinets.

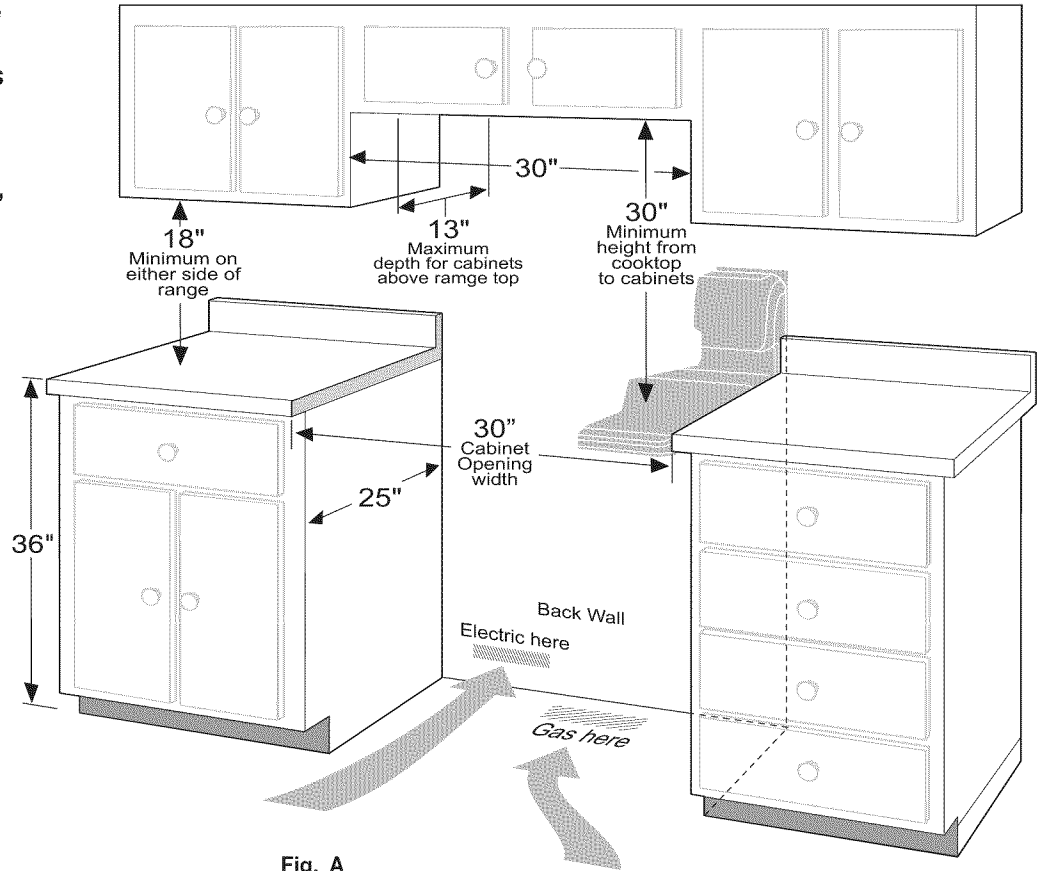
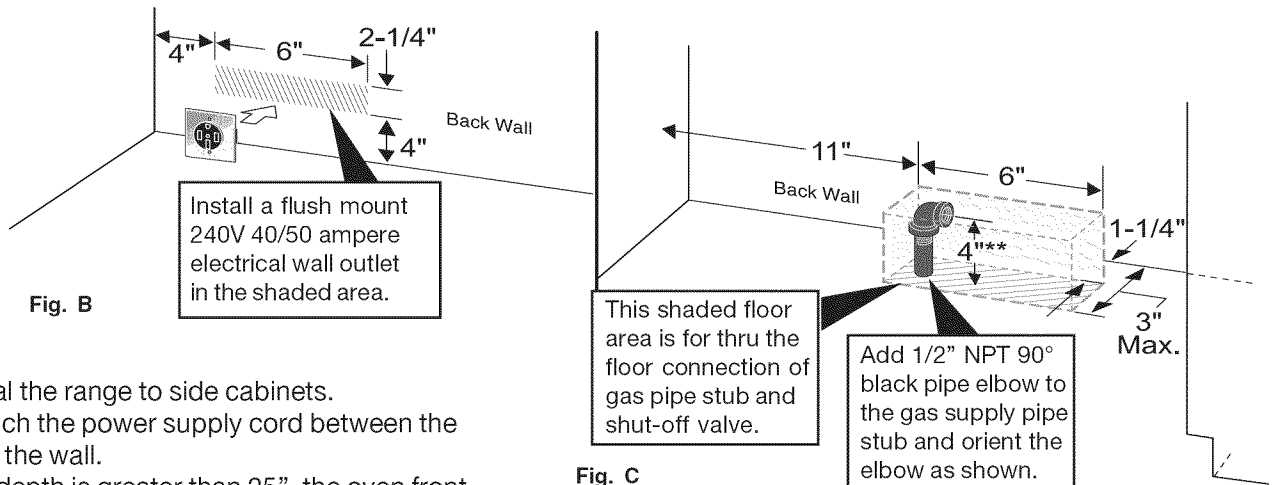

Fig. A



- Do not seal the range to side cabinets.
- Do not pinch the power supply cord between the range and the wall.
- If cabinet depth is greater than 25", the oven front frame must extend beyond cabinet front by 1/2" minimum.

All openings in the wall or floor where the range is to be installed must be sealed.

Note: The gas supply pipe stub and elbow assembly centerline should not exceed 4" height from the floor.

INSTALLATION INSTRUCTIONS FOR FREESTANDING DUAL FUEL

Installation with cabinets and wall

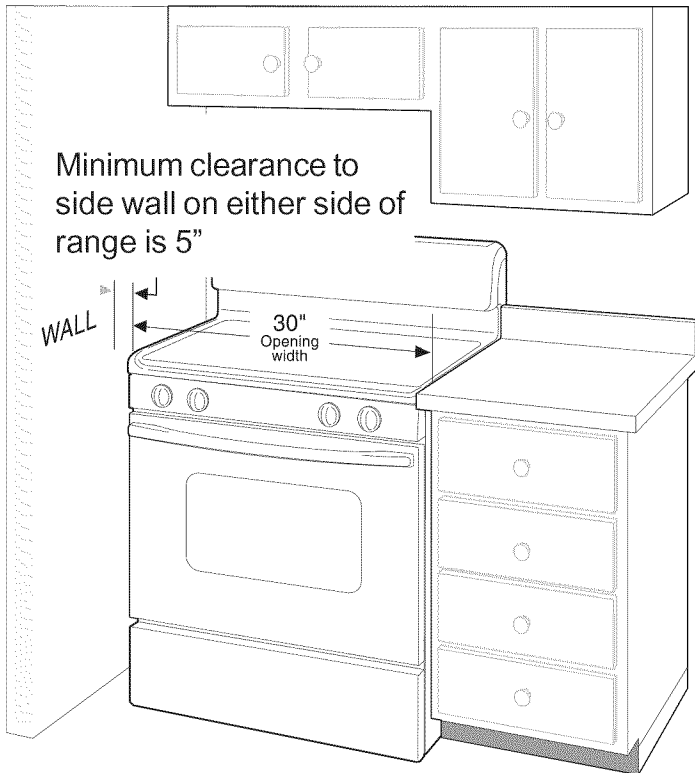

Fig. D

Anti-tip installation

IMPORTANT SAFETY WARNING!

To reduce the risk of tipping of the range, the range must be secured to the floor by properly installed anti-tip bracket and screws packed with the range. Failure to install the anti-tip bracket will allow the range to tip over if excessive weight is placed on an open door or if a child climbs upon it. Serious injury might result from spilled hot liquids or from the range itself.

If range is ever moved to a different location, the anti-tip brackets must also be moved and installed with the range.

Instructions are provided for installation in wood or cement fastened to either the floor or wall. When installed to the wall, make sure that screws completely penetrate dry wall and are secured in wood or metal. When fastening to the floor or wall, be sure that screws do not penetrate electrical wiring or plumbing.

Anti-tip bracket installation instructions

- 1. Locate the Bracket Using the Template** - (Bracket may be positioned on either the left or right side of the range. Refer to Figs. 24 thru 26 to position the bracket if template is not available). Mark the floor or wall where left or right side of the range will be located. If rear of range is against wall or no further than 1-1/4" from wall when installed, you may use the wall or floor mount method. If molding is installed and does not allow the bracket to fit flush against wall, remove molding or mount bracket to floor. For wall mount (Fig. 24), locate the bracket by placing the back edge of the template against rear wall and the side edge of template on the mark made referencing the side of the range. Place bracket on top of template and mark location of the screw holes in wall. If rear of range is further than 1-1/4" from wall when installed, attach bracket to the floor. For floor mount (Figs. 24 or 25), locate the bracket by placing back edge of the template where the rear of the range will be located. Mark the location of the screw holes shown in template.
- 2. Drill Pilot Holes & Fasten Bracket** - Drill 1/8" pilot hole where screws are to be located (Fig. 23). If bracket is to be mounted to the wall, drill pilot hole at an approximate 20° downward angle. If bracket is to be mounted to masonry or ceramic floors, drill 3/16" pilot hole 1-3/4" deep. The screws provided may be used in wood or concrete material. Use 5/16" nut-driver or flat head screwdriver to secure the bracket in place.
- 3. Level & Position Range** - Level range by adjusting the (4) leveling legs with a wrench. Note: A min. clearance of 1/8" is required between bottom of range and leveling legs to allow room for bracket. Slide range back into position (Fig. 26). Remove lower panel or storage drawer to visually check that rear leveling leg is inserted into and fully secured by the bracket. For models with a warmer drawer or broiler compartment, grasp the top rear edge of the range and carefully attempt to tilt it forward. Use a level to check your adjustments (Fig. 27).

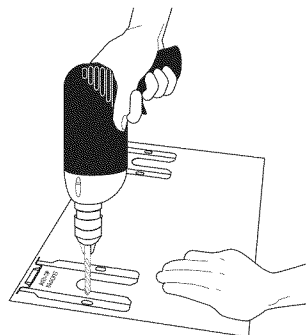
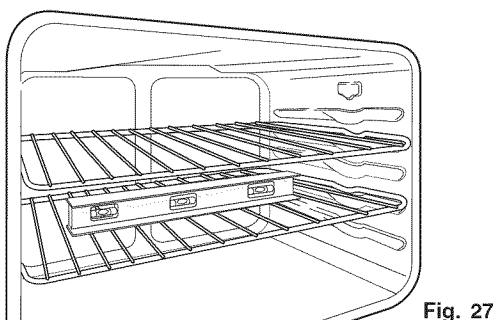
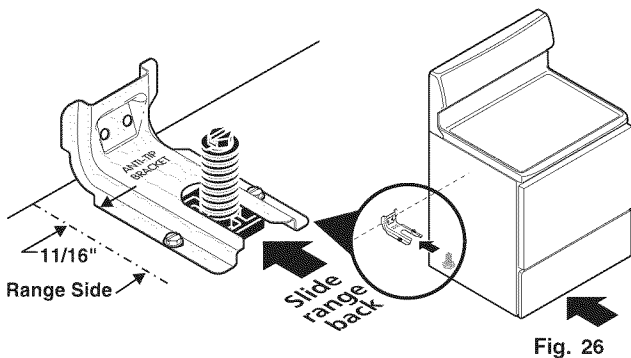
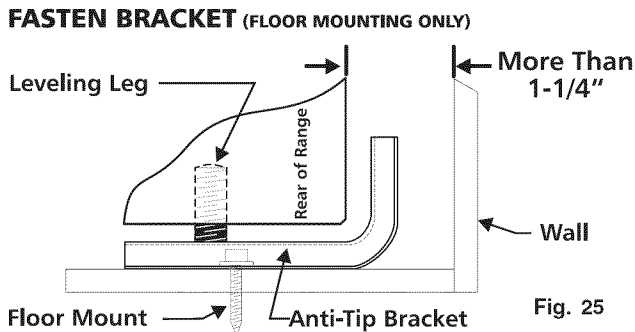
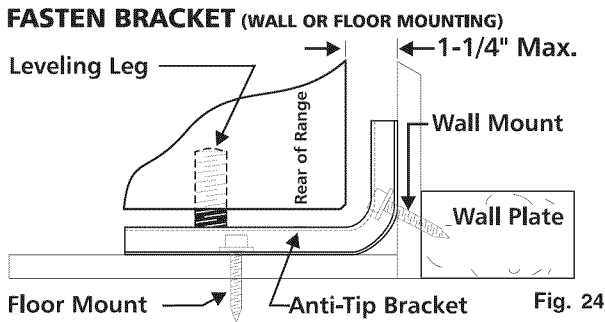

Fig. 23

INSTALLATION INSTRUCTIONS FOR FREESTANDING DUAL FUEL

Anti-tip bracket installation instructions



Electrical requirements

3 & 4 - Wire electrical wall Receptacle types and recommended mounting orientation on wall

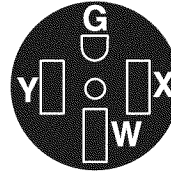

Required for new and remodeled installations

4 Wire Wall Receptacle (14-50R)

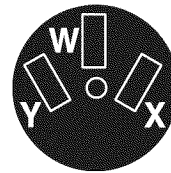

Allowed for existing installations

3 Wire Wall Receptacle (10-50R)

Fig. 28

Electrical connection requirements

This appliance must be properly installed and grounded by a qualified technician in accordance with the National Electrical Code ANSI/NFPA No. 70 -- latest edition -- and local electrical code requirements.

This appliance may be connected by means of permanent "Hard Wiring" or "Power Supply Cord Kit."

When hard wiring, do not leave excess wire in range compartment. Excess wire in the range compartment may not allow the access cover to be replaced properly, and could create a potential electrical hazard if wires become pinched. Connect only as instructed under "WIRING INSTRUCTIONS" in Step B of the Installation Steps. When using flexible conduit or range cable use flex connector or range cable strain relief (See Fig. 32 on page 7).

NOTE: Only use copper wire in connection to terminal block.

Models Requiring Power Supply Cord Kit

RISK OF FIRE OR ELECTRICAL SHOCK MAY OCCUR IF AN INCORRECT SIZE RANGE CORD KIT IS USED, THE INSTALLATION INSTRUCTIONS ARE NOT FOLLOWED OR STRAIN RELIEF BRACKET IS DISCARDED.

This appliance may be connected by means of a power supply cord. Only a power supply cord kit rated at 125/250 volts minimum, and marked for use with ranges shall be used. See chart (Fig. 29) for cord kit ampere rating information. Cord must have either four (4) or three (3) conductors (See Fig. 28). Terminals on end of wires must be either closed loop or open-end spade lugs with upturned ends. Cord must have strain relief clamp. See Step B in Installation Steps for 4 or 3 - Wire connections.

INSTALLATION INSTRUCTIONS FOR FREESTANDING DUAL FUEL

Range installations steps

A Install the power cord.

The rear access cover must be removed. To remove, loosen center screw (one screw) and remove access cover. The terminal block will then be accessible (See Fig. 30).

Range Connection Opening Size Chart				
Supply Cord Kit ampere rating information. See serial plate on range for kilowatt rating data.				
See Serial Plate on Range for KW Rating		Cord Kit Ampere Rating	Diameter (inches) of Range connection Opening	
120/240 Volts	120/208 Volts		Cord Kit	Permanent Wiring
8.8-16.5 KW 16.6-22.5 KW	7.9-12.5 KW 12.6-18.5 KW	40/50 Amp 50 Amp	1-3/8 in. 1-3/8 in.	1-1/8 in. 1-3/8 in.

Fig. 29

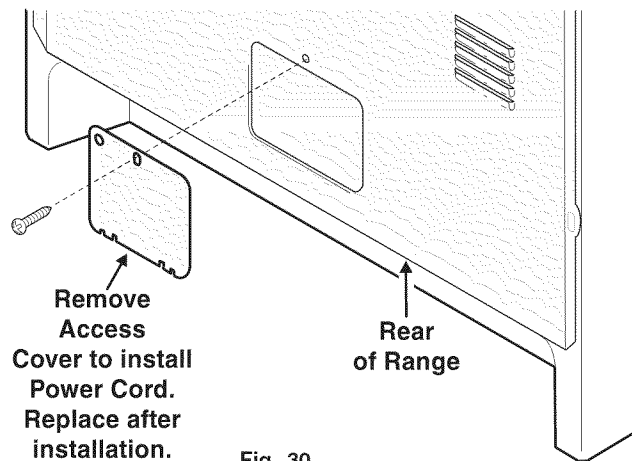

Fig. 30

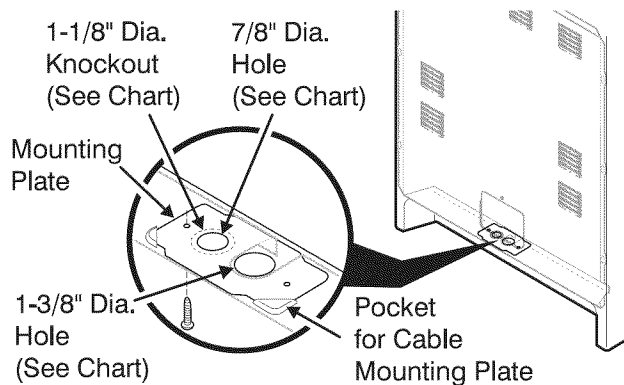

Fig. 31

B Wiring instructions (4-wire connection - See fig. 33)

Before wiring the range review the suggested power source location drawing in Fig. 2. If connecting to a 4-Wire electrical system (new branch-circuit or mobile home requires 4-Wire connection):

Power cord instructions

1. Follow the manufacturer's installation instructions supplied with the strain relief and install (Also see Figs. 29, 30, 31 & 32).
2. Insert the end connectors for Line 1, Line 2 and Neutral and tighten securely to the terminal block.
- IMPORTANT NOTE:** DO NOT LOOSEN the factory installed nut connections which secure the range wiring to the terminal block. Electrical failure or loss of electrical connection may occur if these 3 nuts are loosened or removed.
3. **You must disconnect the ground strap.** Remove the factory installed ground screw & plate to release the copper ground strap from the frame of the appliance. Cut and discard the copper ground strap & plate. KEEP the ground screw.
4. Connect the ground wire (Green) lead with the eyelet to the frame of the appliance with the ground screw using the same hole in the frame where the ground screw was originally installed (See Fig. 33).
5. Make sure all screws are tightened securely and replace the rear access cover (See Fig. 30).

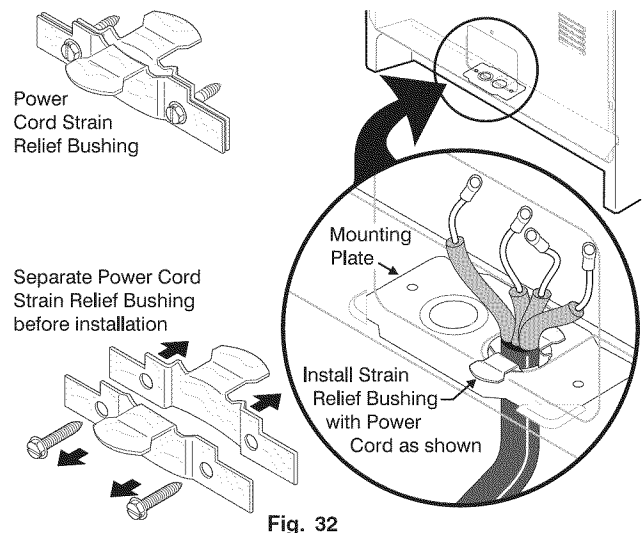

Fig. 32

INSTALLATION INSTRUCTIONS FOR FREESTANDING DUAL FUEL

Range installation instructions

OR **B** 3-Wire connection instructions (for existing installations ONLY) See Fig. 34)

Power Cord Connection

1. Follow the manufacturer's installation instructions supplied with the strain relief and install (Also see Figs. 29, 30 & 31).
2. Insert the end connectors for Line 1, Line 2 and Neutral and tighten securely to the terminal block (See Fig. 34).
IMPORTANT NOTE: DO NOT LOOSEN the factory installed nut connections which secure the range wiring to the terminal block. Electrical failure or loss of electrical connection may occur if these 3 nuts are loosened or removed.
3. Make sure all connections are tightened securely and replace the rear access cover (See Fig. 30).

Grounding instructions (for 3-Wire connections ONLY)

A ground strap is installed on this range which connects the center terminal of the terminal block (neutral) to the range chassis. The ground strap is connected to the range by the center, lowest screw (See Fig. 34). The ground strap must not be removed unless national or local codes do not permit use of ground strap.

NOTE: If the ground strap is removed for any reason, a separate ground wire must be connected to the separate ground screw attached to the range chassis and to an adequate ground source.

For 3 & 4-Wire permanent connections ONLY

3 - Wire permanent connection - follow Steps 1,2 & 5 below.

4 - Wire permanent connection - follow Steps 1 thru 5 below.

Before wiring the range, review the suggested power source location drawings in Fig. A & B. If connecting to a 4-Wire electrical system (new branch-circuit or mobile home requires 4-Wire connection):

1. **(3 & 4 - Wire permanent connections)** Follow the manufacturer's installation instructions supplied with the strain relief and install.

4-Wire Connection

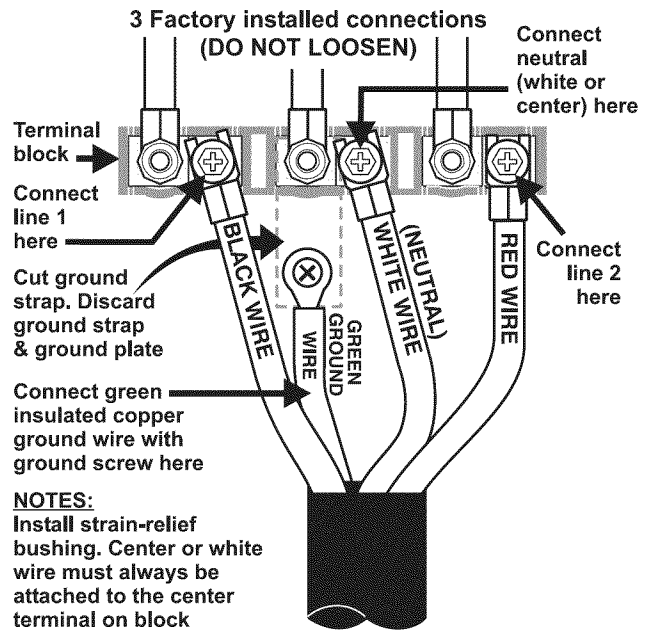

Fig. 33

3-Wire Connection

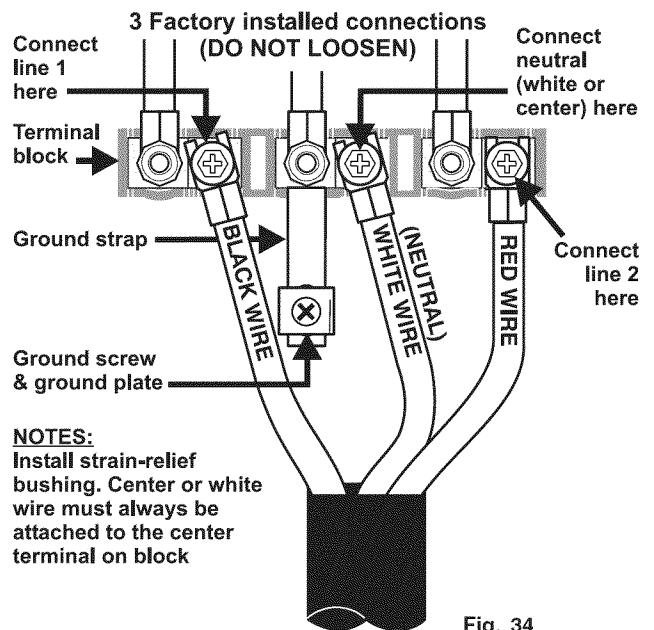

Fig. 34

INSTALLATION INSTRUCTIONS FOR FREESTANDING DUAL FUEL

Range installations steps

- (3 & 4 - Wire Permanent Connections)** Strip insulation away from the ends of the permanent wiring for Line 1, Line 2, Neutral (also strip ground wire on 4-Wire Connections). Tighten all 3 wire leads to the terminal block (Follow wire locations shown in Fig. 35). **IMPORTANT NOTE: DO NOT LOOSEN** the factory installed nut connections which secure the range wiring to the terminal block. Electrical failure or loss of electrical connection may occur if these 3 nuts are loosened or removed. **NOTE: For 3-Wire Permanent Connections skip Steps 3 & 4 and continue with Step 5.**
- (4-Wire Permanent Connection ONLY)** Disconnect the ground strap. Remove the factory installed ground screw & plate to release the factory installed copper ground strap from frame of the appliance. Cut and discard the copper strap from the terminal block. KEEP the ground screw, ground plate and go to Step 4.
- (4-Wire Permanent Connection ONLY)** Connect the ground wire lead (Green) to the frame of the appliance using the ground screw & plate as shown in Fig. 36. Be sure to install using the same hole in the frame where the ground screw was originally installed.
- (3 & 4 - Wire Permanent Connections)** Make sure all connections are tightened securely and replace the rear access cover (See Fig. 30).

FOR 3 & 4-Wire Permanent Connections

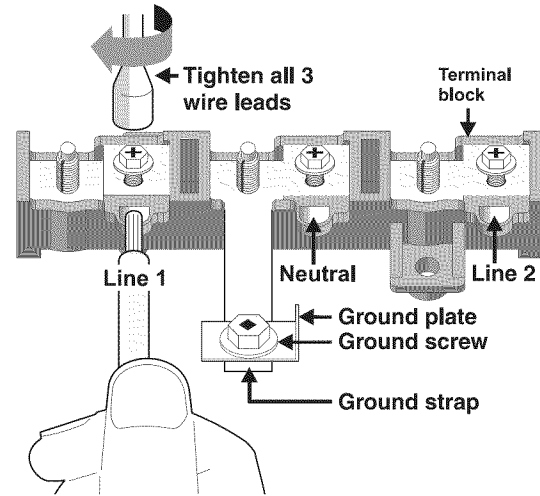

NOTE: Non-terminated field wire compression connections must be set at approximately 22in./lbs. Always use 10 ga. wire or larger.

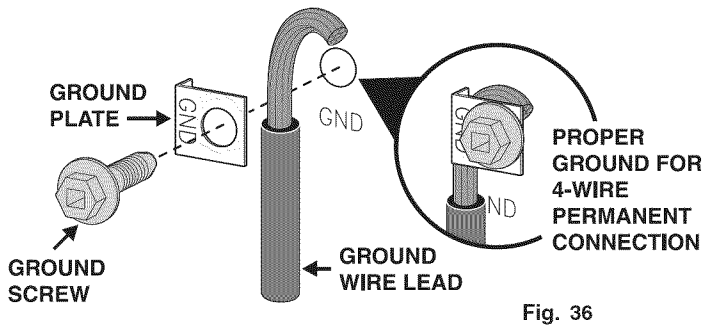

Fig. 36

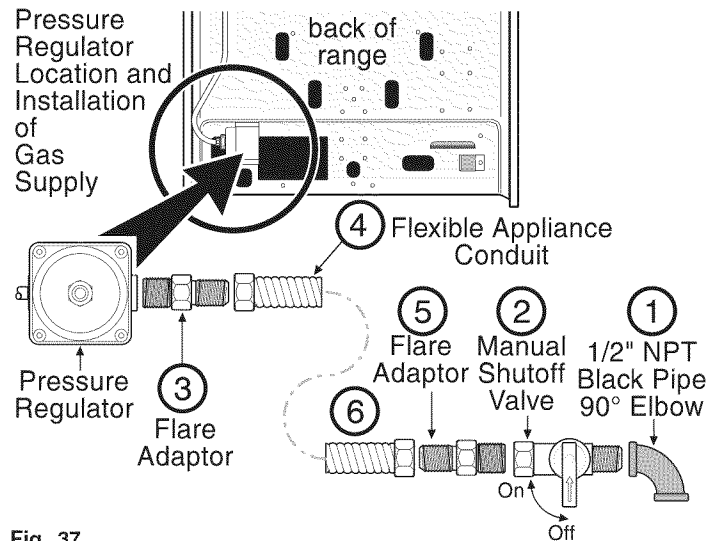

Fig. 37

INSTALLATION INSTRUCTIONS FOR FREESTANDING DUAL FUEL

Range installation instructions

C Provide an adequate gas supply.

This range is pre-set to operate on 4" natural gas manifold pressure. A convertible Pressure Regulator is connected to the manifold and **MUST** be connected in series with the gas supply line (Refer to Fig. 37). If the LP/Propane conversion kit has been used, follow instructions provided with the kit for converting the pressure regulator to LP/Propane use. The LP Kit can be found on the back side of the range or ordered from your dealer.

Care must be taken during installation of range not to obstruct the flow of combustion and ventilation air. The gas supply line should be 1/2" or 3/4" I.D.

For proper operation, the maximum inlet pressure to the regulator should be no more than 14 inches of water column pressure. The inlet pressure to the regulator must be at least 1 inch greater than regulator manifold pressure. Examples: If regulator is set for natural gas 4 inch manifold pressure, inlet pressure must be at least 5 inches; if regulator has been converted for LP/Propane gas 10 inch manifold pressure, inlet pressure must be at least 11 inches. Leak testing of the appliance shall be conducted according to the instructions in Step E.

D Seal the wall and floor openings (Refer to Figs. 1, 2 & 3).

Seal any openings in the wall behind the range and in the floor under the range after gas supply line is installed.

E Connect the range to the gas supply (refer to Fig. 37).

Before connecting gas supply to range, **review the suggested power source location drawings** (Figs. 1, 3 & 4). To prevent leaks apply pipe joint sealant on all male (outside) pipe threading. The Pressure Regulator can be found mounted to the lower left rear of range (See Fig 37). To install the gas supply:

- 1.) Install 1/2" NPT 90° Black Pipe Elbow to the gas supply pipe stub (See Figs. 3, 17 & 37)
- 2.) Install an external gas Shut-Off Valve (manual) to gas supply line in an easily-accessible location outside of the range. Be sure you know how and where to shut-off the gas supply to the range (Figs. 16 & 37).
- 3.) Install Flare Adapter* to gas Pressure Regulator (Figs. 19 & 37).

⚠ CAUTION Do not allow the Pressure Regulator to turn on pipe when tightening fittings.

- 4.) Attach flexible Appliance Conduit to Flare Adapter on Pressure Regulator (Figs. 18 & 37).
- 5.) Install 2nd Flare Adapter* to external manual Shut-Off Valve (Figs. 19 & 37).
- 6.) Attach flexible Appliance Conduit to Flare Adapter on Shut-Off Valve (Fig. 37).
- 7.) After making these connections, check for gas leaks. Turn the gas supply on to the range and use a liquid leak detector at all joints and conduits to check for leaks in the system.***Note:** Be sure to use the 2 Flare Adapters supplied with the Flexible Conduit Kit.

⚠ WARNING Do not use a flame to check for gas leaks.

Checking Manifold Gas Pressure:

Disconnect the range and its individual shut-off valve from the gas supply piping system during any pressure testing of that system at test pressures greater than 14" of water column pressure (approximately 1/2" psig). The appliance must be isolated from the gas supply piping system by closing its individual manual shut-off valve during any pressure testing of the gas supply piping system at test pressures equal to or less than 14" of water column pressure (approximately 1/2" psig).

If it should be necessary to check the manifold gas pressure, connect manometer (water gauge) or other pressure device to the top burner right rear orifice. Using a rubber hose with inside diameter of approximately 1/4," hold tubing down tight over orifice. Turn burner valve on. For an accurate pressure check have at least two (2) other top burners burning. Be sure the gas supply (inlet) pressure is at least one inch above specified range manifold pressure. The gas supply pressure should never be over 14" water column. When properly adjusted for Natural Gas the manifold pressure is 4" (For LP/Propane Gas the manifold pressure is 10").

F Read the electrical connection details below. Plug the range into the wall receptacle.

⚠ WARNING Before servicing, disconnect electrical supply at circuit breaker, fuse or Power Cord.

⚠ WARNING PLEASE READ CAREFULLY! For personal safety, this product must be properly grounded.

INSTALLATION INSTRUCTIONS FOR FREESTANDING DUAL FUEL

G Carefully slide range into cabinet opening.

Carefully slide range into cabinet opening while inserting rear leveling leg into and FULLY ENGAGING THE ANTI-TIP BRACKET (See Fig. 26). Make sure that the flexible appliance conduit (Fig. 18) and the power cord (Fig. 20) folds into the remaining open floor area behind the range warmer or storage drawer. **Make sure that the flexible appliance conduit does not become pinched or kinked!** Pre-shape the flexible appliance conduit and power cord if necessary to insure that the range slides into cabinet opening properly. Be sure to check level of the range by placing a level horizontally on an oven rack (See Fig. 27).

Example of Burner Assembly

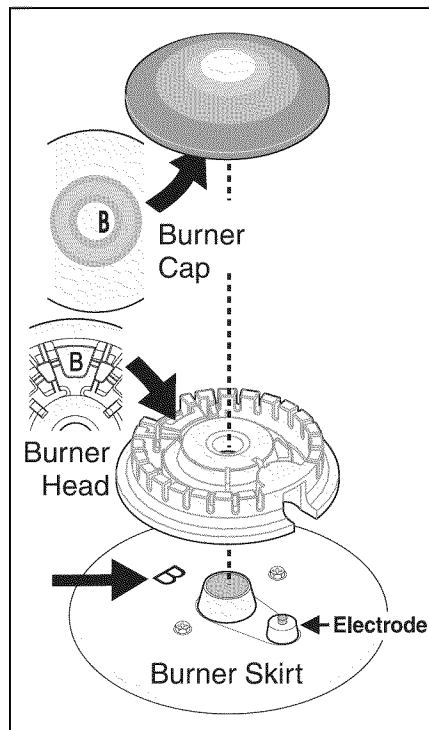

Cooktop Layout

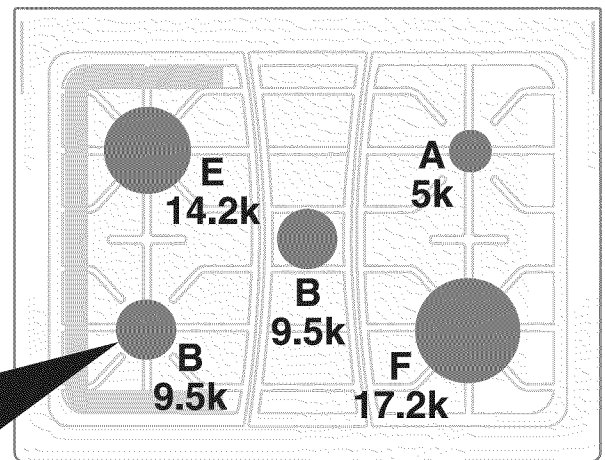

Front of cooktop

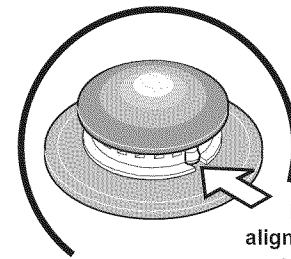

Electrodes must align into slot or hole for each Burner Head

Fig. 38

H Surface burner heads, cap & grates.

Your range is shipped with the Burner Heads and Burner Caps in the correct locations. Packing material is located between the Burner Heads and Burner Skirts.

1. Be sure to follow the Installation Instructions before installing and using your new range.
2. Remove all packing tape from cooktop area. Remove all Burner Caps and Burner Heads.
3. Discard all packing material located under Burner Heads.
4. To replace Burner Heads & Caps, match the letters located under center of Burner Caps with the letters located inside Burner Heads (Fig. 38).
5. Match the letters stamped on Burner Skirts with Burner Heads and Burner Caps (See Fig. 38). Replace the Burner Heads and Caps on cooktop (See Fig. 38). Carefully align the Electrodes into slot or hole of each Burner Head (Fig. 38). Note: The Burner Heads should sit flat on Cooktop Burner Skirts.
6. Unpack Burner Grates and position on the cooktop.

REMEMBER — DO NOT ALLOW SPILLS, FOOD, CLEANING AGENTS OR ANY OTHER MATERIAL TO ENTER THE GAS ORIFICE HOLDER OPENING. Always keep the Burner Caps and Burner Heads in place whenever the surface burners are in use.

I Check electric ignition of surface burners.

Operation of electric igniters should be checked after range and supply line connectors have been carefully checked for leaks and range has been connected to electric power.

1. To check for proper lighting, **push in and turn** surface burner knob **counterclockwise** to the (lite) position. You will hear the igniter sparking (Fig. 39).
2. The surface burner should light when gas is available to the top burner. Purge air from supply lines by leaving knob in the (lite) position until burner ignites. Each burner should light within four (4) seconds in normal operation after air has been purged from supply lines.
3. Visually check that the burner has lit. Once the burner lites, turn the control knob out of the (lite) position.
4. The range has separate electrodes (igniters) for each burner. Try each knob separately until all burner valves have been checked.

INSTALLATION INSTRUCTIONS FOR FREESTANDING DUAL FUEL

Range installations steps

J Adjust the "LO" setting of surface burner valve (for linear flow valves only).

Test to verify if "LO" setting should be adjusted:

1. Push in and turn control to LITE until burner ignites.
2. Push in and quickly turn knob to LOWEST POSITION.
3. If burner goes out, reset control to OFF.
4. Remove the surface burner control knob.
5. Insert a thin-bladed screwdriver into the hollow valve stem and engage the slotted screw inside (See Fig. 40). Flame size can be increased or decreased with the turn of the screw. Turn counterclockwise to increase flame size. Turn clockwise to decrease flame size.

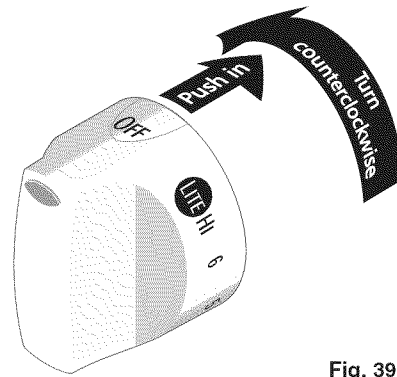

Fig. 39

K After installation is complete, make all controls are left in the OFF position.

Care, cleaning and maintenance

Refer to the Use & Care Guide for cleaning instructions. If removing the range is necessary for cleaning or maintenance, shut off the gas supply. Disconnect the gas and electrical supply. If the gas or electrical supply is inaccessible, lift the range slightly at the front and pull out away from the wall. Pull only as far as necessary to disconnect the gas and electrical supply. Finish removing the range for servicing and cleaning. Reinstall in reverse order making sure to level the range and check gas connections for leaks. See anti-tip instructions for proper anti-tip anchoring instructions.

Before you call for service

Refer to the Use & Care Guide for cleaning instructions. If removing the range is necessary for cleaning or maintenance, shut off the gas supply. Disconnect the gas and electrical supply. If the gas or electrical supply is inaccessible, lift the range slightly at the front and pull out away from the wall. Pull only as far as necessary to disconnect the gas and electrical supply. Finish removing the range for servicing and cleaning. Reinstall in reverse order making sure to level the range and check gas connections for leaks. See page 3 of this document for proper anti-tip anchoring instructions.

Model and serial number location

The Serial Plate is located on the right-hand surface of the oven front frame at the storage or warmer drawer; or the lower panel area (See Fig. 41).

When ordering parts for or making inquires about your range, always be sure to include the model and serial numbers and a lot number or letter from the Serial Plate on your range. The Serial Plate will also inform you of the rating of the burners, the type of fuel and the pressure the range was adjusted for when it left the factory.

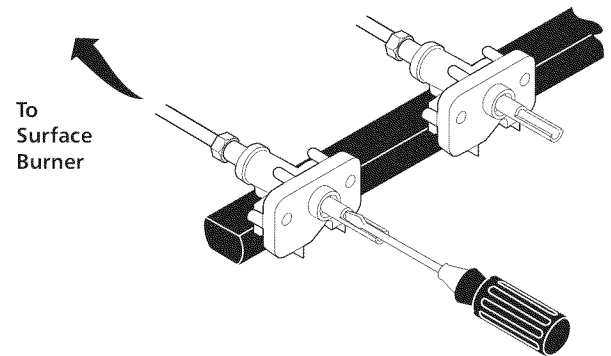
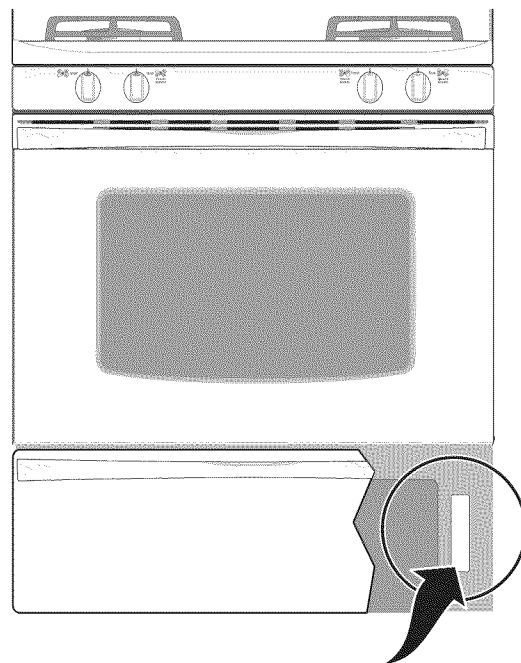

Fig. 40



Serial plate is located on the lowerright front frame of the appliance. Alternate location may be under cooktop.

Fig. 41