

SEARS

OWNER'S MANUAL

CRAFTSMAN[®]

PERMANENTLY LUBRICATED TANK MOUNTED AIR COMPRESSOR

- **SAFETY GUIDELINES**
- **ASSEMBLY**
- **OPERATION**
- **MAINTENANCE**
- **TROUBLESHOOTING**
- **REPAIR PARTS**





IMPORTANT:
Read the Safety Guidelines and
All Instructions Carefully Before
Operating.

Sears, Roebuck and Co., Hoffman Estates, IL 60179 U.S.A.

TABLE OF CONTENTS

	Page
SAFETY GUIDELINES	3
WARNING CHART	3
GLOSSARY	5
ACCESSORIES FOR USE WITH SEARS AIR COMPRESSORS.....	5
GENERAL INFORMATION	5
DESCRIPTION OF OPERATION	6
ASSEMBLY	7
REMOVAL OF SHIPPING BOARDS AND INSTALLATION OF RUBBER FEET	8
INSTALLATION AND BREAK-IN PROCEDURES	8
Location of Air Compressor	8
Lubrication and Oil	8
Extension Cords	9
Voltage and Current Protection	9
Grounding Instructions	9
Break-in Procedures	10
OPERATING PROCEDURES	10
MAINTENANCE	11
Air Filter - Inspection and Replacement	11
Check Valve -Replacement.....	11
Safety Valve - Inspection	11
Motor	11
Motor Replacement - Wiring Diagram	11
STORAGE	11
TROUBLESHOOTING GUIDE	12
HOW TO ORDER REPAIR PARTS.....	14
WARRANTY	14

SAFETY GUIDELINES - DEFINITIONS

<p>This manual contains information that is important for you to know and understand. This information relates to protecting YOUR SAFETY and PREVENTING EQUIPMENT PROBLEMS. To help you recognize this information, we use symbols to the right. Please read the manual and pay attention to these sections.</p>	 DANGER	 CAUTION
	<p>URGENT SAFETY INFORMATION - A HAZARD THAT WILL CAUSE SERIOUS INJURY OR LOSS OF LIFE</p>	<p>Information for preventing damage to equipment.</p>
	 WARNING	 NOTE
	<p>IMPORTANT SAFETY INFORMATION - A HAZARD THAT <i>MIGHT</i> CAUSE SERIOUS INJURY OR LOSS OF LIFE.</p>	<p>Information that you should pay special attention to.</p>

IMPORTANT SAFETY INSTRUCTIONS

- SAVE THESE INSTRUCTIONS •

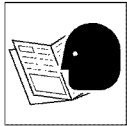

IMPROPER OPERATION OR MAINTENANCE OF THIS PRODUCT COULD RESULT IN SERIOUS INJURY AND PROPERTY DAMAGE. READ AND UNDERSTAND ALL WARNINGS AND OPERATING INSTRUCTIONS BEFORE USING THIS EQUIPMENT.

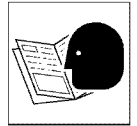

WHAT TO LOOK FOR	WHAT COULD HAPPEN	HOW TO PREVENT IT
Hot Parts	The compressor head gets hot when the air compressor is running. If you touch it, you may be seriously burned.	Never touch the air compressor head during or immediately after operation.
Flammable Vapors	It is normal for the motor and pressure switch to spark when the compressor starts or stops. A spark can ignite flammable vapors from gasoline or solvents, causing a fire or explosion.	<p>If spraying a flammable material, provide ample ventilation. Never spray in a closed area. There must be a flow of fresh air at all times.</p> <p>Always operate the air compressor in well-ventilated areas, free of gasoline or other solvent vapors. Do not operate the compressor near the spray area.</p>
Air Tank	<p>Modifications to air compressor components in an attempt to reach higher air pressure can cause the air tank to rupture or explode.</p> <p>Incompatibility between tank and compressor will cause the tank to rupture.</p> <p>Modifications to the air tank will cause it to weaken.</p>	<p>Do not adjust, remove or tamper with the safety valve or pressure switch. If safety valve or pressure switch replacement is necessary, a part with the same ratings must be used.</p> <p>Never use a motor with a higher horsepower rating than the one supplied. Never replace the air tank with a different model or a larger tank. Return to authorized Service Center if replacement is required.</p> <p>Never drill into, weld or in any way modify the air tank. The tank may rupture or explode. If leaks develop due to corrosion or tank is damaged, return to authorized Service Center for replacement.</p>

SAFETY GUIDELINES

WHAT TO LOOK FOR	WHAT COULD HAPPEN	HOW TO PREVENT IT
Compressed Air	<p>Compressed air can propel dust, dirt or loose particles it comes in contact with. These propelled particles may cause serious injury or damage.</p> <p>Too much air pressure applied to air tools or accessories can cause damage or risk of bursting.</p>	<p>Never point any nozzle or sprayer toward a person or any part of the body.</p> <p>Always wear safety goggles or glasses when using the air compressor.</p> <p>Always turn the air compressor off before attaching or removing accessories.</p> <p>Check the manufacturer's pressure rating for air tools and accessories. Regulator outlet pressure must never exceed the maximum pressure rating.</p>
Electricity	<p>Your air compressor is powered by electricity. Like any other electrically powered device, if it is not used properly it may cause electrical shock.</p>	<p>Always unplug the air compressor prior to maintenance or repair.</p> <p>Never use the air compressor outdoors when it is raining.</p> <p>Always plug the cord into an electrical outlet with the specified voltage and adequate fuse protection.</p>
Toxic Vapors	<p>It is normal for compressed air to contain toxic or irritating vapors. Such vapors are harmful if inhaled.</p> <p>Certain materials you are spraying (like paint, weed killer, sand or insecticide) can be harmful if you inhale them.</p>	<p>Never directly inhale the compressed air produced by this unit.</p> <p>Read labels and safety data for all materials you spray. Follow all safety precautions.</p> <p>Use a mask or respirator if there is a chance of inhaling toxic sprayed materials. Masks and respirators have limits and will only provide protection against some kinds and limited amounts of toxic material. Read mask and respirator instructions carefully. Consult with a safety expert or industrial hygienist if you are not sure about the use of a certain mask or respirator.</p>
Unsuitable Solvents	<p>The solvents 1,1,1 - Trichloroethane and Methylene Chloride can chemically react with aluminum used in paint spray guns, paint pumps, etc., and cause an explosion. These solvents can also react with galvanized components and cause corrosion and weakening of parts. This does not affect your air compressor - but it may affect the equipment being used.</p>	<p>If the material you intend to spray contains the solvents listed at left (read the label or data sheet), do not use accessories that contain aluminum or galvanized parts. You must either change the material you intend to spray, or use only stainless steel spray equipment.</p>

GLOSSARY

CFM: Cubic feet per minute.

SCFM: Standard cubic feet per minute; a unit of measure of air delivery.

PSIG: Pounds per square inch gauge; a unit of measure of pressure.

ASME: American Society of Mechanical Engineers; made, tested, inspected and registered to meet the standards of the ASME.

U.L. Listed: Underwriter Laboratories; Samples of compressor outfits, taken from production, were submitted to U.L. and found to comply with their requirements for design and performance.

Cut-In Pressure: While the motor is off, air tank pressure drops as you continue to use your accessory. When the tank pressure drops to a certain low level the motor will restart automatically. The low pressure at which the motor automatically re-starts is called "cut-in pressure."

Cut-Out Pressure: When you turn on your air compressor and it begins to run, air pressure in the air tank begins to build. It builds to a certain high pressure before the motor automatically shuts off - protecting your air tank from pressure higher than its capacity. The high pressure at which the motor shuts off is called "cut-out pressure."

ACCESSORIES FOR USE WITH SEARS AIR COMPRESSORS

The following accessories are available through the current general sale catalog or at full-line Sears stores.

- SPRAY GUNS
- BLOW GUNS
- AIR CAULKING GUNS
- AIR POWERED WASHER GUNS
- SANDBLASTERS
- AIR BRUSHES
- AIR LINE FILTERS
- TIRE AIR CHUCKS
- PAINT TANKS
- AIR TANKS
- INFLATOR KITS
- QUICK CONNECTOR SETS
(various sizes)

- VISCOSIMETER
- AIR PRESSURE REGULATORS
- OIL FOG LUBRICATORS
- AIR TOOLS:
 - Sanders
 - Drills
 - Impact Wrenches
 - Hammers
- AIR HOSE:
 - 1/4", 5/16" or 3/8" I.D.
 - in various lengths
- NAILER/STAPLERS
 - Decking

- Farming
- Roofing
- Siding
- Finishing
- Carpenting
- Upholstery
- Picture Framing
- DRAIN CLEANER
- DUSTER GUN

GENERAL INFORMATION

You have purchased an air compressor unit consisting of a 1 cylinder, single-stage air compressor pump, an air tank, wheels, handle and associated controls and instruments.

This air compressor requires no oil. Now you can enjoy all the benefits of having an air compressor without ever having to purchase, add or change oil.

Your air compressor can be used for operating paint spray guns, air tools, caulking guns, grease guns, air

brushes, sandblaster, or inflating tires and plastic toys, spraying weed killers, insecticides, etc. An air pressure regulator is usually necessary for most of the applications.

Separate air transformers which combine the functions of air regulation and/or moisture and dirt removal should be used where applicable.

These accessories can be purchased from most Sears stores or from the Sears Power Tool Catalog.

DESCRIPTION OF OPERATION

Air Compressor Pump: To compress air, the piston moves up and down in the cylinder. On the downstroke, air is drawn in through the air intake valves. The exhaust valve remains closed. On the upstroke of the piston, air is compressed. The intake valves close and compressed air is forced out through the exhaust valve, through the outlet tube, through the check valve and into the air tank. Working air is not available until the compressor has raised the air tank pressure above that required at the air outlet.

Check Valve: When the air compressor is operating, the check valve is “open”, allowing compressed air to enter the air tank. When the air compressor reaches “cut-out” pressure, the check valve “closes”, allowing air pressure to remain inside the air tank.

Pressure Release Valve: The pressure release valve located on the side of the pressure switch, is designed to automatically release compressed air from the compressor head and the outlet tube when the air compressor reaches “cut-out” pressure or is shut off. If the air is not released, the motor will try to start, but will be unable to. The pressure release valve allows the motor to restart freely. When the motor stops running, air will be heard escaping from the valve for a few seconds. No air should be heard leaking when the motor is running.

Pressure Switch: The pressure switch automatically starts the motor when the air tank pressure drops below the factory set “cut-in” pressure. It stops the motor when the air tank pressure reaches the factory set “cut-out” pressure.

Shut-off Valve: Turn the knob counter-clockwise to open the valve and clockwise to close.

Safety Valve: If the pressure switch does not shut off the air compressor at its cut-out pressure setting, the safety valve will protect against high pressure by “popping out” at its factory set pressure (slightly higher than the pressure switch cut-out setting).

Regulator: The air pressure coming from the air tank is controlled by the regulator knob. Turn the knob clockwise to increase pressure and counter-clockwise to decrease pressure. To avoid minor readjustment after making a change in pressure setting, always approach the desired pressure from a lower pressure. When reducing from a higher to a lower setting, first reduce to some pressure less than that desired, then bring up to the desired pressure. Depending on the air requirements of each particular accessory, the outlet regulated air pressure may have to be adjusted while operating the accessory.

Outlet Pressure Gauge: The outlet pressure gauge indicates the air pressure available at the outlet side of the regulator. This pressure is controlled by the regulator and is always less or equal to the tank pressure. See “Operating Procedures”.

Tank Pressure Gauge: The tank pressure gauge indicates the reserve air pressure in the tank.

Flow Valve: This compressor may contain a flow valve which blows air for approximately 10 seconds. This is normal and helps the compressor start or restart easily.

Cooling System: This compressor contains an advanced design cooling system. At the heart of this cooling system is an engineered fan. It is perfectly normal for this fan to blow air through the vent holes in large amounts. You know that the cooling system is working with air is being expelled.

TOOLS NEEDED FOR ASSEMBLY

- an adjustable wrench for attaching the pressure regulator
- a 9/16" socket or open end wrench for attaching the wheels, wheel plates and hose adapter.
- a 7/16" open end wrench for attaching the air pressure gauges
- a 3/16" hex key for installing the plug in the regulator
- a 3/8" open end wrench to tighten handle screws
- a #2 Phillips screwdriver for attaching the control cover
- a 3/8" socket wrench for removal of shipping boards and installation of rubber feet
- a 9/16" socket or open end wrench for attaching the hose adapter.
- a 7/16" and 9/16" open end wrench for attaching the air pressure gauges

ASSEMBLY

Installing Wheels, Wheel Plates, Handles, Rubber Foot Strip, Shut-off Valve (not included on some models)

⚠ WARNING

THE WHEELS AND HANDLE DO NOT PROVIDE ADEQUATE CLEARANCE, STABILITY OR SUPPORT FOR PULLING THE UNIT UP AND DOWN STAIRS OR STEPS. THE UNIT MUST BE LIFTED, OR PUSHED UP A RAMP.

1. Attach the handle to the inside of the compressor saddle by pushing the handle in until the slot in the handle engages with the tabs in the saddle. Pull the handle back and install the two screws, one on each side of the saddle. Tighten securely.

⚠ CAUTION

It may be necessary to brace or support one end of the outfit when attaching the wheels, wheel plates, and the rubber foot strip, because the air compressor will have a tendency to tip.

2. Remove the protective paper strip from the adhesive backed rubber foot strip. Attach the rubber foot strip to the bottom of the air tank leg. Press firmly into place.

On Models Requiring a Wheel Plate:

Attach a wheel plate to each tank leg.

Attach one wheel to each side of the air compressor. Use the top wheel plate hole. Use one shoulder bolt and one nut for each wheel. Tighten securely.

3. On models not requiring wheel plate, install one shoulder bolt and one nut for each wheel using **lower** bolt hole. Tighten securely. The outfit will sit level if the wheels are properly installed.

Installing Regulator and/or Control Cover (not included on some models)

Use a small amount of pipe thread sealant on all pipe thread joints.

Install the regulator on the end of the manifold using the short pipe nipple. The arrow on the bottom of the regulator must point away from the manifold in order for the regulator to function properly.

Install the adapter and plug in the regulator. The plug is supplied with the regulator. Install the rear cover and the gauges at the same time. The diagrams below illustrate two various installations.

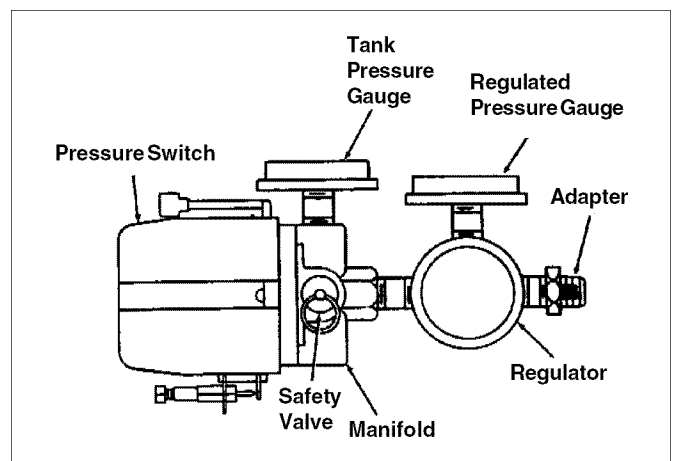
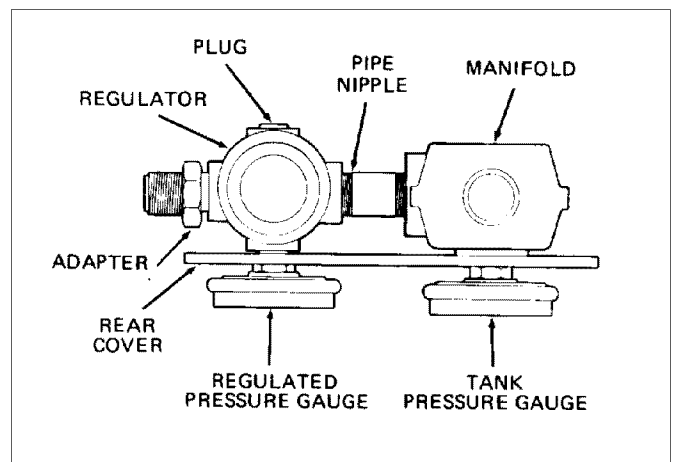

Install the control cover. Fasten it to the manifold using the Phillips screw. Install the plastic mounting ring to the regulator to fasten the top of the control cover.

Installing Shut-off Valve (not included on some models)

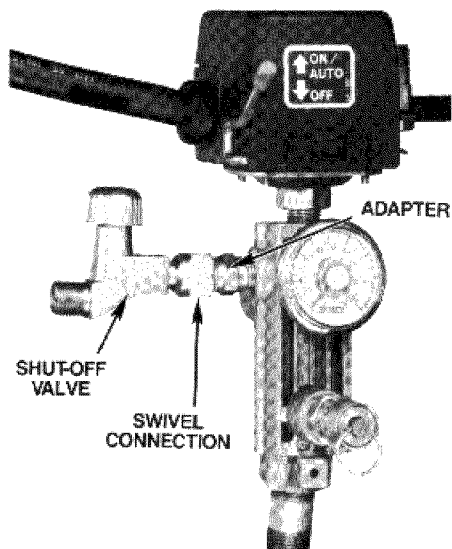

Apply a small amount of pipe sealant to the tapered pipe threads on the adapter and tighten into the manifold. Install the swivel connection end of the shut-off valve to the straight threaded end of the adapter (pipe sealant is not required) and tighten this connection. See photo.

REMOVAL OF SHIPPING BOARDS AND INSTALLATION OF RUBBER FEET

(not included on some models)

CAUTION

It may be necessary to brace or support one end of the outfit when attaching the wheels, wheel plates, and the rubber foot strip, because the air compressor will have a tendency to tip.

1. Tip the air compressor toward the intake muffler side. Remove (2) screws with washers securing the upper shipping board with 3/8" socket wrench. Reuse the (2) screws to attach (2) of the rubber feet. Tighten securely.

2. Carefully remove (2) screws with washers securing the lower shipping board. Supporting the outfit at this point may be necessary to prevent tipping. Again reuse the (2) screws to attach the remaining (2) rubber feet. Tighten securely.
3. Discard the (2) shipping boards and (4) washers.

INSTALLATION BREAK-IN PROCEDURES

Location of the Air Compressor

Locate the air compressor in a clean, dry and well ventilated area. The air filter must be kept clear of obstructions which could reduce air delivery of the air compressor. The air compressor should be located at least 12" away from the wall or other obstructions that will interfere with the flow of air. The air compressor head and shroud are designed to allow for proper cooling.

If humidity is high, a Sears air filter can be installed on the air outlet adapter to remove excessive moisture. Follow the instructions packaged with the air filter for proper installation.

Lubrication and Oil

This unit needs no lubrication or oiling.

Extension Cords

Use extra air hose instead of an extension cord to avoid voltage drop and power loss to the motor, and to prevent overheating

If an extension cord must be used, be sure it is:

- a 3-wire extension cord that has a 3-blade grounding plug, and a 3-slot receptacle that will accept the plug on the product
- in good condition
- no longer than 50 feet
- 12 gauge (AWG) or larger. (Wire size increases as gauge number decreases. 10 AWG and 8 AWG may also be used. DO NOT USE 14 OR 16 AWG.)

Voltage and Circuit Protection

Refer to your Parts List Manual for the voltage and circuit protection requirements of your compressor. Use only a fuse or circuit breaker that is the same rating as the branch circuit the air compressor is operated on. If the compressor is connected to a circuit protected by fuses, use only dual element time delay fuses, as noted in that Service Bulletin.

Refer to Parts List Manual for your compressor. Certain air compressor models can be operated on a 15 amp circuit if:

1. Voltage supply to circuit is normal.
2. Circuit is not used to supply any other electrical needs (lights, appliances, etc.).
3. Extension cords comply with specifications.
4. Circuit is equipped with a 15 amp circuit breaker or 15 amp time delay fuse. Use a Fusetron Type "T" time delay fuse.

If any of the above conditions cannot be met, or if operation of the compressor repeatedly causes interruption of the power, it may be necessary to operate it from a 20 amp circuit. It is not necessary to change the cord set.

GROUNDING INSTRUCTIONS

⚠ WARNING

RISK OF ELECTRICAL SHOCK. IN THE EVENT OF A SHORT CIRCUIT, GROUNDING REDUCES THE RISK OF SHOCK BY PROVIDING AN ESCAPE WIRE FOR THE ELECTRIC CURRENT. THIS AIR COMPRESSOR MUST BE PROPERLY GROUNDING.

1. The air compressor is equipped with a cord having a grounding wire with an appropriate grounding plug. The plug must be used with an outlet that has been installed and grounded in accordance with all local codes and ordinances. The outlet must have the same configuration as the plug. DO NOT USE AN ADAPTER (See Illustration).
2. Inspect the plug and cord before each use. Do not use if there are signs of damage.

Break-in Procedure

⚠ DANGER

IMPROPER GROUNDING CAN RESULT IN ELECTRICAL SHOCK.

Do not modify the plug that has been provided. If it does not fit the available outlet, the correct outlet should be installed by a qualified electrician.

If repairing or replacing cord or plug, the grounding wire must be kept separate from the current-carrying wires. Never connect the grounding wire to a flat blade plug terminal. The grounding wire has insulation with an outer surface that is green - with or without yellow stripes.

If these grounding instructions are not completely understood, or if in doubt as to whether the compressor is properly grounded, have the installation checked by a qualified electrician.

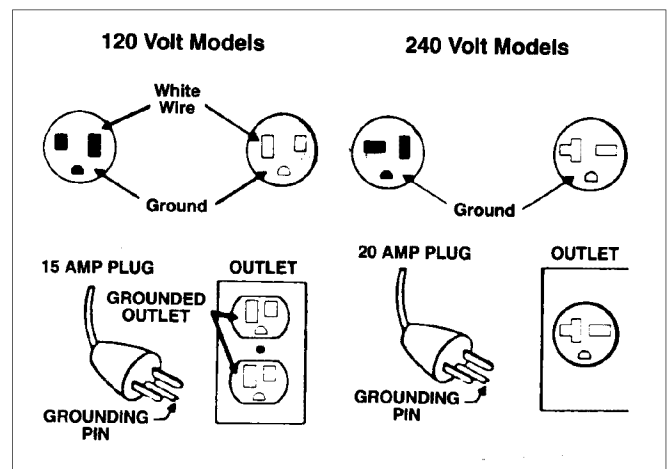

Serious damage may result if the following break-in instructions are not closely followed.

⚠ CAUTION

This procedure is required only once, before the air compressor is put into service.

1. Set the pressure switch OFF/AUTO lever in the “OFF” position.
2. Plug the power cord into the correct branch circuit receptacle.
3. Turn the regulator clockwise, opening it fully, to prevent air pressure build-up in the tank.

4. Move the OFF/AUTO lever to “AUTO”. The compressor will start.
5. Run the compressor for 15 minutes. Make sure the regulator is open and there is no tank pressure build-up.
6. After 15 minutes, close the regulator by turning it counterclockwise. The air tank will fill to cut-out pressure and then the motor will stop. Refer to “Operating Procedures”.

OPERATING PROCEDURES

1. Before attaching air hose or accessories, make sure the OFF/AUTO lever is set to “OFF” and the air regulator or shut-off valve is closed.
2. Attach hose and accessories.

⚠ WARNING

TOO MUCH AIR PRESSURE CREATES A HAZARDOUS RISK OF BURSTING. CAREFULLY FOLLOW STEPS 3 AND 5 EACH TIME THE COMPRESSOR IS USED.

⚠ CAUTION

Compressed air from the outfit may contain water condensation. Do not spray unfiltered air at an item that could be damaged. Some air operated tools or devices may require filtered air. Read the instructions for the air tool or device.

3. Check the manufacturer’s maximum pressure rating for air tools and accessories. The regulator outlet pressure must never exceed the maximum pressure rating.
4. Turn the OFF/AUTO lever to “AUTO” and allow tank pressure to build. Motor will stop when tank pressure reaches “cut-out” pressure.
5. Open the regulator by turning it clockwise. Adjust the regulator to the correct pressure setting. Your compressor is ready for use.

6. Always operate the air compressor in well-ventilated areas; free of gasoline or other solvent vapors. Do not operate the compressor near the spray area.

When you are finished:

7. Set the “OFF/AUTO” lever to “OFF”.
8. Turn the regulator counterclockwise and set the outlet pressure to zero.
9. Remove the air tool or accessory.
10. Open the regulator and allow the air to slowly bleed from the tank. Close the regulator when tank pressure is approximately 20 psi.
11. Drain water from air tank.

⚠ WARNING

WATER WILL CONDENSE IN THE AIR TANK. IF NOT DRAINED, WATER WILL CORRODE AND WEAKEN THE AIR TANK CAUSING A RISK OF AIR TANK RUPTURE.

With tank pressure at approximately 20 psi, open the drain cock or drain valve and tip the outfit forward approximately 20-30 degrees allowing the moisture to drain.

Note

If drain cock valve is plugged, release all air pressure. The valve can then be removed, cleaned, then reinstalled.

12. After the water has been drained, close the drain cock or drain valve. The air compressor can now be stored.

MAINTENANCE

⚠ WARNING

UNIT CYCLES AUTOMATICALLY WHEN POWER IS ON. WHEN DOING MAINTENANCE, YOU MAY BE EXPOSED TO VOLTAGE SOURCES, COMPRESSED AIR OR MOVING PARTS. PERSONAL INJURIES CAN OCCUR. BEFORE PERFORMING ANY MAINTENANCE OR REPAIR, UNPLUG THE COMPRESSOR AND BLEED OFF ALL AIR PRESSURE.

Air Filter - Inspection and Replacement

Keep the air filter clean at all times. Do not operate the compressor with the air filter removed.

A dirty air filter will not allow the compressor to operate at full capacity. Before you use the compressor, check the air filter to be sure it is clean.

If it is dirty, simply pull it out. You may wash it with a mild detergent and warm water, or replace it.

Check Valve - Replacement

1. Release all air pressure from air tank and unplug outfit.
2. Remove shroud.
3. Loosen the top and bottom nuts and remove the outlet tube.
4. Remove the pressure release tube and fitting.
5. Unscrew the check valve (turn counterclockwise) using a socket wrench.
6. Check that the valve disc moves freely inside the check valve and that the spring holds the disc in the upper, closed position. The check valve may be cleaned with a solvent, such as paint and varnish remover.
7. Apply sealant to the check valve threads. Reinstall the check valve (turn clockwise).
8. Replace the pressure release tube and fitting.
9. Replace the outlet tube and tighten top and bottom nuts.
10. Replace the shroud.

Safety Valve - Inspection

⚠ WARNING

IF THE SAFETY VALVE DOES NOT WORK PROPERLY, OVER-PRESSURIZATION MAY OCCUR, CAUSING AIR TANK RUPTURE OR AN EXPLOSION. OCCASIONALLY PULL THE RING ON THE SAFETY VALVE TO MAKE SURE THAT THE SAFETY VALVE OPERATES FREELY. IF THE VALVE IS STUCK OR DOES NOT OPERATE SMOOTHLY, IT MUST BE REPLACED WITH THE SAME TYPE OF VALVE.

Motor

The motor has an automatic reset thermal overload protector. If the motor overheats for any reason, the overload protector will shut off the motor. The motor must be allowed to cool down before restarting. The compressor will automatically restart after the motor cools.

If the overload protector shuts the motor off frequently, check for a possible voltage problem. Low voltage can also be suspected when:

1. The motor does not get up to full power or speed.
2. Fuses blow out when starting the motor; lights dim and remain dim when motor is started and is running.

Motor Replacement - Wiring Diagram

The motor connection diagram is located on the side of motor.

STORAGE

Before you store the air compressor, make sure you do the following:

1. Review the "Maintenance" and "Operating Procedures" sections and perform maintenance as necessary. Be sure to drain water from the air tank.

2. Protect the electrical cord and air hose from damage (such as being stepped on or run over). Wind them loosely around the compressor handle.

Store the air compressor in a clean and dry location.

TROUBLESHOOTING GUIDE

⚠ WARNING

PERFORMING REPAIRS MAY EXPOSE VOLTAGE SOURCES, MOVING PARTS OR COMPRESSED AIR SOURCES. PERSONAL INJURY MAY OCCUR. PRIOR TO ATTEMPTING ANY REPAIRS, UNPLUG THE COMPRESSOR AND BLEED OFF TANK AIR PRESSURE.

PROBLEM	CAUSE	CORRECTION
Excessive tank pressure - safety valve pops off.	<p>Pressure switch does not shut off motor when compressor reaches “cut-out” pressure.</p> <p>Pressure switch “cut-out” too high.</p>	<p>Move the pressure switch lever to the “OFF” position. If the outfit doesn’t shut off, and the electrical contacts are welded together, replace the pressure switch.</p> <p>If the contacts are good, check to see if the pin in the bottom of the pressure release valve is stuck. If it does not move freely, replace the valve.</p> <p>Return the outfit to Sears Service Center to check and adjust, or replace switch.</p>
Air leaks at fittings.	Tube fittings are not tight enough.	Tighten fittings where air can be heard escaping. Check fittings with soapy water solution. DO NOT OVERTIGHTEN.
Air leaks at or inside check valve.	Defective or dirty check valve.	A defective check valve results in a constant air leak at the pressure release valve where there is pressure in the tank and the compressor is shut off. Remove and clean or replace check valve. DO NOT OVERTIGHTEN.
Air leaks at pressure switch release valve.	<p>Defective pressure switch release valve.</p> <p>Defective check valve.</p>	<p>Remove and replace the release valve.</p> <p>A defective check valve results in a constant air leak at the pressure release valve when there is pressure in the tank and the compressor is shut off. Remove and clean or replace check valve. DO NOT OVERTIGHTEN.</p>
Air leaks in air tank or at air tank welds.	Defective air tank.	<p>Air tank must be replaced. Do not repair the leak.</p> <p style="text-align: center;">⚠ WARNING</p> <p style="text-align: center;">DO NOT DRILL INTO, WELD OR OTHERWISE MODIFY AIR TANK OR IT WILL WEAKEN. THE TANK CAN RUPTURE OR EXPLODE.</p>
Air leaks between head and valve plate.	Leaking gasket.	Torque head screws to 8 ft. lbs. If this does not stop leak, replace gasket.
Pressure reading on the regulated pressure gauge drops when an accessory is used.	It is normal for “some” pressure drop to occur.	<p>If there is an excessive amount of pressure drop when the accessory is used, adjust the regulator following the instructions on page 10.</p> <p style="text-align: center;">NOTE</p> <p style="text-align: center;">Adjust the regulated pressure under flow conditions (while accessory is being used).</p>

TROUBLESHOOTING GUIDE (Continued)

PROBLEM	CAUSE	CORRECTION
Air leak from safety valve.	Possible defect in safety valve.	Operate safety valve manually by pulling on ring. If valve still leaks, it should be replaced.
Knocking Noise	Defective check valve.	Remove and clean, or replace.
Compressor is not supplying enough air to operate accessories.	<p>Prolonged excessive use of air.</p> <p>Compressor is not large enough for air requirement.</p> <p>Restricted air intake filter.</p> <p>Hole in hose.</p> <p>Check valve restricted.</p> <p>Air leaks.</p>	<p>Decrease amount of air usage.</p> <p>Check the accessory air requirement. If it is higher than the SCFM or pressure supplied by your air compressor, you need a larger compressor.</p> <p>Clean or replace air intake filter. Do not operate the air compressor in the paint spray area.</p> <p>Check and replace if required.</p> <p>Remove and clean, or replace.</p> <p>Tighten fittings. (See Air Leaks Section of Troubleshooting Guide.)</p>
Motor will not run.	<p>Motor overload protection switch has tripped.</p> <p>Tank pressure exceeds pressure switch "cut-in" pressure.</p> <p>Wrong gauge wire or length of extension cord.</p> <p>Check valve stuck open.</p> <p>Loose electrical connections.</p> <p>Possible defective capacitor.</p> <p>Paint spray on internal motor parts.</p> <p>Possible defective motor.</p> <p>Fuse blown, circuit breaker tripped.</p> <p>Pressure release valve on pressure switch has not unloaded head pressure.</p>	<p>Let motor cool off and overload switch will automatically reset.</p> <p>Motor will start automatically when tank pressure drops below "cut-in" pressure of pressure switch.</p> <p>Check for proper gauge wire and cord length.</p> <p>Remove and clean, or replace.</p> <p>Check wiring connection inside pressure switch and terminal box area.</p> <p>Return to Sears Service Center for inspection or replacement, if necessary.</p> <p>Have checked at Sears Service Center. Do not operate the compressor in the paint spray area. See flammable vapor warning.</p> <p>Have checked at a local Sears Service Center.</p> <ol style="list-style-type: none"> 1. Check fuse box for blown fuse and replace, if necessary. Reset circuit breaker. Do not use a fuse or circuit breaker with higher rating than that specified for your particular branch circuit. 2. Check for proper fuse; only "Fusetron" type T fuses are acceptable. 3. Check for low voltage conditions and/or proper extension cord. 4. Disconnect the other electrical appliances from circuit or operate the compressor in its own branch circuit. <p>Bleed the line by pushing the lever on the pressure switch to the "off" position; if the valve does not open, replace it.</p>
Regulator knob continuous air leak. Regulator will not shut off at air outlet.	Dirty or damaged regulator internal parts.	Clean or replace regulator, or internal parts.

SEARS

OWNER'S MANUAL

When requesting service or ordering parts, always provide the following information:

- Model Number
- Part Number
- Part Description
- Name of Item

FULL ONE YEAR WARRANTY AIR COMPRESSOR

If this air compressor fails due to a defect in material or workmanship within one year from the date of purchase, RETURN IT TO THE NEAREST SEARS REPAIR CENTER THROUGHOUT THE UNITED STATES AND SEARS WILL REPAIR IT, FREE OF CHARGE. IF PURCHASED FROM ORCHARD SUPPLY HARDWARE, RETURN TO THE NEAREST ORCHARD STORE AND ORCHARD WILL REPAIR IT, FREE OF CHARGE.

If this air compressor is used for commercial or rental purposes, the warranty will apply for ninety days from the date of purchase.

This warranty gives you specific legal rights and you may have other rights which vary from state to state.

CRAFTSMAN®

PERMANENTLY LUBRICATED TANK MOUNTED AIR COMPRESSOR

For the repair or replacement parts you need

Call 7 am - 7 pm, 7 days a week

1-800-366-PART

(1-800-366-7278)

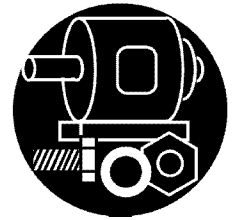

For in-home major brand repair service

Call 24 hours a day, 7 days a week

1-800-4-REPAIR

(1-800-473-7247)



For the location of a
Sears Parts and Repair Center in your area

Call 24 hours a day, 7 days a week

1-800-488-1222



For information on purchasing a Sears
Maintenance Agreement or to inquire
about an existing Agreement
call 9 am - 5 pm, Monday-Saturday

1-800-827-6655



SEARS
REPAIR SERVICES
America's Repair Specialists

Sears, Roebuck and Co., Hoffman Estates, IL 60179 U.S.A.