



Contact SAMSUNG WORLDWIDE

If you have any questions or comments relating to Samsung products, please contact the SAMSUNG customer care center.

Contacte con SAMSUNG WORLDWIDE

Si tiene alguna pregunta o comentario referente a nuestros productos, por favor contacte con nuestro Servicio de Atención al Cliente.

Country	Customer Care Center ☎	Web Site	Address
CANADA	1-800-SAMSUNG(726-7864)	www.samsung.com/ca	Samsung Electronics Canada Inc., Customer Service 55 Standish Court Mississauga, Ontario L5R 4B2 Canada
			Samsung Electronique Canada Inc., Service à la Clientèle 55 Standish Court Mississauga, Ontario L5R 4B2 Canada
U.S.A	1-800-SAMSUNG(726-7864)	www.samsung.com/us	Samsung Electronics America, Inc. 105 Challenger Road Ridgefield Park, NJ 07660-0511

SERIES **8**
850

LCD TV
user manual



BN68-01691A-02

imagine the possibilities

Thank you for purchasing this Samsung product. To receive more complete service, please register your product at

www.samsung.com/global/register

Model _____ Serial No. _____



Important Warranty Information Regarding Television Format Viewing

Wide screen format LCD Displays (16:9, the aspect ratio of the screen width to height) are primarily designed to view wide screen format full-motion video. The images displayed on them should primarily be in the wide screen 16:9 ratio format, or expanded to fill the screen if your model offers this feature and the images are constantly moving. Displaying stationary graphics and images on screen, such as the dark sidebars on nonexpanded standard format television video and programming, should be limited to no more than 5% of the total television viewing per week.

Additionally, viewing other stationary images and text such as stock market reports, video game displays, station logos, web sites or computer graphics and patterns, should be limited as described above for all televisions. Displaying stationary images that exceed the above guidelines can cause uneven aging of LCD Displays that leave subtle, but permanent burned-in ghost images in the LCD picture. To avoid this, vary the programming and images, and primarily display full screen moving images, not stationary patterns or dark bars.

On LCD models that offer picture sizing features, use these controls to view different formats as a full screen picture.

Be careful in the selection and duration of television formats used for viewing. Uneven LCD aging as a result of format selection and use, as well as burned-in images, are not covered by your Samsung limited warranty.

U.S.A Only

The product unit accompanying this user manual is licensed under certain intellectual property rights of certain third parties. In particular, this product is licensed under the following US patents: 5,991,715, 5,740,317, 4,972,484, 5,214,678, 5,323,396, 5,539,829, 5,606,618, 5,530,655, 5,777,992, 6,289,308, 5,610,985, 5,481,643, 5,544,247, 5,960,037, 6,023,490, 5,878,080, and under US Published Patent Application No. 2001-44713-A1.

This license is limited to private non-commercial use by end-user consumers for licensed contents. No rights are granted for commercial use. The license does not cover any product unit other than this product unit and the license does not extend to any unlicensed product unit or process conforming to ISO/IEC 11172-3 or ISO/IEC 13818-3 used or sold in combination with this product unit. The license only covers the use of this product unit to encode and/or decode audio files conforming to the ISO/IEC 11172-3 or ISO/IEC 13818-3. No rights are granted under this license for product features or functions that do not conform to the ISO/IEC 11172-3 or ISO/IEC 13818-3.

Other countries

The product unit accompanying this user manual is licensed under certain intellectual property rights of certain third parties. This license is limited to private non-commercial use by end-user consumers for licensed contents. No rights are granted for commercial use. The license does not cover any product unit other than this product unit and the license does not extend to any unlicensed product unit or process conforming to ISO/IEC 11172-3 or ISO/IEC 13818-3 used or sold in combination with this product unit. The license only covers the use of this product unit to encode and/or decode audio files conforming to the ISO/IEC 11172-3 or ISO/IEC 13818-3. No rights are granted under this license for product features or functions that do not conform to the ISO/IEC 11172-3 or ISO/IEC 13818-3.

SAMSUNG ELECTRONICS NORTH AMERICAN LIMITED WARRANTY STATEMENT

Subject to the requirements, conditions, exclusions and limitations of the original Limited Warranty supplied with Samsung Electronics (SAMSUNG) products, and the requirements, conditions, exclusions and limitations contained herein, SAMSUNG will additionally provide Warranty Repair Service in the United States on SAMSUNG products purchased in Canada, and in Canada on SAMSUNG products purchased in the United States, for the warranty period originally specified, and to the Original Purchaser only.

The above described warranty repairs must be performed by a SAMSUNG Authorized Service Center. Along with this Statement, the Original Limited Warranty Statement and a dated Bill of Sale as Proof of Purchase must be presented to the Service Center. Transportation to and from the Service Center is the responsibility of the purchaser.

Conditions covered are limited only to manufacturing defects in material or workmanship, and only those encountered in normal use of the product.

Excluded, but not limited to, are any originally specified provisions for, in-home or on-site services, minimum or maximum repair times, exchanges or replacements, accessories, options, upgrades, or consumables.

For the location of a SAMSUNG Authorized Service Center, please call toll-free:

In the United States : 1-800-SAMSUNG (1-800-726-7864)

In Canada : 1-800-SAMSUNG

➤ See the warranty card for more information on warranty terms.

Precautions When Displaying a Still Image

A still image may cause permanent damage to the TV screen

- Do not display a still image on the LCD panel for more than 2 hours as it can cause screen image retention. This image retention is also known as "screen burn". To avoid such image retention, reduce the degree of brightness and contrast of the screen when displaying a still image.
-  Watching the LCD TV in 4:3 format for a long period of time may leave traces of borders displayed on the left, right and center of the screen caused by the difference of light emission on the screen. Playing a DVD or a game console may cause a similar effect to the screen. Damages caused by the above effect are not covered by the Warranty.
- Displaying still images from Video games and PC for longer than a certain period of time may produce partial after-images. To prevent this effect, reduce the 'brightness' and 'contrast' when displaying still images.

Contents

General Information

■ List of Features	3
■ Accessories	3
■ Viewing the Control Panel	4
■ Viewing the Connection Panel	5
■ Remote Control	7
■ Mini Remote Control	8
■ Installing Batteries in the Remote Control	8
■ Using the Remote Control Backlight Buttons	9

Connections

■ Connecting VHF and UHF Antennas	9
■ Connecting Cable TV	10
■ Connecting a DVD/Blu-Ray player or Cable Box/Satellite receiver (Set-Top Box) via HDMI	11
■ Connecting a DVD/Blu-Ray player or Cable Box/Satellite receiver (Set-Top Box) via DVI	11
■ Connecting a DVD/Blu-Ray player or Cable Box/Satellite receiver (Set-Top Box) via Component cables	12
■ Connecting a Camcorder	12
■ Connecting a VCR	13
■ Connecting a Digital Audio System	14
■ Connecting an Amplifier/DVD Home Theater	14
■ Connecting a PC	15

Operation

■ Turning the TV On and Off	16
■ Plug & Play Feature	16
■ Changing Channels	18
■ Adjusting the Volume	18
■ Viewing the Display	19
■ Viewing the Menus	19
■ Using the TOOLS Button	20
■ Memorizing the Channels	20
■ Setting Up Your Remote Control	22
■ Remote Control Codes	24
■ To Select the Source	27
■ To Edit the Input Source Name	27

Picture Control

■ Changing the Picture Standard	28
■ Customizing the Picture Settings	28
■ Adjusting the Detailed Settings	29
■ Resetting the Picture Settings to the Factory Defaults	32
■ Configuring Picture Options	33
■ Viewing Picture-in-Picture	38

Sound Control

■ Changing the Sound Standard	40
■ Customizing the Sound	40
■ Setting the TruSurround XT	41
■ Choosing Preferred Language	42
■ Choosing a Multi-Channel Sound (MTS) track	42
■ Automatic Volume Control	43
■ Selecting the Speaker	43
■ Listening to the Sound of the Sub (PIP) Picture	44
■ Resetting the Sound Settings to the Factory Defaults	45
■ Connecting Headphones (Sold separately)	45

Channel Control

■ Managing Channels	46
■ Clearing Scrambled Channels - Digital	53
■ Fine Tuning Analog Channels	53
■ Checking the Digital-Signal Strength	54

PC Display

■ Using Your TV as a Computer (PC) Display	55
■ Display Modes	55
■ Setting up the TV with your PC	56

Time Setting

■ Setting the Clock	58
---------------------	----

Function Description

■ Selecting a Menu Language	62
■ Using the V-Chip	62
■ Viewing Closed Captions (On-Screen Text Messages) - Analog	69
■ Viewing Closed Captions (On-Screen Text Messages) - Digital	70
■ Adjusting the TV On/Off Melody Sound	71
■ Setting the Light Effect	71
■ Setting the Entertainment mode	72
■ Using the Energy Saving Feature	72
■ Upgrading the Software	73
■ Self diagnosis	74

WISELINK Pro

■ Using the WISELINK Pro Function	75
■ Using the Photo List	77
■ Sorting Photo List	78
■ Viewing a Photo or Slide Show	83
■ Using the Music List	87
■ Sorting Music List	88
■ Playing a Music File	92
■ Using the Movie List	94
■ Sorting Movie List	95
■ Playing a Movie File	98
■ Picture/Music Settings Using WISELINK	100
■ Using the Setup Menu	100

WISELINK Pro-DLNA

■ Setting the DLNA Network	102
■ Installing the DLNA Application	103
■ Using the DLNA Application	104
■ Using the DLNA Function	109

Content Library

■ Using the Content Library	111
■ Using the TV Memory Contents	112
■ Using Additional Content Using External USB Memory Storage	117

Network Settings and InfoLink

■ Network Connection - Cable.....	118
■ Network Connection - Wireless	120
■ Network selection	120
■ Cable Network Setup.....	121
■ Wireless Network Setup	123
■ Using InfoLink.....	126
■ InfoLink Setup.....	129
■ Product Guide.....	130

About Anynet+

■ What is Anynet+?.....	131
■ Connecting Anynet+ Devices.....	131
■ Setting Up Anynet+	132
■ Scanning and Switching between Anynet+ Devices.....	133
■ Recording	134
■ Listening through a Receiver (Home theater).....	134
■ Troubleshooting for Anynet+	135

Appendix

■ Troubleshooting.....	136
■ Installing the Stand.....	138
■ Disconnecting the Stand.....	138
■ Auto Wall-Mount Adjustment (Sold separately)	139
■ Wall Mount Kit Specifications (VESA)	140
■ Using the Anti-Theft Kensington Lock	141
■ Securing the TV to the Wall.....	142
■ Specifications	143
■ Dimensions.....	144

Symbol



Press



Note



One-Touch Button

General Information

List of Features

- Adjustable picture settings that can be stored in the TV's memory.
- Automatic timer to turn the TV on and off.
- A special sleep timer.
- Excellent Digital Interface & Networking :
With a built-in HD digital tuner, non-subscription HD broadcasts can be viewed with no Cable Box/Satellite receiver (Set-Top Box) needed.
- You can view News, Weather, and Stock information over the network (SAMSUNG InfoLink's Service).
- You can listen to music files and view pictures on USB Mass Storage Class (MSC) devices.
- **HDMI/DVI connection of your PC to this TV.**
- Excellent Picture Quality
 - DNIe technology provides life-like clear images.
- SRS TruSurround XT
 - SRS TruSurround XT provides a virtual surround system.

Accessories

Please make sure the following items are included with your LCD TV. If any items are missing, contact your dealer.

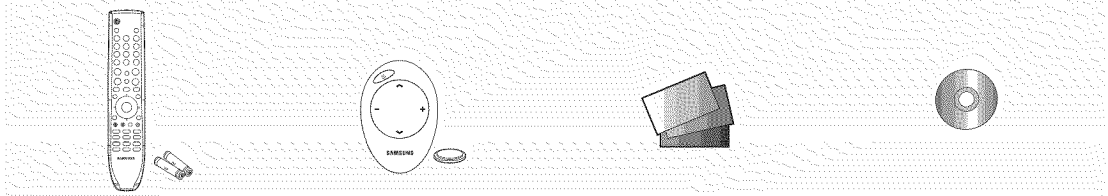

Remote Control & Batteries
(AAA x 2)
(BN59-00700A)

Mini Remote Control &
Lithium battery (3V x 1ea)
(BN59-00788B)

Warranty Card /
Registration Card /
Safety Guide Manual
(Not available in all locations)

Program CD
(BN59-00726A)

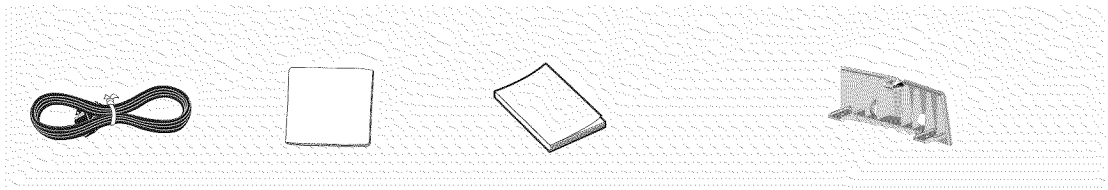

Power Cord
(3903-000144)

Cleaning Cloth
(BN63-01798B)

Owner's Instructions

Cover-Bottom
(LN46A850S1F, LN46A860S2F: BN63-04822B)
(LN52A850S1F, LN52A860S2F: BN63-04822B)

➤ The items color and shape may vary depending on the model.

Viewing the Control Panel

Buttons on the Lower-Right Part of the Panel

The buttons on the lower-right panel control your TV's basic features, including the on-screen menu. To use the more advanced features, you must use the remote control.

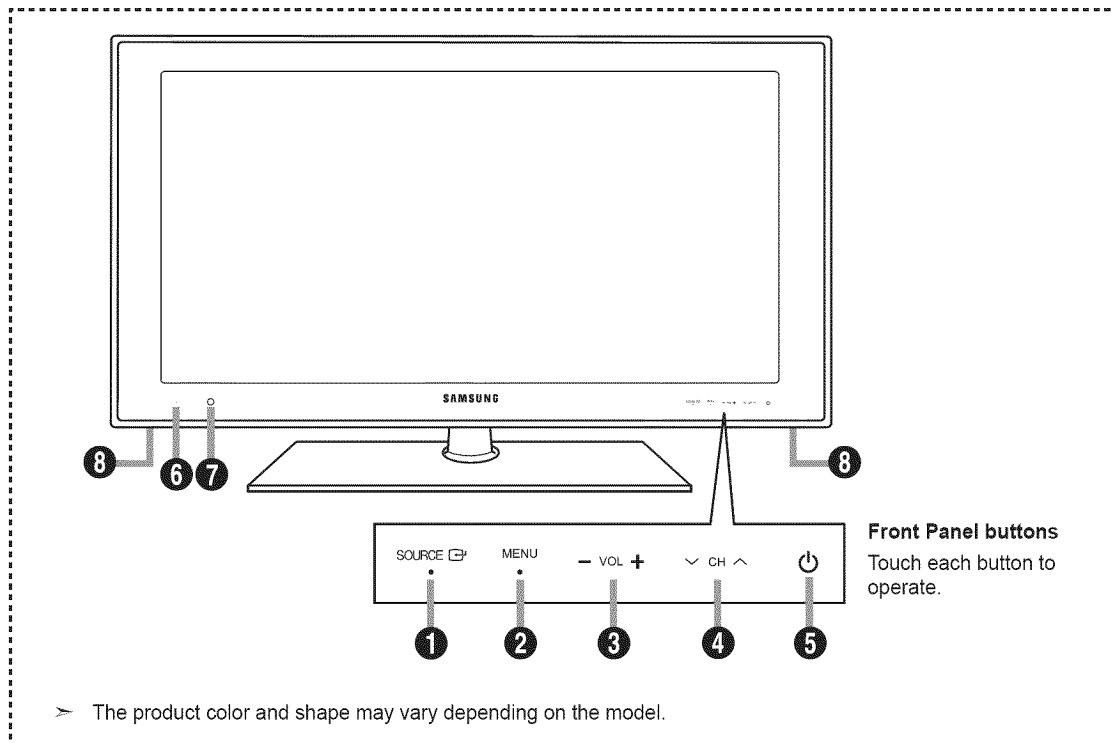

1 SOURCE

Toggles between all the available input sources (TV, AV1, AV2, S-Video, Component1, Component2, PC, HDMI1, HDMI2/DVI, HDMI3, HDMI4). In the on-screen menu, use this button as you would use the **ENTER**  button on the remote control.

2 MENU

Press to see an on-screen menu of your TV's features.

3 - VOL +

Press to increase or decrease the volume. In the on-screen menu, use the **- VOL +** buttons as you would use the **<** and **>** buttons on the remote control.

4 \vee CH \wedge

Press to change channels. In the on-screen menu, use the **\vee CH \wedge** buttons as you would use the **<** and **>** buttons on the remote control.

5 (Power)

Press to turn the TV on and off.

6 POWER INDICATOR

Blinks and turns off when the power is on and lights up in stand-by mode.

7 REMOTE CONTROL SENSOR

Aim the remote control towards this spot on the TV.

8 SPEAKERS

Viewing the Connection Panel

Use the connection panel jacks to connect A/V components that will be connected continuously, such as DVD/Blu-Ray players or a VCR. For more information on connecting equipment, see pages 9~15.

[LN46A850S1F, LN52A850S1F]

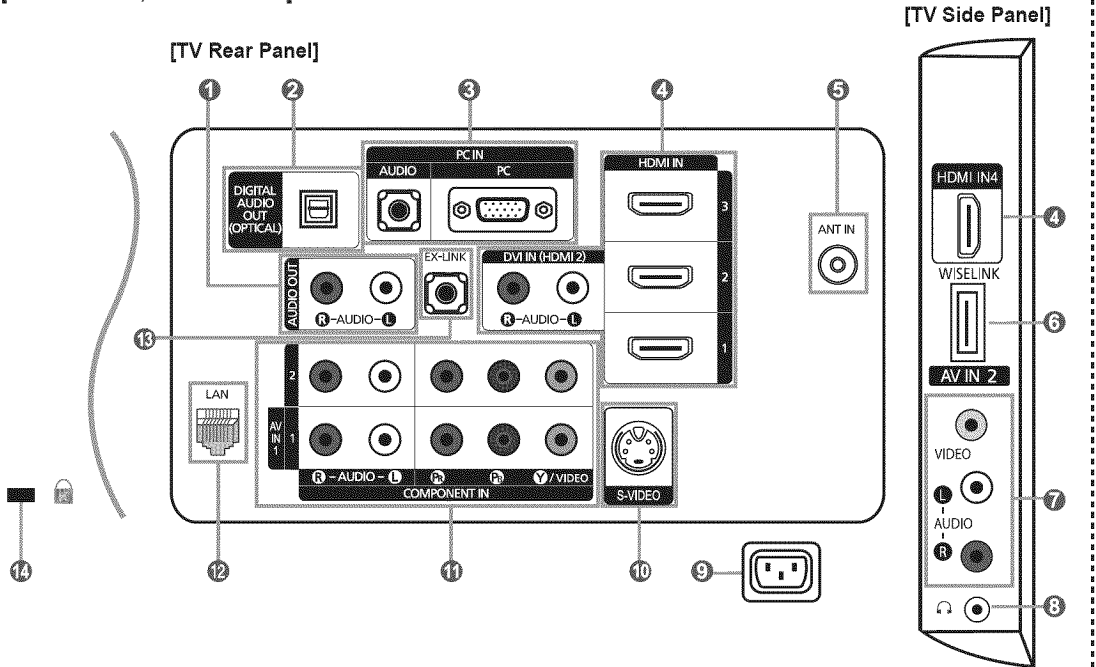

[LN46A860S2F, LN52A860S2F]

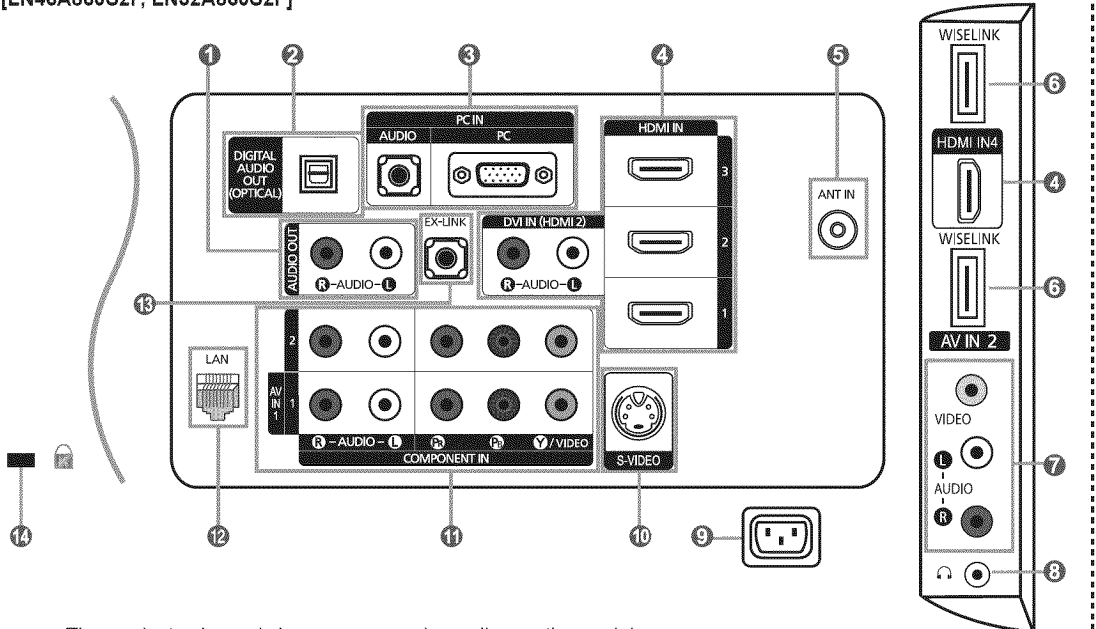







➤ The product color and shape may vary depending on the model.

- ❶ **AUDIO OUT**
Connects to the audio input jacks on your Amplifier/Home theater.
- ❷ **DIGITAL AUDIO OUT (OPTICAL)**
Connects to a Digital Audio component.
- ❸ **PC IN [PC] / [AUDIO]**
Connects to the video and audio output jacks on your PC.
- ❹ **HDMI IN 1, 2, 3, 4 / DVI IN(HDMI2)[R-AUDIO-L]**
Connects to the HDMI jack of a device with an HDMI output.
- No sound connection is needed for an HDMI to HDMI connection. Use the HDMI IN 2 jack for DVI connection to an external device. Use a DVI to HDMI cable or DVI-HDMI adapter (DVI to HDMI) for video connection and the DVI IN (HDMI2) [R-AUDIO-L] jacks for audio.
- When using an HDMI/DVI cable connection, you must use the HDMI IN 2 jack.
- ❺ **ANT IN**
Connects to an antenna or cable TV system.
- ❻ **WISELINK**
Connect a USB mass storage device to view movies and photos and listen to music files.
You can connect to Samsung's network wirelessly using the Wireless Infolink adapter (Sold separately).
- ❼ **AV IN 2**
Video and audio inputs for external devices, such as a camcorder or VCR.
- ❽  **(HEADPHONE)**
Connects a set of external headphones for private listening.
- ❾ **POWER INPUT**
Connects the supplied power cord.
- ❿ **S-VIDEO**
Connects an S-Video signal from a camcorder or VCR.
- Use the AV IN 1 [R-AUDIO-L] jacks for audio.
- ⓫ **COMPONENT IN 1, 2 / AV IN 1**
Connects Component video/audio. The COMPONENT IN 1 jack is also used as the AV IN 1 jack.
- Connect the video cable to the COMPONENT IN 1 [Y/VIDÉO] jack and the audio cable to the COMPONENT IN 1 [R-AUDIO-L] jacks.
- ⓬ **LAN**
Connect a LAN cable to this port to connect to the Network (SAMSUNG InfoLink's Service). (See pages 118~119)
- ⓭ **EX-LINK**
Connect this to the jack on the optional wall mount bracket. This will allow you to adjust the TV viewing angle using your remote control.
- ⓮ **KENSINGTON LOCK**
The Kensington Lock (optional) is a device used to physically fix the system when used in a public place. If you want to use a locking device, contact the dealer where you purchased the TV.
➤ The location of the Kensington Lock may be different depending on its model.

Remote Control

You can use the remote control up to a distance of about 23 feet from the TV. When using the remote, always point it directly at the TV. You can also use your remote control to operate your VCR, DVD/Blu-Ray player or Cable Box/Satellite receiver (Set-Top Box)

- 1 POWER**
Turns the TV on and off.
- 2 TV**
Selects the TV mode directly.
- 3 NUMERIC BUTTONS**
Press to directly select the channel.
- 4** 
Press to select additional channels (digital and analog) being broadcast by the same station. For example, to select channel "54-3", press "54", then press "" and "3".
- 5 (MUTE)**
Press to temporarily cut off the sound.
- 6 VOL - / VOL +**
Press to increase or decrease the volume.
- 7 CH LIST**
Used to display Channel Lists on the screen.
- 8 TOOLS**
Use to quickly select frequently used functions.
- 9 INFO**
Press to display information on the TV screen.
- 10 COLOR BUTTONS**
Use these buttons in the Channel list, WISELINK Pro, etc.
- 11 CC**
Controls the caption decoder.
- 12 E.MODE**
Press to select the preset display and sound modes for sports, cinema and games.
- 13** Use these buttons in the DMA, WISELINK Pro and Anynet+ modes.
(): This remote can be used to control recording on Samsung recorders with the Anynet+ feature)
- 14 SET**
Sets the remote to control your TV, VCR, DVD or Set-Top Box
- 15 MODE**
Press to operate your TV, DVD, STB or VCR (See pages 22~26)
- 16**  **ON/OFF**
Press to backlight the buttons on the remote. This function is convenient for using at night or when the room is dark. (Using the remote control with the  ON/OFF light button set to On will reduce the battery usage time.) (See page 9)
- 17 PRE-CH**
Tunes to the previous channel.
- 18 CH ∇ / CH ▲**
Press to change channels.
- 19 SOURCE**
Press to display and select the available video sources.
- 20 W.LINK (WISELINK Pro)**
This function enables you to view and play photo, music and movie files from an external device. (Refer to pages 77 (Photo), 87 (Music) and 94 (Movie))
- 21 MENU**
Displays the main on-screen menu.
- 22 RETURN**
Returns to the previous menu.
- 23 UP ▲ / DOWN ▼ / LEFT ◀ / RIGHT ▶ / ENTER** 
Press the Up/Down/Left/Right sections of the wheel button and Enter to select on-screen menu items and change menu values.
You can navigate up and down the menu, switch channels and adjust the volume by turning the wheel button. (See pages 18~19)
- 24 EXIT**
Press to exit the menu.
- 25 DMA (Digital Media Adapter)**
Use this when connecting a SAMSUNG DMA device through an HDMI interface and switching to DMA mode.
For more information on the operating procedures, refer to the user manual of the DMA. This button is available when "Anynet+(HDMI-CEC)" is "On". (see page 132)
- 26 INFO.L**
Press to use the News, Stock Market and Weather Forecast information services available over Samsung's network. (see page 126)
- 27 FAV.CH**
Press to switch to your favorite channels. (see page 48)
- 28 CONTENT**
This function enables you to view "Content Library". (see page 111)
- 29 RESET**
When your remote does not work, change the batteries and press the RESET button for 2-3 seconds before use.

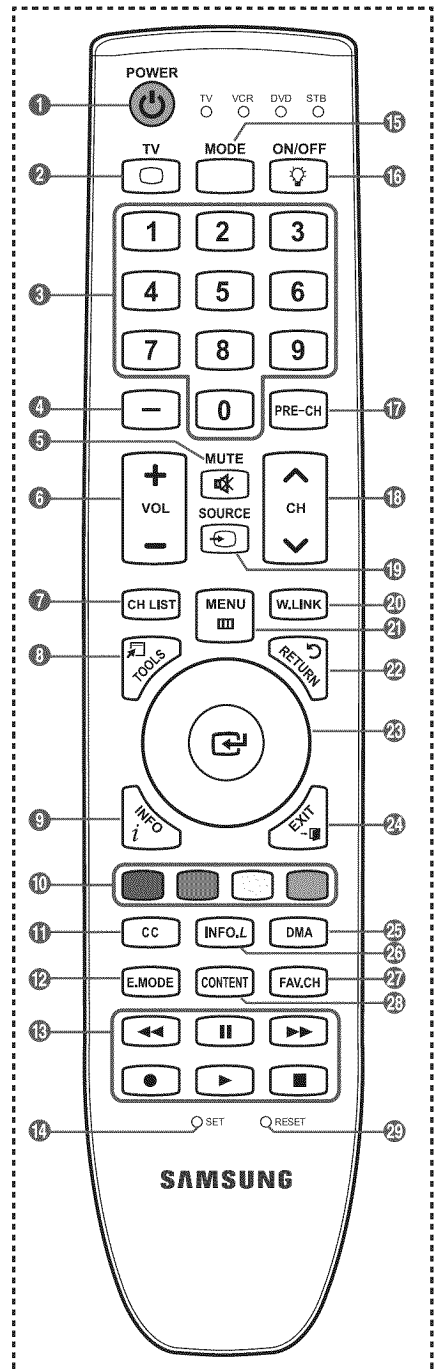

> The performance of the remote control may be affected by bright light.

Mini Remote Control

The Mini Remote Control is a simplified remote control that consists of the power, channel and volume buttons only.

1 Television Standby button

➤ This button only works when you press it for longer than 1.5 seconds.

- 2 ▼ : Next channel
 2 ▲ : Previous channel

- 3 + : Volume increase
 3 - : Volume decrease

4 IrDA transmitter

➤ Use the Mini Remote Control so that this part faces the TV.

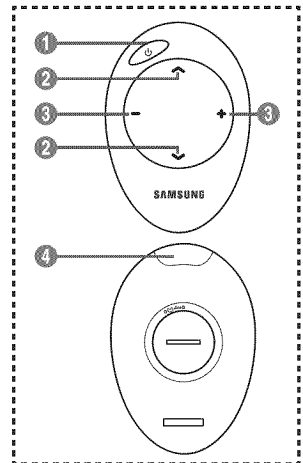

Installing Batteries in the Remote Control

Normal Remote Control

- Lift the cover at the back of the remote control upward as shown in the figure.
- Install two AAA size batteries.
 - Make sure to match the "+" and "-" ends of the batteries with the diagram inside the compartment.
- Replace the cover.
 - Remove the batteries and store them in a cool, dry place if you won't be using the remote control for a long time.

The remote control can be used up to about 23 feet from the TV.

(Assuming typical TV usage, the batteries should last for about one year.)

➤ Using the remote control with the ON/OFF light button set to On will reduce the battery usage time.

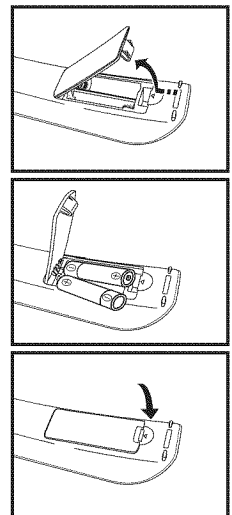

Mini Remote Control

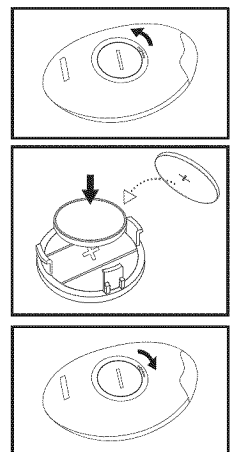

- Turn the battery cover counterclockwise to unlock it and then separate the battery cover.
- Insert the corresponding 3V Lithium battery.
- Place the battery cover into the remote control aligning it with the grooves and then turn the battery cover clockwise to lock the cover.

- If the remote control doesn't work, check the following:
- Is the TV power on?
 - Are the plus and minus ends of the batteries reversed?
 - Are the batteries drained?
 - Is there a power outage or is the power cord unplugged?
 - Is there a special fluorescent light or neon sign nearby?



Using the Remote Control Backlight Buttons

Use this feature in dark surroundings and when you are unable to see the remote control buttons clearly.

1. Press the  **ON/OFF** light button.
 - Pressing the  **ON/OFF** light button toggles between ON and OFF.
 - When ON, the button backlight is turned on for a moment.
 - Pressing a remote control button when the remote control is on turns the button backlight on for a moment. If you touch or move the remote control and the motion is detected by the sensor of the remote control, the button backlight will be turned on for a moment.
 - Since there is a vibrating device inside the remote control, shaking the remote control will result in a sound generated by the device.
 - The button backlight will not be turned on when the remote control is turned off.

Connections

Connecting VHF and UHF Antennas

If your antenna has a set of leads that look like the diagram to the right, see "Antennas with 300 Ω Flat Twin Leads" below.

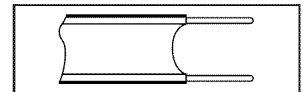

If your antenna has one lead that looks like the diagram to the right, see "Antennas with 75 Ω Round Leads".

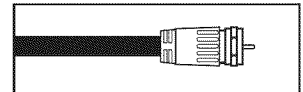

If you have two antennas, see "Separate VHF and UHF Antennas".

Antennas with 300 Ω Flat Twin Leads

If you are using an off-air antenna (such as a roof antenna or "rabbit ears") that has 300 Ω twin flat leads, follow the directions below.

1. Place the wires from the twin leads under the screws on a 300-75 Ω adapter (not supplied). Use a screwdriver to tighten the screws.
2. Plug the adaptor into the ANT IN terminal on the back of the TV.

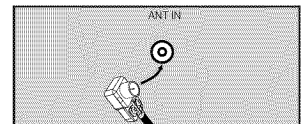
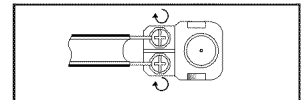

Antennas with 75 Ω Round Leads

1. Plug the antenna lead into the ANT IN terminal on the back of the TV.

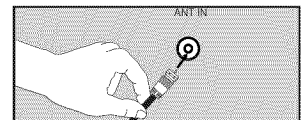

Separate VHF and UHF Antennas

If you have two separate antennas for your TV (one VHF and one UHF), you must combine the two antenna signals before connecting the antennas to the TV. This procedure requires an optional combiner-adaptor (available at most electronics shops).

1. Connect both antenna leads to the combiner.
2. Plug the combiner into the ANT IN terminal on the bottom of the rear panel.

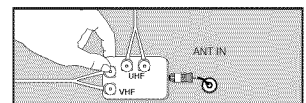
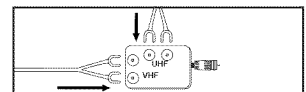

Connecting Cable TV

To connect to a cable TV system, follow the instructions below.

Cable without a Cable Box

1. Plug the incoming cable into the ANT IN terminal on the back of the TV.
 - > Because this TV is cable-ready, you do not need a cable box to view unscrambled cable channels.

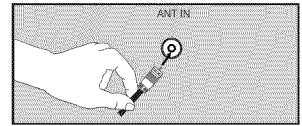

Connecting to a Cable Box that Descrambles All Channels

1. Find the cable that is connected to the ANT OUT terminal on your cable box.
 - > This terminal might be labeled "ANT OUT", "VHF OUT" or simply, "OUT".
2. Connect the other end of this cable to the ANT IN terminal on the back of the TV.

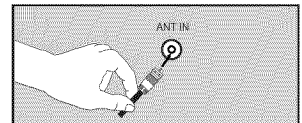
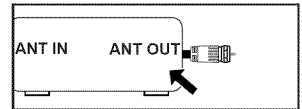

Connecting to a Cable Box that Descrambles Some Channels

If your cable box descrambles only some channels (such as premium channels), follow the instructions below. You will need a two-way splitter, an RF (A/B) switch and four lengths of RF cable. (These items are available at most electronics stores.)

1. Find and disconnect the cable that is connected to the ANT IN terminal on your cable box.
 - > This terminal might be labeled "ANT IN", "VHF IN" or simply, "IN".

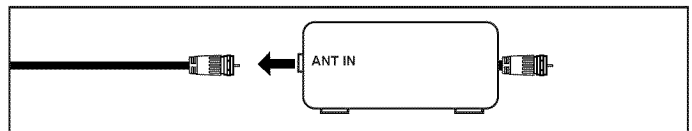

2. Connect this cable to a two-way splitter.

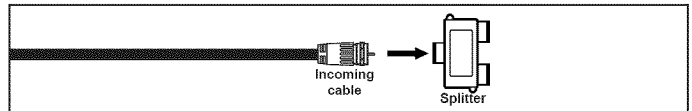

3. Connect an RF cable between the OUTPUT terminal on the splitter and the IN terminal on the cable box.

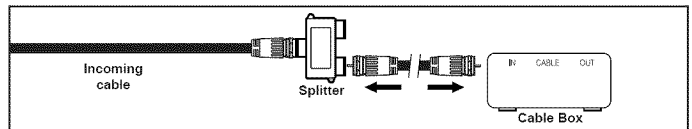

4. Connect an RF cable between the ANT OUT terminal on the cable box and the B-IN terminal on the RF (A/B) switch.

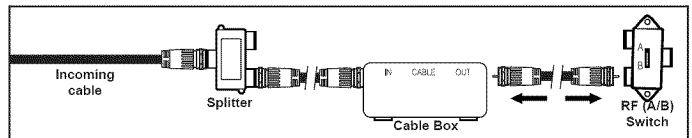

5. Connect another cable between the other OUT terminal on the splitter and the A-IN terminal on the RF (A/B) switch.

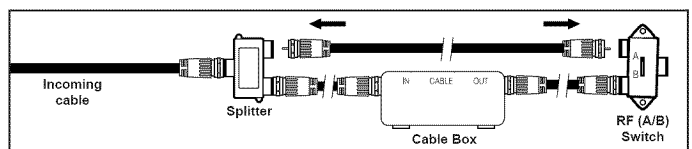

6. Connect the last RF cable between the OUT terminal on the RF (A/B) switch and the ANT IN terminal on the rear of the TV.

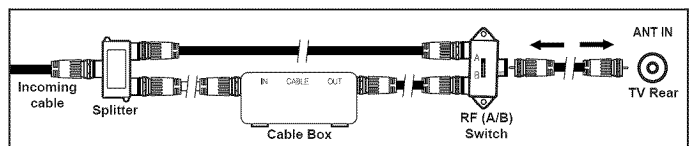

After you have made this connection, set the A/B switch to the "A" position for normal viewing. Set the A/B switch to the "B" position to view scrambled channels. (When you set the A/B switch to "B", you will need to tune your TV to the cable box's output channel, which is usually channel 3 or 4.)

Connecting a DVD/Blu-Ray player or Cable Box/Satellite receiver (Set-Top Box) via HDMI

This connection can only be made if there is an HDMI Output connector on the external device.

1. Connect an HDMI Cable between the HDMI IN (1, 2, 3 or 4) jack on the TV and the HDMI jack on the DVD/Blu-Ray player or Cable Box/Satellite receiver (Set-Top Box).

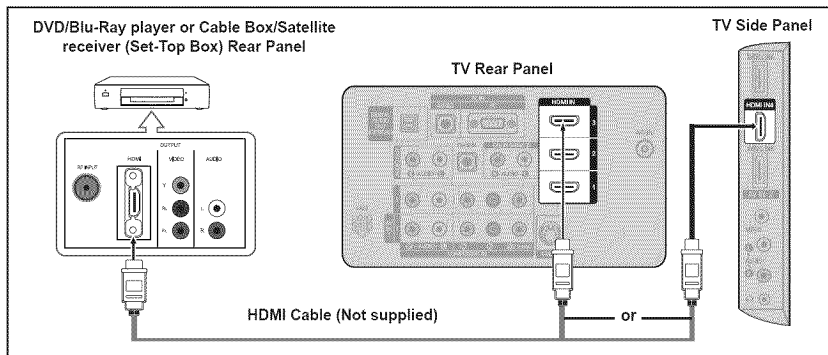

- What is HDMI?
 - HDMI(High-Definition Multimedia Interface), is an interface that enables the transmission of digital audio and video signals using a single cable.
 - The difference between HDMI and DVI is that the HDMI device is smaller in size and has the HDCP (High Bandwidth Digital Copy Protection) coding feature installed. DVI also requires a separate audio connection (see below).
- Each DVD/Blu-Ray player or Cable Box/Satellite receiver (Set-Top Box) has a different back panel configuration.
- The TV may not output sound and pictures may be displayed with abnormal color when DVD/Blu-Ray players/Cable Boxes/Satellite receivers supporting HDMI versions older than 1.3 are connected. When connecting an older HDMI cable and there is no sound, connect the HDMI cable to the HDMI IN 2 jack and the audio cables to the DVI IN (HDMI2) [R-AUDIO-L] jacks on the back of the TV. If this happens, contact the company that provided the DVD/Blu-Ray player/Cable Box/Satellite receiver to confirm the HDMI version, then request an upgrade.
- HDMI cables that are not 1.3 may cause annoying flicker or no screen display.

Connecting a DVD/Blu-Ray player or Cable Box/Satellite receiver (Set-Top Box) via DVI

This connection can only be made if there is a DVI Output connector on the external device.

1. Connect a DVI to HDMI Cable or DVI-HDMI Adapter between the HDMI IN 2 jack on the TV and the DVI jack on the DVD/Blu-Ray player or Cable Box/Satellite receiver (Set-Top Box).
2. Connect Audio Cables between the DVI IN (HDMI 2) [R-AUDIO-L] jack on the TV and the DVD/Blu-Ray player or Cable Box/Satellite receiver (Set-Top Box).

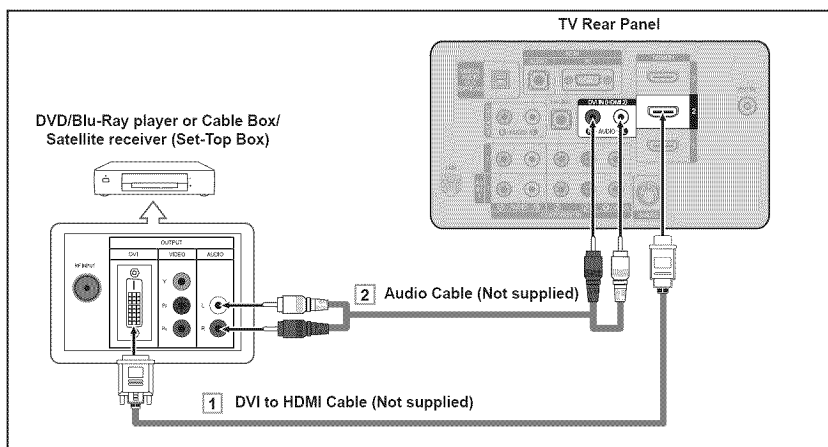

- Each DVD/Blu-Ray player or Cable Box/Satellite receiver (Set-Top Box) has a different back panel configuration.
- When connecting a DVD/Blu-Ray player or Cable Box/Satellite receiver (Set-Top Box), match the color of the connection terminal to the cable.
- When using an HDMI/DVI cable connection, you must use the HDMI IN 2 jack.

Connecting a DVD/Blu-Ray player or Cable Box/Satellite receiver (Set-Top Box) via Component cables

The rear panel jacks on your TV make it easy to connect a DVD/Blu-Ray player or Cable Box/Satellite receiver (Set-Top Box) to your TV.

1. Connect a Component Cable between the COMPONENT IN (1 or 2) [Y, Pb, Pr] jacks on the TV and the COMPONENT [Y, Pb, Pr] jacks on the DVD/Blu-Ray player or Cable Box/Satellite receiver (Set-Top Box).
2. Connect Audio Cables between the COMPONENT IN(1 or 2) [R-AUDIO-L] jacks on the TV and the AUDIO OUT jacks on the DVD/Blu-Ray player or Cable Box/Satellite receiver (Set-Top Box).

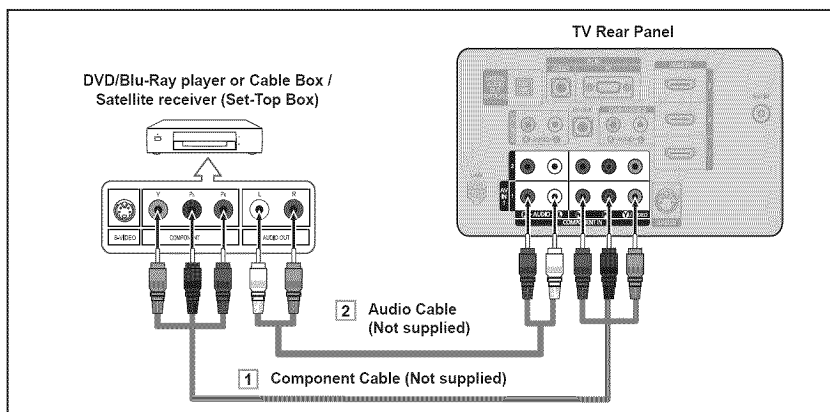

- Component video separates the video into Y (Luminance (brightness)), Pb (Blue) and Pr (Red) for enhanced video quality. Be sure to match the component video and audio connections. For example, if connecting a Component video cable to COMPONENT IN 1, connect the audio cable to COMPONENT IN 1 also.
- Each DVD/Blu-Ray player or Cable Box/Satellite receiver (Set-Top Box) has a different back panel configuration.
- When connecting a DVD/Blu-Ray player or Cable Box/Satellite receiver (Set-Top Box), match the color of the connection terminal to the cable.

Connecting a Camcorder

The side panel jacks on your TV make it easy to connect a camcorder to your TV. They allow you to view the camcorder tapes without using a VCR.

1. Connect a Video Cable between the AV IN 2 [VIDEO] jack on the TV and the VIDEO OUT jack on the camcorder.
2. Connect Audio Cables between the AV IN 2 [R-AUDIO-L] jacks on the TV and the AUDIO OUT jacks on the camcorder.

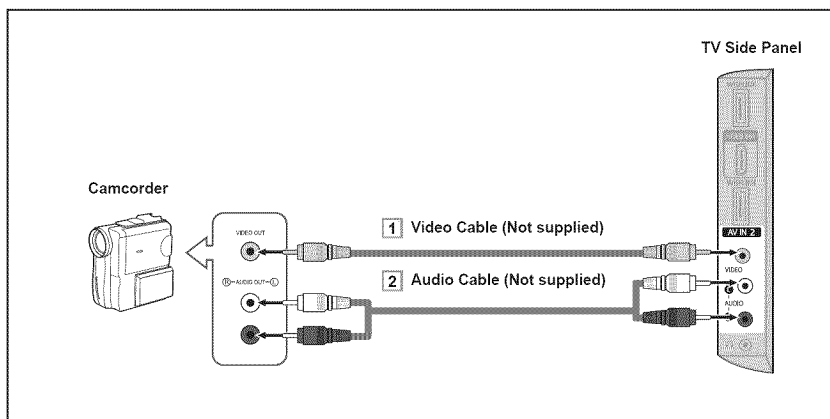

- Each Camcorder has a different back panel configuration.
- When connecting a Camcorder, match the color of the connection terminal to the cable.

Connecting a VCR

Video Connection

These instructions assume that you have already connected your TV to an antenna or a cable TV system (according to the instructions on pages 9-10). Skip step 1 if you have not yet connected to an antenna or a cable system.

1. Unplug the cable or antenna from the back of the TV.
2. Connect the cable or antenna to the ANT IN terminal on the back of the VCR.
3. Connect an RF Cable between the ANT OUT terminal on the VCR and the ANT IN terminal on the TV.
4. Connect a Video Cable between the VIDEO OUT jack on the VCR and the AV IN 1 [Y/VIDEO] or AV IN 2 [VIDEO] jack on the TV.
5. Connect Audio Cables between the AUDIO OUT jacks on the VCR and the AV IN 1 (or AV IN 2) [R-AUDIO-L] jacks on the TV.

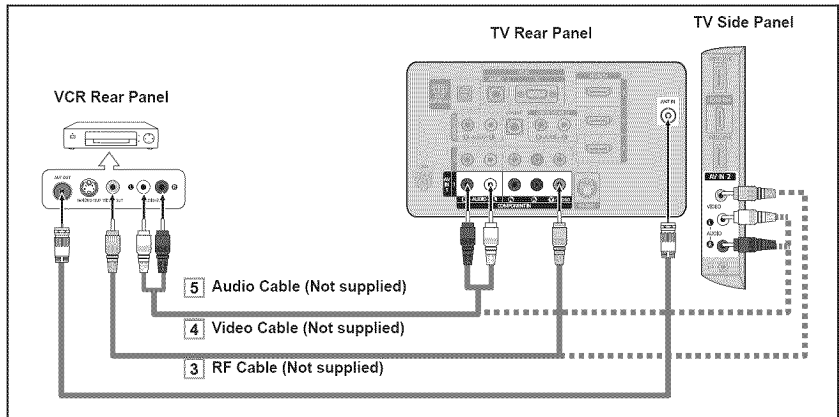
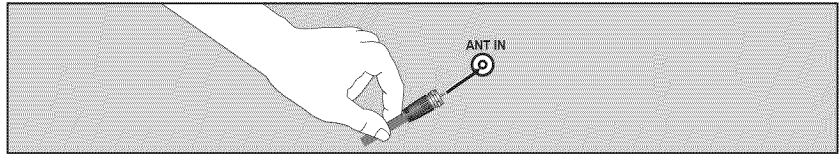

Follow the instructions in "Viewing a VCR or Camcorder Tape" to view your VCR tape.

- > Each VCR has a different back panel configuration.
- > When connecting a VCR, match the color of the connection terminal to the cable.
- > When connecting to AV IN 1, the color of the AV IN 1 [Y/VIDEO] jack (Green) does not match the color of the video cable (Yellow).
- > If you have a "mono" (non-stereo) VCR, use a Y-connector (not supplied) to connect to the right and left audio input jacks of the TV. Alternatively, connect the cable to the "R" jack. If your VCR is stereo, you must connect two cables.

S-Video Connection

Your Samsung TV can be connected to an S-Video jack on a VCR. (This connection delivers a better picture as compared to a standard VCR.)

1. To begin, follow steps 1-3 in the previous section to connect the antenna or cable to your VCR and your TV.
2. Connect an S-Video Cable between the S-VIDEO OUT jack on the VCR and the [S-VIDEO] jack on the TV.
3. Connect Audio Cables between the AUDIO OUT jacks on the VCR and the AV IN 1 [R-AUDIO-L] jacks on the TV.

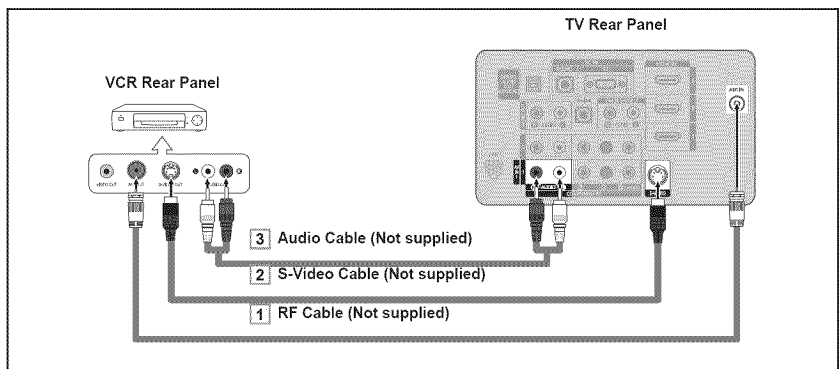

An S-Video cable may be included with a VCR. (If not, check your local electronics store.)

- > Each VCR has a different back panel configuration.
- > When connecting a VCR, match the color of the connection terminal to the cable.

Connecting a Digital Audio System

The rear panel jacks on your TV make it easy to connect a Digital Audio System (Home theater/Receiver) to your TV.

1. Connect an Optical Cable between the "DIGITAL AUDIO OUT (OPTICAL)" jacks on the TV and the Digital Audio Input jacks on the Digital Audio System.

When a Digital Audio System is connected to the "DIGITAL AUDIO OUT (OPTICAL)" jack: Decrease the volume of the TV and adjust the volume level with the system's volume control.

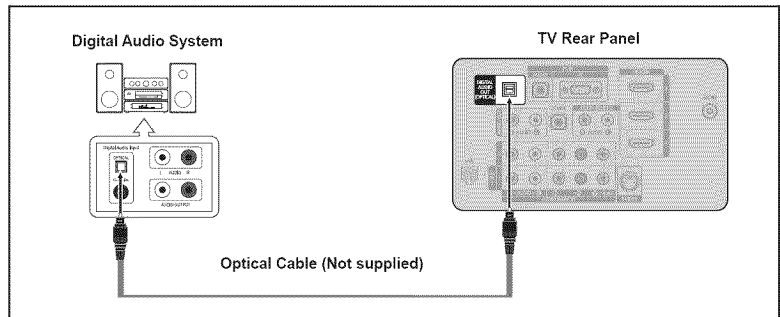

- 5.1CH audio is possible when the TV is connected to an external device supporting 5.1CH.
- Each Digital Audio System has a different back panel configuration.
- When the receiver (home theater) is set to On, you can hear sound output from the TV's Optical jack. When the TV is displaying a DTV(air) signal, the TV will send out 5.1 channel sound to the Home theater receiver. When the source is a digital component such as a DVD and is connected to the TV via HDMI, only 2 channel sound will be heard from the Home Theater receiver. If you want to hear 5.1 channel audio, connect the DIGITAL AUDIO OUT (OPTICAL) jack on the DVD/Blu-Ray player or Cable/Satellite Box directly to an Amplifier or Home Theater, not the TV.

Connecting an Amplifier/DVD Home Theater

1. Connect Audio Cables between the AUDIO OUT [R-AUDIO-L] jacks on the TV and AUDIO IN [R-AUDIO-L] jacks on the Amplifier/DVD Home Theater.

When an audio amplifier is connected to the "AUDIO OUT [R-AUDIO-L]" jacks: Decrease the volume of the TV and adjust the volume level with the Amplifier's volume control.

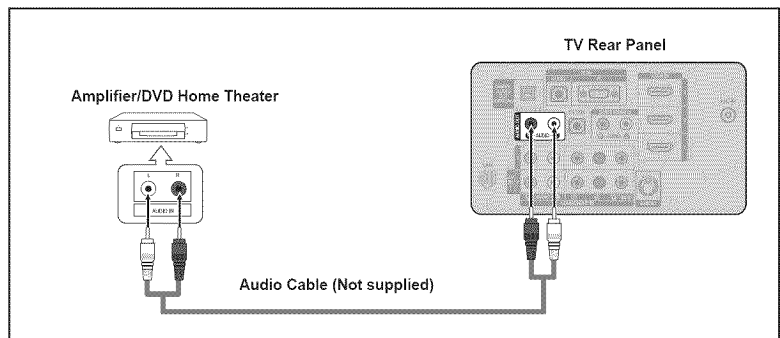

- Each Amplifier/DVD Home Theater has a different back panel configuration.
- When connecting an Amplifier/DVD Home Theater, match the color of the connection terminal to the cable.

Connecting a PC

Using the D-Sub Cable

1. Connect a D-Sub Cable between PC IN [PC] connector on the TV and the PC output connector on your computer.
2. Connect a PC Audio Cable between the PC IN [AUDIO] jack on the TV and the Audio Out jack of the sound card on your computer.

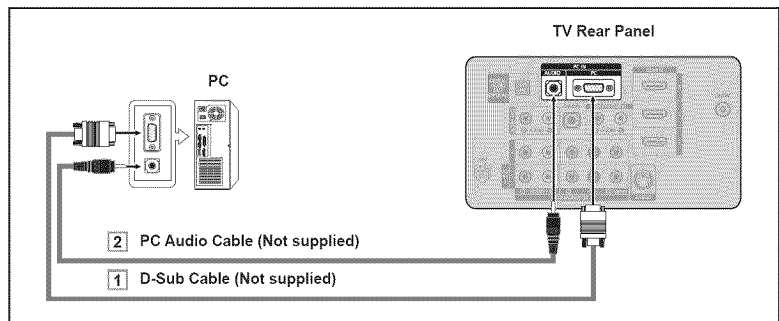

Using the HDMI/DVI Cable

1. Connect an HDMI/DVI cable between the HDMI IN 2 jack on the TV and the PC output jack on your computer.
2. Connect a 3.5 mm Stereo mini-plug/2RCA Cable between the DVI IN(HDMI2) [R-AUDIO-L] jack on the TV and the Audio Out jack of the sound card on your computer.

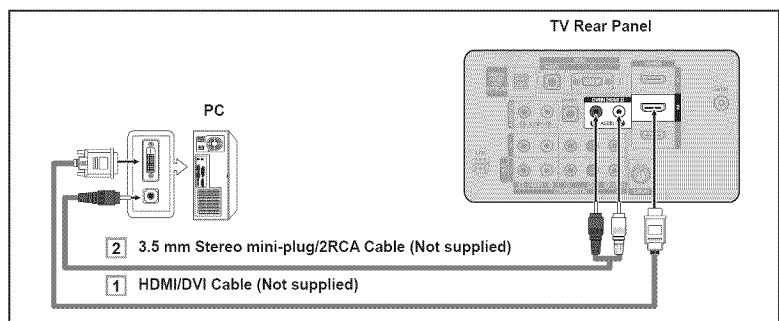

- Each PC has a different back panel configuration.
- When connecting a PC, match the color of the connection terminal to the cable.
- When using an HDMI/DVI cable connection, you must use the HDMI IN 2 terminal.

Operation

Turning the TV On and Off

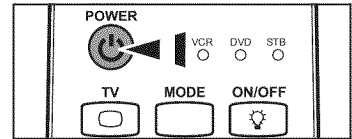

Press the **POWER**  button on the remote control.
You can also use the **POWER**  button on the TV.





Plug & Play Feature



When the TV is initially powered on, basic settings proceed automatically and subsequently.

1. Press the **POWER** button on the remote control.
The message "Menu Language, Store Demo, Channels and Time will be set." is displayed.

Press the **ENTER**  button, then "Select Language of the OSD." menu is automatically displayed. Press the **ENTER**  button.

2. Press the **▲** or **▼** button to select language, then press the **ENTER**  button.
The message "Select 'Home Use' when installing this TV in your home." is displayed.

3. Press the **◀** or **▶** button to select "Store Demo" or "Home Use", then press the **ENTER**  button. The message "Select the Antenna source to memorize." is displayed.
 - > We recommend setting the TV to "Home Use" mode for the best picture in your home environment.
 - > "Store Demo" mode is only intended for use in retail environments.
 - > If the unit is accidentally set to "Store Demo" mode and you want to return to "Home Use" (Standard): Press the Volume button on the TV. When the volume OSD is displayed, press and hold the **MENU** button on the TV for 5 seconds.

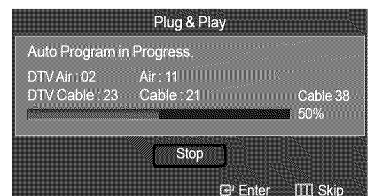
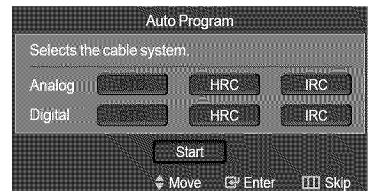
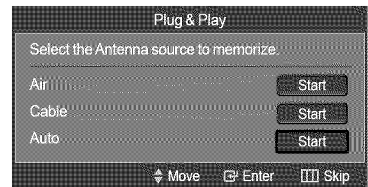

4. Press the **▲** or **▼** button to memorize the channels of the selected connection. Press the **ENTER**  button to select "Start".
 - > Air: "Air" antenna signal.
 - > Cable: "Cable" antenna signal.
 - > Auto: "Air" and "Cable" antenna signals.
 - > In Cable mode, you can select the correct signal source among STD, HRC, and IRC by pressing the **▲**, **▼**, **◀** or **▶** button, then press the **ENTER**  button. If you have Digital cable, select the cable system signal source for both Analog and Digital. Contact your local cable company to identify the type of cable system that exists in your particular area.



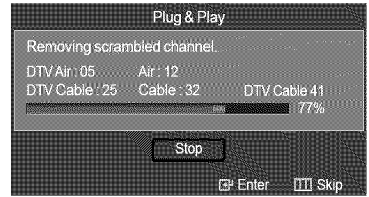

5. The TV will begin memorizing all of the available channels.
 - To stop the search before it has finished, press the **ENTER**  button with "Stop" selected.

After all the available channels are stored, it starts to remove scrambled channels (see page 53). And then, the Auto program menu reappears. Press the **ENTER**  button when channel memorization is complete. The message "Set the Clock Mode." is displayed.

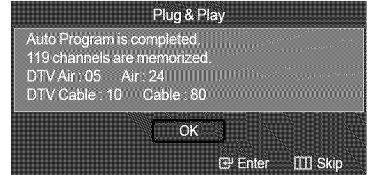

6. Press the **ENTER**  button. Press the **▲** or **▼** button to select "Auto", then Press the **ENTER**  button. The message "Set to daylight saving time." is displayed. If you select "Manual", "Set current date and time" is displayed. (See page 58)



7. Press the **▲** or **▼** button to select "Off", "On" or "Auto", then press the **ENTER**  button. The message "Select the time zone in which you live." is displayed.

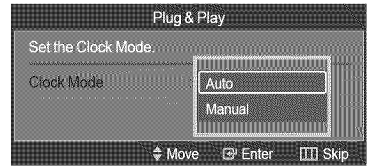

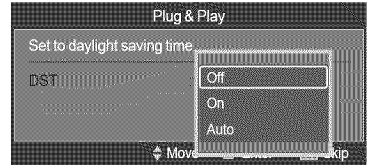

8. Press the **▲** or **▼** button to highlight the time zone for your local area. Press the **ENTER**  button. If you have received a digital signal, the time will be set automatically. If not, see page 58 to set the clock.

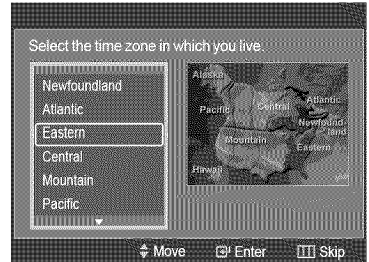

9. The message "Enjoy your watching." is displayed. When you have finished, press the **ENTER**  button.



If you want to reset this feature...

1. Press the **MENU** button to display the menu. Press the **▲** or **▼** button to select "Setup", then press the **ENTER**  button.
2. Press the **ENTER**  button again to select "Plug & Play". For further details on setting up options, refer to the pages 16~17.
 - The "Plug & Play" feature is only available in the TV mode.



Changing Channels

Using the Channel Buttons

1. Press the **CH** ∇ or **CH** \blacktriangle button to change channels.
 - When you press the **CH** ∇ or **CH** \blacktriangle button, the TV changes channels in sequence. You will see all the channels that the TV has memorized. (The TV must have memorized at least three channels). You will not see channels that were either erased or not memorized. See page 20 to memorize channels.
 - To increase the channel number, turn the wheel clockwise when the Channel Display is displayed. To decrease the channel number, turn the wheel counterclockwise.

Using the Number Buttons

1. Press the number buttons to go directly to a channel. For example, to select channel 27, press **2**, then **7**.
 - For quick channel change, press the number buttons, then press the **ENTER** \square button.

Using the \square Button

The \square button is used to select stations that broadcast a digital signal.

1. For example, for Channel 7-1, press **7**, then \square , then **1**.
 - HD indicates the TV is receiving a Digital High Definition signal.
 - SD indicates the TV is receiving a Standard Definition signal.
 - For quick channel change, press the number buttons, then press the **ENTER** \square button.

Using the PRE-CH Button to select the Previous Channel

1. Press the **PRE-CH** button. The TV will switch to the last channel viewed.
 - To quickly switch between two channels that are far apart, tune to one channel, then use the number button to select the second channel. Then use the **PRE-CH** button to quickly alternate between them.

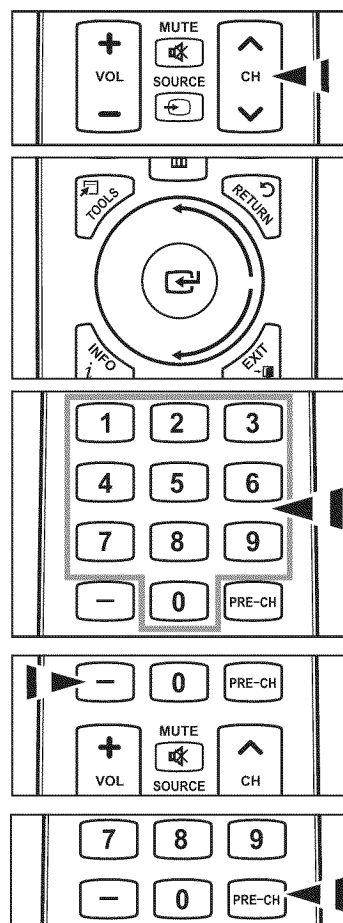

Adjusting the Volume

Using the Volume Button

1. Press the **VOL** $-$ or **VOL** $+$ button to increase or decrease the volume.
 - To turn the volume up, turn the wheel clockwise when the Volume Control window is displayed. To turn the volume down, turn the wheel counterclockwise.

Using the MUTE button

At any time, you can cut off the sound using the **MUTE** button.

1. Press **MUTE** button and the sound cuts off. "M" is displayed on the screen.
2. To turn mute off, press the **MUTE** button again or simply press the **VOL** $-$ or **VOL** $+$ button.

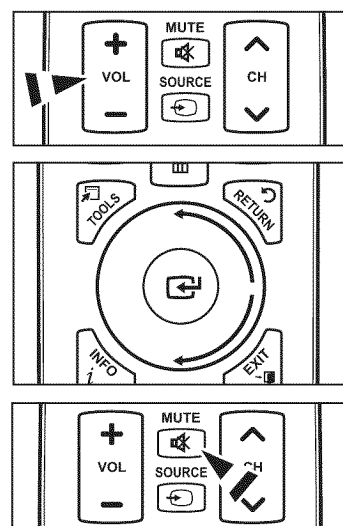

Viewing the Display

The display identifies the current channel and the status of certain audio-video settings.

1. Press the **INFO** button on the remote control.
The TV will display the channel, the type of sound, and the status of certain picture and sound settings.
 - Press the **INFO** button once more or wait approximately 10 seconds and the display disappears automatically.

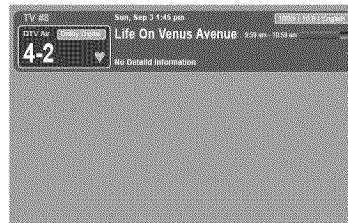
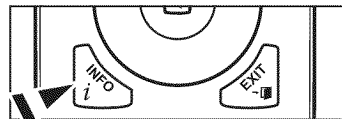

Viewing the Menus

1. With the power on, press the **MENU** button.
The main menu appears on the screen.
The menu's left side has icons: Picture, Sound, Channel, Setup, Input, Application.
 - To move to a lower menu, turn the wheel clockwise when the menu Display is displayed. To move to a higher menu, turn the wheel counterclockwise.
2. Press the **▲** or **▼** button to select one of the icons.
Then press the **ENTER** button to access the icon's sub-menu.
 - To move to a lower menu, turn the wheel clockwise when the menu Display is displayed. To move to a higher menu, turn the wheel counterclockwise.
3. Press the **EXIT** button to exit.
 - The on-screen menus disappear from the screen after about one minute.

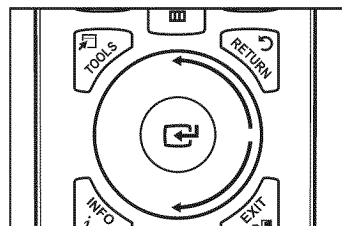
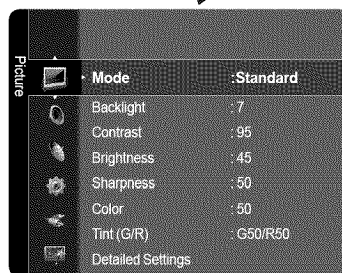
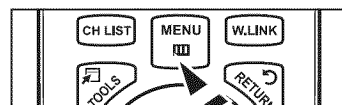

Using the TOOLS Button

You can use the **TOOLS** button to select your frequently used functions quickly and easily. The "Tools" menu changes depending on which external input mode you are viewing.

1. Press the **TOOLS** button. The "Tools" menu will appear.
2. Press the **▲** or **▼** button to select a menu.
3. Press the **▲/▼/◀/▶/ENTER**  buttons to display, change, or use the selected items. For a more detailed description of each function, refer to the corresponding page.

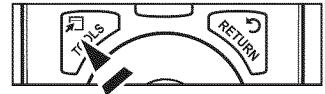

- Anynet+ (HDMI-CEC): see page 132
- Multi-Track Sound: see page 42
- Picture Size: see page 33
- Picture Mode: see page 28
- Sound Mode: see page 40
- Sleep Timer: see page 60
- Add to Favorite: see page 48
- Switch to Cable (or Switch to Air): see page 20
- PIP: see page 39
- Auto Adjustment: see page 56

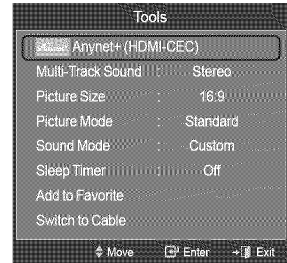



Memorizing the Channels

Your TV can memorize and store all of the available channels for both "off-air" (Air) and "Cable" channels. After the available channels are memorized, use the **CH ▼** or **CH ▲** button to scan through the channels. This eliminates the need to change channels by entering the channel digits. There are three steps for memorizing channels: selecting a broadcast source, memorizing the channels (automatic) and adding or deleting channels (Channel Lists).

Selecting the Video Signal-source

Before your television can begin memorizing the available channels, you must specify the type of signal source that is connected to the TV (i.e. an Air or a Cable system).

1. Press the **MENU** button to display the menu. Press the **▲** or **▼** button to select "Channel", then press the **ENTER**  button.
2. Press the **ENTER**  button to select "Antenna". Press the **▲** or **▼** button to select "Air" or "Cable", then press the **ENTER**  button. Press the **EXIT** button to exit.

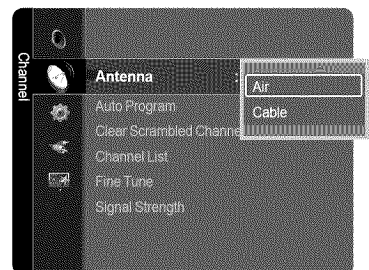
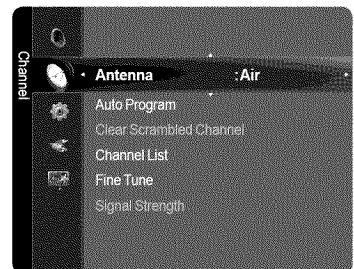

Easy Setting

1. Press the **TOOLS** button on the remote control.
2. Press the **▲** or **▼** button to select "Switch to Cable (or Switch to Air)".
3. Press the **ENTER**  button to switch "Cable" (or "Air").

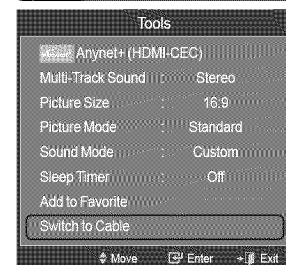

Storing Channels in Memory (Automatic Method)

- Press the **MENU** button to display the menu. Press the **▲** or **▼** button to select "Channel", then press the **ENTER** button.
- Press the **▲** or **▼** button to select "Auto Program", then press the **ENTER** button.
- Press the **▲** or **▼** button to select the antenna connection, then press the **ENTER** button.
 - Air: "Air" antenna signal.
Cable: "Cable" antenna signal.
Auto: "Air" and "Cable" antenna signals.
- When selecting the Cable TV system: Press the **ENTER** button to start the auto program. Press the **▲**, **▼**, **◀** or **▶** to select the correct analog signal cable system among "STD", "HRC", and "IRC". Press the **▲** or **▼** button to select "Start", then press the **ENTER** button. If you have Digital cable TV, select the cable system signal source for both Analog and Digital.
 - STD, HRC and IRC identify various types of cable TV systems. Contact your local cable company to identify the type of cable system that exists in your particular area. At this point the signal source has been selected.
- The TV begins memorizing all available stations.
 - After all the available channels are stored, it starts to remove scrambled channels (see page 53). The Auto program menu then reappears.
 - If you want to stop Auto Programming, press the **ENTER** button. The "Stop Auto Program?" message will be displayed. Select "Yes" by pressing the **◀** or **▶** button, then press the **ENTER** button.

Press the **EXIT** button to exit.

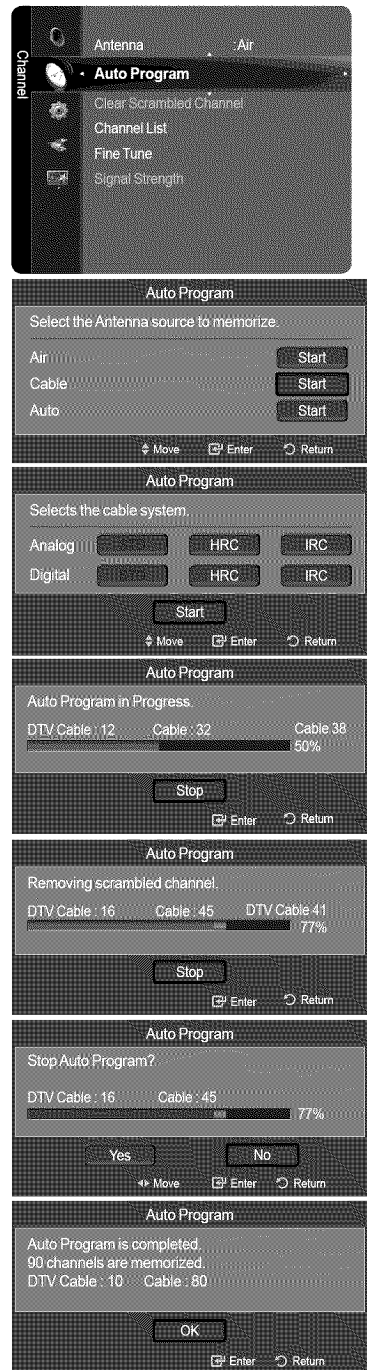

Setting Up Your Remote Control

After the television has been set up properly, your remote control can operate in different modes: TV, VCR, DVD, Set-Top Box. Pressing the corresponding button on the remote control allows you to switch between these modes and control whichever piece of equipment you choose.

- > The remote control might not be compatible with all DVD Players, VCRs, and Set-Top Boxes.

Setting Up the Remote to Operate Your VCR

1. Turn off your VCR.
2. Press the **MODE** button and make sure that the VCR LED is illuminated.
3. Press the **SET** button on your TV's remote control.
4. Using the number buttons on your remote control, enter three digits of the VCR code listed on page 24 of this manual for your brand of VCR. Make sure you enter three digits of the code, even if the first digit is a "0". (If more than one code is listed, try the first one.)
5. Press the **POWER** button on the remote control. Your VCR should turn on if your remote is set up correctly.

If your VCR does not turn on after set up, repeat steps 2, 3 and 4, but try one of the other codes listed for your brand of VCR.
If no other codes are listed, try each VCR code, 000 through 080.

- > Note on Using Remote Control Modes: VCR
When your remote control is in VCR mode, the volume buttons still control your TV's volume.

Setting Up the Remote to Operate Your DVD

1. Turn off your DVD.
2. Press the **MODE** button and make sure that the DVD LED is illuminated.
3. Press the **SET** button on your TV's remote control.
4. Using the number buttons on your remote control, enter three digits of the DVD code listed on pages 25 of this manual for your brand of DVD. Make sure you enter three digits of the code, even if the first digit is a "0". (If there is more than one code listed, try the first one.)
5. Press the **POWER** button on the remote control. Your DVD should turn on if your remote is set up correctly.

If your DVD does not turn on after set up, repeat steps 2, 3 and 4, but try one of the other codes listed for your brand of DVD.
If no other codes are listed, try each code, 000 through 141.

- > Note on Using Remote Control Modes: DVD
When your remote control is in DVD mode, the volume buttons still control your TV's volume.

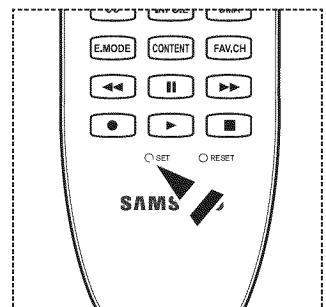
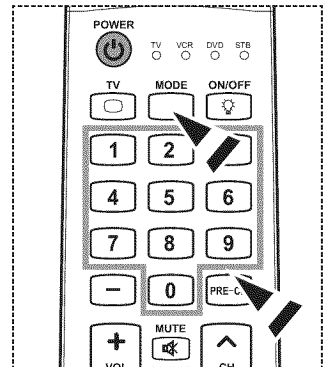
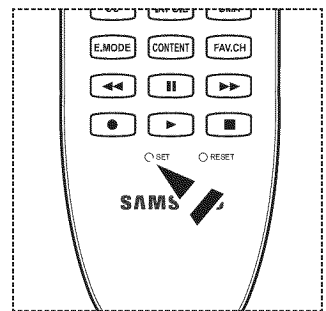
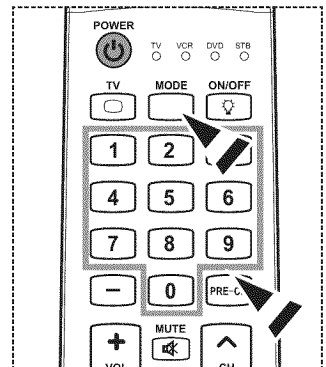

Setting Up the Remote to Operate Your STB

1. Turn off your STB.
2. Press the **MODE** button and make sure that the STB LED is illuminated.
3. Press the **SET** button on your TV's remote control.
4. Using the number buttons on your remote control, enter three digits of the STB code listed on page 26 of this manual for your brand of STB. Make sure you enter three digits of the code, even if the first digit is a "0". (If there is more than one code listed, try the first one.)
5. Press the **POWER** button on the remote control. Your STB should turn on if your remote is set up correctly.

If your STB does not turn on after set-up, repeat steps 2, 3 and 4, but try one of the other codes listed for your brand of STB. (If no other codes are listed, try each code, 000 through 074.)

- Note on Using Remote Control Modes: STB
When your remote control is in STB mode, the volume buttons still control your TV's volume.

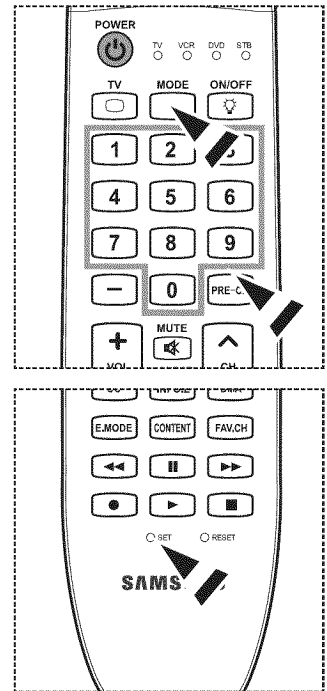

Setting Up the Remote to Operate Your Cable Box

1. Turn off your Cable Box.
2. Press the **MODE** button and make sure that the STB LED is illuminated.
3. Press the **SET** button on your TV's remote control.
4. Using the number buttons on your remote control, enter three digits of the cable box code listed on page 26 of this manual for your brand of cable box. Make sure you enter three digits of the code, even if the first digit is a "0". (If there is more than one code listed, try the first one.)
5. Press the **POWER** button on the remote control. Your cable box should turn on if your remote is set up correctly.

If your cable box does not turn on after set up, repeat steps 2, 3 and 4, but try one of the other codes listed for your brand of cable box. If no other codes are listed, try each code, 000 through 046.

- Note on Using Remote Control Modes: STB
When your remote control is in STB mode, the volume buttons still control your TV's volume.

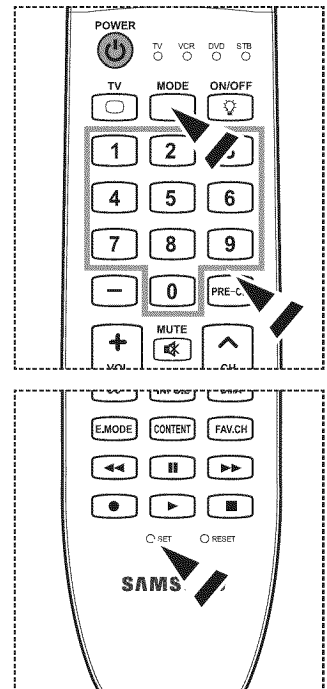

Remote Control Codes

> VCR

Brand	Code
SAMSUNG	000 001 002 003 004 005 077 078 079
ADMIRAL	020
AIWA	025
AKAI	004 027 032
AUDIO DYNAMICS	007 026
BELL&HOWELL	018
BROKSONIC	022
CANDLE	002 003 006 008 015 055
CANON	021 056
CITIZEN	002 003 006 008 015 055
COLORTYME	007
CRAIG	002 024
CURTIS MATHES	002 007 008 017 021 025 056 064 066
DAEWOO	003 010 011 012 013 014 015 016
DB	007 026
DIMENSIA	017
DYNATECH	025
ELECTROHOME	034
EMERSON	001 003 006 021 022 025 030 032 034 040 047 050 052 060 063 065 066 067 069 073
FISHER	018 024 028 029 048 051 061
FUNAI	025
GENERAL ELECTRIC	002 005 017 021 056
GO VIDEO	002
HARMAN KARDON	007
HITACHI	019 025 041 042 074
INSTANT REPLAY	021
JC PENNEY	002 007 018 019 021 026 037 041 054 056
JCL	007 008 018 021 026 037
JVC	081 082 083
KENWOOD	007 008 018 026 037
KLH	070
KONIA	036
LG(Goldstar)	006 007 008 009 010
LLOYD	025
LOGIK	038
LXI	025
MAGNAVOX	021 056 059
MARANTZ	007 008 018 021 026 037 062
MARTA	006
MEI	021
MEMOREX	006 021 024 025
MGA	034
MIDLAND	005
MINOLTA	019 041 075
MITSUBISHI	019 034 041 046

Brand	Code
MONTGOMERY WARD	020
MTC	002 025
MULTITECH	002 005 025 038
NEC	007 008 018 026 037 062 064
OPTIMUS	020
ORION	073 074 075 076
PANASONIC	021 056 071 072
PENTAX	019 041 075
PENTEX RESEARCH+	008
PHILCO	021 056 059
PHILIPS	021 080
PIONEER	019 026 039 053
PORTLAND	015 049 055
PROSCAN	017
QUARTZ	018
QUASAR	021 056
RADIO SHACK/ REALISTIC	006 018 020 021 024 025 029 034 048 056
RCA	002 017 019 021 035 041 043 057 068 076
SANSUI	026
SANYO	018 024
SCOTT	003 047 052 067
SEARS	006 018 019 024 028 029 041 048 051
SHARP	020 034 045 015
SHIMTOM	027 033 038 058
SIGNATURE	025
SONY	027 033 044
SYLVANIA	021 025 056 059
SYMPHONIC	025
TANDY	018 025
TASHIKA	006
TATUNG	037
TEAC	025 037 068
TECHNICS	021
TEKNIKA	006 021 025 031
TMK	066
TOSHIBA	003 019 029 051 052
TOTEVISION	002 006
UNITECH	002
VECTOR RESEARCH	007 026
VICTOR	026
VIDEO CONCEPTS	007 026
VIDEOSONIC	002
WARDS	002 003 006 019 020 021 024 025 034 038 041
YAMAHA	007 008 018 026 037
ZENITH	023 027 033

➤ **SAMSUNG DVD**

Product	Code
DVD	000 001 002 022
DVDR	003 004
BD Record	005 006
VCR COMBO	007 008 009 010 011
VCR Record	012
DHR COMBO	013

➤ **DVD**

Brand	Code
ANAM	030
AUDIOVOX	075
AUDIOLOGIC	085
ANABA	072
APEX DIGITAL	070 071 074 086 083 084 088 111 112
AIWA	114
BROKSONIC	062
BLAUPUNKT	074
B&K	122 123
CURTIS MATHES	027
CYBER HOME	077 078 079 082
CLARION	080 125
CIRRUS	081
CYBER HOME	065
CINEVISION	095
DAEWOO	066
DENON	146
FARENHEIT	067 068
FISHER	090
GPX	060
GO VIDEO	061 089 133 135
GE	069 074
GREENHILL	074
HITACHI	064 113
HITEKER	071
HOYO	073
HARMAN / KARDON	091 110
IRT	089
INTEGRA	092
JBL	091
JVC	022 033 115 116
JATON	073
KENWOOD	051 108 109
KISS	073
KONKA	059 100 106 107
KLH	074 075
LG(Goldstar)	025 031
LOEWE	057
LASONIC	058
MOBILE AUTHORITY	054
MEMOREX	055
MALATA	056
MAGNAVOX	076 093
MINTEK	074 094
MONYKA	073

Product	Code
Home Theater VCR COMBO	014 015 016
HDD Recorder COMBO	017
TWIN TRAY COMBO	018
STB DVD COMBO	019
DVD Receiver	020
AV Receiver	021

Brand	Code
NORCENT	048 049 050
NEXT BASE	052
NEC	053
NANTAUS	144
NESA	074
OPTOMEDIA ELECTRONICS	105
OPTIVIEW	072
ONKYO	076 092 119
PHILCO	044 045
PRINCETON	046 047
PROSCAN	023
PANASONIC	024 034 124 134 136 137 138
PHILIPS	036 076
PIONEER	037 143
ROTEL	117 118
RIO	120
RCA	023 035 074 075 131 132
RAITE	073
ROWA	038
SAMPO	104
SONY	026 029 126 127 128 129 130 141
SHERWOOD	039 041
SVA	042
SYLVANIA	043 093
SHARP	140
SANSUI	062
SANYO	062 090
SHINSONIC	094
THOMSON	145
TOSHIBA	028 062 076
TECHNICS	139
TVIEW	072
TOKAI	073
TEAC	096
TECHWOOD	097
TREDEX	098 099 101
URBAN CONCEPTS	076
VENTURER	075
VOCOPRO	102
YAMAHA	032 063
YAMAKAWA	040 073
XWAVE	103
ZENITH	076 121

➤ **SAMSUNG SET-TOP BOX**

Product	Code
Ground wave STB	000 001 002 008 013
CABLE STB	000 004 008 009 010 011 012 013 014 075 076 077 078 079 080 081 082
Satellite STB	000 003 008 013



➤ **SET-TOP BOX, CABLE BOX**

Brand	Code
ALPHASTAR	023
ANAM	043
CHANNEL MASTER	018 034
CROSSDIGITAL	019
CHAPARRAL	035
DIRECT TV	015 016 017 019 022 045 060 061 062 065 066 067 068
DAEWOO	074
DISH NETWORK SYSTEM	069 070
DISHPRO	069
DRAKE	018 024 032
DX ANTENNA	027
ECHOSTAR	025 069 070 071
EXPRESSVU	069
GE	065
GENERAL INSTRUMENT	046 047 048 063 064
GI	116
GOI	069
HAMLIN	078 099 106
HTS	069
HOME CABLE	056
HITACHI	022 100 105
HUGHES NETWORK	015 017
IQ	020
IQ PRISM	020
JANEIL	059
JERROLD	063 113 114
JVC	069 070
LG(Goldstar)	044 073
MAGNAVOX	016 021 036 038 039 040 041 042 084 098 103
MEMOREX	016
MOTOROLA	064
MACOM	018 100 105
MITSUBISHI	015
NEXT LEVEL	047 048 064

Brand	Code
OAK	101
PHILIPS	015 016 017 021 033 036 038 039 040 041 042 067 094 096 098 103
PIONEER	093 095 079 119
PRIMESTAR	046 049 050 063
PANASONIC	058 059 061 062 078 097 102 112 119
PAYSAT	016
PROSCAN	065 066
RCA	051 052 053 065 066 089 097 115
RADIOSHACK	064
REALISTIC	057
REGAL	078
REGENCY	090 098
SA	117 118
SAMSUNG	000 001 002 003 004 008 009 010 011 012 013 014 075 080 078 079 081 082 076 077
SCIENTIFIC ATLANTA	117 118
STAR TRAK	026
STS	020 027
SKY	031
SKY LIFE	005 006 007
SHACK	064
STAR CHOICE	064
SONY	054 060
SPRUCER	097
STARGATE 2000	111
SYLVANIA	091
TEXSCAN	091
TOCOM	107
TOSHIBA	015 017 028 029 030 072
ULTIMATE TV	060 066
UNIDEN	016 021 037 055 056 057
UNIVERSAL	108 109
VIEWSTAR	094 096 098 103
WAMER AMEX	121
ZENITH	024 031 068 092 104 110 112 120

To Select the Source

Use to select TV or other external input sources such as DVD players or Cable Box/Satellite receivers (Set-Top Box) connected to the TV. Use to select the input source of your choice.

1. Press the **MENU** button to display the menu.
Press the **▲** or **▼** button to select "Input", then press the **ENTER**  button.
2. Press the **ENTER**  button to select "Source List".
Press the **▲** or **▼** button to select signal source, then press the **ENTER**  button.
 - Available signal sources: TV, AV1, AV2, S-Video, Component1, Component2, PC, HDMI1, HDMI2/DVI, HDMI3, HDMI4, USB, DLNA.
 - You can choose only those external devices that are connected to the TV. In the "Source List", connected inputs will be highlighted and sorted to the top. Inputs that are not connected will be sorted to the bottom.
 - If each USB device is connected to 2 WISELINK jacks, each is shown as "USB1", "USB2" in order of reading.
 - **Using the Color buttons on the remote with the Source list**

- **Red (Refresh):** Refreshes the connecting external devices.
- **TOOLS (Option):** Displays the "Edit Name" and "Information" menus.

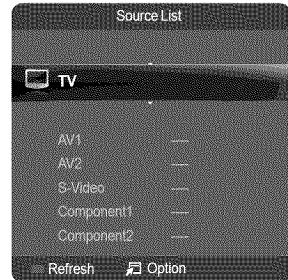
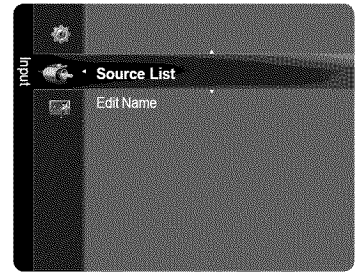



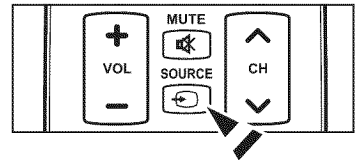

-  Press the **SOURCE** button on the remote control to view an external signal source.



To Edit the Input Source Name

Name the device connected to the input jacks to make your input source selection easier.

1. Press the **MENU** button to display the menu.
Press the **▲** or **▼** button to select "Input", then press the **ENTER**  button.
Press the **▲** or **▼** button to select "Edit Name", then press the **ENTER**  button.
2. Press the **▲** or **▼** button to select "AV1", "AV2", "S-Video", "Component1", "Component2", "PC", "HDMI1", "HDMI2/DVI", "HDMI3", "HDMI4" input jack, then press the **ENTER**  button.
3. Press the **▲** or **▼** button to select "VCR", "DVD", "Cable STB", "Satellite STB", "PVR STB", "AV Receiver", "Game", "Camcorder", "PC", "TV", "IPTV", "Blu-Ray", "HD DVD", "DMA" input source, then press the **ENTER**  button.
Press the **EXIT** button to exit.
 - When a PC with a resolution of 1920 x 1080@60Hz is connected to the HDMI IN 2 port, you should set the "HDMI2/DVI" mode to "PC" in the "Edit Name" of the "Input" mode.

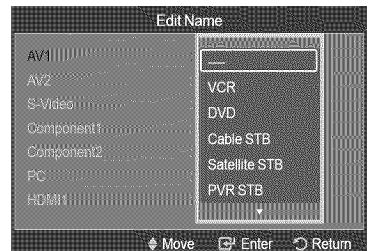
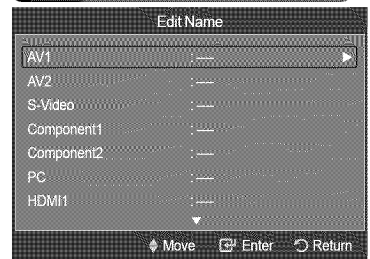
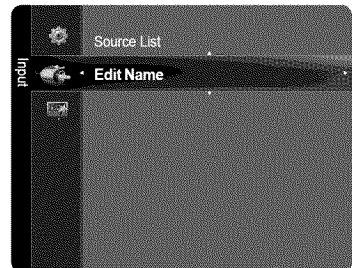

Picture Control

Changing the Picture Standard

You can select the type of picture which best corresponds to your viewing requirements.

1. Press the **MENU** button to display the menu.
Press the **ENTER** button to select "Picture".
2. Press the **ENTER** button to select "Mode". Press the **▲** or **▼** button to select "Dynamic", "Standard" or "Movie". Press the **ENTER** button.

- **Dynamic:** Selects the picture for high-definition in a bright room.
- **Standard:** Selects the picture for the optimum display in a normal environment.
- **Movie:** Selects the picture for viewing movies in a dark room.

3. Press the **EXIT** button to exit.

Easy Setting

1. Press the **TOOLS** button on the remote control.
2. Press the **▲** or **▼** button to select "Picture Mode".
3. Press the **◀** or **▶** button to select the required option.
4. Press the **EXIT** or **TOOLS** button to exit.

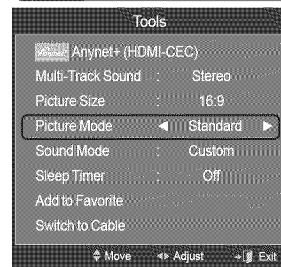
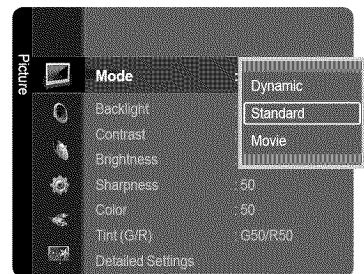
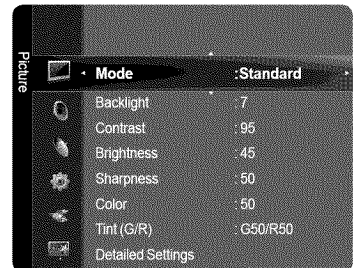

Customizing the Picture Settings

Your television has several setting options that allow you to control the picture quality.

1. To select the desired picture mode, follow the "Changing the Picture Standard" instructions numbers 1 and 2.
2. Press the **▲** or **▼** button to select "Backlight", "Contrast", "Brightness", "Sharpness", "Color" or "Tint(G/R)", then press the **ENTER** button.
3. Press the **◀** or **▶** button to decrease or increase the value of a particular item. Press the **ENTER** button.
Press the **EXIT** button to exit.
 - When you make changes to "Backlight", "Contrast", "Brightness", "Sharpness", "Color" or "Tint(G/R)", the OSD will be adjusted accordingly.
 - In PC mode, you can only make changes to "Backlight", "Contrast" and "Brightness".
 - Settings can be adjusted and stored for each external device you have connected to an input of the TV.
 - The energy consumed during use can be significantly reduced if the level of brightness of the picture is reduced, and that this will reduce the overall running cost.

- **Backlight:** Adjusts the brightness of LCD back light.
- **Contrast:** Adjusts the contrast level of the picture.
- **Brightness:** Adjusts the brightness level of the picture.
- **Sharpness:** Adjusts the edge definition of the picture.
- **Color:** Adjusts color saturation of the picture.
- **Tint(G/R):** Adjusts the color tint of the picture.

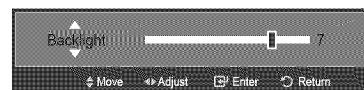
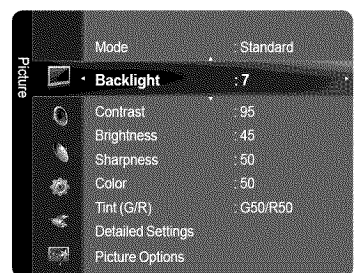

Adjusting the Detailed Settings

Samsung's new TVs allow you to make even more precise picture settings than previous models. See below to adjust detailed picture settings.

Activating Detailed Settings

1. Press the **MENU** button to display the menu.
Press the **ENTER** button to select "Picture".
2. Press the **ENTER** button to select "Mode".
Press the **▲** or **▼** button to select "Standard" or "Movie", then press the **ENTER** button.
➤ "Detailed Settings" is available in "Standard" or "Movie" mode.
3. Press the **▲** or **▼** button to select "Detailed Settings", then press the **ENTER** button.
➤ In PC mode, you can only make changes to "Dynamic Contrast", "Gamma" and "White Balance" from among the "Detailed Settings" items.

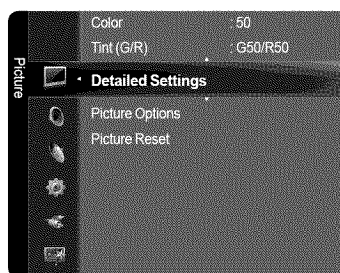
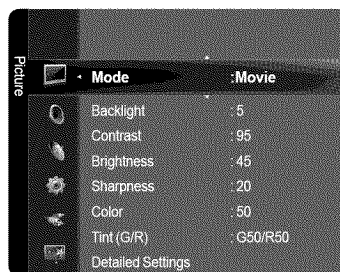

Setting the Black adjust

You can select the black level on the screen to adjust the screen depth.

4. Press the **▲** or **▼** button to select "Black adjust", then press the **ENTER** button.
5. Press the **▲** or **▼** button to select "Off", "Low", "Medium" or "High".
Press the **ENTER** button.

- **Off:** Turns off the black adjustment function.
- **Low:** Sets the black color depth to low.
- **Medium:** Sets the black color depth to medium.
- **High:** Sets the black color depth to high.

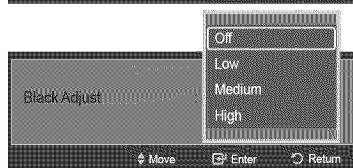
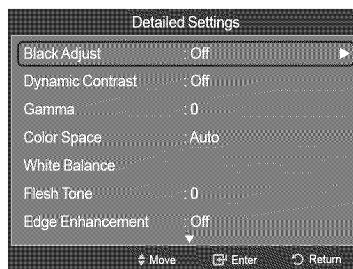

Setting the Dynamic Contrast

You can adjust the screen contrast so that the optimal contrast is provided.

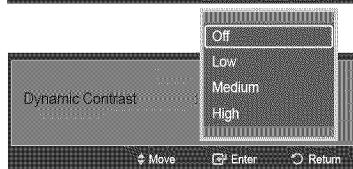
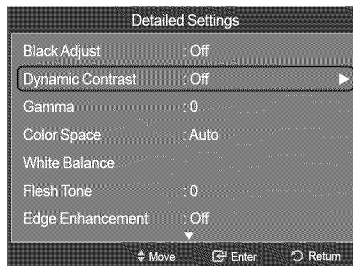

6. Press the **▲** or **▼** button to select "Dynamic Contrast", then press the **ENTER** button.
7. Press the **▲** or **▼** button to select "Off", "Low", "Medium" or "High".
Press the **ENTER** button.

- **Off:** Turns off the dynamic contrast adjustment function.
- **Low:** Sets the dynamic contrast to low.
- **Medium:** Sets the dynamic contrast to medium.
- **High:** Sets the dynamic contrast to high.



Adjusting the Gamma

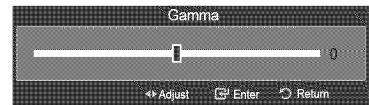
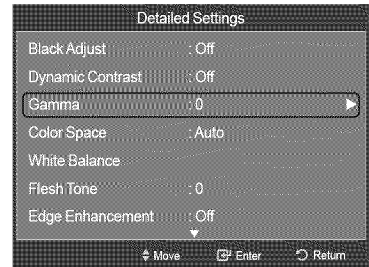

You can adjust the Primary Color (Red, Green, Blue) Intensity. (-3 ~ +3)

8. Press the ▲ or ▼ button to select "Gamma", then press the **ENTER**  button.
9. Press the ◀ or ▶ button to decrease or increase the value. Press the **ENTER**  button.



Setting the Color Space



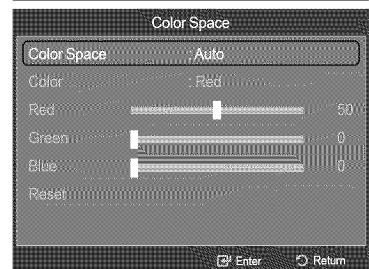
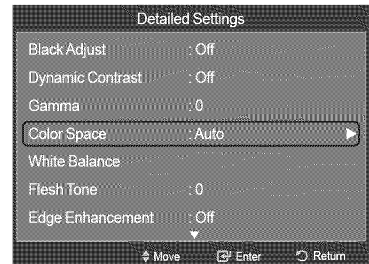

Color space is a color matrix composed of red, green and blue colors. Select your favorite color space to experience the most natural color.

10. Press the ▲ or ▼ button to select "Color Space", then press the **ENTER**  button.
11. Press the **ENTER**  button again to select "Color Space".
12. Press the ▲ or ▼ button to select "Auto", "Native" or "Custom". Press the **ENTER**  button.

- **Auto:** Auto Color Space automatically adjusts to the most natural color tone based on program sources.
- **Native:** Native Color Space offers deep and rich color tone.
- **Custom:** Adjusts the color range to suit your preference. (see "Customizing the Color Space")



Customizing the Color Space

13. Press the ▲ or ▼ button to select "Color", then press the **ENTER**  button.
 - "Color" is available when "Color Space" is set to "Custom".
14. Press the ▲ or ▼ button to select "Red", "Green", "Blue", "Yellow", "Cyan" or "Magenta". Press the **ENTER**  button.
15. Press the ▲ or ▼ button to select "Red", "Green", or "Blue" to change it. Press the **ENTER**  button.
16. Press the ◀ or ▶ button to decrease or increase the value of a particular item. Press the **ENTER**  button.
 - In "Color", you can adjust the RGB values for the selected color.
 - To reset the adjusted RGB value, select "Reset".

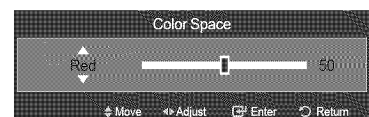
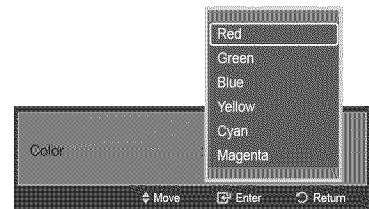
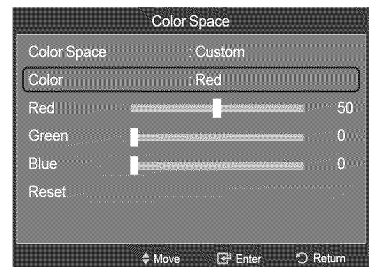
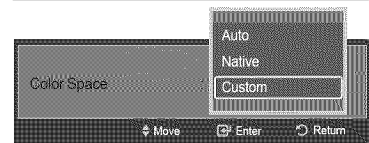

- **Red:** Adjusts the red saturation level of the selected color.
- **Green:** Adjusts the green saturation level of the selected color.
- **Blue:** Adjusts the blue saturation level of the selected color.
- **Reset:** Resets the color space to the default values.

- Changing the adjustment value will refresh the adjusted screen.
- Settings can be adjusted and stored for each external device you have connected to an input of the TV. For example, if you have a DVD player connected to HDMI 1 and it is currently selected, settings and adjustments will be saved for the DVD player.



Adjusting the White Balance

You can adjust the color temperature for more natural picture colors.

17. Press the ▲ or ▼ button to select "White Balance", then press the **ENTER**  button.
18. Select the required option by pressing the ▲ or ▼ button, then press the **ENTER**  button.
19. Press the ◀ or ▶ button to decrease or increase the value of a particular item. Press the **ENTER**  button.

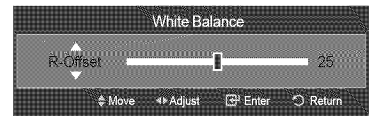
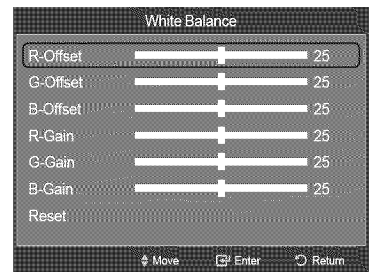
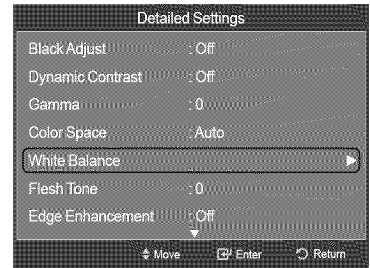

- **R-Offset:** Adjusts the red color darkness.
- **G-Offset:** Adjusts the green color darkness.
- **B-Offset:** Adjusts the blue color darkness.
- **R-Gain:** Adjusts the red color brightness.
- **G-Gain:** Adjusts the green color brightness.
- **B-Gain:** Adjusts the blue color brightness.
- **Reset:** The previously adjusted white balance will be reset to the factory defaults.

➤ Changing the adjustment value will refresh the adjusted screen.



Adjusting the Flesh Tone

You can emphasize the pink 'flesh tone' in the picture.

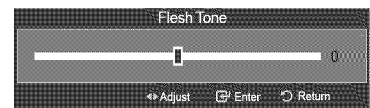
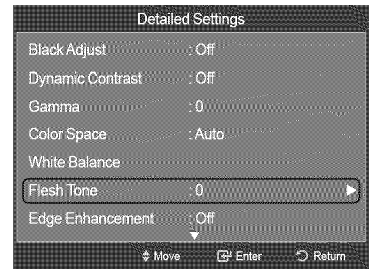

20. Press the ▲ or ▼ button to select "Flesh Tone", then press the **ENTER**  button.
21. Press the ◀ or ▶ button to decrease or increase the value. Press the **ENTER**  button.

➤ Changing the adjustment value will refresh the adjusted screen.



Setting the Edge Enhancement

You can emphasize object boundaries in the picture.

22. Press the ▲ or ▼ button to select "Edge Enhancement", then press the **ENTER**  button.
23. Press the ▲ or ▼ button to select "Off" or "On". Press the **ENTER**  button.

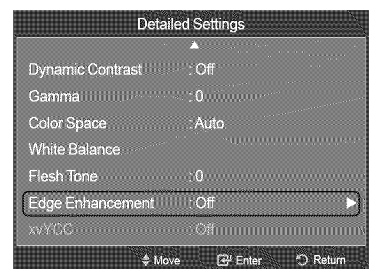

Setting the xvYCC

Setting the xvYCC mode to "On" increases detail and color space when watching movies from an external device (ie. DVD player) connected to the HDMI or Component IN jacks.



24. Press the ▲ or ▼ button to select "xvYCC", then press the **ENTER**  button.

25. Press the ▲ or ▼ button to select "Off" or "On".
Press the **ENTER**  button.

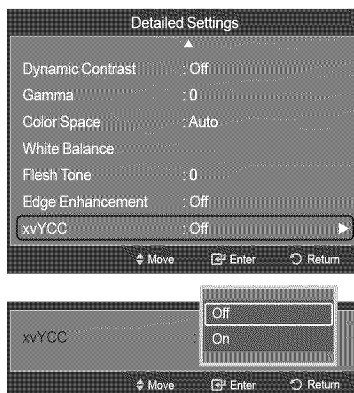
➤ "xvYCC" is available when the picture mode is set to "Movie", and the external input is set to "HDMI" or "Component" mode.



Resetting the Picture Settings to the Factory Defaults

1. To select the desired picture mode, follow the "Changing the Picture Standard" instructions numbers 1 and 2. (see page 28)
2. Press the ▲ or ▼ button to select "Picture Reset", then press the **ENTER**  button.
3. Press the ▲ or ▼ button to select "Reset Picture Mode" or "Cancel", then press the **ENTER**  button.
Press the **EXIT** button to exit.

- **Reset Picture Mode:** All picture values in the current picture mode return to default settings.
- **Cancel:** Does not perform a screen reset.

➤ Each mode can be reset.

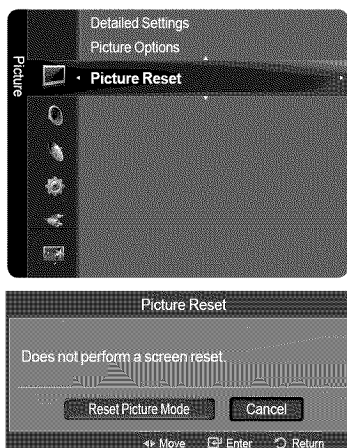

Configuring Picture Options

Activating Picture Options

1. Press the **MENU** button to display the menu. Press the **ENTER** button to select "Picture".
2. Press the **▲** or **▼** button to select "Picture Options", then press the **ENTER** button.
 - Press the **▲** or **▼** button to select a particular item. Press the **ENTER** button.
 - When you are satisfied with your setting, press the **ENTER** button.
 - In PC mode, you can only make changes to the "Color Tone" and "Size" from among the items in "Picture Options".

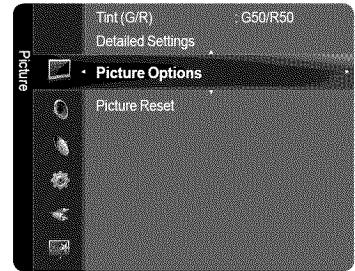

Setting the Color Tone

1. Follow the "Activating Picture Options" instructions numbers 1 and 2.
2. Press the **▲** or **▼** button to select "Color Tone", then press the **ENTER** button.
3. Press the **▲** or **▼** button to select "Cool2", "Cool1", "Normal", "Warm1" or "Warm2". Press the **ENTER** button.
 - "Warm1" or "Warm2" is only activated when the picture mode is "Movie".
 - Settings can be adjusted and stored for each external device you have connected to an input of the TV.

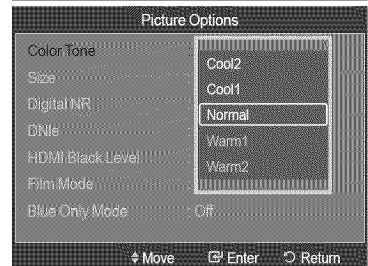
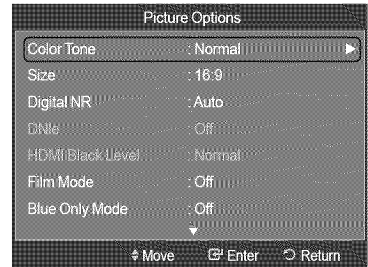

Setting the Screen Size

Occasionally, you may want to change the size of the image on your screen. Your TV comes with six screen size options, each designed to work best with specific types of video input. Your cable box or satellite receiver may have its own set of screen sizes as well. In general, though, you should view the TV in 16:9 mode as much as possible.

1. Follow the "Activating Picture Options" instructions numbers 1 and 2.
2. Press the **▲** or **▼** button to select "Size", then press the **ENTER** button.
3. Press the **▲** or **▼** button to select the screen format you want. Press the **ENTER** button. Press the **EXIT** button to exit.



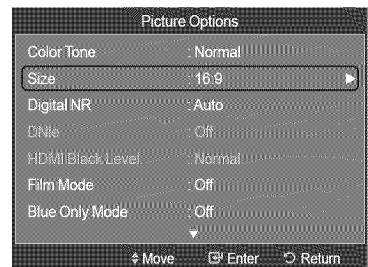

- **16:9** : Sets the picture to 16:9 wide mode.
- **Zoom1** : Magnifies the size of the picture on the screen.
- **Zoom2** : Magnifies the size of the picture more than "Zoom1".
- **Wide Fit** : Enlarges the aspect ratio of the picture to fit the entire screen.
- **4:3** : Sets the picture to 4:3 normal mode.
- **Just Scan** : Use the function to see the full image without any cutoff when HDMI (720p/1080i/1080p), Component (1080i/1080p) or DTV (1080i) signals are input.



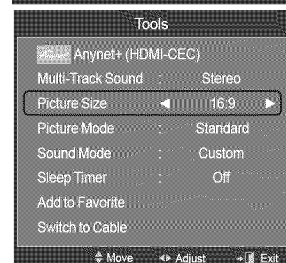

Easy Setting

1. Press the **TOOLS** button on the remote control.
2. Press the **▲** or **▼** button to select "Picture Size".
3. Press the **◀** or **▶** button to select the required option.
4. Press the **EXIT** or **TOOLS** button to exit.

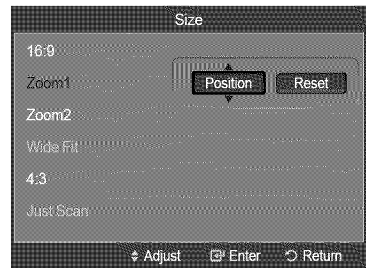

- When Double ( , ) mode has been set in PIP, the Picture Size cannot be set.
- Temporary image retention may occur when viewing a static image on the set for more than two hours.
- **After selecting "Zoom1", "Zoom2" or "Wide Fit":**
Press the ◀ or ▶ button to select "Position", then press the ENTER  button. Press the ▲, ▼, ◀ or ▶ button to move the picture up and down.
Reset: Press the ◀ or ▶ button to select "Reset", then press the ENTER  button. You can initialize the setting.



- **After selecting "Just Scan" in HDMI (1080i/1080p) or Component (1080i/1080p) mode:**
Press the ◀ or ▶ button to select "Position", then press the ENTER  button. Press the ▲, ▼, ◀ or ▶ button to move the picture.
Reset: Press the ◀ or ▶ button to select "Reset", then press the ENTER  button. You can initialize the setting.

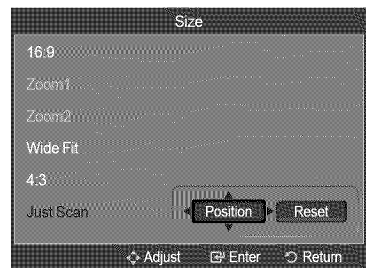

- HD (High Definition)
16:9 - 1080i/1080p (1920x1080), 720p (1280x720)

- Settings can be adjusted and stored for each external device you have connected to an input of the TV.

Input Source	Picture Size
ATV, AV, S-Video, Component (480i, 480p)	16:9, Zoom1, Zoom2, 4:3
DTV(1080i), Component (1080i, 1080p), HDMI (720p, 1080i, 1080P)	16:9, 4:3, Wide Fit, Just Scan
PC	16:9, 4:3

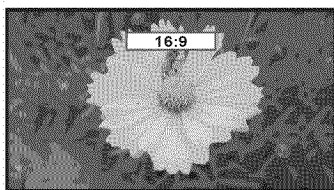

16:9
Sets the picture to 16:9 wide mode.

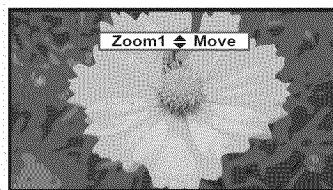

Zoom1
Magnifies the size of the picture on the screen.

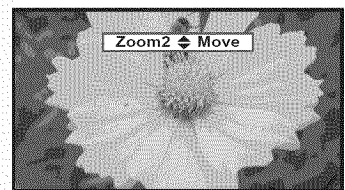

Zoom2
Magnifies the size of the picture more than "Zoom1".

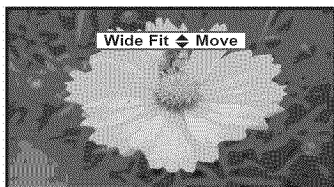

Wide Fit
Enlarges the aspect ratio of the picture to fit the entire screen.

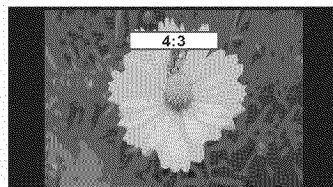

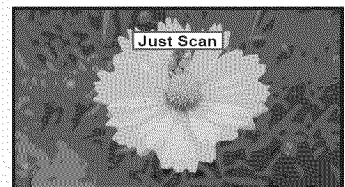

4:3
Sets the picture to 4:3 normal mode.



Just Scan
Use the function to see the full image without any cutoff when HDMI (720p/1080i/1080p), Component (1080i/1080p) or DTV (1080i) signals are input.

Setting the Digital Noise Reduction

If the broadcast signal received by your TV is weak, you can activate the Digital Noise Reduction feature to help reduce any static and ghosting that may appear on the screen.

1. Follow the "Activating Picture Options" instructions numbers 1 and 2. (Refer to page 33)
2. Press the ▲ or ▼ button to select "Digital NR", then press the **ENTER**  button.
3. Press the ▲ or ▼ button to select "Off", "Low", "Medium", "High" or "Auto". Press the **ENTER**  button.

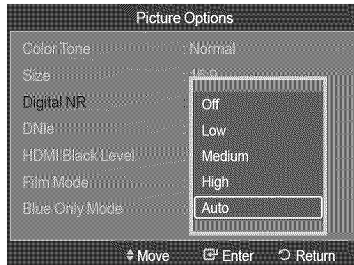
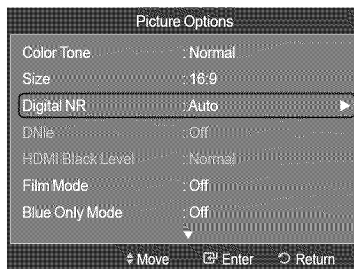

- **Off:** Turns the screen noise reduction function off.
- **Low:** Reduces screen noise at a low level.
- **Medium:** Reduces screen noise at a medium level.
- **High:** Reduces screen noise at a high level.
- **Auto:** Automatically recognizes and reduces screen noise.

Press the **EXIT** button to exit.



Setting the DNle (Digital Natural Image engine)

This TV includes the DNle function to provide high visual quality. If you set DNle to on, you can view the screen with the DNle feature activated.

1. Follow the "Activating Picture Options" instructions numbers 1 and 2. (Refer to page 33)
2. Press the ▲ or ▼ button to select "DNle", then press the **ENTER**  button.
3. Press the ▲ or ▼ button to select "Off" or "On", then press the **ENTER**  button.

- **Off:** Switches off the DNle mode.
- **On:** Switches on the DNle mode.

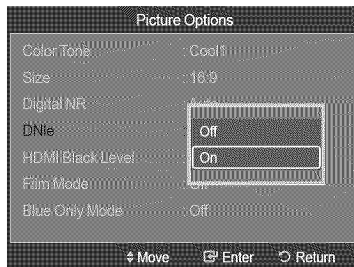
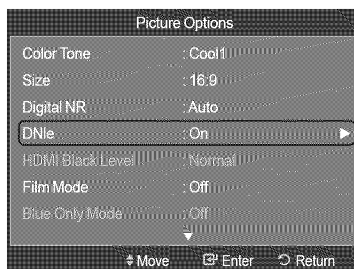

Press the **EXIT** button to exit.

- DNle™ (Digital Natural Image engine) **DNle**
This feature brings you a more detailed image with 3D noise reduction and detail, contrast and white enhancement.
- "DNle" is only available in "Dynamic" mode.



Setting the HDMI Black Level

You can select the black level on the screen to adjust the screen depth.

1. Follow the "Activating Picture Options" instructions numbers 1 and 2. (Refer to page 33)
2. Press the ▲ or ▼ button to select "HDMI Black Level", then press the **ENTER**  button.
3. Press the ▲ or ▼ button to select "Normal" or "Low", then press the **ENTER**  button.

- **Normal:** The screen gets brighter.
- **Low:** The screen gets darker.

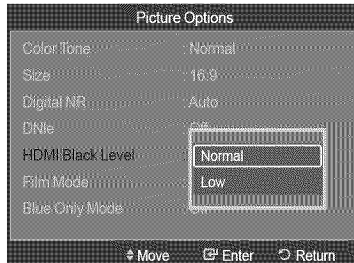
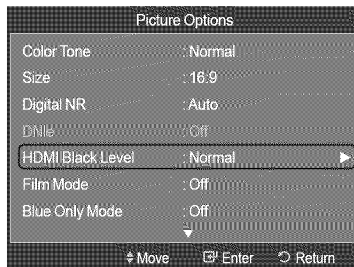

- This function is active only when an external device is connected to the TV via HDMI. "HDMI Black Level" function may not be compatible with all external devices.

Press the **EXIT** button to exit.



Setting the Film Mode

The TV can be set to automatically sense and process film signals from all sources and adjust the picture for optimum quality.

1. Follow the "Activating Picture Options" instructions numbers 1 and 2. (Refer to page 33)
2. Press the ▲ or ▼ button to select "Film Mode", then press the **ENTER**  button.
3. Press the ▲ or ▼ button to select "Off", "Auto1" or "Auto2", then press the **ENTER**  button.

- **Off:** Turn the Film Mode function off.
- **Auto1:** Automatically adjusts the picture for the best quality when watching a film.
- **Auto2:** Automatically optimizes the video text when watching a film.

Press the **EXIT** button to exit.

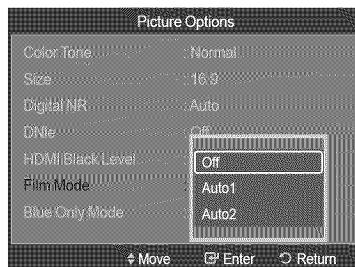
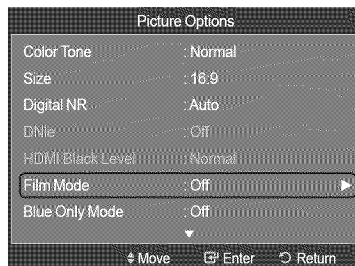

- "Film mode" is supported in TV, AV, S-Video, Component (480i / 1080i) and HDMI (480i / 1080i).



Setting the Blue Only Mode

This function is for AV device measurement experts. This function displays the blue signal only by removing the red and green signals from the video signal so as to provide a Blue Filter effect that is used to adjust the Color and Tint of video equipment such as DVD players, Home Theaters, etc.

Using this function, you can adjust the Color and Tint to preferred values appropriate to the signal level of each video device using the Red/Green/Blue/ Cyan/Magenta/Yellow Color Bar Patterns, without using an additional Blue Filter.

1. Follow the "Activating Picture Options" instructions numbers 1 and 2. (Refer to page 33)
2. Press the ▲ or ▼ button to select "Blue Only Mode", then press the **ENTER**  button.
3. Press the ▲ or ▼ button to select "Off" or "On", then press the **ENTER**  button.

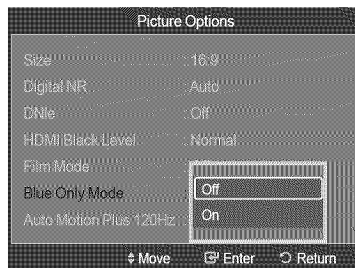
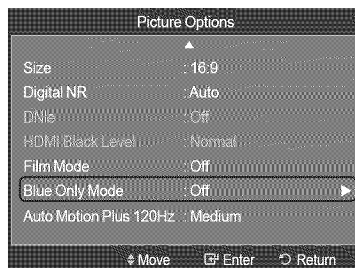

Press the **EXIT** button to exit.

- "Blue Only Mode" is available when the picture mode is set to "Movie" or "Standard".



Setting the Auto Motion Plus 120Hz

Removes drag from fast scenes with a lot of movement to provide a clearer picture.

1. Follow the “Activating Picture Options” instructions numbers 1 and 2. (Refer to page 33)
2. Press the ▲ or ▼ button to select “Auto Motion Plus 120Hz”, then press the **ENTER**  button.
3. Press the ▲ or ▼ button to select “Off”, “Low”, “Medium”, “High” or “Demo”, then press the **ENTER**  button.

- **Off:** Switches Auto Motion Plus 120Hz off.
- **Low:** Sets Auto Motion Plus 120Hz to minimum.
- **Medium:** Sets Auto Motion Plus 120Hz to medium.
- **High:** Sets Auto Motion Plus 120Hz to maximum.
- **Demo:** Displays the difference between Auto Motion Plus 120Hz on and off modes. The screen after applying “Auto Motion Plus 120Hz” appears on the left.

Press the **EXIT** button to exit.

- If you enable “Auto Motion Plus 120Hz”, noise may appear on the screen. If this occurs, set “Auto Motion Plus 120Hz” to “Off”.

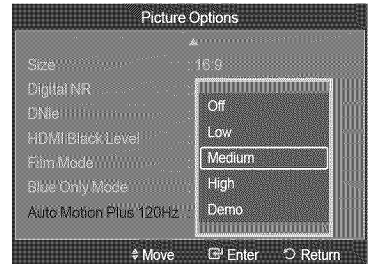
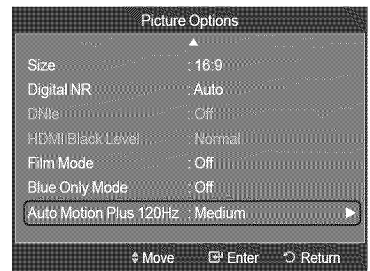

Viewing Picture-in-Picture

You can use the PIP feature to simultaneously watch the TV tuner and one external video source. (See page 44 to select the PIP picture sound.) This product has one built-in tuner, which does not allow PIP to function in the same mode. Please see 'PIP Settings' below for details.

- While V-Chip (See page 62) is in operation, the PIP function cannot be used.

Activating Picture-in-Picture

1. Press the **MENU** button to display the menu.
Press the **▲** or **▼** button to select "Setup", then press the **ENTER** button.
Press the **▲** or **▼** button to select "PIP", then press the **ENTER** button.

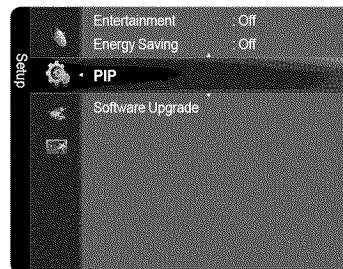

2. Press the **ENTER** button again.
Press the **▲** or **▼** button to select "On", then press the **ENTER** button.
 - If you turn the TV off while watching in PIP mode and turn it on again, the PIP window will disappear.
 - You can view TV broadcasts on the PIP screen (sub-picture) when the main picture is from an external device connected to HDMI 1, HDMI/DVI 2, HDMI 3, HDMI 4, Component1, 2 or PC.

PIP Settings

Main picture	Sub picture
Component 1, 2	TV
HDMI 1, HDMI/DVI 2, HDMI 3, HDMI 4	
PC	

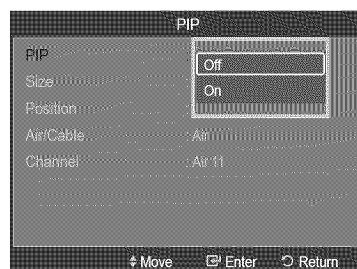

Changing the Size of the PIP Window

3. Press the **▲** or **▼** button to select "Size", then press the **ENTER** button.
Press the **▲** or **▼** button to select the required option, then press the **ENTER** button.
 - You may notice that the picture in the PIP window becomes slightly unnatural when you use the main screen to view a game or karaoke.

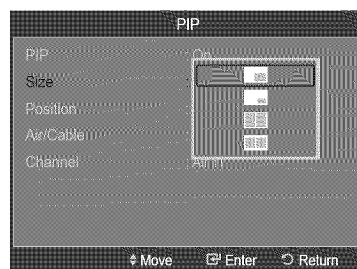



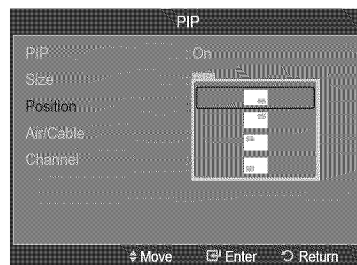

Changing the Position of the PIP Window

4. Press the **▲** or **▼** button to select "Position", then press the **ENTER** button.
Press the **▲** or **▼** button to select the required option, then press the **ENTER** button.
 - In Double Window (□□) and Double Wide (□□) modes, "Position" cannot be selected.



Changing the PIP Channel

5. Press the ▲ or ▼ button to select "Air/Cable", then press the **ENTER**  button.
6. Press the ▲ or ▼ button to select "Air" or "Cable", then press the **ENTER**  button.
7. Press the ▲ or ▼ button to select "Channel", then press the **ENTER**  button.
8. Press the ▲ or ▼ button to select the desired channel in the PIP window. Press the **ENTER**  button. Press the **EXIT** button to exit.

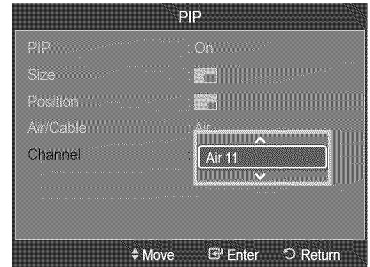
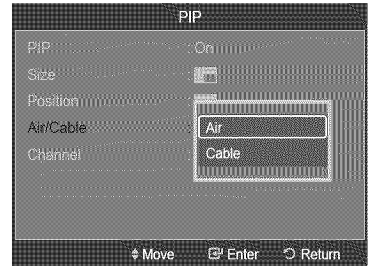

Easy Setting

1. Press the **TOOLS** button on the remote control.
2. Press the ▲ or ▼ button to select "PIP", then press the **ENTER**  button.
3. Press the ◀ or ▶ button to select "On".
4. Press the ▲ or ▼ button to select a particular item.
5. Press the ◀ or ▶ button to select the required option.
6. Press the **EXIT** or **TOOLS** button to exit.

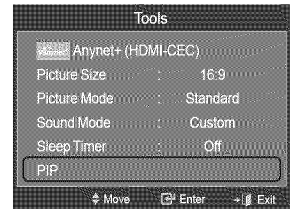

Sound Control

Changing the Sound Standard

You can select the sound mode to best suit the programming you're watching.

1. Press the **MENU** button to display the menu.
Press the **▲** or **▼** button to select "Sound", then press the **ENTER** button.
2. Press the **ENTER** button to select "Mode". Press the **▲** or **▼** button to select "Standard", "Music", "Movie", "Speech", or "Custom" sound setting, then press the **ENTER** button.
Press the **EXIT** button to exit.

- **Standard:** Selects the normal sound mode.
- **Music:** Emphasizes music over voices.
- **Movie:** Provides the best sound for movies
- **Speech:** Emphasizes voice over other sounds.
- **Custom:** Recalls your customized sound settings.
(see "Customizing the Sound")

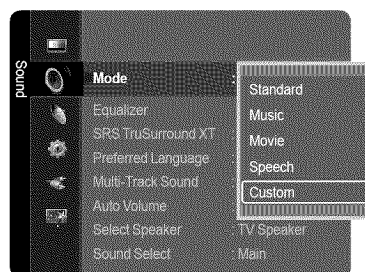
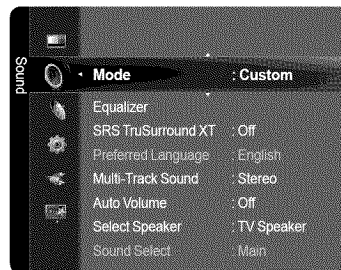

Easy Setting

1. Press the **TOOLS** button on the remote control.
2. Press the **▲** or **▼** button to select "Sound Mode".
3. Press the **◀** or **▶** button to select the required option.
4. Press the **EXIT** or **TOOLS** button to exit.

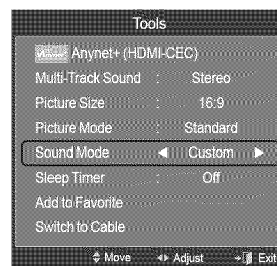

Customizing the Sound

The sound settings can be adjusted to suit your personal preference.

1. Press the **MENU** button to display the menu.
Press the **▲** or **▼** button to select "Sound", then press the **ENTER** button.
2. Press the **▲** or **▼** button to select "Equalizer", then press the **ENTER** button.
3. Press the **ENTER** button to select "Mode".
Press the **▲** or **▼** button to select "Standard", "Music", "Movie", "Speech", or "Custom" sound setting, then press the **ENTER** button.

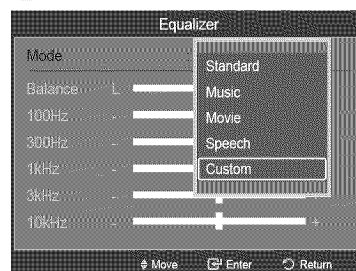
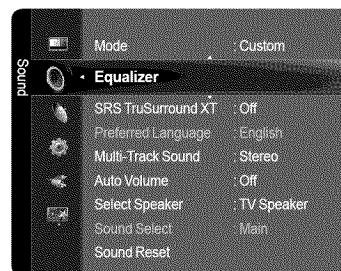

- Press the ▲ or ▼ button to select a particular frequency to adjust.
Press the ◀ or ▶ button to increase or decrease the level of the particular frequency.

- **Mode:** Selects the sound mode among the predefined settings.
- **Balance L/R:** Adjusts the balance between the right and left speaker.
- **Bandwidth Adjustment (100Hz, 300Hz, 1kHz, 2kHz, 3kHz, 10kHz):**
To adjust the level of different bandwidth frequencies.

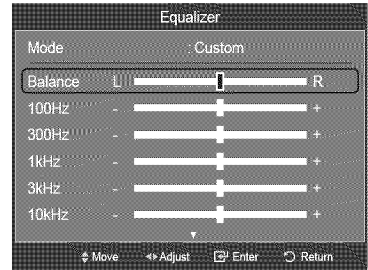

Resetting the Equalizer Settings to the Factory Defaults

- Press the ▲ or ▼ button to select "Reset", then press the ENTER button.
➤ The equalizer resets to the factory defaults.
Press the EXIT button to exit.

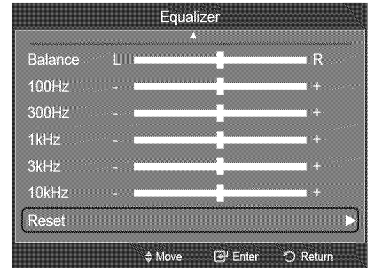

Setting the TruSurround XT

TruSurround XT is a patented SRS technology that solves the problem of playing 5.1 multichannel content over two speakers. TruSurround delivers a compelling, virtual surround sound experience through any two-speaker playback system, including internal television speakers. It is fully compatible with all multichannel formats.

- Press the MENU button to display the menu.
Press the ▲ or ▼ button to select "Sound", then press the ENTER button.
- Press the ▲ or ▼ button to select "SRS TruSurround XT", then press the ENTER button.
- Press the ▲ or ▼ button to select "Off" or "On", then press the ENTER button.
Press the EXIT button to exit.

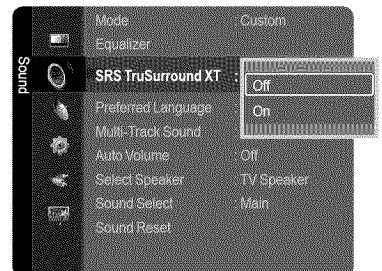
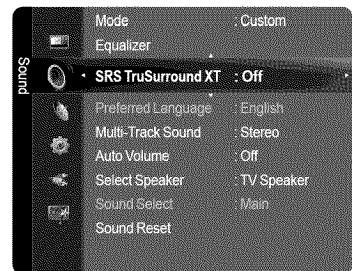

TruSurround XT, SRS and  Symbol are trademarks of SRS Labs, Inc.
TruSurround XT technology is incorporated under license from SRS Labs, Inc.

Choosing Preferred Language

The digital-TV transmission system is capable of simultaneous transmission of many audio tracks (for example, simultaneous translations of the program into foreign languages). Select the language you would like to hear the audio track in.

1. Press the **MENU** button to display the menu.
Press the **▲** or **▼** button to select "Sound", then press the **ENTER**  button.



2. Press the **▲** or **▼** button to select "Preferred Language", then press the **ENTER**  button.



3. Press the **▲** or **▼** button to choose the language (English, Spanish or French) you want, then press the **ENTER**  button.

Press the **EXIT** button to exit.

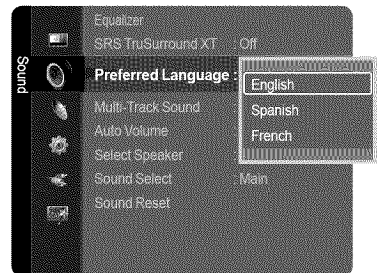
- "Preferred Language" is available only in Digital TV mode.
- You can only select the language from among the actual languages being broadcast.



Choosing a Multi-Channel Sound (MTS) track

1. Press the **MENU** button to display the menu.
Press the **▲** or **▼** button to select "Sound", then press the **ENTER**  button.
2. Press the **▲** or **▼** button to select "Multi-Track Sound", then press the **ENTER**  button.

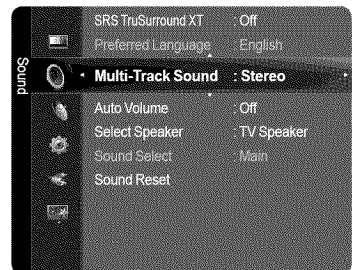

3. Press the **▲** or **▼** button to select a setting you want, then press the **ENTER**  button. Press the **EXIT** button to exit.

- **Mono**: Choose for channels that are broadcasting in mono or if you are having difficulty receiving a stereo signal.
- **Stereo**: Choose for channels that are broadcasting in stereo.
- **SAP**: Choose to listen to the Separate Audio Program, which is usually a foreign-language translation.

- "Multi-Track Sound" is available only in Analog TV mode.
- Depending on the particular program being broadcast, you can listen to "Mono", "Stereo" or "SAP".

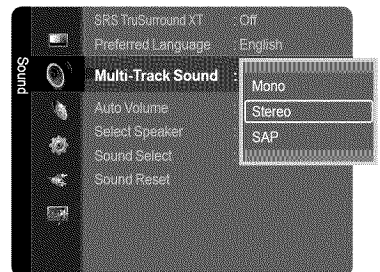

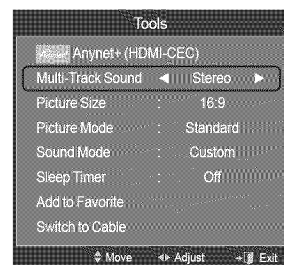

Easy Setting

1. Press the **TOOLS** button on the remote control.
2. Press the **▲** or **▼** button to select "Multi-Track Sound".
3. Press the **◀** or **▶** button to select the required option.
4. Press the **EXIT** or **TOOLS** button to exit.



Automatic Volume Control

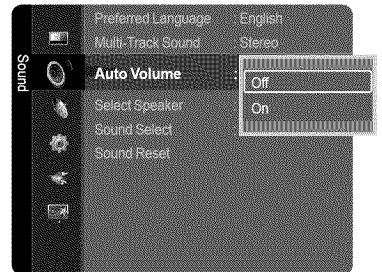
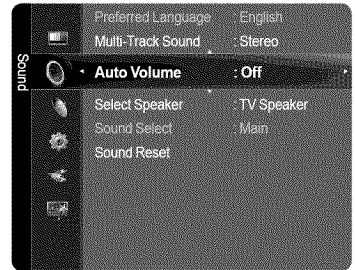

Reduces the differences in volume level among broadcasters.

1. Press the **MENU** button to display the menu.
Press the **▲** or **▼** button to select "Sound", then press the **ENTER**  button.
2. Press the **▲** or **▼** button to select "Auto Volume", then press the **ENTER**  button.
3. Press the **▲** or **▼** button to set "Off" or "On" then press the **ENTER**  button.
Press the **EXIT** button to exit.



Selecting the Speaker

When you watch TV by connecting it to a home theater, turn the TV speaker off so that the audio from the TV is output using the external speakers instead of the TV speakers.

1. Press the **MENU** button to display the menu.
Press the **▲** or **▼** button to select "Sound", then press the **ENTER**  button.
2. Press the **▲** or **▼** button to select "Select Speaker", then press the **ENTER**  button.

- **External Speaker:** Used to listen to the sound of the External Speaker.
- **TV Speaker:** Used to listen to the sound of the TV Speaker.

Press the **EXIT** button to exit.

- When "Select Speaker" is set to "External Speaker", you can operate only "Preferred Language" (in digital TV mode), "Multi-Track Sound" (in analog TV mode), "Sound Select" (in PIP mode) and "Sound Reset" in Sound menu.
- The **VOL -**, **VOL+** and **MUTE** buttons do not operate when the "Select Speaker" is set to "External Speaker".

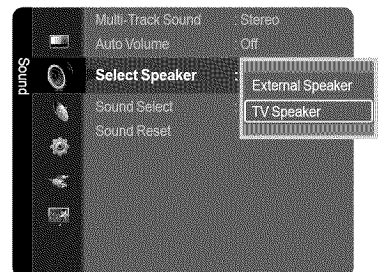
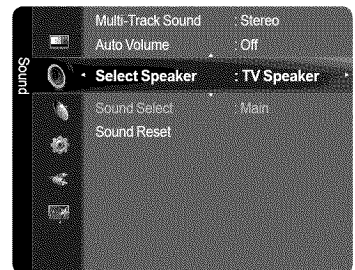



	TV's Internal Speakers			Audio Out (Optical, L/R Out) to Sound System		
	RF	AV, S-Video	Component, PC, HDMI	RF	AV, S-Video	Component, PC, HDMI
TV Speaker	Speaker Output	Speaker Output	Speaker Output	Sound Output	Sound Output	Sound Output
External Speaker	Mute	Mute	Mute	Sound Output	Sound Output	Sound Output
Video No Signal	Mute	Mute	Mute	Mute	Mute	Mute



Manufactured under license from Dolby Laboratories. Dolby and the double-D symbol are trademarks of Dolby Laboratories.

Listening to the Sound of the Sub (PIP) Picture

When the PIP feature is activated, you can listen to the sound of the sub (PIP) picture.

1. Press the **MENU** button to display the menu.
Press the **▲** or **▼** button to select "Sound", then press the **ENTER**  button.
2. Press the **▲** or **▼** button to select "Sound Select", then press the **ENTER**  button.
3. Press the **▲** or **▼** button to select "Main" or "Sub", then press the **ENTER**  button.
Press the **EXIT** button to exit.

- **Main**: Used to listen to the sound of the main picture.
- **Sub**: Used to listen to the sound of the sub picture.

➤ You can select this option when "PIP" is set to "On". (See page 38)

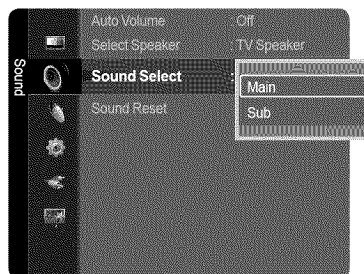
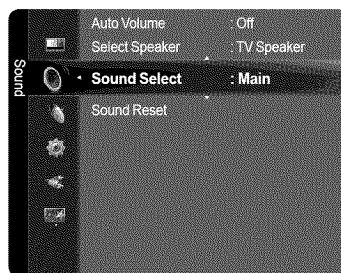

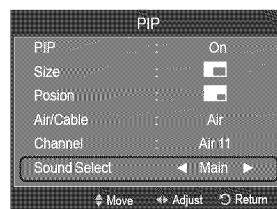

Easy Setting

1. Press the **TOOLS** button on the remote control.
2. Press the **▲** or **▼** button to select "PIP".
3. Press the **◀** or **▶** button to select "On".
4. Press the **▲** or **▼** button to select "Sound Select".
5. Press the **◀** or **▶** button to select the required option.
6. Press the **EXIT** or **TOOLS** button to exit.



Resetting the Sound Settings to the Factory Defaults

You can restore the Sound settings to the factory defaults.

1. Press the **MENU** button to display the menu.
Press the **▲** or **▼** button to select "Sound", then press the **ENTER**  button.
2. Press the **▲** or **▼** button to select "Sound Reset", then press the **ENTER**  button.
Press the **EXIT** button to exit.
3. Press the **◀** or **▶** button to select "Reset All", "Reset Sound Mode" or "Cancel" then press the **ENTER**  button.
Press the **EXIT** button to exit.

- **Reset All:** All the sound values return to default settings.
- **Reset Sound Mode:** Current sound values return to default settings.
- **Cancel:** Select the sound reset options.

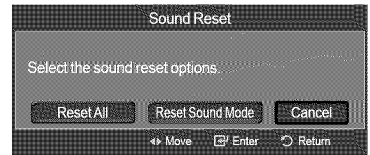
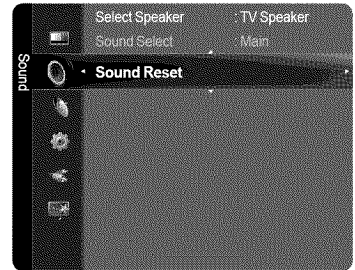

Connecting Headphones (Sold separately)

You can connect a set of headphones to your set if you wish to watch a TV program without disturbing other people in the room.

- When you insert the headphone's plug into the headphone jack, you can operate only "Preferred Language" (in digital TV mode), "Multi-Track Sound" (in analog TV mode), "Auto Volume", "Sound Select" (in PIP mode) and "Sound Reset" in Sound menu.
- Prolonged use of headphones at a high volume may damage your hearing.
- You will not hear sound from the speakers when you connect headphones to the TV.
- The headphone volume and TV volume are adjusted separately.

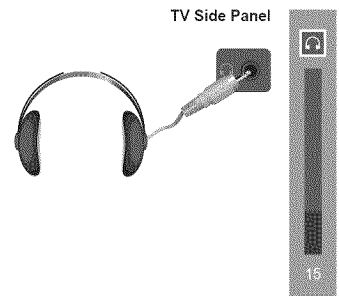

Channel Control



Managing Channels

Using this menu, you can Add/Delete or set Favorite channels and use the program guide for digital broadcasts.

Viewing All Channels

Show all currently available channels.

To use the Channel List function, first run "Auto Program" (see page 21).

1. Press the **MENU** button.
Press the **▲** or **▼** button to select "Channel", then press the **ENTER**  button.
Press the **▲** or **▼** button to select "Channel List", then press the **ENTER**  button.

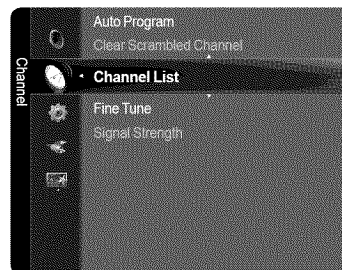

2. Press the **◀** button to select "Added Channels".



3. Press the **▲** or **▼** button to select "All Channels".

➤ Shows all currently available channels.

Press the **ENTER**  button.

4. Press the **▲** or **▼** button to select a channel to view, then press the **ENTER**  button. You can watch the selected channel.



 Press the **CH LIST** button on the remote control to bring up the channel lists.

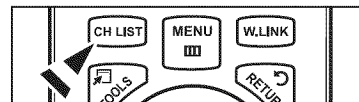

Using the Color buttons on the Remote with the Channel List



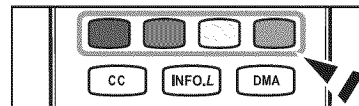



- **Red (Antenna):** Switches to Air or Cable.
- **Green (Zoom):** Enlarges or shrinks a channel number.
- **Yellow (Select):** Selects multiple channel lists.
- **TOOLS (Option):** Displays the "Add" (or "Delete"), "Add to Favorite"(or "Delete from Favorite"), "Timer Viewing", "Channel Name Edit", "Select All", "Deselect All" and "Auto Program" menus. (The Options menus may differ depending on the situation.)



- A gray-colored channel indicates the channel has been deleted.
The "Add" menu only appears for deleted channels.
- A channel marked with the "♥" mark means the channel has been set as a Favorite.
The "Delete from Favorite" menu only appears for channels with the "♥" mark.

Erasing and Adding Channels



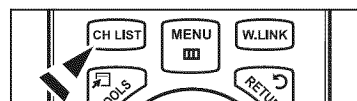
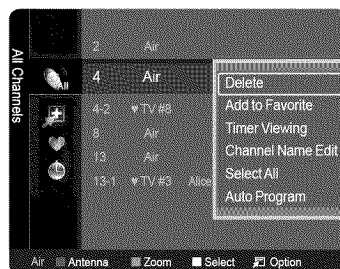
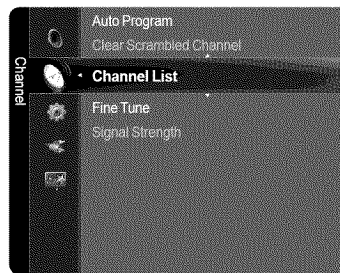

You can delete or add a channel to display the channels you want.

1. Press the **MENU** button.
Press the **▲** or **▼** button to select "Channel", then press the **ENTER**  button.
Press the **▲** or **▼** button to select "Channel List", then press the **ENTER**  button.
 2. Press the **◀** button to select "Added Channels".
 3. Press the **▲** or **▼** button to select "All Channels".
 - Shows all currently available channels.Press the **ENTER**  button.
 4. Press the **▲** or **▼** button to select a channel to delete, then press the **TOOLS** button.
 5. Press the **ENTER**  button to select "Delete".
 - All deleted channels will be shown on "All Channels" menu.
 6. Press the **EXIT** button to exit.
 - You can also delete a channel to the "Added Channels" menu in the same manner.
 - A channel must be deleted before it can be added back to the "Added Channels" list.
 - To Add (Restore) a channel back to the All Channel List, follow steps 1-3 above, press the **▲** or **▼** button to select a channel to add, then press the **TOOLS** button. Press the **ENTER**  button to select Add.
-  Press the **CH LIST** button on the remote control to bring up the channel lists.



Setting Your Favorite Channels

You can set channels you watch frequently as favorites.

1. Press the **MENU** button.
Press the **▲** or **▼** button to select "Channel", then press the **ENTER**  button.
Press the **▲** or **▼** button to select "Channel List", then press the **ENTER**  button.
2. Press the **◀** button to select "Added Channels".
3. Press the **▲** or **▼** button to select "All Channels".
➤ Shows all currently available channels.
Press the **ENTER**  button.
4. Press the **▲** or **▼** button to select a channel as a favorite channel.
➤ **Adding multiple channels to Favorites**
Press the **▲** or **▼** button to select the desired channel in the channel list. Then press the yellow button. Repeat the above operation to select multiple channels. The **✓** mark appears to the left of the selected channels.
5. Press the **TOOLS** button.
6. Press the **▲** or **▼** button to select "Add to Favorite", then press the **ENTER**  button. The "♥" symbol will be displayed and the channel will be set as a favorite.
7. To cancel your favorite channel selection, press the **TOOLS** button when a favorite channel is selected.
Press the **▲** or **▼** button to select "Delete from Favorite", then press the **ENTER**  button.
The channel is deleted from "Favorites" and the "♥" mark also disappears.
Press the **EXIT** button to exit.
➤ You can also Add or Delete a channel from Favorites in the "Added Channels" menu in the same manner.
➤ All favorite channels will be shown in the "Favorite" menu.

 Press the **CH LIST** button on the remote control to bring up the channel lists.

 To select the favorite channels you have set up, press the **FAV.CH** button on the remote control.

Easy Setting

1. Press the **TOOLS** button on the remote control.
2. Press the **▲** or **▼** button to select "Add to Favorite" ("Delete from Favorite"), then press the **ENTER**  button.
➤ The current channel is added to (or deleted from) Favorites.

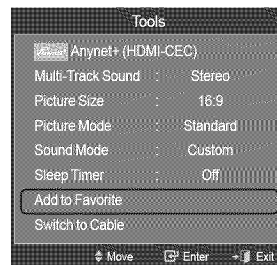
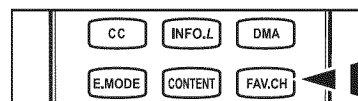
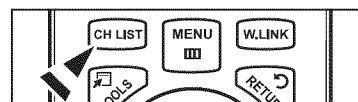
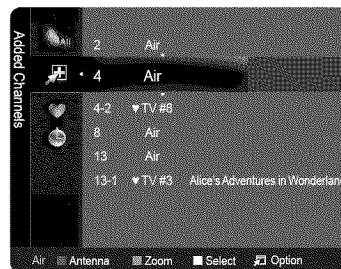

Reserving a Program (Timer Viewing)

If you reserve a program you want to watch, the channel is automatically switched to the reserved channel in the Channel List; even when you are watching another channel.

To reserve a program, set the current time first. See pages 58~59. Reserved channels can only be set if they are in the "Channel List" (See page 50).

1. Press the **MENU** button.
Press the **▲** or **▼** button to select "Channel", then press the **ENTER** button.
Press the **▲** or **▼** button to select "Channel List", then press the **ENTER** button.

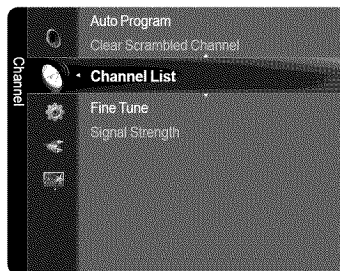

2. Press the **▲** or **▼** button to select a channel, then press the **TOOLS** button.

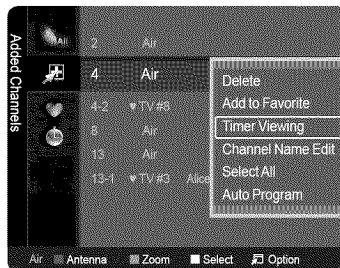

3. Press the **▲** or **▼** button to select "Timer Viewing", then press the **ENTER** button. The Reserve a Program (Timer Viewing) screen appears.

4. Press the **▲/▼/◀/▶** buttons to reserve a program and then press the **ENTER** button. Reserving a program has been completed.

Press the **EXIT** button to exit.

- You can also reserve a program in the "All Channels" or "Favorite" menus using the same procedures.
- For information on how to confirm a viewing reservation, refer to page 50. Only memorized channels can be reserved.
- You can set the channel, month, day, year, hour and minute directly by pressing the number buttons on the remote control.

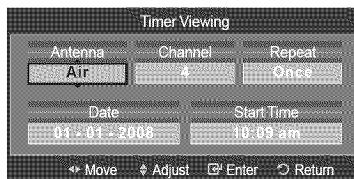

- ☞ Press the **CH LIST** button on the remote control to bring up the channel lists.

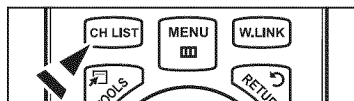

Digital Program Guide and Viewing Reservation

When a digital channel is selected, and you press the **▶** button, the Program Guide for the channel appears. You can reserve a program according to the procedures described above.

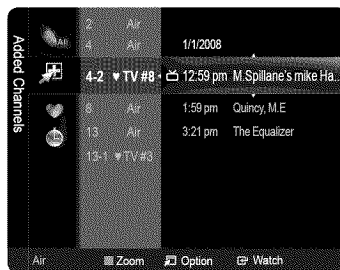

☞ : A program currently being broadcast.

Ⓢ : A reserved program





Confirming a Viewing Reservation

You can view, modify or delete a reservation.

1. Press the **MENU** button.
Press the **▲** or **▼** button to select "Channel", then press the **ENTER**  button.
Press the **▲** or **▼** button to select "Channel List", then press the **ENTER**  button.
2. Press the **◀** button to select "Added Channels".
3. Press the **▲** or **▼** button to select "Programmed".
➤ Shows all current reserved programs.
Press the **ENTER**  button.



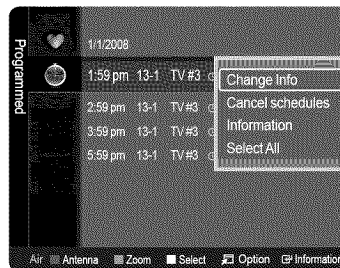

Modifying a viewing reservation

4. To select a reservation item to be modified, press the **▲** or **▼** button and then press the **TOOLS** button.
5. Press the **ENTER**  button to select "Change Info".
6. Press the **▲/▼/◀/▶** buttons to change a reservation setting and then press the **ENTER**  button. The reservation modification is applied.



Canceling a reservation

4. To select a reservation item to be canceled, press the **▲** or **▼** button, and then press the **TOOLS** button.
5. Press the **▲** or **▼** button to select "Cancel schedules", then press the **ENTER**  button.
6. Press the **◀** or **▶** button to select "OK", then press the **ENTER**  button. The viewing reservation has been canceled.
Press the **EXIT** button to exit.

Programmed Option

- **Change Info:** Select to change a viewing reservation.
- **Cancel schedules:** Select to cancel a viewing reservation.
- **Information:** Select to view a viewing reservation.
- **Select All:** Select all reserved programs.

-  Press the **CH LIST** button on the remote control to bring up the channel lists.

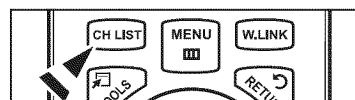

Labeling Channels - Analog

Channels can be labeled so that their call letters appear whenever the channel is selected.

1. Press the **MENU** button.
Press the **▲** or **▼** button to select "Channel", then press the **ENTER** button.
Press the **▲** or **▼** button to select "Channel List", then press the **ENTER** button.

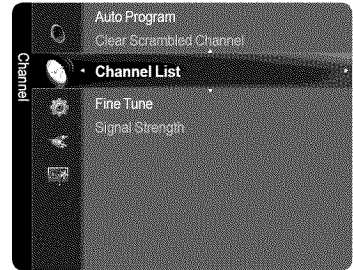

2. Press the **▲** or **▼** button to select the channel to be assigned a new name, then press the **TOOLS** button.

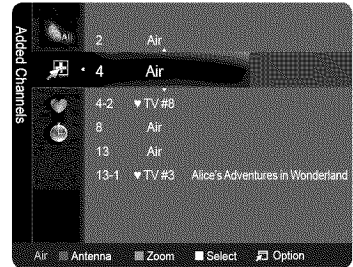

3. Press the **▲** or **▼** button to select "Channel Name Edit", then press the **ENTER** button.

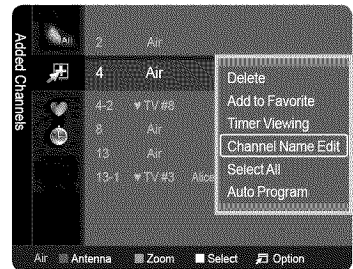



4. Press the **▲/▼/◀/▶** button to select a letter, then press the **ENTER** button.

- **Numeric buttons:** You can enter numbers.
- **Red button:** You can switch between English and Characters.
- **Green button:** You can delete an already entered character.
- **Yellow button:** You can enter a blank space.
- **Blue button:** Press this button to finish renaming a channel.





5. When you have finished, press the blue button to assign the new name.
Press the **EXIT** button to exit.
➤ The names of digital broadcasting channels are automatically assigned and cannot be labeled.

Selecting and Deselecting All Channels

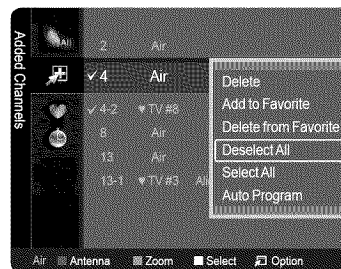
1. Press the **MENU** button.
Press the ▲ or ▼ button to select "Channel", then press the **ENTER**  button.
Press the ▲ or ▼ button to select "Channel List", then press the **ENTER**  button.
2. Press the ▲ or ▼ button to select a channel, then press the **TOOLS** button.
3. Press the ▲ or ▼ button to select "Select All" or "Deselect All", then press the **ENTER**  button.
 - You can select(or Deselect) all channel in the channel list.
 - The ✓ mark appears to the left of the selected channels.



Storing Channels in Memory (Auto Program)

1. Press the **MENU** button.
Press the ▲ or ▼ button to select "Channel", then press the **ENTER**  button. Press the ▲ or ▼ button to select "Channel List", then press the **ENTER**  button.
2. Press the ▲ or ▼ button to select a channel, then press the **TOOLS** button.
3. Press the ▲ or ▼ button to select "Auto Program", then press the **ENTER**  button.
 - For further details on setting up options, refer to page 21.

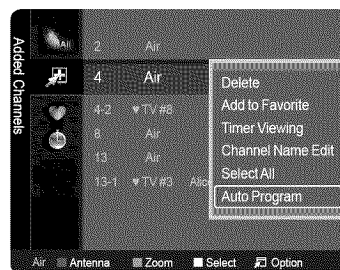

Clearing Scrambled Channels - Digital

The "Clear Scrambled Channel" function is used to filter out scrambled channels after "Auto Program" is completed. This process may take up to 20~30 minutes.

1. Press the **MENU** button to display the menu. Press the **▲** or **▼** button to select "Channel", then press the **ENTER** button.
2. Press the **▲** or **▼** button to select "Clear Scrambled Channel", then press the **ENTER** button. It searches scrambled channels, which are to be removed from the list.
 - > To stop searching scrambled channels; Press the **ENTER** button to select "Stop". Press the **◀** button to select "Yes", then press the **ENTER** button.
3. When the scrambled channel searching is completed, press the **ENTER** button. Press the **EXIT** button to exit.
 - > This function is only available in "Cable" mode.

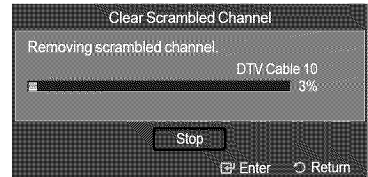
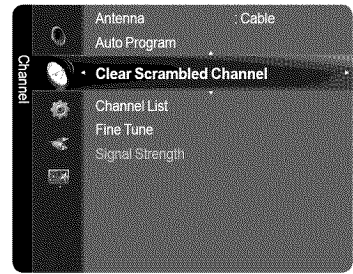

Fine Tuning Analog Channels

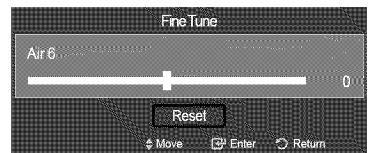
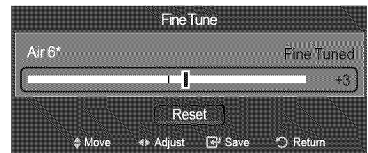
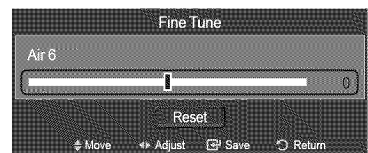

Use fine tuning to manually adjust a particular channel for optimal reception.

1. Press the **MENU** button to display the menu. Press the **▲** or **▼** button to select "Channel", then press the **ENTER** button.
2. Press the **▲** or **▼** button to select "Fine Tune", then press the **ENTER** button.
3. Press the **◀** or **▶** button to adjust the fine tuning. To store the fine tuning setting in the TV's memory, press the **ENTER** button.
 - > If you do not store the fine-tuned channel in memory, adjustments are not saved.
4. To reset the fine tuning setting, press the **▼** button to select "Reset", then press the **ENTER** button. Press the **EXIT** button to exit.
 - > "*" will appear next to the name of fine-tuned channels.
 - > Only analog TV channels can be fine tuned.



Checking the Digital-Signal Strength

Unlike analog channels, which can vary in reception quality from “snowy” to clear, digital (HDTV) channels have either perfect reception quality or you will not receive them at all. So, unlike analog channels, you cannot fine tune a digital channel. You can, however, adjust your antenna to improve the reception of available digital channels.

1. Press the **MENU** button to display the menu. Press the **▲** or **▼** button to select “Channel”, then press the **ENTER**  button.
2. Press the **▲** or **▼** button to select “Signal Strength”, then press the **ENTER**  button.

If the signal strength meter indicates that the signal is weak, physically adjust your antenna to increase the signal strength.

Continue to adjust the antenna until you find the best position with the strongest signal.

Press the **EXIT** button to exit.

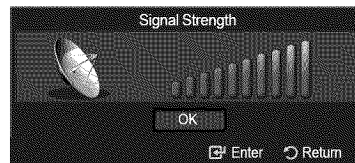
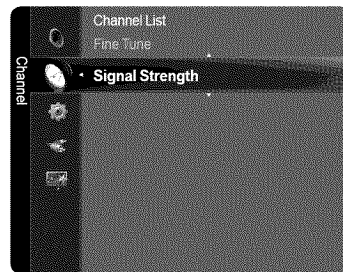

PC Display

Using Your TV as a Computer (PC) Display

Setting Up Your PC Software (Based on Windows XP)

The Windows display-settings for a typical computer are shown below. The actual screens on your PC will probably be different, depending upon your particular version of Windows and your particular video card. However, even if your actual screens look different, the same basic set-up information will apply in almost all cases. (If not, contact your computer manufacturer or Samsung Dealer.)

1. First, click on "Control Panel" on the Windows start menu.
2. When the control panel window appears, click on "Appearance and Themes" and a display dialog-box will appear.
3. When the control panel window appears, click on "Display" and a display dialog-box will appear.
4. Navigate to the "Settings" tab on the display dialog-box.

The correct size setting (resolution)

Optimum: 1920 X 1080 pixels

If a vertical-frequency option exists on your display settings dialog box, the correct value is "60" or "60 Hz". Otherwise, just click "OK" and exit the dialog box.

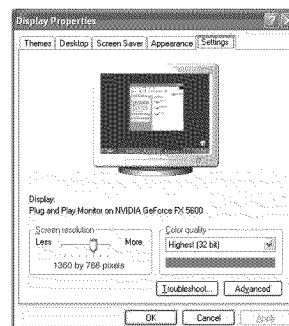

Display Modes

If the signal from the system equals the standard signal mode, the screen is adjusted automatically. If the signal from the system doesn't equal the standard signal mode, adjust the mode by referring to your videocard user guide; otherwise there may be no video. For the display modes listed below, the screen image has been optimized during manufacturing.

D-Sub Input

Mode	Resolution	Horizontal Frequency (kHz)	Vertical Frequency (Hz)	Pixel Clock Frequency (MHz)	Sync Polarity (H/V)
IBM	640 x 350	31.469	70.086	25.175	+ / -
	720 x 400	31.469	70.087	28.322	- / +
VESA	640 x 480	31.469	59.940	25.175	- / -
	640 x 480	37.861	72.809	31.500	- / -
	640 x 480	37.500	75.000	31.500	- / -
	800 x 600	37.879	60.317	40.000	+ / +
	800 x 600	48.077	72.188	50.000	+ / +
	800 x 600	46.875	75.000	49.500	+ / +
	1024 x 768	48.363	60.004	65.000	- / -
	1024 x 768	56.476	70.069	75.000	- / -
	1024 x 768	60.023	75.029	78.750	+ / +
	1280 x 1024	63.981	60.020	108.000	+ / +
	1280 x 1024	79.976	75.025	135.000	+ / +
1360 x 768	47.712	60.015	85.500	+ / +	
1600 x 1200	75.000	60.000	162.000	+ / +	
CVT	1920 x 1080RB	66.587	59.934	138.500	+ / -



HDMI/DVI Input

Mode	Resolution	Horizontal Frequency (kHz)	Vertical Frequency (Hz)	Pixel Clock Frequency (MHz)	Sync Polarity (H/V)
VESA	640 x 480	31.469	59.940	25.175	- / -
	800 x 600	37.879	60.317	40.000	+ / +
	1024 x 768	48.363	60.004	65.000	- / -
	1280 x 1024	63.981	60.020	108.000	+ / +
	1360 x 768	47.712	60.015	85.500	+ / +
1600 x 1200	75.000	60.000	162.000	+ / +	
CEA	1920 x 1080p	67.500	60.000	148.500	+ / +

Setting up the TV with your PC

How to Auto Adjust

Use the Auto "Adjust" function to have the TV set automatically adjust the video signals it receives. The function also automatically fine-tunes the settings and adjusts the frequency values and positions.

- > This function does not work in DVI-Digital mode.
 - > Preset: Press the **SOURCE** button to select PC mode.
1. Press the **MENU** button to display the menu. Press the **▲** or **▼** button to select "Picture", then press the **ENTER**  button.
 2. Press the **▲** or **▼** button to select "Auto Adjustment", then press the **ENTER**  button. Press the **EXIT** button to exit.

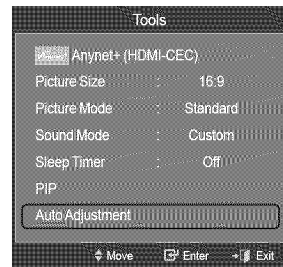
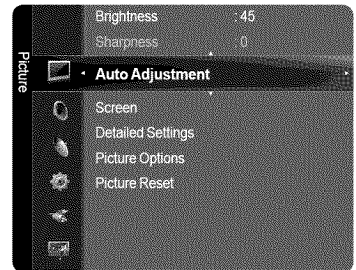
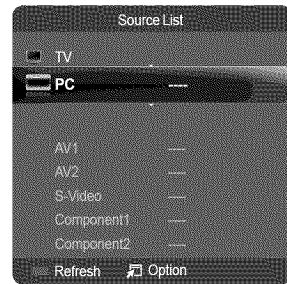





Easy Setting

1. Press the **TOOLS** button on the remote control.
2. Press the **▲** or **▼** button to select "Auto Adjustment", then press the **ENTER**  button.

Adjusting the Screen Quality



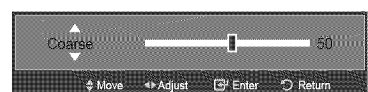
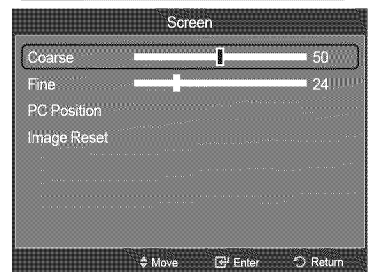
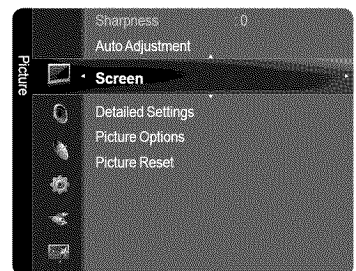

The purpose of the picture quality adjustment is to remove or reduce picture noise. If the noise is not removed by fine tuning alone, then make the vertical frequency adjustments on your PC and fine tune again. After the noise has been reduced, re-adjust the picture so that it is aligned on the center of the screen.

- > Preset: Press the **SOURCE** button to select PC mode.
1. Press the **MENU** button to display the menu. Press the **▲** or **▼** button to select "Picture", then press the **ENTER**  button.
 2. Press the **▲** or **▼** button to select "Screen", then press the **ENTER**  button.
 3. Press the **▲** or **▼** button to select "Coarse" or "Fine", then press the **ENTER**  button. Press the **◀** or **▶** button to adjust the screen quality.
 - > Vertical stripes may appear or the picture may be blurry. Press the **ENTER**  button. Press the **EXIT** button to exit.



Changing the Screen Position

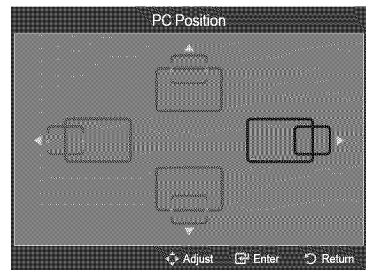
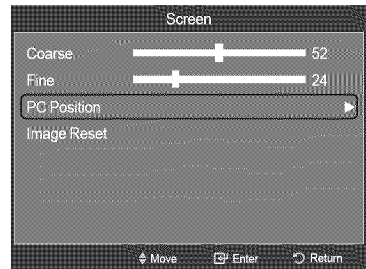
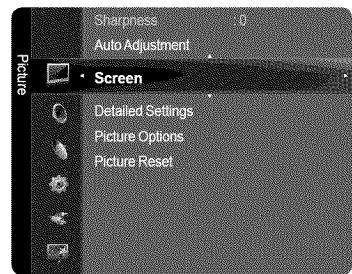

Adjust the PC's screen positioning if it does not fit the TV screen.

- Preset: Press the **SOURCE** button to select PC mode.
- 1.** Press the **MENU** button to display the menu.
Press the **▲** or **▼** button to select "Picture", then press the **ENTER**  button.
- 2.** Press the **▲** or **▼** button to select "Screen", then press the **ENTER**  button.
- 3.** Press the **▲** or **▼** button to select "PC Position", then press the **ENTER**  button.
- 4.** Press the **▲** or **▼** button to adjust the V-Position.
Press the **◀** or **▶** button to adjust the H-Position.
Press the **ENTER**  button.
Press the **EXIT** button to exit.



Initializing the Screen Position, Coarse and Fine

You can replace all image settings with the factory default values.

- Preset: Press the **SOURCE** button to select PC mode.
- 1.** Press the **MENU** button to display the menu.
Press the **▲** or **▼** button to select "Picture", then press the **ENTER**  button.
- 2.** Press the **▲** or **▼** button to select "Screen", then press the **ENTER**  button.
- 3.** Press the **▲** or **▼** button to select "Image Reset", then press the **ENTER**  button.
Press the **EXIT** button to exit.

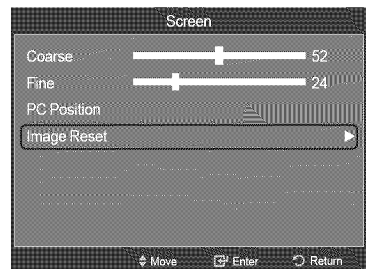
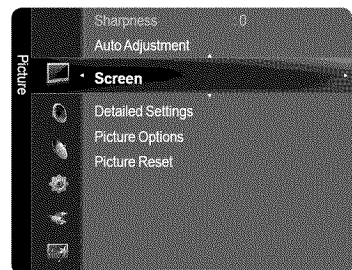

Time Setting

Setting the Clock

Setting the clock is necessary in order to use the various timer features of the TV. Also, you can check the time while watching the TV. (Just press the **INFO** button.)

Option 1: Setting the Clock Manually

1. Press the **MENU** button to display the menu.
Press the **▲** or **▼** button to select "Setup", then press the **ENTER** button.
Press the **▲** or **▼** button to select "Time", then press the **ENTER** button.



2. Press the **ENTER** button to select "Clock".



3. Press the **ENTER** button to select "Clock Mode".
Press the **▲** or **▼** button to select "Manual", then press the **ENTER** button.

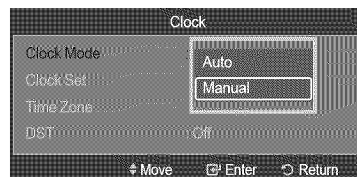

4. Press the **▲** or **▼** button to select "Clock Set", then press the **ENTER** button.

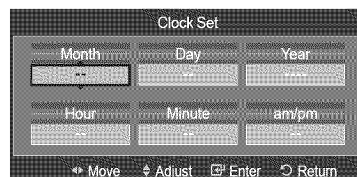

5. Press the **◀** or **▶** button to move to "Month", "Day", "Year", "Hour", "Minute", or "am/pm". Set the date and time you want by pressing the **▲** or **▼** button, then press the **ENTER** button.
Press the **EXIT** button to exit.
 - > The current time will appear every time you press the **INFO** button.
 - > You can set the month, day, year, hour and minute directly by pressing the number buttons on the remote control.

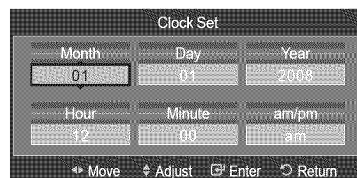

Option 2: Setting the Clock Automatically

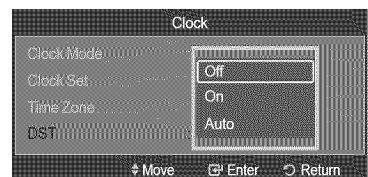
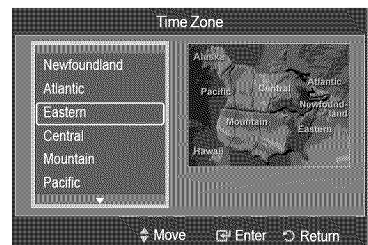
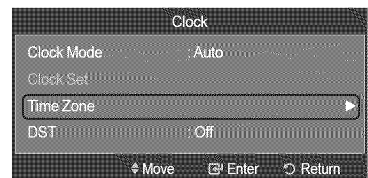
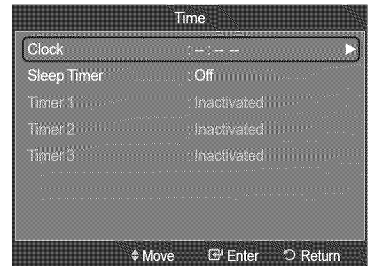
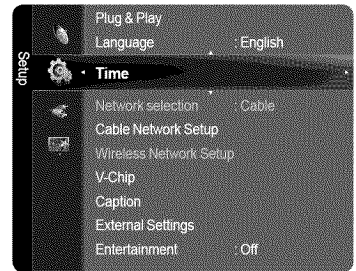

The Clock can be set automatically if you are receiving a digital signal.

1. Press the **MENU** button to display the menu.
Press the **▲** or **▼** button to select "Setup", then press the **ENTER** button.
Press the **▲** or **▼** button to select "Time", then press the **ENTER** button.
2. Press the **ENTER** button to select "Clock".
3. Press the **ENTER** button to select "Clock Mode".
Press the **▲** or **▼** button to select "Auto", then press the **ENTER** button.
4. Press the **▲** or **▼** button to select "Time Zone", then press the **ENTER** button.
5. Press the **▲** or **▼** button to highlight the time zone for your local area, then press the **ENTER** button.
6. Press the **▲** or **▼** button to select "DST" (Daylight Saving Time), then press the **ENTER** button. Press the **▲** or **▼** button to select "Off", "On" or "Auto", then press the **ENTER** button.
Press the **EXIT** button to exit.
 - Depending on the broadcast station and signal, the auto time may not be set correctly. If this occurs, set the time manually.
 - The Antenna or cable must be connected in order to set the time automatically.





Setting the Sleep Timer

The sleep timer automatically shuts off the TV after a preset time (30, 60, 90, 120, 150 and 180 minutes).

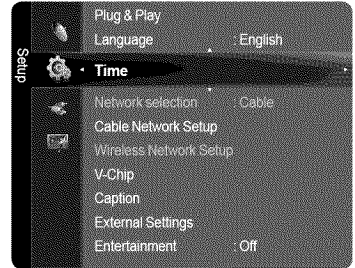
1. Press the **MENU** button to display the menu.
Press the **▲** or **▼** button to select "Setup", then press the **ENTER**  button.
Press the **▲** or **▼** button to select "Time", then press the **ENTER**  button.



2. Press the **▲** or **▼** button to select "Sleep Timer", then press the **ENTER**  button.

3. Press the **▲** or **▼** button to select the minute, then press the **ENTER**  button.

To cancel the set sleep timer:

Press the **▲** or **▼** button to select "Off", then press the **ENTER**  button.

4. Press the **EXIT** button to exit.

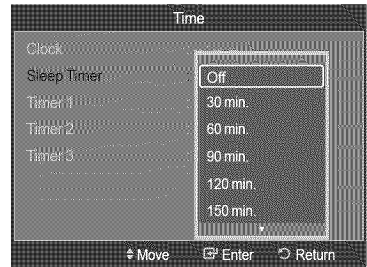

Easy Setting

1. Press the **TOOLS** button on the remote control.
2. Press the **▲** or **▼** button to select "Sleep Timer".
3. Press the **◀** or **▶** button to select the minute.
4. Press the **EXIT** or **TOOLS** button to exit.

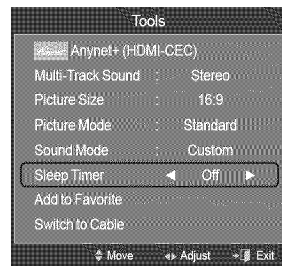

Setting the On/Off Timer

1. Press the **MENU** button to display the menu.
Press the **▲** or **▼** button to select "Setup", then press the **ENTER** button.
Press the **▲** or **▼** button to select "Time", then press the **ENTER** button.



2. Three different On/Off Timer Settings can be made.
Press the **▲** or **▼** button to select "Timer 1", "Timer 2" or "Timer 3", then press the **ENTER** button.

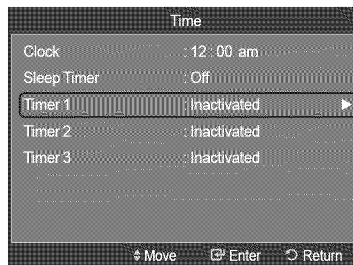

3. Press the **◀** or **▶** button to select the desired item below.
Press the **▲** or **▼** button to adjust the setting.

- **On Time:** Set the Hour, Minute, am/pm, and Activation/Inactivation. (To activate timer with the setting you've chosen, set to "Activate".)
- **Off Time:** Set the Hour, Minute, am/pm, and Activation/Inactivation. (To activate timer with the setting you've chosen, set to "Activate".)
- **Volume:** Set the desired volume level.
- **Contents:** When the "On Time" is active, you can turn on a specific channel or play back contents such as photo or audio files.
 - TV/USB: Select TV or USB. (Make sure that an USB device is connected to your TV.)
 - Antenna: Select "Air" or "Cable".
 - Channel: Select the desired channel.
 - Music: Select the folder containing MP3 files on the USB device.
 - Photo: Select the folder containing JPEG files on the USB device.
- **Repeat:** Select "Once", "Everyday", "Mon~Fri", "Mon~Sat", "Sat~Sun", or "Manual".
 - When "Manual" is selected, press the **▶** button to select the desired day of the week. Press the **ENTER** button over the desired day and the **✓** mark will appear.

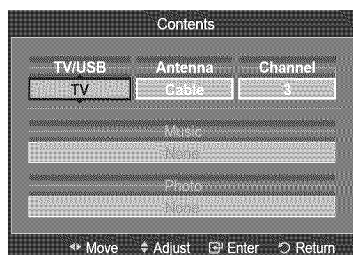
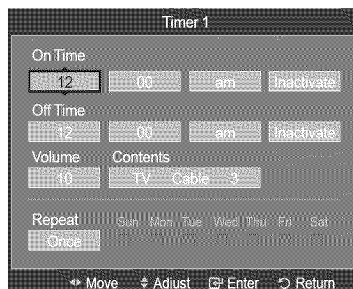

Press the **EXIT** button to exit.

- You can set the hour, minute and channel by pressing the number buttons on the remote control.
- **Auto Power Off**
When you set the timer On, the television will eventually turn off, if no controls are operated for 3 hours after the TV was turned on by the timer. This function is only available in timer On mode and prevents overheating, which may occur if a TV is on for too long time.
- When executing automatic power- on with scheduling a time and 2 USB devices that have same manufacturer and folder name one another are simultaneously connected, Other USB device can be read.

Function Description

Selecting a Menu Language

1. Press the **MENU** button to display the menu. Press the **▲** or **▼** button to select "Setup", then press the **ENTER** button. Press the **▲** or **▼** button to select "Language", then press the **ENTER** button.
2. Press the **▲** or **▼** button to select "English", "Español" or "Français". Press the **ENTER** button. Press the **EXIT** button to exit.



Using the V-Chip

The V-Chip feature automatically locks out programs that are deemed inappropriate for children. The user must enter a PIN (personal ID number) before any of the V-Chip restrictions are set up or changed.

- > "V-Chip" function is not available in HDMI, Component or PC mode.

U.S.A Only

This product is covered by the following U.S.patents: US4, 930, 158, US4, 930, 160.

Setting Up Your Personal ID Number (PIN)

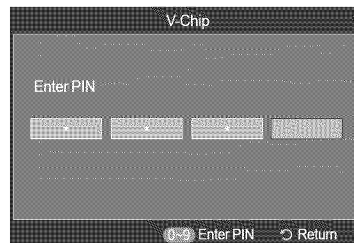
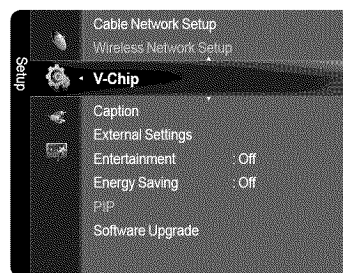

1. Press the **MENU** button to display the menu. Press the **▲** or **▼** button to select "Setup", then press the **ENTER** button.
2. Press the **▲** or **▼** button to select "V-Chip", then press the **ENTER** button. The message "Enter PIN" will appear. Enter your 4 digit PIN number.
 - > The default PIN number of a new TV set is "0-0-0-0".



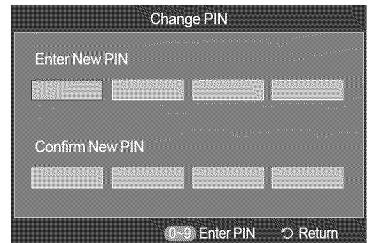

- The "V-Chip" screen will appear. Press the **▲** or **▼** button to select "Change PIN", then press the **ENTER**  button. The Change PIN screen will appear. Choose any 4 digits for your PIN and enter them. As soon as the 4 digits are entered, the "Confirm New PIN" screen appears. Re-enter the same 4 digits. When the Confirm screen disappears, your PIN has been memorized. Press the **EXIT** button to exit.
 - If you forget the PIN, press the remote-control buttons in the following sequence, which resets the pin to 0-0-0-0 : Power Off. → Mute → 8 → 2 → 4 → Power On.

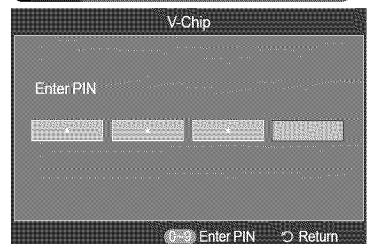
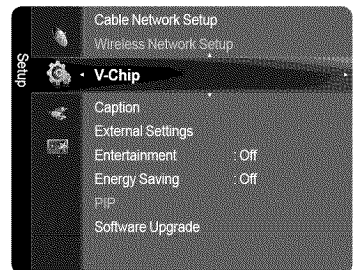

How to Enable/Disable the V-Chip

- Press the **MENU** button to display the menu. Press the **▲** or **▼** button to select "Setup", then press the **ENTER**  button.
- Press the **▲** or **▼** button to select "V-Chip", then press the **ENTER**  button. The message "Enter PIN" will appear. Enter your 4 digit PIN number.



- The "V-Chip" screen will appear. To enable the V-Chip feature, press the **ENTER**  button so that the "V-Chip Lock" field is "On". (Pressing the **▲** or **▼** button will alternate between "On" and "Off".) Press the **ENTER**  button. Press the **EXIT** button to exit.



How to Set up Restrictions Using the TV Parental Guidelines

First, set up a personal identification number (PIN) and enable the V-Chip. (See previous section.) Parental restrictions can be set up using either of two methods: The TV guidelines or the MPAA rating.

1. Press the **MENU** button to display the menu.
Press the **▲** or **▼** button to select "Setup", then press the **ENTER** button.
2. Press the **▲** or **▼** button to select "V-Chip", then press the **ENTER** button. The message "Enter PIN" will appear. Enter your 4 digit PIN number.
3. The "V-Chip" screen will appear. Press the **▲** or **▼** button to select "TV Parental Guidelines", then press the **ENTER** button.
4. The "TV Parental Guidelines" screen will appear.
Press the **▲** or **▼** button to select one of the six aged based categories:

• TV-Y: Young children	• TV-PG: Parental guidance
• TV-Y7: Children 7 and over	• TV-14: Viewers 14 and over
• TV-G: General audience	• TV-MA: Mature audience

5. At this point, one of the TV-Ratings is selected.

Press the **ENTER** button. Depending on your existing setup, the " " symbol will be selected. (Blank = Unblocked, = Blocked)

While " " is selected, press the **ENTER** button to block or unblock the category. To select a different TV-Rating, press the **▲** or **▼** button and then repeat the process.

- Allow all: Press to unlock all TV ratings.
Block all: Press to lock all TV ratings.
- The TV-Y, TV-Y7, TV-G, TV-PG, TV-14 and TV-MA have additional options. See the next step to change any of the following sub-ratings: ALL / FV / V / S / L / D
- The V-Chip will automatically block certain categories that are "more restrictive". For example, if you block "TV-Y" category, then TV-Y7 will automatically be blocked. Similarly, if you block the TV-G category, then all the categories in the "young adult" group will be blocked (TV-G, TV-PG, TV-14 and TV-MA). The sub-ratings (D, L, S, V) work together similarly. (See next section.)

6. How to set the FV, D, L, S and V sub-ratings.

First, select one of these TV-Ratings: TV-Y, TV-Y7, TV-G, TV-PG, TV-14 or TV-MA (See Step 4) and press the **▶** button.

The " " symbol will be displayed for each sub-rating. While " " is selected, press the **ENTER** button to go to a sub rating. Press **ENTER** to block the sub rating. To select a different TV-Rating, press the **▲** or **▼** button and then repeat the process.

• ALL: Lock all TV ratings.	• S: Sexual situation
• FV: Fantasy violence	• L: Adult Language
• V: Violence	• D: Sexually Suggestive Dialog

- The V-chip will automatically block certain categories that are "More restrictive". For example, if you block "L" sub-rating in TV-PG, then the "L" sub-ratings in TV-14 and TV-MA will automatically be blocked.

7. Press the **EXIT** button to clear all the screens. (Or proceed to the next section, and set up additional restrictions based on the MPAA codes.)
 - These categories consist of two separate groups: TV-Y and TV-Y7 (young children through age 7) and TV-G through TV-MA (everybody else). The restrictions for these two groups work independently: If a household includes very young children as well as young adults, the TV guidelines must be set up separately for each age group. (See next step.)

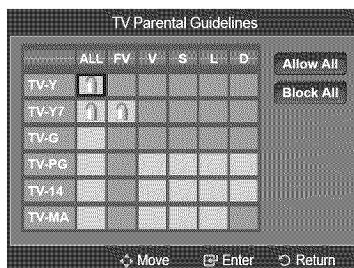
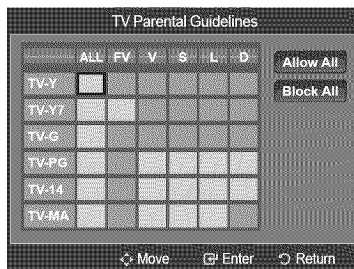
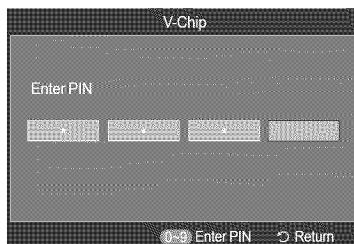
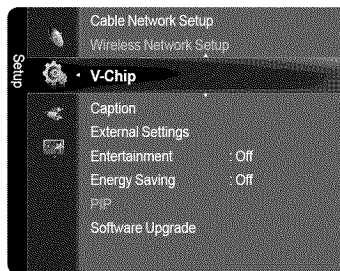

How to Set up Restrictions Using the MPAA Ratings: G, PG, PG-13, R, NC-17, X, NR

The MPAA rating system uses the Motion Picture Association of America (MPAA) system and its main application is for movies. When the V-Chip lock is on, the TV will automatically block any programs that are coded with objectionable ratings (either MPAA or TV-Ratings).

1. Press the **MENU** button to display the menu.
Press the **▲** or **▼** button to select "Setup", then press the **ENTER** button.

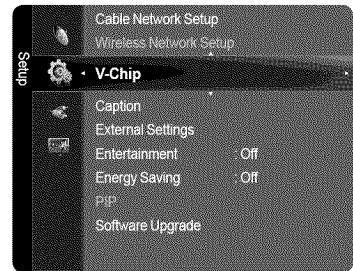

2. Press the **▲** or **▼** button to select "V-Chip", then press the **ENTER** button.

The message "Enter PIN" will appear. Enter your 4 digit PIN number.

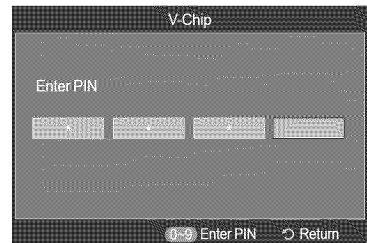

3. The "V-Chip" screen will appear. Press the **▲** or **▼** button to select "MPAA Rating", then press the **ENTER** button.



4. The "MPAA Rating" screen will appear. Repeatedly press the **▲** or **▼** button to select a particular MPAA category. Pressing the **▲** or **▼** button will cycle through the MPAA categories:

- **G**: General audience (no restrictions).
- **PG**: Parental guidance suggested.
- **PG-13**: Parents strongly cautioned.
- **R**: Restricted. Children under 17 should be accompanied by an adult.
- **NC-17**: No children under age 17.
- **X**: Adults only.
- **NR**: Not rated.

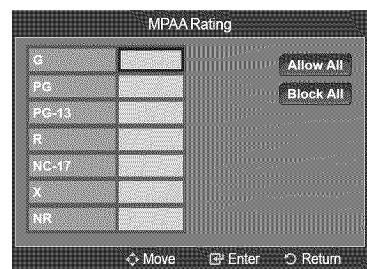

- > Allow all: Press to unlock all TV ratings.
Block all: Press to lock all TV ratings.
- > While a particular category is selected, press the **ENTER** button to activate it. The "🔒" symbol will be displayed. Press the **ENTER** button to block or unblock the category.
- > The V-Chip will automatically block any category that is "More restrictive". For example, if you block the "PG-13" category, then "R", "NC-17" and "X" will automatically be blocked also.

Press the **EXIT** button to exit.

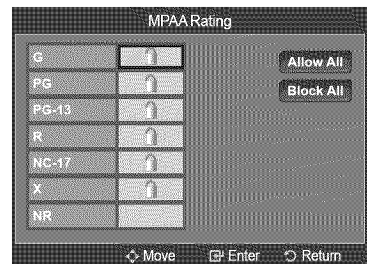

How to Set up Restrictions Using the Canadian English

1. Press the **MENU** button to display the menu.
Press the **▲** or **▼** button to select "Setup", then press the **ENTER** button.

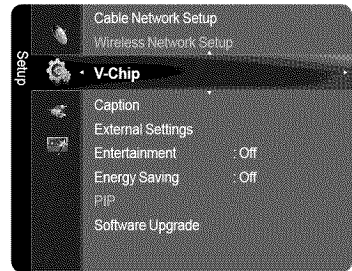

2. Press the **▲** or **▼** button to select "V-Chip", then press the **ENTER** button.
The message "Enter PIN" will appear. Enter your 4 digit PIN number.

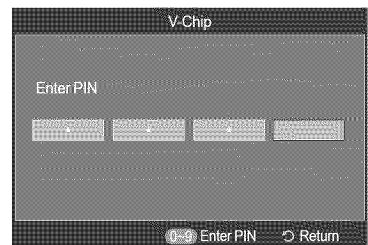

3. The "V-Chip" screen will appear. Press the **▲** or **▼** button to select "Canadian English", then press the **ENTER** button.



4. Press the **▲** or **▼** button to select a appropriate restriction.
Press the **ENTER** button to activate the restriction selected. The "🔒" symbol is indicated.

Press the **EXIT** button to exit.

- > Allow all: Press to unlock all TV ratings.
- Block all: Press to lock all TV ratings.

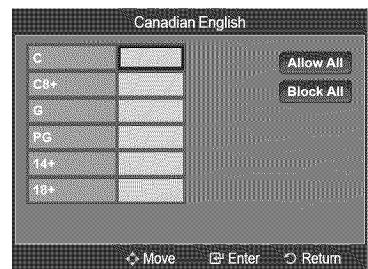

- **C**: Programming intended for children under age 8.
- **C8+**: Programming generally considered acceptable for children 8 years and over to watch on their own.
- **G**: General programming, suitable for all audiences.
- **PG**: Parental Guidance.
- **14+**: Programming contains themes or content which may not be suitable for viewers under the age of 14.
- **18+**: Adult programming.

- > The V-Chip will automatically block any category that is "More restrictive". For example, if you block G category, then PG, 14+ and 18+ will automatically be blocked also.

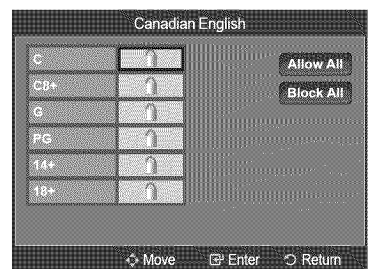

How to Set up Restrictions Using the Canadian French

1. Press the **MENU** button to display the menu.
Press the **▲** or **▼** button to select "Setup", then press the **ENTER** button.

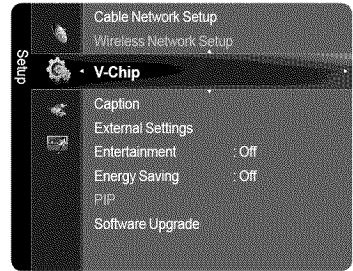

2. Press the **▲** or **▼** button to select "V-Chip", then press the **ENTER** button.
The message "Enter PIN" will appear. Enter your 4 digit PIN number.

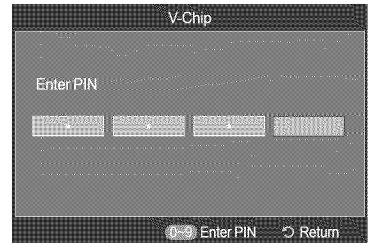

3. The "V-Chip" screen will appear. Press the **▲** or **▼** button to select "Canadian French", then press the **ENTER** button.



4. Press the **▲** or **▼** button to select an appropriate restriction. Press the **ENTER** button to activate the restriction selected. The "🔒" symbol is indicated.

Press the **EXIT** button to exit.

- Allow all: Press to unlock all TV ratings.
- Block all: Press to lock all TV ratings.

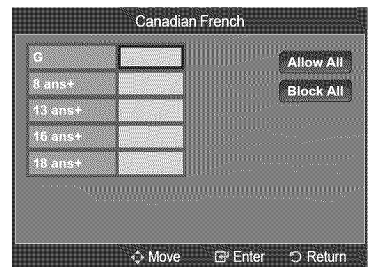

- **G**: General
- **8 ans+**: Programming generally considered acceptable for children 8 years and over to watch on their own.
- **13 ans+**: Programming may not be suitable for children under the age of 13.
- **16 ans+**: Programming is not suitable for children under the age of 16.
- **18 ans+**: Programming restricted to adults.

- The V-Chip will automatically block any category that is "More restrictive". For example, if you block 8 ans+ category, then 13 ans+, 16 ans+ and 18 ans+ will automatically be blocked also.

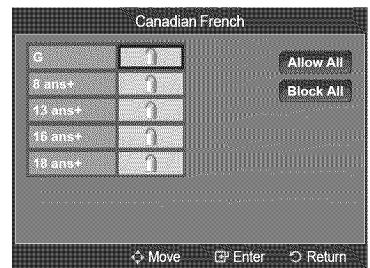

Using the V-Chip for Digital channels

Parental restriction information can be used while watching DTV channels.

- Press the **MENU** button to display the menu.
Press the **▲** or **▼** button to select "Setup", then press the **ENTER** button.
- Press the **▲** or **▼** button to select "V-Chip", then press the **ENTER** button.
The message "Enter PIN" will appear. Enter your 4 digit PIN number.
- The "V-Chip" screen will appear. Press the **▲** or **▼** button to select "Downloadable U.S. Rating", then press the **ENTER** button.
 - If information is not downloaded from the broadcasting station, the Downloadable U.S. rating menu is deactivated.
 - Parental restriction information is automatically downloaded while watching DTV channels. It may take several seconds.
 - The Downloadable U.S. rating menu is available for use after information is downloaded from the broadcasting station. However, depending on the information from the broadcasting station, it may not be available for use.
- Press the **▲** or **▼** button to select a appropriate restriction. Press the **ENTER** button to activate the restriction selected. The "🔒" symbol is indicated.
Press the **EXIT** button to exit.
 - Allow all: Press to unlock all TV ratings.
Block all: Press to lock all TV ratings.
 - Parental restriction levels differ depending on the broadcasting station.
 - The default menu name and Downloadable US rating changes depending on the downloaded information.
 - Even if you set the On-screen display to your desired language, the "Downloadable U.S. Rating" menu will appear in English only.
 - The rating will automatically block certain categories that are more restrictive.
 - The rating titles (For example: Humor Level..etc) and TV ratings (For example: DH, MH, H..etc) may differ depending on the broadcasting station.

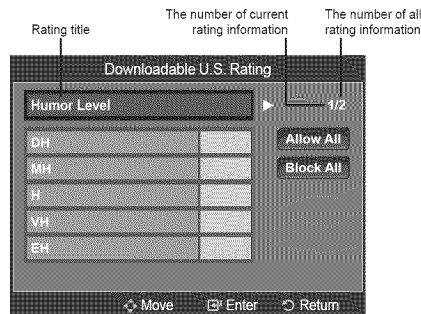
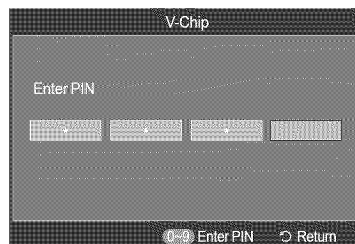
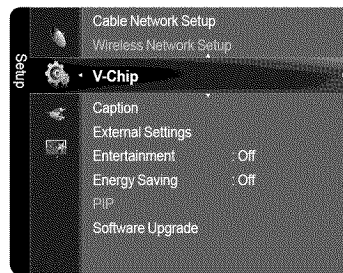

How to Reset the TV after the V-Chip Blocks a Channel ("Emergency Escape")

If the TV is tuned to a restricted channel, the V-Chip will block it. The screen will go blank and the following message will appear:

- Enter your PIN.
To resume normal viewing, tune to a different channel using **CH ▼** or **CH ▲** button. Under certain conditions (depending on the rating of the local TV programs) the V-Chip might lock out all the channels. In this case, use the V-Chip function for an "emergency escape":
 - If you forget the PIN, press the remote-control buttons in the following sequence, which resets the pin to 0-0-0-0 : Power Off. → MUTE → 8 → 2 → 4 → Power On.



Viewing Closed Captions (On-Screen Text Messages) - Analog

The Analog Caption function operates in either analog TV channel mode or when a signal is supplied from an external device to TV. (Depending on the broadcasting signal, the Analog Caption function may operate on digital channels.)

1. Press the **MENU** button to display the menu.
Press the **▲** or **▼** button to select "Setup", then press the **ENTER** button.

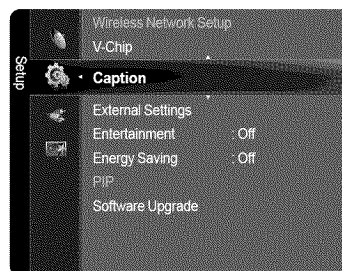

2. Press the **▲** or **▼** button to select "Caption", then press the **ENTER** button.

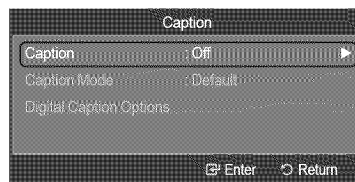

3. Press the **ENTER** button to select "Caption". Press the **▲** or **▼** button to select "On", then press the **ENTER** button.

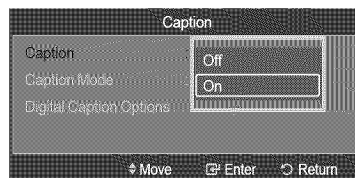

4. Press the **▲** or **▼** button to select "Caption Mode", then press the **ENTER** button. Press the **▲** or **▼** button to select submenu (Default, CC1~CC4 or Text1~Text4) you want, then press the **ENTER** button.

Press the **EXIT** button to exit.

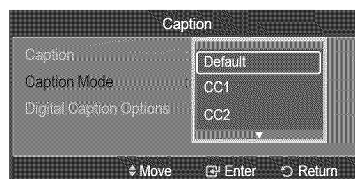

- The default is "CC1".
- **CC1**: The Primary Synchronous Caption Service. These are captions in the primary language that must be in sync with the sound, preferably matched to a specific frame.
- **CC2**: The Special Non-Synchronous Use Captions. This channel carries data that is intended to augment information carried in the program.
- **CC3**: Secondary Synchronous Caption Service. Alternate program-related caption data, typically second language captions.
- **CC4**: Special Non-Synchronous Use Captions. Similar to CC2.
- **Text1**: First Text Service. This may be various non-program related data.
- **Text2**: Second Text Service. Additional data, usually not program related.
- **Text3/Text4**: Third and Fourth Text Services. These data channels should be used only if Text1 and Text2 are not sufficient.

- The Caption feature doesn't work in Component, HDMI or PC modes.
- The availability of captions depends on the program being broadcast.

- Press the **CC** button on the remote control to turn the Caption "On" or "Off".

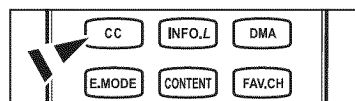

Viewing Closed Captions (On-Screen Text Messages) - Digital

The Digital Captions function operates on digital channels.

1. Press the **MENU** button to display the menu.
Press the **▲** or **▼** button to select "Setup", then press the **ENTER** button.
2. Press the **▲** or **▼** button to select "Caption", then press the **ENTER** button.
3. Press the **ENTER** button to select "Caption".
Press the **▲** or **▼** button to select "On", then press the **ENTER** button.

4. Press the **▲** or **▼** button to select "Caption Mode", then press the **ENTER** button. Press the **▲** or **▼** button to select submenu (Default, Service1~Service6, CC1~CC4 or Text1~Text4) you want, then press the **ENTER** button.

5. Press the **▲** or **▼** button to select "Digital Caption Options", then press the **ENTER** button.
 - "Digital Caption Options" are available only when "Default" and "Service 1~Service 6" can be selected in "Caption Mode".
 - Service1~6 in digital caption mode may not be available depending on the broadcast.

6. Press the **▲** or **▼** button to select "Size", then press the **ENTER** button. Press the **▲** or **▼** button to select the desired Caption option, then press the **ENTER** button. Press the **▲** or **▼** button to select the desired sub-menu options (see options below), then press **ENTER** button.

Press the **EXIT** button to exit.

- The availability of captions depends on the program being broadcast.
- "Default" means to follow the standard set by the broadcaster.
- Foreground and Background cannot be set to have the same color.
- "Foreground Opacity" and "Background Opacity" cannot be both set to Transparent.

- **Size:** This option consists of "Default", "Small", "Standard" and "Large". The default is "Standard".
- **Font Style:** This option consists of "Default", "Style0 ~ Style 7". You can change the font you want. The default is "Style 0".
- **Foreground Color:** This option consists of "Default", "White", "Black", "Red", "Green", "Blue", "Yellow", "Magenta" and "Cyan". You can change the color of the letter. The default is "White".
- **Background Color:** This option consists of "Default", "White", "Black", "Red", "Green", "Blue", "Yellow", "Magenta" and "Cyan". You can change the background color of the caption. The default is "Black".
- **Foreground Opacity:** This option consists of "Default", "Transparent", "Translucent", "Solid" and "Flashing". You can change the opacity of the letter.
- **Background Opacity:** This option consists of "Default", "Transparent", "Translucent", "Solid" and "Flashing". You can change the background opacity of the caption.
- **Return to Default:** This option sets each of "Size", "Font Style", "Foreground Color", "Background color", "Foreground Opacity" and "Background Opacity" to its default.

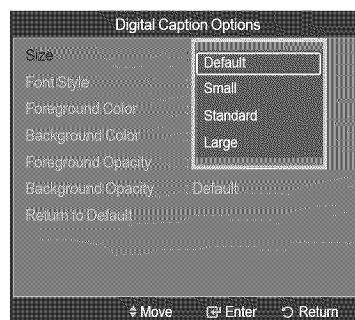
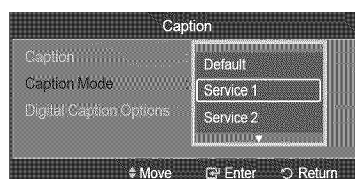
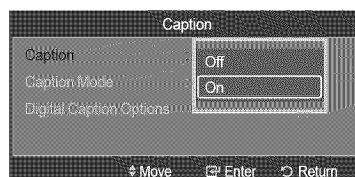
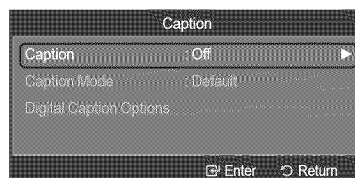
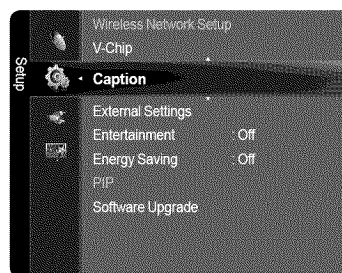

 Press the **CC** button on the remote control to turn the Caption "On" or "Off".

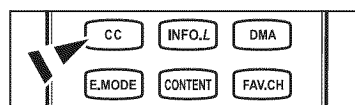

Adjusting the TV On/Off Melody Sound

A melody sound can be set to come on when the TV is powered On or Off.

1. Press the **MENU** button to display the menu.
Press the **▲** or **▼** button to select "Setup", then press the **ENTER** button.
2. Press the **▲** or **▼** button to select "External Settings", then press the **ENTER** button.
3. Press the **▲** or **▼** button to select "Melody", then press the **ENTER** button.
Press the **▲** or **▼** button to select "Off", "Low", "Medium" or "High", then press the **ENTER** button.

- **Off:** Turns off the melody function.
- **Low:** Sets the melody volume to low.
- **Medium:** Sets the melody volume to medium.
- **High:** Sets the melody volume to high.

Press the **EXIT** button to exit.

> The Melody does not play

- When no sound is output from the TV because the **MUTE** button has been pressed.
- When no sound is output from the TV because the volume has been reduced to minimum with the **VOL -** button.
- When the TV is turned off by Sleep Timer function.

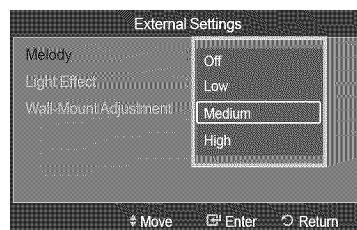
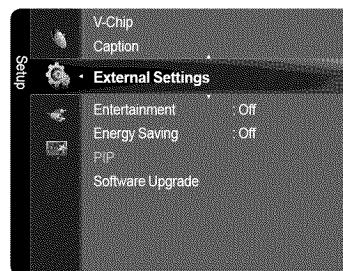

Setting the Light Effect

You can turn the LED on the front of TV on/off.

1. Press the **MENU** button to display the menu.
Press the **▲** or **▼** button to select "Setup", then press the **ENTER** button.
2. Press the **▲** or **▼** button to select "External Settings" then press the **ENTER** button.
3. Press the **▲** or **▼** button to select "Light Effect", then press the **ENTER** button.
Press the **▲** or **▼** button to select "Off", "In Standby", "Watching TV" or "Always", then press the **ENTER** button.

- **Off:** LED will not come on.
- **In Standby:** Turns the LED on in standby mode.
- **Watching TV:** Turns the LED on while watching TV.
- **Always:** LED will come on after you turn the TV off.

Press the **EXIT** button to exit.

- > Set the "Light Effect" to "Off" to reduce power consumption.

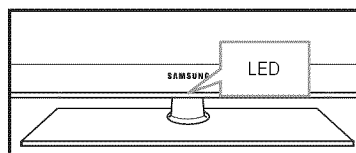
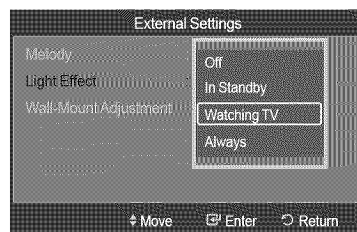
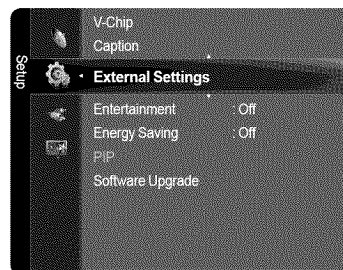

Setting the Entertainment mode

The "Entertainment" mode enables you to select the optimal display and sound for sports, cinema and games.

1. Press the **MENU** button to display the menu.
Press the **▲** or **▼** button to select "Setup", then press the **ENTER** button.
2. Press the **▲** or **▼** button to select "Entertainment", then press the **ENTER** button.
3. Press the **▲** or **▼** button to select "Off", "Sports", "Cinema" or "Game", then press the **ENTER** button.

- **Off**: Switches the "Entertainment" function off.
- **Sports**: Provides the optimal picture and sound quality for sports.
- **Cinema**: Provides the optimal picture and sound quality for movie watching. You can experience a richer picture and enhanced sound.
- **Game**: Provides the optimal picture and sound quality for games. This mode accelerates the playing speed when using an external game console connected to the TV.

Press the **EXIT** button to exit.

- If you set any of the three "Entertainment" modes to On, the settings will be locked and can not be adjusted. If you want to make Picture and Sound mode adjustments, the "Entertainment" mode must be turned off.
- The "Entertainment" settings are saved for each input source.
- If you set any of the three "Entertainment" modes to On, "SRS TruSurround XT" function is not available.
- In PC mode, This function is not available.

- ☑ You can press the **E.MODE** button on the remote control repeatedly to change the "Entertainment" setting.

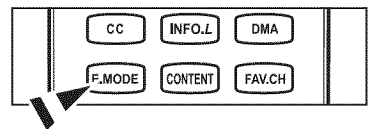
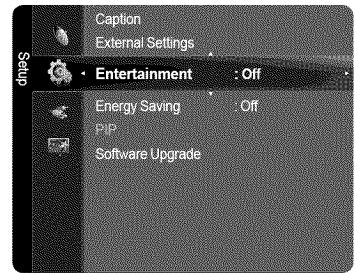

Using the Energy Saving Feature

This feature adjusts the brightness of the TV in order to reduce power consumption. When watching TV at night, set the "Energy Saving" mode option to "High" to reduce eye fatigue as well as power consumption.

1. Press the **MENU** button to display the menu.
Press the **▲** or **▼** button to select "Setup", then press the **ENTER** button.

2. Press the **▲** or **▼** button to select "Energy Saving", then press the **ENTER** button. Select the required option (Off, Low, Medium, High, Auto) by pressing the **▲** or **▼** button.

Press the **ENTER** button.

- **Off**: Turns off the energy saving function.
- **Low**: Sets the TV to low energy saving mode.
- **Medium**: Sets the TV to medium energy saving mode.
- **High**: Sets the TV to high energy saving mode.
- **Auto**: Automatically adjusts the brightness of the TV screen in accordance with the scenes.

Press the **EXIT** button to exit.



Upgrading the Software

Samsung may offer upgrades for TV's firmware in the future. Please contact the Samsung call center at 1-800-SAMSUNG (726-7864) to receive information about downloading upgrades and using a USB drive. Upgrades will be possible by connecting a USB drive to the USB port located on your TV.

1. Insert a USB drive containing the firmware upgrade into the WISELINK port on the side of the TV.
 - > Software can not be upgraded through the LAN connection.
 - > Please connect a single USB device having upgrade file .

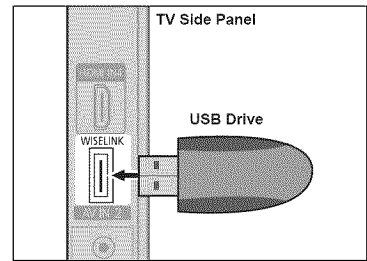

[LN46A850S1F, LN52A850S1F]

2. Press the **MENU** button to display the menu.
Press the **▲** or **▼** button to select "Setup", then press the **ENTER** button.
3. Press the **▲** or **▼** button to select "Software Upgrade", then press the **ENTER** button.
4. Press the **ENTER** button.
The message "Scanning for USB... It may take up to 30 seconds." is displayed.

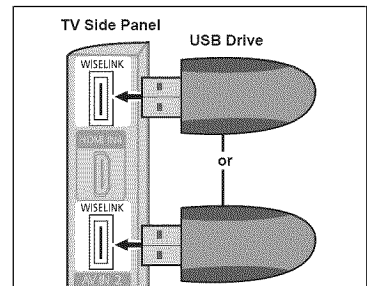

[LN46A860S2F, LN52A860S2F]

5. The message "Upgrade version XXXX to version XXXX? The system would be reset after upgrade." is displayed.
Press the **◀** or **▶** to select the "OK", then press the **ENTER** button.



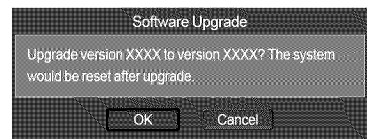



Please be careful to not disconnect the power or remove the USB drive while upgrades are being applied. The TV will turn off and turn on automatically after completing the firmware upgrade. Please check the firmware version after the upgrades are complete. When software is upgraded, video and audio settings you have made will return to their default (factory) settings. We recommend you write down your settings so that you can easily reset them after the upgrade.



Self diagnosis

Picture Test

If you think you have a picture problem, perform the picture test. Check the color pattern on the screen to see if the problem still exists.





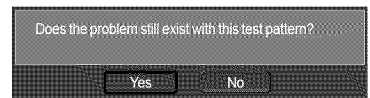
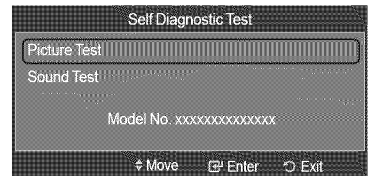
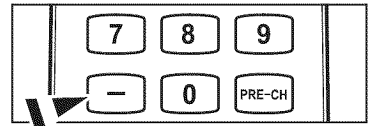

1. Press and hold the  button for more than 5 seconds.
 - > "Self Diagnostic Test" appears on the screen.
2. Press the  or  button to select "Picture Test", then press the **ENTER**  button.
 - > "Does the problem still exist with this test pattern?" appears on the screen.
3. Press the  or  button to select "Yes" or "No".
 - > If the test pattern does not appear or there is noise in the test pattern, select "Yes".
 - > If the test pattern is properly displayed, select "No".

- **Yes:** There may be a problem with the TV. Contact the Samsung Call center at 1-800 SAMSUNG.
- **No:** There may be a problem with your external equipment. Please check your connections. If the problem still persists, refer to the external device's user manual.



Sound Test

If you think you have a sound problem, please perform the sound test. You can check the sound by playing a built-in melody sound through the TV.

1. Press and hold the  button for more than 5 seconds.
 - > "Self Diagnostic Test" appears on the screen.
2. Press the  or  button to select "Sound Test", then press the **ENTER**  button.
 - > "Does the problem still exist with this sound test?" appears on the screen.
3. Press the  or  button to select "Yes" or "No".
 - > If during the sound test you can hear sound only from one speaker or from no speaker at all, select "Yes".
 - > If you can normally hear the sound from the speakers, select "No".

- **Yes:** There may be a problem with the TV. Contact the Samsung Call center at 1-800-SAMSUNG.
- **No:** There may be a problem with your external equipment. Please check your connections. If the problem still persists, refer to the external device's user manual.

- > If you hear no sound from the TV's speakers, before performing the sound test, make sure "Select Speaker" is set to "TV speaker" in the Sound menu.
- > The melody will be heard during the test even if "Select Speaker" is set to "External Speaker" or the sound is muted by pressing the **MUTE** button.
- > If headphones are connected, the test melody will play through the headphones.

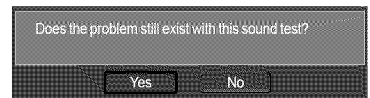
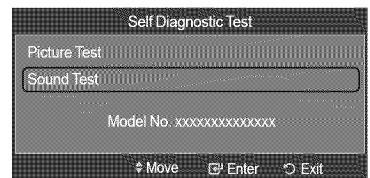
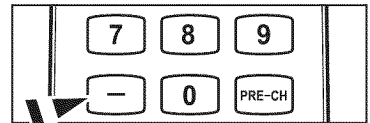

Using the WISELINK Pro Function

Connecting a USB Device

- LN46A850S1F and LN52A850S1F only have one USB port.
- LN46A860S2F and LN52A860S2F have two USB ports.

You can view movies and photos and listen to music files stored on a USB Mass Storage Class (MSC) device.

1. Press the **POWER** button on the remote control or front panel.
 - The TV is powered on.

2. Connect a USB device containing JPEG, MP3 and/or Movie files to the WISELINK jack (USB jack) on the side of the TV.

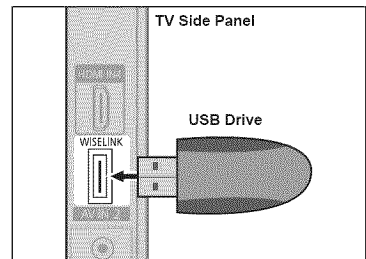

[LN46A850S1F, LN52A850S1F]

- If you enter the WISELINK Pro mode with no USB device connected the message "No external storage device found. Check the connection status." will appear. In this case, insert the USB device, exit the screen by pressing the **W.LINK** button on the remote control and enter the WISELINK Pro screen again.
- MTP (Media Transfer Protocol) is not supported.
- The file system only supports FAT16/32 (The NTFS file system is not supported).
- Certain types of USB Digital camera and audio devices may not be compatible with this TV.

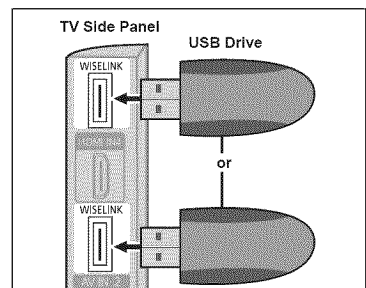

[LN46A860S2F, LN52A860S2F]

- WISELINK Pro only supports USB Mass Storage Class devices (MSC). MSC is a Mass Storage Class Bulk-Only Transport device. Examples of MSC are Thumb drives and Flash Card Readers (Both USB HDD and HUB are not supported.)
- Please connect directly to the USB port of your TV. If you are using a separate cable connection, there may be a USB compatibility problem.
- Before connecting your device to the TV, please back up your files to prevent them from damage or loss of data. SAMSUNG is not responsible for any data file damage or data loss.
- Do not disconnect the USB device while it is loading.
- MSC supports MP3 and JPEG files, while a PTP device supports JPEG files only.
- The sequential jpeg format is supported.
- Photo and audio files must be named in English, French or Spanish. If not, the files can not be played. Change the file names to English, French or Spanish if necessary.
- The higher the resolution of the image, the longer it takes to display on the screen.
- The maximum supported JPEG resolution is 15360X8640 pixels.
- For unsupported or corrupted files, the "Not Supported File Format" message is displayed.
- If the number of photo files exceeds 4000 (or the number of music files exceeds 3000), any files exceeding the 4000 limit may not be displayed in the Photo List (or Music List).
- MP3 files with DRM that have been downloaded from a non-free site cannot be played. Digital Rights Management (DRM) is a technology that supports the creation of content, the distribution and management of the content in an integrated and comprehensive way, including the protection of the rights and interests of the content providers, the prevention of the illegal copying of contents, as well as managing billings and settlements.
- If more than 2 PTP devices are connected, you can only use one at a time. (Applicable to models LN46A860S2F, LN52A860S2F only)
- If more than one MSC device is connected, some of them may not be recognized. If a device requires high power (more than 500mA or 5V), the USB device may not be supported. (Applicable to models LN46A860S2F, LN52A860S2F only)

Using the Remote Control Button in WISELINK Pro Menu

Button	Operations
Wheel (▲/▼/◀/▶)	Move the cursor and select an item.
ENTER	Select the currently selected item. While playing a slide show, movie, or music file: - Pressing the ENTER button during play pauses play. - Pressing the ENTER button during pause resumes play.
▶ / ⏸	Play or pause the Slide Show, Music or Movie file.
RETURN	Return to the previous menu.
TOOLS	Run various functions from the Photo, Music and Movie menus.
■	Stop the current slide show, Music or Movie file.
◀◀ / ▶▶	Jump to previous group / Jump to next group.
INFO	Show file information.
W.LINK	Exit WISELINK Pro mode.
CH ▼/▲ PRE.CH / FAV.CH / CH.LIST	Stop WISELINK Pro mode and Returns to TV mode.
EXIT	Stop the current function and return to the WISELINK Pro main menu.
SOURCE	Stop WISELINK Pro mode and show the source list.

Using the WISELINK Pro Menu

1. Press the **MENU** button. Press the ▲ or ▼ button to select "Application", then press the **ENTER** button.
2. Press the ▲ or ▼ button to select "WISELINK Pro", then press the **ENTER** button.
 - > The "WISELINK Pro" menu is displayed.

or

- Press the **W.LINK** button on the remote control to display the "WISELINK Pro" menu.

or

- Press the **SOURCE** button on the remote control repeatedly to select "USB", then press the **ENTER** button.

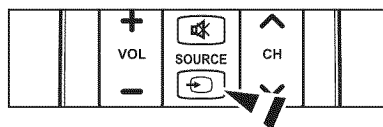
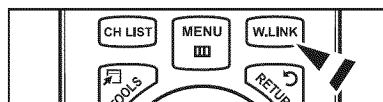

3. Press the Red button, then press the ▲ or ▼ button to select the corresponding USB Memory Device (i.e. if connected through a hub, or if you have two USB devices connected (LN46A860S2F, LN52A860S2F only)). Press the **ENTER** button.
 - > This function differs depending on the USB Memory Device connected to TV.
 - > The selected USB device name appears at the bottom left of the screen.
 - > If you have two USB devices connected simultaneously (LN46A860S2F, LN52A860S2F) they will be shown by name in the order they were inserted.
4. Press the ◀ or ▶ button to select an icon (Photo, Music, Movie, Setup), then press the **ENTER** button.
 - > To exit "WISELINK Pro" mode, press the **W.LINK** button on the remote control.

Using the Photo List

This menu shows Photo files saved on a USB memory device.

Photo List

1. Press the **W.LINK** button on the remote control to display the "WISELINK Pro" menu.
2. Press the ◀ or ▶ button to select "Photo", then press the **ENTER** button.
 - > Photo files are displayed.
 - > This menu only shows files whose file extension is jpg. Files of other formats such as bmp or tiff will not be displayed.
 - > Press the ▶ (Play) / **ENTER** button to start the Slide Show.
 - > To move to the previous / next group, press the ◀◀ (REW) or ▶▶ (FF) button.
 - > When moving to a photo, loading may take a few seconds. At this point, the loading icon will appear on the screen.
 - > It may take some time to load photo files as Thumbnail images.

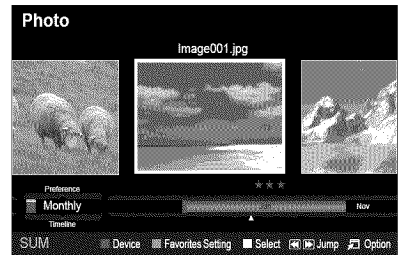

Screen Display

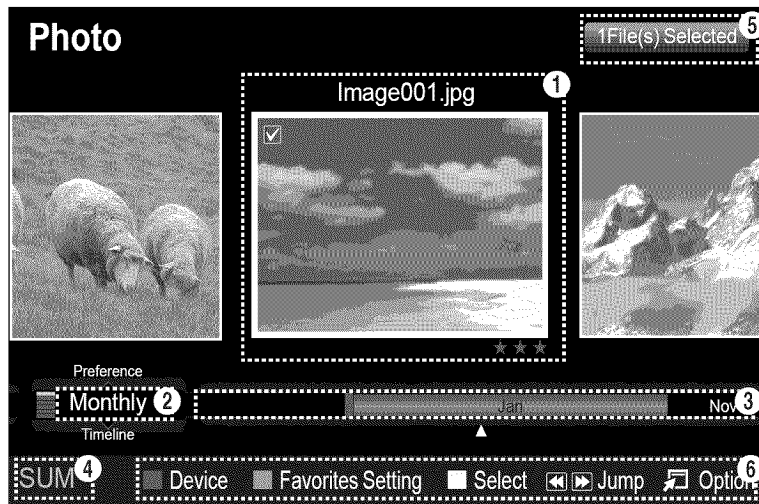

1 Currently selected photo

Shows the currently selected photo.

2 Current Sort Standard

Press the ▲ or ▼ button to change the standard for sorting photos. ("Monthly", "Timeline", "Color", "Composition", "Folder", "Preference")

The item that is selected as the sorting standard is highlighted in the Photo Information Window.

3 View Groups

Shows the sorting groups. The sorting group including the currently selected photo is highlighted.

4 Current Device

Shows the currently selected device name. Press the Red button to select a device.

5 Item Selection Information

Shows the number of photos that are selected by pressing the Yellow button.

6 Help Items

- **Red(Device) button:** Selects a connected device.
- **Green(Favorites Setting) button:** Changes the favorites setting for the selected photo. Press this button repeatedly until the desired value appears. (Refer to page 81)
- **Yellow(Select) button:** Selects photos from the photo list. Selected photos are marked with a symbol ✓ on the left.
- **◀▶(Jump) button:** Jumps to the previous sorting group / Jumps to the next sorting group.
- **TOOLS(Optional) button:** Displays the "Slide Show", "Play Current Group", "Rotate", "Delete", "Change Group Info" (in "Color" or "Composition" group), "Information" or "Safe Remove" menus.

Sorting Photo List

You can sort photos in the Photo List by a particular standard.

1. Press the **W.LINK** button on the remote control to display the "WISELINK Pro" menu.
2. Press the ◀ or ▶ button to select "Photo", then press the **ENTER** button.
 - Photo files are displayed.
3. Press the ▲ or ▼ button to select a sorting standard. ("Monthly", "Timeline", "Color", "Composition", "Folder", "Preference")
 - The photos are sorted according to the newly selected sorting standard.
4. Press the **ENTER** button to start the Slide Show in the order selected by the user.
 - WISELINK Pro identifies the color and composition of images and groups them accordingly by analyzing the images on the USB device.
 - The "Composition" and "Color" information extracted from a photo file may be different from what you selected.
 - Photo information is automatically set. You can change the "Color", "Composition", and "Favorite".
 - Photos for which information cannot be displayed are set as "Unclassified".
 - PTP does not support folder sort mode.

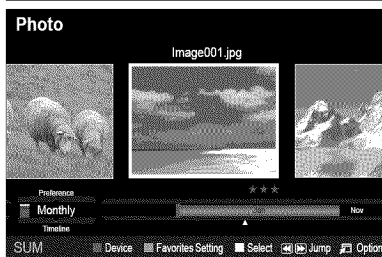

Monthly

You can sort and play photos by month.

- It sorts and shows photos in the file by month. It sorts only by month (from January to December) regardless of year.
1. Select "Monthly" as the sorting standard in the Photo List.
 2. Press the ◀ or ▶ button to select from the sublist of photos grouped by Month.
 - To move to the previous / next month group, press the ◀◀ (REW) or ▶▶ (FF) button.
 3. Press the **TOOLS** button. Press the ▲ or ▼ button to select "Play Current Group".
 4. Press **ENTER**  to play the selected group of photo files from the sublist.

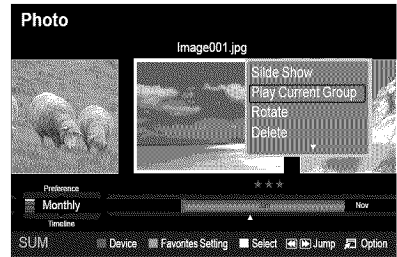

Timeline

You can sort and play photos by timeline.

- It sorts and shows photos by date. It sorts by year and month from the earliest photo.
1. Select "Timeline" as the sorting standard in the Photo List.
 2. Press the ◀ or ▶ button to select from the sublist of photos grouped by Timeline.
 - To move to the previous / next timeline group, press the ◀◀ (REW) or ▶▶ (FF) button.
 3. Press the **TOOLS** button. Press the ▲ or ▼ button to select "Play Current Group".
 4. Press **ENTER**  to play the selected group of photo files from the sublist.





Color

You can sort and play photos by color.

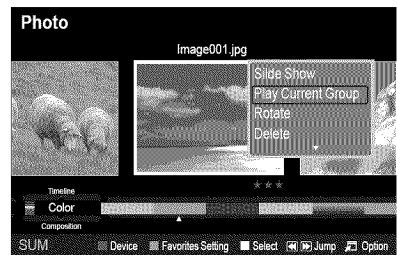
1. Select "Color" as the sorting standard in the Photo List.
2. Press the ◀ or ▶ button to select from the sublist of photos grouped by color.
 - To move to the previous / next color group, press the ◀◀ (REW) or ▶▶ (FF) button.
3. Press the **TOOLS** button. Press the ▲ or ▼ button to select "Play Current Group".
4. Press **ENTER**  to play the selected group of photo files from the sublist.



Changing the color information of a selected photo

- You can change a selected photo file's (or group of files) color information in order to move it from one color group to another.
 - This does not change the actual color of the photo.
1. Select "Color" as the sorting standard in the Photo List and press the ◀ or ▶ button to select a photo.
 - **Changing the information of multiple photos**
Press the ◀ or ▶ button to select the desired photo in the Photo list. Then press the yellow button.
Repeat the above operation to select multiple photos.
The ✓ mark appears to the left of the selected photo.
 2. Press the **TOOLS** button.
 3. Press the ▲ or ▼ button to select "Change Group Info". Press the **ENTER**  button.
 4. Press the ◀ or ▶ button to select the desired color option, then press the **ENTER**  button.
 - The group information of the current file is updated and the photos are moved to the new color group.
 - "Color" options: Red, Yellow, Green, Blue, Magenta, Black, Gray, Unclassified.

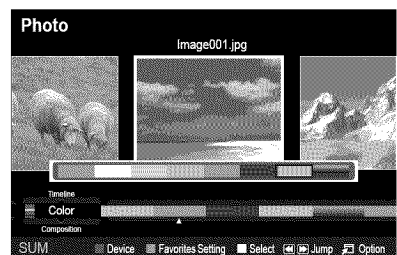

Composition

You can sort and play photos by composition.

1. Select "Composition" as the sorting standard in the Photo List.
2. Press the ◀ or ▶ button to select from the sublist of photos grouped by composition.
 - To move to the previous / next composition group, press the ◀◀ (REW) or ▶▶ (FF) button.
3. Press the **TOOLS** button. Press the ▲ or ▼ button to select "Play Current Group".
4. Press **ENTER** ⏎ to play the selected group of photo files from the sublist.

Changing the composition information of a selected photo

- You can change a selected photo file's (or group of files) composition information in order to move it from one composition group to another.
1. Select "Composition" as the sorting standard in the Photo List and press the ◀ or ▶ button to select a photo.
 - **Changing the information of multiple photos**
Press the ◀ or ▶ button to select the desired photo in the Photo list. Then press the yellow button.
Repeat the above operation to select multiple photos.
The ✓ mark appears to the left of the selected photo.
 2. Press the **TOOLS** button.
 3. Press the ▲ or ▼ button to select "Change Group Info". Press the **ENTER** ⏎ button.
 4. Press the ◀ or ▶ button to select the composition option, then press the **ENTER** ⏎ button.
 - The group information of the current file is updated and the photos are moved to the new composition group.
 - "Composition" options: ☰ (horizontal), ☷ (vertical), 📄 (object), 📐 (perspective), 📏 (pattern), Unclassified

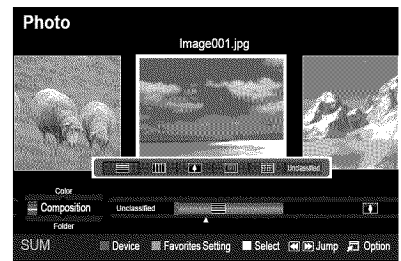
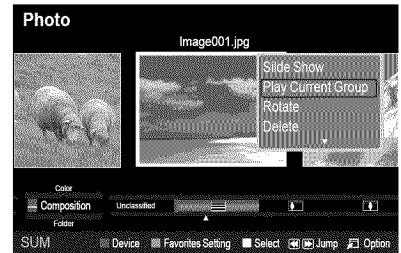

Folder

You can sort and play photos by folder.

- If there are many folders in USB, the photos files are shown in order in each folder. The photo file in the Root folder is shown first and the others are shown in alphabetical order by name.
1. Select "Folder" as the sorting standard in the Photo List.
 2. Press the ◀ or ▶ button to select from the sublist of photos grouped by folder.
 - To move to the previous / next folder group, press the ◀◀ (REW) or ▶▶ (FF) button.
 3. Press the **TOOLS** button. Press the ▲ or ▼ button to select "Play Current Group".
 4. Press **ENTER** ⏎ to play the selected group of photo files from the sublist.



Preference

You can sort and play photos by preference. (Favorite)

1. Select "Preference" as the sorting standard in the Photo List.
2. Press the ◀ or ▶ button to select from the sublist of photos grouped by preference.
 - To move to the previous / next preference group, press the ◀◀ (REW) or ▶▶ (FF) button.
3. Press the **TOOLS** button. Press the ▲ or ▼ button to select "Play Current Group".
4. Press **ENTER** (G) to play the selected group of photo files from the sublist.

Changing the Favorites setting

- You can change a selected photo file's (or group of files) preference information in order to move it from one preference group to another.
1. Press the ◀ or ▶ button to select the desired photo in the Photo list.
 2. Press the Green button repeatedly until the desired setting appears.
 - Favorites settings change completed.
 - "Favorite" options: ★★, ★★★, ★★, ★★★
 - Users can select the number of stars (up to 3) according to their preference.
 - The stars are for grouping purposes only. For example, the 3 star setting does not have any priority over the one star setting.



Rotating the Photo file

1. Press the ◀ or ▶ button to select the desired photo in the Photo list.
2. Press the **TOOLS** button.
3. Press the ▲ or ▼ button to select "Rotate", then press the **ENTER** (G) button. Press the ◀ or ▶ button repeatedly to rotate the photo by the desired amount.
 - Whenever you press the ◀ button, it rotates by 270°, 180°, 90°, and 0°.
 - Whenever you press the ▶ button, it rotates by 90°, 180°, 270°, and 0°.
 - The Rotating function information icon is displayed.

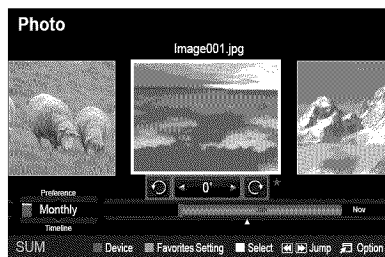
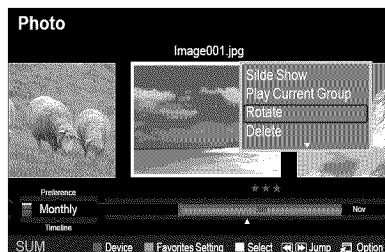
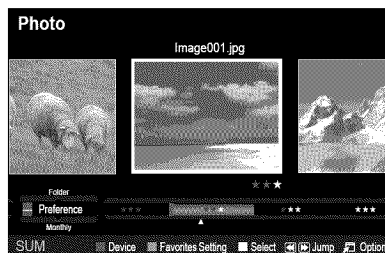
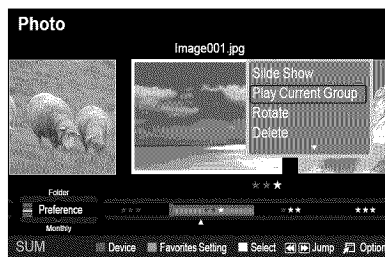
Icon	Current OSD	Function
	Rotating (0°)	This rotates a photo to its original position
	Rotating (90°)	This rotates a photo by 90 degrees
	Rotating (180°)	This rotates a photo by 180 degrees
	Rotating (270°)	This rotates a photo by 270 degrees



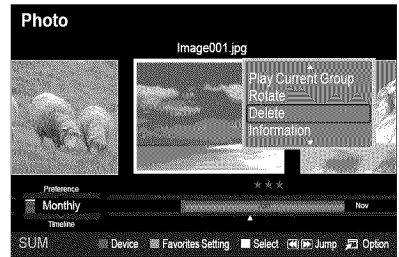

Deleting the Photo file

1. Press the ◀ or ▶ button to select the desired photo in the Photo list.
2. Press the **TOOLS** button.
3. Press the ▲ or ▼ button to select "Delete", then press the **ENTER**  button.
 - The "Delete this file?" message appears.
4. Press the ◀ or ▶ button to select "OK", then press the **ENTER**  button.
 - The photo is deleted.
 - When a read-only file is deleted, the "Read-only file(s). Delete the file(s)?" message appear.
 - If you select "Cancel", the deletion is cancelled.
5. To exit "WISELINK Pro" mode, press the **W.LINK** button on the remote control.
 - You cannot remove the PTP-connected digital camera picture files.
 - While removing files, don't remove the USB memory device.
 - You cannot recover a deleted photo file.



Deleting Multiple Photos

1. Press the ◀ or ▶ button to select the desired photo in the Photo list. Then press the yellow button.
 - Repeat the above operation to select multiple photos.
 - The ✓ mark appears to the left of the selected photo.
2. Press the **TOOLS** button.
3. Press the ▲ or ▼ button to select "Delete selected File", then press the **ENTER**  button.
 - The "Delete the selected file(s)?" message appears.
4. Press the ◀ or ▶ button to select "OK", then press the **ENTER**  button.
 - The selected photos are deleted.
 - If you select "Cancel", the deletion is cancelled.
5. To exit "WISELINK Pro" mode, press the **W.LINK** button on the remote control.
 - You cannot remove the read-only files from the selected ones.
 - You cannot recover a deleted photo file.



Viewing the Photo Information

The photo file information including the order of the file in the current directory, the name, the size, the resolution, the date modified and the path is displayed.

1. Press the ◀ or ▶ button to select the desired photo in the Photo list.
2. Press the **TOOLS** button.
3. Press the ▲ or ▼ button to select "Information", then press the **ENTER**  button.
 - The information on the selected photo appears.

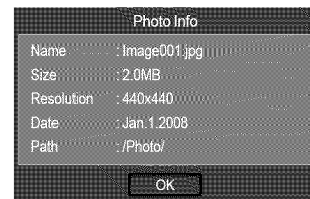
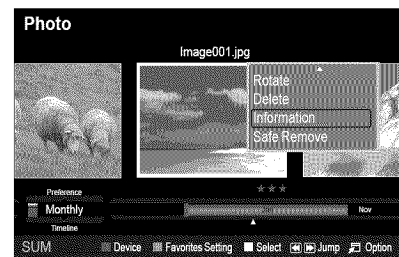





-  Press the **INFO** button to viewing the information.



Viewing a Photo or Slide Show



Viewing a Slide Show

1. Press the **W.LINK** button on the remote control to display the "WISELINK Pro" menu.
2. Press the ◀ or ▶ button to move to "Photo", then press the **ENTER**  button.
 - Photo files are displayed.
3. Press the ◀ or ▶ button to select the desired photo in the Photo list.
4. Press the **TOOLS** button.
5. Press the ▲ or ▼ button to select "Slide Show", then press the **ENTER**  button.
 - All files in the photo list will be used for the Slide Show.
 - During the slide show, files are displayed in order from the currently shown file.
 - The Slide Show progresses in the order sorted in the Photo list.
 - Music files can be automatically played during the Slide Show if the "Background Music" is set to "On". (Refer to page 85).

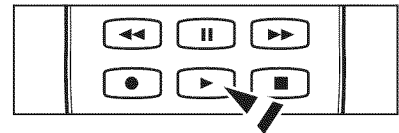
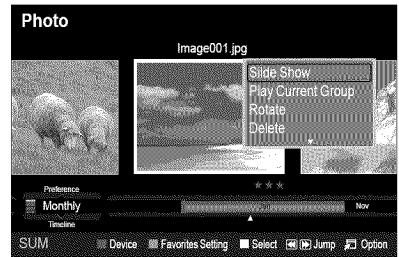

 While a photo list is displayed, press the  (Play) / **ENTER**  button on the remote control to start the Slide Show.



To perform a SlideShow with only the selected files







1. Press the ◀ or ▶ button to select the desired photo in the Photo list. Then press the yellow button. Repeat the above operation to select multiple photos.
 - The ✓ mark appears to the left of the selected photo.
 - If you select one file, the SlideShow will not be performed.
2. Press the  (Play) / **ENTER**  button.
 - The selected files will be used for the Slide Show.
 - If you have selected files, only the selected files will be used for the Slide Show.

Playing current group

1. Press the ▲ or ▼ button to select a sorting standard. ("Monthly", "Timeline", "Color", "Composition", "Folder", "Preference")
2. Press the ◀ or ▶ button to select the desired photo in the Photo list.
 - To move to the previous / next group, press the  (REW) or  (FF) button.
3. Press the **TOOLS** button.
4. Press the ▲ or ▼ button to select "Play Current Group", then press the **ENTER**  button. Only the photos in the sorting group including the selected files will be used for the Slide Show.
5. To exit "WISELINK Pro" mode, press the **W.LINK** button on the remote control.



Slide show function information icon (Displayed at the top left of the screen)

Icon	Current OSD	Function
	(Photo) SlideShow	Photo Slide Show is in progress.
	Photo Pause	You can pause a Slide Show by pressing the  (Pause)/ ENTER  button on the remote control during a Slide Show. To resume the Slide Show, press the  (Play)/ ENTER  button on the remote control again.

Viewing a photo

1. Press the **W.LINK** button on the remote control to display the "WISELINK Pro" menu.
2. Press the ◀ or ▶ button to move to "Photo", then press the **ENTER** button.
 - Photo files are displayed.
3. Press the ◀ or ▶ button to select the desired photo in the Photo list. Then Press the Yellow button to select only one file.
4. Press the **ENTER** button over a photo icon.
 - The currently selected photo is displayed in full screen.



Using the option menu during a slide show (or Viewing a Photo)

1. During a slide show(or viewing a photo), press the **TOOLS** button to set the option.
2. Press the ▲ or ▼ button to select the desired option. Then press the **ENTER** button.

Start Slide Show (or Stop Slide Show)

You can start or stop a Slide Show.

Press the ▲ or ▼ button to select "Start Slide Show" (or "Stop Slide Show"), then press the **ENTER** button.

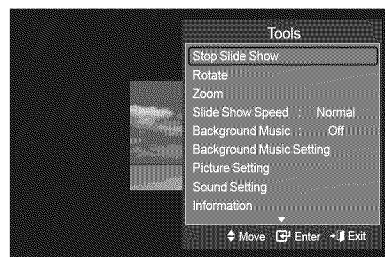

Rotate

You can rotate images in full screen mode.

Press the ▲ or ▼ button to select "Rotate", then press the **ENTER** button. Press the ◀ or ▶ button repeatedly to rotate the photo by the desired amount.

- Whenever you press the ◀ button, it rotates by 270°, 180°, 90°, and 0°.
- Whenever you press the ▶ button, it rotates by 90°, 180°, 270°, and 0°.
- If you have selected "Zoom", the "Rotate" deactivated.
- The rotated file is not saved.
- The Rotating function information icon is displayed at the top right of the screen

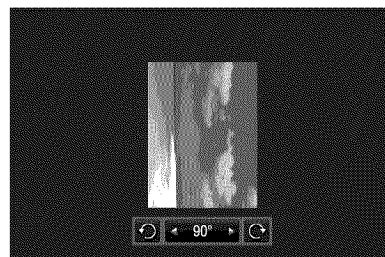

Icon	Current OSD	Function
0°	Rotating (0°)	This rotates a photo to its original position
90°	Rotating (90°)	This rotates a photo by 90 degrees
180°	Rotating (180°)	This rotates a photo by 180 degrees
270°	Rotating (270°)	This rotates a photo by 270 degrees







Zoom

You can zoom into images in full screen mode.

Press the ▲ or ▼ button to select "Zoom", then press the **ENTER**  button.
Press the ◀ or ▶ button repeatedly to increase or decrease the Zoom effect. (x1 → x2 → x4)

To move the enlarged photo image, press the **ENTER**  button, then press the ▲/▼/◀/▶ buttons.

- Note that when the enlarged picture is smaller than the original screen size, the location change function doesn't work.
- The enlarged file is not saved.
- If you have selected "Rotate", the "Zoom" deactivate
- Zoom function information icon is displayed at the top right of the screen.

Icon	Current OSD	Function
	Zoom (x 2)	Zoom-into a photo at 2x.
	Zoom (x 4)	Zoom-into a photo at 4x.
	Zoom (x 1)	Restore a photo to its original size.
	Pan Down	Pan down to view the lower part of a zoomed-in photo.
	Pan Up	Pan up to view the upper part of a zoomed-in photo.
	Pan Right	Pan right to view the right side of a zoomed-in photo.
	Pan Left	Pan left to view the left side of a zoomed-in photo.

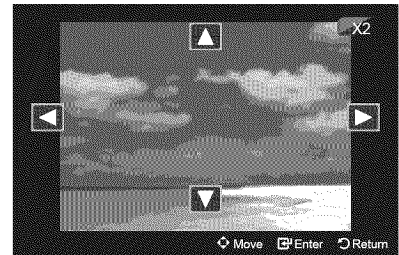



Slide Show Speed

You can select the slide show speed.

Press the ▲ or ▼ button to select "Slide Show Speed".

Press the ◀ or ▶ button to select the desired option. (Fast → Slow → Normal)

- You can select the SlideShow speed only during a slide show.
- You can also change the speed of the Slide Show by pressing the  (REW) or  (FF) key during the Slide Show.

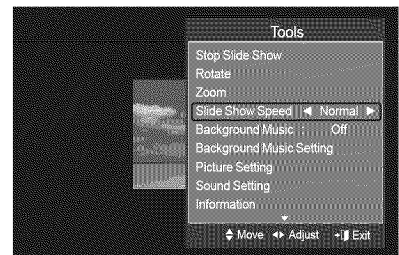

Background Music

If you set "Background Music" to On, the background music will be played when viewing photos one by one or in a Slide Show.

Press the ▲ or ▼ button to select "Background Music".

Press the ◀ or ▶ button to select "On" or "Off".

- If you set "Background Music" to On, a screen appears immediately where you can set the Background Music.

- **On:** When the background music is available, if you select On, the music is played back. To use this feature, there must be music and photo files stored on the USB device.
- **Off:** Background music is not played.



Background Music Setting

You can set the background music.

Press the ▲ or ▼ button to select "Background Music Setting", then press the ENTER button.

- If you turn off the "Background Music", even if the "Background Music Settings" have been set up, the background music will not be played.

- Music files must be loaded and playing to change the BGM mode.
- **"Background Music setting" menu is displayed.**

Press the ◀ or ▶ button to select the desired BGM (Background music) mode. (Shuffle, Selected file, Mood)

- **Shuffle:** Plays music files in random order.
- **Selected file:** Plays a selected music file.
- **Mood:** Plays music files of a particular mood only.

- **Selecting the background music file**

Press the ◀ or ▶ button to set "BGM Mode" to "Selected file". Press the ▲ or ▼ button to select "Select Music File", then press the ENTER button.

Press the ▲ or ▼ button to select a music file, then press the yellow button.

The ✓ mark appears to the left of the selected music. Repeat the above operation to select multiple music files. Press the ENTER button.

- **Selecting the background music file mood**

Press the ◀ or ▶ button to set "BGM Mode" to "Mood". Press the ▲ or ▼ button to select "BGM Mood". Then press ◀ or ▶ button to select the desired BGM mood. Press the ENTER button.

BGM mode option: Energetic, Rhythmical, Sad, Exciting, Calm

- WISELINK Pro identifies and analyzes the mood the of music files on the USB device and groups them accordingly.

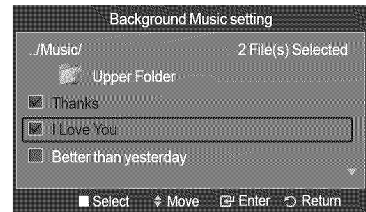
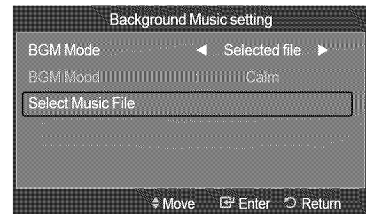
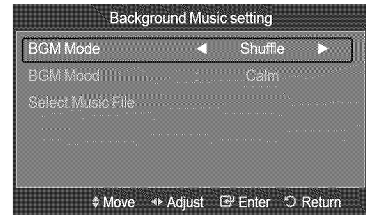
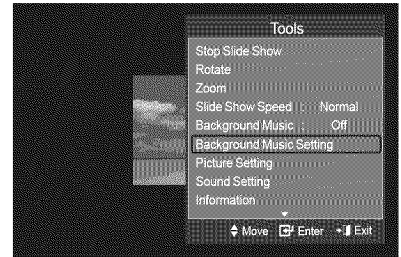

Picture Setting

You can set the Picture mode. (Refer to page 100)

Sound Setting

You can set the Sound mode. (Refer to page 100)

Information

The photo file information including the order of the file in the current directory, the name, the size, the resolution, the date modified and the path is displayed. (Refer to page 82)

Safe Remove

You can remove the device safely from the TV.

Press the ▲ or ▼ button to select "Safe Remove", then press the ENTER button.

Remove the USB device from the TV.

Using the Music List

This menu shows MP3 files from among the files saved on a USB memory device.

1. Press the **W.LINK** button on the remote control to display the "WISELINK Pro" menu.
2. Press the ◀ or ▶ button to select "Music", then press the **ENTER** button.
 - Music files are displayed.
 - Press the (Play) / **ENTER** button over a music icon to play the music.
 - To move to the previous / next group, press the (REW) or (FF) button.

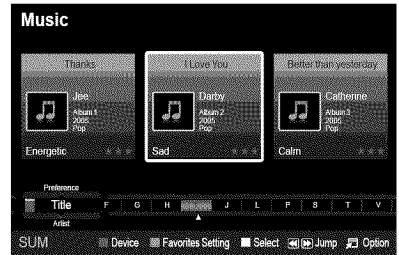

Screen Display

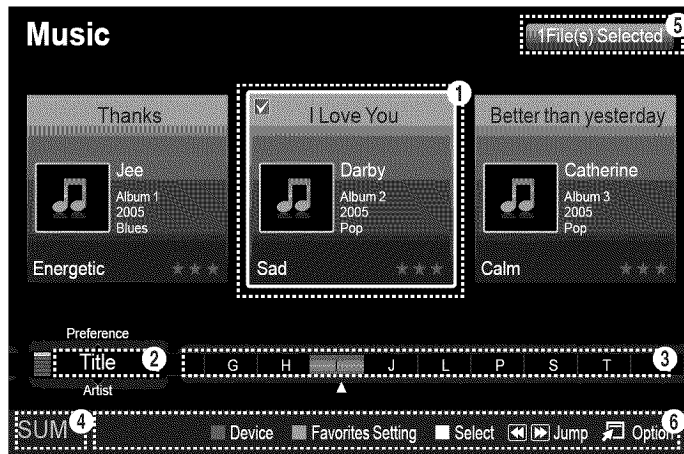

- 1 **Currently selected music**
Shows the currently selected music.
- 2 **Current Sort Standard**
Press the ▲ or ▼ button to change the standard for sorting music files. ("Title", "Artist", "Mood", "Genre", "Folder", "Preference")
- 3 **View Groups**
Shows the sorting groups. The sorting group including the currently selected music file is highlighted.
- 4 **Current Device**
Shows the currently selected device name. Press the Red button to select a device.

5 Item Selection Information

Shows the number of music files that are selected by pressing the Yellow button.

6 Help Items

- **Red(Device) button:** Selects a connected device.
- **Green(Favorites Setting) button:** Changes the favorites setting for the selected music. Press this button repeatedly until the desired value appears. (Refer to page 90)
- **Yellow(Select) button:** Selects music files from the music list. Selected music files are marked with a symbol ✓ on the left.
- **◀▶ (Jump) button:** Jumps to the previous sorting group / Jumps to the next sorting group.
- **TOOLS(Option) button:** Displays the "Play Current Group", "Delete", "Change Group Info" (in "Mood" group), "Information" or "Safe Remove" menus.

Sorting Music List

You can sort music files in the Music List by a particular standard.

1. Press the **W.LINK** button on the remote control to display the WISELINK Pro menu.
2. Press the **◀** or **▶** button to select "Music", then press the **ENTER** button.
 - > Music files are displayed.
3. Press the **▲** or **▼** button to select a sorting standard. ("Title", "Artist", "Mood", "Genre", "Folder", "Preference")
 - > Music files are sorted according to the newly selected sorting standard.
4. Press the **ENTER** button to start playing music in the order selected by the user.
 - > Music information is set automatically and you can change the Favorite information.
 - > Music files for which information cannot be displayed are set to "Unclassified".
 - > If there is no title information for a music file, the filename is displayed.
 - > If no information is available for the Genre, Artist, Album, or Year, the corresponding item is displayed as blank.



Title

You can sort and play music files by title.

- > It sorts and displays the Music titles in alphabetical order.
1. Select "Title" as the sorting standard in the Music List.
 2. Press the **◀** or **▶** button to select from the sublist of music files grouped in alphabetical order.
 - > To move to the previous / next title group, press the **◀◀** (REW) or **▶▶** (FF) button.
 3. Press the **TOOLS** button.
 4. Press the **▲** or **▼** button to select "Play Current Group".
 5. Press **ENTER** to play the selected group of music files from the sublist.

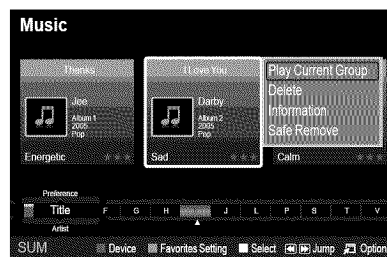

Artist

You can sort and play music files by artist.

- It sorts the music file by artist in alphabetical order.

1. Select "Artist" as the sorting standard in the Music List.
2. Press the ◀ or ▶ button to select from the sublist of music files grouped in alphabetical order.
 - To move to the previous / next artist group, press the ◀◀ (REW) or ▶▶ (FF) button.
3. Press the **TOOLS** button.
4. Press the ▲ or ▼ button to select "Play Current Group".
5. Press **ENTER**  to play the selected group of music files from the sublist.



Mood



You can sort and play music files by mood.

1. Select "Mood" as the sorting standard in the Music List.
2. Press the ◀ or ▶ button to select from the sublist of music files grouped by mood.
 - To move to the previous / next mood group, press the ◀◀ (REW) or ▶▶ (FF) button.
3. Press the **TOOLS** button.
4. Press the ▲ or ▼ button to select "Play Current Group".
5. Press **ENTER**  to play the selected group of music files from the sublist.



Changing the Mood information of a selected music file

- You can change a selected music file's (or group of files) mood information in order to move it from one mood group to another.

1. Select "Mood" as the sorting standard in the Music List and press the ◀ or ▶ button to select a music file.
 - **Changing the information of multiple music files**
Press the ◀ or ▶ button to select the desired music in the Music list. Then press the yellow button.
Repeat the above operation to select multiple music files.
The ✓ mark appears to the left of the selected music file.
2. Press the **TOOLS** button.
3. Press the ▲ or ▼ button to select "Change Group Info". Press the **ENTER**  button.
 - WISELINK Pro identifies the mood of the music files and groups them accordingly by analyzing the music files on the USB device.
 - "Mood" information extracted from a music file may not always match the Mood option. For example, a file you think is "Energetic" may be extracted to the "Exciting" mood option.
4. Press the ◀ or ▶ button to select the desired mood option, then press the **ENTER**  button.
 - The group information is updated and the music files are moved to the new mood group.
 - "Mood" options: Energetic, Rhythmical, Sad, Exciting, Calm, Unclassified

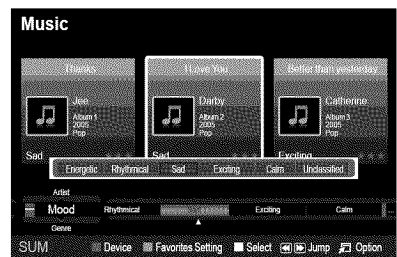

Genre

You can sort and play music files by genre.

1. Select "Genre" as the sorting standard in the Music List.
2. Press the ◀ or ▶ button to select from the sublist of music files grouped by Genre.
 - To move to the previous / next genre group, press the ◀◀ (REW) or ▶▶ (FF) button.
3. Press the **TOOLS** button.
4. Press the ▲ or ▼ button to select "Play Current Group".
5. Press **ENTER**  to play the selected group of music files from the sublist.



Folder

You can sort and play music files by folder.

- If there are many folders in USB, the files are shown in order in each folder. The music file in the Root folder is shown first and the others are shown in alphabetical order by name.
1. Select "Folder" as the sorting standard in the Music List.
 2. Press the ◀ or ▶ button to select from the sublist of music files grouped by Folder.
 - To move to the previous / next folder group, press the ◀◀ (REW) or ▶▶ (FF) button.
 3. Press the **TOOLS** button.
 4. Press the ▲ or ▼ button to select "Play Current Group".
 5. Press **ENTER**  to play the selected group of music files from the sublist.

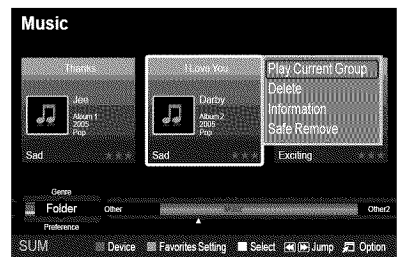



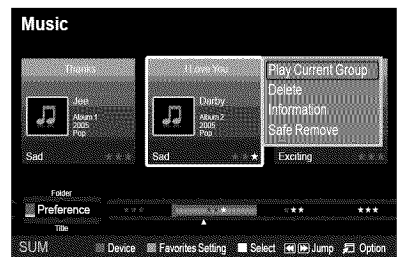

Preference

You can sort and play music files by preference. (Favorite)

1. Select "Preference" as the sorting standard in the Music List.
2. Press the ◀ or ▶ button to select from the sublist of music files grouped by Preference.
 - To move to the previous / next preference group, press the ◀◀ (REW) or ▶▶ (FF) button.
3. Press the **TOOLS** button.
4. Press the ▲ or ▼ button to select "Play Current Group".
5. Press **ENTER**  to play the selected group of music files from the sublist.



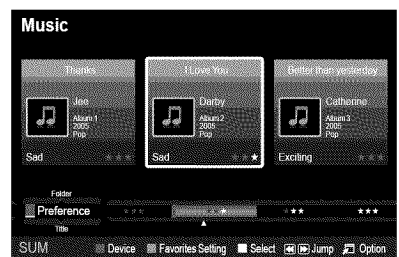

Changing the Favorites setting

- You can change a selected music file's (or group of files) preference information in order to move it from one preference group to another.
1. Press the ◀ or ▶ button to select the desired music in the music list.
 2. Press the Green button repeatedly until the desired setting appears.
 - Favorites settings change completed.
 - "Favorite" options:    
 - Users can select the number of stars (up to 3) according to their preference.
 - The stars are for grouping purposes only. For example, the 3 star setting does not have any priority over the one star setting.



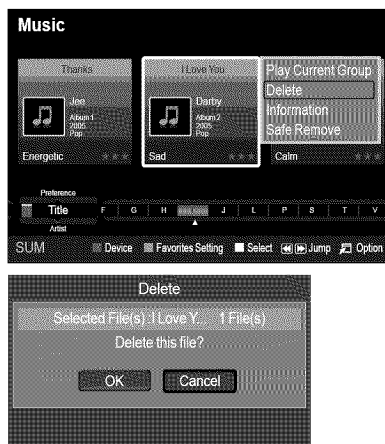

Deleting the Music file

1. Press the ◀ or ▶ button to select the desired music file in the music list.
2. Press the **TOOLS** button.
3. Press the ▲ or ▼ button to select "Delete", then press the **ENTER**  button.
 - The (for example) "Delete this file?" message appears.
4. Press the ◀ or ▶ button to select "OK", then press the **ENTER**  button.
 - The music is deleted.
 - When a read-only file is deleted, the "Read-only file(s). Delete the file(s)?" message appear.
 - If you select "Cancel", the deletion is cancelled.
5. To exit "WISELINK Pro" mode, press the **W.LINK** button on the remote control.
 - While removing files, don't remove the USB memory device.
 - You cannot recover deleted music files.



Deleting Multiple Music files

1. Press the ◀ or ▶ button to select the desired music in the music list. Then press the yellow button.
 - Repeat the above operation to select multiple music files.
 - The ✓ mark appears to the left of the selected music files.
2. Press the **TOOLS** button.
3. Press the ▲ or ▼ button to select "Delete selected File", then press the **ENTER**  button.
 - The "Delete the selected file(s)?" message appears.
4. Press the ◀ or ▶ button to select "OK", then press the **ENTER**  button.
 - The selected music files are deleted.
 - If you select "Cancel", the deletion is cancelled.
5. To exit "WISELINK Pro" mode, press the **W.LINK** button on the remote control.
 - You cannot remove the read-only files from the selected ones.
 - You cannot restore the deleted music files.

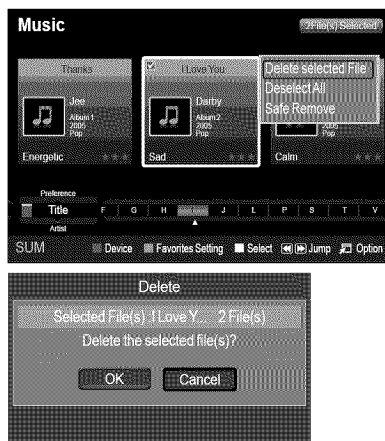

Viewing the Information

The music file information including the order of the file in the current directory, the name, the size, the date modified and the path is displayed.

1. Press the ◀ or ▶ button to select the desired music in the music list.
2. Press the **TOOLS** button.
3. Press the ▲ or ▼ button to select "Information", then press the **ENTER**  button.
 - The information on the selected file appears.

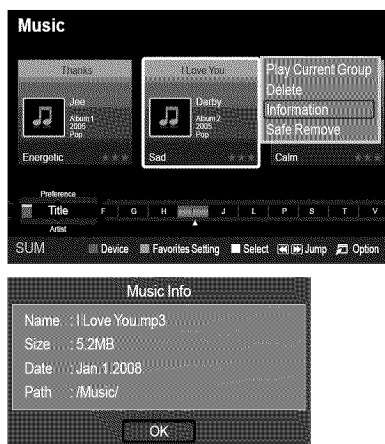

-  Press the **INFO** button to viewing the information.



Playing a Music File

Playing a music file

1. Press the **W.LINK** button on the remote control to display the "WISELINK Pro" menu.
2. Press the ◀ or ▶ button to select "Music", then press the **ENTER** button.
 - Music files are displayed.
3. Pressing the ◀ or ▶ button to select a music file to be played, then press the **ENTER** button.
 - This menu only shows files with the MP3 file extension. Files with other file extensions are not displayed, even if they are saved on the same USB device.
 - Press the **▶** (Play) / **ENTER** button over a music icon to play the music.
 - **◀◀** (REW) or **▶▶** (FF) buttons do not function during play.
 - Press the **⏸** (Pause) / **ENTER** button while playing a music file to pause the file. Press the **■** (Stop) button to exit Play mode.
 - The selected file is displayed at the top with its playing time.
 - To adjust the music volume, press the **VOL -** or **VOL +** button on the remote control. To mute the sound, press the **MUTE** button on the remote control.
 - The playing duration of a music file may be displayed as '00:00:00' if its playing time information is not found at the start of the file.
4. To exit "WISELINK Pro" mode, press the **W.LINK** button on the remote control.

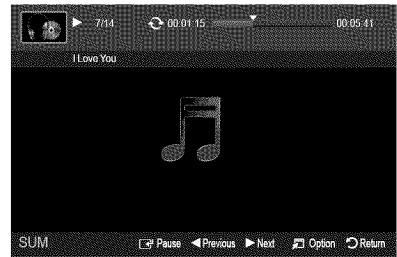
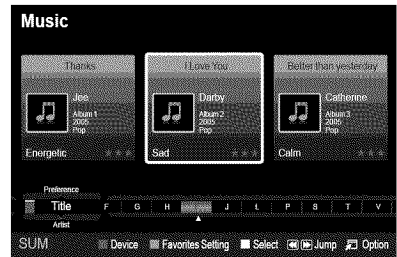

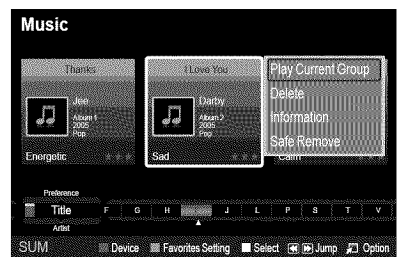

Playing the music group

1. Press the **W.LINK** button on the remote control to display the WISELINK Pro menu.
2. Press the ◀ or ▶ button to select "Music", then press the **ENTER** button.
 - To move to the previous / next group, press the **◀◀** (REW) or **▶▶** (FF) button.
3. Press the ◀ or ▶ button to select the desired music file.
4. Press the **TOOLS** button.
5. Press the ▲ or ▼ button to select "Play Current Group", then press the **ENTER** button.
 - The music files in the sorting group including the selected file are played.
6. To exit "WISELINK Pro" mode, press the **W.LINK** button on the remote control.





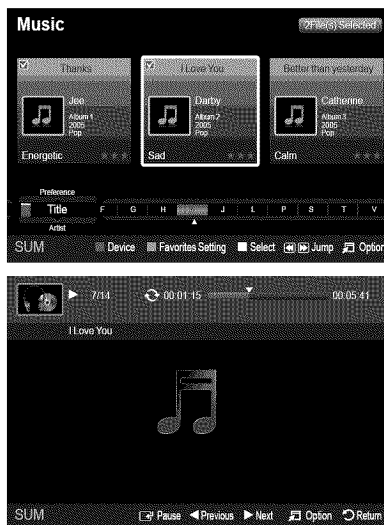

Playing the selected music files

1. Press the **W.LINK** button on the remote control to display the WISELINK Pro menu.
2. Press the ◀ or ▶ button to select "Music", then press the **ENTER** button.
3. Press the ◀ or ▶ button to select the desired music file, then press the yellow button. Repeat the above operation to select multiple music files.
 - > The ✓ mark appears to the left of the selected music file.
4. Press the  (Play) / **ENTER** button.
 - > Only the selected file is played.
 - > Press the  (Stop) button while playing to stop the current item and to return to the music list.
5. To exit "WISELINK Pro" mode, press the **W.LINK** button on the remote control.



Music function information icon (Displayed at the top left of the screen)

Icon	Current OSD	Function
	(Music) Repeat	When all music files in the folder(or the selected file) are repeated. "Repeat Mode" is "On".
	(Music) Once	When all music files in the folder(or the selected file) are played once. "Repeat Mode" is "Off".
	(Music) Play/Pause	When pressing the  (Play) /  (Pause) / ENTER button on the remote control while music is playing.

Repeating Music Play

1. While a Music file is playing, press the **TOOLS** button.
2. Press the ▲ or ▼ button to select "Repeat Mode".
3. Press the ◀ or ▶ button to select "On" or "Off".
 - **On:** Plays back all music files in the folder(or the selected file) repeatedly.
 - **Off:** Doesn't play back repeatedly.
4. To exit "WISELINK Pro" mode, press the **W.LINK** button on the remote control.

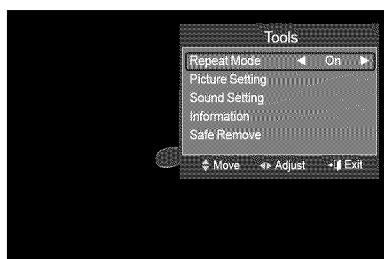

Picture Setting

You can set the Picture mode. (Refer to page 100)

Sound Setting

You can set the Sound mode. (Refer to page 100)

Information

The Music file information including the order of the file.

Safe Remove

You can remove the device safely from the TV.

Press the ▲ or ▼ button to select "Safe Remove", then press the **ENTER** button.

Remove the USB device from the TV.

Using the Movie List

This menu shows Movies files and folders saved on an USB memory device.

Movie List

- Press the **W.LINK** button on the remote control to display the "WISELINK Pro" menu.
- Press the **◀** or **▶** button to select "Movie", then press the **ENTER** button.
 - Movie files are displayed.
 - Press the **▶** (Play) / **ENTER** button over a movie icon to play the movie.
 - When moving to a movie, loading may take a few seconds. At this point, the loading icon will appear on the screen.
 - You can watch exciting gaming multimedia files, but the gaming function is not supported.
 - Movie doesn't support subtitles. (for example, not support smi, srt and sub files, etc and not support subtitles included in movie files)
 - Supported Video Formats

File Extension	Video Decoder	Resolution	Audio codec
avi	Xvid	800X600	PCM ADPCM
	H.264 MP	1920X1080	AC3
	MPEG4 SP	800X600	PCM ADPCM
	MPEG4 ASP	800X600	ADPCM
	MJPEG	800X600	PCM
mp4	H.264 BP	1920X1080	AAC PCM
	H.264 MP	1920X1080	AAC
	MPEG2	1920X1080	AC3
vro	MPEG2	1920X1080	AC3
vob	MPEG2	1920X1080	AC3

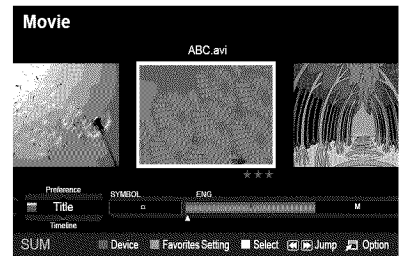

Screen Display

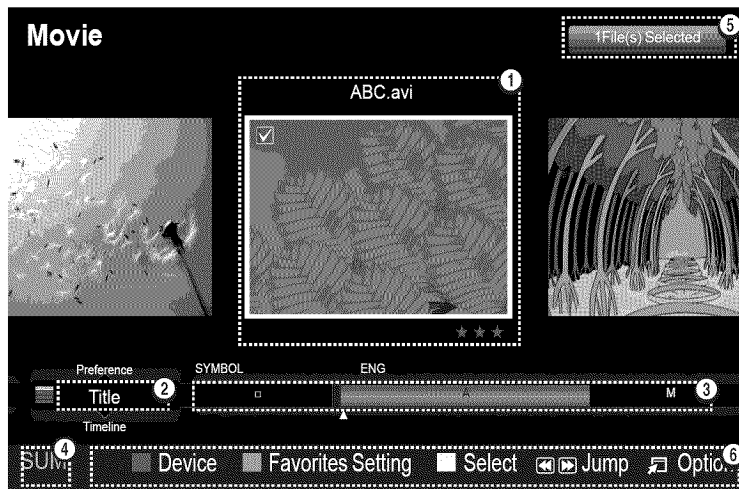

- Currently selected movie**
Shows the currently selected movie.
- Current Sort Standard**
Press the **▲** or **▼** button to change the standard for sorting Movies. ("Title", "Timeline", "Folder", "Preference")

3 View Groups

Shows the sorting groups. The sorting group including the currently selected movie is highlighted.

4 Current Device

Shows the currently selected device name. Press the Red button to select a device.

5 Item Selection Information

Shows the number of movie files that are selected by pressing the Yellow button.

6 Help Items

- **Red(Device) button:** Selects a connected device.
- **Green(Favorites Setting) button:** Changes the favorites setting for the selected movie. Press this button repeatedly until the desired value appears. (Refer to page 96)
- **Yellow(Select) button:** Selects movies from the movie list. Selected movies are marked with a symbol ✓ on the left.
- **◀▶▶ (Jump) button:** Jumps to the previous sorting group / Jumps to the next sorting group.
- **TOOLS(Option) button:** Displays the "Play Current Group", "Delete", "Information" or "Safe Remove" menus.

Sorting Movie List

You can sort movies in the Movie List by a particular standard.

1. Press the **W.LINK** button on the remote control to display the "WISELINK Pro" menu.
2. Press the **◀** or **▶** button to select "Movie", then press the **ENTER** button.
 - Movie files are displayed.
3. Press the **▲** or **▼** button to select a sorting standard. ("Title", "Timeline", "Folder", "Preference")
 - The movies are sorted according to the newly selected sorting standard.
 - Movie information is automatically set. You can change the "Favorite".

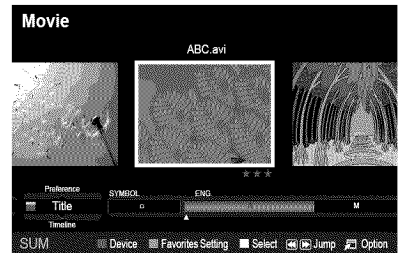

Title

You can sort and play movie files by title.

- It sorts and displays the Movie titles in alphabetical order.
1. Select "Title" as the sorting standard in the Movie List.
 2. Press the **◀** or **▶** button to select from the sublist of movie files grouped by Title.
 - To move to the previous / next title group, press the **◀◀** (REW) or **▶▶** (FF) button.
 3. Press the **TOOLS** button. Press the **▲** or **▼** button to select "Play Current Group".
 4. Press **ENTER** to play the selected group of movie files from the sublist.

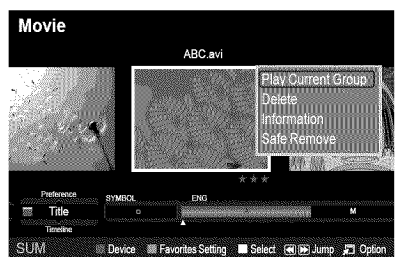

Timeline

You can sort and play movie files by timeline.

- It sorts and shows movies by date. It sorts by year and month from the earliest movie.
1. Select "Timeline" as the sorting standard in the Movie List.
 2. Press the ◀ or ▶ button to select from the sublist of movie files grouped by Timeline.
 - To move to the previous / next timeline group, press the ◀◀ (REW) or ▶▶ (FF) button.
 3. Press the **TOOLS** button. Press the ▲ or ▼ button to select "Play Current Group".
 4. Press **ENTER** to play the selected group of movie files from the sublist.

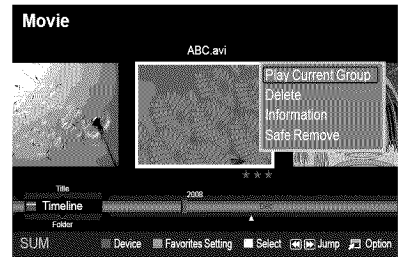

Folder

You can sort and play movie files by folder.

- If there are many folders in USB, the movies files are shown in order in each folder. The movie file in the Root folder is shown first and the others are shown in alphabetical order by name.
1. Select "Folder" as the sorting standard in the Movie List.
 2. Press the ◀ or ▶ button to select from the sublist of movie files grouped by folder.
 - To move to the previous / next folder group, press the ◀◀ (REW) or ▶▶ (FF) button.
 3. Press the **TOOLS** button. Press the ▲ or ▼ button to select "Play Current Group".
 4. Press **ENTER** to play the selected group of movie files from the sublist.

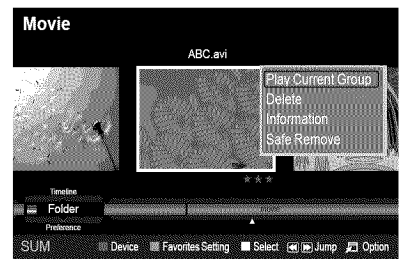

Preference

You can sort and play movie files by preference. (Favorite)

1. Select "Preference" as the sorting standard in the Movie List.
2. Press the ◀ or ▶ button to select from the sublist of movie files grouped by preference.
 - To move to the previous / next preference group, press the ◀◀ (REW) or ▶▶ (FF) button.
3. Press the **TOOLS** button. Press the ▲ or ▼ button to select "Play Current Group".
4. Press **ENTER** to play the selected group of movie files from the sublist.

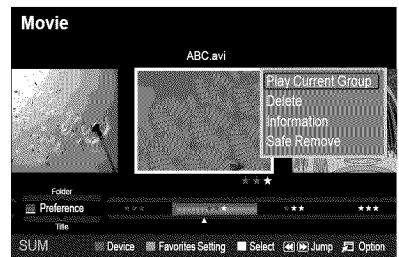

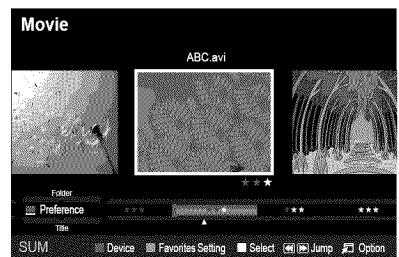

Changing the Favorites setting

- You can change a selected movie file's (or group of files) preference information in order to move it from one preference group to another.
1. Press the ◀ or ▶ button to select the desired movie in the movie list.
 2. Press the Green button repeatedly until the desired setting appears.
 - Favorites settings change completed.
 - "Favorite" options: ☆☆☆, ☆☆☆, ☆☆☆, ☆☆☆
 - Users can select the number of stars (up to 3) according to their preference.
 - The stars are for grouping purposes only. For example, the 3 star setting does not have any priority over the one star setting.



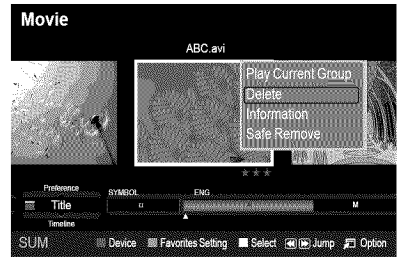

Deleting a Movie file

1. Press the ◀ or ▶ button to select the desired movie in the Movie list.
2. Press the **TOOLS** button.
3. Press the ▲ or ▼ button to select "Delete", then press the **ENTER**  button.
 - The "Delete this file?" message appears.
 - When a read-only file is deleted, the "Read-only file(s). Delete the file(s)?" message appear.
4. Press the ◀ or ▶ button to select "OK", then press the **ENTER**  button.
 - The movie is deleted.
 - If you select "Cancel", the deletion is cancelled.
5. To exit "WISELINK Pro" mode, press the **W.LINK** button on the remote control.
 - While deleting files, don't remove the USB memory device.
 - You cannot recover a deleted Movie file.



Deleting Multiple Movie files

1. Press the ◀ or ▶ button to select the desired movie in the movie list. Then press the yellow button.
 - Repeat the above operation to select multiple movie files.
 - The ✓ mark appears to the left of the selected movie files.
2. Press the **TOOLS** button.
3. Press the ▲ or ▼ button to select "Delete selected File", then press the **ENTER**  button.
 - The "Delete the selected file(s)?" message appears.
4. Press the ◀ or ▶ button to select "OK", then press the **ENTER**  button.
 - The selected movie files are deleted.
 - If you select "Cancel", the deletion is cancelled.
5. To exit "WISELINK Pro" mode, press the **W.LINK** button on the remote control.
 - You cannot remove read-only files.
 - You cannot restore the deleted Movie files.

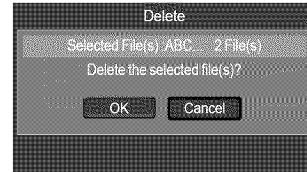
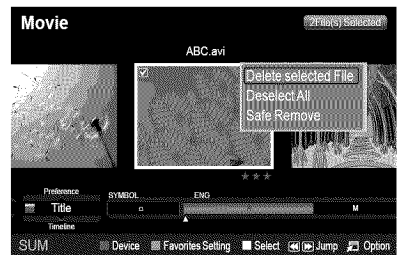

Viewing the Movie Information

The movie file information including the order of the file in the current directory, the name, the size, the date modified and the path is displayed.

1. Press the ◀ or ▶ button to select the desired movie in the movie list.
2. Press the **TOOLS** button.
3. Press the ▲ or ▼ button to select "Information", then press the **ENTER**  button.
 - The information on the selected movie appears.

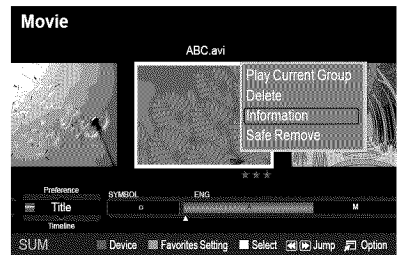

 Press the **INFO** button to viewing the information.



Playing a Movie File

Playing a movie file

1. Press the **W.LINK** button on the remote control to display the "WISELINK Pro" menu.
2. Press the ◀ or ▶ button to select "Movie", then press the **ENTER** button.
3. Pressing the ◀ or ▶ button to select a movie to be played, then press the **ENTER** button.
 - The selected file is played.
 - Press the ▶ (Play) / **ENTER** button over a movie icon to play the movie.
 - Press the ⏸ (Pause) / **ENTER** button while playing a movie file to pause the file. Press the ⏹ (Stop) button to exit Play mode.
 - The selected file is displayed at the top with its playing time.
 - The playing duration of a movie file may be displayed as '00:00:00' if its playing time information is not found at the start of the file.
 - Press the ◀ button while playing a video file to rewind by 20 seconds
 - Press the ▶ button to fast forward by 20 seconds.
4. To exit "WISELINK Pro" mode, press the **W.LINK** button on the remote control.

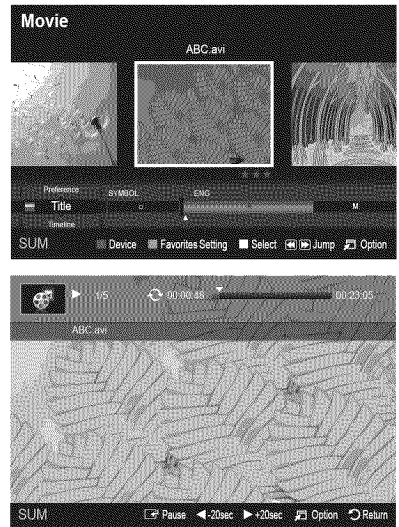

Playing the movie group

1. Press the **W.LINK** button on the remote control to display the "WISELINK Pro" menu.
2. Press the ◀ or ▶ button to select "Movie", then press the **ENTER** button.
3. Press the ◀ or ▶ button to select the desired movie file.
4. Press the **TOOLS** button.
5. Press the ▲ or ▼ button to select "Play Current Group", then press the **ENTER** button.
 - The movie files in the sorting group including the selected file are played.
6. To exit "WISELINK Pro" mode, press the **W.LINK** button on the remote control.

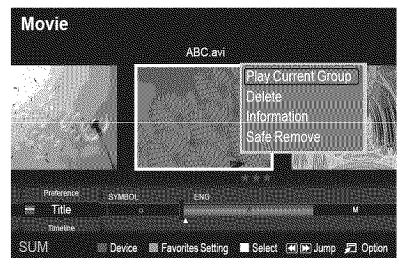

Playing the selected movie files

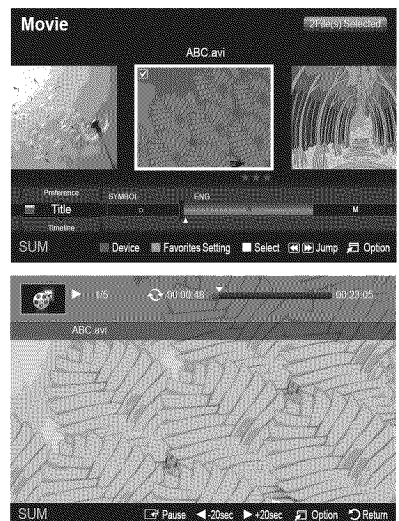

1. Press the **W.LINK** button on the remote control to display the "WISELINK Pro" menu.
2. Press the ◀ or ▶ button to select "Movie", then press the **ENTER** button.
3. Press the ◀ or ▶ button to select the desired movie file, then press the yellow button. Repeat the above operation to select multiple movie files.
 - The ✓ mark appears to the left of the selected movie file.
4. Press the ▶ (Play) / **ENTER** button.
 - Only the selected file is played.
 - Press the ⏹ (Stop) button while playing to stop the current item and to return to the movie list.
5. To exit "WISELINK Pro" mode, press the **W.LINK** button on the remote control.



Playing movie continuously







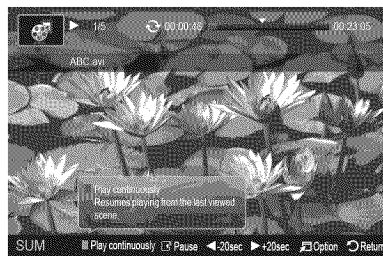

If you exit playing movie, playing it continuously later is possible.

With 'Play continuously' function, you can watch movie without watching again from beginning or bothering searching.

1. Select movie file you want to 'Play continuously' by pressing ◀ or ▶ button from the Movie List.
2. Press the  (Play) / **ENTER**  button.
3. Select 'Play continuously' by pressing Blue button.
 - Movie will begin to play from where it was stopped being played.
 - If "Continuous Movie Play Help" function was set "On", a pop-up message will appear when you play movie file you want to "Play continuously". (Refer to page 101)
4. To exit "WISELINK Pro" mode, press the **W.LINK** button on the remote control.



Movie function information icon (Displayed at the top left of the screen)

Icon	Current OSD	Function
	(Movie) Repeat	When all movie files in the folder(or the selected file) are repeated. "Repeat Mode" is "On".
	(Movie) Once	When all movie files in the folder(or the selected file) are played once. "Repeat Mode" is "Off".
	(Movie) Play/Pause	When pressing the  (Play) /  (Pause) / ENTER  button on the remote control while movie is playing.
	(Movie) x2 Play	When pressing the  (FF) button on the remote control while movie is playing.

Repeating Movie Play

1. While a Movie file is playing, press the **TOOLS** button.
2. Press the ▲ or ▼ button to select "Repeat Mode".
3. Press the ◀ or ▶ button to select "On" or "Off".
 - **On**: Plays back all movie files in the folder(or the selected file) repeatedly.
 - **Off**: Doesn't play back repeatedly.
4. To exit "WISELINK Pro" mode, press the **W.LINK** button on the remote control.

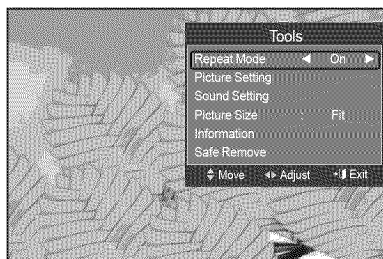

Picture Setting

You can set the Picture mode. (Refer to page 100)

Sound Setting

You can set the Sound mode. (Refer to page 100)

Picture Size

- **Fit**: Play video to fit the TV's screen size.
- **Original**: Play video at the original size.

Information

The Movie file information including the order of the file.

Safe Remove

You can remove the device safely from the TV.

Press the ▲ or ▼ button to select "Safe Remove", then press the **ENTER**  button.

Remove the USB device from the TV.

Picture/Music Settings Using WISELINK

When watching a Slide Show or listening to music using WISELINK, you can set the picture and sound.

Picture Setting

1. Press the **TOOLS** button during a Slide Show or while music is playing.
2. Press the **▲** or **▼** button to select "Picture Setting".
3. Press the **◀** or **▶** button to select the "Picture Mode" ("Dynamic", "Standard", or "Movie").
4. Press the **▲** or **▼** button to move to an item. ("Contrast", "Brightness", "Color", "Dynamic Contrast", "Black Adjust", "Auto Motion Plus 120Hz" or "Reset")
 - > Select "Reset" to initialize the picture settings.
5. Press the **◀** or **▶** button to adjust the settings.
 - > For more information on the picture settings, refer to pages 28~32.

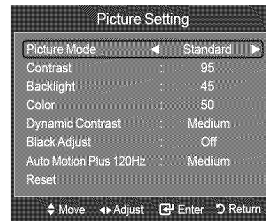
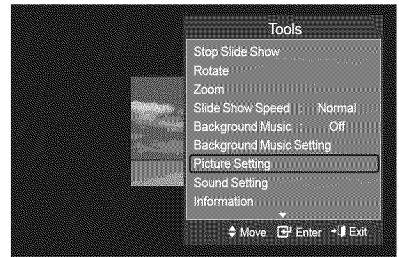

Sound Setting

1. Press the **TOOLS** button during a Slide Show or while music is playing.
2. Press the **▲** or **▼** button to select "Sound Setting".
3. Press the **◀** or **▶** button to select the "Sound Mode". ("Standard", "Music", "Movie", "Speech", or "Custom")
4. Press the **▲** or **▼** button to move to an item.
 - > Select "Reset" to initialize the sound settings.
5. Press the **◀** or **▶** button to adjust the settings.
 - > For more information on the sound settings, refer to pages 40~41.

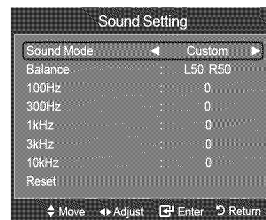
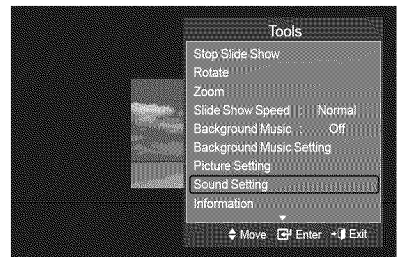

Using the Setup Menu

Setup displays the user settings of the WISELINK Pro menu.

1. Press the **W.LINK** button on the remote control to display the WISELINK Pro menu.
2. Press the **◀** or **▶** button to select "Setup", then press the **ENTER** button.
3. Press the **▲** or **▼** button to select the desired option. (Slide Show Speed, Music Repeat Mode, Movie Repeat Mode, Screen Saver Run Time, Information, Safe Remove)
4. Press the **◀** or **▶** button to select the option, then press the **ENTER** button.
 - > To exit WISELINK Pro mode, press the **W.LINK** button on the remote control.



Slide Show Speed

Select to control the slide show speed.

Press the ▲ or ▼ button to select "Slide Show Speed".

Press the ◀ or ▶ button to select "Fast", "Normal" or "Slow".

Music Repeat Mode

Select to repeatedly play music files.

Press the ▲ or ▼ button to select "Music Repeat Mode".

Press the ◀ or ▶ button to select "On" or "Off".

Movie Repeat Mode

Select to repeatedly play movie files.

Press the ▲ or ▼ button to select "Movie Repeat Mode".

Press the ◀ or ▶ button to select "On" or "Off".

Continuous Movie Play Help

Select to display the help pop-up message for continuous movie playback.

Press the ▲ or ▼ button to select "Continuous Movie Play Help".

Press the ◀ or ▶ button to select "On" or "Off".

Screen Saver Run Time

Select to set the waiting time before the screen saver appears.

Press the ▲ or ▼ button to select "Screen Saver Run Time".

Press the ◀ or ▶ button to select "1 min", "3 min" or "5 min".

Information

Select to viewing the information of the connected device.

Press the ▲ or ▼ button to select "Information", then press the **ENTER**  button.

Safe Remove

You can remove the device safely from the TV.

Press the ▲ or ▼ button to select "Safe Remove", then press the **ENTER**  button.

Remove the USB device from the TV.

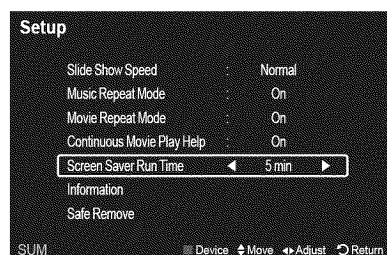
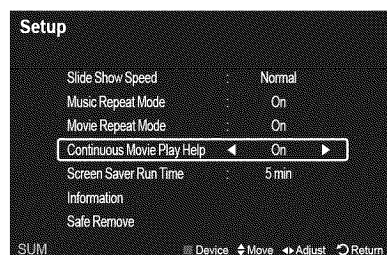
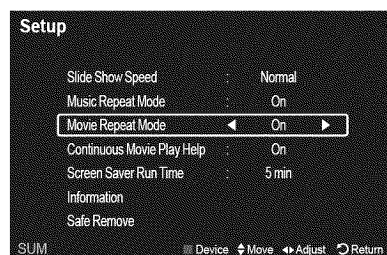
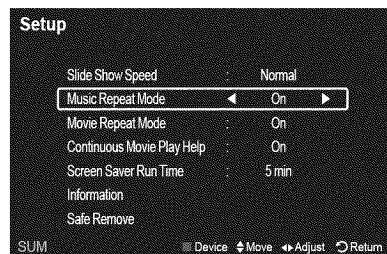
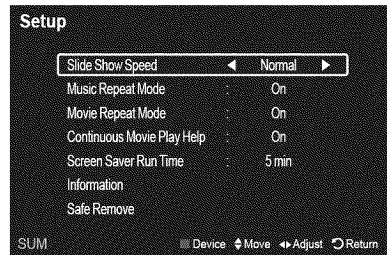

Setting the DLNA Network

DLNA allows you to watch videos and pictures saved on your PC on your TV through a network connection in Wiselink Pro mode. This removes the need to copy them to a USB storage device and then connect the device to your TV. To use DLNA, the TV must be connected to the network and the DLNA application must be installed on your PC.

Network Connections Diagram

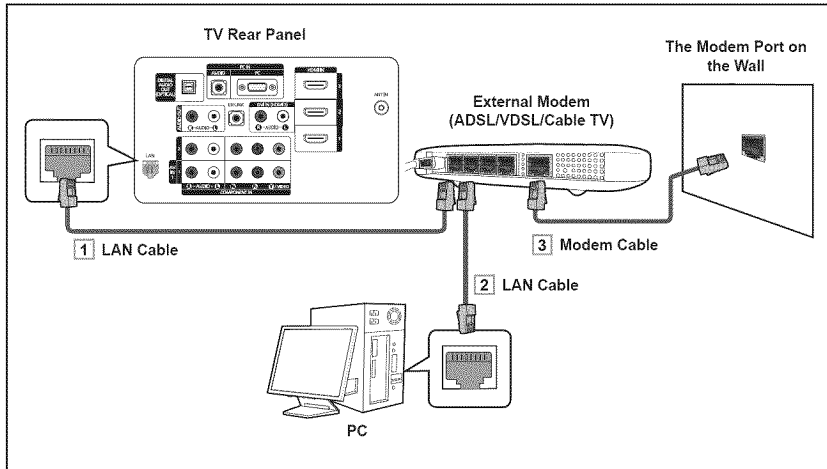

1. Connect the [LAN] port on the rear panel of the TV to the external modem with a LAN Cable.
2. Connect the PC to which the "DLNA PC Share Manager" program will be installed and the external modem using a LAN cable.
3. Connect the LAN port on the wall and the external modem with a Modem Cable.

Connecting to the Network

1. When connecting to the network is complete, set up the network on the TV (see page 121).
 - A Wireless Internet connection does not support DLNA.
 - The first 3 digits (subnet address) of the IP addresses of the TV and the PC must be the same (e.g. IP Address: 123.456.789.XX)
2. Run a "Network Test" to check the network settings (see page 122).

Installing the DLNA Application

To play content on the PC on the TV, you have to first install the application.

System Requirements

1. Insert the Program CD supplied with this TV into your PC.
2. 20MB of free hard disk space is needed for the program installation.
 - If you share files, up to 20MB of hard disk drive space is required for each 100 files.
 - If you cancel file sharing, the hard disk drive space used for the thumbnail information is also freed.

Supported Formats

1. Image : JPEG (jpg, jpeg)
2. Audio : MP3 (mp3)
3. Video : MPEG1(mpg, mpeg), MPEG2 PS/TS(mpg, mpeg, trp, ts, tp), divx(mpg, mpeg, avi), MPEG4 / H.264 (mpg, mpeg)

Install the application

1. Run the Setup.exe file on the Program CD supplied with the product.
 - Alternatively, you can download the file from www.samsung.com.
2. Install the SAMSUNG PC Share Manager as shown in the figures below.

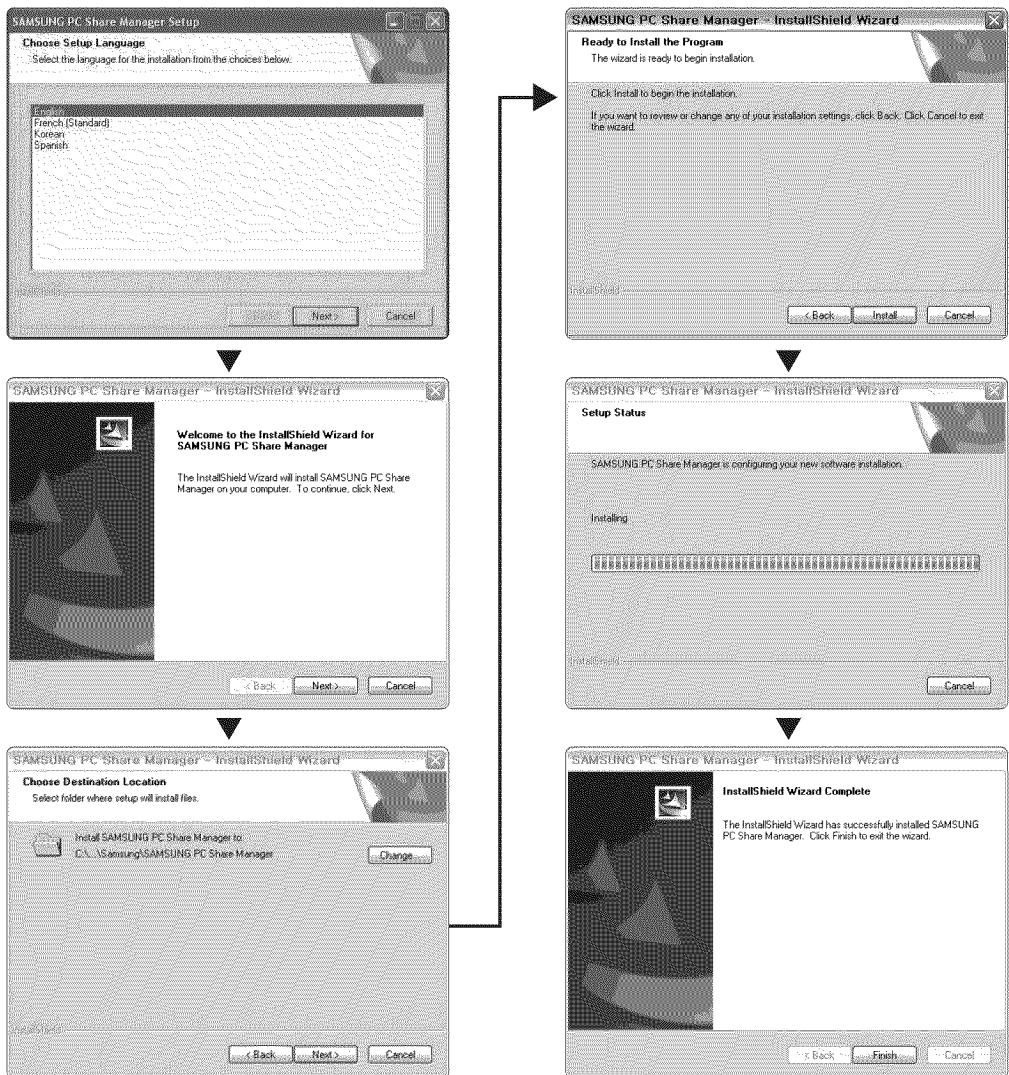

3. When the installation is complete, the PC Share Manager icon appears on your Desktop.
 - Double-click the icon to run the program.

Using the DLNA Application

The Program Screen Layout

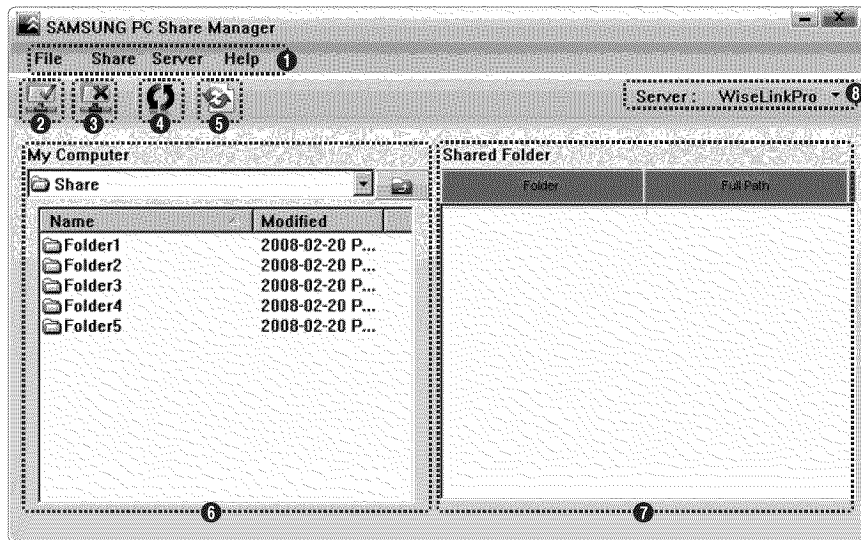

1. Menus: The following application menus are provided : "File", "Share", "Server", and "Help".
2. Click to share the selected PC server folder (see page 106)
3. Click to cancel sharing (see page 106)
4. Click to refresh the PC folder and files.
5. Click to synchronize the share status (see page 107)
6. The folders and files of the PC to be shared are listed.
7. Folders shared by the user are listed.

File

Property: Shows information on the selected file or folder.

Method 1: Select a file or folder and select the “File” menu and then select the “Property” sub-menu.

Method 2: Select a file or folder, right-click over the selected file or folder and then select “Property” from the pop-up menu.

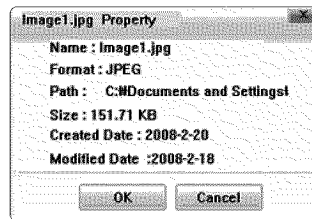
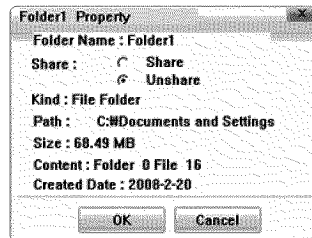
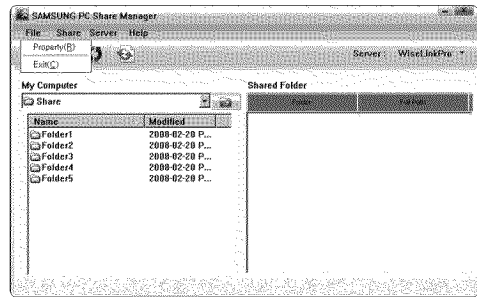

Exit: Exits the DLNA application.

If you select “Exit” without applying the changes after changing the shared status, a message will appear asking if you want to apply the changed settings to the PC. Select “Yes” to apply the changes and exit the application.

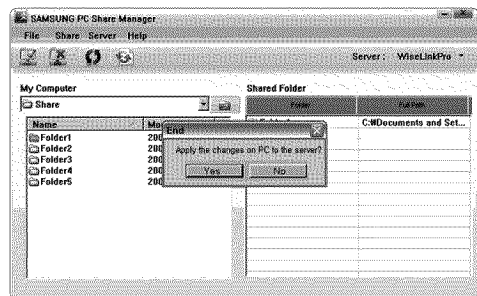

Share

Sharing a Folder

You can share a folder from your PC to the TV.
The maximum number of folders that can be shared is 32.
> Your PC will operate as a server to the TV.

Method 1: Select a folder in "My Computer", select the "Share" menu and then select the "Share Folder" sub-menu.

Method 2: Select a folder in "My Computer", right-click over the selected folder and then select "Share Folder" from the pop-up menu.

Method 3: Locate the mouse pointer over a folder in the "My Computer" folder list in the left pane and drag&drop the folder into the Shared Folders pane. If a message appears asking you to confirm the shared folder, select "Yes".

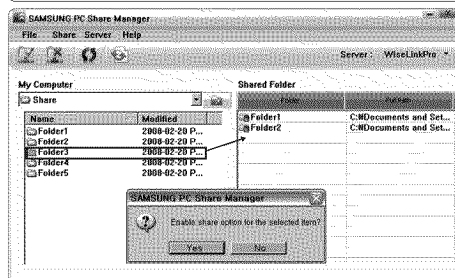
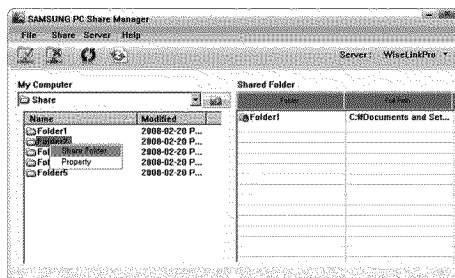
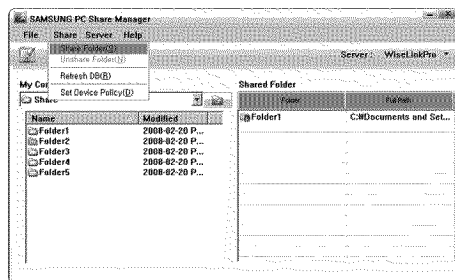

Canceling a Shared Folder

You can cancel a shared folder on your PC. Select a folder from the "Shared Folder" pane and select "Unshare Folder".

Method 1: Select a folder from the "Shared Folder" pane, select the "Share" menu and then select "Unshare Folder".

Method 2: Select a folder from the "Shared Folder" pane, right-click over the selected folder and then select "Unshare Folder" from the pop-up menu.

Method 3: Locate the mouse pointer over a folder in the "Shared Folder" pane and drag&drop the folder into the "My Computer" pane. If a message appears asking you to confirm the cancelation, select "Yes".

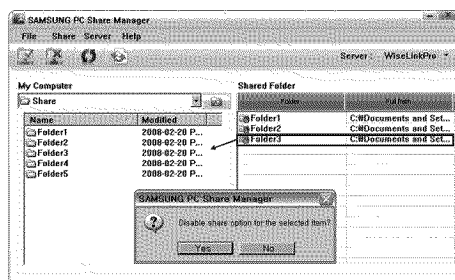
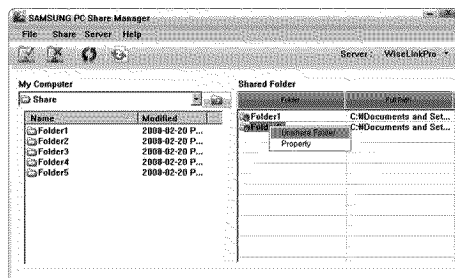
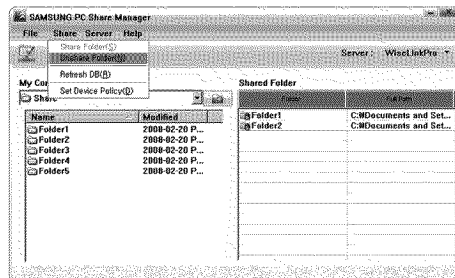

Applying the Current Settings

Perform this when synchronization is necessary due to a new shared folder or canceling a shared folder. The "Set Changed State" menu applies changes to shared folders to the data saved with the PC share program.

Since applying changes to the internal data is a time-consuming process, this function enables users to apply changes to the data only when required.

Until the "Set Changed State" menu is selected, the changed state of the shared folder is not applied to the server.

Changes to the shared folders are not applied to your PC until you select the "Set Changed State" menu.

Method 1: Select the "Share" menu and select the "Refresh DB" sub-menu.

Method 2: Click the "Set Changed State" icon.

Setting the Access Permission

To enable the TV to find your PC, the TV must be set to "Set Device Policy" in the Access Permission Settings window. In addition, the PC server and the TV must be on the same subnet.

Method: Select the "Share" menu and select "Set Device Policy".

- Rejected items are represented in gray.
- You can change the access permissions by using the Allow "Accept"/"Deny" button.
- To delete an item, select the item and select "Delete Item".

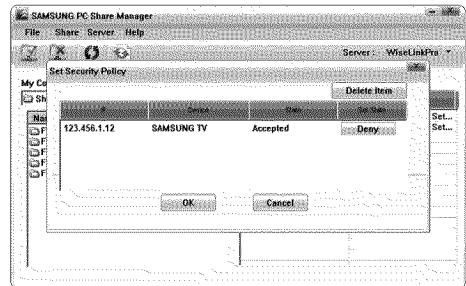
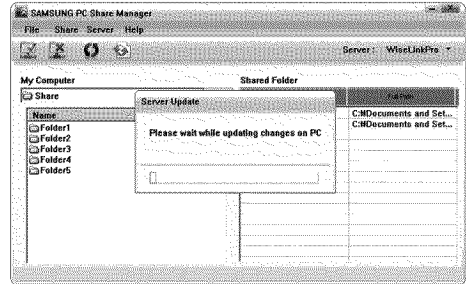
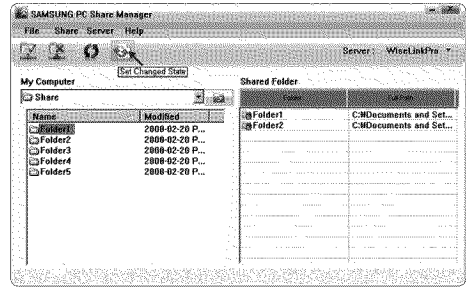

Server

Server

You can run or stop using your PC as a server.

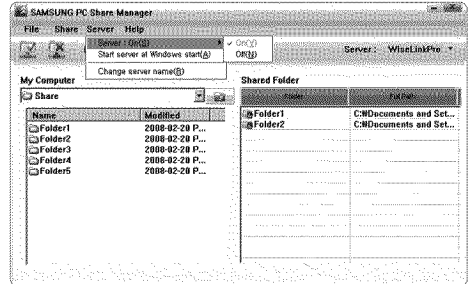

Start Server at Windows start

You can determine whether to start the PC server automatically when Windows starts.

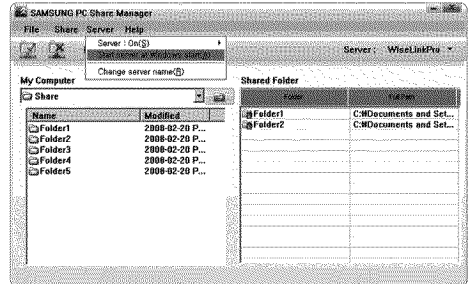

Change server name

You can rename the PC server. Enter a new name and click "OK". The new name will appear at the top right of the window and will appear on the TV.

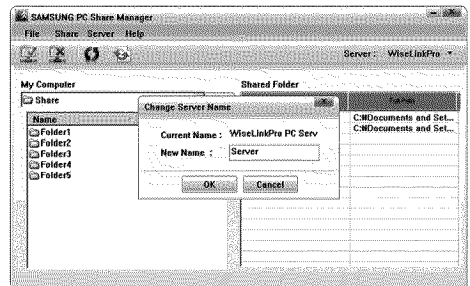

Help

Version

The program version information message box appears.

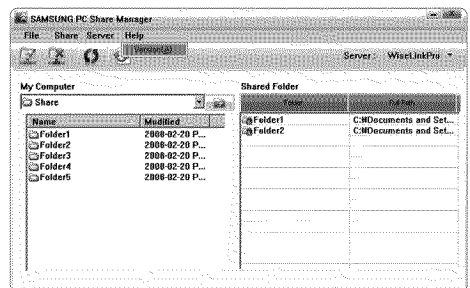

Using the DLNA Function

Using the DLNA Menu

DLNA (Digital Living Network Alliance) enables content saved on a DLNA server (usually your PC) connected to your TV or over a network to be played.

Wiselink Pro enables playing content saved on a USB memory device connected to the TV, while DLNA enables playing content saved on a DLNA server (your PC) connected to your TV or over the network. The procedures to use the content are the same as those for WISELINK Pro.

➤ If you install the PC share manager program supplied with the TV onto a PC, you can have the PC perform the role of a DLNA server over the network.

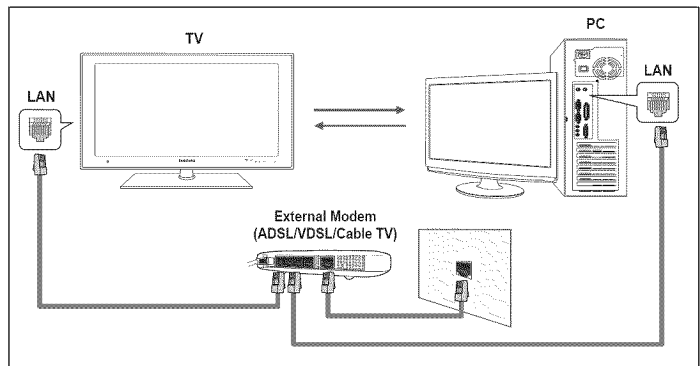

1. Press the **W.LINK** button on the remote control to display the “DLNA” menu.
2. Press the ◀ or ▶ button to select an icon (Photo, Music, Movie, Setup), then press the **ENTER** button.
 - To exit “DLNA” mode, press the **W.LINK** button on the remote control.

Photo

◆ Photo List

- Sorting Photo List: Refer to page 78
- Viewing the Information: Refer to page 82
- Rotating the Photo file: Refer to page 81
- Viewing a Slide Show: Refer to page 83

◆ During a Slide Show

- Play & Pause: Refer to page 83
- Slide Show Speed: Refer to page 85
- Zoom: Refer to page 85
- Rotate: Refer to page 84

➤ If the user has rotated the photo, the orientation of the photo will return to its original state when the user exits the DLNA application or exits WISELINK Pro mode.

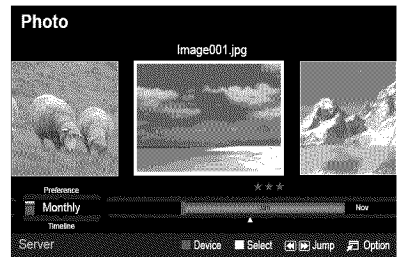

Music

◆ Music List

- Sorting Music List: Refer to page 88
- Viewing the Information: Refer to page 91
- Playing a music file: Refer to page 92

◆ While Playing a Music File

- Play & Pause: Refer to page 93
- Repeat Mode: Refer to page 93

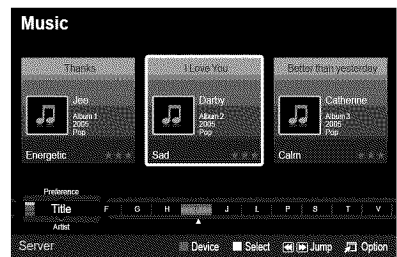

Movie

- ◆ Movie List
 - Sorting Movie List: Refer to page 95
 - Viewing the Information: Refer to page 97
 - Playing a Movie file: Refer to page 98
- ◆ While Playing a Movie File
 - Play & Pause: Refer to page 99
 - Repeat Mode: Refer to page 99

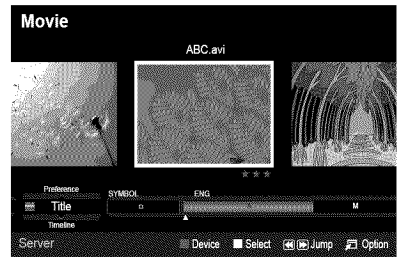

Setup

- Slide Show Speed: Refer to page 101
- Music Repeat Mode: Refer to page 101
- Movie Repeat Mode: Refer to page 101
- Screen Saver Run Time: Refer to page 101
- Information: Refer to page 101

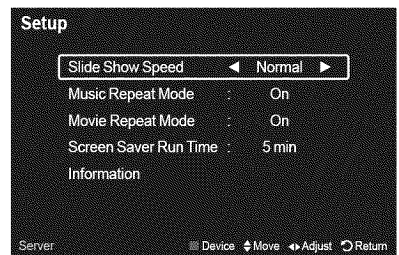

- DLNA does not support the following functions.
 - The Background Music and Background Music Setting functions.
 - Sorting files by preference in the Photo, Music, and Movie folders.
 - The Change Group Info function.
 - The Delete function.
 - The Safe Remove function.
 - The REW/FF (◀ / ▶) key functions while a movie is playing.
 - Function to watch continuously when playing movie.
- The Skip (◀ / ▶ keys) or Pause function may not work while a movie is playing for the DLNA of other manufacturers, depending on the corresponding content information.
- The playing time may not be displayed while a movie is playing.



Content Library

Using the Content Library

The "Content Library" enables you to view or play the built-in contents on the TV or stored on your USB device.

> The Delete, Move and Update functions will not work with the built-in content on the TV.

Using the Content Library Menu

1. Press the **MENU** button. Press the **▲** or **▼** button to select "Application", then press the **ENTER**  button.
2. Press the **▲** or **▼** button to select "Content Library", then press the **ENTER**  button.
 - > The "Content Library" main menu is displayed.

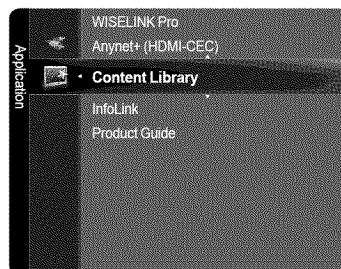

-  Press the **CONTENT** button on the remote control to display the "Content Library" menu.

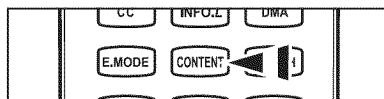

3. Press the **◀** or **▶** button to select an icon (Gallery, Cooking, Game, Children, Fitness), then press the **ENTER**  button.
 - > To return to TV mode, press the **CH** **▼/▲** button on the remote control.
 - > If you press the Volume or **MUTE** button, no OSD is displayed, but the function operates accordingly.

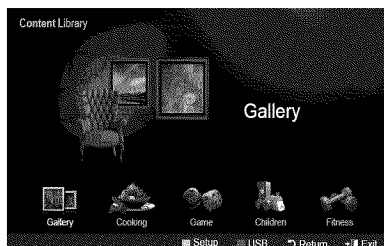

Using the Remote Control Button in Content Library Menu

Button	Operations
Wheel (▲/▼/◀/▶)	Move the cursor and select an item.
ENTER 	Select the currently selected item.
RETURN	Return to the previous menu.
EXIT	Stop the current function and return to the "Content Library" main menu.
CH ▼/▲ PRE.CH / FAV.CH / CH.LIST	Stop Content Library mode and Returns to TV mode.
Color button	Keys that provide functions are described on the corresponding page.
VOL ▼/▲	You can control the volume of the played content.
CONTENT	Exit Content Library mode.



Using the TV Memory Contents

The built-in contents of the "Content Library" are composed of the following sub-categories: "Gallery", "Cooking", "Game", "Children", and "Fitness".

Gallery

This function plays a SlideShow with high resolution images and background music and produces various atmospheres.

Using the Gallery function of the TV, you can change your home atmosphere.

1. Press the ◀ or ▶ button to select "Gallery" in the "Content Library" main menu.
Then press the **ENTER**  button.
2. Press the ▲ or ▼ button to select "Art", "Relaxation" or "Party", then press the **ENTER**  button.
 - The selected slide show is played.
 - There is default music for each for the "Art", "Relaxation", and "Party" options.
3. Press the yellow button to playback all images.
 - To return to "Content Library" main menu, press the **EXIT** button.
 - To exit "Content Library" mode, press the **CH**  button on the remote control.

- **Art:** You can view masterpieces of the impressionists including Van Gogh, Monet, Degas, Cezanne, etc.
- **Relaxation:** You can view beautiful and serene images of nature.
- **Party:** You can view images that can produce a cheerful and exciting atmosphere.

- The copyrights of the "Gallery" contents and all issues related to them are reserved by Gallery Player, Inc.
- For additional "Gallery" contents, check for information through www.samsung.com. Please refer to the "Using Additional Content Using External USB Memory Storage" section (page 117) to see how to play additional imagery.

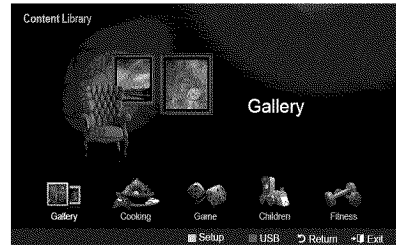

CONTENT LIBRARY CONTAINS TEXT, GRAPHICS, IMAGES, MULTIMEDIA, AND OTHER MATERIALS FOR INFORMATIONAL AND PROMOTIONAL PURPOSES ONLY. MATERIALS IN CONTENT LIBRARY HAS BEEN MODIFIED AND KEEPS BEING REVISED AND UPDATED. THE MATERIALS IN THE CONTENT LIBRARY MAY NOT BE SUITABLE FOR ALL AUDIENCES. INFORMATION IN THE CONTENT LIBRARY IS PROVIDED "AS IS." ALTHOUGH THE INFORMATION PROVIDED TO YOU IN THE CONTENT LIBRARY IS OBTAINED OR COMPLIED FROM SOURCES WE BELIEVE TO BE RELIABLE, SAMSUNG CANNOT AND DOES NOT GUARANTEE THE ACCURACY, VALIDITY, TIMELINESS OR COMPLETENESS OF ANY INFORMATION OR DATA MADE AVAILABLE TO YOU FOR ANY PARTICULAR PURPOSE. UNDER NO CIRCUMSTANCES, INCLUDING NEGLIGENCE, SHALL SAMSUNG BE HELD LIABLE, WHETHER IN CONTRACT OR TORT, FOR ANY DIRECT, INDIRECT, INCIDENTAL, SPECIAL OR CONSEQUENTIAL DAMAGES, ATTORNEY FEES, EXPENSES, OR ANY OTHER DAMAGES WHATSOEVER ARISING OUT OF, OR IN CONNECTION WITH, ANY INFORMATION CONTAINED IN, OR THE USE OF, THE CONTENT LIBRARY, EVEN IF ADVISED OF THE POSSIBILITY OF SUCH DAMAGES.

Cooking

You can view various recipes that you can then easily follow step by step. Enjoy these contents which give you great ideas for meals.

1. Press the ◀ or ▶ button to select "Cooking" in the "Content Library" main menu.
Then press the **ENTER**  button.

2. Press the ▲ or ▼ button to select "Starters", "Main Courses" or "Dessert", then press the **ENTER**  button.

- **Starters:** Selection of light meals and starters to bring your appetite.
- **Main Courses:** Most popular recipes of Chicken, Seafood, Vegetables, and Grill.
- **Desserts:** Wide choice of sweet treats and fancy beverages.

- The recipes introduced in the "Cooking" contents on the Samsung TV are based on recipes published by Anness Publishing.
- The copyrights of the "Cooking" contents and all issues related to them are reserved by Practical Pictures.

3. Press the ▲ or ▼ button to select a particular item.
Press the **ENTER**  button.

4. Press the ▲, ▼, ◀ or ▶ button to select a recipe you want to use.
Then press the **ENTER**  button.

5. Press the ▲, ▼, ◀ or ▶ button to use a recipe.
 - To return to "Content Library" main menu, press the **EXIT** button.
 - To exit "Content Library" mode, press the **CH** /▲ button on the remote control.

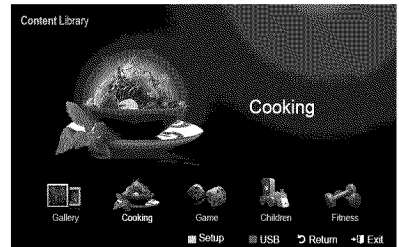



Game

This category provides entertainment games for the whole family.

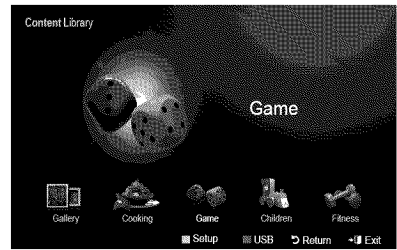
1. Press the ◀ or ▶ button to select "Game" in the "Content Library" main menu.
Then press the **ENTER**  button.



2. Press the ▲ or ▼ button to select "Dynamic Bowling", "Minimini Cook", "Mini Game Pack", "IQ Academy" or "Sudoku+", then press the **ENTER**  button.

- For the buttons used in the games, refer to the directions on the screen.
- To return to "Content Library" main menu, press the **EXIT** button.
- To exit "Content Library" mode, press the **CH**  button on the remote control.

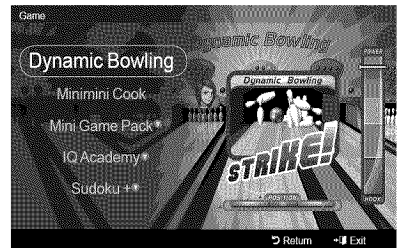

- **Dynamic Bowling:** A realistic bowling game enjoyable on your TV. To achieve victory select the best position and power that enables you to hit a strike.
- **Minimini Cook:** A cooking game that allows you to cook delicious foods. If you play all the mini-games for each type of food, the food is completely cooked and a customer character eats the food. The greater the number of failures during the mini-games, the worse the reaction displayed by the customer character. If you avoid failure completely, the customer character eats your finished food!
- **Mini Game Pack:** This is a collection of one-button games that you can play with the **ENTER**  button only. Since operating the game is easy, the whole family can enjoy this game. Each game will give you a different delight.
- **IQ Academy:** A brain training game the whole family can enjoy. This game improves your power to think fast, memorize and calculate by letting you solve problems within a specified time. The problems start at the elementary school level. You have to take examinations whenever your score exceeds the threshold. If you pass the examination, you change to a higher grade. If you graduate from university, you have completed the game.
- **Sudoku+:** Now you can enjoy world-famous Sudoku (Magic Square) on the TV. The objective is to fill a 9×9 grid so that each column, each row, and each of the nine 3×3 boxes contains digits 1 to 9.

- For the 5 embedded games, the copyrights and all issues related to them are reserved by the corresponding game providers.
- More detail instructions on how to play a game is given at the beginning of each game page.
- Mini Game Pack, IQ Academy and Sudoku+ are trial versions. You can purchase a full version or additional games at www.samsung.com or www.nurisam.com

Color Buttons for Games

Button	Operations
Red	Press to move to the game home screen
Green	Press to pause the game
Yellow	Option Key
Blue	Press to exit the game

Children

This is educational and interactive content that children can watch repeatedly. Enjoy existing stories, songs and games with the Boowa and Kwala characters.

1. Press the ◀ or ▶ button to select "Children" in the "Content Library" main menu.
Then press the **ENTER**  button.

2. Press the ▲ or ▼ button to select "Story", "Song" or "Play", then press the **ENTER**  button.

- **Story:** You can watch storytelling content with the Boowa and Kwala characters.
- **Song:** You can enjoy Sing Along content with the Boowa and Kwala characters.
- **Play:** You can enjoy exciting and fun interactive games using the remote control.

- The copyrights of the "Children" contents and issues related to them are reserved by UpToTen.

3. Press the ▲ or ▼ button to select an item to play. Press the **ENTER**  button.

The selected content is played.

- To return to "Content Library" main menu, press the **EXIT** button.
- To exit "Content Library" mode, press the **CH**  button on the remote control.

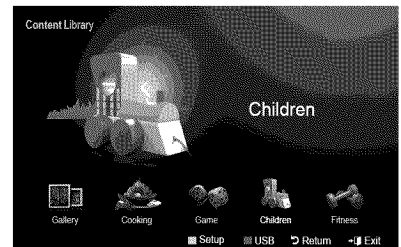

Fitness

This is beneficial health management content that provides stretching and massage exercises that can be enjoyed by the whole family.

1. Press the ◀ or ▶ button to select "Fitness" in the "Content Library" main menu.
Then press the ENTER button.

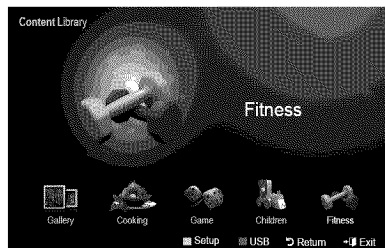

2. Press the ▲ or ▼ button to select "Basic Stretches" or "Massage", then press the ENTER button.

- **Basic Stretches:** Follow the stretching exercises provided by detailed descriptions and slow motion images step by step.
- **Massage:** Manage your health and release your stress through the easy to follow massages.

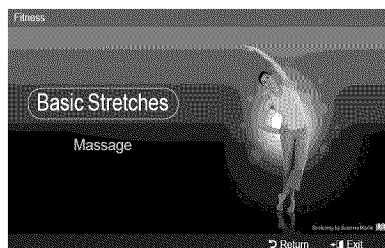

- The "Basic Stretches" contents for the Samsung TV are based on the book *Stretching* by Suzanne Martin which is published by DK and the "Massage" contents are based on the books published by Anness Publishing.
- The copyrights to "Basic Stretches" are reserved by the DK Publishing Company. The copyrights to the "Massage" content are reserved by Practical Pictures. All issues related to copyrights are reserved by the corresponding company.

3. Press the ◀, ▶, ▲ or ▼ button to select an item to view.
Press the ENTER button.

- The "Basic Stretches" contents are automatically played so that you can easily follow the movements on the screen. To move to the previous or next operation, press the ◀ or ▶ button to view the required step.
- The selected item is displayed on the screen.
- To return to "Content Library" main menu, press the EXIT button.
- To exit "Content Library" mode, press the CH button on the remote control.



Using the Remote Control Button in Fitness menu

Button	Operations
Wheel (◀/▶)	View to previous step / View to next step
ENTER	Play or pause (in Basic Stretches)

Setup

Select to set the waiting time before the screen saver appears.

1. Press the yellow button to select "Setup" in the "Content Library" main menu.
2. Press the ◀ or ▶ button to select "Off", "4 hour", "8 hour", "10 hour".

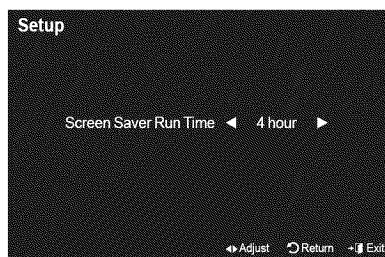

Using Additional Content Using External USB Memory Storage

You can download contents onto a USB memory device and play them on your TV.
(The contents on the external USB device are played directly without being copied to the built-in Flash memory of the TV.)

Playing and Exiting New Content

- Press the Red button in the "Content Library" main menu.
 - The USB Browser main screen is displayed.
 - A list of files saved on the USB device is displayed.
- Press the ▲ or ▼ button to move to the file (or folder) you want to play. Press the **ENTER** button.
 - The selected content is played.
 - The use of contents is the same as in using the TV memory contents.
 - To return to the USB browser main screen, press the **EXIT** button. To exit "Content Library" mode, press the **CH** button on the remote control.
 - "Content Library" only supports USB Mass Storage Class devices (MSC). MSC is a Mass Storage Class Bulk-Only Transport device. Examples of MSC are Thumb drives and Flash Card Readers (Both USB HDD and HUB are not supported.)

Playing a game using an external USB memory device will allow you to save your game (depending on the game).
Take care as removing the USB memory device while saving data to the USB memory device may cause the data to be lost.

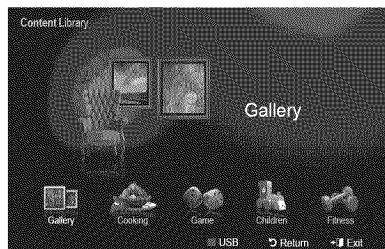

Downloading New Contents

New content other than the built-in contents will be provided via the Samsung.com website with or without charge.

◆ Downloading Content

- Visit the www.samsung.com website and open the Content Library page.
- Enter the product number (UDN, Unique Device Number).
- Select a content item in the Contents Download page.
- Download the contents onto the USB memory device.
 - "Content Library" only supports USB Mass Storage Class devices (MSC). MSC is a Mass Storage Class Bulk-Only Transport device. Examples of MSC are Thumb drives and Flash Card Readers (Both USB HDD and HUB are not supported.)
- Go to "Content Library" main menu by pressing "Contents" button or choosing "Content Library" (Menu→Application→"Content Library")
- Plug the USB memory into USB port on the side of the TV.

◆ Finding a product number (Unique Device Number, UDN)

- Insert the USB memory into the USB port on the side of the TV.
- In the USB Browser main screen, press the Green button (Show UDN).
- The 18-digit number on the screen is the product code.

◆ Provided Content

Additional contents are available on www.samsung.com

The Remote Control Buttons Used in the USB "Content Library"

Button	Operations
Red	Return to the main menu of the TV Memory "Content Library".
Green	Show the product number (unique device number) of the TV used to download content from the website.
EXIT	Stop the current function and return to the "Content Library" main menu.
CH ▼/▲ / PRE.CH / FAV.CH / CH.LIST	Stop Content Library mode and Returns to TV mode.

Network Settings and InfoLink

To access Samsung's Infotlink network feature, you must make one of the connections on the following pages.

Network Connection - Cable

LAN Connection for a DHCP Environment

The procedures to set up the network using Dynamic Host Configuration Protocol (DHCP) are described below. Since an IP address, subnet mask, gateway, and DNS are automatically allocated when DHCP is selected, you do not have to enter them manually.

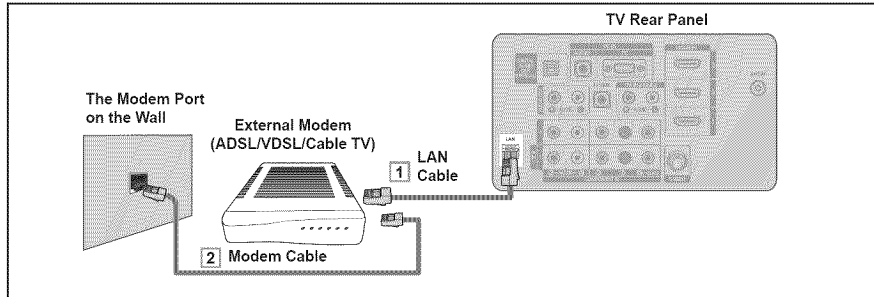

1. Connect the [LAN] port on the rear panel of the TV and the external modem with a LAN Cable.
2. Connect the LAN port on the wall and the external modem with a Modem Cable.

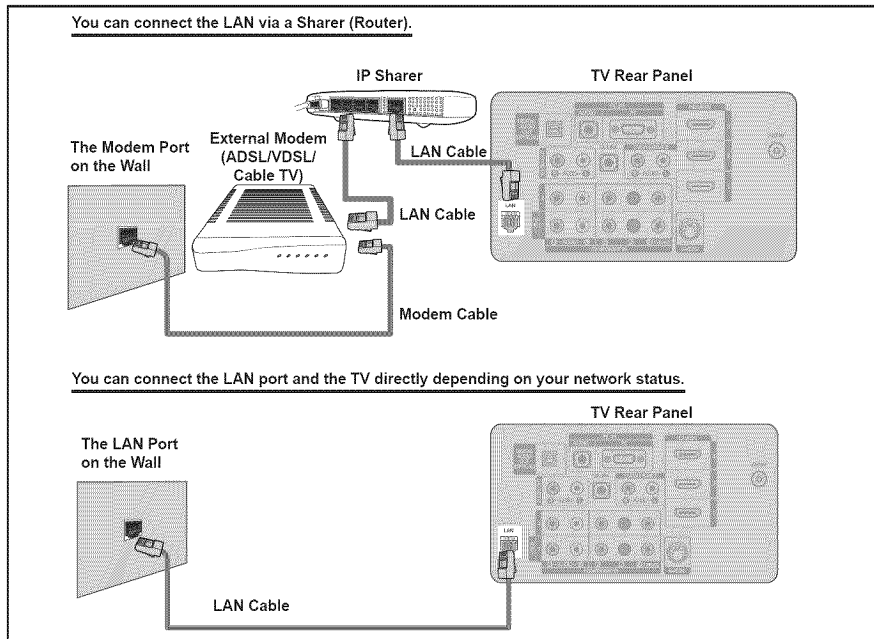

- The terminals (the position of the port and the type) of the external device may differ depending on the manufacturer.
- If the IP address allocation by the DHCP server has failed, turn the external modem off, turn it on again after at least 10 seconds and then try again.
- For the connections between the external modem and the Sharer (Router), refer to the owner's manual of the corresponding product.
- You can connect the TV to the LAN directly without connecting it through a Sharer (Router)
- You cannot use a manual-connection-type ADSL modem because it does not support DHCP. You have to use an automatic-connection-type ADSL modem.

LAN Connection for Static IP Environment

The procedures to set up the network using a static IP address are described below. You have to manually enter the IP address, subnet mask, gateway, and DNS that are provided by your Internet Service Provider (ISP).

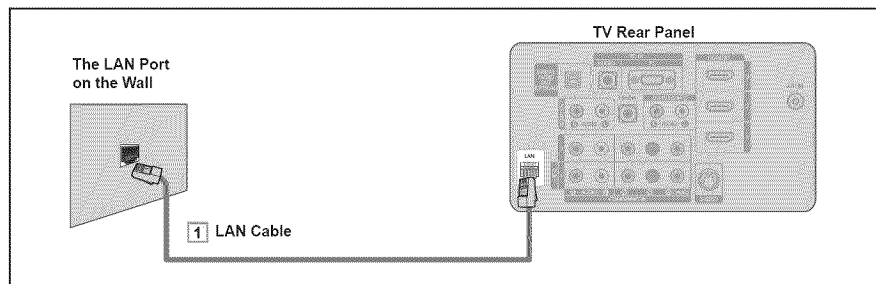

1. Connect the [LAN] port on the rear panel of the TV and the LAN port on the wall using the LAN cable.

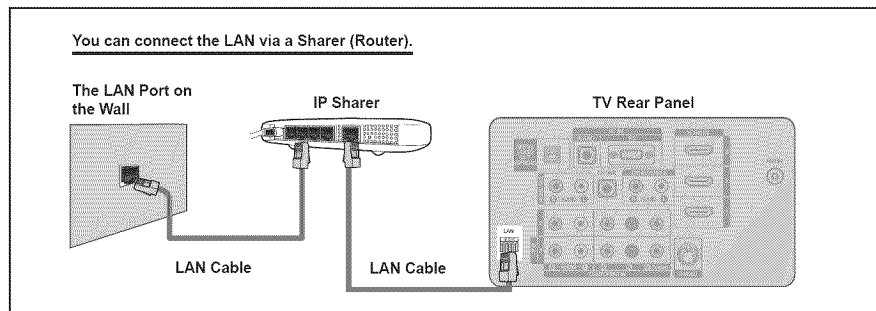

- The terminals (the position of the port and the type) of the external device may differ depending on the manufacturer.
- If you are using a static IP address, your ISP will inform you of the IP address, subnet mask, gateway, and DNS. You must enter these values to complete the network settings. If you do not know the values, ask your network administrator.
- For the information on how to configure and connect a Sharer (Router), refer to the owner's manual for the corresponding product.
- You can connect the TV to the LAN directly without connecting it through a Sharer (Router).
- If you use an IP Sharer (IP Router) that supports DHCP, you can set up the device as either DHCP or static IP.
- For the procedures to use a static IP address, ask your Internet Service Provider.

Network Connection - Wireless

You can connect to the Samsung's Infolink network wirelessly through a wireless IP sharer.

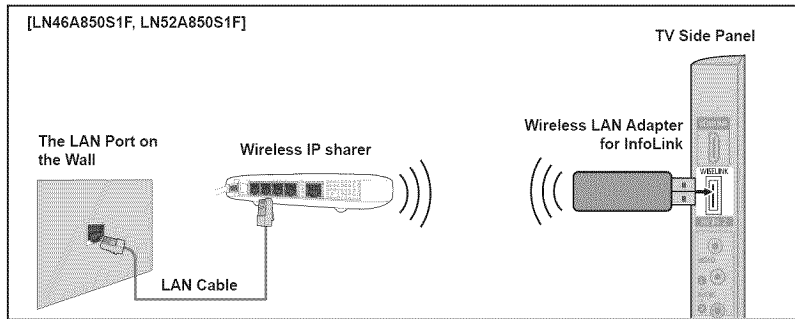

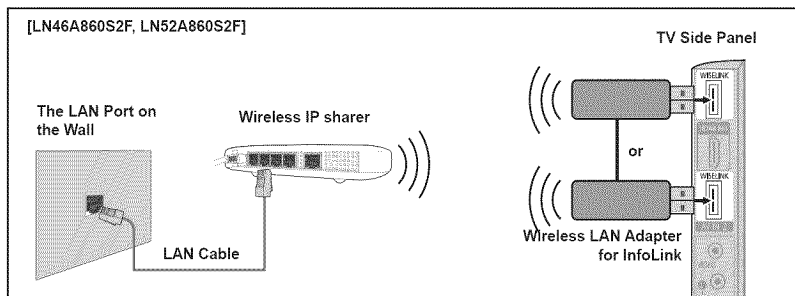

1. Connect the Samsung Infolink Wireless adapter into the Wiselink terminal of the TV.



- You must use the Samsung Wireless LAN Adapter for InfoLink(WIS-08BG) to use a wireless network.
- The Samsung Wireless LAN Adapter for InfoLink is sold separately. Contact a Samsung Electronics agent or service center for purchasing.
- To use a wireless network, your TV must be connected to a wireless IP sharer.
- If the wireless IP sharer supports DHCP, you TV can use a DHCP or static IP address to connect to the wireless network.
- You must use a wireless IP sharer that supports IEEE 802.11 B or IEEE 802.11G.
- If the wireless IP sharer allows you to turn on/off the Ping connection function, turn it on.
- Set the wireless IP sharer to Infrastructure mode. Ad-hoc mode is not supported.
- Select a channel for the wireless IP sharer that is not currently being used. If the channel set for the wireless IP sharer is currently being used by another device nearby, this will result in interference and communications may fail.
- When applying the security key for the AP (wireless IP sharer), only the following is supported.
 - 1) Authentication Mode : WEP, WPAPSK, WPA2PSK
 - 2) Encryption Type : WEP, TKIP, AES
 If you apply a security system other than the systems listed above, it will not work with the TV.
- If connecting 2 Wireless LAN Adapters for InfoLink, the adaptor read at first is executed.

Network selection

Select Cable or Wireless as the method to connect to the Samsung's Infolink network.

1. Press the **MENU** button to display the menu.
Press the **▲** or **▼** button to select "Setup", then press the **ENTER**  button.
2. Press the **▲** or **▼** button to select "Network selection", then press the **ENTER**  button.
3. Press the **▲** or **▼** button to select "Cable" or "Wireless", then press the **ENTER**  button.

- **Cable:** Connect to Samsung's Infolink network using a cable.
- **Wireless:** Connect to Samsung's Infolink network wirelessly.

- The menu is activated only if the Samsung Wireless LAN Adapter for InfoLink is connected.

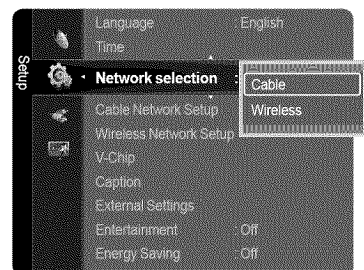



Cable Network Setup



- First, the "Network selection" must be set to "Cable". (See page 120)

Auto Setup

If you connect the LAN cable and it supports DHCP, the Internet Protocol (IP) Settings are automatically configured.

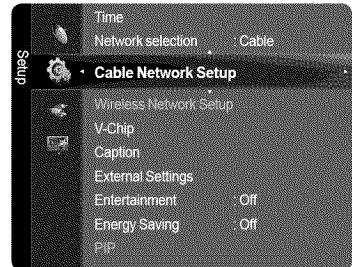
- Please check if the LAN cable is connected. (See page 118)
1. Press the **MENU** button to display the menu.
Press the **▲** or **▼** button to select "Setup", then press the **ENTER**  button.
 2. Press the **▲** or **▼** button to select "Cable Network Setup", then press the **ENTER**  button.





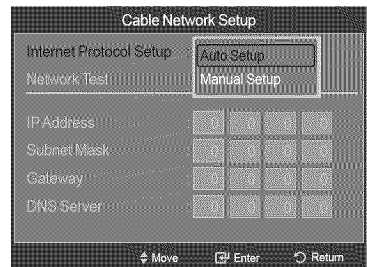

3. Press the **ENTER**  button to select "Internet Protocol Setup".
4. Press the **▲** or **▼** button to select "Auto Setup", then press the **ENTER**  button.
 - The Internet Protocol is set automatically.
 - Select "Network Test" to check the network connectivity. (Refer to page 122)

Press the **EXIT** button to exit.



Manual Setup

To connect the TV to the LAN using a static IP address, you must set up the Internet Protocol (IP).

- Please check if the LAN cable is connected. (See page 119)
1. Press the **MENU** button to display the menu.
Press the **▲** or **▼** button to select "Setup", then press the **ENTER**  button.
 2. Press the **▲** or **▼** button to select "Cable Network Setup", then press the **ENTER**  button.
 3. Press the **ENTER**  button to select "Internet Protocol Setup".
 4. Press the **▲** or **▼** button to select "Manual Setup", then press the **ENTER**  button.

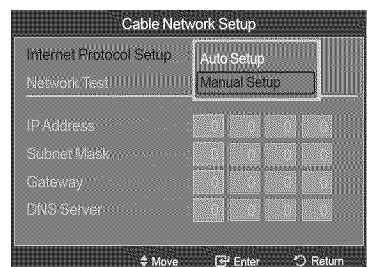
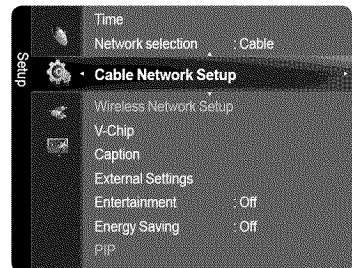

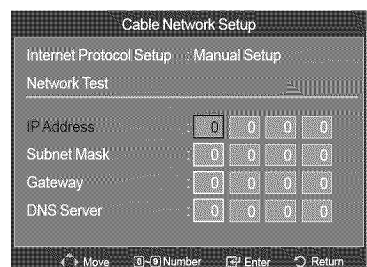

5. Press the **▲**, **▼**, **◀** or **▶** button to move to an item, and press the numeric button to configure the selected item. Press the **ENTER**  button.
 - Select "Network Test" to check the network connectivity. (Refer to page 122)

Press the **EXIT** button to exit.



Network Test

You can test or confirm the network connection status after setting up the network.

1. Press the **MENU** button to display the menu.
Press the **▲** or **▼** button to select "Setup", then press the **ENTER**  button.
2. Press the **▲** or **▼** button to select "Cable Network Setup", then press the **ENTER**  button.
3. Press the **▲** or **▼** button to select "Network Test", then press the **ENTER**  button.
 - The current network settings will appear.Press the **EXIT** button to exit.

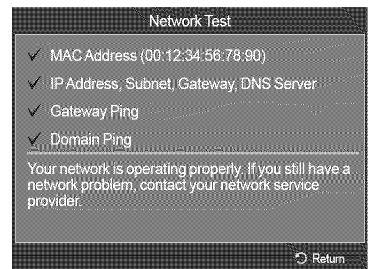
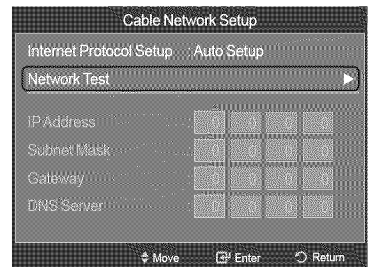
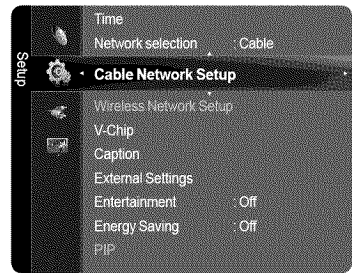

When unable to connect to a wired network

1. If your Internet service provider has registered the MAC address of the device used to connect to the Internet for the first time and authenticates the MAC address each time you connect to the Internet, your TV may not be able to connect to the Internet as the MAC address differs from that of the device (PC) used to connect to the Internet the first time. In this case, ask your Internet service provider about the procedures to connect devices other than your PC (such as your TV) to the Internet.
2. If your Internet service provider requires an ID or password to connect to the Internet (network), your TV may not be able to connect to the Internet. In this case, you have to enter your ID or password when connecting to the Internet using an Internet Sharer (Router).
3. The internet connection may fail due to a firewall problem. In this case, contact your Internet service provider.

If you cannot connect to the Internet even if you have followed the procedures of your Internet service provider, please contact a Samsung Electronics Service Center.

Wireless Network Setup

- > The menu is activated only if the Samsung Infolink Wireless adapter is connected. (See page 120)

Auto Setup

- > If you connect the LAN cable and it supports DHCP, the Internet Protocol (IP) Settings are automatically configured.
- > The wireless IP sharer to be connected to this product must support DHCP.

1. Press the **MENU** button to display the menu.
Press the **▲** or **▼** button to select "Setup", then press the **ENTER** button.
2. Press the **▲** or **▼** button to select "Wireless Network Setup", then press the **ENTER** button.

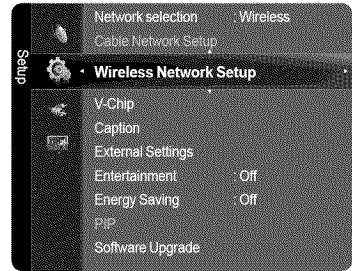

3. Press the **ENTER** button to select "Internet Protocol Setup".
4. Press the **▲** or **▼** button to select "Auto Setup", then press the **ENTER** button.
 - > The Internet Protocol is set automatically.
 - > Select "Access Point Select" to check the network connectivity. (Refer to page 124)Press the **EXIT** button to exit.

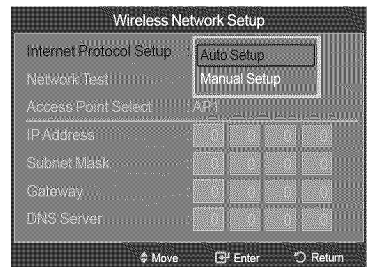

Manual Setup

1. Press the **MENU** button to display the menu.
Press the **▲** or **▼** button to select "Setup", then press the **ENTER** button.
2. Press the **▲** or **▼** button to select "Wireless Network Setup", then press the **ENTER** button.



3. Press the **ENTER** button to select "Internet Protocol Setup".
4. Press the **▲** or **▼** button to select "Manual Setup", then press the **ENTER** button.

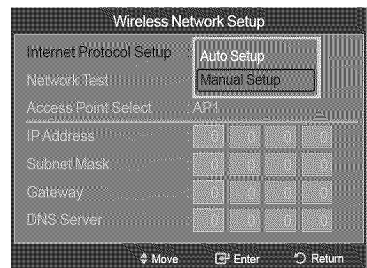

5. Press the **▲**, **▼**, **◀** or **▶** button to move to an item, and press the numeric button to configure the selected item. Press the **ENTER** button.
 - > If you want to use a static IP address, refer to the user manual of your wireless IP sharer.
 - > Select "Access Point Select" to check the network connectivity. (Refer to page 124)

Press the **EXIT** button to exit.

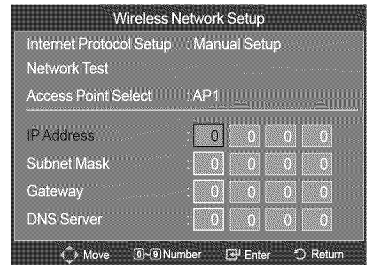

Access Point Select

You can select the IP sharer to use when using a wireless network.

1. Press the **MENU** button to display the menu.
Press the **▲** or **▼** button to select "Setup", then press the **ENTER** button.
2. Press the **▲** or **▼** button to select "Wireless Network Setup", then press the **ENTER** button.

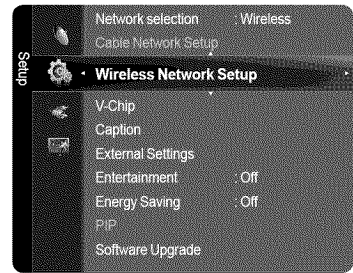

3. Press the **▲** or **▼** button to select "Access Point Select", then press the **ENTER** button.
 - The wireless Access Points that exist in you area are searched and displayed in the Access Point List.

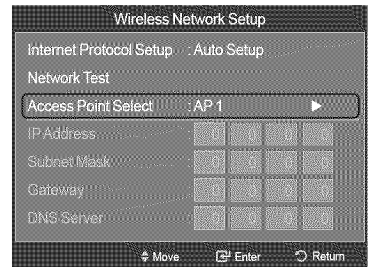

4. Press the **▲** or **▼** button to select the Access Point to use. Then press the **ENTER** button.
 - If a wireless Access Point is not in the Access Point list, press the Red button.
 - When the connection is made, you will be returned to the screen automatically.
 - If you selected an Access Point that requires security authentication, enter the security key.
 - You can enter up to characters for a security key.]
 - The character set may differ and the red button may not appear depending on the Access Point.

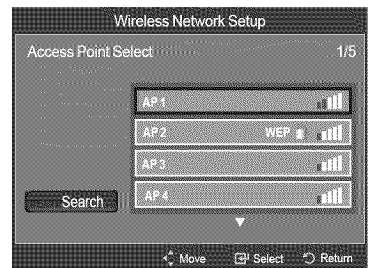

- **If you have selected an Access Point with a security authentication:**
 - The Security Key input screen appears.
 - Enter the security key and press the **ENTER** button.
 - Using the Remote Control Buttons on the Security Key Input Screen

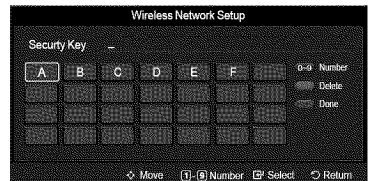

Button	Operations
Wheel (▲/▼/◀/▶)	Moves the selection up/down/left/right.
ENTER	Enters (Inputs) the selected character.
RED	Switch between Upper- and Lower-Case Letters
GREEN	You can delete an already entered character.
BLUE	Press this button to finish entering the security key.

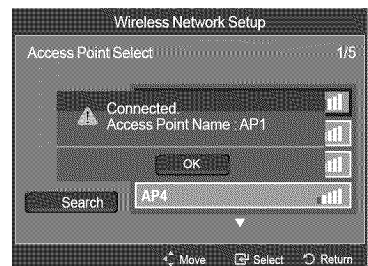

Network Test

You can test or confirm the network connection status after setting up the network.

1. Press the **MENU** button to display the menu.
Press the **▲** or **▼** button to select "Setup", then press the **ENTER** button.
2. Press the **▲** or **▼** button to select "Wireless Network Setup", then press the **ENTER** button.



3. Press the **▲** or **▼** button to select "Network Test", then press the **ENTER** button.
 - > The current network settings will appear.
 - > If no "Access Point Select" is set up, the test cannot be completed. (See page 124)Press the **EXIT** button to exit.

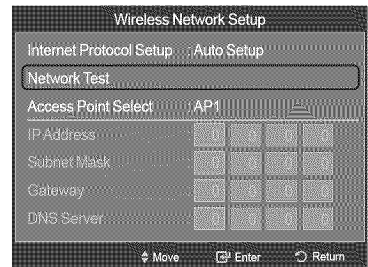

When unable to connect to a wireless network

1. Your TV may fail to locate an AP that is configured as a private SSID type.
In this case, please change the AP settings and try again.
2. If your Internet service provider has registered the MAC address of the device used to connect to the Internet for the first time and authenticates the MAC address each time you connect to the Internet, your TV may not be able to connect to the Internet as the MAC address differs from that of the device (PC) used to connect to the Internet the first time. In this case, ask your Internet service provider about the procedures to connect devices other than your PC (such as your TV) to the Internet.

If you cannot connect to the Internet even if you have followed the procedures of your Internet service provider, please contact 1-800-SAMSUNG.

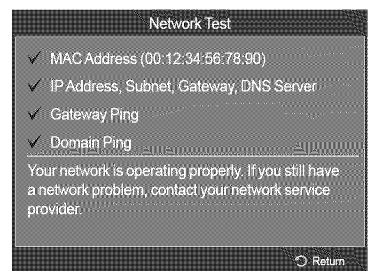

Using InfoLink

You can view news, stock market and weather information services using SAMSUNG's InfoLink service.

- Set up the network. (Refer to pages 118~125)

Activating InfoLink

1. Press the **MENU** button to display the menu.
Press the **▲** or **▼** button to select "Application", then press the **ENTER** button.
2. Press the **▲** or **▼** button to select "InfoLink", then press the **ENTER** button.
3. Press the **◀** or **▶** button to select a service ("Weather", "News", "Stocks" or "Setup") and press the **ENTER** button.
 - You can select and view more than one service at the same time only for 'News (without detailed information)', 'Weather-Today's Weather', and 'Stocks-Favorite Stocks, Market Summary'.Press the **EXIT** button to exit.

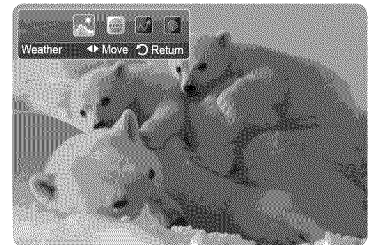
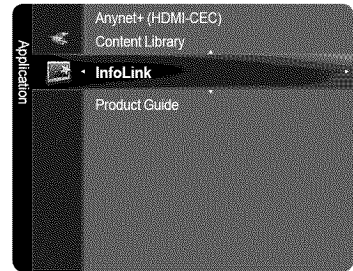

-  Press the **INFO.L** button on the remote control to display the "InfoLink" menu.

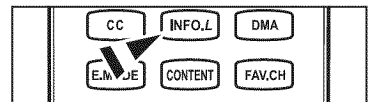

ALL THE MATERIALS AVAILABLE THROUGH INFOLINK ["INFOLINK CONTENT"] ARE THE PROPERTY OF THE ORIGINATOR OF THE CONTENT ["CONTENT OWNER"] AND/OR ITS AFFILIATES OR LICENSORS, AND ARE PROTECTED BY COPYRIGHT, TRADEMARK, AND OTHER INTELLECTUAL PROPERTY LAWS. ALL INFOLINK CONTENT IS PROVIDED SOLELY FOR YOUR PERSONAL NONCOMMERCIAL USE. YOU MAY NOT USE ANY INFOLINK CONTENT IN A MANNER THAT CONSTITUTES AN INFRINGEMENT OF THE CONTENT OWNERS' RIGHTS OR THAT HAS NOT BEEN AUTHORIZED BY THE CONTENT OWNER. MORE SPECIFICALLY, UNLESS EXPLICITLY AUTHORIZED IN THIS DISCLAIMER OR BY THE CONTENT OWNER, YOU MAY NOT MODIFY, COPY, REPRODUCE, REPUBLISH, UPLOAD, POST, TRANSMIT, TRANSLATE, SELL, CREATE DERIVATIVE WORKS, EXPLOIT, OR DISTRIBUTE IN ANY MANNER OR MEDIUM (INCLUDING BY EMAIL OR OTHER ELECTRONIC MEANS) ANY INFOLINK CONTENT OR ANY OTHER MATERIAL FROM THE INFOLINK SERVICE. CONTENT PROVIDED CONTENT OWNERS IN CONNECTION WITH THE INFOLINK SERVICE MAY BE TIME-DELAYED AS SPECIFIED BY THE CONTENT OWNER AND/OR ITS AFFILIATES.

INFOLINK IS PROVIDED THROUGH AGREEMENT BETWEEN SAMSUNG AND THE CONTENT OWNER. INFOLINK MAY BE TERMINATED OR INTERRUPTED AT ANY TIME BY EITHER SAMSUNG OR THE CONTENT PROVIDER OR THROUGH TERMINATION OF THE AGREEMENT BETWEEN THEM. UNDER NO CIRCUMSTANCES, INCLUDING NEGLIGENCE, SHALL SAMSUNG OR THE CONTENT PROVIDER BE HELD LIABLE, WHETHER IN CONTRACT OR TORT, FOR ANY DIRECT, INDIRECT, INCIDENTAL, SPECIAL OR CONSEQUENTIAL DAMAGES, ATTORNEY FEES, EXPENSES, OR ANY OTHER DAMAGES WHATSOEVER ARISING OUT OF, OR IN CONNECTION WITH, SUCH TERMINATION OR INTERRUPTION. SINCE CONTENT TRANSMITTED VIA INFOLINK IS RECEIVED BY MEANS OF NETWORKS AND TRANSMISSION FACILITIES OVER WHICH SAMSUNG HAS NO CONTROL, SAMSUNG EXPRESSLY DISCLAIMS ANY RESPONSIBILITY OR LIABILITY FOR ANY INTERRUPTION OR SUSPENSION OF INTERLINK SERVICE OR FOR THE ABSENCE OF CONTENT RESULTING THEREFROM. INFORMATION IN THE INFOLINK IS PROVIDED "AS IS," AND CONSEQUENTLY, SAMSUNG DOES NOT WARRANT THE INFORMATION SO PROVIDED, EITHER EXPRESSLY OR IMPLIEDLY, FOR ANY PARTICULAR PURPOSE; AND SAMSUNG EXPRESSLY DISCLAIMS ANY IMPLIED WARRANTIES, INCLUDING BUT NOT LIMITED TO, WARRANTIES OF MERCHANTABILITY OR FITNESS FOR A PARTICULAR PURPOSE. SAMSUNG DOES NOT GUARANTEE THE ACCURACY, VALIDITY, TIMELINESS, LEGALITY, OR COMPLETENESS OF ANY INFORMATION OR DATA MADE AVAILABLE THROUGH INFOLINK FOR ANY PARTICULAR PURPOSE AND UNDER NO CIRCUMSTANCES, INCLUDING NEGLIGENCE, SHALL SAMSUNG BE HELD LIABLE, WHETHER IN CONTRACT OR TORT, FOR ANY DIRECT, INDIRECT, INCIDENTAL, SPECIAL OR CONSEQUENTIAL DAMAGES, ATTORNEY FEES, EXPENSES, OR ANY OTHER DAMAGES WHATSOEVER ARISING OUT OF, OR IN CONNECTION WITH, ANY INFORMATION CONTAINED IN, OR AS A RESULT OF THE USE OF INFOLINK BY YOU OR ANY THIRD PARTY, EVEN IF ADVISED OF THE POSSIBILITY OF SUCH DAMAGES.

Using the Weather Service

1. Press the **INFO.L** button on the remote control.
2. Press the ◀ or ▶ button to move to the "Weather" service and press the **ENTER**  button.

Set up the Region

3. Press Yellow button. Input the postal (zip) code of the region by pressing the number buttons on the remote, then press the **ENTER**  button.
 - You can check the weather of the selected region.





Set up Weather Option

4. Press the Red button while using the service to change the "Weather" service option.
5. Press ▲ or ▼ button and select "Weather" option.
 - To exit the "Weather" service, press the Blue button.
 - To exit the "InfoLink" service, press the **EXIT** button.



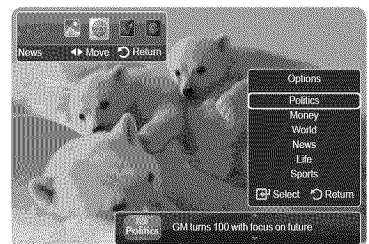

Using the News Service

- The news provider may be changed in the future.
1. Press the **INFO.L** button on the remote control.
 2. Press the ◀ or ▶ button to move to the "News" service and press the **ENTER**  button.
 - Press the **ENTER**  button to view the detailed article.
 - Press the ▲ or ▼ button to view the previous or next article.
 3. Press the Red button while using the service to change the "News" service Option.
 4. Press ▲ or ▼ button and select "News" service option.
 - The News service option changes depending on the provided web service.
 - To exit the "News" service, press the Blue button.
 - To exit the "InfoLink" service, press the **EXIT** button.



Using the Stock Service



1. Press the **INFO.L** button on the remote control.
2. Press the ◀ or ▶ button to move to the “Stocks” service and press the **ENTER**  button.
3. Press the Red button while using the service to change the “Stocks” service option.
4. Press ▲ or ▼ button and select “Stocks” service option, then press the **ENTER**  button.

- **Favorite Stocks:** The Favorite stock information is displayed. You can set up the Favorite Stocks by pressing the Yellow button.
- **Market Summary:** Dow Jones, Nasdaq and S&P 500 are toggled and the entire index, amount of up or down, and % are displayed.
- **Stocks & News:** The Favorite stock information and Dow Jones, NASDAQ and S&P 500 index and Financial news are displayed.

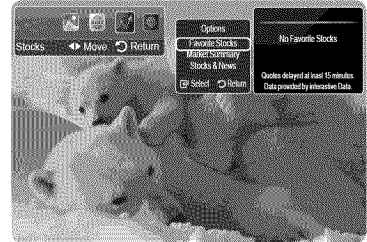
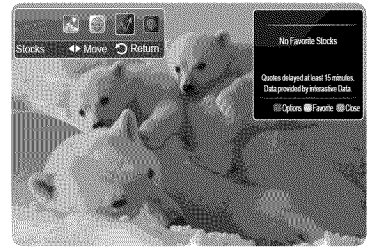
- Stock quotes delayed at least 15 minutes.
- To exit the “Stocks” service, press the Blue button.
- To exit the “InfoLink” service, press the **EXIT** button.



Setting Favorite Stocks Items

1. Press the Yellow button when “Favorite Stocks” or “Stocks & News” is selected. The Set Favorite Stocks screen appears.
2. Press the ◀ button to move to the Category. Press the ▲ or ▼ button to select a Category. Press the **ENTER**  button.
3. Press the ▲ or ▼ button to select a stock item and press the **ENTER**  button.
 - The selected stock is set as a Favorite Stock.
 - The ✓ mark will appear to the left of the stock name.
 - Press the **ENTER**  button again to cancel the setting. The ✓ mark will disappear.
 - To cancel all selections, press the Green button.
 - Pressing the Red button toggles between NYSE and NASDAQ.
4. To finish the settings, press the **RETURN** button.

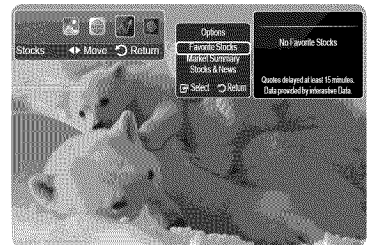

InfoLink Setup

1. Press the **INFO.L** button on the remote control.
2. Press the ◀ or ▶ button to select "Setup", then press the **ENTER**  button.

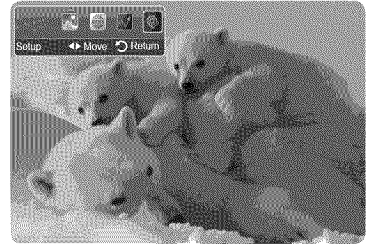

3. Press the ▲ or ▼ button to select the desired option. ("Auto Launch", "Display Time", "Font Size", "Background Color", "InfoLink's Position")
4. Press the ▲ or ▼ button to select an option, then press the **ENTER**  button.

- **Auto Launch:** Determines whether to launch InfoLink automatically when the TV is turned on. You can select either "Off" or "On".
- **Display Time:** Determines the time to display the news service on the TV screen. You can select "4 Hours", "8 Hours", "10 Hours", or "Always".
- **Font Size:** You can select letter size "Standard" or "Large" through InfoLink service.
- **Background Color:** You can select the Background Color of InfoLink service. The color is applied to each service, option and setup window.
- **InfoLink's Position:** You can set the position of each InfoLink service on the screen. You can select from six preset InfoLink positions ("Position 1"~"Position 6").

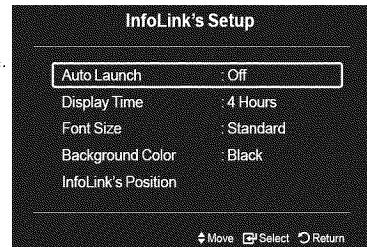

- To exit the "Setup" service, press the **RETURN** button.
- To exit the "InfoLink" service, press the **EXIT** button.

InfoLink's Position

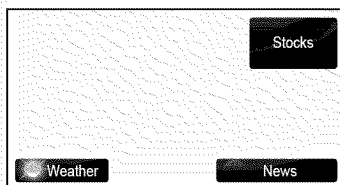

Position 1

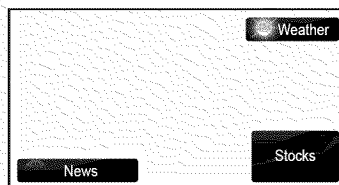

Position 2

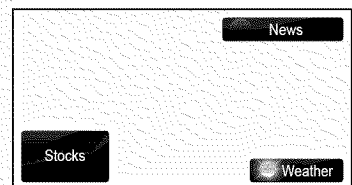

Position 3

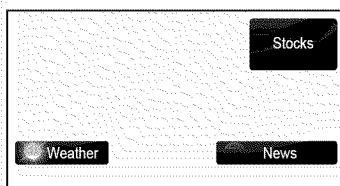

Position 4

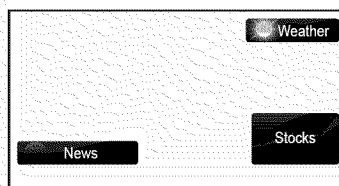

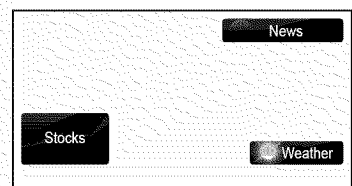

Position 5





Position 6

Product Guide

The Product Guide gives you information on the most important features of this TV.

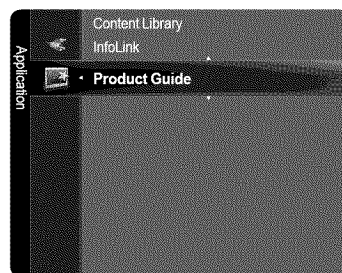
1. Press the **MENU** button to display the menu.
Press the **▲** or **▼** button to select "Application", then press the **ENTER**  button.
2. Press the **▲** or **▼** button to select "Product Guide", then press the **ENTER**  button.



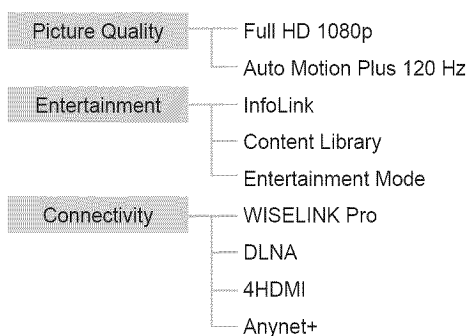

3. Press the **◀** or **▶** button to select a Guide ("Picture Quality", "Entertainment" or "Connectivity") and press the **ENTER**  button.
4. You can navigate the Product Guide screen by using the **◀** and **▶** buttons.



6. Press the **EXIT** button to exit.

Using the Remote Control Button in Product Guide Menu

Button	Operations
Yellow Button	Shows the contents of the Product Guide sequentially. (AutoPlay)
Wheel (◀▶)	Move the cursor and select an item.
ENTER 	Select the currently selected item.
RETURN	Return to the previous menu.
EXIT	Stop the current function and return to the "Product Guide" main menu.
CH  PRE.CH / FAV.CH	Stop Product Guide mode and Returns to TV mode

About Anynet+

What is Anynet+?

Anynet+ is a function that enables you to control all connected Samsung devices that support Anynet+ with your Samsung TV's remote.

Connecting Anynet+ Devices

The Anynet+ system can be used only with Samsung devices that have the Anynet+ feature. To be sure your Samsung device has this feature, check if there is an Anynet+ logo on it.

To connect to a TV

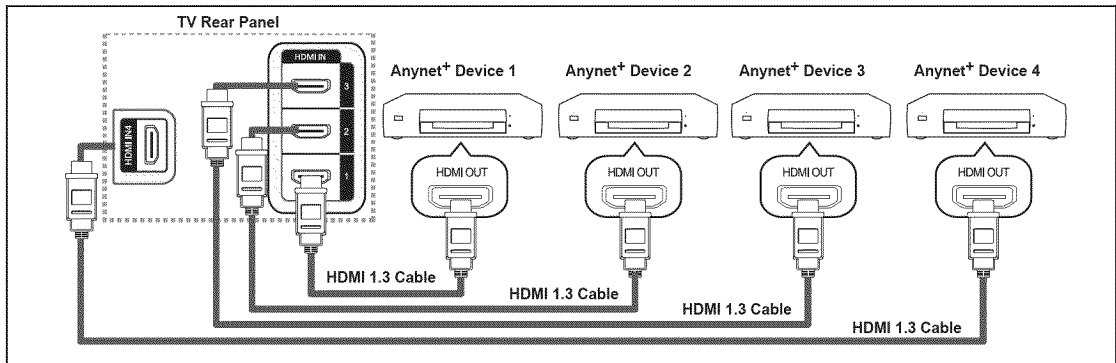

Connect the [HDMI 1], [HDMI 2], [HDMI 3] or [HDMI 4] jack on the TV and the HDMI OUT jack of the corresponding Anynet+ device using an HDMI cable.

To connect to Home Theater

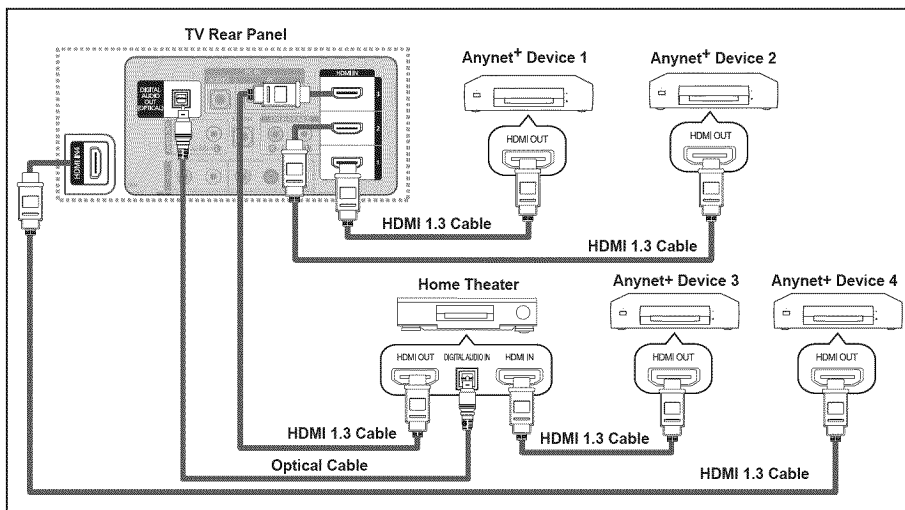





1. Connect the [HDMI 1], [HDMI 2], [HDMI 3] or [HDMI 4] jack on the TV and the HDMI OUT jack of the corresponding Anynet+ device using an HDMI cable.
2. Connect the HDMI IN jack of the home theater and the HDMI OUT jack of the corresponding Anynet+ device using an HDMI cable.

- Connect the Optical cable between the Digital Audio Out (Optical) jack on your TV and the Digital Audio Input on the Home Theater.
- When following the connection above, the Optical jack only outputs 2 channel audio. You will only hear sound from the Home Theater's Front Left and Right speakers and the subwoofer. If you want to hear 5.1 channel audio, connect the DIGITAL AUDIO OUT (OPTICAL) jack on the DVD/Blu-Ray player or Cable/Satellite Box (ie Anynet Device 1 or 2) directly to the Amplifier or Home Theater, not the TV.
- Connect only one Home Theater.
- You can connect an Anynet+ device using the HDMI 1.3 cable. Some HDMI cables may not support Anynet+ functions.
- Anynet+ works when the AV device supporting Anynet+ is in the Standby or On status.
- Anynet+ supports up to 12 AV devices in total. Note that you can connect up to 3 devices of the same type.

Setting Up Anynet+



The following settings help set the Anynet+ functions.

To use the Anynet+ Function, Anynet+ (HDMI-CEC) must be set to On

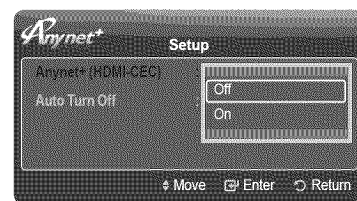
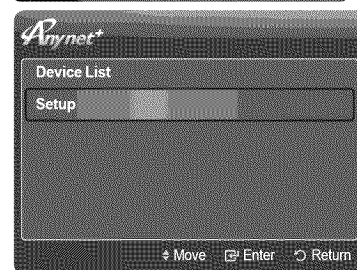
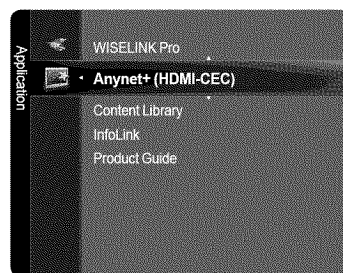
1. Press the **MENU** button. Press the **▲** or **▼** button to select "Application", then press the **ENTER**  button.
2. Press the **▲** or **▼** button to select "Anynet+ (HDMI-CEC)", then press the **ENTER**  button.
3. Press the **▲** or **▼** button to select "Setup", then press the **ENTER**  button.
4. Press the **▲** or **▼** button to select "Anynet+ (HDMI-CEC)", then press the **ENTER**  button.
5. Press the **▲** or **▼** button to select "On", then press the **ENTER**  button.
 - The "Anynet+ (HDMI-CEC)" function is enabled.
 - If you select Off, "Anynet+ (HDMI-CEC)" is disabled.
 - When the "Anynet+ (HDMI-CEC)" function is disabled, all the Anynet+ related operations are deactivated.



Setting an Anynet+ Device to turn Off Automatically when the TV is Turned Off

1. Press the **▲** or **▼** button to select "Auto Turn Off", then press the **ENTER**  button.
2. Press the **▲** or **▼** button to select "Yes", then press the **ENTER**  button.
 - The "Auto Turn Off" function is enabled.
 - If you select "No", the "Auto Turn Off" function is canceled.Press the **EXIT** button to exit.
 - The active source on the TV remote must be set to TV to use the Anynet+ function.
 - If you set "Auto Turn Off" to "Yes", connected external devices are also turned off when the TV is turned off. If an external device is still recording, it may or may not turn off.

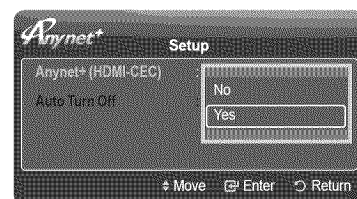

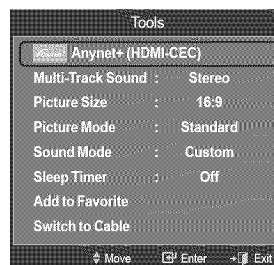

Easy Setting

1. Press the **TOOLS** button on the remote control.
2. Press the **ENTER**  button to select "Anynet+ (HDMI-CEC)".
 - The Anynet+ (HDMI-CEC) menus appear on the screen.



Scanning and Switching between Anynet+ Devices

1. Press the **TOOLS** button.
Press the **ENTER**  button to select "Anynet+ (HDMI-CEC)".
2. Press the **▲** or **▼** button to select "Device List", then press the **ENTER**  button.
 - Anynet+ devices connected to the TV are listed.
If you cannot find a device you want, press the red button to scan for devices.
 - Only when you set "Anynet+ (HDMI-CEC)" to On in the "Setup" menu, the "Device List" menu appears.
3. Press the **▲** or **▼** button to select to a particular device and press the **ENTER**  button. It is switched to the selected device.
 - Switching to the selected devices may take up to 2 minutes. You cannot cancel the operation during the switching operation.
 - The time required to scan for devices is determined by the number of connected devices.
 - When the device scan is complete, the number of devices found are not displayed.
 - Although the TV automatically searches the device list when the TV is turned on via the power button, devices connected to the TV when the TV is on or under some conditions are not automatically displayed in the device list. Press the red button to search for the connected device.
 - If you have selected external input mode by pressing the **SOURCE** button, you cannot use the Anynet+ function. Make sure to switch to an Anynet+ device by using the "Device List"



Anynet+ Menu



The Anynet+ menu changes depending on the type and status of the Anynet+ devices connected to the TV.

Anynet+ Menu	Description
View TV	Anynet+ mode changes to TV broadcast mode.
Device List	Shows the Anynet+ device list.
(device_name) Menu	Shows the connected device menus. E.g. If a DVD recorder is connected, the disc menu of the DVD recorder will appear.
(device_name) Operation	Shows the play menu of the connected device. E.g. If a DVD recorder is connected, the play menu of the DVD recorder will appear.
Record: (*recorder)	Starts recording immediately using the recorder. (This is only available for devices that support the recording function.)
(*recorder) Reserve Recording	Enables reserving a recording for the recorder. (This is only available for devices that support the recording reservation function.)
Stop Recording: (*recorder)	Stops recording.
Receiver	Sound is played through the receiver.

- If more than one recording device is connected, they are displayed as (*recorder) and if only one recording device is connected, it will be represented as (*device_name).



TV Remote Control Buttons Available in Anynet+ Mode

Device Type	Operating Status	Available Buttons
Anynet+ Device	After switching to the device, when the menu of the corresponding device is displayed on the screen.	Numeric buttons ▲/▼/◀/▶/ENTER  buttons Color buttons / EXIT button
	After switching to the device, while playing a file	◀◀ (Backward search) / ▶▶ (Forward search) ■ (Stop) / ▶ (Play) / ⏸ (Pause)
Device with built-in Tuner	After switching to the device, when you are watching a TV program	CH ▼ / CH ▲ button
Audio Device	When Receiver is activated	VOL - / VOL + / MUTE button

- The Anynet+ function only works when the active source on the TV remote control is set to TV.
- The  button works only while in the recordable state.
- You cannot control Anynet+ devices using the buttons on the TV. You can control Anynet+ devices only using the TV remote control.
- The TV remote control may not work under certain conditions. In this case, reselect the Anynet+ device.
- The Anynet+ functions do not operate with other manufacturers' products.
- The ,  operations may differ depending on the device.

Recording

You can make a recording of a TV program using a Samsung recorder.

1. Press the **TOOLS** button.
Press the **ENTER**  button to select "Anynet+ (HDMI-CEC)".
2. Press the **▲** or **▼** button to select "Recording: (device_name)", then press the **ENTER**  button. Recording begins.

When there is more than one recording device

When multiple recording devices are connected, the recording devices are listed. Press the **▲** or **▼** button to select a recording device and press the **ENTER**  button. Recording begins.

When the recording device is not displayed

Select "Device List" and press the red button to search devices.

Press the **EXIT** button to exit.

- You can record the source streams by selecting "Recording: (device_name)".
- Pressing the  button will record whatever you are currently watching. If you are watching video from another device, the video from the device is recorded.
- Before recording, check whether the antenna jack is properly connected to the recording device. To properly connect an antenna to a recording device, refer to the recording device's users manual.

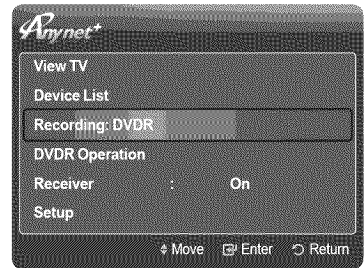

Listening through a Receiver (Home theater)

You can listen to sound through a receiver instead of the TV speaker.

1. Press the **TOOLS** button.
Press the **ENTER**  button to select "Anynet+ (HDMI-CEC)".
2. Press the **▲** or **▼** button to select "Receiver".
Press the **◀** or **▶** button to select "On" or "Off".
3. Press the **EXIT** button to exit.
 - If your receiver supports audio only, it may not appear in the device list.
 - The receiver will work when you have properly connected the Optical IN jack of the receiver to the Optical Out jack of the TV.
 - When the receiver (home theater) is set to On, you can hear sound output from the TV's Optical jack. When the TV is displaying a DTV(air) signal, the TV will send out 5.1 channel sound to the Home theater receiver. When the source is a digital component such as a DVD and is connected to the TV via HDMI, only 2 channel sound will be heard from the Home Theater receiver.
 - When using the WISELINK Pro feature, sound may not output properly through the receiver.
 - When listening through the receiver, there are restrictions for using the PIP and audio-related (MTS, Preferred language) menus.
 - If there is a power interruption to the TV when the "Receiver" is set to "On" (by disconnecting the power cord or a power failure), the "Select Speaker" may be set to "External Speaker" when you turn the TV on again. (see page 43)



Troubleshooting for Anynet+

Symptom	Solution
Anynet+ does not work.	<ul style="list-style-type: none"> • Check if the device is an Anynet+ device. The Anynet+ system supports Anynet+ devices only. • Connect only one receiver (home theater). • Check if the Anynet+ device power cord is properly connected. • Check the Anynet+ device's Video/Audio/HDMI 1.3 cable connections. • Check whether Anynet+ (HDMI-CEC) is set to On in the Anynet+ setup menu. • Check whether the TV remote control is in TV mode. • Check whether it is Anynet+ exclusive remote control. • Anynet+ doesn't work in certain situations. (Searching channels, Operating WISELINK Pro, Plug & Play, etc.) • When connecting or removing the HDMI 1.3 cable, please make sure to search devices again or turn your TV off and on again. • Check if the Anynet+ Function of Anynet+ device is set on.
I want to start Anynet+.	<ul style="list-style-type: none"> • Check if the Anynet+ device is properly connected to the TV and check if the Anynet+ (HDMI-CEC) is set to On in the Anynet+ Setup menu. • Press the TV button on the TV remote control to switch to TV. Then press the TOOLS button to show the Anynet+ menu and select a menu you want.
I want to exit Anynet+.	<ul style="list-style-type: none"> • Select View TV in the Anynet+ menu. • Press the SOURCE button on the TV remote control and select a device other than Anynet+ devices. • Press CH, CH LIST, PRE-CH, and FAV.CH to change the TV mode. (Note that the channel button operates only when a tuner-embedded Anynet+ device is not connected.)
The message Connecting to Anynet+ device... appears on the screen.	<ul style="list-style-type: none"> • You cannot use the remote control when you are configuring Anynet+ or switching to a view mode. • Use the remote control when the Anynet+ setting or switching to view mode is complete.
The Anynet+ device does not play.	You cannot use the play function when Plug & Play is in progress.
The connected device is not displayed.	<ul style="list-style-type: none"> • Check whether or not the device supports Anynet+ functions. • Check whether or not the HDMI 1.3 cable is properly connected. • Check whether Anynet+ (HDMI-CEC) is set to On in the Anynet+ setup menu. • Search Anynet+ devices again. • You can connect an Anynet+ device using the HDMI 1.3 cable only. Some HDMI cables may not support Anynet+ functions. • If it is terminated by an abnormal situation such as disconnecting the HDMI cable or power cord or a power failure, please repeat the device scan.
The TV program cannot be recorded.	Check whether the antenna jack on the recording device is properly connected.
The TV sound is not output through the receiver.	Connect the optical cable between TV and the receiver.

Appendix

Troubleshooting

If the TV seems to have a problem, first try this list of possible problems and solutions.

If none of these troubleshooting tips apply, call Samsung customer service at 1-800-SAMSUNG.

Problem	Possible Solution
Poor picture.	Try another channel. Adjust the antenna. Check all wire connections.
Poor sound quality.	Try another channel. Adjust the antenna.
No picture or sound.	Try another channel. Press the SOURCE button. Make sure the TV is plugged in. Check the antenna connections.
No sound or sound is too low at maximum volume.	First, check the volume of units connected to your TV (digital broadcasting receiver, DVD, cable broadcasting receiver, VCR, etc.). Then, adjust the TV volume accordingly.
Picture rolls vertically.	Check all wire connections.
There is a problem with the picture	Run the Picture test in the Self diagnostic menu
There is a problem with the sound	Run the Sound test in the Self diagnostic menu
The TV operates erratically.	Unplug the TV for 30 seconds, then try operating it again.
The TV won't turn on.	Make sure the wall outlet is working.
Remote control malfunctions.	Replace the remote control batteries. Clean the upper edge of the remote control (transmission window). Check the battery terminals.
'Check signal cable' message.	Ensure that the signal cable is firmly connected to the PC source.
'Not Supported Mode' message.	Check the maximum resolution and connected device's Video frequency. Compare these values with the data in the Display Modes.
Digital broadcasting screen problem.	Please check the digital signal strength and input antenna.
The image is too light or too dark.	Adjust the Brightness and Contrast. Adjust the Fine tuning.
Black bars on the screen.	Make sure the broadcast you're receiving is High Definition (HD). HD channels sometimes broadcast Standard Definition (SD) programming, which can cause black bars. Set your cable/satellite box to stretch or widescreen mode to eliminate the bars.
Picture has a Red/Green or Pink tint.	Make sure the Component cables are connected to the correct jacks.
Closed Captioning not working.	If you are using a Cable/Satellite box, you must set Closed Captioning on the box, not your TV.
Snowy picture.	Your cable box may need a firmware upgrade. Please contact your Cable company.
Ghosting on picture.	This is sometimes caused by compatibility issues with your cable box. Try connecting Component cables instead.
Horizontal bars appear to flicker, jitter or shimmer on the image.	Adjust the Coarse tuning and then adjust the Fine tuning.
Vertical bars appear to flicker, jitter or shimmer on the image.	Adjust the Coarse tuning and then adjust the Fine tuning.

Problem	Possible Solution						
Screen is black and power indicator light blinks steadily.	On your computer check: Power, Signal Cable. The TV is using its power management system. Move the computer's mouse or press any key on the keyboard.						
Image is not stable and may appear to vibrate when you have a computer connected to the PC input.	If the setting is not correct, use your computer utility program to change the display settings. ➤ Your TV supports multiscan display functions within the following frequency domain: <table border="1" data-bbox="581 369 1130 479"> <tr> <td>Horizontal frequency (kHz)</td> <td>30~60</td> </tr> <tr> <td>Vertical frequency (Hz)</td> <td>60~75</td> </tr> <tr> <td>PC Maximum refresh rate (at 60 Hz)</td> <td>1920 x 1080</td> </tr> </table>	Horizontal frequency (kHz)	30~60	Vertical frequency (Hz)	60~75	PC Maximum refresh rate (at 60 Hz)	1920 x 1080
Horizontal frequency (kHz)	30~60						
Vertical frequency (Hz)	60~75						
PC Maximum refresh rate (at 60 Hz)	1920 x 1080						
Image is not centered on the screen.	Adjust the horizontal and vertical position. The screen position must be adjusted on the output source (i.e. STB) with a digital signal.						
The picture appears distorted in the corner of the screen.	If "Just Scan" is selected with some external devices, the picture may appear distorted in the corner of the screen. This symptom is caused by the external devices, not TV.						
The 'Resets all settings to the default values' message appears.	This appears when you press and hold the EXIT button for a while. The product settings are reset to the factory defaults.						
You may see small particles if you look closely at the edge of the bezel surrounding the TV screen.	This is part of the product's design and is not a defect.						
This TFT LCD panel uses a panel consisting of sub pixels (6 220 800) which require sophisticated technology to produce. However, there may be few bright or dark pixels on the screen. These pixels will have no impact on the performance of the product.							

Installing the Stand

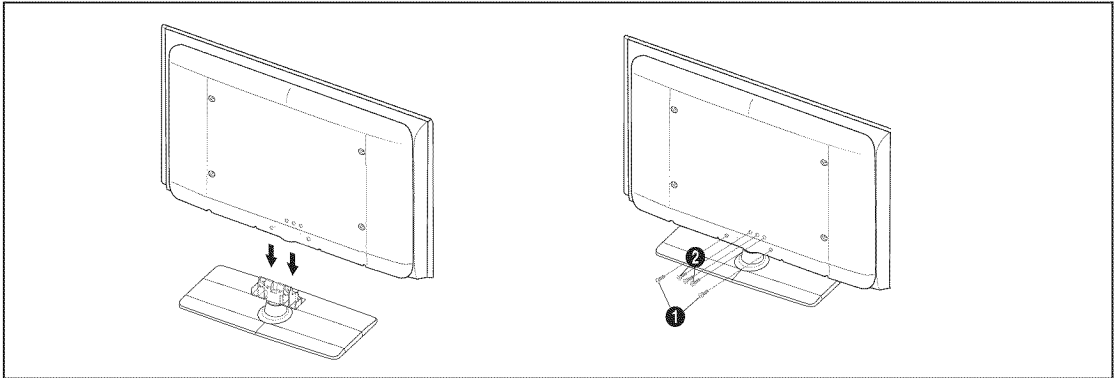

1. Attach your LCD TV to the stand.
 - Two or more people should carry the TV.
 - Make sure to distinguish between the front and back of the stand when attaching it.
 - To make sure the TV is installed on the stand at a proper level, do not apply excess downward pressure to the upper left or right sides of the TV.
2. Fasten two screws at position ① and then fasten three screws at position ②.
 - Stand the product up and fasten the screws. If you fasten the screws with the LCD TV placed down, it may lean to one side.

Disconnecting the Stand

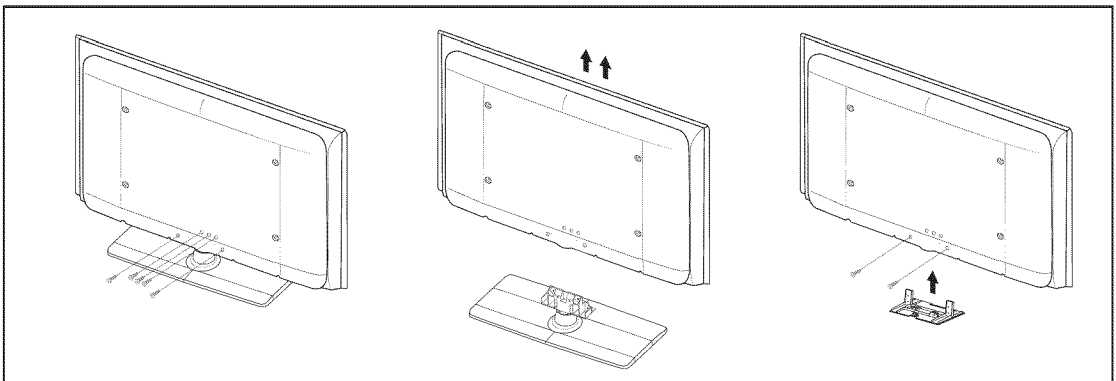

1. Remove five screws from the back of the TV.
2. Separate the stand from the TV.
 - Two or more people should carry the TV.
3. Cover the bottom hole with the cover.

Auto Wall-Mount Adjustment (Sold separately)

Once the auto wall mount is installed, your TV's position can be easily adjusted.

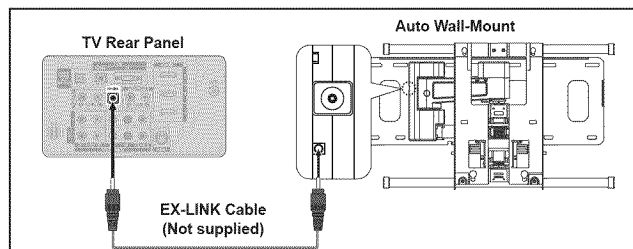

Entering the menu

- Press the ▲, ▼, ◀ or ▶ button on your remote control.
 - The Wall Mount Adjustment screen is displayed.
 - If the Wall Mount Adjustment screen is not displayed when clicking on a direction button while watching your TV, use the menu to display that screen.
- Press the **MENU** button to display the menu. Press the ▲ or ▼ button to select "Setup", then press the **ENTER** button.
- Press the ▲ or ▼ button to select "External Settings", then press the **ENTER** button.
- Press the ▲ or ▼ button to select "Wall-Mount Adjustment", then press the **ENTER** button.

Remembering the Position

- Adjust to the desired position using the ▲, ▼, ◀, ▶ buttons.
 - If you press an arrow button when no OSD is displayed on the TV screen, the Adjustment screen appears.
 - Press the **INFO** button to reset. Press the ◀ or ▶ button to select "Yes", then press the **ENTER** button. The position is initialized to the default setting.
- Press the Blue button.
 - Press the ▲ and ▼ buttons to select a save mode from either Position 1, Position 2 or Position 3 in order to save the current position.
 - To not save the current position, press the **RETURN** button.
 - When selecting a save mode, you cannot use the Color buttons.
- Press the **ENTER** button to save.
 - When Position 1 is selected, the message "Current position saved as Position 1" is displayed.
- Press the **ENTER** button.
 - The saved Position appears on the left side of the OSD.

Moving to the remembered position

- Complete Step 1 of "Entering the menu".
 - Pressing a Color (Red, Green, Yellow) button moves the auto wall mount to the saved position.
 - You can move the wall mount to one of the 3 pre-set positions by pressing the Red (Position 1), Green (Position 2) or Yellow (Position 3) buttons.
 - If you adjust the position after moving to a pre-set position, the position display will disappear.
- For installation, refer to the Installation Manual provided with the wall mount.
 - For product installation and the installation and moving of the wall mount, make sure to consult a specialized installation company.
 - This installation manual is to be used when attaching the wall mount to a wall. When attaching to other building materials, please contact your nearest dealer.
 - The auto wall mount will not work when Anynet+ or WISELINK Pro is operating.
 - LN46A850S1F and LN46A860S2F models are not compatible with the old electrically powered wall mount model (WMN5090A).

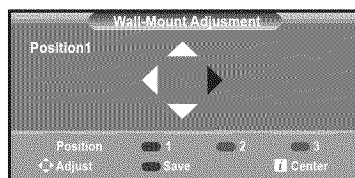
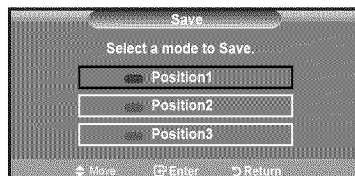
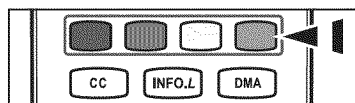
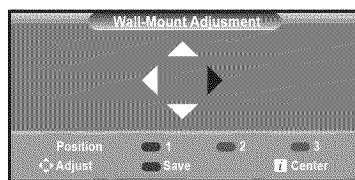
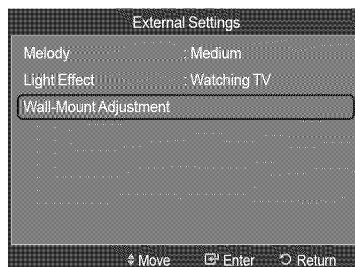
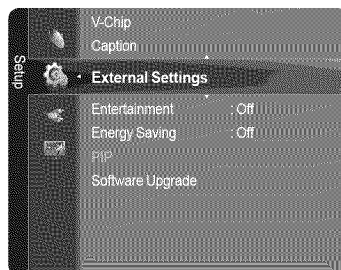

Wall Mount Kit Specifications (VESA)

Install your wall mount on a solid wall perpendicular to the floor. When attaching to other building materials, please contact your nearest dealer. If installed on a ceiling or slanted wall, it may fall and result in severe personal injury.

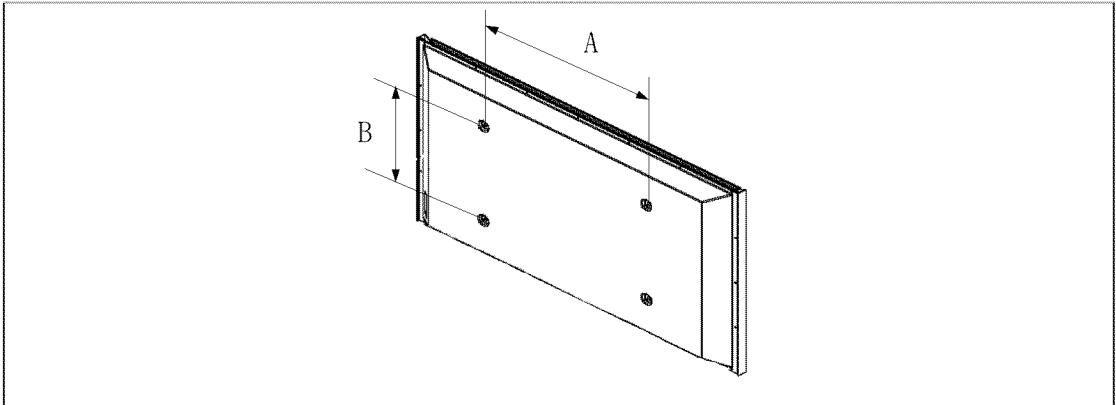

Product Family	inches, model	VESA Spec. (A * B)	Standard Screw	Quantity
LCD-TV	23~ 26	200 * 100	M4	4
	32 ~ 40	200 * 200	M6	
	LN46A850S1F, LN46A860S2F, LN52A850S1F, LN52A860S2F	400 * 400	M8	
	57	700 * 400 (No VESA)		
	57 ~ 70	800 * 400		
	80 ~	1400 * 800		
PDP-TV	42 ~ 50	600 * 400	M8	4
	55 ~ 70	800 * 400		
	63	No VESA		6
	80 ~	1400 * 800		4

- Standard dimensions for wall mount kits are shown in the table above.
- When purchasing our wall mount kit, a detailed installation manual and all parts necessary for assembly are provided.
- Do not use screws longer than the standard dimension, as they may cause damage to the inside of the TV set.
- For wall mounts that do not comply with the VESA standard screw specifications, the length of the screws may differ depending on their specifications.
- Do not use screws that do not comply with the VESA standard screw specifications. Do not fasten the screws too strongly, this may damage the product or cause the product to fall, leading to personal injury. Samsung is not liable for these kinds of accidents.
- Samsung is not liable for product damage or personal injury when a non-VESA or non-specified wall mount is used or the consumer fails to follow the product installation instructions.
- Our 57" and 63" models do not comply with VESA Specifications. Therefore, you should use our dedicated wall mount kit for this model.
- Do not exceed 15 degrees tilt when mounting this TV.

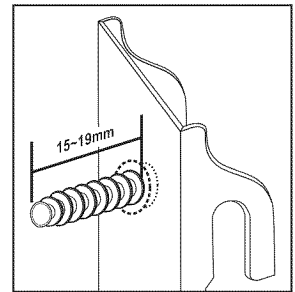

Do not install your Wall Mount Kit while your TV is turned on. It may result in personal injury due to electric shock.

Using the Anti-Theft Kensington Lock

The Kensington Lock is a device used to physically fix the system when using it in a public place. The appearance and locking method may differ from the illustration depending on the manufacturer. Refer to the manual provided with the Kensington Lock for proper use. The locking device has to be purchased separately.

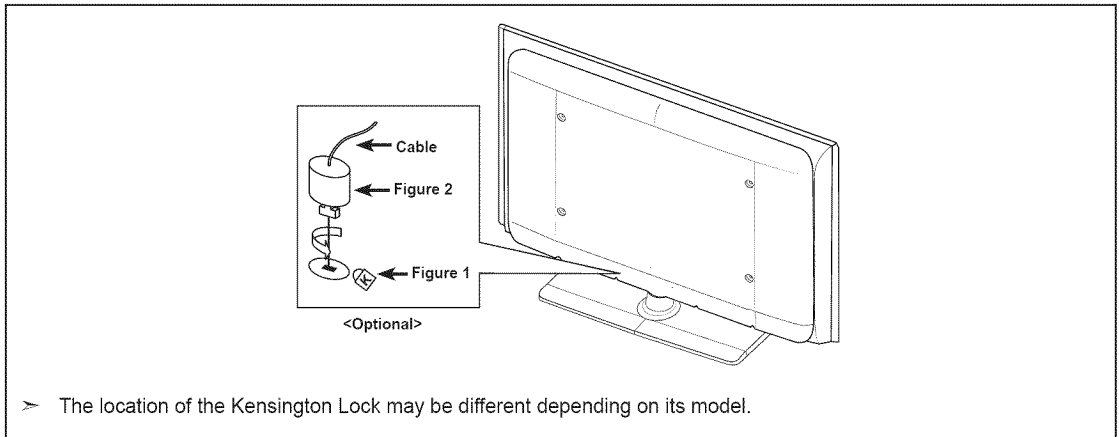

1. Insert the locking device into the Kensington slot on the LCD TV (Figure 1) and turn it in the locking direction (Figure 2).
2. Connect the Kensington Lock cable.
3. Fix the Kensington Lock to a desk or a heavy stationary object.

Securing the TV to the Wall



Caution: Pulling, pushing, or climbing on the TV may cause the TV to fall. In particular, ensure your children do not hang over or destabilize the TV; doing so may cause the TV to tip over, causing serious injuries or death. Follow all safety precautions provided on the included Safety Flyer. For added stability, install the anti-fall device for safety purposes, as follows.

To secure the TV:

1. Put the screws into the clamps and firmly fasten them onto the wall. Confirm that the screws have been firmly installed onto the wall.
 - You may need additional material such as an anchor depending on the type of wall.
 - Since the necessary clamps, screws, and string are not supplied, please purchase them separately.

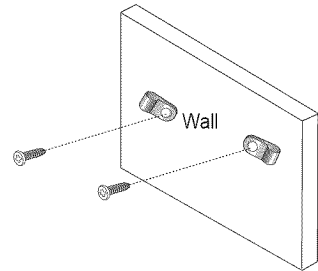

2. Remove the screws from the center back of the TV, put the screws into the clamps, and then fasten the screws onto the TV again.
 - Screws may not be supplied with the product. In this case, please purchase the screws of the following specifications.

Screw Specifications

- For a 17 ~ 29 Inch LCD TV: M4 X 15
- For a 32 ~ 40 Inch LCD TV: M6 X 15

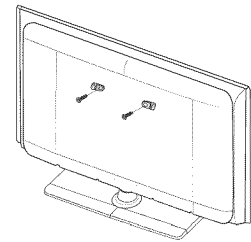

3. Connect the clamps fixed onto the TV and the clamps fixed onto the wall with a strong cable.
 - Install the TV near to the wall so that it does not fall backwards.
 - It is safe to connect the cable so that the clamps fixed on the wall are equal to or lower than the clamps fixed on the TV.
 - Remove the cable before moving the TV.
4. Verify all connections are properly secured. Periodically check connections for any sign of fatigue or failure. If you have any doubt about the security of your connections, contact a professional installer.

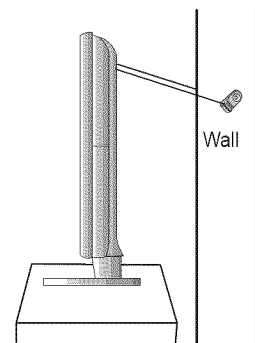

Specifications

Model Name	LN46A860S1F, LN46A860S2F	LN52A860S1F, LN52A860S2F
Screen Size (Diagonal)	46 inches (45.9 inches measured diagonally)	52 inches (52.0 inches measured diagonally)
PC Resolution	1920 x 1080 @ 60 Hz	1920 x 1080 @ 60 Hz
Sound Output	10W X 2	10W X 2
Dimensions (WxDxH)		
Body	44.1 X 1.9 X 27.3 inches (1 119.0 X 48.4 X 692.5 mm)	49.7 X 1.9 X 30.7 inches (1 263.1 X 48.4 X 779.3 mm)
With stand	44.1 X 11.1 X 29.3 inches (1 119.0 X 283.0 X 745.1 mm)	49.7 X 12.4 X 32.7 inches (1 263.1 X 314.0 X 831.7 mm)
Weight		
With Stand	55.0 lbs (25.0 kg)	68.8 lbs (31.2 kg)
Without Stand	46.1 lbs (20.9 kg)	59.1 lbs (26.8 kg)
Environmental Considerations		
Operating Temperature	50°F to 104°F (10°C to 40°C)	
Operating Humidity	10% to 80%, non-condensing	
Storage Temperature	-4°F to 113°F (-20°C to 45°C)	
Storage Humidity	5% to 95%, non-condensing	
Stand Swivel (Left / Right)	-20° ~ 20°	

- Design and specifications are subject to change without prior notice.
- This device is a Class B digital apparatus.
- For the power supply and Power Consumption, refer to the label attached to the product.

Dimensions

LN52A850S1F, LN52A860S2F

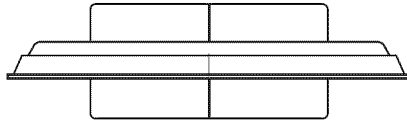

TOP VIEW

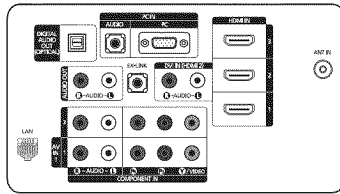

JACK PANEL DETAIL 3.7"(H) X 9.1"(W)

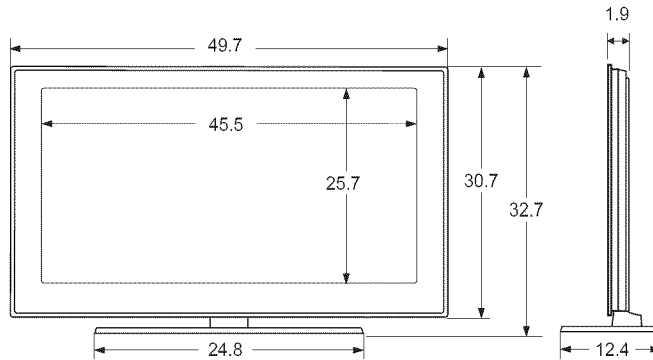

FRONT VIEW / SIDE VIEW

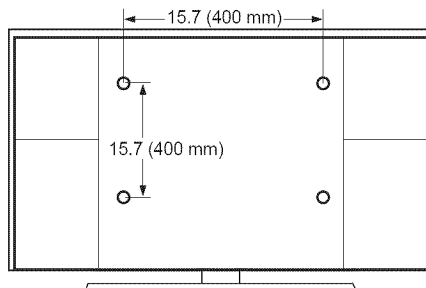

REAR VIEW

NOTE: All drawings are not necessarily to scale.
Some dimensions are subject to change without prior notice.
Refer to the dimensions prior to performing installation of your TV.
Not responsible for typographical or printed errors.
© 2008 Samsung Electronics America, Inc.

- This product uses parts of the software from the Independent JPEG Group.
- This product uses parts of the software owned by the Freetype Project (www.freetype.org).
- This product uses some software programs which are distributed under the GPL/LGPL license. Accordingly, the following GPL and LGPL software source codes that have been used in this product can be provided after asking to vdswmanager@samsung.com.
 GPL software: Linux Kernel, Busybox, Binutils
 LGPL software: Glibc, Libusb, Libgphoto2, SDL

The GNU General Public License (GPL)

Version 2, June 1991

Copyright (C) 1989, 1991 Free Software Foundation, Inc. 59 Temple Place, Suite 330, Boston, MA 02111-1307 USA

Everyone is permitted to copy and distribute verbatim copies of this license document, but changing it is not allowed.

Preamble

The licenses for most software are designed to take away your freedom to share and change it. By contrast, the GNU General Public License is intended to guarantee your freedom to share and change free software--to make sure the software is free for all its users. This General Public License applies to most of the Free Software Foundation's software and to any other program whose authors commit to using it. (Some other Free Software Foundation software is covered by the GNU Library General Public License instead.) You can apply it to your programs, too.

When we speak of free software, we are referring to freedom, not price. Our General Public Licenses are designed to make sure that you have the freedom to distribute copies of free software (and charge for this service if you wish), that you receive source code or can get it if you want it, that you can change the software or use pieces of it in new free programs; and that you know you can do these things.

To protect your rights, we need to make restrictions that forbid anyone to deny you these rights or to ask you to surrender the rights. These restrictions translate to certain responsibilities for you if you distribute copies of the software, or if you modify it.

For example, if you distribute copies of such a program, whether gratis or for a fee, you must give the recipients all the rights that you have. You must make sure that they, too, receive or can get the source code. And you must show them these terms so they know their rights.

We protect your rights with two steps: (1) copyright the software, and (2) offer you this license which gives you legal permission to copy, distribute and/or modify the software.

Also, for each author's protection and ours, we want to make certain that everyone understands that there is no warranty for this free software. If the software is modified by someone else and passed on, we want its recipients to know that what they have is not the original, so that any problems introduced by others will not reflect on the original authors' reputations.

Finally, any free program is threatened constantly by software patents. We wish to avoid the danger that redistributors of a free program will individually obtain patent licenses, in effect making the program proprietary. To prevent this, we have made it clear that any patent must be licensed for everyone's free use or not licensed at all.

The precise terms and conditions for copying, distribution and modification follow.

TERMS AND CONDITIONS FOR COPYING, DISTRIBUTION AND MODIFICATION

0. This License applies to any program or other work which contains a notice placed by the copyright holder saying it may be distributed under the terms of this General Public License. The "Program", below, refers to any such program or work, and a "work based on the Program" means either the Program or any derivative work under copyright law: that is to say, a work containing the Program or a portion of it, either verbatim or with modifications and/or translated into another language. (Hereinafter, translation is included without limitation in the term "modification".) Each licensee is addressed as "you".

Activities other than copying, distribution and modification are not covered by this License; they are outside its scope. The act of running the Program is not restricted, and the output from the Program is covered only if its contents constitute a work based on the Program (independent of having been made by running the Program). Whether that is true depends on what the Program does.

1. You may copy and distribute verbatim copies of the Program's source code as you receive it, in any medium, provided that you conspicuously and appropriately publish on each copy an appropriate copyright notice and disclaimer of warranty; keep intact all the notices that refer to this License and to the absence of any warranty; and give any other recipients of the Program a copy of this License along with the Program.

You may charge a fee for the physical act of transferring a copy, and you may at your option offer warranty protection in exchange for a fee.

2. You may modify your copy or copies of the Program or any portion of it, thus forming a work based on the Program, and copy and distribute such modifications or work under the terms of Section 1 above, provided that you also meet all of these conditions:

- a) You must cause the modified files to carry prominent notices stating that you changed the files and the date of any change.
- b) You must cause any work that you distribute or publish, that in whole or in part contains or is derived from the Program or any part thereof, to be licensed as a whole at no charge to all third parties under the terms of this License.
- c) If the modified program normally reads commands interactively when run, you must cause it, when started running for such interactive use in the most ordinary way, to print or display an announcement including an appropriate copyright notice and a notice that there is no warranty (or else, saying that you provide a warranty) and that users may redistribute the program under these conditions, and telling the user how to view a copy of this License. (Exception: if the Program itself is interactive but does not normally print such an announcement, your work based on the Program is not required to print an announcement.)

These requirements apply to the modified work as a whole. If identifiable sections of that work are not derived from the Program, and can be reasonably considered independent and separate works in themselves, then this License, and its terms, do not apply to those sections when you distribute them as separate works. But when you distribute the same sections as part of a whole which is a work based on the Program, the distribution of the whole must be on the terms of this License, whose permissions for other licensees extend to the entire whole, and thus to each and every part regardless of who wrote it.

Thus, it is not the intent of this section to claim rights or contest your rights to work written entirely by you; rather, the intent is to exercise the right to control the distribution of derivative or collective works based on the Program.

In addition, mere aggregation of another work not based on the Program with the Program (or with a work based on the Program) on a volume of a storage or distribution medium does not bring the other work under the scope of this License.

3. You may copy and distribute the Program (or a work based on it, under Section 2) in object code or executable form under the terms of Sections 1 and 2 above provided that you also do one of the following:

- a) Accompany it with the complete corresponding machine-readable source code, which must be distributed under the terms of Sections 1 and 2 above on a medium customarily used for software interchange; or,
- b) Accompany it with a written offer, valid for at least three years, to give any third party, for a charge no more than your cost of physically performing source distribution, a complete machine-readable copy of the corresponding source code, to be distributed under the terms of Sections 1 and 2 above on a medium customarily used for software interchange; or,
- c) Accompany it with the information you received as to the offer to distribute corresponding source code. (This alternative is allowed only for noncommercial distribution and only if you received the program in object code or executable form with such an offer, in accord with Subsection b above.)

The source code for a work means the preferred form of the work for making modifications to it. For an executable work, complete source code means all the source code for all modules it contains, plus any associated interface definition files, plus the scripts used to control compilation and installation of the executable. However, as a special exception, the source code distributed need not include anything that is normally distributed (in either source or binary form) with the major components (compiler, kernel, and so on) of the operating system on which the executable runs, unless that component itself accompanies the executable.

If distribution of executable or object code is made by offering access to copy from a designated place, then offering equivalent access to copy the source code from the same place counts as distribution of the source code, even though third parties are not compelled to copy the source along with the object code.

4. You may not copy, modify, sublicense, or distribute the Program except as expressly provided under this License. Any attempt otherwise to copy, modify, sublicense or distribute the Program is void, and will automatically terminate your rights under this License. However, parties who have received copies, or rights, from you under this License will not have their licenses terminated so long as such parties remain in full compliance.

5. You are not required to accept this License, since you have not signed it. However, nothing else grants you permission to modify or distribute the Program or its derivative works. These actions are prohibited by law if you do not accept this License. Therefore, by modifying or distributing the Program (or any work based on the Program), you indicate your acceptance of this License to do so, and all its terms and conditions for copying, distributing or modifying the Program or works based on it.

6. Each time you redistribute the Program (or any work based on the Program), the recipient automatically receives a license from the original licensor to copy, distribute or modify the Program subject to these terms and conditions. You may not impose any further restrictions on the recipients' exercise of the rights granted herein. You are not responsible for enforcing compliance by third parties to this License.

7. If, as a consequence of a court judgment or allegation of patent infringement or for any other reason (not limited to patent issues), conditions are imposed on you (whether by court order, agreement or otherwise) that contradict the conditions of this License, they do not excuse you from the conditions of this License. If you cannot distribute so as to satisfy simultaneously your obligations under this License and any other pertinent obligations, then as a consequence you may not distribute the Program at all. For example, if a patent license would not permit royalty-free redistribution of the Program by all those who receive copies directly or indirectly through you, then the only way you could satisfy both it and this License would be to refrain entirely from distribution of the Program.

If any portion of this section is held invalid or unenforceable under any particular circumstance, the balance of the section is intended to apply and the section as a whole is intended to apply in other circumstances.

It is not the purpose of this section to induce you to infringe any patents or other property right claims or to contest validity of any such claims; this section has the sole purpose of protecting the integrity of the free software distribution system, which is implemented by public license practices. Many people have made generous contributions to the wide range of software distributed through that system in reliance on consistent application of that system; it is up to the author/donor to decide if he or she is willing to distribute software through any other system and a licensee cannot impose that choice.

This section is intended to make thoroughly clear what is believed to be a consequence of the rest of this License.

8. If the distribution and/or use of the Program is restricted in certain countries either by patents or by copyrighted interfaces, the original copyright holder who places the Program under this License may add an explicit geographical distribution limitation excluding those countries, so that distribution is permitted only in or among countries not thus excluded. In such case, this License incorporates the limitation as if written in the body of this License.

9. The Free Software Foundation may publish revised and/or new versions of the General Public License from time to time. Such new versions will be similar in spirit to the present version, but may differ in detail to address new problems or concerns.

Each version is given a distinguishing version number. If the Program specifies a version number of this License which applies to it and "any later version", you have the option of following the terms and conditions either of that version or of any later version published by the Free Software Foundation. If the Program does not specify a version number of this License, you may choose any version ever published by the Free Software Foundation.

10. If you wish to incorporate parts of the Program into other free programs whose distribution conditions are different, write to the author to ask for permission. For software which is copyrighted by the Free Software Foundation, write to the Free Software Foundation; we sometimes make exceptions for this. Our decision will be guided by the two goals of preserving the free status of all derivatives of our free software and of promoting the sharing and reuse of software generally.

NO WARRANTY

11. BECAUSE THE PROGRAM IS LICENSED FREE OF CHARGE, THERE IS NO WARRANTY FOR THE PROGRAM, TO THE EXTENT PERMITTED BY APPLICABLE LAW. EXCEPT WHEN OTHERWISE STATED IN WRITING THE COPYRIGHT HOLDERS AND/OR OTHER PARTIES PROVIDE THE PROGRAM "AS IS" WITHOUT WARRANTY OF ANY KIND, EITHER EXPRESSED OR IMPLIED, INCLUDING, BUT NOT LIMITED TO, THE IMPLIED WARRANTIES OF MERCHANTABILITY AND FITNESS FOR A PARTICULAR PURPOSE. THE ENTIRE RISK AS TO THE QUALITY AND PERFORMANCE OF THE PROGRAM IS WITH YOU. SHOULD THE PROGRAM PROVE DEFECTIVE, YOU ASSUME THE COST OF ALL NECESSARY SERVICING, REPAIR OR CORRECTION.

12. IN NO EVENT UNLESS REQUIRED BY APPLICABLE LAW OR AGREED TO IN WRITING WILL ANY COPYRIGHT HOLDER, OR ANY OTHER PARTY WHO MAY MODIFY AND/OR REDISTRIBUTE THE PROGRAM AS PERMITTED ABOVE, BE LIABLE TO YOU FOR DAMAGES, INCLUDING ANY GENERAL, SPECIAL, INCIDENTAL OR CONSEQUENTIAL DAMAGES ARISING OUT OF THE USE OR INABILITY TO USE THE PROGRAM (INCLUDING BUT NOT LIMITED TO LOSS OF DATA OR DATA BEING RENDERED INACCURATE OR LOSSES SUSTAINED BY YOU OR THIRD PARTIES OR A FAILURE OF THE PROGRAM TO OPERATE WITH ANY OTHER PROGRAMS), EVEN IF SUCH HOLDER OR OTHER PARTY HAS BEEN ADVISED OF THE POSSIBILITY OF SUCH DAMAGES.

END OF TERMS AND CONDITIONS

How to Apply These Terms to Your New Programs

If you develop a new program, and you want it to be of the greatest possible use to the public, the best way to achieve this is to make it free software which everyone can redistribute and change under these terms.

To do so, attach the following notices to the program. It is safest to attach them to the start of each source file to most effectively convey the exclusion of warranty; and each file should have at least the "copyright" line and a pointer to where the full notice is found.

One line to give the program's name and a brief idea of what it does.

Copyright (C) <year> <name of author>

This program is free software; you can redistribute it and/or modify it under the terms of the GNU General Public License as published by the Free Software Foundation; either version 2 of the License, or (at your option) any later version.

This program is distributed in the hope that it will be useful, but WITHOUT ANY WARRANTY; without even the implied warranty of MERCHANTABILITY or FITNESS FOR A PARTICULAR PURPOSE. See the GNU General Public License for more details.

You should have received a copy of the GNU General Public License along with this program; if not, write to the Free Software Foundation, Inc., 59 Temple Place, Suite 330, Boston, MA 02111-1307 USA

Also add information on how to contact you by electronic and paper mail.

If the program is interactive, make it output a short notice like this when it starts in an interactive mode:

Gnomovision version 69, Copyright (C) year name of author Gnomovision comes with ABSOLUTELY NO WARRANTY; for details type `show w'. This is free software, and you are welcome to redistribute it under certain conditions; type `show c' for details.

The hypothetical commands `show w' and `show c' should show the appropriate parts of the General Public License. Of course, the commands you use may be called something other than `show w' and `show c'; they could even be mouse-clicks or menu items--whatever suits your program.

You should also get your employer (if you work as a programmer) or your school, if any, to sign a "copyright disclaimer" for the program, if necessary. Here is a sample; alter the names:

Yoyodyne, Inc., hereby disclaims all copyright interest in the program `Gnomovision' (which makes passes at compilers) written by James Hacker.

signature of Ty Coon, 1 April 1989

Ty Coon, President of Vice

This General Public License does not permit incorporating your program into proprietary programs. If your program is a subroutine library, you may consider it more useful to permit linking proprietary applications with the library. If this is what you want to do, use the GNU Library General Public License instead of this License.

GNU Lesser General Public License (LGPL)

Version 2.1, February 1999

Copyright (C) 1991, 1999 Free Software Foundation, Inc. 59 Temple Place, Suite 330, Boston, MA 02111-1307 USA
Everyone is permitted to copy and distribute verbatim copies of this license document, but changing it is not allowed.

[This is the first released version of the Lesser GPL. It also counts as the successor of the GNU Library Public License, version 2, hence the version number 2.1.]

Preamble

The licenses for most software are designed to take away your freedom to share and change it. By contrast, the GNU General Public Licenses are intended to guarantee your freedom to share and change free software--to make sure the software is free for all its users.

This license, the Lesser General Public License, applies to some specially designated software packages--typically libraries--of the Free Software Foundation and other authors who decide to use it. You can use it too, but we suggest you first think carefully about whether this license or the ordinary General Public License is the better strategy to use in any particular case, based on the explanations below.

When we speak of free software, we are referring to freedom of use, not price. Our General Public Licenses are designed to make sure that you have the freedom to distribute copies of free software (and charge for this service if you wish); that you receive source code or can get it if you want it; that you can change the software and use pieces of it in new free programs; and that you are informed that you can do these things.

To protect your rights, we need to make restrictions that forbid distributors to deny you these rights or to ask you to surrender these rights. These restrictions translate to certain responsibilities for you if you distribute copies of the library or if you modify it.

For example, if you distribute copies of the library, whether gratis or for a fee, you must give the recipients all the rights that we gave you. You must make sure that they, too, receive or can get the source code. If you link other code with the library, you must provide complete object files to the recipients, so that they can relink them with the library after making changes to the library and recompiling it. And you must show them these terms so they know their rights.

We protect your rights with a two-step method: (1) we copyright the library, and (2) we offer you this license, which gives you legal permission to copy, distribute and/or modify the library.

To protect each distributor, we want to make it very clear that there is no warranty for the free library. Also, if the library is modified by someone else and passed on, the recipients should know that what they have is not the original version, so that the original author's reputation will not be affected by problems that might be introduced by others.

Finally, software patents pose a constant threat to the existence of any free program. We wish to make sure that a company cannot effectively restrict the users of a free program by obtaining a restrictive license from a patent holder. Therefore, we insist that any patent license obtained for a version of the library must be consistent with the full freedom of use specified in this license.

Most GNU software, including some libraries, is covered by the ordinary GNU General Public License. This license, the GNU Lesser General Public License, applies to certain designated libraries, and is quite different from the ordinary General Public License. We use this license for certain libraries in order to permit linking those libraries into non-free programs.

When a program is linked with a library, whether statically or using a shared library, the combination of the two is legally speaking a combined work, a derivative of the original library. The ordinary General Public License therefore permits such linking only if the entire combination fits its criteria of freedom. The Lesser General Public License permits more lax criteria for linking other code with the library.

We call this license the "Lesser" General Public License because it does Less to protect the user's freedom than the ordinary General Public License. It also provides other free software developers Less of an advantage over competing non-free programs. These disadvantages are the reason we use the ordinary General Public License for many libraries. However, the Lesser license provides advantages in certain special circumstances.

For example, on rare occasions, there may be a special need to encourage the widest possible use of a certain library, so that it becomes a de-facto standard. To achieve this, non-free programs must be allowed to use the library. A more frequent case is that a free library does the same job as widely used non-free libraries. In this case, there is little to gain by limiting the free library to free software only, so we use the Lesser General Public License.

In other cases, permission to use a particular library in non-free programs enables a greater number of people to use a large body of free software. For example, permission to use the GNU C Library in non-free programs enables many more people to use the whole GNU operating system, as well as its variant, the GNU/Linux operating system.

Although the Lesser General Public License is Less protective of the users' freedom, it does ensure that the user of a program that is linked with the Library has the freedom and the wherewithal to run that program using a modified version of the Library.

The precise terms and conditions for copying, distribution and modification follow. Pay close attention to the difference between a "work based on the library" and a "work that uses the library". The former contains code derived from the library, whereas the latter must be combined with the library in order to run.

TERMS AND CONDITIONS FOR COPYING, DISTRIBUTION AND MODIFICATION

0. This License Agreement applies to any software library or other program which contains a notice placed by the copyright holder or other authorized party saying it may be distributed under the terms of this Lesser General Public License (also called "this License"). Each licensee is addressed as "you".

A "library" means a collection of software functions and/or data prepared so as to be conveniently linked with application programs (which use some of those functions and data) to form executables.

The "Library", below, refers to any such software library or work which has been distributed under these terms. A "work based on the Library" means either the Library or any derivative work under copyright law: that is to say, a work containing the Library or a portion of it, either verbatim or with modifications and/or translated straightforwardly into another language. (Hereinafter, translation is included without limitation in the term "modification".)

"Source code" for a work means the preferred form of the work for making modifications to it. For a library, complete source code means all the source code for all modules it contains, plus any associated interface definition files, plus the scripts used to control compilation and installation of the library.

Activities other than copying, distribution and modification are not covered by this License; they are outside its scope. The act of running a program using the Library is not restricted, and output from such a program is covered only if its contents constitute a work based on the Library (independent of the use of the Library in a tool for writing it). Whether that is true depends on what the Library does and what the program that uses the Library does.

1. You may copy and distribute verbatim copies of the Library's complete source code as you receive it, in any medium, provided that you conspicuously and appropriately publish on each copy an appropriate copyright notice and disclaimer of warranty; keep intact all the notices that refer to this License and to the absence of any warranty; and distribute a copy of this License along with the Library.

You may charge a fee for the physical act of transferring a copy, and you may at your option offer warranty protection in exchange for a fee.

2. You may modify your copy or copies of the Library or any portion of it, thus forming a work based on the Library, and copy and distribute such modifications or work under the terms of Section 1 above, provided that you also meet all of these conditions:

- a) The modified work must itself be a software library.
- b) You must cause the files modified to carry prominent notices stating that you changed the files and the date of any change.
- c) You must cause the whole of the work to be licensed at no charge to all third parties under the terms of this License.
- d) If a facility in the modified Library refers to a function or a table of data to be supplied by an application program that uses the facility, other than as an argument passed when the facility is invoked, then you must make a good faith effort to ensure that, in the event an application does not supply such function or table, the facility still operates, and performs whatever part of its purpose remains meaningful.

(For example, a function in a library to compute square roots has a purpose that is entirely well-defined independent of the application. Therefore, Subsection 2d requires that any application-supplied function or table used by this function must be optional: if the application does not supply it, the square root function must still compute square roots.)

These requirements apply to the modified work as a whole. If identifiable sections of that work are not derived from the Library, and can be reasonably considered independent and separate works in themselves, then this License, and its terms, do not apply to those sections when you distribute them as separate works. But when you distribute the same sections as part of a whole which is a work based on the Library, the distribution of the whole must be on the terms of this License, whose permissions for other licensees extend to the entire whole, and thus to each and every part regardless of who wrote it.

Thus, it is not the intent of this section to claim rights or contest your rights to work written entirely by you; rather, the intent is to exercise the right to control the distribution of derivative or collective works based on the Library.

In addition, mere aggregation of another work not based on the Library with the Library (or with a work based on the Library) on a volume of a storage or distribution medium does not bring the other work under the scope of this License.

3. You may opt to apply the terms of the ordinary GNU General Public License instead of this License to a given copy of the Library. To do this, you must alter all the notices that refer to this License, so that they refer to the ordinary GNU General Public License, version 2, instead of to this License. (If a newer version than version 2 of the ordinary GNU General Public License has appeared, then you can specify that version instead if you wish.) Do not make any other change in these notices.

Once this change is made in a given copy, it is irreversible for that copy, so the ordinary GNU General Public License applies to all subsequent copies and derivative works made from that copy.

This option is useful when you wish to copy part of the code of the Library into a program that is not a library.

4. You may copy and distribute the Library (or a portion or derivative of it, under Section 2) in object code or executable form under the terms of Sections 1 and 2 above provided that you accompany it with the complete corresponding machine-readable source code, which must be distributed under the terms of Sections 1 and 2 above on a medium customarily used for software interchange.

If distribution of object code is made by offering access to copy from a designated place, then offering equivalent access to copy the source code from the same place satisfies the requirement to distribute the source code, even though third parties are not compelled to copy the source along with the object code.

5. A program that contains no derivative of any portion of the Library, but is designed to work with the Library by being compiled or linked with it, is called a “work that uses the Library”. Such a work, in isolation, is not a derivative work of the Library, and therefore falls outside the scope of this License.

However, linking a “work that uses the Library” with the Library creates an executable that is a derivative of the Library (because it contains portions of the Library), rather than a “work that uses the library”. The executable is therefore covered by this License. Section 6 states terms for distribution of such executables.

When a “work that uses the Library” uses material from a header file that is part of the Library, the object code for the work may be a derivative work of the Library even though the source code is not. Whether this is true is especially significant if the work can be linked without the Library, or if the work is itself a library. The threshold for this to be true is not precisely defined by law.

If such an object file uses only numerical parameters, data structure layouts and accessors, and small macros and small inline functions (ten lines or less in length), then the use of the object file is unrestricted, regardless of whether it is legally a derivative work. (Executables containing this object code plus portions of the Library will still fall under Section 6.)

Otherwise, if the work is a derivative of the Library, you may distribute the object code for the work under the terms of Section 6. Any executables containing that work also fall under Section 6, whether or not they are linked directly with the Library itself.

6. As an exception to the Sections above, you may also combine or link a “work that uses the Library” with the Library to produce a work containing portions of the Library, and distribute that work under terms of your choice, provided that the terms permit modification of the work for the customer’s own use and reverse engineering for debugging such modifications.

You must give prominent notice with each copy of the work that the Library is used in it and that the Library and its use are covered by this License. You must supply a copy of this License. If the work during execution displays copyright notices, you must include the copyright notice for the Library among them, as well as a reference directing the user to the copy of this License. Also, you must do one of these things:

- a) Accompany the work with the complete corresponding machine-readable source code for the Library including whatever changes were used in the work (which must be distributed under Sections 1 and 2 above); and, if the work is an executable linked with the Library, with the complete machine-readable “work that uses the Library”, as object code and/or source code, so that the user can modify the Library and then relink to produce a modified executable containing the modified Library. (It is understood that the user who changes the contents of definitions files in the Library will not necessarily be able to recompile the application to use the modified definitions.)
- b) Use a suitable shared library mechanism for linking with the Library. A suitable mechanism is one that (1) uses at run time a copy of the library already present on the user’s computer system, rather than copying library functions into the executable, and (2) will operate properly with a modified version of the library, if the user installs one, as long as the modified version is interface-compatible with the version that the work was made with.
- c) Accompany the work with a written offer, valid for at least three years, to give the same user the materials specified in Subsection 6a, above, for a charge no more than the cost of performing this distribution.
- d) If distribution of the work is made by offering access to copy from a designated place, offer equivalent access to copy the above specified materials from the same place.
- e) Verify that the user has already received a copy of these materials or that you have already sent this user a copy.

For an executable, the required form of the “work that uses the Library” must include any data and utility programs needed for reproducing the executable from it. However, as a special exception, the materials to be distributed need not include anything that is normally distributed (in either source or binary form) with the major components (compiler, kernel, and so on) of the operating system on which the executable runs, unless that component itself accompanies the executable.

It may happen that this requirement contradicts the license restrictions of other proprietary libraries that do not normally accompany the operating system. Such a contradiction means you cannot use both them and the Library together in an executable that you distribute.

7. You may place library facilities that are a work based on the Library side-by-side in a single library together with other library facilities not covered by this License, and distribute such a combined library, provided that the separate distribution of the work based on the Library and of the other library facilities is otherwise permitted, and provided that you do these two things:

- a) Accompany the combined library with a copy of the same work based on the Library, uncombined with any other library facilities. This must be distributed under the terms of the Sections above.
- b) Give prominent notice with the combined library of the fact that part of it is a work based on the Library, and explaining where to find the accompanying uncombined form of the same work.

8. You may not copy, modify, sublicense, link with, or distribute the Library except as expressly provided under this License. Any attempt otherwise to copy, modify, sublicense, link with, or distribute the Library is void, and will automatically terminate your rights under this License. However, parties who have received copies, or rights, from you under this License will not have their licenses terminated so long as such parties remain in full compliance.

9. You are not required to accept this License, since you have not signed it. However, nothing else grants you permission to modify or distribute the Library or its derivative works. These actions are prohibited by law if you do not accept this License. Therefore, by modifying or distributing the Library (or any work based on the Library), you indicate your acceptance of this License to do so, and all its terms and conditions for copying, distributing or modifying the Library or works based on it.

10. Each time you redistribute the Library (or any work based on the Library), the recipient automatically receives a license from the original licensor to copy, distribute, link with or modify the Library subject to these terms and conditions. You may not impose any further restrictions on the recipients' exercise of the rights granted herein. You are not responsible for enforcing compliance by third parties with this License.

11. If, as a consequence of a court judgment or allegation of patent infringement or for any other reason (not limited to patent issues), conditions are imposed on you (whether by court order, agreement or otherwise) that contradict the conditions of this License, they do not excuse you from the conditions of this License. If you cannot distribute so as to satisfy simultaneously your obligations under this License and any other pertinent obligations, then as a consequence you may not distribute the Library at all. For example, if a patent license would not permit royalty-free redistribution of the Library by all those who receive copies directly or indirectly through you, then the only way you could satisfy both it and this License would be to refrain entirely from distribution of the Library.

If any portion of this section is held invalid or unenforceable under any particular circumstance, the balance of the section is intended to apply, and the section as a whole is intended to apply in other circumstances.

It is not the purpose of this section to induce you to infringe any patents or other property right claims or to contest validity of any such claims; this section has the sole purpose of protecting the integrity of the free software distribution system which is implemented by public license practices. Many people have made generous contributions to the wide range of software distributed through that system in reliance on consistent application of that system; it is up to the author/donor to decide if he or she is willing to distribute software through any other system and a licensee cannot impose that choice.

This section is intended to make thoroughly clear what is believed to be a consequence of the rest of this License.

12. If the distribution and/or use of the Library is restricted in certain countries either by patents or by copyrighted interfaces, the original copyright holder who places the Library under this License may add an explicit geographical distribution limitation excluding those countries, so that distribution is permitted only in or among countries not thus excluded. In such case, this License incorporates the limitation as if written in the body of this License.

13. The Free Software Foundation may publish revised and/or new versions of the Lesser General Public License from time to time. Such new versions will be similar in spirit to the present version, but may differ in detail to address new problems or concerns.

Each version is given a distinguishing version number. If the Library specifies a version number of this License which applies to it and "any later version", you have the option of following the terms and conditions either of that version or of any later version published by the Free Software Foundation. If the Library does not specify a license version number, you may choose any version ever published by the Free Software Foundation.

14. If you wish to incorporate parts of the Library into other free programs whose distribution conditions are incompatible with these, write to the author to ask for permission. For software which is copyrighted by the Free Software Foundation, write to the Free Software Foundation; we sometimes make exceptions for this. Our decision will be guided by the two goals of preserving the free status of all derivatives of our free software and of promoting the sharing and reuse of software generally.

NO WARRANTY

15. BECAUSE THE LIBRARY IS LICENSED FREE OF CHARGE, THERE IS NO WARRANTY FOR THE LIBRARY, TO THE EXTENT PERMITTED BY APPLICABLE LAW. EXCEPT WHEN OTHERWISE STATED IN WRITING THE COPYRIGHT HOLDERS AND/OR OTHER PARTIES PROVIDE THE LIBRARY "AS IS" WITHOUT WARRANTY OF ANY KIND, EITHER EXPRESSED OR IMPLIED, INCLUDING, BUT NOT LIMITED TO, THE IMPLIED WARRANTIES OF MERCHANTABILITY AND FITNESS FOR A PARTICULAR PURPOSE. THE ENTIRE RISK AS TO THE QUALITY AND PERFORMANCE OF THE LIBRARY IS WITH YOU. SHOULD THE LIBRARY PROVE DEFECTIVE, YOU ASSUME THE COST OF ALL NECESSARY SERVICING, REPAIR OR CORRECTION.

16. IN NO EVENT UNLESS REQUIRED BY APPLICABLE LAW OR AGREED TO IN WRITING WILL ANY COPYRIGHT HOLDER, OR ANY OTHER PARTY WHO MAY MODIFY AND/OR REDISTRIBUTE THE LIBRARY AS PERMITTED ABOVE, BE LIABLE TO YOU FOR DAMAGES, INCLUDING ANY GENERAL, SPECIAL, INCIDENTAL OR CONSEQUENTIAL DAMAGES ARISING OUT OF THE USE OR INABILITY TO USE THE LIBRARY (INCLUDING BUT NOT LIMITED TO LOSS OF DATA OR DATA BEING RENDERED INACCURATE OR LOSSES SUSTAINED BY YOU OR THIRD PARTIES OR A FAILURE OF THE LIBRARY TO OPERATE WITH ANY OTHER SOFTWARE), EVEN IF SUCH HOLDER OR OTHER PARTY HAS BEEN ADVISED OF THE POSSIBILITY OF SUCH DAMAGES.

END OF TERMS AND CONDITIONS

How to Apply These Terms to Your New Libraries

If you develop a new library, and you want it to be of the greatest possible use to the public, we recommend making it free software that everyone can redistribute and change. You can do so by permitting redistribution under these terms (or, alternatively, under the terms of the ordinary General Public License).

To apply these terms, attach the following notices to the library. It is safest to attach them to the start of each source file to most effectively convey the exclusion of warranty; and each file should have at least the "copyright" line and a pointer to where the full notice is found.

<one line to give the library's name and an idea of what it does.> Copyright (C) <year> <name of author>

This library is free software; you can redistribute it and/or modify it under the terms of the GNU Lesser General Public License as published by the Free Software Foundation; either version 2.1 of the License, or (at your option) any later version.

This library is distributed in the hope that it will be useful, but WITHOUT ANY WARRANTY; without even the implied warranty of MERCHANTABILITY or FITNESS FOR A PARTICULAR PURPOSE. See the GNU Lesser General Public License for more details.

You should have received a copy of the GNU Lesser General Public License along with this library; if not, write to the Free Software Foundation, Inc., 59 Temple Place, Suite 330, Boston, MA 02111-1307 USA

Also add information on how to contact you by electronic and paper mail.

You should also get your employer (if you work as a programmer) or your school, if any, to sign a "copyright disclaimer" for the library, if necessary. Here is a sample; alter the names:

Yoyodyne, Inc., hereby disclaims all copyright interest in the library 'Frob' (a library for tweaking knobs) written by James Random Hacker.

signature of Ty Coon, 1 April 1990

Ty Coon, President of Vice

That's all there is to it!