

SEARS

OWNERS MANUAL

MODEL NO.
919.762000

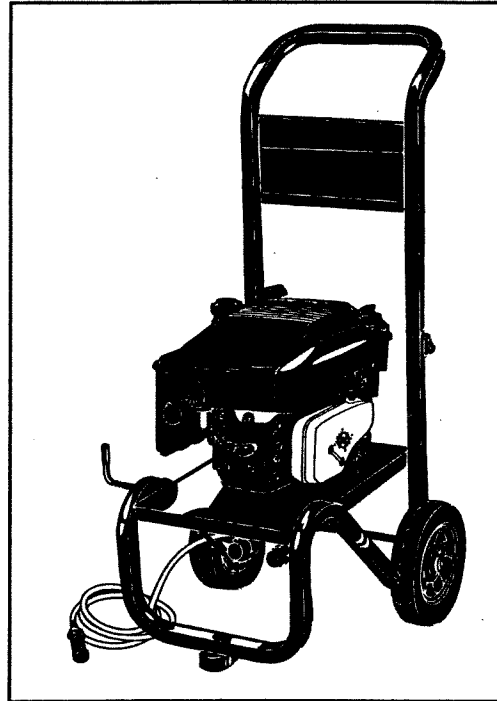

CRAFTSMAN. **6HP 2000 PSI 2 GPM** **HIGH PRESSURE POWER WASHER**

WARNING

Read Owner's Manual. Do not operate equipment until you have read Owners Manual for Safety, Operation, and Maintenance Instructions.

- This product is not equipped with a spark arresting muffler. If the product will be used around flammable materials, or on land covered with materials such as agricultural crops, forest, brush, grass, or other similar items, then an approved spark arrester must be installed and is legally required in the state of California. It is a violation of California statutes section 130050 and/or sections 4442 and 4443 of the California Public Resources Code, unless the engine is equipped with a spark arrester, as defined in section 4442, and maintained in effective working order. Spark arresters are also required on some U.S. Forest service land and may also be legally required under other statutes and ordinances.

Engine exhaust from this product contains chemicals known, in certain quantities, to cause cancer, birth defects or other reproductive harm.

Sears, Roebuck and Co., Hoffman Estates, IL 60179 U.S.A.

TABLE OF CONTENTS

Safety Guidelines	3-4
Operating Instructions	5
Box Contents	6
Assembly Instructions	6
Prestart Instructions	7
Starting Instructions	7
High Pressure Instructions	8
Using Soap/Chemicals	8
Nozzle Cleaning	8
Trouble Shooting	9
Pump Breakdown	10
Parts List	11
Pressure Washer Breakdown	12
Parts List	13
Warranty/Repair/Replacement Parts	Back Cover

SAFETY GUIDELINES - DEFINITIONS



<p>This manual contains information that is important for you to know and understand. This information relates to protecting YOUR SAFETY and PREVENTING EQUIPMENT PROBLEMS. To help you recognize this information, we use the symbols to the right. Please read the manual and pay attention to these sections.</p>	<p>⚠ DANGER</p> <p>URGENT SAFETY INFORMATION - A HAZARD THAT WILL CAUSE SERIOUS INJURY OR LOSS OF LIFE.</p>	<p>⚠ CAUTION</p> <p>Information that you should pay special attention to.</p>
	<p>⚠ WARNING</p> <p>IMPORTANT SAFETY INFORMATION - A HAZARD THAT <i>MIGHT</i> CAUSE SERIOUS INJURY OR LOSS OF LIFE.</p>	<p>NOTE</p> <p>Information for preventing damage to equipment.</p>

IMPORTANT SAFETY INSTRUCTIONS





• SAVE THESE INSTRUCTIONS •

⚠ WARNING

IMPROPER OPERATION OR MAINTENANCE OF THIS PRODUCT COULD RESULT IN SERIOUS INJURY AND PROPERTY DAMAGE. READ AND UNDERSTAND ALL WARNINGS AND OPERATING INSTRUCTIONS BEFORE USING

HAZARD	WHAT CAN HAPPEN	HOW TO PREVENT IT
<p style="text-align: center;">⚠ DANGER</p> <p style="text-align: center;">RISK OF EXPLOSION OR FIRE</p> <div style="text-align: center;">  </div>	<ul style="list-style-type: none"> Spilled gasoline and its vapors can become ignited from cigarette sparks, electrical arcing, exhaust gases, and hot engine components such as the muffler. Heat will expand fuel in the tank which could result in spillage. Operating the pressure washer in an explosive environment could result in a fire. Materials placed against or near the pressure washer can interfere with its proper ventilation features causing overheating and possible ignition of the materials. Improperly stored fuel could lead to accidental ignition. Fuel improperly secured could get into the hands of children or other unqualified persons. 	<ul style="list-style-type: none"> Shut off engine and allow it to cool before adding fuel to the tank. Use care in filling tank to avoid spilling fuel. Move pressure washer away from fueling area before starting engine. Keep maximum fuel level $\frac{1}{2}$" below top of tank to allow for expansion. Operate and fuel equipment in well ventilated areas free from obstructions. Equip areas with fire extinguishers suitable for gasoline fires. Never operate pressure washer in an area containing dry brush or weeds. Store fuel in container approved for gasoline, in a secure location away from work area.
<p style="text-align: center;">⚠ DANGER</p> <p style="text-align: center;">RISK TO BREATHING</p> <div style="text-align: center;">  </div>	<ul style="list-style-type: none"> Breathing exhaust fumes will cause serious injury or death. Some cleaning fluids contain substances which could cause injury to skin, eyes, or lungs. 	<ul style="list-style-type: none"> Operate pressure washer in a well ventilated area. Avoid enclosed areas such as garages, basements, etc. Never operate unit in a location occupied by humans or animals. Use only cleaning fluids specifically recommended for high pressure washers. Follow manufacturers recommendations.
<p style="text-align: center;">⚠ WARNING</p> <p style="text-align: center;">RISK OF UNSAFE OPERATION</p> <div style="text-align: center;">  </div>	<ul style="list-style-type: none"> Unsafe operation of your pressure washer could lead to serious injury or death to you or others. The spray gun/wand is a powerful cleaning tool that could look like a toy to a child. Reactive force of spray will cause gun/wand to move, and could cause the operator to slip or fall, or misdirect the spray. Improper control of gun/wand can result in injuries to self and others. 	<ul style="list-style-type: none"> Become familiar with the operation and controls of the pressure washer. Keep children away from the pressure washer at all times. Never defeat the safety features of this product. Do not operate machine with missing, broken, or unauthorized parts. Never leave wand unattended while unit is running. Keep work area free of obstacles. Stand on a stable surface and grip gun/wand firmly. Expect the gun to kick when triggered.

IMPORTANT SAFETY INSTRUCTIONS (cont'd)

HAZARD	WHAT CAN HAPPEN	HOW TO PREVENT IT
<p>⚠ WARNING</p> <p>RISK OF INJURY FROM SPRAY</p> 	<ul style="list-style-type: none"> • High velocity fluid spray can cause objects to break, propelling particles at high speed. • Light or unsecured objects can become hazardous projectiles. 	<ul style="list-style-type: none"> • Always wear ANSI approved Z87 safety glasses. Wear protective clothing to protect against accidental spraying. • Never point wand at, or spray people or animals. • Always secure trigger lock when wand is not in service to prevent accidental operation. • Never permanently secure trigger in pull back (open) position.
<p>⚠ WARNING</p> <p>RISK OF ELECTRICAL SHOCK</p> 	<ul style="list-style-type: none"> • Spray directed at electrical outlets or switches, or objects connected to an electrical circuit, could result in a fatal electrical shock. 	<ul style="list-style-type: none"> • Unplug any electrically operated product before attempting to clean it. Direct spray away from electric outlets and switches.
<p>⚠ WARNING</p> <p>RISK TO FLUID INJECTION</p> 	<ul style="list-style-type: none"> • Your washer operates at fluid pressures and velocities high enough to penetrate human and animal flesh, which could result in amputation or other serious injury. Leaks caused by loose fittings or worn or damaged hoses can result in injection injuries. DO NOT TREAT FLUID INJECTION AS A SIMPLE CUT! See a physician immediately! • Relieve system pressure before attempting maintenance or disassembly of equipment. 	<ul style="list-style-type: none"> • Never place hands in front of nozzle. • Direct spray away from self and others. • Make sure hose and fittings are tightened and in good condition. Never hold onto the hose or fittings during operation. • Do not allow hose to contact muffler. • Never attach or remove wand or hose fittings while system is pressurized. • Use only hose and high pressure accessories rated for 2000 PSI service. • To relieve system pressure, shut off engine, turn off water supply, and pull gun trigger until water stops flowing.
<p>⚠ WARNING</p> <p>RISK OF CHEMICAL BURN</p> 	<ul style="list-style-type: none"> • Use of acids, toxic or corrosive chemicals, poisons, insecticides, or any kind of flammable solvent with this product could result in serious injury or death. 	<ul style="list-style-type: none"> • Do not use acids, gasoline, kerosene, or any other flammable materials in this product. Use only household detergents, cleaners and degreasers recommended for use in pressure washers. • Wear protective clothing to protect eyes and skin from contact with sprayed materials.
<p>⚠ WARNING</p> <p>RISK OF HOT SURFACES</p> 	<ul style="list-style-type: none"> • Contact with hot surfaces, such as engines exhaust components, could result in serious burn. 	<ul style="list-style-type: none"> • During operation, touch only the control surfaces of the pressure washer. Keep children away from the pressure washer at all times. They may not be able to recognize the hazards of this product.

GLOSSARY

PSI: Unit of measure, pounds per square inch.

FLOW RATE: This is the amount of water that passes through your wand. (Usually measured in G.P.M., gallons per minute).

PRESSURE WASHER PUMP: Delivers high water pressure. Pressure washer pump is shipped with oil. No oil should be added to this pump.

Engine: Gasoline powered engine drives pump. Engine is shipped with oil. See Manufacturer's Owner's Manual for oil recommendations.

⚠ CAUTION

Operating unit with water supply shut-off without flow of water will result in equipment damage.

BYPASS MODE: This pertains to the time that the pressure washer is running without the trigger on the gun engaged to spray. You should never run this pressure washer for more than 2 minutes without pulling the trigger to allow cool water to enter the pump and the heated (recirculated) water to exit. Running the pressure washer with water supply shut-off would void your warranty.

⚠ CAUTION

THE POWERFUL SPRAY FROM YOUR PRESSURE WASHER IS CAPABLE OF CAUSING DAMAGE TO FRAGILE SURFACES SUCH AS; WOOD, GLASS, AUTOMOBILE PAINT, AUTO STRIPPING AND TRIM, AND DELICATE OBJECTS SUCH AS FLOWERS AND SHRUBS. BEFORE SPRAYING, CHECK THE ITEM TO BE CLEANED TO ASSURE YOURSELF THAT IT IS ROBUST ENOUGH TO RESIST DAMAGE FROM THE FORCE OF THE SPRAY. AVOID THE USE OF THE CONCENTRATED SPRAY STREAM EXCEPT FOR VERY STRONG SURFACES LIKE CONCRETE AND STEEL.

OPERATING UNIT WITH WATER SUPPLY SHUT-OFF WITHOUT FLOW OF WATER WILL RESULT IN EQUIPMENT DAMAGE. YOU SHOULD NEVER RUN THIS PRESSURE WASHER FOR MORE THAN 2 MINUTES WITHOUT PULLING THE TRIGGER TO ALLOW COOL WATER TO ENTER THE PUMP AND THE HEATED (RECIRCULATED) WATER TO EXIT. RUNNING THE PRESSURE WASHER WITH WATER SUPPLY SHUT-OFF WOULD VOID YOUR WARRANTY.

OPERATING INSTRUCTIONS

Quick Reference Guide

Everything Below is Detailed
in this Manual — Please See
Reference Pages Noted Below

STEP 1 ASSEMBLY INSTRUCTIONS

(Reference Below Right)

- Connect Handle to Frame
- Connect Wand to Gun
- Attach High Pressure Hose
- Attach Water Source (Garden Hose)

STEP 2 PRESTART INSTRUCTIONS

(Reference Page 5)

- Fill Gas Tank
- Check Engine Oil
- Turn Water Source On
- Check for Leaks

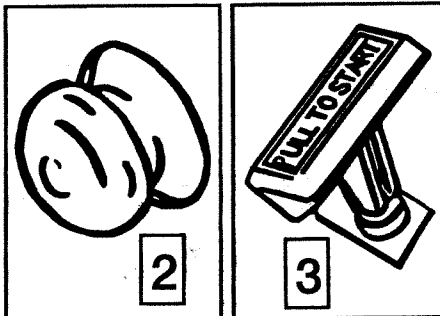
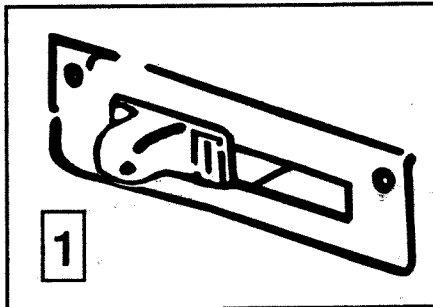

STEP 3 STARTING INSTRUCTIONS

(Reference Page 5)

- 1 SLIDETHROTTLECONTROL
TORUN POSITION
- 2 PUSH PRIMER BULB 3 TIMES-WAIT
2 SECONDS BETWEEN EACH PUSH
- 3 PULL START
(NOTE: If engine doesn't
start right away, trigger
gun to depressurize the unit)

HELPLINE:

1-800-488-1222

BOX CONTENTS

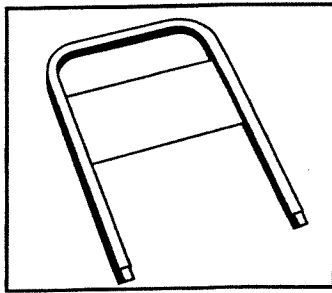

Handle

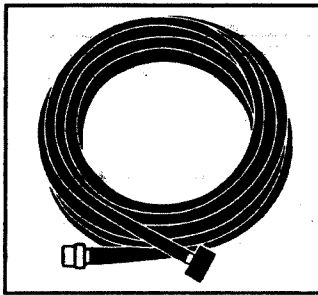

Hose

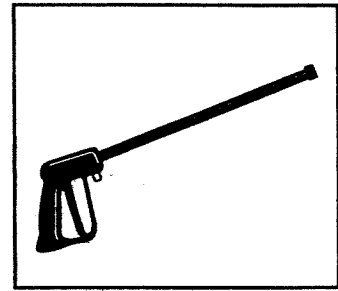

Gun

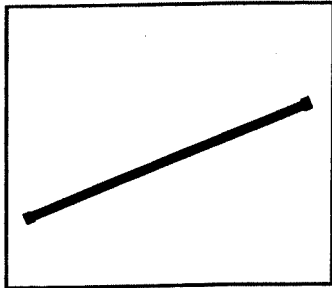

Wand/Nozzle

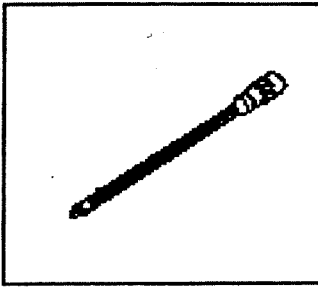

Wand, Rotary

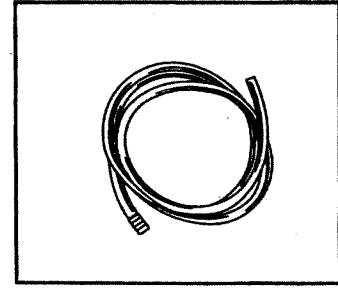

Chemical Hose

ASSEMBLY INSTRUCTIONS

STEP #1

**Connect Handle
to Frame**

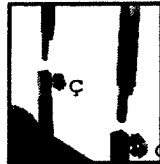

Tighten
Knob
by Turning

STEP #2

**Connect Wand
to Gun**



Turn
Knob
Clock-
wise

STEP #3

**Attach High
Pressure
Hose**

Attach High Pressure
Hose Twist Connect to
the Discharge Fitting
on the Machine.

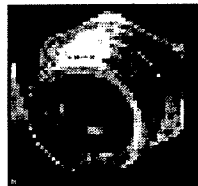

Discharge Fitting

STEP #4

**Attach Water
Source
(Garden Hose)**



Front View
Garden
Hose
Connection

PRESTART INSTRUCTIONS

STEP #1

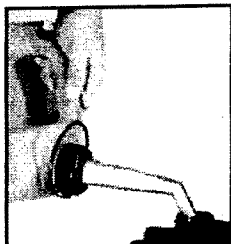

Fill Gas Tank

Use Gasoline Only!
DO NOT Use
2 Cycle
(Gasoline and Oil Mix)

STEP #2

Check Engine Oil

Engine Uses
30 Weight —
Detergent Oil

- Be sure the engine is in a level position.
- Remove the oil filler cap.
- To check oil level, check to ensure oil is to full mark on the dipstick.
- If the level is low, add oil to the full mark with 30 weight detergent oil.
- Reinstall the oil filler cap/dipstick.

STEP #3



Turn Water Source On

STEP #4

Check for Leaks



*Leaking from Water Inlet Source
 Does Not Affect Performance*

**If leaks are present tighten fittings
 and check or replace o-rings**

IMPORTANT: Running the engine with a low oil level can cause engine damage.

STARTING INSTRUCTIONS

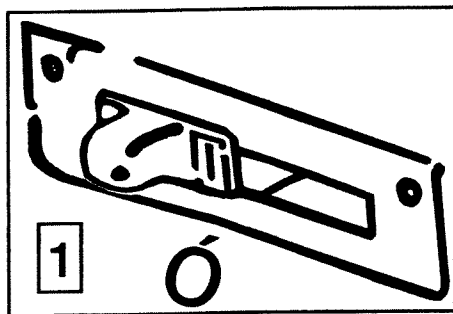

1 SLIDE THROTTLE CONTROL TO RUN POSITION

2 PUSH PRIMER BULB 3 TIMES-WAIT 2 SECOND BETWEEN EACH PUSH

3 PULL START
(NOTE: If engine doesn't start right away, trigger gun to depressurize the unit)

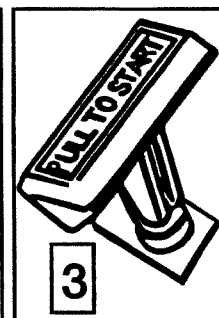

DO NOT Leave the Trigger Disengaged with the Engine Running For More than Two (2) Minutes, This Can Cause Serious Damage to Your Pump.

If engine will not restart after use, release the pressure build up by depressing the trigger gun

SPECIFICATIONS:

Model 919.762000

- Operating Pressure 2000 PSI • Gallons Per Minute — 2 GPM
- Engine: 6.0 HP Craftsman • Pump: Wobble Plate Oil Bath
- Chemical Injection - Under L
- Hose: 1/4" x 25' • Gun: Trigger Control
- Wheels: Two 8" Semi-Pneumatic

HIGH PRESSURE INSTRUCTIONS

*Push Nozzle Forward
for Low Pressure*

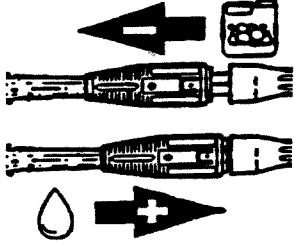

*Pull Back Nozzle
for High Pressure*

**OPEN (3/8" GAP)
to Draw Chemical**

***This Pressure
Washer is Preset at
the Factory to
Achieve Maximum
Pressure at Full
Throttle***

**CLOSED (1/8" GAP)
for High Pressure**

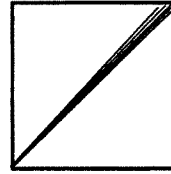

**0° Degree Narrow
Spray Pattern Greatest
Cleaning Impact Turn
Counterclockwise**

**60° Degree Wide
Spray Pattern Great-
est Cleaning Coverage
Turn Clockwise**

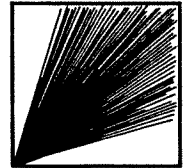

1. The power washer spray pattern may be adjusted by rotating the nozzle head, clockwise or counterclockwise.
2. For the narrowest spray pattern (greatest cleaning impact), rotate nozzle head counterclockwise.
3. For widest spray pattern (greatest cleaning coverage), rotate nozzle head clockwise.

USING SOAP/CHEMICALS

Excessive soap concentration does not necessarily improve cleaning power.



NOTE: Follow chemical manufacturer's label & safety directions!

For chemical recommendations specific to your application, contact your local janitorial supply or chemical manufacturer.

Use EX-CELL 5000 (Formulated for EX-CELL Pressure Washers) Or Contact Your Local Janitorial or Chemical Supplier for Recommendations for Your Specific Application.

NOZZLE CLEANING

1. Remove wand from gun by unscrewing at coupler.
2. Open the adjustable nozzle at the end of the wand to the 0 position by turning counterclockwise. (See Diagram 1). This will allow maximum accessibility to clean the nozzle. Be careful not to damage metal spray fins.
3. Insert the nozzle cleaning wire or straightened paper clip into the nozzle orifice. Move gently in and out to clear blockage from nozzle. (See Diagram 2).
4. Flush water through the nozzle backwards with garden hose.
5. Reattach wand to gun.

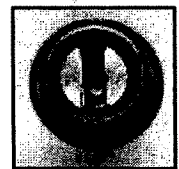

**Diagram 1
Nozzle Fins Open**

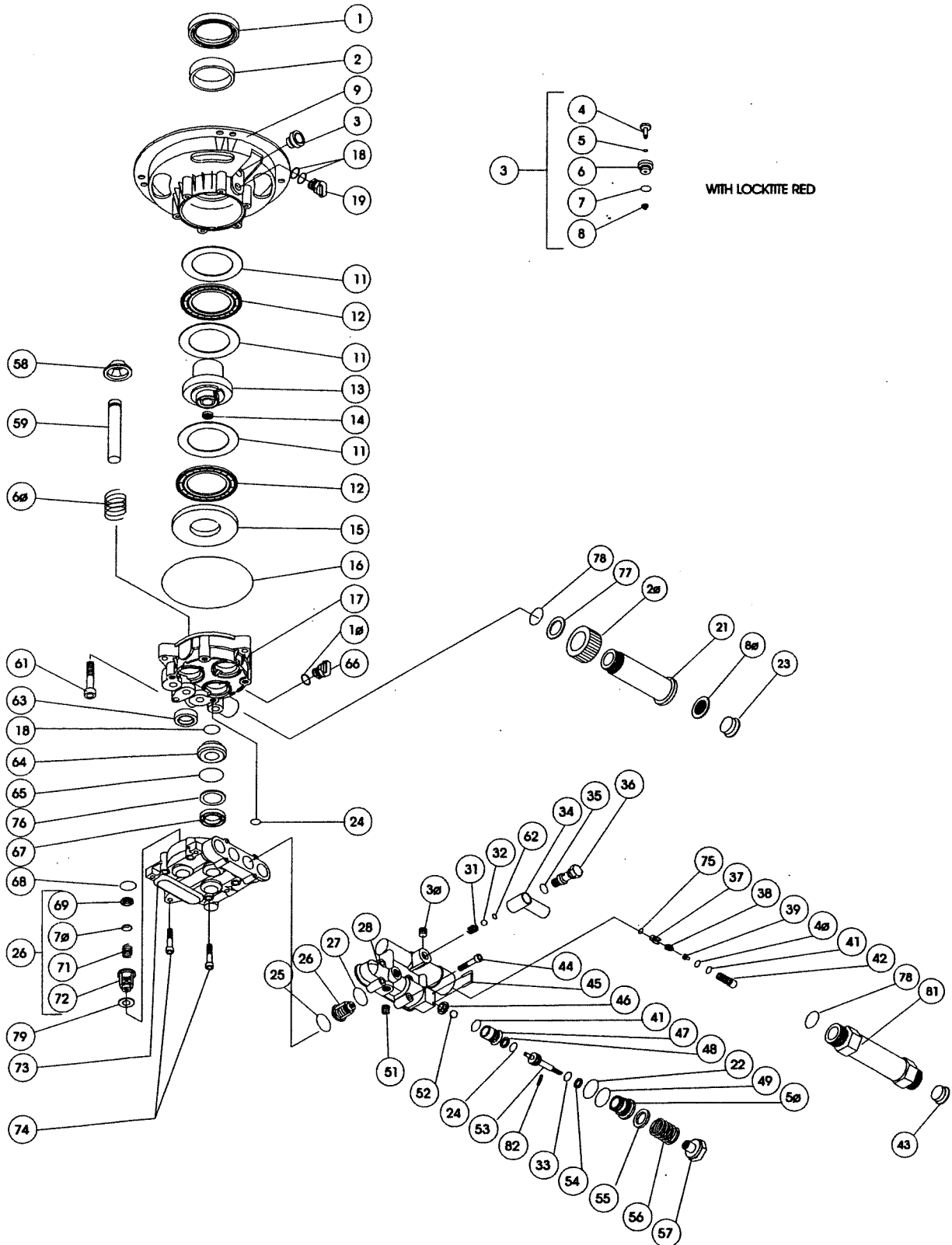

**Diagram 2
Insert Cleaning Tool**

TROUBLE SHOOTING

SYMPTOM	CAUSE	SOLUTION
Engine won't start	Engine throttle is in "OFF" Position Primer bulb hasn't been pushed Pressure build up after initial use	Slide throttle to "Run" position. Push primer bulb 3 times, waiting 2 seconds between pushes. Depress trigger gun
Won't Draw Chemical	Nozzle not in chemical draw position Chemical screen is obstructed Chemical screen not working Chemical injector orifice obstructed or stuck	Push nozzle forward at end of wand. Check chemical screen, clean of obstructed. Make sure chemical screen is submerged in chemical/water Check and clean
Pump running normally but pressure does not achieve rated values.	Water supply restricted Nozzle is in low PSI position Nozzle incorrect or worn Pump sucking air Nozzle blocked	Check water supply and filter screen for blockage. Check hoses for blockage, kinks, leaks, etc.. Pull nozzle at end of wand back to the high pressure position. Check and replace. Check that hoses and fitting are air tight. Clean nozzle.
Fluctuating Pressure	Pump sucking air Garden hose inlet strainer clogged Worn Seals or Packing. Inadequate water supply. Fouled or dirty inlet or discharge valves. Leaky discharge hose.	Check that hoses and fittings are air tight. Purge air from garden hose. Clean. Check filter frequently. Check and replace Check flow available to pump. Check for excessive heat 145° F Clean inlet and discharge valve assemblies. Replace if damaged.
Pressure drops after period of normal use	Nozzle clogged, partially obstructed Nozzle worn Valves worn, dirty or stuck Worn piston packing	Clean or replace. Check and replace. Check, clean or replace. Check and replace.
Pump noisy	Water too hot Pump sucking air Valves dirty or worn Worn bearings	Reduce temperature below 63° C or 145° F. Check that hoses and fittings are air tight. Check, clean or replace. Check and replace if necessary.
Presence of water in oil (Oil milky) Water dripping from pump	High humidity Piston packing and oil seal worn	Change Oil. Check and replace oil seals.
Water dripping from pump	Fittings Loose O-rings of piston guide or retainer worn Piston packing worn	Tighten Check and replace. Check and replace.
Oil Dripping	Oil seal worn Loose drain plug or worn drain plug o-ring.	Check and replace Tighten drain plug or replace O-ring. Do not over torque.

PUMP BREAKDOWN



SERVICE KITS

<u>KEY #</u>	<u>DESCRIPTION</u>	<u>REF.</u>	<u>COMPONENTS</u>	<u>KEY #</u>	<u>DESCRIPTION</u>	<u>REF.</u>	<u>COMPONENTS</u>
16286	OIL SEAL KIT	3	VENTED VALVE	16309	UNLOADERSTEM	22	O-RING [2050]
		10	O-RING [117]			24	O-RING [108]
		16	O-RING [80]			33	O-RING [2025]
		18	O-RING [114]			48	BACK-RING FOR O-RING [108]
		19	OIL SIGHT GLASS			49	O-RING [2056]
		63	OIL SEAL			50	BY-PAS VALVE BODY
		69	OIL FILL CAP			53	BY-PAS PISTON
16287	PLUNGERKIT	58	RING	54	BACK-RING FOR O-RING [2025]	55	SPACER
		59	PISTON	56	PRESSUREREG. SCREW	57	PRESSUREREG. NUT
		60	SPRING	82	PIN		
16288	WOBBLE PLATE/ BEARING KIT	11	BEARING DISC	16310	MANIFOLD ASSEMBLY	22	O-RING [2050]
		12	NEEDLE BEARING			24	O-RING [108]
		13	WOBBLE PLATE			27	O-RING [15X2]
		14	CAP			28	MANIFOLD
		15	BEARING DISC			30	SCREW
16289	INLET EXTENSION KIT	20	CONNECTIONRING NUT	31	CHEMICAL SPRING	32	BALL STAINLESS STEEL
		21	INLET EXTENSION	33	O-RING [2025]	34	CHEMICAL DOSING BODY
		23	UNDER CAP	35	O-RING [2031]	36	CHEMICAL DOSING SCREW
		77	WASHER	37	NO RETURN VALVE	38	SPRING
		78	O-RING [140]	39	INJECTOR NOZZLE	40	O-RING [8X2]
		80	GASKET W/FILTER	41	O-RING [2037]	42	INJECTION NIPPLE
16290	OUTLET EXTENSION KIT	43	UNDER PLUG	44	SCREW TCEL [M5X30 12K]	45	BY PASS PIN
		78	O-RING [14X2]	46	VALVE SEAT PLATE	47	VALVE SEA
		81	OUTLET EXTENSION	48	BACK-RING [FOR O-RING 108]	49	O-RING [2056]
16304	PACKING KIT	65	O-RING [2093]	50	BY-PASS VALVE BODY	51	PLUG
		67	O-RING	52	BALL STAINLESS STEEL	53	BY-PAS PISTON
		76	O-RING [22X14X1,5]	54	BACK-RING [FOR O-RING 2025]	55	SPACER
16305	VALVE KIT	25	O-RING [2050]	56	PRESSUREREG. SCREW	57	PRESSUREREG. NUT
		26	VALVE	62	O-RING [2015]	75	O-RING [5X2]
		68	O-RING [12X2]	82	PIN [M2X10]		
		79	WASHER				
16306	UNLOADER CHECK	37	NO RETURN VALVE	16302	HEAD, BRASS PUMP	73	
		38	SPRING	16311	MANIFOLD	28	
		39	INJECTOR NOZZLE	15955	COMPLETE PUMP ASSY.		
		40	O-RING [8X2]				
		41	O-RING [2037]				
		42	INJECTION NIPPLE				
		75	O-RING [5X2]				
16307	INJECTOR REPAIR	31	CHEMICAL SPRING				
		32	BALL STAINLESS STEEL				
		35	O-RING [2031]				
16308	UNLOADER SET	62	O-RING [2015]				
		46	VALVE SEAT PLATE				
		47	VALVE SEAT				
		52	BALL STAINLESS STEEL				
		41	O-RING [2037]				

PRESSURE WASHER BREAKDOWN

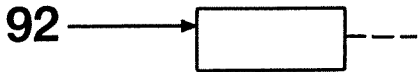
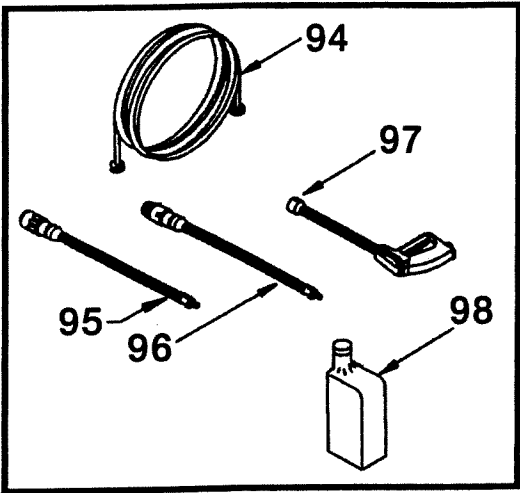

90 89

PARTS LIST

<u>KEY #</u>	<u>PART NUMBER</u>	<u>DESCRIPTION</u>
83	16272	Handle
84	C042	Knob, 5/16
85	15226	Tire, Semi, 8x13/4
86	W137	Nut, Pal, 1/2
87	16303	Label, Hot Surface
88	15223	Foot, 2x1
89	15231	Hose, Chemical
90	15972	Cap, 5/16
91	16273	Frame
92	16257	Label, Craftsman
93	AD187	Label, Warning
94	H040	Hose, 1/4x25 ft.
95	WA100	Wand, Rotary
96	15227	Lance, Multi-Reg.
97	H128	Gun, 1/4 Male
98	16270	Oil, 27 oz., 30 Wt.
	<u>Not Illustrated</u>	
	16256	Owners Manual

SEARS

OWNERS MANUAL

**MODEL NO.
919.762000**

When requesting service or ordering parts, always provide the following information:

- Model Number
- Part Number
- Part Description
- Name of Item

FULL ONE YEAR WARRANTY AIR COMPRESSOR

If this air compressor fails due to a defect in material or workmanship within one year from the date of purchase, RETURN IT TO THE NEAREST SEARS REPAIR CENTER THROUGHOUT THE UNITED STATES AND SEARS WILL REPAIR IT, FREE OF CHARGE.

If this air compressor is used for commercial or rental purposes, the warranty will apply for ninety days from the date of purchase.

This warranty gives you specific legal rights and you may have other rights which vary from state to state.

CRAFTSMAN. 6HP 2000 PSI 2 GPM HIGH PRESSURE POWER WASHER

For the repair or replacement parts you need

Call 7 am - 7 pm, 7 days a week

1-800-366-PART

(1-800-366-7278)



For in-home major brand repair service

Call 24 hours a day, 7 days a week

1-800-4-REPAIR

(1-800-473-7247)



For the location of a

Sears Parts and Repair Center in your area

Call 24 hours a day, 7 days a week

1-800-488-1222



For information on purchasing a Sears
Maintenance Agreement or to inquire

about an existing Agreement

call 9 am - 5 pm, Monday-Saturday

1-800-827-6655



SEARS
REPAIR SERVICES
America's Repair Specialists

Sears, Roebuck and Co., Hoffman Estates, IL 60179 U.S.A.