

Operator's Manual



5 Amp Motor
14 Inch Cutting Path / 0.065 In. Line
ELECTRIC WEEDWACKER®

Model No.
358.745460

- **Safety**
- **Assembly**
- **Operation**
- **Maintenance**
- **Español, p. 16**

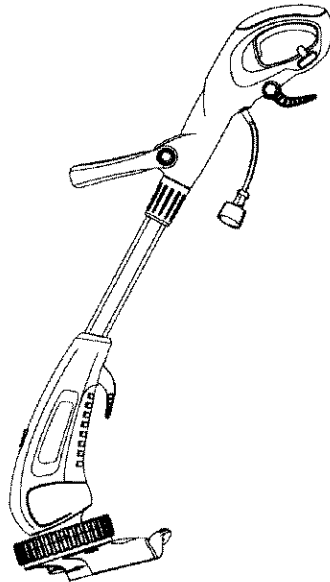

WARNING:

Read and follow all Safety Rules and Operating Instructions before first use of this product.



For answers to your questions about this product:
Call 7 am-7 pm, Mon-Sat; Sun, 10 am-7 pm

1-800-235-5878 (Hours listed are Central Time)

Sears, Roebuck and Co., Hoffman Estates, IL 60179 U.S.A.

545123834 Rev. 1 11/1/07 BRW

TABLE OF CONTENTS

Warranty Statement	2	Service & Adjustments	13
Identification of Safety Symbols	2	Parts Available	14
Safety Rules	4	Storage	14
Assembly	6	Troubleshooting Table	15
Operation	9	Spanish	16
Maintenance	12	Parts Ordering	Back Cover

LIMITED WARRANTY STATEMENT

ONE YEAR FULL WARRANTY ON CRAFTSMAN ELECTRIC WEEDWACKER® LINE TRIMMER

When used and maintained according to the operator's manual, if this product fails due to a defect in material or workmanship within one year from the date of purchase, return it to any Sears store or other Craftsman outlet in the United States for free replacement.

This warranty does not include the nylon line, which is an expendable part.

This warranty applies for only 30 days from purchase date if this product is used for commercial or rental purposes.

This warranty gives you specific legal rights, and you may also have other rights which vary from state to state.

Sears, Roebuck and Co., Hoffman Estates, IL 60179

IDENTIFICATION OF SAFETY SYMBOLS

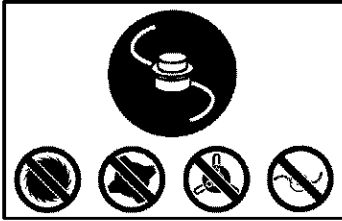

⚠ DANGER: Use only specified trimmer head, spool, and 0.065 inch (1.65 mm) recommended trimmer line. Never use blades, flailing devices, wire, rope, string, etc. Unit is designed for line trimmer use only. Failure to follow these instructions may result in serious injury.



⚠ WARNING: This unit can be dangerous! Careless or improper use can cause serious injury.

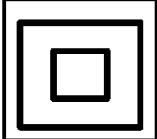

⚠ WARNING: This unit is double insulated. Failure to have the unit repaired by qualified service personnel can cause the double insulation construction to become ineffective and result in serious injury.



Read the operator's manual before use. Failure to follow instructions could result in serious injury. Save operator's manual.

IDENTIFICATION OF SAFETY SYMBOLS



To reduce the risk of electric shock, do not expose unit to water. Do not operate unit on wet ground or in rain.



Trimmer line can throw objects violently. You can be blinded or injured. Always wear hearing protection and safety glasses marked Z87. Always wear heavy, long pants, long sleeves, boots and gloves.

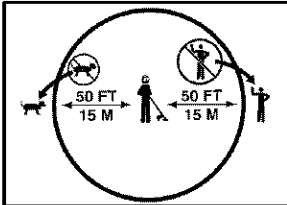

Hazard zone for thrown objects.

- Trimmer line throws objects violently.
- You and others can be blinded/injured.
- Keep children, bystanders, and animals 50 feet (15 meters) away.



Secure hair above shoulder length. Do not wear jewelry, loose clothing or clothing with loosing hanging straps, ties, tassels, etc. They can be caught in moving parts.



This unit is double insulated. All internal service must be completed by an authorized service dealer. Disconnect unit from power source before cleaning or servicing.

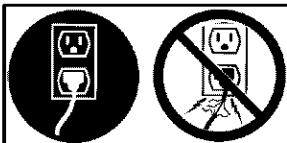

Do not use with damaged cord. Repair or replace damaged cord immediately.

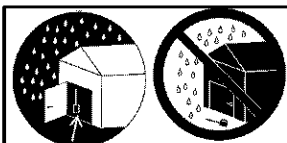

Store unit indoors in a high, dry place out of the reach of children. Store unit unplugged.



This unit is for household use only and not for commercial use.

IDENTIFICATION OF SAFETY SYMBOLS

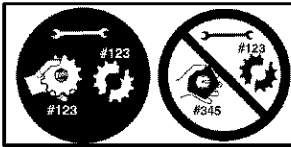

When servicing unit, use only identical replacement parts.

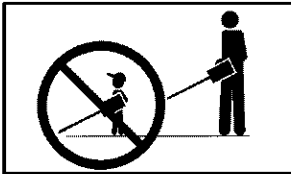

Never allow children to operate this unit.

SAFETY RULES

⚠ WARNING: When using electric gardening appliances, basic safety precautions must always be followed to reduce the risk of fire, electric shock, and serious injury. Read and follow all instructions.



SAFETY INFORMATION
ON THE UNIT

This power unit can be dangerous!
Operator is responsible for following the warnings and instructions in this manual and on the unit. Read entire operator's manual before using unit! Be thoroughly familiar with the controls and the proper use of the unit. Restrict the use of this unit to persons who read, understand, and follow unit and manual warnings and instructions. Never allow children to operate this unit. Close attention is necessary when used near children.

⚠ DANGER: Never use blades or flailing devices. Unit is designed for line trimmer use only. Use of any other accessories or attachments will increase the risk of injury.



⚠ WARNING: Trimmer line throws objects violently. You and others can be blinded/injured. Wear safety glasses, boots, and leg protection. Keep body parts clear of rotating line. Keep children, bystanders, and ani-

mals 50 feet (15 meters) away. If approached stop unit immediately. If situations occur which are not covered in this manual, use care and good judgement. If you need assistance, call 1-800-235-5878.

OPERATOR SAFETY

- Dress properly. Always wear safety glasses or similar eye protection when operating, or performing maintenance on your unit. (Safety glasses are available.) Always wear face or dust mask if operation is dusty. Always wear heavy, long pants, long sleeves, boots, and gloves. Do not go barefoot or wear sandals.
- Secure hair above shoulder length. Secure or remove loose clothing and jewelry or clothing with loosely hanging ties, straps, tassels, etc. They can be caught in moving parts.
- Being fully covered also helps protect you from debris and pieces of toxic plants thrown by spinning line.
- Stay alert. Do not operate unit when you are tired, ill, upset or under influence of alcohol, drugs, or medication. Watch what you are doing; use common sense.
- Avoid unintentional starting of the unit. Never carry unit with your finger on the switch. Be sure the switch is in the OFF position and never touch the switch when connecting extension cord.

ELECTRICAL SAFETY

⚠ WARNING: Avoid a dangerous environment. To reduce the risk of electrical shock, do not use in rain, in

damp or wet locations, or around swimming pools, hot tubs, etc. Do not expose to snow, rain, or water to avoid the possibility of electrical shock.

- Use a voltage supply as shown on unit.
- Avoid dangerous situations. Do not use in the presence of flammable liquids or gases to avoid creating a fire or explosion and/or causing damage to unit.
- To reduce the risk of electrical shock, this equipment has a polarized plug (one blade is wider than the other) and will require the use of a polarized extension cord. The appliance plug will fit into a polarized extension cord only one way. If the plug does not fit fully into the extension cord, reverse the plug. If the plug still does not fit, obtain a correct polarized extension cord. A polarized extension cord will require the use of a polarized wall outlet. This plug will fit into the polarized wall outlet only one way. If plug does not fit fully into the wall outlet, reverse the plug. If it still does not fit, contact a qualified electrician to install the proper wall outlet. Do not change the equipment plug, extension cord receptacle, or extension cord plug in any way.
- To reduce risk of electrical shock, use extension cords specifically marked as suitable for outdoor appliances having electrical rating not less than the rating of unit. Cord must be marked with suffix "W-A" (in Canada "W"). Make sure your extension cord is in good condition. Inspect extension cord before use and replace if damaged. Do not use a damaged cord. Cord insulation must be intact with no cracks or deterioration. Plug connectors must be undamaged. An undersized extension cord will cause a drop in line voltage resulting in loss of power and overheating. If in doubt, use the next heavier gauge. The lower the gauge number, the heavier the cord (see SELECT AN EXTENSION CORD in the OPERATION section).
- Do not use multiple cords.
- Do not abuse cord. Never carry the unit by the extension cord or yank extension cord to disconnect unit.
- Use cord retainer to prevent disconnection of extension cord from unit and possible damage to the unit due to plug movement (see ATTACH THE EXTENSION CORD TO YOUR TRIMMER in the OPERATION section).

- Do not use the unit if the switch does not turn the unit on and off properly. Repairs to the switch must be made by your authorized service dealer.
- Keep the extension cord clear of operator and obstacles at all times. Do not expose cords to heat, oil, water, or sharp edges.
- To avoid the possibility of electric shock, avoid body contact with any grounded conductor, such as metal fences or pipes.
- Ground Fault Circuit Interrupter (GFCI) protection should be provided on circuit or outlet to be used. Receptacles are available having built-in GFCI protection and may be used for this measure of safety.

UNIT SAFETY

- Inspect unit before use. Replace damaged parts. Make sure all handles, guards, and fasteners are in place and securely fastened. Parts that are damaged must be repaired or replaced by an authorized service dealer. These include head parts that are cracked, or chipped, guards, and any other part that is damaged.
- Do not repair unit yourself.
- Use only 0.065 inch (1.65 mm) diameter recommended trimmer line (see USER REPLACEABLE SERVICE PARTS in the SERVICE AND ADJUSTMENTS section). Never use wire, rope, string, etc.
- Use specified trimmer spool. Make sure spool is properly installed and all parts are securely fastened.
- When servicing unit, use only Craftsman identical replacement parts and accessories as recommended.

CUTTING SAFETY

 **WARNING:** Inspect area to be cut. Remove objects (rocks, broken glass, nails, wire, string, etc.) which can be thrown or become entangled in cutting head.

- Do not overreach or stand on unstable support. Keep firm footing and balance.
- Keep the cutting head below waist level. Do not raise handles above your waist. Cutting head can come dangerously close to your body.
- Keep away from cutting head and spinning line.
- Use unit properly. Use only for trimming, scalping, and mowing. Do not force unit. It will do the job better and with less risk of injury at the rate for which it was designed.

- Use only in daylight or in good artificial light.

MAINTENANCE SAFETY

⚠ WARNING: Disconnect unit from the power supply before performing maintenance, or when changing trimmer line.

- Maintain unit according to recommended procedures. Keep cutting line at proper length. Follow instructions for changing trimmer line.
- Have all service and maintenance not explained in this manual performed by an authorized service dealer to avoid creating a hazard.
- Never douse or squirt the unit with water or any other liquid. Clean unit and labels with a damp sponge. Keep handles dry, clean, and free from oil and grease.
- Keep the air vents clean and free of debris to avoid overheating the motor. Clean after each use.

TRANSPORTING AND STORAGE

- Stop the unit and disconnect the power source when not in use.
- Carry the unit with motor stopped.
- Store unit indoors in a high, dry place out of the reach of children. Store unit unplugged.
- Do not hang unit so that the trigger switch is depressed.

DOUBLE INSULATION CONSTRUCTION

This unit is double insulated to help protect against electric shock. Double insulation construction consists of two separate “layers” of electrical insulation instead of grounding. Tools built with this insulation system are not intended to be grounded. No grounding means is provided on this unit, nor should a means of grounding be added to this unit. As a result, the extension cord used with your unit can be plugged into any standard 120 volt electrical outlet. Safety precautions must be observed when operating any electrical tool. The double insulation system only provides added protection against injury resulting from an internal electrical insulation failure.

⚠ WARNING: All electrical repairs to this unit, including housing, switch, motor, wires, etc., must be diagnosed and repaired by qualified service personnel. Replacement parts for a double insulated appliance must be recommended by the manufacturer. A double insulated appliance is marked with the words “double insulation” or “double insulated”. The symbol (square within a square) □ may also be marked on the appliance. Failure to have the unit repaired by qualified service personnel can cause the double insulation construction to become ineffective and result in serious injury.

SAVE THESE INSTRUCTIONS

ASSEMBLY

CARTON CONTENTS

Check carton contents against the following list.

Model 358.745460

- Trimmer
- Shield
- Assist handle
- Wheel

Examine parts for damage. Do not use damaged parts.

NOTE: If you need assistance or find parts missing or damaged, call 1-800-235-5878.

ASSEMBLY

⚠ WARNING: If received assembled, review all assembly steps to ensure your unit is properly assembled and all fasteners are secure.

SHAFT ASSEMBLY

⚠ WARNING: Ensure that the excess wire between the switch handle and motor housing is not twisted and is enclosed in switch handle and motor housing during assembly of the unit. Failure to do so may result in damage to the wires and/or the unit or serious injury to the operator including electrocution.

1. Push the tube into the switch handle until it snaps into place.

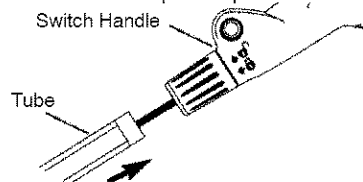

2. Push the tube into the motor housing until it snaps into place.

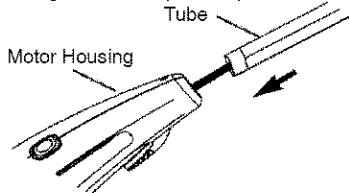

3. Try to remove tube from switch handle and motor housing. If the tube remains in place, it is properly snapped into place. If the tube will not remain in place, repeat steps 1 and 2. Push until the tube snaps into place.

ATTACHING THE SHIELD

⚠ WARNING: The shield must be properly installed. The shield provides partial protection from the risk of thrown objects to the operator and others. Your unit is equipped with a line limiter pin, which cuts excess line to the proper length while running.

NOTE: If shield is not properly installed, damage to unit (including motor failure) will result.

1. Place the shield onto the motor housing. Ensure the cutting head remains free to rotate and the line is not caught between the shield and the motor housing (see illustration).

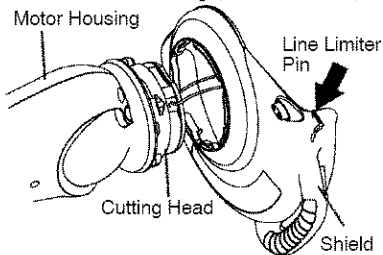

2. Align the installation arrow on the shield with the installation arrow on the motor housing as shown.

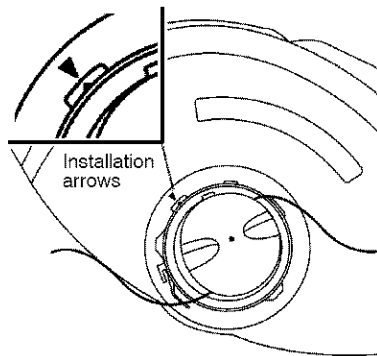

3. Twist the shield as illustrated until it snaps securely into place. Make sure the shield is assembled to the unit as shown in the illustration below and in the KNOW YOUR TRIMMER section of this manual.

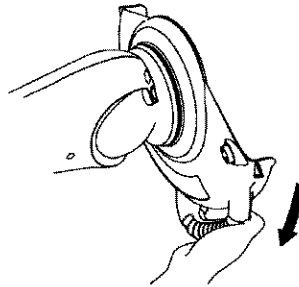

WHEEL ASSEMBLY

1. Fit the two halves of the wheel together (see illustration).

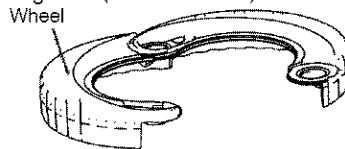

2. Attach the wheel to the trimmer. Make sure the wheel is fitted into the groove on the motor housing.

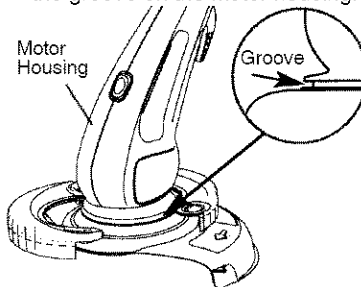

3. Clip the wheel together securely on the other side. The wheel should turn freely.

INSTALLATION OF ASSIST HANDLE

1. Press the two buttons on the sides of the switch handle.

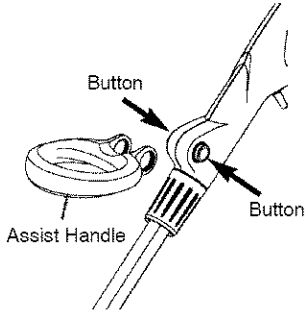

2. Push the assist handle over the buttons and release the buttons.
3. Adjust the handle to the most comfortable operating position by pressing the buttons and moving the handle.

HEIGHT ADJUSTMENT

1. Turn height adjuster in the direction indicated to unlock (see illustration).

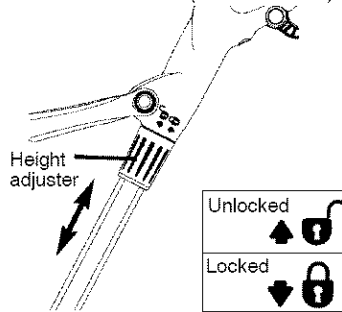

2. Adjust the length of the tube to the most comfortable operating position.
3. Turn height adjuster in the opposite direction to lock.

OPERATION

KNOW YOUR TRIMMER

READ THIS OPERATOR'S MANUAL AND SAFETY RULES BEFORE OPERATING YOUR UNIT. Compare the illustrations with your unit to familiarize yourself with the location of the various controls and adjustments. Save this manual for future reference.

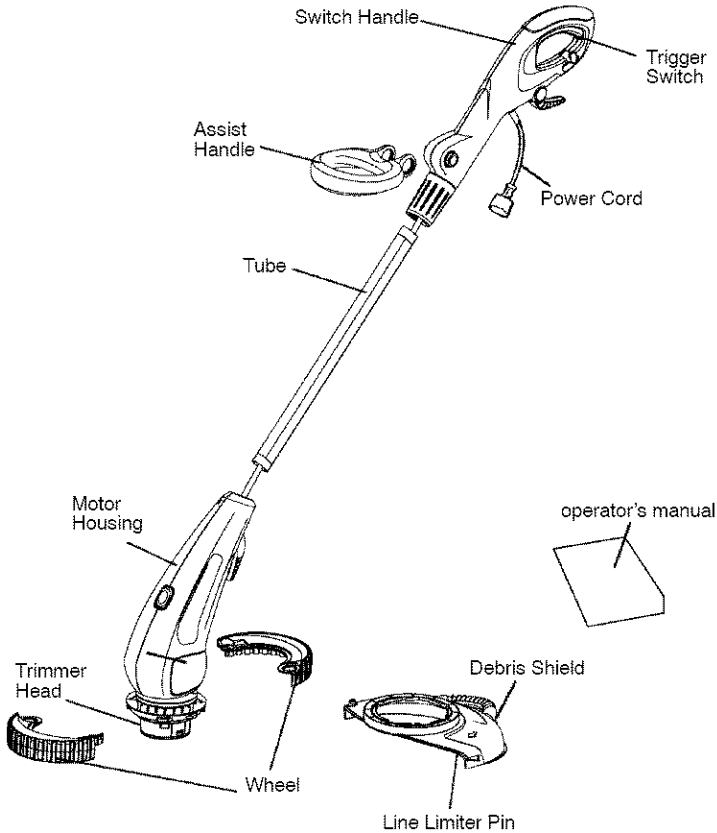

POWER CORD

The POWER CORD is where you attach your extension cord to the unit.

TRIGGER SWITCH

The TRIGGER SWITCH is used to turn on the unit. Squeeze the trigger switch to operate the unit. Release to stop.

LINE LIMITER PIN

LINE LIMITER PIN

The LINE LIMITER PIN cuts the cutting line to the proper cutting length.

TRIMMER HEAD

The TRIMMER HEAD holds cutting line and rotates during operation.

OPERATING INSTRUCTIONS

Use only a voltage supply as specified on your unit.

SELECT AN EXTENSION CORD

Extension Cord Gauge Chart	
Length of Cord	Gauge
25 Ft. (7.5 m)	18 Gauge
50 Ft. (15 m)	16 Gauge
100 Ft. (30 m)	16 Gauge

Extension cords are available for this unit at Sears.

ATTACH THE EXTENSION CORD TO YOUR TRIMMER

1. Form a loop in your extension cord.
2. Push the loop through the slot in the handle (see illustration).

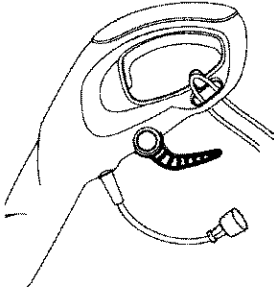

3. Position the loop over the cord retainer and pull back to secure.
4. Connect power cord of unit to extension cord.

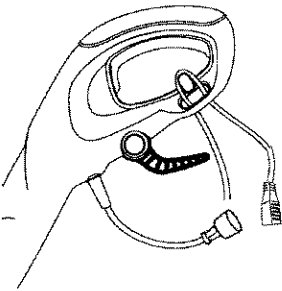

CORRECT OPERATING POSITION

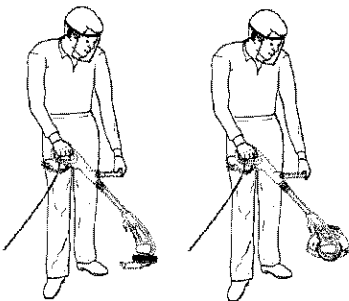

Trimming

Edging

⚠ WARNING: Always wear eye protection. Never lean over the trimmer head. Rocks or debris can ricochet or be thrown into eyes and face and cause blindness or other serious injury.

When operating unit, stand as shown and check for the following:

- Wear eye protection and heavy clothing.
- Hold trigger handle with right hand and assist handle with left hand.
- Keep unit below waist level.
- Cut only from your right to your left to ensure debris is thrown away from you. Without bending over, keep line near and parallel to the ground and not crowded into material being cut.

AUTOMATIC LINE FEED SYSTEM

When the trimmer is initially started, a small length of cutting line is fed out.

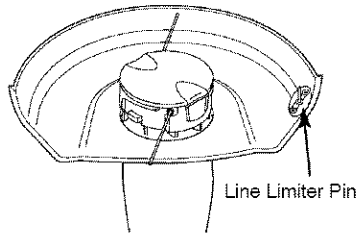

After approximately 5 seconds, the line will be cut to the correct length by the line limiter pin as the motor reaches full speed. **Make sure the motor is up to full speed before trimming.** If the noise of the cutting line being cut cannot be heard, more line will need to be fed out.

To feed more line:

- Allow the motor to stop completely; then, restart the motor and allow it to reach full speed.
- Repeat until you hear the line hitting against the line limiter pin (do not repeat this procedure more than 6 times).

If problems are experienced with the automatic line feed, refer to the TROUBLESHOOTING TABLE.

To manually feed the nylon line:

- If required, the cutting line can be fed out manually.
- To operate, press and release manual line feed button while gently pulling on one of the lines until the line reaches the line limiter pin.

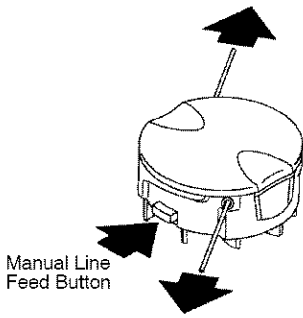

- When the required amount of line is fed out, gently pull on the second line (there is no need to press the manual line feed button again).
- If the line extends past the line limiter pin, too much line has been fed out. If too much line is fed out, remove the spool cap and click spool counterclockwise until the line is at the desired length.

To remove spool cap:

1. Press and hold in the two cap release latches.
2. Pull cap away from the hub.

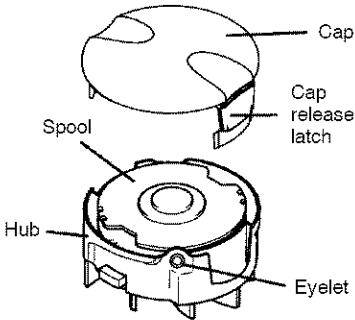

To reinstall spool cap:

1. Keep all areas of the cap and hub clean. Failure to do so may prevent the cap being securely located in the hub.
2. Replace the cap, pressing firmly down towards the hub to ensure cap is fully secured.
3. Check that the cap is secure by trying to remove it without pressing the two latches.

⚠ WARNING: Use only 0.065 inch (1.65 mm) diameter line. Other sizes of line will not advance properly and will result in improper cutting head function or can cause serious injury. Do not use other materials such as wire, string, rope, etc. Wire can break off during cutting and become a dangerous missile that can cause serious injury. See page 4 for warning concerning other cutting devices.

TRIMMING

Hold the bottom of the trimmer head about 3 inches (8 cm) above the ground and at an angle. Allow only the tip of the line to make contact. Do not force trimmer line into work area.

Trimming

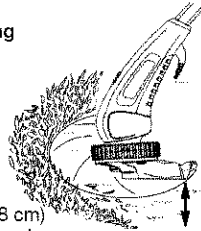

3 inches (8 cm) above ground

EDGING POSITION

You can twist the lower portion of the unit into an edging position. Press button and twist lower portion of unit as shown in the illustration until it snaps into place. To return to trimming position, press button and twist lower portion in opposite direction.

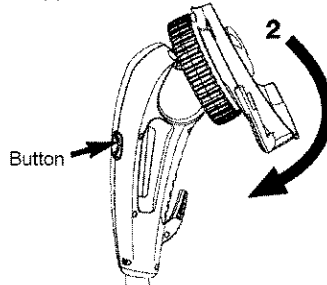

EDGING

While edging, allow unit to rest on wheel for extra stability. Edge in direction shown in illustration. Allow the tip of the line to make contact. Do not force the line. Take extra caution while edging as objects can be thrown from the trimmer line.

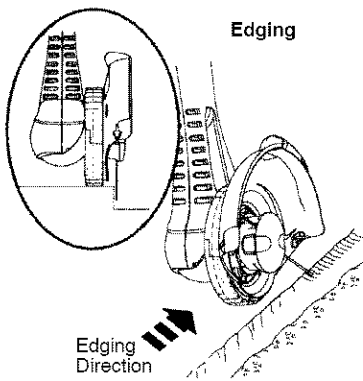

Edging

Edging Direction

SCALPING

The scalping technique removes unwanted vegetation down to the ground. Hold the bottom of the trimmer head about 3 inches (8 cm) above the ground and at an angle. Allow the tip of the line to strike the ground around trees, posts, monuments, etc. This technique increases line wear.

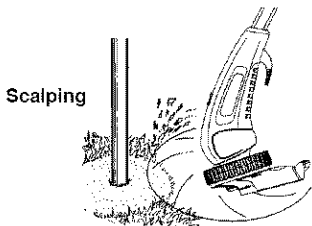

Scalping

MOWING

Your trimmer is ideal for mowing in places conventional lawn mowers cannot reach. In the mowing position, keep the line parallel to the ground. Avoid pressing the head into the ground as this can scalp the ground and damage the tool.

Mowing

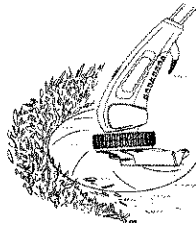

SWEEPING

The fanning action of the rotating line can be used for a quick and easy clean up. Keep the line parallel to and above the surfaces being swept and move the tool from side to side.

Sweeping

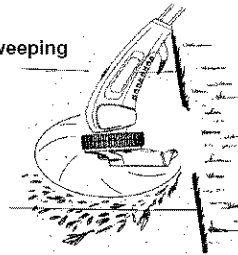

MAINTENANCE

CUSTOMER RESPONSIBILITIES

⚠ WARNING: Disconnect power source before performing maintenance.

CARE & MAINTENANCE TASK	WHEN TO PERFORM
Check for loose fasteners and parts	Before each use
Check for damaged or worn parts	Before each use
Inspect and clean unit and labels	After each use

GENERAL RECOMMENDATIONS

The warranty on this unit does not cover items that have been subjected to operator abuse or negligence. To receive full value from the warranty, the operator must maintain unit as instructed in this manual. Various adjustments will need to be made periodically to properly maintain your unit.

BEFORE EACH USE

CHECK FOR LOOSE FASTENERS AND PARTS

- Housing Screws
- Debris Shield

CHECK FOR DAMAGED OR WORN PARTS

Contact a Sears Service Center for replacement of damaged or worn parts.

- Trigger Switch - Ensure switch functions properly by pressing and releasing the trigger switch. Make sure motor stops.
- Debris Shield - Discontinue use of unit if debris shield is damaged.

**AFTER EACH USE
INSPECT AND CLEAN UNIT AND LABELS**

- After each use, inspect complete unit for loose or damaged parts. Never use a damaged trimmer.
- Clean the unit using a damp cloth with a mild detergent.
- Wipe off unit with a clean dry cloth.
- Use a soft brush to clean around the inside of the debris shield, the cutting head and the motor housing air vents.

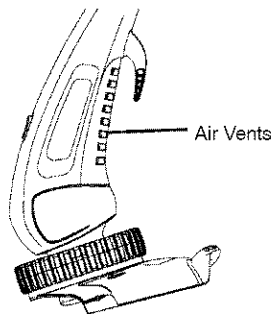

- Remove the wheel by pressing one of the buttons. Clean the wheel and groove on the motor housing with a soft brush. Reinstall wheel (see ASSEMBLY section).

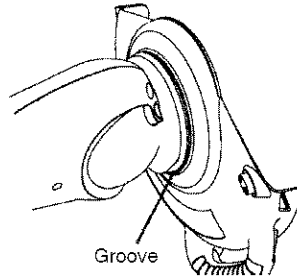
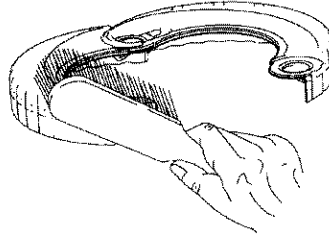
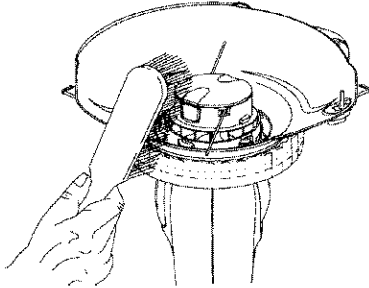

SERVICE AND ADJUSTMENTS

REPLACING THE LINE

- ⚠ WARNING:** Disconnect unit from power source before servicing.
1. Press and hold in the two cap release latches.
 2. Pull cap away from the hub.

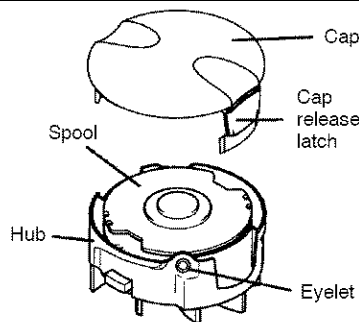

3. Remove old spool.
4. Clean entire surface of hub and spool.
5. Replace with a pre-wound spool or cut two lengths of 13 feet (4 meters) of 0.065" (1.65 mm) diameter Craftsman brand line. Use of heavier lines could overload and damage unit.

- ⚠ WARNING:** Never use wire, rope, string, etc., which can break off and become a dangerous missile.
6. Insert one end of the line about 1/2 inch (1 cm) into one of the small holes in the upper section of the inside of the spool.

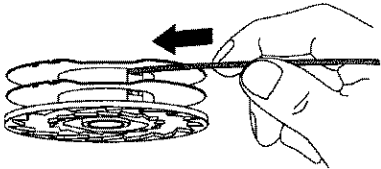

7. Wind the line evenly and tightly onto the spool. Wind in the direction of the arrow found on the spool.
8. Push the line into the notch, leaving 3 to 5 inches (7 - 12 cm) unwound.

9. Repeat on the lower section of the spool.

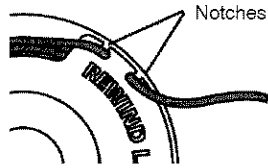

10. Place spool into hub with cut out area of spool in line with eyelets (see illustration).

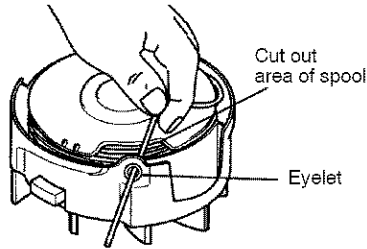

11. Remove one line from notch and feed line through eyelet. Repeat for second line.
12. Reinstall the spool cap.

USER REPLACEABLE SERVICE PARTS

REPLACEMENT PART	PART NUMBER
Spool with 0.065" Trimmer Line	71-85935
Spool Cap	545124417
Assist Handle	545124404
Wheel	545124405

STORAGE

- ⚠ WARNING:** Perform the following steps after each use.
- Stop the unit and disconnect the power source when not in use.
 - Carry the unit with motor stopped.
 - Store unit with all guards in place. Position unit so that any sharp object cannot accidentally cause injury.

- Store unit and extension cord indoors in a high, dry place out of the reach of children. Store unit unplugged.

EXTENSION CORD STORAGE

The extension cord can be stored on the unit using the cord brackets as shown.

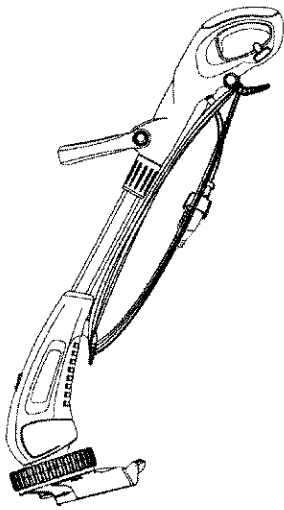

1. Wind cord carefully to avoid kinking.
2. To release the cord, press the button and the bracket will drop down (see illustration).

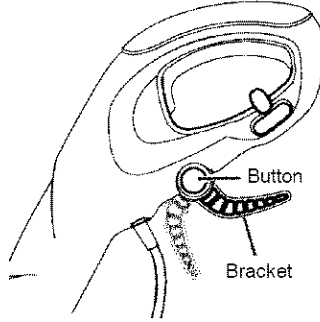

3. Push cord bracket fully back into position.

TROUBLESHOOTING TABLE

⚠ WARNING: Always stop unit and disconnect from the power source before performing all of the recommended remedies below except remedies that require unit to be operating.

TROUBLE	CAUSE	REMEDY
Trimmer head stops under a load or does not turn when switch is pressed.	<ol style="list-style-type: none"> 1. Crowding trimmer line against material being cut. 2. Electrical failure. 3. Thrown circuit breaker. 4. Debris stopping head. 	<ol style="list-style-type: none"> 1. Allow tip of line to do the cutting. 2. Contact Sears Service (see back cover). 3. Check Breaker Box. 4. Remove debris.
Line does not advance, line is too short, or trimmer vibrates.	<ol style="list-style-type: none"> 1. Line improperly routed in head. 2. Line improperly wound into spool. 3. Incorrect line size 4. Not enough line outside of head. 5. Manual line feed not working. 6. Dirt buildup on unit. 	<ol style="list-style-type: none"> 1. Check line routing. 2. Rewind line tightly and evenly. 3. Use only 0.085 in. (1.65 mm) dia. line. 4. Remove spool cap and spool. Manually feed line. Reinstall cap and spool. See Automatic Line Feed System section. 5. Rewind line tightly and evenly. Check that line is in correct section of spool. 6. Clean unit.
Excessive noise when unit is running.	<ol style="list-style-type: none"> 1. Motor has not reached full speed before use. 2. Too much line has been released from the spool. 3. Line limiter pin missing from shield. 	<ol style="list-style-type: none"> 1. Allow the motor to reach full speed before use. 2. Rewind line tightly and evenly. See Automatic Line Feed System section. 3. Contact Sears Service (see back cover).
Line releases continuously.	<ol style="list-style-type: none"> 1. Line improperly routed in head. 2. Spool damaged. 	<ol style="list-style-type: none"> 1. Check line routing. 2. Replace spool.
Line usage is excessive.	<ol style="list-style-type: none"> 1. Line improperly routed in head. 2. Line size is incorrect. 3. Crowding line against material being cut. 4. Spool worn or damaged. 	<ol style="list-style-type: none"> 1. Check line routing. 2. Replace spool. 3. Cut with tip of line fully extended. 4. Replace spool.
Wheel stops turning.	<ol style="list-style-type: none"> 1. Dirt or debris buildup on wheel or in groove. 	<ol style="list-style-type: none"> 1. Clean wheel and groove on motor housing (see Maintenance section).