

A1013 OWNER'S MANUAL

SEARS



MODEL NO.
308.700020

- safety rules • assembly
- care • replacement parts

FAMILY CABIN TENT

**CAUTION: READ ALL INSTRUCTIONS
CAREFULLY BEFORE USE AND RETAIN
THEM FOR FUTURE REFERENCE.**

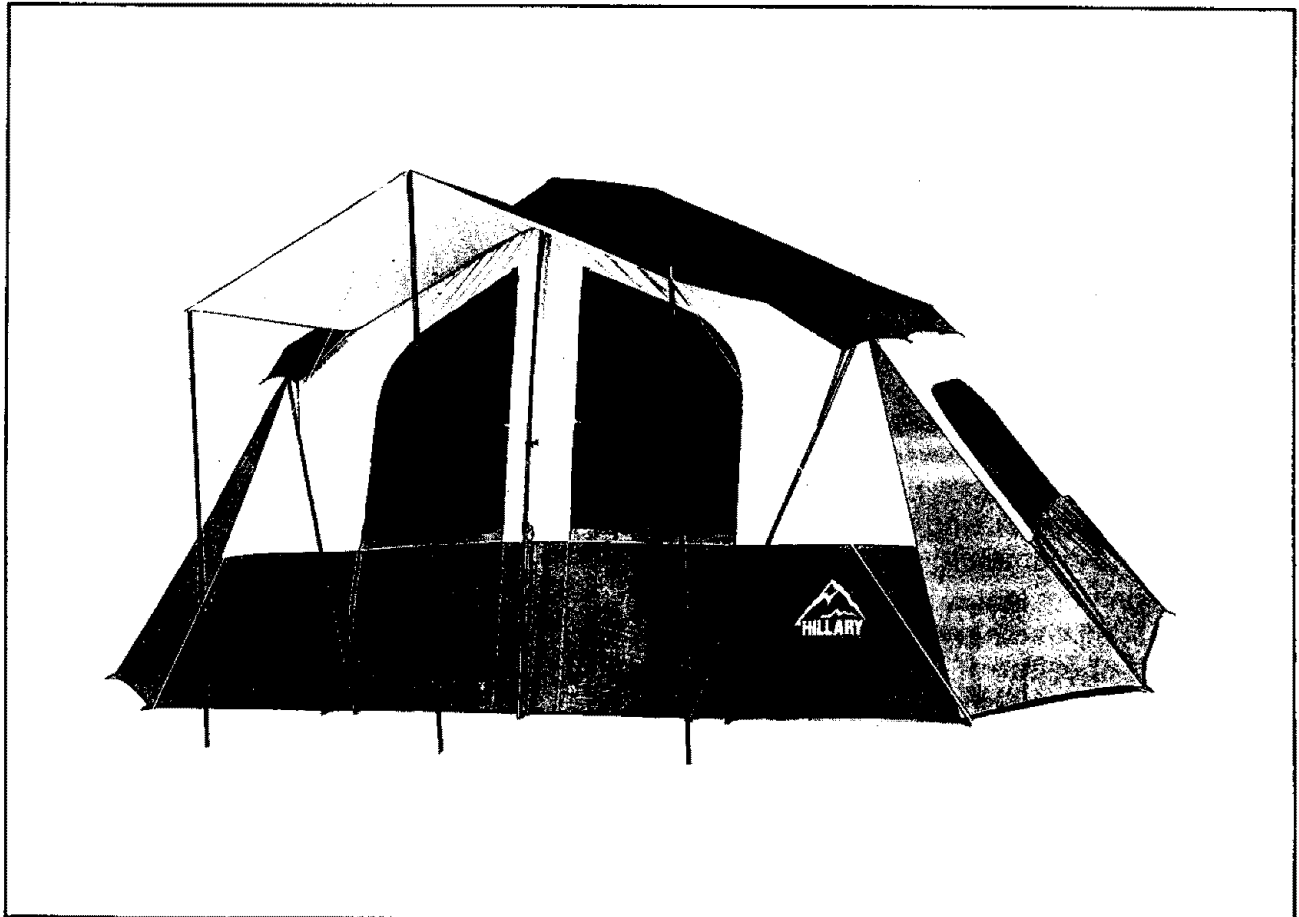

SAFETY

WARNING

KEEP ALL FLAME AND HEAT SOURCES AWAY FROM THIS TENT FABRIC. This tent is made with flame resistant fabric which meets CPAI-84 specifications. **IT IS NOT FIREPROOF.** The fabric will burn if left in continuous contact with any flame source. The application of any foreign substance to the tent fabric may render the flame-resistant properties ineffective.

DO NOT...

1. Do not pitch tents near open fire.
2. Do not leave campfire unattended.
3. Do not leave children unattended inside a tent.
4. Do not use heating, lighting or cooking equipment with open flames in or near tent.
5. Do not use other than recommended water-repellent compounds on your tent.
6. Do not spray your tent with insecticide.
7. Never use fuel burning, oxygen consuming devices (i.e. heaters, lanterns, cooking stoves or other flame sources) inside your tent.

DO...

1. Always extinguish campfire before leaving area.
2. Exercise care when using electricity and lighting in and near tents.
3. Make certain your tent is properly ventilated in all weather conditions. In extreme weather conditions, snow could obstruct airflow and cause asphyxiation unless cleared frequently.
4. Anchor your tent securely to provide additional security from changing climatic conditions. Snow pegs, skis and/or heavy rocks may be necessary to supplement tent stakes and guy cords.
5. Take your tent down and store properly after camping.

CARE

DO NOT LEAVE YOUR TENT SET UP IN DIRECT SUNLIGHT LONGER THAN NECESSARY. THE POLYESTER FABRIC IN YOUR HILLARY TENT PROVIDES MUCH GREATER ULTRAVIOLET RESISTANCE THAN NYLON TENTS BUT FOR MAXIMUM LIFE OF PRODUCT, AVOID SET UP IN SUNLIGHT FOR PROLONGED PERIODS OF TIME.

Your tent is water repellent. However, it is not waterproof. During heavy rain some leakage may occur. Keep objects from touching the inside of the tent. Such objects may cause leakage at point of contact. If seam leakage occurs, it can be controlled by applying a seam sealer compound.

Although our tents and screen houses are constructed to rigid specifications, periods of wind or rain soaking the ground may loosen the stakes and cause the uprights to sink into the ground. This will weaken the rigidity of the overall structure. Water pockets may also form in the roof if the unit is not assembled taut, possibly causing broken frames and torn fabric.

Make certain your tent is clean and dry before storage. Do not store on concrete floor.

FULL ONE YEAR WARRANTY

If, within one year from the date of purchase, this tent fails due to defect in material or workmanship, warranty service is available by RETURNING IT TO THE NEAREST SEARS STORE/SERVICE CENTER in the United States and Sears will repair it, free of charge.

This warranty gives you specific legal rights, and you may also have other rights which vary from state to state.

SEARS, ROEBUCK AND CO.
Department 817 WA
Hoffman Estates, IL 60179
USA

Let's Go Camping Checklist

SAFETY AND HEALTH AIDS

- First aid kit
- Insect repellent
- Hat
- Sun screen
- Lip balm
- Sewing kit
- Canteen
- Map
- Compass
- Binoculars
- Emergency blanket
- Signal whistle
- Sunglasses
- Bandanna
- Rain gear (poncho or rain suit)

CAMP BATH

- Toothbrush
- Toothbrush container
- Soap - biodegradable
- Soap container
- Toilet tissue
- Wash basin
- Mirror
- Camper's shower

PERSONAL LIST

-
-
-
-
-

ATTENTION!!!

- If You Have... **Camping Suggestions**
 - If You Need... **Problems Solved**
- If You Have... **Consumer Questions**

CALL OUR CONSUMER HOT LINE
1-800-325-8368

SEARS





Let's Go Camping Checklist

Thank you for buying a Hillary tent only available at Sears. To show our appreciation for your purchase, we're including this camping trip checklist. This is a great start to your own personal listing. We hope you enjoy your camping experience!

CAMPSITE

- | | |
|--|---|
| <input type="checkbox"/> Tent | <input type="checkbox"/> Axe |
| <input type="checkbox"/> Spare tent stakes | <input type="checkbox"/> Camp saw |
| <input type="checkbox"/> Sleeping bags | <input type="checkbox"/> Pocket knife |
| <input type="checkbox"/> Sleeping mats, self inflating or air mattress with air pump | <input type="checkbox"/> Hammer or mallet |
| <input type="checkbox"/> Camp chair | <input type="checkbox"/> Whisk broom |
| <input type="checkbox"/> Lounge chair | <input type="checkbox"/> Flashlight, spare batteries and bulb |
| <input type="checkbox"/> Folding table | <input type="checkbox"/> Rope and clothespins |
| <input type="checkbox"/> Fire extinguisher | <input type="checkbox"/> Fishing rod and tackle |
| <input type="checkbox"/> Propane, fluorescent, kerosene or battery powered lantern | <input type="checkbox"/> Other sporting gear |
| <input type="checkbox"/> Tarp | <input type="checkbox"/> Camera and film with spare batteries |
| <input type="checkbox"/> Day pack | <input type="checkbox"/> Butane gas lighter |
| | <input type="checkbox"/> Shovel |

CAMP KITCHEN

- | | |
|---|---|
| <input type="checkbox"/> Propane stove | <input type="checkbox"/> Paper towels |
| <input type="checkbox"/> Propane fuel | <input type="checkbox"/> Napkins |
| <input type="checkbox"/> Matches in waterproof match safe | <input type="checkbox"/> Water container |
| <input type="checkbox"/> Dish pan | <input type="checkbox"/> Cooler |
| <input type="checkbox"/> Detergent - biodegradable | <input type="checkbox"/> Insulated jug |
| <input type="checkbox"/> Coffee pot | <input type="checkbox"/> Can opener / Bottle opener |
| <input type="checkbox"/> Mess kits | <input type="checkbox"/> Aluminum foil |
| <input type="checkbox"/> Pot scrubbers | <input type="checkbox"/> Pot holders |
| <input type="checkbox"/> Cook kit | <input type="checkbox"/> Knives, forks & spoons |
| <input type="checkbox"/> Cooking fork, tongs, spatula | <input type="checkbox"/> Serving spoons |
| <input type="checkbox"/> Salt and pepper shakers | <input type="checkbox"/> Measuring cups |
| <input type="checkbox"/> Camp grill top | <input type="checkbox"/> Storage containers |
| <input type="checkbox"/> Charcoal | <input type="checkbox"/> Plastic mugs |
| <input type="checkbox"/> Fire starter | <input type="checkbox"/> Garbage bags |

REPLACEMENT PARTS

*Congratulations on your purchase of a Sir Edmund Hillary tent,
an exclusive brand of Sears.*

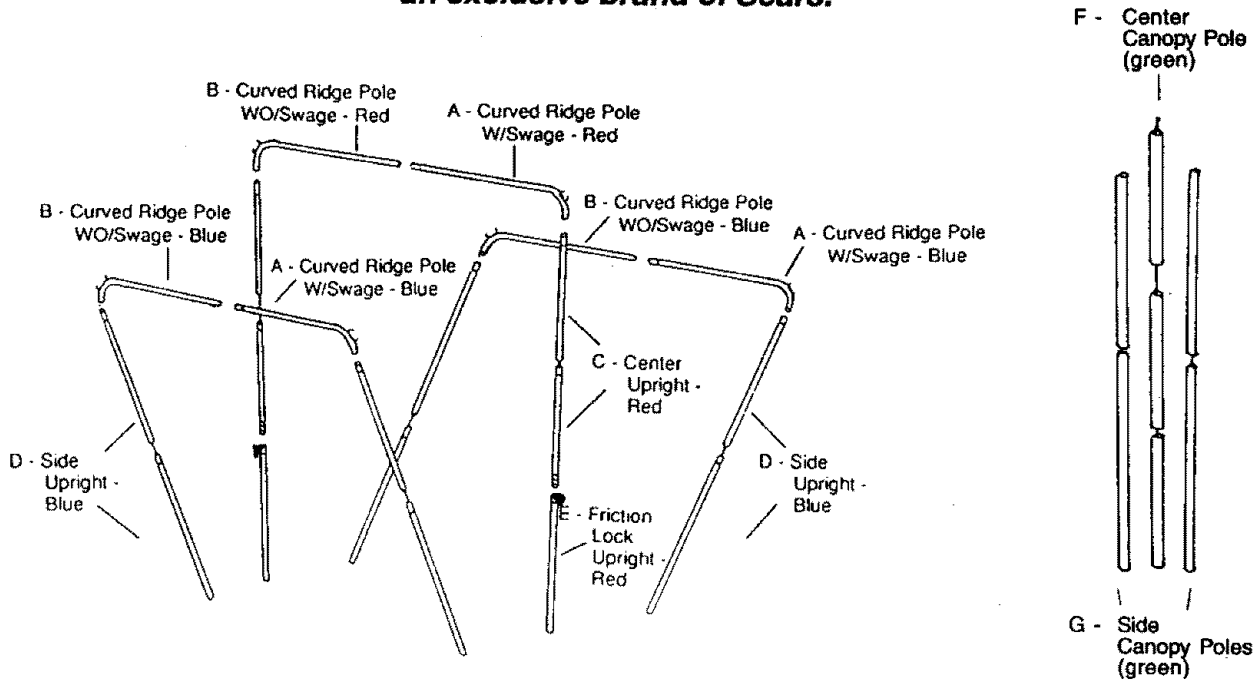

HOW TO ORDER REPLACEMENT PARTS FOR YOUR NEW DOME TENT

The Model Number for your tent will be found on the convenience pocket sewn on the inside of the tent. Always mention the Model Number in all correspondence regarding your Sears Tent and when ordering replacement parts.

All parts listed herein may be ordered from any Sears, Roebuck and Co. retail store or by calling toll free 1-800-366-7278. For questions concerning your tent, call 1-800-325-8368.

WHEN ORDERING REPAIR PARTS, ALWAYS GIVE THE FOLLOWING INFORMATION:

1. Part Number
2. Parts Description
3. Model Number
4. Name of Item

If the parts you need are not stocked locally, your order will be electronically transmitted to a Sears Repair Parts Distribution Center for expedited handling.

KEY NO.	DESCRIPTION	MODEL NO. 700020	MODEL NO.	QUANTITY REQUIRED
		PART NO.	PART NO.	
A	CURVED RIDGE POLE WITH SWAGE - BLUE	99-2001B		3
B	CURVED RIDGE POLE W/O SWAGE - BLUE	99-2002B		3
C	CENTER UPRIGHT - RED	99-2003B		2
D	SIDE UPRIGHT - BLUE	99-2004B		4
E	FRICTION LOCK UPRIGHT - RED	97-2004B		2
F	CENTER CANOPY POLE - GREEN	96-0038B		1
G	SIDE CANOPY POLES - GREEN	96-0039B		2
	COMPLETE FRAME	57000200BS		1
	TENT CARRY BAG	CABIN BAG		1

ASSEMBLY INSTRUCTIONS

IMPORTANT: WE ADVISE YOU TO ASSEMBLE THE TENT ONCE BEFORE GOING CAMPING TO BECOME FAMILIAR WITH THE ASSEMBLY OF THE TENT. FOR THIS MODEL, IT IS RECOMMENDED TWO PEOPLE BE INVOLVED IN SETTING UP THIS TENT.

NOTE: PLEASE LOOK AT THE REPLACEMENT PARTS DIAGRAM TO SEE HOW YOUR FRAME HAS BEEN COLOR CODED FOR EASY SET UP.

- To prolong the life of the tent floor, select a level, clean area for the campsite.
- To prevent damage to the zipper, unzip the doors and window flaps to allow air to enter the tent.

STEP 1: Separate all frame sections by color.

STEP 2: Spread tent out flat, floor side down.

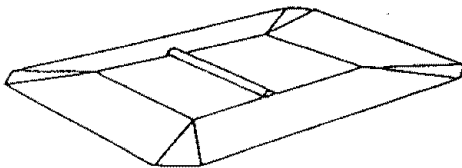

Stake down tent by inserting stakes through stake loops at each corner. Hammer stakes into the ground at a 45° angle by using a hammer or mallet. Make sure to pull tent out even and tight.

Stake down remaining loops.

STEP 3: The top center section of the frame, called the "center ridge pole", consists of two bent sections, color coded red, one with plain end and one with swage.

Join these sections together by sliding the straight end of each pole through the loop and into the sleeve at opposite ends on the center of the roof.

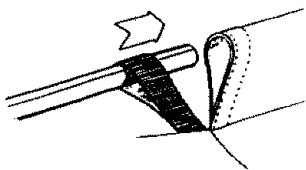

Pull loops over curve and attach to C-clips.

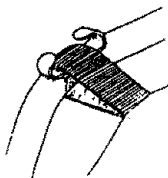

STEP 4: Locate "side ridge poles", color coded blue. The side ridges of the tent have 3 sleeves. Repeat above step 3, inserting poles through corner loops and then the sleeves.

NOTE: Make sure pole sleeves do not catch on pole while inserting.

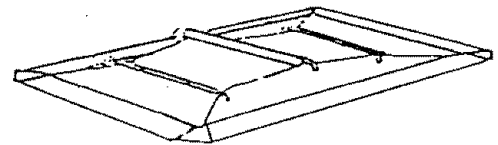

STEP 5: There are two center upright sections, color coded red. The center upright section consists of two straight poles corded together and one friction lock pole (this has a plastic clamp attached at one end). Extend two straight sections and insert one with the reduced end up, through the plastic clamp and into the steel pole section. Repeat with the remaining upright section.



Join each upright section to the curved end of the center ridge pole.

STEP 6: With the help of another, on the opposite side, lift and push up on the upright sections to raise tent. Adjust center height by adjusting friction locks. Once raised, clip tent to frame.

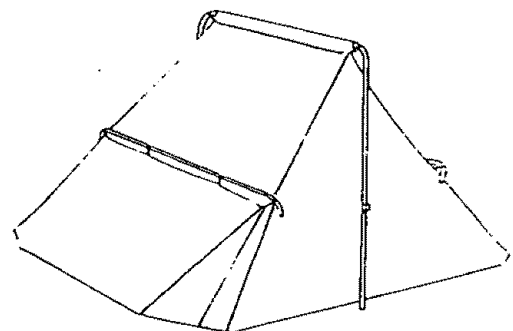

ASSEMBLY INSTRUCTIONS

STEP 7: There are four side upright sections color coded blue. Extend all four pole sections and join one of these side uprights into the bent end of the side ridge pole section, doing opposite sides at the same time. Make certain the ends of the poles, with a drilled hole for the fly attachment, are up.

With the help of another, push up on the frame until tent is pulled out evenly.



Try door zippers. If they are hard to open and close, adjust the frame legs slightly to reduce tension on zipper.

STEP 8: Place fly over tent. Attach hooks on fly into the holes located on each of the metal pole sections.

STEP 9: Extend remaining poles, color coded green, to form three canopy poles. Place the pointed end of each pole through each grommet on the canopy. The longer pole is for the center of the canopy.

Tie a guy out rope to the point of the center canopy pole. Pull rope straight out and stake down. Repeat the same step for corner poles, pulling rope out at a 45° angle to the tent and stake down.

STEP 10: Guy ropes are provided for windy conditions. Tie guy ropes through loops on each side of the fly. Make a loop at the opposite end of the guy rope by using slider and place loop over the tent stake. Adjust slider to make guy rope tight. Extra tent stakes have been included for this.

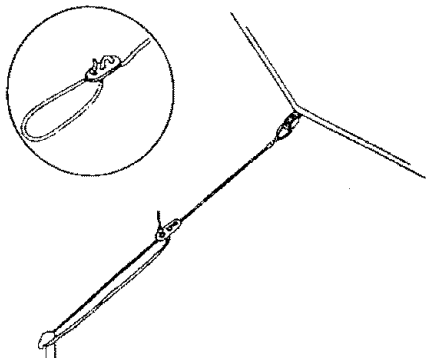

Assembled tent should appear as shown.



Your tent includes a divider curtain which can be hooked into the center of your tent to divide the tent into two rooms.

Convenience pockets are provided for storing small camping gear.

NOTE: To take down tent, follow above steps in the reverse order. Be sure to leave tent unzipped. Place stakes into stake bag, which is provided.

To roll tent up, fold into thirds lengthwise toward the door. At opposite end of the door, start a small, tight roll and roll toward the door. Once rolled, tie a string or rope around tent to hold into place. Slide tent, frame and stakes into carry bag. Make sure tent is clean and dry before storing.