

Use & Care Manual

Gas Range

ES340 Control, Self-Cleaning Oven
with Sealed Gas Burners

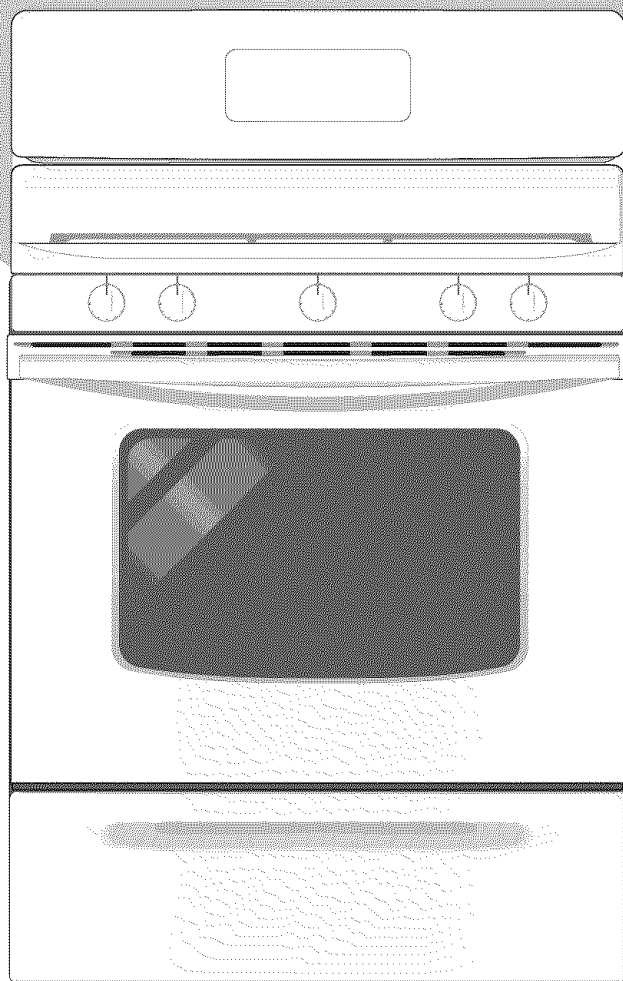

Questions or for Service Call:

1-800-944-9044 (U.S.)

1-800-668-4606 (Canada)

Visit the Frigidaire Web Site at: <http://www.frigidaire.com>

Welcome 2



Important Safety Instructions 2-4



Features at a Glance 5

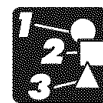

Before Setting Oven Controls 6



Setting Surface Controls 7



Oven Control Functions 8



Setting Oven Controls 9-13



Self Cleaning 14-15



General Care & Cleaning 16-18



Adjusting Oven Temperature 18

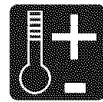

Before You Call

Solutions to Common Problems 19



Warranty Back Page





Welcome & Congratulations

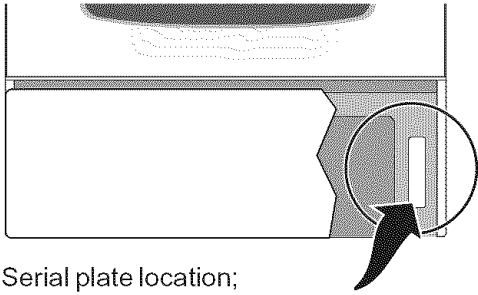

Serial plate location;
Open storage drawer (some models)
or remove outer lower panel (some models).

Product Registration

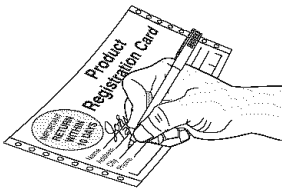

Register Your Product

The self-addressed **PRODUCT REGISTRATION CARD** should be filled in completely, signed and returned to Electrolux Home Products.

Congratulations on your purchase of a new range! At **Electrolux Home Products**, we are very proud of our product and are completely committed to providing you with the best service possible. Your satisfaction is our number one priority.

We know you'll enjoy your new range and **Thank You** for choosing our product. We hope you consider us for future purchases.

PLEASE CAREFULLY READ AND SAVE THESE INSTRUCTIONS

This Use & Care Manual provides specific operating instructions for your model. Use your range only as instructed in this manual. These instructions are not meant to cover every possible condition and situation that may occur. Common sense and caution must be practiced when installing, operating and maintaining any appliance.

Please record your model and serial numbers below for future reference.

Model Number: _____

Serial Number: _____

Purchase Date: _____

This Use & Care Manual contains general operating instructions for your range and feature information for several models. Your range **may not** have all the described features. The graphics shown are representational. The graphics on your range may not look exactly like those shown.



Important Safety Instructions

Grounding type
wall receptacle

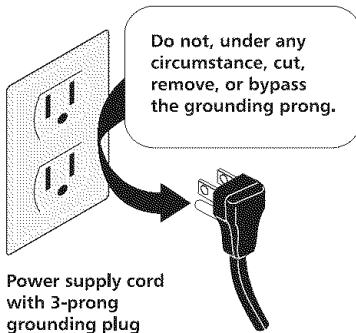

Power supply cord
with 3-prong
grounding plug

See the **INSTALLATION INSTRUCTIONS** packaged with this range for complete installation and grounding instructions.

Grounding Instructions (electric ignition models only)

⚠ WARNING Avoid fire hazard or electrical shock. Do not use an adapter plug, an extension cord, or remove grounding prong from electrical power cord. Failure to follow this warning can cause serious injury, fire or death.

⚠ WARNING This appliance is equipped with a 3-prong grounding plug for your protection against shock hazard and should be plugged directly into a properly grounded receptacle. **DO NOT** cut or remove the grounding prong from this plug.

For personal safety, the range must be properly grounded. For maximum safety, the power cord must be plugged into an electrical outlet that is correctly polarized and properly grounded.

If a 2-prong wall receptacle is the only available outlet, it is the personal responsibility of the consumer to have it replaced with a properly grounded 3-prong wall receptacle installed by a qualified electrician.

Conversion to Liquefied Petroleum Gas (or L.P. Gas)

The natural gas range is designed to allow for conversion to Liquefied Petroleum (L.P.) Gas.

If L.P. conversion is needed, contact your local appliance dealer for assistance. The L.P. Conversion Kit may be obtained from your appliance dealer and should be installed by a qualified service technician. Before installing the kit be sure to follow the L.P. Installation Instructions carefully.

⚠ WARNING Personal injury or death from electrical shock may occur if the range is not installed by a qualified installer or electrician.

⚠ CAUTION Any additions, changes or conversions required in order for this appliance to satisfactorily meet the application needs must be made by a qualified technician.

Important Safety Instructions



Read all instructions before using this appliance. Save these instructions for future reference.

This manual contains important safety symbols and instructions. Please pay attention to these symbols and follow all instructions given.

⚠ WARNING This symbol will help alert you to situations that may cause serious bodily harm, death or property damage.

⚠ CAUTION This symbol will help alert you to situations that may cause bodily injury or property damage.

⚠ WARNING If the information in this manual is not followed exactly, a fire or explosion may result causing property damage, personal injury or death.

FOR YOUR SAFETY:

- Do not store or use gasoline or other flammable vapors and liquids in the vicinity of this or any other appliance.
 - **WHAT TO DO IF YOU SMELL GAS:**
 - Do not try to light any appliance.
 - Do not touch any electrical switch; do not use any phone in your building.
 - Immediately call your gas supplier from a neighbor's phone. Follow the gas supplier's instructions.
 - If you cannot reach your gas supplier, call the fire department.
 - Installation and service must be performed by a qualified installer, servicer or the gas supplier.
- **Remove all tape and packaging before using the range.** Destroy the carton and plastic bags after unpacking the range. Never allow children to play with packaging material.
 - **Proper Installation—Be sure your appliance is properly installed and grounded by a qualified technician in accordance with the National Fuel Gas Code ANSI Z223.- latest edition, or in Canada CAN/CGA B149.1, and CAN/CGA B149.2, and the the National Electrical Code ANSI/NFPA No.70-latest edition, or in Canada CSA Standard C22.1, Canadian Electrical Code, Part 1, and local code requirements.** Install only per installation instructions provided in the literature package for this range. Ask your dealer to recommend a qualified technician and an authorized repair service. Know how to disconnect the power to the range at the circuit breaker or fuse box in case of an emergency.
 - **User servicing—Do not repair or replace any part of the appliance unless specifically recommended in the manuals.** All other servicing should be done only by a qualified technician. This may reduce the risk of personal injury and damage to the range.
 - **Never modify or alter the construction of a range by removing leveling legs, panels, wire covers, anti-tip brackets/screws, or any other part of the product.**

Important Safety Notice

The California Safe Drinking Water and Toxic Enforcement Act requires the Governor of California to publish a list of substances known to the state to cause cancer, birth defects or other reproductive harm, and requires businesses to warn customers of potential exposure to such substances.

⚠ WARNING

- All ranges can tip.
- Injury to persons could result.
- Install anti-tip device packed with range.
- See Installation Instructions.



⚠ WARNING To reduce the risk of tipping, the range must be secured by properly installed anti-tip bracket provided with the range. To check if the bracket is installed properly, visually check that rear leveling leg is inserted into and fully secured by the anti-tip bracket by removing lower panel or storage drawer. For models with a warmer drawer, grasp the top rear edge of the range and carefully attempt to tilt it forward. Refer to the installation instructions for proper anti-tip bracket installation.

⚠ WARNING NEVER use this appliance as a space heater to heat or warm the room. Doing so may result in carbon monoxide poisoning.

⚠ WARNING NEVER cover any slots, holes or passages in the oven bottom or cover an entire rack with materials such as aluminum foil. Doing so blocks air flow through the oven and may cause carbon monoxide poisoning. Aluminum foil linings may trap heat, causing a fire hazard.

⚠ WARNING Stepping, leaning or sitting on the doors or drawers of this range can result in serious injuries and also cause damage to the range. Do not allow children to climb or play around the range. The weight of a child on an open door may cause the range to tip, resulting in serious burns or other injury.

⚠ WARNING Do not use the oven or warmer drawer (if equipped) for storage.

⚠ CAUTION Do not store items of interest to children in the cabinets above a range or on the backguard of a range. Children climbing on the range to reach items could be seriously injured.

⚠ WARNING Never Use Your Appliance for Warming or Heating the Room.

• **Storage in or on Appliance—Flammable materials should not be stored in an oven, warmer drawer, near surface burners or in the storage drawer.** This includes paper, plastic and cloth items, such as cookbooks, plasticware and towels, as well as flammable liquids. Do not store explosives, such as aerosol cans, on or near the range.



Important Safety Instructions

- **Do Not Leave Children Alone**—Children should not be left alone or unattended in the area where appliance is in use. They should never be allowed to sit or stand on any part of the appliance.
- **DO NOT TOUCH SURFACE BURNERS, AREAS NEAR THESE BURNERS, OVEN BURNERS OR INTERIOR SURFACES OF THE OVEN.** Both surface and oven burners may be hot even though flames are not visible. Areas near surface burners may become hot enough to cause burns. During and after use, do not touch, or let clothing or other flammable materials touch these areas until they have had sufficient time to cool. Among these areas are the cook top, surfaces facing the cook top, the oven vent openings and surfaces near these openings, oven door and window.
- **Wear Proper Apparel**—Loose-fitting or hanging garments should never be worn while using the appliance. Do not let clothing or other flammable materials contact hot surfaces.
- **Do Not Use Water or Flour on Grease Fires**—Smother the fire with a pan lid, or use baking soda, a dry chemical or foam-type extinguisher.
- **When heating fat or grease, watch it closely.** Fat or grease may catch fire if allowed to become too hot.
- **Use Only Dry Potholders**—Moist or damp potholders on hot surfaces may result in burns from steam. Do not let potholders touch hot heating burners. Do not use a towel or other bulky cloth instead of a potholder.
- **Do Not Heat Unopened Food Containers**—Buildup of pressure may cause container to burst and result in injury.
- **Remove the oven door from any unused range if it is to be stored or discarded.**

IMPORTANT—ELECTRIC IGNITION MODELS ONLY: Do not attempt to operate the oven during a power failure. If the power fails, always turn off the oven. If the oven is not turned off and the power resumes, the oven will begin to operate again. Once the power resumes, reset the clock and oven function.

IMPORTANT INSTRUCTIONS FOR USING YOUR COOKTOP

- **WARNING Use Proper Flame Size**—Adjust flame size so it does not extend beyond the edge of the utensil. The use of undersized utensils will expose a portion of the burner flame to direct contact and may result in ignition of clothing. Proper relationship of utensil to flame will also improve efficiency.
- **Know which knob controls each surface burner.** Place a pan of food on the burner before turning it on, and turn the burner off before removing the pan.
- **Always turn knob to the full LITE position when igniting top burners.** Visually check that burner has lit. Then adjust the flame so it does not extend beyond the edge of the utensil.
- **Utensil Handles Should Be Turned Inward and Not Extend Over Adjacent Surface Burners**—To reduce the risk of burns, ignition of flammable materials, and spillage due to unintentional contact with the utensil, the handle of the utensil should be positioned so that it is turned inward, and does not extend over adjacent surface burners.
- **Never Leave Surface Burners Unattended at High Heat Settings**—Boilovers cause smoking and greasy spillovers that may ignite, or a pan that has boiled dry may melt.

- **Protective Liners**—Do not use aluminum foil to line surface burner pans, or oven bottom, except as suggested in this manual. Improper installation of these liners may result in risk of electric shock, or fire.
- **Glazed Cooking Utensils**—Only certain types of glass, glass/ceramic, ceramic, earthenware, or other glazed utensils are suitable for cooktop service without breaking due to the sudden change in temperature. Check the manufacturer's recommendations for cooktop use.

IMPORTANT INSTRUCTIONS FOR USING YOUR OVEN

- **Use Care When Opening Oven Door or Warmer Drawer**—Stand to the side of the range when opening the door of a hot oven. Let hot air or steam escape before you remove or replace food in the oven.
- **Keep Oven Vent Ducts Unobstructed.** The oven vent is located below the backguard. Touching the surfaces in this area when the oven is operating may cause severe burns. Also, do not place plastic or heat-sensitive items on or near the oven vent. These items could melt or ignite.
- **Placement of Oven Racks.** Always place oven racks in desired location while oven is cool. If rack must be moved while oven is hot use extreme caution. Use potholders and grasp the rack with both hands to reposition. Do not let potholders contact the hot heating elements in the oven. Remove all utensils from the rack before moving.
- **Do not use the broiler pan without its insert.** The broiler pan and its insert allow dripping fat to drain and be kept away from the high heat of the broiler.
- **Do not cover the broiler insert with aluminum foil. Exposed fat and grease could ignite.**
- Cold temperatures can damage the electronic control. When using the appliance for the first time, or when the appliance has not been used for an extended period of time, be certain the unit has been in temperatures above 32°F (0°C) for at least 3 hours before turning on the power to the appliance.

IMPORTANT INSTRUCTIONS FOR CLEANING YOUR RANGE

- **Clean the range regularly to keep all parts free of grease that could catch fire.** Pay particular attention to the area underneath each surface element. Do not allow grease to accumulate. Refer to the range manufacturer's instructions for cleaning.
- **Kitchen cleaners and aerosols**—Always follow the manufacturer's recommended directions for use. Be aware that excess residue from cleaners and aerosols may ignite causing damage and injury.

SELF CLEANING OVENS

- **Clean in the self-cleaning cycle only the parts listed in this Owner's Guide.** Before self cleaning the oven, remove the broiler pan and any utensils or foods from the oven.
- **Do Not Use Oven Cleaners**—No commercial oven cleaner or oven liner protective coating of any kind should be used in or around any part of the oven.
- **Do Not Clean Door Gasket**—The door gasket is essential for a good seal. Care should be taken not to rub, damage or move the gasket.

Features At A Glance

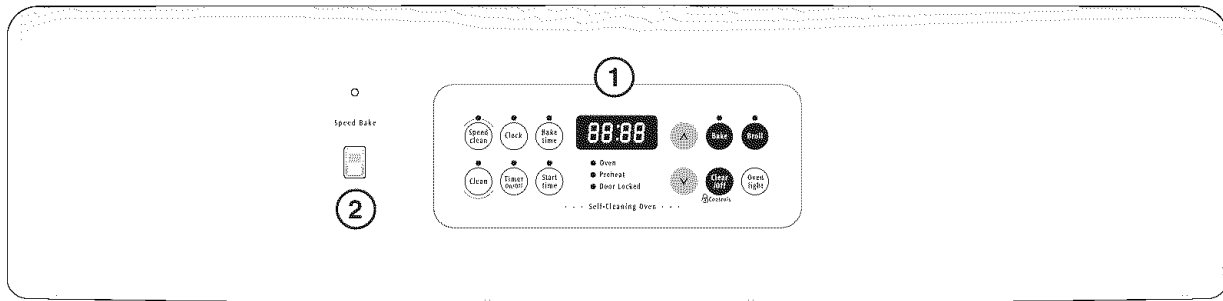

Your Gas Range Features Include:

1. Electronic Oven Control with Kitchen Timer.
2. Speed Bake™ Cooking System Control Switch & Indicator Light (some models).
3. Left Front Burner Valve & Knob.
4. Left Rear Burner Valve & Knob.
5. Center Burner Valve & Knob (some models).
6. Right Rear Burner Valve & Knob.
7. Right Front Burner Valve & Knob.
8. Easy to clean Upswept cooktop (some models) or deep well style cooktop (some models).
9. Dishwasher safe Burner Grates (styles & colors vary by model).
10. Dishwasher safe Center Burner Grate (some models)
11. Self-Clean Oven Door Latch.
12. Automatic Oven Door Light Switch (some models).
13. Oven Interior Light with Shield (some models).
14. Self-Cleaning Oven interior.
15. Adjustable Oven Rack(s).
16. Speed Bake™ Cooking System Fan (some models).
17. Large 1 piece Oven Door Handle.
18. Full width Oven Door (styles vary with model).
19. Storage Drawer with integrated Handle (some models) or lower cover panel (some models).
20. 5,000 BTU Simmer Burner (some models).
21. 9,500 BTU Burner (some models).
22. 12,000 BTU Power Plus Burner (some models).
23. 14,000 BTU Power Plus Burner (some models).
24. 16,000 BTU Power Plus Burner (some models).
25. 9,500 BTU Center Burner (some models).
26. Broil Pan (some models).
27. Broil Pan Insert (some models).
28. Leveling Legs & Anti-tip Bracket (included).
Burner Drip pans (some models).

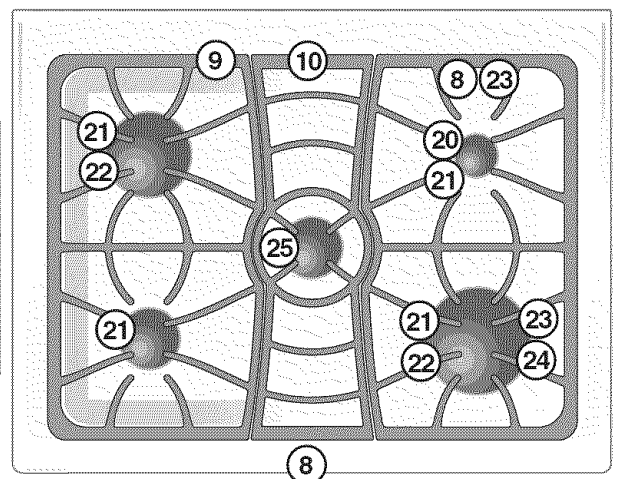
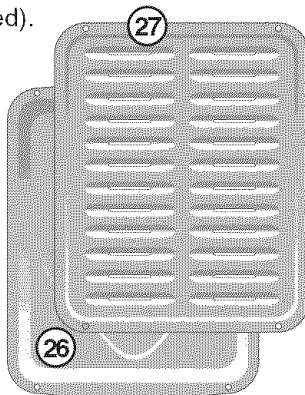
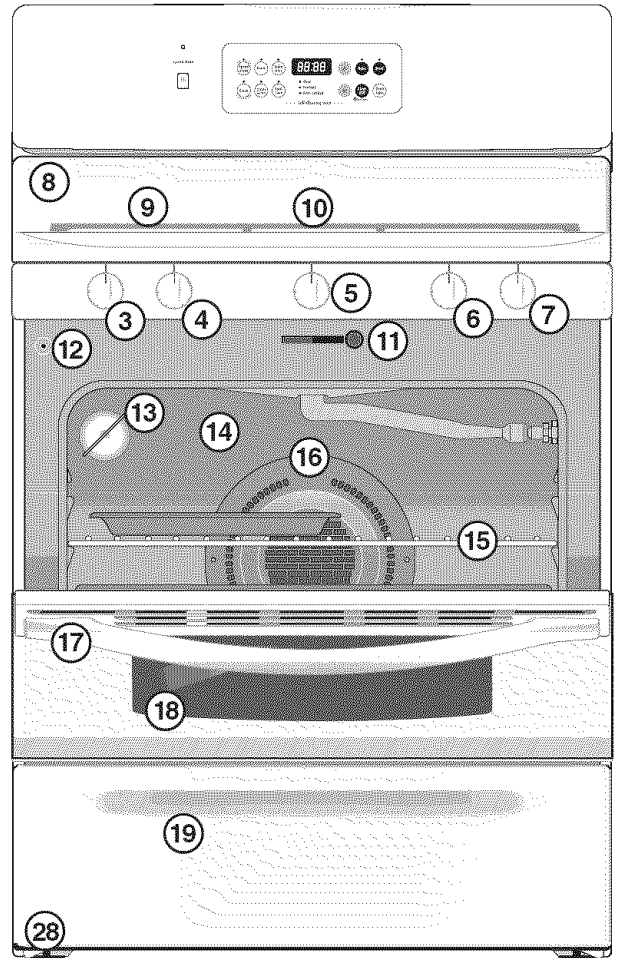

NOTE: The features of your range may vary according to model type & color.



Before Setting Oven Controls

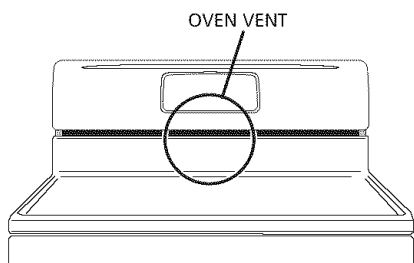

Fig. 1

Oven Vent Location

The oven vent is located **below the backguard** (See Fig. 1). When the oven is on, warm air is released through this vent. This venting is necessary for proper air circulation in the oven and good baking results. **DO NOT BLOCK THE VENT.**

Arranging Oven Racks

ALWAYS ARRANGE OVEN RACKS WHEN THE OVEN IS COOL (PRIOR TO OPERATING THE OVEN). Always use oven mitts when using the oven.

Removing & Replacing Oven Racks

To remove, pull the rack forward until it stops. Lift up front of rack and slide out.

To replace, fit the rack onto the guides on the oven walls. Tilt the front of the rack upward and slide the rack back into place.

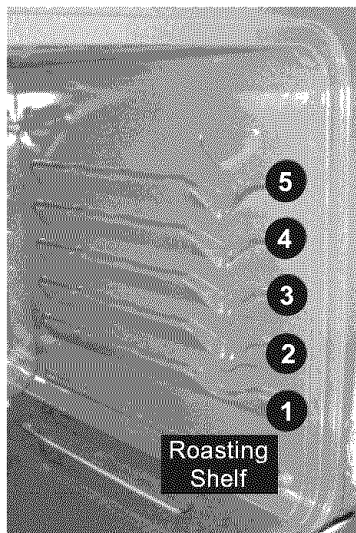

Fig. 2

Recommended Rack Positions for Broiling, Baking & Roasting:

Food	Rack Position
Broiling hamburgers & steaks	See Broil section
Broiling meats, chicken or fish	See Broil section
Cookies, cakes, pies, biscuits & muffins	2 or 3
Frozen pies, angel food cake, yeast, bread, casseroles, small cuts of meat or poultry	1 or Roasting Shelf
Turkey, roast or ham	

Oven Racks

Your range is equipped with one or more **Flat Oven Rack(s)**. Place the rack(s) into the positions shown in Fig. 2. See the Recommended Rack Positions in the chart above.

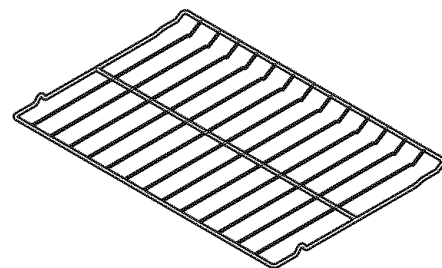

Flat Oven Rack
Fig. 3

Baking Layer Cakes with 1 or 2 Oven Racks

For best results when baking cakes using 2 oven racks, place cookware on rack positions 1 & 4 (See Figs. 2 & 4). For best results when using a single oven Flat Rack, place cookware on rack position 2 or 3 (See Figs. 2 & 5).

Air Circulation in the Oven

For best air circulation and baking results allow 2-4" (5-10 cm) around the cookware for proper air circulation and be sure pans and cookware do not touch each other, the oven door, sides or back of the oven cavity. The hot air must be able to circulate around the pans and cookware in the oven for even heat to reach around the food.

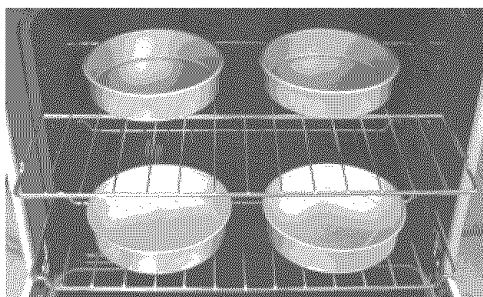

Fig. 4



Fig. 5

Setting Surface Controls



⚠ CAUTION Do not place plastic items such as salt and pepper shakers, spoon holders or plastic wrappings on top of the range when it is in use. These items could melt or ignite. Potholders, towels or wood spoons could catch fire if placed too close to a flame.

In the event of an electrical power outage, the surface burners can be lit manually. To light a surface burner, hold a lit match to the burner head, then slowly turn the surface control knob to **LITE**. After burner lights push in and turn knob to desired setting. Use caution when lighting surface burners manually.

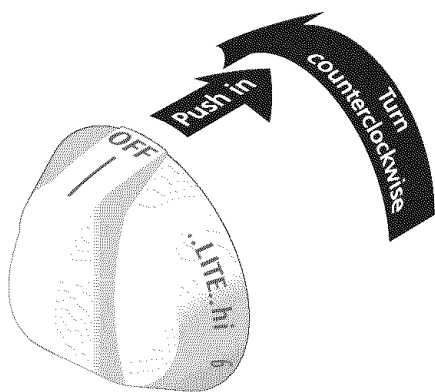

OFF ..LITE.. hi 6 5 4 3 2 lo

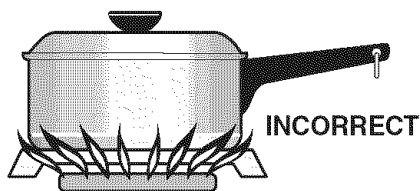
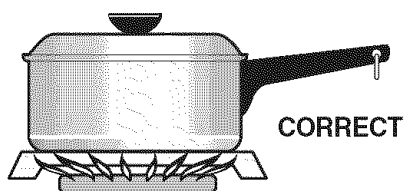

Never extend the flame beyond the outer edge of the utensil. A higher flame simply wastes heat and energy, and increases your risk of being burned by the flame.

Setting Surface Controls

Your range may be equipped with different sized surface burners. The ability to heat food quicker and in larger volumes increases as the burner size increases.

The **SIMMER** burner (some models) is best used for simmering delicate sauces, etc.

The standard burners can be used for most surface cooking needs. Some models include a standard sized center burner (or 5th burner).

The **POWER PLUS** burner(s) (some models) are best used for bringing large quantities of liquid to temperature and when preparing larger quantities of food.

Regardless of size, always select cookware that is suitable for the amount and type of food being prepared. Select a burner and flame size appropriate to the pan. Never allow flames to extend beyond the outer edge of the pan.

Operating the Gas Surface Burners:

1. Place cooking utensil on surface burner.
2. Push the surface control knob in and turn **counterclockwise** out of the OFF position.
3. Release the knob and rotate to the LITE position. Note: All four electronic surface ignitors will spark at the same time. However, only the burner you are turning on will ignite.
3. Visually check that the burner has lit.
4. Push the control knob in and turn **counterclockwise** to the desired flame size. The control knobs do not have to be set at a particular setting. Use the guides and adjust the flame as needed. **DO NOT** cook with the surface control knob in the LITE position. (The electronic ignitor will continue to spark if the knob is left in the LITE position.)

Setting Proper Surface Burner Flame Size

For most cooking, start on the highest control setting and then turn to a lower one to complete the process. Use the recommendations below as a guide for determining proper flame size for various types of cooking. The size and type of utensil used and the amount of food being cooked will influence the setting needed for cooking.

*Flame Size	Type of Cooking
High Flame	Start most foods; bring water to a boil; pan broiling.
Medium Flame	Maintain a slow boil; thicken sauces, gravies; steaming.
Low Flame	Keep foods cooking; poach; stewing.

For deep fat frying, use a thermometer and adjust the surface control knob accordingly. If the fat is too cool, the food will absorb the fat and be greasy. If the fat is too hot, the food will brown so quickly that the center will be undercooked. Do not attempt to deep fat fry too much food at once as the food will neither brown nor cook properly.

*These settings are based on using medium-weight metal or aluminum pans with lids. Settings may vary when using other types of pans. The color of the flame is the key to proper burner adjustment. A good flame is clear, blue and hardly visible in a well-lighted room. Each cone of flame should be steady and sharp. Adjust or clean burner if flame is yellow-orange.



Oven Control Functions

READ THE INSTRUCTIONS CAREFULLY BEFORE USING THE OVEN. For satisfactory use of your oven, become familiar with the various pad functions of the oven as described below.

CLOCK PAD— Used to set the time of day.

BAKE TIME PAD— Used to enter the length of the baking time.

UP and DOWN ARROW PADS— Used along with the function pads to select oven temperature, cook time, start time (when programming an automatic start time), time of day, clean time and minute timer.

BAKE PAD— Used to select the bake function.

FEATURE INDICATOR LIGHTS— These light to show which feature is in use.

BROIL PAD— Used to select the variable broil function.

OVEN LIGHT PAD— Used to turn the interior oven light ON or OFF.

CLEAR/OFF PAD— Used to clear any function previously entered except the time of day and minute timer. Press CLEAR/OFF to stop cooking. Also the CLEAR/OFF pad is used to activate oven lockout setting.

OVEN, PREHEAT & DOOR LOCKED LIGHTS* — The "OVEN" light will glow each time the oven turns on to maintain the set oven temperature. The "PREHEAT" light will glow when the oven is first set to operate, or if the desired temperature is reset higher than the actual oven temperature. The "DOOR LOCKED" light will flash when the oven door locks and unlocks or when using the Self-Clean cycle or the oven door lockout is activated.

TIMER ON/OFF PAD— Used to set or cancel the minute timer. The minute timer does not start or stop cooking. Also, **TIMER ON/OFF** pad is used to set the Continuous Bake feature.

START TIME PAD— Used to set the desired start time for baking & Self-Clean. May be used with **BAKE TIME** to program a delayed bake cycle.

Speed clean (SELF-CLEAN) — Used to select a shorter 2 hour Self-Clean cycle time.

Clean (SELF-CLEAN) — Used to select a longer 3 hour Self-Clean cycle time.

Speed clean (SELF-CLEAN) — Used to select a shorter 2 hour Self-Clean cycle time.

Clean (SELF-CLEAN) — Used to select a longer 3 hour Self-Clean cycle time.

Timer On/off — Used to set or cancel the minute timer. The minute timer does not start or stop cooking. Also, **TIMER ON/OFF** pad is used to set the Continuous Bake feature.

Start time — Used to set the desired start time for baking & Self-Clean. May be used with **BAKE TIME** to program a delayed bake cycle.

Oven
Preheat
Door Locked

Self-Cleaning Oven

Controls

*Note: The **OVEN** indicator light on the electronic display will turn ON and OFF when using the Bake feature and during preheat. This is normal and indicates that the oven is cycling to maintain the selected baking temperature. When the preheat indicator light turns OFF, your oven is ready.

For a silent control panel

When choosing a function, a beep will be heard each time a pad is pressed. If desired, the control can be programmed for silent operation. Press and hold . After 7 seconds, the control will beep once. This will block the controls from sounding when a pad is pressed. To return the sound, press and hold again for 7 seconds until the control beeps once.

Temperature conversion

The electronic oven control is set to operate in °F (Fahrenheit) when shipped from the factory. The oven can be programmed for any temperature from 170°F to 550°F (77°C to 287°C).

To change the temperature to °C (Celsius) or from °C to °F (control should not be in a Bake or Clean mode):

1. Press . "—" appears in the display.
2. Press and hold the until "HI" appears in the display.
3. Press and hold until °F or °C appears in the display.
4. Press the or to change °F to °C or °C to °F.
5. Press any control pad to return to normal operating mode.

Setting Oven Controls



Note: The time of day **must** first be set in order to operate the oven.



To Set the Clock

When the range is first plugged in, or when the power supply to the range has been interrupted, the display will flash "12:00".

1. Press  once (do not hold pad down).
2. Within 5 seconds, press and hold the  or  until the correct time of day appears in the display.

Note: The clock cannot be changed during any timed bake or Self-Clean cycle.

To Set the Minute Timer:

1. Press .
2. Press the  to increase the time in one minute increments. Press and hold the  to increase the time in 10 minute increments. The timer can be set for any amount of time from 1 minute to 11 hours and 59 minutes.



Note: If the  pad is pressed first, the timer will advance to 11 hours and 59 minutes.

3. The display shows the timer countdown in minutes until 1 minute remains. Then the display will countdown in seconds.
4. When the set time has run out, the timer will beep 3 times. It will then continue to beep 3 times every 60 seconds until  is pressed.



Note: The indicator light located above the  pad will glow while the minute timer is active.

Note: The minute timer does not start or stop cooking. It serves as an extra timer in the kitchen that will beep when the set time has run out. The minute timer can be used alone or during any of the other oven functions. When the minute timer is in use with any other function, the minute timer will be shown in the display. To view other functions, press the pad for that function.

To Change the Minute Timer while it is in use:

While the timer is active and shows in the display, press and hold the  or  to increase or decrease the time.

To Cancel the Minute Timer before the set time has run out: Press .

Note: To turn the **time of day** display **OFF** or **ON** in the display press  and hold for 15 seconds (the control will beep once) and then release. This feature does not remove the set time of day from the memory of the control. When the display is turned **OFF** the time of day will re-appear for a few seconds any time the  pad is touched.











Setting Oven Controls



To Set or Change the Temperature for Baking

The oven can be programmed to bake at any temperature from 170°F to 550°F (77°C to 287°C).

To Set the Controls for Baking:

1. Press . "— — —" appears in the display.
2. Within 5 seconds, press the  or . The display will show "350°F (177°C)." By pressing and holding the  or , the temperature can then be adjusted in 5°F increments (1°C if the control is set to display Celsius).
3. As soon as the  or  pad is released, the oven will begin heating to the selected temperature. When the displayed temperature reaches the desired baking temperature, the preheat indicator light will turn OFF and the control will beep 3 times.
4. To cancel baking, press .



To Change the Oven Temperature after Baking has Started:

1. Press  and make sure the bake temperature is displayed.
2. Press the  or  pad to increase or decrease the set temperature.

To Set Control for Continuous Bake or 12 Hour Energy Saving

The oven control has a built-in 12 Hour Energy Saving feature that will shut off the oven if the control is left on for more than 11 hours and 59 minutes. The oven can be programmed to override this feature for continuous baking.



To set control for continuous baking:

1. Press and hold  down for 5 seconds until tone is heard, " — — hr" will appear in display for continuous cooking. The current time of day will return to the display.
2. To cancel the Continuous Bake function, press  and hold for 5 seconds until tone is heard. "12hr" will appear in display indicating that the control has returned to the 12 Hour Energy Saving feature.

To Set Control for Oven Lockout

The control can be programmed to lock the oven door and lockout the oven control pads.

To set Control for Oven Lockout feature:



1. Press  and hold for 3 seconds. "Loc" will appear in display, the "Door Locked" indicator light will flash and the motor driven door lock will begin to close automatically. **DO NOT open oven door** while the indicator light is flashing. Allow about 15 seconds for the oven door to lock. Once the oven door is locked, the current time of day will appear in the display.
2. To cancel the Oven Lockout feature, press  and hold for 3 seconds. The control will unlock the oven door and resume normal operation.

Note: If any control pad is pressed while in the Oven Lockout mode, "Loc" will appear in the display until the control pad is released.

Setting Oven Controls











To Set the Timed Bake and Delay Start (Delayed Timed Bake) Features











The  **BAKE TIME** and  **START TIME** pads operate the features that will turn the oven ON and OFF at the times you select in advance. The oven can be programmed to start immediately and shut off automatically (Timed Bake) or to begin baking at a later time with a delayed start time (Delay Start).

Note: During Timed Bake the preheat indicator light will not function.

To Program the Oven to Begin Baking Immediately and To Shut Off Automatically (Timed Bake):

1. Be sure that the clock shows the correct time of day.
2. Place the food in the oven.
3. Press . " — — — ° " appears in the display.
4. Within 5 seconds, press the  or . The display will show "350°F (177°C)." By holding the  or , the temperature can then be adjusted in 5°F increments (1°C if the control is set to display Celsius).
5. Press . "0:00" will flash in the display (HR:MIN).
6. Press the  or  until the desired baking time appears in the display.
7. The oven will turn ON and begin heating.



To Program Oven for a Delayed Start Time and to Shut-Off Automatically (Delayed Timed Bake):

1. Be sure that the clock shows the correct time of day.
2. Place the food in the oven.
3. Press . " — — — ° " appears in the display.
4. Within 5 seconds, press the  or . The display will show "350°F (177°C)." By holding the  or , the temperature can then be adjusted in 5°F increments (1°C if the control is set to display Celsius).
5. Press . "0:00" will flash in the display (HR:MIN).
6. Press the  or  until the desired baking time appears.
7. Press . The earliest possible start time will appear in the display.
8. Press the  or  until the desired start time appears in the display.
9. Once the controls are set, the control calculates the time when baking will stop in order to start at the time you have set.
10. The oven will turn ON at the delayed start time and begin heating.

When the Set Bake Time Runs Out:

- a. "END" will appear in the display window and the oven will shut-off automatically.
- b. The control will beep 3 times every 60 seconds until  is pressed.

To Change the Oven Temperature or Bake Time after Baking has Started:

1. Press the function pad you want to change.
2. Press the  or  to adjust the setting.

CAUTION Use caution with the Timed Bake and Delayed Start (Delayed Timed Bake) features. Foods that can easily spoil such as milk, eggs, fish, meat or poultry, should be chilled in the refrigerator first. Even when chilled, they should not stand in the oven for more than 1 hour before cooking begins, and should be removed promptly when cooking is completed.



Setting Oven Controls

Speed Bake™ Cooking System

Benefits of Speed Bake™ Cooking System:

- Foods cook up to 25 to 30% faster, saving time and energy.
- Multiple rack baking.
- No special pans or bakeware needed.

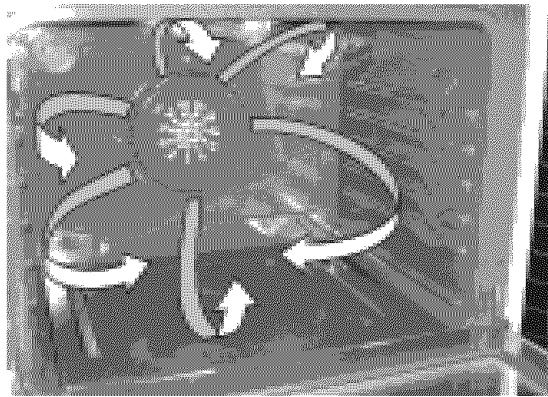
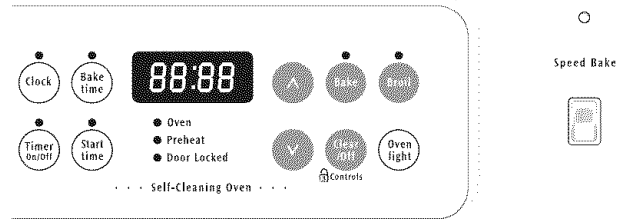

Fig. 1

How the Speed Bake™ Cooking System works (some models)

Speed Bake™ Cooking System uses a fan to circulate the oven's heat uniformly and continuously around the oven. This improved heat distribution allows for fast, even cooking and browning results. It also gives better baking results when using two racks at the same time (See Fig. 1).

Heated air flows around the food from all sides, sealing in juices and flavors. Meats cooked with **Speed Bake™ Cooking System** are juicier. Poultry is crisp on the outside while staying tender and moist on the inside. Breads and pastry brown more evenly. Most foods baked in a standard oven can be cooked faster and more evenly with **Speed Bake™ Cooking System**.

General Cooking Instructions:

For Baking:

1. For optimum cooking results it is recommended to preheat the oven when baking foods such as cookies, biscuits and breads.
 2. Reduce oven temperature 25° F from recipe's recommended oven temperature. Follow the remainder of the recipe's instructions using the minimum recommended cook time.
 3. When using 2 oven racks at the same time, place in oven rack positions 1 & 4 for best results (See Fig. 2)
- Note:** Layer cakes will have better results using the normal Bake feature.

For Roasting:

1. Preheating is not necessary when roasting foods with **Speed Bake™ Cooking System**.
 2. Since **Speed Bake™** cooks food faster, reduce the cook time by 25% from the recommended cook time of your recipe. Increase the time until the desired doneness is obtained.
- Note:** Cook time reductions will vary depending on the amount and type of food being cooked.

To Set Speed Bake™ Cooking System:

1. Program the oven as you normally would to bake. **Speed Bake™** may be used with Bake, Timed Bake and Delayed Time Bake features.
2. Press and release **Speed Bake™** switch. The indicator light located above the Speed Bake™ switch will glow and the fan will come on. The fan stays on when the oven door is closed and shuts off while the oven door is opened. The fan will continue to operate until cooking is complete.
3. To cancel **Speed Bake™**, press  on the oven control as you would to stop any baking function.

IMPORTANT NOTES: The Speed Bake™ fan will take 6 minutes to begin rotating once the Speed Bake™ switch has been turned ON. The Speed Bake™ feature will not activate during a Self-Clean cycle.

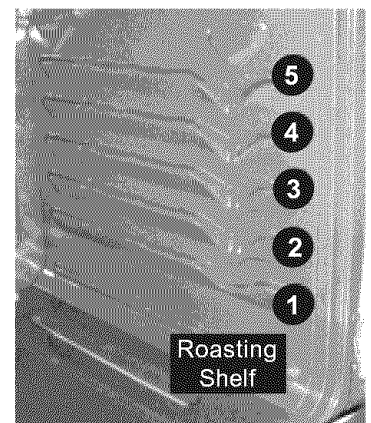







Fig. 2

Setting Oven Controls



To Set for Broiling:

1. Arrange the oven rack while oven is still cool. Position the rack as suggested in the **Broil Rack Position Table** below.
2. Press . " — " will appear in display.
3. Press and hold the  or  until the desired broil setting level appears in the display. Press the  for **HI** broil or the  for **LO** broil. Most foods may be broiled at the **HI** broil setting. Select the **LO** broil setting to avoid excess browning or drying of foods that should be cooked to the well-done stage.
4. **For optimum browning, preheat broil burner for 3 - 4 minutes before adding food.**
5. Place the insert on the broil pan (if equipped), then place the food on the insert (if equipped; See Fig. 1).
6. Place the broiler pan and insert on the oven rack (if equipped). **Close the oven door.**
7. Broil on one side until food is browned. Turn and broil food on 2nd side.
Note: Always pull the oven rack out to the stop position before turning or removing the food.
8. When broiling is finished press .

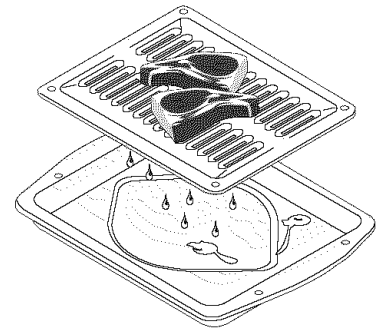

Fig.1 (some models)

Broil Rack Position Table (Refer to Fig. 2)



Rack Position from Top	Food category
5th rack position	Medium-well steaks & hamburgers
4th rack position	Fish, steaks & pork chops
3rd rack position	Well-done foods such as chicken & lobster

CAUTION To insure proper results when broiling use ONLY Electrolux Home Products, Inc. approved Broil Pan & Insert.

CAUTION Should an oven fire occur, close the oven door and turn the oven OFF. If the fire continues, use a fire extinguisher. **DO NOT** put water or flour on the fire. Flour may be explosive.

The broiler pan and the insert allows grease to drain and be kept away from the high heat of the broiler. **DO NOT** use the pan without the insert. **DO NOT** cover the insert with foil; the exposed grease could ignite. **DO NOT** use the broil pan without the insert or cover the insert with **aluminum foil**. The exposed fat could ignite.

To Operate the Interior Oven Lights

The interior oven lights will automatically turn ON when the oven door is opened. Press  to turn the interior oven lights ON or OFF whenever needed. The light for the **Bake-n-Warm™ Double Oven** may also be operated by pressing the same  pad.

The interior oven light is located at the upper left rear wall of the oven interior and is covered with a glass shield held by a wire holder. The glass shield must be in place whenever the oven is in use. To change the interior oven light, see "Changing the Oven Light" in the **General Care & Cleaning** section. See the **Bake-n-Warm™ Double Oven** section for instructions to change the lower oven light.

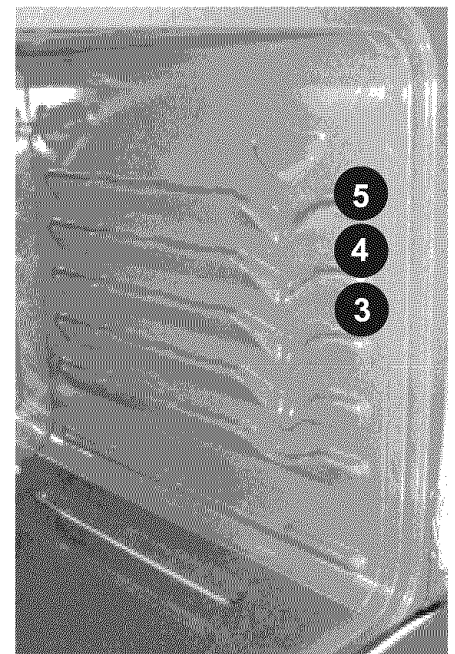

Fig. 2



Self-Cleaning

CAUTION During the Self-Cleaning cycle, the outside of the range can become very hot to the touch. **DO NOT** leave small children unattended near the appliance.

CAUTION The health of some birds is extremely sensitive to the fumes given off during the Self-Cleaning cycle of any range. Move birds to another well-ventilated room.

CAUTION **DO NOT** line the oven walls, racks, bottom or any other part of the range with **aluminum foil**. Doing so will destroy heat distribution, produce poor baking results and cause permanent damage to the oven interior (aluminum foil will melt to the interior surface of the oven).

CAUTION **DO NOT** force the oven door open. This can damage the automatic door locking system. Use caution when opening the door after the Self-Cleaning cycle is completed. The oven may still be **VERY HOT**.

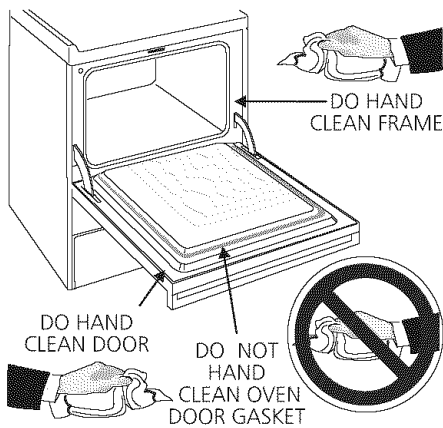

Note: See additional cleaning information for the oven door in the **General Care & Cleaning** section.



Self-Cleaning Oven

A Self-Cleaning oven cleans itself with high temperatures (well above cooking temperatures) which eliminate soils completely or reduces them to a fine powdered ash you can wipe away with a damp cloth.

Adhere to the following cleaning precautions:



- **DO NOT** use oven cleaners or oven protective coatings in or around any part of the Self-Cleaning oven.
- **DO NOT** clean the oven door gasket. The woven material of the oven door gasket is essential for a good seal. Care should be taken not to rub, damage or remove the gasket.
- **DO NOT** use any cleaning materials on the oven door gasket. Doing so could cause damage.
- **Remove the broiler pan and insert (some models), all utensils and any aluminum foil. These items cannot withstand high cleaning temperatures.**
- Remove the oven racks. If they are not removed during the Self-Clean cycle their color will turn slightly blue and the finish will be dull. After the cycle is complete and the oven has cooled, rub the sides of the oven racks with wax paper or a cloth containing a small amount of salad oil (this will make the racks glide easier into the rack position).
- **Remove any excessive spillovers** in the oven cavity **before** starting the Self-Cleaning cycle. To clean, use hot, soapy water and a cloth. Large spillovers can cause heavy smoke or fire when subjected to high temperatures. **DO NOT** allow food spills with a high sugar or acid content (such as milk, tomatoes, sauerkraut, fruit juices or pie filling) to remain on the surface as they may leave a dull spot even after cleaning.
- Clean any soil from the oven frame, the door liner outside the oven door gasket and the small area at the front center of the oven bottom. These areas heat sufficiently to burn soil on. Clean with soap and water.

NOTE: Prior to setting the Self-Clean cycle, any spills remaining on the oven bottom should be removed.

Self-Cleaning







Clean

Choose a Self-Clean Cycle Time

Determine which Self-Clean Cycle time as required. Your appliance comes with two choices:  (Speed Clean) for a 2 hour Self-Clean cycle (for lighter soils) or  (Clean) for a 3 hour cycle (for heavier soils). To set for Self-Clean follow the instructions provided below. **PLEASE NOTE:** The kitchen area should be well ventilated using an open window, ventilation fan or exhaust hood during the 1st Self-Clean cycle. This will help eliminate the normal odors associated with the 1st Self-Clean cycle.

To Set the Controls for a Self-Clean Cycle or a Delayed Start Self-Clean Cycle:

(Note: If you do not want to start a **Delayed** Self-Clean Cycle, skip steps 2 & 3.)

1. Be sure the clock shows the correct time of day.
2. Press . The " : " in the time of day will flash.
3. Press and hold the  pad to scroll to the time to start the delayed Self-Clean cycle. Release the pad when the desired time is displayed.
4. Press  (for 2 hour Self-Clean time) or  (for 3 hour Self-Clean time).
5. Press the  or  pad. The time selected in step 4 above should appear in the display.
As soon as the controls are set, the motor driven lock will begin to close automatically and the "DOOR LOCKED" indicator light will flash. **DO NOT** open the oven door while the light is flashing (it takes about 15 seconds for the oven door to lock).
6. "CLn" will appear in the display during the Self-Clean cycle and the "DOOR LOCKED" light will glow until the Self-Cleaning cycle is complete or cancelled and the oven temperature has cooled.

When the Self-Clean Cycle has Completed:

1. The time of day or "End" will appear in the display window and the "Clean" and "DOOR LOCKED" light will continue to glow.
2. Once the oven has cooled down for about 1 HOUR and the "DOOR LOCKED" light has gone out, the oven door can be opened.
3. If "End" is in the display and the Clean indicator light remains ON, press . The time of day will appear in the display.

NOTE: When the oven is cool, wipe away any residue or powdered ash with a damp cloth or paper towel.

Stopping or Interrupting a Self-Cleaning Cycle

If it becomes necessary to stop or interrupt a Self-Cleaning cycle:

1. Press .
2. Once the oven has cooled down for about 1 HOUR and the "DOOR LOCKED" light has gone out, the oven door can be opened.
3. Restart the Self-Clean cycle once all conditions have been corrected.

CAUTION To avoid possible burns use care when opening the oven door after the Self-Cleaning cycle. Stand to the side of the oven when opening the door to allow hot air or steam to escape.

CAUTION DO NOT force the oven door open. This can damage the automatic door locking system. Use caution and avoid possible burns when opening the door after the Self-Cleaning cycle has completed. The oven may still be VERY HOT.



General Care & Cleaning (Cleaning Table)

Surfaces	How to Clean
Glass, Painted Plastic Body Parts & Control Knobs	<i>For general cleaning</i> , use a soft cloth, clean with mild dish detergent & water or a 50/50 solution of vinegar & water. Follow by rinsing the area with clean water; dry & polish with a soft cloth. Glass cleaners may be used if sprayed on a soft cloth 1st. DO NOT spray liquids directly on the control pad and display areas. DO NOT use large amounts of water on the control panel - excess water on the control area may cause damage to the appliance. DO NOT use other liquid cleaners, abrasive cleaners, scouring pads, or some paper towels - they will damage the finish.
Painted Control Panels & Display areas	<i>Before cleaning the control panel</i> , turn all controls to OFF & remove the control knobs. To remove, pull each knob straight off the shaft. Use the <i>general cleaning</i> instructions provided in the paragraph above.
Porcelain Enamel Burner Grates, Cooktop Surface, Broiler Pan & Insert (some models), Door Liner, Oven Bottom & Bake-n-Warm™ Double Oven	Clean burner grates, broiler pan & insert in the dishwasher and dry upon removal. If soils are not removed, follow the cooktop cleaning instructions below. Gentle scouring with a soapy scouring pad will remove most spots. Rinse with a 1:1 solution of clean water & ammonia. <i>If necessary</i> , cover difficult spots with an ammonia-soaked paper towel for 30 to 40 minutes. Rinse with clean water and a damp cloth, then scrub with a soap-filled scouring pad. Rinse & wipe dry with a clean cloth. Remove all cleaners or the porcelain may become damaged during future heating. DO NOT use spray oven cleaners on the range.
Oven Racks	Remove racks. See "Removing & Replacing Oven Racks" under Before Setting Oven Controls . Use a mild, abrasive cleaner, following the cleaner's recommendations. Rinse with clean water & let dry. After cleaning the racks, rub the sides of the racks with wax paper or a cloth containing a small amount of salad oil (this will make the racks glide easier into the oven rack positions).
Oven Door	Use soap & water to thoroughly clean the top, sides & front of the oven door. Rinse well. You may use a glass cleaner on the outside glass of the oven door. DO NOT immerse the door in water. DO NOT spray or allow water or the glass cleaner to enter the door vents . DO NOT use oven cleaners, cleaning powders or any harsh abrasive cleaning materials on the outside of the oven door. DO NOT clean the oven door gasket. The oven door gasket is made of a woven material, on Self-Cleaning models, which is essential for a good seal. Care should be taken not to rub, damage or remove this gasket.
Easy Care™ Stainless Steel (some models)	Your range finish is may be made with Easy Care™ Stainless Steel (some models). Clean the stainless with warm soapy water using a clean sponge or cloth. Rinse with clean water and dry with a soft clean cloth. DO NOT use ANY store bought cleaners like Stainless Steel cleaners or any other types of cleaners containing any abrasive, chlorides, chlorines or ammonia. It is recommended to use mild dish soap and water or a 50/50 solution of water and vinegar.
Gas Cooktop and Surface Burners	The cooktop is designed to make cleaning easier. Because the burners are sealed, cleanups are easy when spillovers are cleaned up immediately. To clean, wipe with a clean, damp cloth and wipe dry. For more information about cleaning the gas burners see Cleaning the Contoured Cooktop Well Areas, Burner Cap, Burner Head and Burner Drip Pans in the General Care & Cleaning section.

Cleaning the Cooktop

The cooktop is designed to make cleaning easier. Because the burners are sealed, cleanups are easy when spillovers are cleaned up immediately. To clean, wipe with a clean, damp cloth and wipe dry.

THE COOKTOP IS NOT REMOVABLE. Do not attempt to remove or lift the cooktop.

⚠ CAUTION Use caution when replacing the burner cap so the electrode is not damaged. This may cause a delayed ignition or prevent the burner from igniting.

General Care & Cleaning

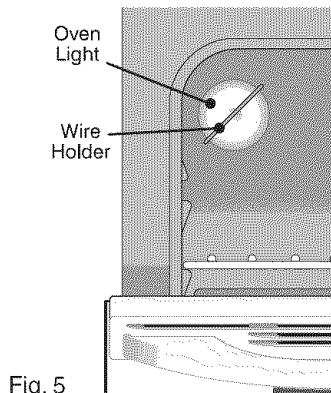
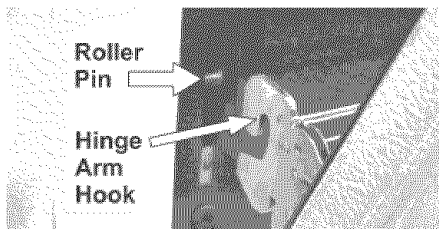
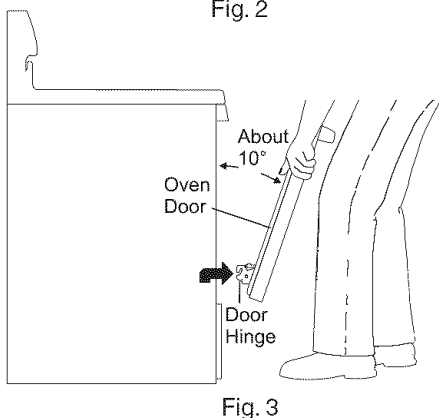
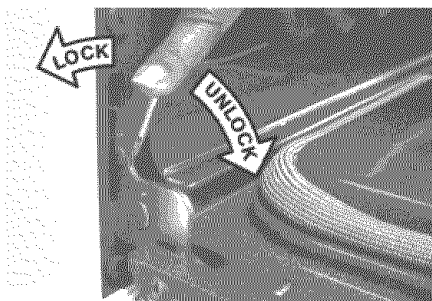
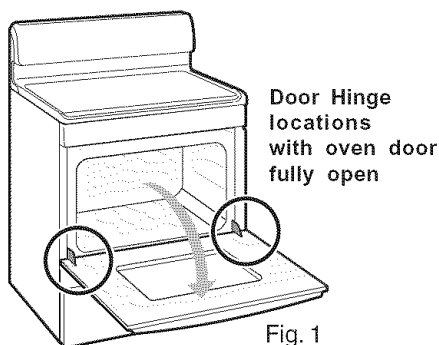

Removing and Replacing the Lift-Off Oven Door

CAUTION The door is heavy. For safe, temporary storage, lay the door flat with the inside of the door facing down.

To Remove Oven Door:

1. Open oven door completely (horizontal with floor - See Fig. 1).
2. Pull the door hinge locks on both left and right door hinges down from the oven frame completely towards the oven door (See Fig. 2). A tool such as a small flat-blade screwdriver may be required.
3. Firmly grasp both sides of oven door along the door sides (Do not use the oven door handle - See Fig. 3).
4. Close the door to the broil stop position (the oven door will stop into this position just before fully closing).
5. With the oven door in the broil stop position, lift the oven door hinge arms over the roller pins located on each side of the oven frame (See Fig. 4).

To Replace Oven Door:

1. Firmly grasp both sides of oven door along the door sides (Do not use the oven door handle - See Fig. 3).
2. Holding the oven door at the same angle as the removal position, seat the hook of the hinge arm over the roller pins located on each side of the oven door frame (See Fig. 4). The hook of the hinge arms must be fully seated onto the roller pins.
3. Fully open the oven door (horizontal with floor - See Fig. 1).
4. Push the door hinge locks up towards and into the oven frame on both left and right oven door hinges (See Fig. 2) to the locked position.
5. Close the oven door.

Special Door Care Instructions - Most oven doors contain glass that can break. Read the following recommendations:

1. Do not close the oven door until all the oven racks are fully in place.
2. Do not hit the glass with pots, pans, or any other object.
3. Scratching, hitting, jarring or stressing the glass may weaken its structure causing an increased risk of breakage at a later time.

Changing the Oven Light (some models)

For models equipped with the interior oven light, the light bulb is located at the rear of the oven and is covered with a glass shield held by a wire holder (See Fig. 5). The glass shield must be in place whenever the oven is in use.

To replace the oven light bulb:

1. Turn electrical power off at the main source or unplug the range.
2. Press wire holder to one side to release the glass shield.
3. Replace bulb with a new 40 watt appliance bulb.
4. Replace glass shield over bulb and snap wire holder into place.
5. Turn power back on again at the main source (or plug the range back in).
6. The clock will then need to be reset. To reset, see **Setting the Clock and Minute Timer** in this Use & Care Guide.

CAUTION Be sure the range is unplugged and all parts are COOL before replacing oven light. Wear a leather-faced glove for protection against possible broken glass.



General Care & Cleaning

Cleaning the Contoured Well Areas, Burner Cap, Burner Head and Burner Drip Pans (some models)

The contoured well areas, burner cap, burner head and burner drip pans (some models) should be routinely cleaned. Keeping the burner ports clean will prevent improper ignition and an uneven flame. Refer to the following instructions:

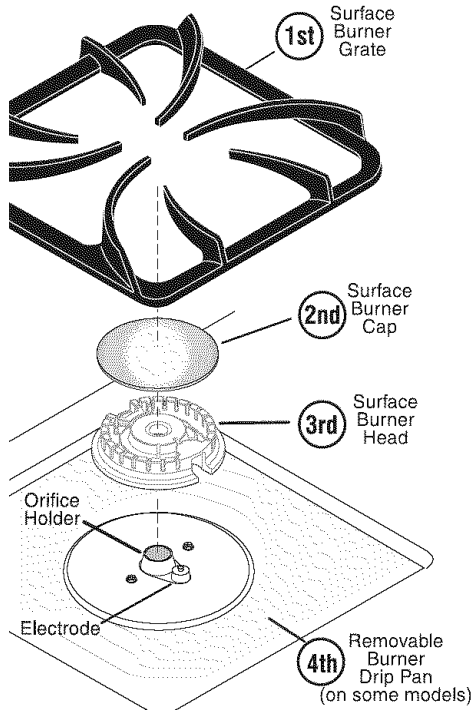

Note: The burner grate style shown above may be a different depending on your model.

To Clean the Recessed and Contoured Areas of the Cooktop - If a spill occurs on or in the recessed or contoured areas, blot up spill with an absorbent cloth. Rinse with a clean, damp cloth and wipe dry.

To Remove and Replace the Surface Burner Caps and Surface Burner Heads - Remove in the following order: (1st) surface burner grate, (2nd) surface burner cap, (3rd) surface burner head and (4th) surface burner drip pan (if equipped).

Reverse the procedure above to replace the surface burner cap, surface burner head and surface burner drip pans (if equipped). **Do not remove any parts from the cooktop until they have completely cooled and are safe to handle. Do not operate the surface burners without the surface burner cap and surface burner head properly in place.**

To Clean the Surface Burner Cap, Surface Burner Head and Surface Burner Drip Pan (if equipped) - Use a soap-filled scouring pad or a mild abrasive cleanser to clean the surface burner caps, surface burner heads and surface burner drip pans (if equipped). The ports (or slots) around the burner head must be routinely cleaned. If residue still remains in these ports, use a small-gauge wire or needle to clean the slots or holes. For proper flow of gas and ignition of the burner—**DO NOT ALLOW SPILLS, FOOD, CLEANING AGENTS OR ANY OTHER MATERIAL TO ENTER THE GAS ORIFICE HOLDER OPENING. ALWAYS** keep the surface burner cap and surface burner head in place whenever a surface burner is in use.



Adjusting Your Oven Temperature

Your oven control has been precisely set at the factory. This setting may differ from your previous oven however, so your recipe times may not give you the results you expect. If you think that the oven is cooking too hot or too cool for your recipe times, you can adjust the control so that the oven cooks hotter or cooler than the temperature displayed.

To Adjust Oven Temperature:

1. Press **Bake**.
2. Set the temperature to 550°F (287°C) by pressing and holding the **▲**.
3. Within 2 seconds, press and hold **Bake** until the 2 digit display appears. Release **Bake**. The display now indicates the amount of degrees offset between the original factory temperature setting and the current temperature setting. If the oven control has the original factory calibration, the display will read "0."
4. The temperature can now be adjusted up or down 35°F (17°C), in 5°F steps by pressing and holding the **▲** or **▼**. Adjust until the desired amount of offset appears in the display. When lowering the oven temperature, a minus sign (-) will appear before the number to indicate that the oven will be cooler by the displayed amount of degrees.
5. When you have made the desired adjustment, press **Clear/Off** to go back to the time of day display.

Note: Oven temperature adjustments made will not change the Self-Cleaning feature temperature.

Before You Call

Solutions to Common Problems

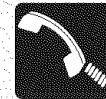

Before you call for service, review the following list. It may save you time & expense. The list includes common occurrences (shown in bold) that are not the result of defective workmanship or materials in this appliance. The possible corrections to these problems are provided with the problem listed:

Range is not level - (1) Poor installation. Place oven rack in center of oven. Place a level on the oven rack. Adjust leveling legs at base of range until the oven rack is level. (2) Be sure floor is level, strong & stable enough to adequately support range. (3) If floor is sagging or sloping, contact a carpenter to correct the situation. (4) Kitchen cabinet alignment may make range appear not level. Be sure cabinets are square & have sufficient room for range clearance.

Cannot move appliance easily. Appliance must be accessible for service - (1) Cabinets not square or are built in too tightly. Contact builder or installer to make appliance accessible. (2) Carpet interferes with range. Provide sufficient space so range can be lifted over carpet.

Surface burners do not light - (1) Surface control knob has not been completely turned to LITE. Push in & turn the surface control knob to LITE until burner ignites & then turn control knob to desired flame size. (2) Burner ports are clogged. With the burner OFF, use a small-gauge wire or needle to clean ports. See **Cleaning the Contoured Well Areas, Burner Cap, Burner Head & Burner Drip Pans** in the General Care & Cleaning section for complete cleaning instructions. (3) Range power cord is disconnected from outlet (electric ignition models only). Be sure cord is securely plugged into the outlet. (4) Electrical power outage (electric ignition models only). Burners can be lit manually. See Setting Surface Controls.

Surface burner flame burns half way around - (1) Burner ports are clogged. With the burner off, clean ports by using a small-gauge wire or needle. (2) Moisture is present after cleaning. Lightly fan the flame and allow burner to operate until flame is full. Dry the burners thoroughly following instructions in the **Cleaning the Contoured Well Areas, Burner Cap, Burner Head & Burner Drip Pans** in the General Care & Cleaning section.

Surface burner flame is orange - (1) Dust particles in main line. Allow the burner to operate a few minutes until flame turns blue. (2) In coastal areas, a slightly orange flame is unavoidable due to salt air.

Oven does not operate - (1) Be sure the oven controls are set properly for the desired function. See **Setting Oven Controls** in this Use & Care Manual or read the instructions "**Entire appliance does not operate**" in this checklist. (2) Be sure gas regulator valve is "ON". See installation instructions.

Entire appliance does not operate - (1) The time of day is not set. The time of day **must** first be set in order to operate the oven. See "To Set the Clock" in the **Setting Oven Controls** section. (2) Make sure cord/plug is plugged correctly into outlet. (3) Service wiring is not complete. Contact your authorized service agent. (4) Electrical power outage. Check house lights to be sure. Call your local electric company for service. (5) Be sure gas supply is turned ON.

Oven light does not work (some models) - Replace or tighten bulb. See **Changing Oven Light** section in this Use & Care Manual.

Oven control beeps & displays any F code error (for example F11) - Electronic control has detected a fault condition. Press **CLEAR/OFF** to clear the display & stop beeping. Reprogram oven. If fault recurs, record fault number. Press **CLEAR/OFF** & contact an authorized service agent.

Poor baking results - Many factors affect baking results. Make sure the proper oven rack position is used. Center food in the oven & space pans to allow air to circulate. Allow the oven to preheat to the set temperature before placing food in the oven. Try adjusting the recipe's recommended temperature or baking time. If you feel the oven is too hot or cool, see **Adjusting Your Oven Temperature** in this Use & Care Manual.

Oven smokes excessively during broiling - (1) Control(s) not set properly. Follow Broil instructions under **Setting Oven Controls**. (2) Oven door is open. Make sure oven door is **closed**. (3) Meat too close to the broil element. Reposition the broil rack to provide proper clearance between the meat & the element. Preheat the broil element for searing. (4) Meat not properly prepared. Remove excess fat from meat. Cut fatty edges to prevent curling, but do not cut into lean. (5) Insert on broiler pan wrong side up & grease not draining. Always place grid on the broiler pan with ribs up & slots down to allow grease to drip into pan (some models). (6) Grease has built up on oven surfaces or broiler pan & insert (some models). Regular cleaning is necessary when broiling frequently. Old grease or food spatters cause excessive smoking.

Self-Cleaning cycle does not work - (1) Oven control not set properly. Follow instructions under **Self-Cleaning**. (2) Self-Cleaning cycle was interrupted. Follow steps under "Stopping or Interrupting a Self-Cleaning Cycle" under **Self-Cleaning**.

Soil not completely removed after Self-Cleaning cycle - Failure to clean bottom, front top of oven, frame of oven or door area outside oven seal. These areas are not in the Self-Cleaning area, but get hot enough to burn on residue. Clean these areas before the Self-Cleaning cycle is started. Burned-on residue can be cleaned with a stiff nylon brush and water or a nylon scrubber. Be careful not to damage the oven gasket.

Flames inside oven or smoking from oven vent - Excessive spillovers in oven. For example this will happen for pie spillovers or large amounts of grease left on the oven bottom. Wipe up excessive spillovers before starting oven. If flames or excessive smoke are present see "Broiling" in the **Setting Oven Controls** section.



Major Appliance Warranty Information

Your appliance is covered by a one year limited warranty. For one year from your original date of purchase, Electrolux will pay all costs for repairing or replacing any parts of this appliance that prove to be defective in materials or workmanship when such appliance is installed, used and maintained in accordance with the provided instructions.

Exclusions **This warranty does not cover the following:**

1. Products with original serial numbers that have been removed, altered or cannot be readily determined.
2. Product that has been transferred from its original owner to another party or removed outside the USA or Canada.
3. Rust on the interior or exterior of the unit.
4. Products purchased "as-is" are not covered by this warranty.
5. Food loss due to any refrigerator or freezer failures.
6. Products used in a commercial setting.
7. Service calls which do not involve malfunction or defects in materials or workmanship, or for appliances not in ordinary household use or used other than in accordance with the provided instructions.
8. Service calls to correct the installation of your appliance or to instruct you how to use your appliance.
9. Expenses for making the appliance accessible for servicing, such as removal of trim, cupboards, shelves, etc., which are not a part of the appliance when it is shipped from the factory.
10. Service calls to repair or replace appliance light bulbs, air filters, water filters, other consumables, or knobs, handles, or other cosmetic parts.
11. Surcharges including, but not limited to, any after hour, weekend, or holiday service calls, tolls, ferry trip charges, or mileage expense for service calls to remote areas, including the state of Alaska.
12. Damages to the finish of appliance or home incurred during installation, including but not limited to floors, cabinets, walls, etc.
13. Damages caused by: services performed by unauthorized service companies; use of parts other than genuine Electrolux parts or parts obtained from persons other than authorized service companies; or external causes such as abuse, misuse, inadequate power supply, accidents, fires, or acts of God.

DISCLAIMER OF IMPLIED WARRANTIES; LIMITATION OF REMEDIES

CUSTOMER'S SOLE AND EXCLUSIVE REMEDY UNDER THIS LIMITED WARRANTY SHALL BE PRODUCT REPAIR OR REPLACEMENT AS PROVIDED HEREIN. CLAIMS BASED ON IMPLIED WARRANTIES, INCLUDING WARRANTIES OF MERCHANTABILITY OR FITNESS FOR A PARTICULAR PURPOSE, ARE LIMITED TO ONE YEAR OR THE SHORTEST PERIOD ALLOWED BY LAW, BUT NOT LESS THAN ONE YEAR. ELECTROLUX SHALL NOT BE LIABLE FOR CONSEQUENTIAL OR INCIDENTAL DAMAGES SUCH AS PROPERTY DAMAGE AND INCIDENTAL EXPENSES RESULTING FROM ANY BREACH OF THIS WRITTEN LIMITED WARRANTY OR ANY IMPLIED WARRANTY. SOME STATES AND PROVINCES DO NOT ALLOW THE EXCLUSION OR LIMITATION OF INCIDENTAL OR CONSEQUENTIAL DAMAGES, OR LIMITATIONS ON THE DURATION OF IMPLIED WARRANTIES, SO THESE LIMITATIONS OR EXCLUSIONS MAY NOT APPLY TO YOU. THIS WRITTEN WARRANTY GIVES YOU SPECIFIC LEGAL RIGHTS. YOU MAY ALSO HAVE OTHER RIGHTS THAT VARY FROM STATE TO STATE.

If You Need Service

Keep your receipt, delivery slip, or some other appropriate payment record to establish the warranty period should service be required. If service is performed, it is in your best interest to obtain and keep all receipts. Service under this warranty must be obtained by contacting Electrolux at the addresses or phone numbers below.

This warranty only applies in the USA and Canada. In the USA, your appliance is warranted by Electrolux Major Appliances North America, a division of Electrolux Home Products, Inc. In Canada, your appliance is warranted by Electrolux Canada Corp. Electrolux authorizes no person to change or add to any obligations under this warranty. Obligations for service and parts under this warranty must be performed by Electrolux or an authorized service company. Product features or specifications as described or illustrated are subject to change without notice.

USA
1.800.944.9044
Electrolux Major Appliances
North America
P.O. Box 212378
Augusta, GA 30907



Canada
1.800.668.4606
Electrolux Canada Corp.
5855 Terry Fox Way
Mississauga, Ontario, Canada
L5V 3E4