



Use and Care Guide

Electric Slide-in Range



Safety instructions3-6

Anti-Tip Device3



Operating Instructions, Tips

Aluminum Foil.....4, 20, 23

Clock and Timer 10, 11

Features8, 9

Oven..... 15-24

Baking 17-20

 Broiling, Broiling Guide23, 24

 Fan....., 16, 17,21,23,25

 Light; Bulb Replacement 16, 30

 Preheating 19

 Roasting, Roasting Guide21, 22

 Self-Cleaning Oven.....25-27

 Shelves 16, 19

 Thermostat Adjustment 16

 Timed Baking 17, 18

Surface Cooking 12-14

 Control Settings 12

 Cooking Tips 13

 Home Canning Tips 14

 Hot Surface Light..... 10



Installation.....7

Installing.....7

Leveling.....7



Problem Solver33, 34

More questions ?...call

GE Answer Center® 800.626.2000



Care and Cleaning.....27-32

Anti-Tip Device32

Glass Ceramic Cooktop31

Door Removal29

Storage Drawer30



Consumer Services35

Appliance Registration2

Important Phone Numbers35

Model and Serial Number Location2

WarrantyBack Cover



HELP US HELP YOU

Before using your range, read this book carefully.

It is **intended** to help you operate and maintain your new range properly.

Keep it handy for answers to your questions.

If you don't understand something or need more help, write (include your phone number):

Consumer Affairs
GE Appliances
Appliance Park
Louisville, KY 40225

Write down the model and serial numbers.

You'll find them on a label behind the storage drawer.

These numbers are also on the Consumer Product Ownership Registration Card that came with your range. Before sending in this card, please write these numbers here:

Model Number

Serial Number

Use these numbers in any correspondence or service calls concerning your range.

If you received a damaged range...

Immediately contact the dealer (or builder) that sold you the range.

Save time and money. Before you request service . . .

Check the Problem Solver in the back of this book. It lists causes of minor operating problems that you can correct yourself.

IF YOU NEED SERVICE...

To obtain service, see the Consumer Services page in the back of this book.

We're proud of our service and want you to be pleased. If for some reason you are not happy with the service you receive, here are 3 steps to follow for further help.

FIRST, contact the people who serviced your appliance. Explain why you are not pleased. In most cases, this will solve the problem.

NEXT, if you are still not pleased, write all the details—including your phone number—to:

Manager, Consumer Relations
GE Appliances
Appliance Park
Louisville, KY 40225

FINALLY, if your problem is still not resolved, write:

Major Appliance Consumer
Action Panel
20 North Wacker Drive
Chicago, IL 60606



IMPORTANT SAFETY INSTRUCTIONS

Read all instructions before using this appliance.

IMPORTANT SAFETY NOTICE

- **The California Safe Drinking Water and Toxic Enforcement Act** requires the Governor of California to publish a list of substances known to the state to cause cancer, birth defects or other reproductive harm, and requires businesses to warn customers of potential exposure to such substances.
- **The fiberglass insulation in self-clean ovens gives off a very small amount of carbon monoxide during the cleaning cycle.** Exposure can be minimized by venting with an open window or using a ventilation fan or hood.

When You Get Your Range

When using electrical appliances, basic safety precautions should be followed, including the following:

- **Have the installer show you the location of the circuit breaker or fuse.** Mark it for easy reference.
- **Be sure your appliance is properly installed and grounded** by a qualified technician in accordance with the provided Installation Instructions.
- **Use this appliance only for its intended use as described in this manual.**
- **Do not attempt to repair or replace any part of your range unless it is specifically recommended in this book.** All other servicing should be referred to a qualified technician.
- **Before performing any service, DISCONNECT THE RANGE POWER SUPPLY AT THE HOUSEHOLD DISTRIBUTION PANEL BY REMOVING THE FUSE OR SWITCHING OFF THE CIRCUIT BREAKER.**

⚠ WARNING—

All ranges can tip and injury could result. To prevent accidental tipping of the range from abnormal usage, including excess loading of the oven door, attach it to the wall or floor by installing the Anti-Tip device supplied. Make sure the chain fits securely into the slot in the bracket.

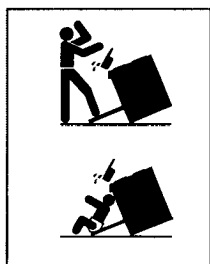

If you pull the range out from the wall for any reason, make sure the device is properly engaged before you push the range back. Please refer to the Anti-Tip device information in this book. Failure to take this precaution could result in tipping of the range and injury.

- **Do not leave children alone—children should not be left alone or unattended in an area where an appliance is in use.** They should never be allowed to sit or stand on any part of the appliance.
- **Do not allow anyone to climb, stand or hang on the door, drawer or cooktop. They could damage the range and even tip it over, causing severe personal injury.**
- **CAUTION: ITEMS OF INTEREST TO CHILDREN SHOULD NOT BE STORED IN CABINETS ABOVE A RANGE OR ON THE BACKSPASH OF A RANGE—CHILDREN CLIMBING ON THE RANGE TO REACH ITEMS COULD BE SERIOUSLY INJURED.**
- **Teach children not to play with the controls or any other part of the range.**
- **Never leave the oven door open when you are not watching the range.**
- **Always keep combustible wall coverings, curtains or drapes a safe distance from your range.**

- **Never wear loose-fitting or hanging garments while using the appliance.** Flammable material could be ignited if brought in contact with the hot glass surface over the cooktop surface units and may cause severe burns.



- **Use only dry pot holders—** moist or damp pot holders on hot surfaces may result in burns from steam. Do not let pot holders touch hot surface units. Do not use a towel or other bulky cloth in place of a pot holder. Such cloths can catch fire on a hot burner.
- **For your safety, never use your appliance for warming or heating the room.**

(continued next page)



IMPORTANT SAFETY INSTRUCTIONS

(continued)

- Always keep dish towels, dish cloths, potholders and other linens a safe distance from your range.
- Always keep wooden and plastic utensils and canned food a safe distance away from your range.
- **DO NOT STORE OR USE COMBUSTIBLE MATERIALS, GASOLINE OR OTHER FLAMMABLE VAPORS AND LIQUIDS IN THE VICINITY OF THIS OR ANY OTHER APPLIANCE.**
- Do not let cooking grease or other flammable materials accumulate in or near the range.



- Do not use water on grease fires.

Never pick up a flaming pan.

Smother flaming pan on surface unit by covering pan completely with well-fitting lid, cookie sheet or flat tray or, if available, a multi-purpose dry chemical or foam-type fire extinguisher.

Flaming grease outside a pan can be put out by covering with baking soda, or if available, a multi-purpose dry chemical or foam-type extinguisher.

Flame in oven can be smothered completely by closing the oven door and pressing the CLEAR/OFF pad or use a dry chemical or foam-type extinguisher.

- **Do not cook on a broken glass cooktop.** Spillovers or cleaning solution may penetrate a broken cooktop and create a risk of electrical shock. Contact a qualified technician immediately should your cooktop become broken.
- **Use care when touching the cooktop.** The glass surface of the cooktop will retain heat after the controls have been turned off.
- **Do not touch surface units.** These surfaces may be hot enough to burn even though they are dark in color. During and after use, do not touch, or let clothing or other flammable materials contact surface units or areas nearby surface units; allow sufficient time for cooling, first.

Potentially hot surfaces include the cooktop and areas facing the cooktop.

- **When cooking pork,** follow the directions exactly and always cook the meat to an internal temperature of at least 170°F. This assures that, in the remote possibility that trichina may be present in the meat, it will be killed and the meat will be safe to eat.

Oven

- Stand away from the range when opening the oven door. Hot air or steam, which escapes, can cause burns to hands, face and/or eyes.
- Do not heat unopened food containers. Pressure could build up, and the container could burst, causing an injury.



- **Keep the oven vent duct unobstructed.**

- **Keep the oven free from grease buildup.**

- **Place the oven shelf in the desired position while the oven is cool.** If the shelves must be handled when hot, do not let pot holder contact heating elements in the oven.
- **Pulling out the shelf to the shelf stop is a convenience in lifting heavy foods. It is also a precaution against burns from touching hot surfaces of the door or oven walls.**
- **Do not use aluminum foil to line the oven bottom or the cooktop, except as suggested in manual.** Improper installation of these liners may result in electric shock or fire.
- **When using cooking or roasting bags in oven,** follow the manufacturer's directions.
- **Do not use your oven to dry newspapers.** If overheated, they can catch fire.
- **Be sure the vent duct is not covered and is in place.** Its absence during cooking could damage range parts and wiring.



Do not touch the cooktop or the interior surfaces of oven. These surfaces may be hot enough to burn even though they are dark in color. During and after use, do not touch, or let clothing or other flammable materials contact areas nearby cooktop or any interior area of oven; allow sufficient time for cooling first.

Potentially hot surfaces include: the cooktop and areas facing the cooktop, the oven vent openings, surfaces near the opening, crevices around the oven door, the edges of the door window and metal trim parts above the door.

Remember: The inside surface of the oven may be hot when the door is opened.

- **Do not leave paper products, cooking utensils, or food in the oven when not in use.** Do not store flammable materials in an oven or near the cooktop.
- **After broiling, always take the broiler pan out of the range and clean it.** Leftover grease in the broiler pan can catch fire next time you use the pan.
- **Never leave jars or cans of fat drippings on or near your range.**

Self-Cleaning Oven

- **Do not clean the door gasket.** The door gasket is essential for a good seal. Care should be taken not to rub, damage or move the gasket.
- **Do not use oven cleaners.** No commercial oven cleaner or oven liner protective coating of any kind should be used in or around any part of the oven. Residue from oven cleaners will damage the inside of the oven when the self-clean cycle is used.
- **Clean only parts listed in this Use and Care Book.**
- **Before self-cleaning the oven,** remove broiler pan, shelves and other cookware.
- **Be sure to wipe up excess spillage before starting the Self-Cleaning operation.**
- **If the self-cleaning mode malfunctions,** press the CLEAR/OFF pad and disconnect the power supply. Have serviced by a qualified technician.

Radiant Cooktop and Radiant Surface Units

- **Use proper pan size—**This appliance has 4 surface units. The left rear surface unit has both a 6-inch and a 9-inch surface unit. Select cookware having flat bottoms large enough to cover the selected surface unit. The use of undersized cookware will expose portions of hot surface units and may result in ignition of pot holders or clothing. Proper relationship of cookware to surface units will also improve efficiency.
- **Do not operate the surface units if the glass is broken.** Spillovers or cleaning solution may penetrate a broken cooktop and create a risk of electrical shock. Contact a qualified technician immediately should your glass cooktop become broken.
- **Avoid scratching the glass cooktop surface** with sharp instruments, or with rings or other jewelry.
- **Never use the glass cooktop surface as a cutting board.**
- **Do not place or store items on top of the glass cooktop surface when it is not in use.**
- **Do not place any spoons or other stirring utensils on glass cooktop surface** when it is in use. They may become hot and could cause burns.
- **Only certain types of glass, glass/ceramic, earthenware or other glazed containers are suitable for cooktop service;** others may break because of the sudden change in temperature.
- **Use proper cookware for cooking on the cooktop surface units.** See the Surface Cooking section of this book.
- **Avoid heating an empty pan.** Doing so may damage the cooktop and the pan.
- **Keep the bottom of the pan and the surface of the cooktop clean and dry.** Wipe the cooktop before and after use to avoid scratches from dust and grit.
- **As the cooking pan gets hot, it transmits heat to the glass cooktop surface.** Do not place plastic materials on the surface. They may melt or warp. Do not touch the surface until it has cooled.

(continued on next page)



IMPORTANT SAFETY INSTRUCTIONS

(continued)

- **To minimize the possibility of burns, ignition of flammable materials and spillage, the handle of a container should be turned toward the center of the cooktop without extending over nearby surface units.**
- **Always turn the surface unit controls to OFF position before removing cookware.**
- **Never leave the surface units unattended at high heat settings.** Boilovers cause smoking and greasy spillovers that may catch fire.
- **Keep an eye on foods being fried at high or medium high heat settings.**
- **Foods for frying should be as dry as possible.** Frost on frozen foods or moisture on fresh foods can cause hot fat to bubble up and over sides of pan,
- **Use little fat for effective shallow or deep-fat frying.** Filling the pan too full of fat can cause spillovers when food is added.
- **If a combination of oils or fats will be used in frying, stir together before heating, or as fats melt slowly.**
- **Always heat fat slowly, and watch as it heats.**
- **Use a deep fat thermometer whenever possible** to prevent overheating fat beyond the smoking point.
- **Never try to move a pan of hot fat, especially a deep fat fryer.** Wait until the fat is cool.
- **When flaming foods are under the hood, turn the fan off.** The fan, if operating, may spread the flame.
- **Hot foods and steam can cause burns.** Be careful when opening any containers of hot food, including popcorn bags, cooking pouches and boxes. To prevent possible injury, direct steam away from hands and face.
- **NEVER USE WATER ON A GREASE FIRE.**

Cleaning

- **To minimize the possibility of burns, always be certain that the controls for all surface units are at OFF position and the entire glass surface is cool before attempting to clean the cooktop.**
- **Clean only parts listed in this book.**
- **Keep the cooktop clean and free of accumulations of grease or spillovers which may ignite.**
- **When not in use, make sure the surface unit controls are set to OFF position** to prevent the cooktop from being activated accidentally.
- **Never clean cooktop surface when it is hot.** Some cleaners produce noxious fumes and wet cloths could cause steam burns if used on a hot surface.
- **Do not allow water, other liquids or grease to remain on the cooktop or control panel.**
- **Clean all cooking surfaces with caution.**

**SAVE THESE
INSTRUCTIONS**

INSTALLING AND LEVELING



Installing

Your range, like many other household items, is heavy and can settle into soft floor coverings such as cushioned vinyl or carpeting. When moving the range on this type of flooring, use care, and it is recommended that these simple and inexpensive instructions be followed.

The range should be installed on a 1/4-inch thick sheet of plywood (or similar material) as follows: **When the floor covering ends at the front of the range**, the area the range will rest on should be built up with plywood to the same level or higher than the floor covering. This will allow the range to be moved for cleaning or servicing. See the complete installation instruction booklet included with the range for full details.

Leveling

Use a 1 1/8" open end or adjustable wrench to equally back out the 4 legs. The flanges (rims) below the sides of the cooktop must be raised above the top of the countertop. Carefully slide the range into its installation space. Observe that it is clearing the countertop. Then place a spirit level or a glass measuring cup partially filled with water on 1 of the oven shelves to check for levelness. If using a spirit level, take 2 readings, with the level placed diagonally first in 1 direction and then the other.

Adjust the 4 legs carefully. Level the range front to back and side to side. The range legs must rest on the floor. The range must not hang from the countertop.



FEATURES OF YOUR RANGE

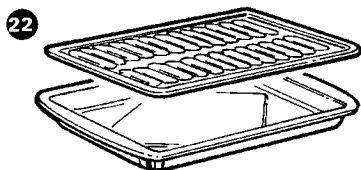
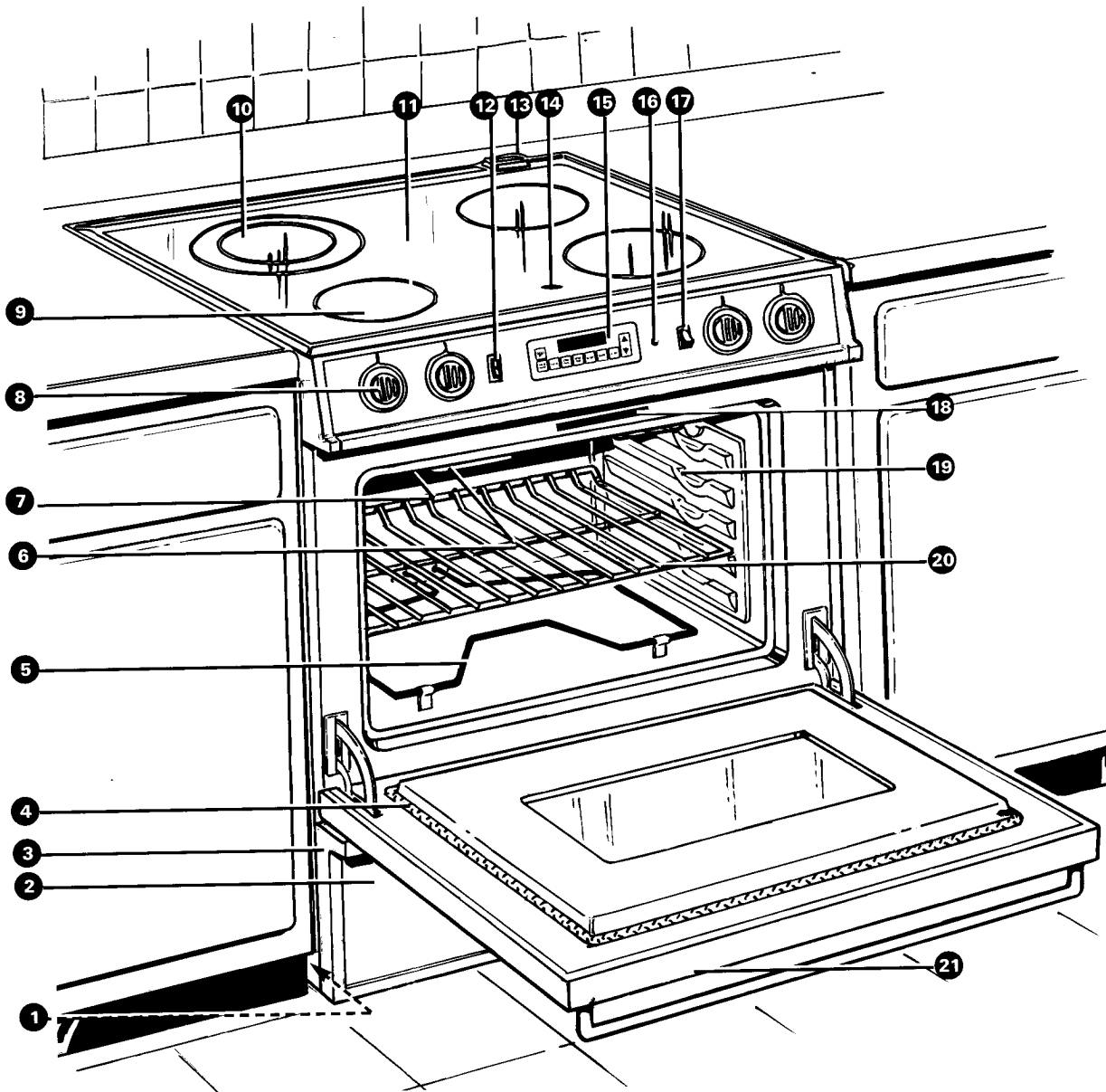

Models JSP38GP
JSP38GS
JSP39GR
JSP40AS

FEATURES OF YOUR RANGE



Features Index	Explained on page
1 Anti-Tip Device See the Installation Instructions.	3,32
2 Storage Drawer	30
3 Model and Serial Numbers	2
4 Oven Door Gasket	5,25,29
5 Bake Element Maybe lifted gently for wiping oven floor.	29
6 Broil Element	21,29
7 Oven Interior Light	16,30
8 Control Knobs for Surface Units	12,28
9 Surface Units	5, 12
10 Dual-Size Surface Units one 6 inch or 9 inch diameter	12
11 Glass Ceramic Cooktop	4,6, 13,31
12 Selector Switch For left rear surface unit.	12

Features Index	Explained on page
13 Oven Vent May get hot during oven use.	4,30
14 Hot Cooktop Indicator Light	12
15 Oven Controls, Clock & Timer	10, 11,28
16 Master Indicator Light	12
17 Oven Light Switch	16
18 Automatic Oven Door Latch	25-27
19 Oven Shelf Supports Shelf positions for cooking are suggested in the Baking, Roasting and Broiling sections.	16
20 Oven Shelves with Stop-locks	4, 15, 19 25,29
21 Removable Oven Door with Broil Stop Position Easily removed for cleaning.	23,25,29
22 Broil Pan and Rack Do not clean in the Self-Clean oven.	5,21,23 24,28



FEATURES OF YOUR OVEN CONTROL

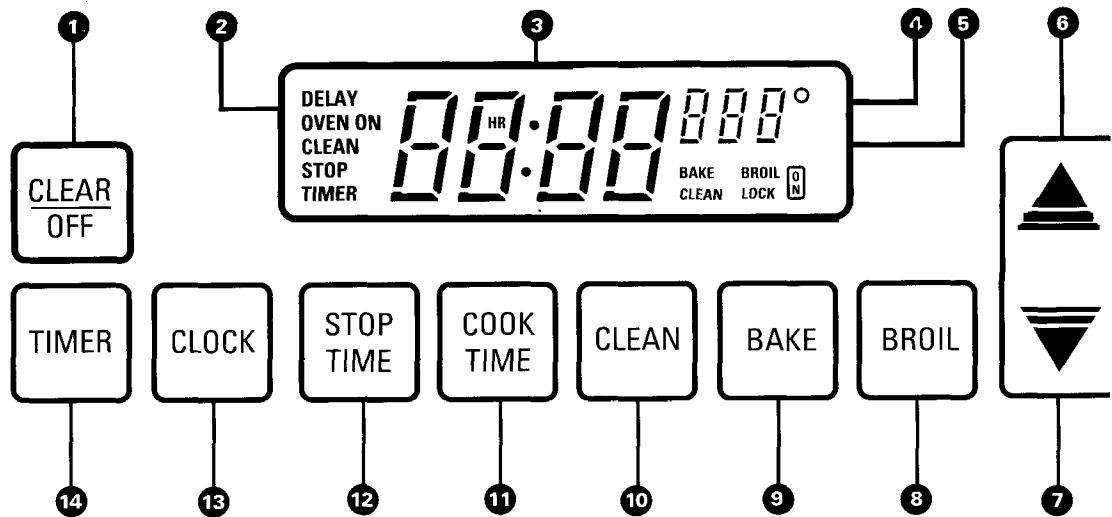

1. CLEAR/OFF. Press this pad to cancel **all** oven operations except clock and timer.

2. PROGRAM STATUS. Words light up in the display to indicate what is in time display.

Programmed information can be displayed at any time by pressing the pad of the operation you want to see. For example, you can display the current time of day while the timer is counting down by pressing the **CLOCK** pad.

3. TIME DISPLAY. Shows the time of day, the times set for the timer or automatic oven operation.

4. OVEN TEMPERATURE AND BROIL DISPLAY. Shows the oven temperature or the broil setting selected.

5. FUNCTION INDICATORS. Lights up to show whether the oven is in bake, broil or self-clean mode.

6. INCREASE. Short taps to this pad increase time or temperature by small amounts. Press and hold the pad to increase time or temperature by larger amounts.

7. DECREASE. Short taps to this pad decrease time or temperature by small amounts. Press and hold the pad to decrease time or temperature by larger amounts.

8. BROIL. Press this pad to select the broil function.

9. BAKE. Press this pad to select the bake function.

10. CLEAN. Press this pad to select self-cleaning function. See the Operating the Self-Cleaning Oven section.

11. COOK TIME. Use this pad for Timed Bake operations.

12. STOP TIME. Use this pad along with the **COOK – TIME** or **CLEAN** pad to set the oven to start and stop automatically at a time you select.

13. CLOCK. To set clock, first press the **CLOCK** pad. Then press the **INCREASE** or **DECREASE** pad to set time of day. Press the **CLOCK** pad to start.

14. TIMER. Press this pad to select timer function. The timer does not control oven operations. The timer can time up to 9 hours and 55 minutes.

To set timer, first press the **TIMER** pad. Then press the **INCREASE** or **DECREASE** pad to change the time.

To cancel the timer, press and hold the **TIMER ON/OFF** pad while **TIMER** is displayed.

If “F-” and a number flash on display and the oven control signals, this indicates function error code. Press the **CLEAR/OFF** pad. Allow the oven to cool for 1 hour. Put the oven back into operation. If the function error code repeats, disconnect power to the range and call for service.

OVEN CONTROL, CLOCK AND TIMER

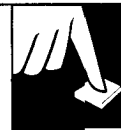

Lock

The clock must be set for the automatic oven timing functions to work properly. The time of day cannot be changed during a Timed Bake or CLEAN cycle.

To Set the Clock



1. Press the **CLOCK** pad.



2. Press the **INCREASE** or **DECREASE** pad to set the time of day.

3. Press the **CLOCK** pad to start.

Timer

The timer is a minute timer only. The timer does not control oven operations. The maximum setting on the timer is 9 hours and 55 minutes.

To Set the Timer

1. Press the **TIMER** pad.

TIMER

cl

2. Press the **INCREASE** or **DECREASE** pad to set the amount of time on timer.

The timer will start automatically within a few seconds of releasing the pad.

The timer, as you are setting it, will display seconds until 60 seconds is reached.

Then it will display minutes and seconds until 60 minutes is reached.

After 60 minutes, it will display hours (“HR” now appears in display) and minutes until the maximum time of 9 hours and 55 minutes is reached.

To Reset Timer

If “**TIMER**” is showing, press the **INCREASE** or **DECREASE** pad until the desired time is reached.

If “**TIMER**” is not showing, press the **TIMER ON/OFF** pad first, then follow instructions above to set the timer.

To Cancel Timer

Press the **TIMER** pad until the word “**TIMER**” quits flashing on the display (about 4 seconds).

Power Outage?

After a power outage, when power is restored, the display will flash and time shown will no longer be correct—for example, after a 5-minute power interruption the clock will be 5 minutes slow. The display flashes until the clock is reset. All other functions that were in operation when the power went out will have to be programmed again.

End of Cycle Tones

The end of cycle tone is 3 short beeps followed by 1 beep that repeats every 6 seconds until you press any operation. If you would like to eliminate the repeating beeps, press and hold the **CLEAR/OFF** pad for 10 seconds.

To return the end of cycle tone to the repeating beeps, press and hold the **CLEAR/OFF** pad for 10 seconds.

Display Messages

If “**DOOr**” appears on the display, the door is open. Close the door. If “**LOCK**” appears on the display, the oven door is in the locked position. **BAKE**, **BROIL** and **COOK TIME** cannot be set if the door is in the locked position.



SURFACE UNIT CONTROLS

At both OFF and HI the control “clicks” into position. You may hear slight “clicking” sounds during cooking, indicating the control is keeping the surface units at the heat level or power level you set.

Switching heats to higher settings always results in a quicker change than switching to lower settings.

How to Set the Controls

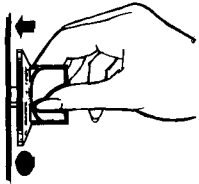

Push the knob and turn in either directions to the heat setting you want.

The control must be pushed in to set only from the OFF position. When the control is on any other position than OFF, it may be rotated without pushing in.

Be sure you turn the control knob to OFF when you finish cooking. An indicator light will glow when a surface unit is on.

Coil Select Control

The left rear surface unit has 2 heating areas of different sizes that let you match the size of the unit to the size of the cookware you are using.

- To use the small (6”) surface unit, push in the bottom portion of the rocker switch next to the control knob. Push in and turn the control knob to desired setting.
- To use the large (9”) surface unit, push in the top portion of the rocker switch. Push in and turn the control knob to desired setting.

CAUTION:

- Never cook directly on the glass. Always use cookware when cooking.
- Do not use surface as a cutting board.
- Do not slide cookware on the glass cooktop surface because it may scratch the glass.

Cooking Guide for Using Heat Settings

HI—Used to begin cooking or to bring water to a boil. Reduce heat setting after water boils.

MEDIUM HIGH—(Setting halfway between HI and MED) Maintains a fast boil on large amounts of food.

MED—Saute and brown; keeps food at a medium boil or simmer.

MEDIUM LOW—(Setting halfway between MED and LO) Cook after starting at HI; cooks with little water in covered pan.

LO—Used for long slow cooking (simmering) to tenderize and develop flavors. Use this setting to melt butter and chocolate or to keep foods warm.

Cooktop temperatures increase with the number of surface units that are on. With 3 or 4 surface units turned on, surface temperatures are high, so be careful when touching the cooktop.

The HOT SURFACE light will glow when the cooktop is hot to the touch.

NOTE:

- At HI or MEDIUM HIGH, never leave food unattended. Boilovers cause smoking; greasy spillovers may catch fire.
- At LO or MEDIUM LOW, melt chocolate, butter on small element.
- When a surface unit is turned on, the unit can be seen glowing red within a few seconds. The red glow will turn on and off (cycling) to maintain the selected heat setting. With poor cookware, you will see frequent cycling of the unit off and on. Good, flat cookware will minimize the cycling. See the Cooking Tips section.
- It is safe to place hot cookware from the oven or surface on the glass ceramic surface when it is cool. Hot cookware will not damage the surface.

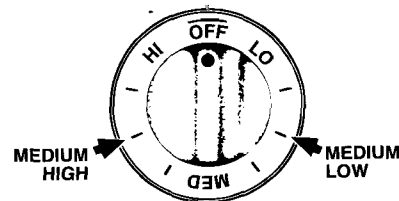

SURFACE COOKING TIPS



Cookware

Use of correct cookware can affect the cooking performance and cleaning of your cooktop. The correct cookware reduces the temperature of the glass ceramic surface and minimizes the chance of spillovers burning onto the surface units.

Use pans with thick, flat, smooth bottoms. Slightly concave pans give acceptable results. Do not expect good results from convex bottom pans. To check the flatness of your pan try 1 of the the following tests:

1. Turn the bottom of the pan up.
Place the edge of a ruler across the bottom of the pan. Little or no light should be visible under the ruler.



2. Another simple test to determine even heat distribution across the cookware bottom is to put 1 inch of water in the pan. Bring the water to a boil and observe the location of bubbles as the water starts to boil. Good flat cookware will have an even distribution of bubbles over the bottom surface area of the pan. Bubbles localized in only a portion of the bottom indicate uneven contact of the pan to the surface unit, uneven heat transfer or an unsuitable pan.

Use pans that match the diameter of the surface unit. Cooking performance will not be as good if the cookware is either smaller or larger than the surface unit.

The following information will help you choose cookware which will give good performance.

Stainless Steel: *highly recommended*

Especially good with a sandwich clad bottom. The sandwich bottom combines the benefits of stainless steel (appearance, durability, and stability) with the advantages of aluminum or copper (heat conduction, even heat distribution).

Aluminum: *heavyweight recommended*

Good conductivity. Aluminum residues sometimes appear as scratches on the cooktop, but can be removed if cleaned immediately. Because of its low melting point, thin weight aluminum should not be used.

Copper Bottom:

Good performance, but copper may leave residues which can appear as scratches. The residues can be removed, as long as the cooktop is cleaned immediately.

Porcelain/enamel:

Good performance only with a thick, flat, smooth bottom. Avoid boiling dry, as porcelain can melt and fuse to the surface.

Glass-ceramic: *not recommended*

Poor performance. May scratch surface. Usable, but not recommended.

Stoneware: *not recommended*

Poor performance. Will scratch the surface.

Cast Iron: *not recommended*

Poor performance. Will scratch the surface.

Deep Fat Frying

Do not overfill cookware with fat that may spill over when adding food. Frosty foods bubble vigorously. Watch food frying at high temperatures. Keep range and hood clean from grease.

Wok Cooking

We recommend that you use only a flat-bottomed wok. They are available at your local retail store.



Melted Materials on Cooktop

Melted materials (plastic, aluminum foil, sugar or foods with high sugar content) **can cause damage to the cooktop.**

If you accidentally melt anything on the cooktop, turn unit to LO, wipe the hot cooktop immediately with several dry paper towels. Wearing an oven mitt, hold the razor scraper at a 30° angle to the cooktop and scrape the hot spill to a cool area outside of the surface unit. Be careful not to burn yourself.

Do not attempt further cleaning until the cooktop surface has cooled. See the Care and Cleaning section.



HOME CANNING TIPS

Canning should be done on cooktop only.

Pots that extend beyond 1 inch of surface unit's edge are not recommended for most surface cooking. However, when canning with water-bath or pressure canner, large-diameter pots may be used. This is because boiling water temperatures (even under pressure) are not harmful to cooktop surfaces surrounding surface unit.

HOWEVER, DO NOT USE LARGE DIAMETER CANNERS OR OTHER LARGE DIAMETER COOKWARE FOR FRYING OR BOILING FOODS OTHER THAN WATER. Most syrup or sauce mixtures—and all types of frying—cook at temperatures much higher than boiling water. Such temperatures could eventually harm cooktop surfaces.

Observe Following Points in Canning

1. Be sure canner fits over center of surface unit. If your cooktop or its location do not allow canner to be centered on the surface unit, use smaller-diameter pots for good canning results.
2. Flat-bottomed canners must be used. Do not use canners with flanged or rippled bottoms (often found in enamelware) because they don't make enough contact with the surface unit and take too long to boil water.



Flat bottomed canners are recommended.

3. When canning, use recipes and procedures from reputable sources. Reliable recipes and procedures are available from the manufacturer of your canner; manufacturers of glass jars for canning, such as Ball and Kerr; and the United States Department of Agriculture Extension Service.
4. Remember that canning is a process that generates large amounts of steam. To avoid burns from steam or heat, be careful when canning.

NOTE: If your house has low voltage, canning may take longer than expected, even though directions have been carefully followed. The process time will be shortened by:

- (1) using a pressure canner, and
- (2) starting with HOT tap water for fastest heating of large quantities of water.

CAUTION

Safe canning requires that harmful microorganisms are destroyed and that the jars are sealed completely. When canning foods in a water bath canner, a gentle but steady boil must be maintained continuously for the required time. When canning foods in a pressure canner, the pressure must be maintained continuously for the required time.

After you have adjusted the controls, it is very important to make sure the prescribed boil or pressure levels are maintained for the required time.

This cooktop has temperature limiters that prevent the cooktop from getting too hot. If the bottom of your canner is not flat, the surface unit can overheat, triggering the temperature limiters to turn the surface unit off for a time. This will stop the boil or reduce the pressure in the canner.

Since you must make sure to process the canning jars for the prescribed time, with no interruption in processing time, you cannot can on this cooktop if your canner is not flat enough.

USING YOUR OVEN



Before Using Your Oven

1. Look at the controls. Be sure you understand how to set them properly. Read over the directions for the Oven Controls so you understand how to use them.
2. Check oven interior. Look at the shelves. Take a practice run at removing and replacing them properly, to give sure, sturdy support.
3. Read over information and tips that follow.
4. Keep this book handy so you can refer to it, especially during the first weeks of using your new range.

NOTE:

- On some models, a fan may automatically turn on to cool internal parts. This is normal, and the fan may continue to run even after the oven is turned off.
- You may notice a “burning” or “oily” smell the first few times you turn your oven on. This is normal in a new oven and will dissipate in a short time. To speed the process, set a self-clean cycle (see Operating the Self-Cleaning Oven section) lasting a minimum of 3 hours.

Oven Shelves

The shelves are designed with stop-locks so when placed correctly on the shelf supports, they will stop before coming completely out of the oven and will not tilt when you are removing food from them or placing food on them.

When placing cookware on a shelf, pull the shelf out to the “stop” position. Place the cookware on the shelf, then slide the shelf back into the oven. This will eliminate reaching into the hot oven.

To remove the shelf from the oven, pull it toward you, tilt the front end upward, and pull it out.

To replace, place the shelf on the shelf support with the stop-locks (curved extension of the shelf) facing up and toward the rear of the oven. Tilt up the front and push the shelf toward the back of the oven until it goes past “stop” on the oven wall. Then lower the front of the shelf and push it all the way back.

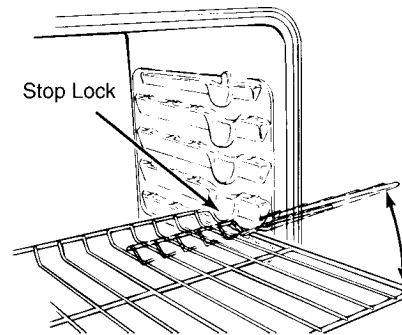

(continued next page)



USING YOUR OVEN

(continued)

Shelf Positions

The oven has 4 shelf supports identified in this illustration as A (bottom), B, C and D (top).

Shelf positions for cooking are suggested in the Baking, Roasting and Broiling sections.

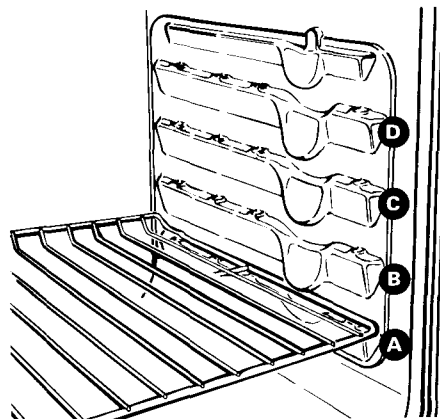

Oven Light

Use the switch on the control panel to turn the light on and off.

Adjusting the Oven Thermostat

If you don't think the oven is heating at the right temperature when you are baking or roasting, you can reset the thermostat yourself.

When cooking food for the first time in your new oven, use time given on recipes as a guide. Oven thermostats, over a period of years, may "drift" from the factory setting and the differences in timing between an old and a new oven of 5 to 10 minutes are not unusual. Your oven has been set correctly at the factory and is more likely to be accurate than the oven which it replaced.

We do not recommend the use of inexpensive thermometers, such as those found in the grocery store, to check the temperature setting of your new oven. These thermometers can vary by 20–40 degrees.

To decide how much to change the temperature, set the oven temperature 25°F. higher or lower than the temperature in your recipe, then bake. The results of this "test" should give you an idea of how much, the temperature should be changed.

To Adjust the Temperature:

1. Press the BAKE pad.

BAKE

c1

2. Select an oven temperature between 500°F. and 550°F.
3. Immediately, before "ON" appears, press and hold the BAKE pad for about 4 seconds. The time display will change to the oven adjustment display.



4. ~~The oven temperature can be adjusted~~ up to (+) 35°F. hotter or (–) 35°F. cooler. Use the INCREASE or DECREASE pad to select the desired change in the display.



5. When you have made the adjustment, press the CLEAR/OFF pad to go back to the time of day display. Use your oven as you would normally.

NOTE: This adjustment will not affect the Broil or Clean temperatures. It will be retained in memory after a power failure.

BAKING



Your oven temperature is controlled very accurately using an oven control system. We recommend that you operate the range for a number of weeks using the time given on recipes as a guide to become familiar with your new oven's performance. If you think an adjustment is necessary, see the Adjusting the Oven Temperature section.

How to Set Your Range for Baking

To avoid possible burns, place the shelves in the correct position before you turn the oven on.



1. Press the BAKE pad.



2. Press the INCREASE or DECREASE pad. The display will show the last bake temperature that was used. (Tap to change the temperature 5°F. a tap. Press and hold to change the temperature 25°F. at a time.)

When the oven starts to heat, the word "ON" and the changing temperature, starting at 100°F., will be displayed. When the oven reaches the set temperature a tone will sound.



3. Press the CLEAR/OFF pad when baking is finished and then remove the food from the oven.

NOTE: A fan may automatically turn on to cool internal parts. This is normal, and the fan may continue to run over after the oven is turned off.

To change the oven temperature during the Bake cycle, press the BAKE pad and then the INCREASE or DECREASE pad to get the new temperature.

TIMED BAKING

How to Time Bake

The oven control allows you to turn the oven on or off automatically at specific times that you set.

NOTE: Before beginning make sure the oven clock shows the correct time of day.

To set the clock, first press the CLOCK pad. Press the INCREASE or DECREASE pad until correct time of day is displayed. Press the CLOCK pad to start.

How to Set Immediate Start and Automatic Stop

To avoid possible burns, place the shelves in the correct position before you turn the oven on.

The oven will turn on immediately and cook for a selected length of time. At the end of Cook Time, the oven will turn off automatically.

1. Press the COOK TIME pad.
2. Press the INCREASE pad until desired length of baking time appears in the display.
3. Press the BAKE pad. Attention tone will occur if step 3 is not done.
4. Press the INCREASE or DECREASE pad until the desired temperature is displayed.

When the oven starts to heat, the word "ON" and the changing temperature, starting at 100°F., will be displayed. When the oven reaches the temperature you set, a tone will sound. The oven will continue to cook for the programmed amount of time, then shut off automatically.

5. Remove the food from the oven. **Remember,** even though the oven shuts off automatically, foods continue cooking after the controls are off.

NOTE: Foods that spoil easily such as milk, eggs, fish, stuffings, poultry and pork should not be allowed to sit for more than 1 hour before or after cooking. Room temperature promotes the growth of harmful bacteria. Be sure the oven light is off because heat from the bulb will speed harmful bacteria growth.

(continued next page)



TIMED BAKING

(continued)

How to Set Delay Start and Automatic Stop

Quick Reminder:

1. Press the COOK TIME pad.
2. Press the INCREASE/ DECREASE pad to set cooking time.
3. Press the STOP TIME pad.
4. Press the INCREASE/ DECREASE pad until desired Stop Time appears in display.
5. Press the BAKE pad.
6. Press the INCREASE/ DECREASE pad to select the oven temperature.

To avoid possible burns, place the shelves in the correct position before you turn the oven on.

You can set the oven control to turn the oven on automatically, cook for a specific length of time and turn off automatically.

For example: Let's say it's 2:00 and dinner time is shortly after 7:00. The recipe suggests 3 hours baking time at 325°F. Here's how:



1. Press the COOK TIME pad.



2. For 3 hours of cooking time, press the INCREASE pad until "3:00" appears in the display.



3. Press the STOP TIME pad.

"5:00" appears in the display and "STOP TIME" flashes. The control



automatically sets Stop Time by adding the Cook Time to the time of day. In this example, the time of day is 2:00 and the Cook Time is 3 hours. Adding 3 hours to the time of day equals 5:00.

4. Change the Stop Time from 5:00 to 7:00 by pressing the INCREASE pad until "7:00" appears in the display.



5. Press the BAKE pad.

6. Press the INCREASE pad. The last oven set temperature appears in the display. Press the INCREASE or DECREASE pad until "325°" is displayed.

At 4:00, the oven will turn on automatically. The word "ON" and the changing oven temperature, starting at 100°F., will be displayed as the oven heats up. The oven will continue to cook for the programmed 3 hours and shut off automatically at 7:00.

7. Remove the food from the oven. Remember, even though the oven shuts off automatically, foods continue cooking after the controls are off.

NOTE:

- The low temperature zone of this range (between 150°F. and 200°F.) is available to keep hot cooked foods warm. Food kept in the oven longer than 2 hours at these low temperatures may spoil.
- When setting your oven for a delay start, never let foods such as dairy products, fish, meat, poultry, etc. sit for more than 1 hour before actual cooking begins. Room temperature promotes the growth of harmful bacteria. Be sure the oven light is off because heat from the bulb will speed bacteria growth.

BAKING



For best baking results, follow these suggestions:

Oven Shelves

Arrange the oven shelf or shelves in the desired locations while the oven is cool. The correct shelf position depends on the kind of food and the browning desired. As a general rule, place most foods in the middle of the oven, on either the second or third shelf from the bottom. See the chart for suggested shelf positions.

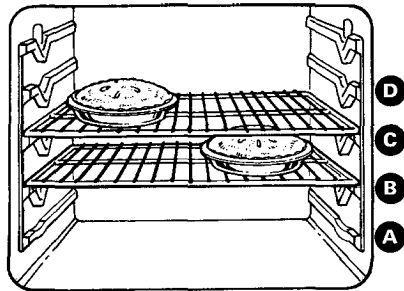

Type of Food	Shelf Position
Angel food cake	A
Biscuits or muffins	B or C
Cookies or cupcakes	B or C
Brownies	B or C
Layer cakes	B or C
Bundt or pound cakes	A or B
Pies or pie shells	B or C
Frozen pies	A (on cookie sheet)
Casseroles	B or C
Roasting	A or B

Preheating

Preheat the oven if the recipe calls for it. Preheat means bringing the oven up to the specified temperature before putting in the food. To preheat, set the oven at the correct temperature—selecting a higher temperature does not shorten preheat time.

Preheating is necessary for good results when baking cakes, cookies, pastry and breads. For most casseroles and roasts, preheating is not necessary. For ovens without a preheat indicator light or tone, preheat 10 minutes. After the oven is preheated place the food in the oven as quickly as possible to prevent heat from escaping.

Baking Pans

Use the proper baking pan. The type of finish on the pan determines the amount of browning that will occur.

- Dark, rough or dull pans absorb heat resulting in a browner, crisper crust. Use this type for pies.
- Shiny, bright and smooth pans reflect heat, resulting in a lighter, more delicate browning. Cakes and cookies require this type of pan.
- Glass baking dishes also absorb heat. When baking in glass baking dishes, lower the temperature by 25°F. and use the recommended cooking time in the recipe. This is not necessary when baking pies or casseroles.

Pan Placement

For even cooking and proper browning, there must be enough room for air circulation in the oven. Baking results will be better if baking pans are centered as much as possible rather than being placed to the front or to the back of the oven.

Pans should not touch each other or the walls of the oven. Allow 1 to 1 ½ inch space between pans as well as from the back of the oven, the door and the sides. If you use 2 shelves, stagger the pans so 1 is not directly above the other.

(continued next page)



BAKING

(continued)

Baking Guides

When using prepared baking mixes, follow package recipe or instructions for the best baking results.

Cookies

When baking cookies, flat cookie sheets (without sides) produce better-looking cookies. Cookies baked in a jelly roll pan (short sides all around) may have darker edges and pale or light browning may occur.

Do not use a cookie sheet so large that it touches the walls or the door of the oven.

For best results, use only 1 cookie sheet in the oven at a time.

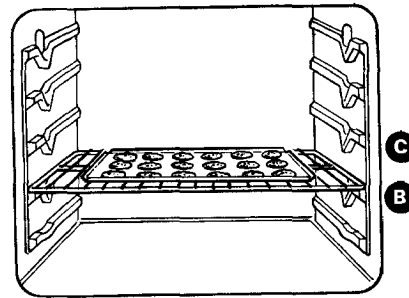

Pies

For best results, bake pies in dark, rough or dull pans to produce a browner, crisper crust. Frozen pies in foil pans should be placed on an aluminum cookie sheet for baking since the shiny foil pan reflects heat away from the pie crust; the cookie sheet helps retain it.

Cakes

When baking cakes, warped or bent pans will cause uneven baking results and poorly shaped products. A cake baked in a pan larger than the recipe recommends will usually be crisper, thinner and drier than it should be. If baked in a pan smaller than recommended, it may be undercooked and batter may overflow. Check the recipe to make sure the pan size used is the one recommended.

Aluminum Foil

Never entirely cover a shelf with a large cookie sheet or aluminum foil. This will disturb the heat circulation and result in poor baking. A smaller sheet of foil may be used to catch a spillover by placing it on a lower shelf several inches below the food.

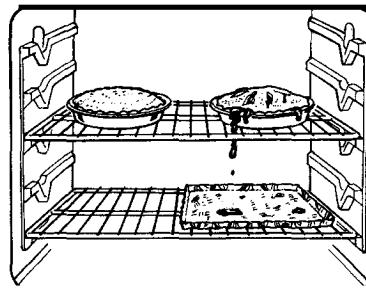

Don't Peek

Set the timer for the estimated cooking time and do not open the door to look at your food. Most recipes provide minimum and maximum baking times such as "bake 30-40 minutes."

DO NOT open the door to check until the minimum time. Opening the oven door frequently during cooking allows heat to escape and makes baking times longer. Your baking results may also be affected.

ROASTING

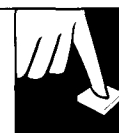

Roasting is cooking by dry heat. Tender meat or poultry can be roasted uncovered in your oven. Roasting temperatures, which should be low and steady, keep spattering to a minimum.

Roasting is really a baking procedure used for meats. Therefore, oven controls are set for BAKE or Timed Bake. (You may hear a slight clicking sound, indicating the oven is working properly.) Roasting is easy; just follow these directions:

1. Place in the shelf in A or B position, No preheating is necessary.

2. Check the weight of the meat, and place, fat side up, or poultry breast-side-up, on the roasting rack in a shallow pan. The melting fat will baste the

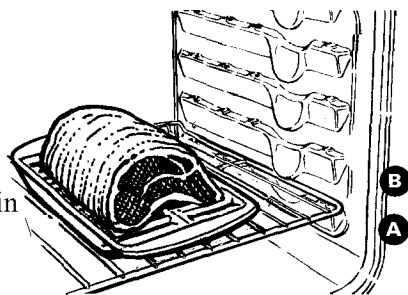

meat. Select a pan as close to the size of the meat as possible. (The broiler pan with rack is a good pan for this.) Line the broiler pan with aluminum foil when using the pan for marinating, cooking with fruits, cooking heavily cured meats, or basting food during cooking. Avoid spilling these materials inside the oven door.



3. Press the BAKE pad.



4. Press the INCREASE pad. The oven set temperature appears in the display.

When the oven starts to heat, the word "ON" and the changing temperature, starting with 100°F., will be displayed. When the oven reaches the set temperature a tone will sound.

5. Press the CLEAR/OFF pad when roasting is finished and then remove the food from the oven.

Most meats continue to cook slightly while standing, after being removed from the oven. Standing time recommended for roasts is 10 to 20 minutes. This allows roasts to firm up and makes them easier to carve. Internal temperature will rise about 5° to 10°F.; to compensate for temperature increase, if desired, remove the roast from oven sooner (at 5° to 10°F. less than temperature in the Roasting Guide).

NOTE:

- You may wish to use Timed Baking, as described in the Baking section of this book, to turn the oven on and off automatically.
- Remember that food will continue to cook in the hot oven and therefore should be removed when the desired internal temperature has been reached.
- A fan may automatically turn on to cool internal parts. This is normal, and the fan may continue to run even after the oven is turned off.

To change the oven temperature during roasting, press the BAKE pad and then the INCREASE or DECREASE pad to get the new temperature.

For Frozen Roasts

Frozen roasts of beef, pork, lamb, etc., can be started without thawing, but allow 10 to 25 minutes per pound additional time (10 minutes per pound for roasts under 5 pounds, more time for larger roasts).

Thaw most frozen poultry before roasting to ensure even doneness. Some commercial frozen poultry can be cooked successfully without thawing. Follow directions given on the package label.

(continued next page)



ROASTING

(continued)

Questions and Answers

Q. Is it necessary to check for doneness with a meat thermometer?

A. Checking the finished internal temperature at the completion of cooking time is recommended. Temperatures are shown in Roasting Guide. For roasts over 8 lbs., check with thermometer at half-hour intervals after half the time has passed.

Q. Why is my roast crumbling when I try to carve it?

A. Roasts are easier to slice if allowed to cool 10 to 20 minutes after removing them from the oven. Be sure to cut across the grain of the meat.

Q. Do I need to preheat my oven each time I cook a roast or poultry?

A. It is unnecessary to preheat your oven.

Q. When buying a roast, are there any special tips that would help me cook it more evenly?

A. Yes. Buy a roast as even in thickness as possible, or buy rolled roasts.

Q. Can I seal the sides of my foil "tent" when roasting a turkey?

A. Sealing the foil will steam the meat. Leaving it unsealed allows the air to circulate and brown the meat.

ROASTING GUIDE

Type	Oven Temperature	Doneness	Approximate Roasting Time in Minutes per Pound		Internal temperature °F.
Meat			3 to 5 lbs.	6 to 8 lbs.	
Tender cuts; rib, high quality sirloin tip, rump or top round*	325°	Rare: Medium: Well Done:	24-33 35-39 40-45	18-22 22-29 30-35	140°-150°† 150°-1600 1700-1 85°
Lamb leg or bone-in shoulder*	325°	Rare: Medium: Well Done:	21-25 25-30 30-35	20-23 24-28 28-33	140°-150°† 150°-1600 1700-1 85°
Veal shoulder, leg or loin*	325°	Well Done:	35-45	30-40	1700-1 800
Pork loin, rib or shoulder*	325°	Well Done:	35-45	30-40	1700-1 80°
Ham, precooked	325°	To Warm:	17-20 minutes per pound (any weight)		1150-1 25°
Poultry			3 to 5 lbs.	Over 5 lbs.	
Chicken or Duck	325°	Well Done:	35-40	30-35	185°-1900
Chicken pieces	350°	Well Done:	35-40		185°-1900
Turkey	325°	Well Done:	10 to 15 lbs. 18-25	Over 15 lbs. 15-20	In thigh: 185°-1900

†For boneless rolled roasts over 6 inches thick, add 5 to 10 minutes per pound to times given above.

*The U.S. Department of Agriculture says "Rare beef is popular, but you should know that cooking it to only 140°F. means some food poisoning organisms may survive." (Source: Safe Food Book, Your Kitchen Guide, USDA Rev. June 1985.)

BROILING

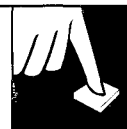

Broiling is cooking food by intense radiant heat from the upper unit in the oven. Most fish and tender cuts of meat can be broiled. Follow these directions to keep spattering and smoking to a minimum.

1. If the meat has fat or gristle near edge, cut vertical slashes through both about 2 inches apart. If desired, the fat may be trimmed, leaving a layer about 1/8 inch thick.
2. Place the meat on the broiler rack in the broiler pan. Always use the rack so the fat drips into the broiler pan; otherwise the juices may become hot enough to catch on fire.
3. Position the shelf on the recommended shelf position as suggested in Broiling Guide. Most broiling is done on C position, but if your range is connected to 208 Volts, you may wish to use a higher position.
4. Leave the door open to the broil stop position.

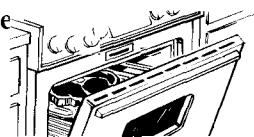

5. Press the BROIL pad.

6. Select LO Broil (450°F.) by tapping INCREASE pad once. Select HI Broil (550°F.) by tapping INCREASE pad twice.

To change from HI Broil to LO Broil, press the BROIL pad then tap DECREASE pad once.

7. Turn the food only once during cooking. Time foods for first side according to the Broiling Guide.

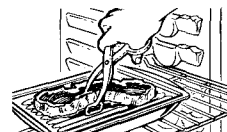

Turn the food, then use the times given for the second side as a guide to preferred doneness. (Where 2 thicknesses and times are given together, use the first times given for the thinnest food.)

8. When broiling is completed, press the CLEAR/OFF pad. Serve the food immediately, and leave the pan outside the oven to cool during the meal for easiest cleaning.

NOTE: A fan may automatically turn on to cool internal parts. This is normal, and the fan may continue to run even after the oven is turned off.

Use of Aluminum Foil

You can use aluminum foil to line your broiler pan and broiler rack. However, you must mold the foil tightly to the rack and cut slits in it just like the rack.

Without the slits, the foil will prevent fat and meat juices from draining to the broiler pan. The juices could become hot enough to catch on fire. If you do not cut the slits, you are frying, not broiling.

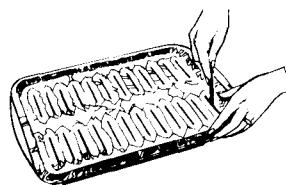

Questions and Answers

Q. Why are my meats not turning out as brown as they should?

- A.** In some areas, the power (voltage) to the range may be low. In these cases, preheat the broil unit for 10 minutes before placing broiler pan with food in oven. Check to see if you are using the recommended shelf position. Broil for longest period of time indicated in the Broiling Guide. Turn food only once during broiling.

Q. When broiling, is it necessary to always use a rack in the pan?

- A. Yes.** Using the rack suspends the meat over the pan. As the meat cooks, the juices fall into the pan, thus keeping meat drier. Juices are protected by the rack and stay cooler, thus preventing excessive spatter and smoking.

Q. Do I need to grease my broiler rack to prevent meat from sticking?

- A. No.** The broiler rack is designed to reflect broiler heat, thus keeping the surface cool enough to prevent meat from sticking to the surface. However, spraying the broiler rack lightly with a vegetable cooking spray before cooking will make cleanup easier.

Q. Should I salt the meat before broiling?

- A. No.** Salt draws out the juices and allows them to evaporate. Always salt after cooking. Turn meat with tongs; piercing meat with a fork also allows juices to escape. When broiling poultry or fish, brush each side often with butter.

(continued next page)



BROILING GUIDE

- Always use the broiler pan and the rack that comes with your oven. It is designed to minimize smoking and spattering by trapping the juices in the shielded lower part of the pan.
- The oven door should be open to the broil stop position.**
- For steaks and chops, slash fat evenly around outside edges of meat. To slash, cut crosswise through outer fat surface just to the edge of the meat. Use tongs to turn meat over to prevent piercing meat and losing juices.
- If desired, marinate meats or chicken before broiling, or brush with barbecue sauce last 5 to 10 minutes of broiling only.
- When arranging food on the pan, do not let fatty edges, which could soil the oven with fat drippings, hang over the sides.
- The Broiler does not need to be preheated. However, for very thin foods, or to increase browning, preheat if desired.
- Frozen steaks can be broiled by positioning the oven shelf at next lowest shelf position and increasing cooking time given in this guide 1 ½ times per side.
- If your range is connected to 208 volts, rare steaks may be broiled by preheating the broiler and positioning the oven shelf 1 position higher.

Food	Quantity and/or Thickness	Shelf Position	First Side Time, Minutes	Second Side Time, Minutes	Comments
Bacon	1/2 lb. (about 8 thin slices)	C	4½	4½	Arrange in single layer.
Ground Beef Well Done	1 lb. (4 patties) 1/2 to 3/4 inch thick	C	10	7	Space evenly. Up to 8 patties take about same time.
Beef Steaks Rare Medium Well Done Rare Medium Well Done	1 inch thick (1 to 1½ lbs.) 1½ inch thick (2 to 2½ lbs.)	C C C C C C	6 8 12 10 15 25	5 6 11 7-8 14-16 20-25	Steaks less than 1 inch thick cook through before browning Pan frying is recommended. Slash fat.
Chicken	1 whole (2 to 2½ lbs.), split lengthwise	A	35	10-15	Reduce time about 5 to 10 minutes per side for cut-up chicken. Brush each side with melted butter. Broil skin-side-down first.
Bakery Products Bread (Toast) or Toaster Pastries English Muffins	2 to 4 slices 1 pkg. (2) 2 (split)	C C	1½-2 3-4	1/2	Space evenly. Place English muffins cut-side-up and brush with butter. if desired.
Loxster Tails	2-4 (6 to 8 oz. each)	B	13-16	Do not turn over.	Cut through back of shell. Spread open. Brush with melted butter before and after half of broiling time.
Fish	1-lb. fillets 1/4 to 1/2 inch thick	C	5	5	Handle and turn very carefully. Brush with lemon butter before and during cooking if desired. Preheat broiler to increase browning.
Ham Slices (precooked)	1 inch thick	B	8	8	Increase time 5 to 10 minutes per side for 1½ inch thick or home cured ham.
Pork Chops Well Done	2 (1/2 inch) 2(1 inch thick) about 1 lb.	C B	10 13	10 13	Slash fat.
Lamb Chops Medium Well Done Medium Well Done	2(1 inch) about 10 to 12 oz. 2 (1½ inch) about 1 lb.	C C C B	10 12 14 17	9 10 12 12-14	Slash fat.
Wieners and similar precooked sausages, bratwurst	1-lb. pkg. (10)	C	6	I-2	If desired, split sausages in half lengthwise; cut into 5- to 6-inch pieces.

OPERATING THE SELF-CLEANING OVEN

Normal Cleaning Time: 3 hours

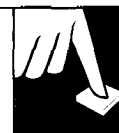

Before a Clean Cycle

Quick Reminder:

1. Prepare the oven for cleaning.
2. Close the oven door.
3. Press the CLEAN pad.
4. Press the INCREASE or DECREASE pad to set the clean time.

The range must be completely cool in order to set the self-clean cycle.

1. Remove the broiler pan, broiler rack, all cookware and any aluminum foil from the oven—they cannot withstand the high cleaning temperatures.

NOTE: The oven shelves may be left in the oven, however, they will discolor and become hard to slide after the self-clean cycle.

2. Wipe up heavy soil on the oven bottom. If you use soap, rinse thoroughly before self-cleaning to prevent staining.

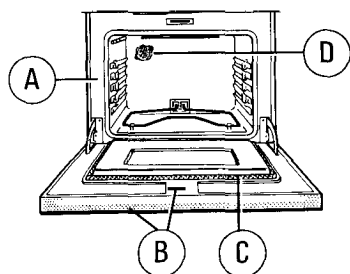

- A. Oven Front Frame
- B. Openings in Door
- C. Oven Door Gasket
- D. Oven Light

3. Clean spatters or spills on oven front frame (A), under the front edge of the oven vent, the door liner outside the door gasket and the front edge of the oven cavity (about 1 inch into the oven). Use detergent and hot water with a soap-filled steel wool pad, then rinse well with a vinegar and water mixture. This will help prevent a brown residue from forming when the oven is heated. Buff these areas with a dry cloth.

- Clean the top, sides and outside front of the oven door with soap and water. Do not use abrasives or oven cleaners.
- **Do not let water run down through the openings (B) in the top of the door. To help prevent water from getting in these slots when cleaning, open the door as far as it will go.**
- **Do not rub or clean the door gasket (C)**—the fiberglass material of the gasket has an extremely low resistance to abrasion. An intact and well-fitting oven door gasket is essential for energy-efficient oven operation and good baking results. If you notice the gasket becoming worn, frayed or damaged in any way or if it has become displaced on the door, you should have it replaced.
- 4. Close the door and make sure the oven light (D) is off. If the oven light is not turned off, the life of the bulb will be shortened or it may cause the bulb to burn out immediately. The door will latch automatically when the CLEAN pad is pushed.

The oven shelves may be cleaned in the self-cleaning oven. However, they will darken, lose their luster and become hard to slide. Wipe the shelf supports with cooking oil after self-cleaning to make shelves slide more easily.

Do not use commercial oven cleaners or oven protectors in or near the self-cleaning oven. A combination of any of these products plus the high clean cycle temperatures may damage the porcelain finish of the oven.

Important

The oven door must be closed and all controls must be set correctly for the clean cycle to work properly.

How to Set the Oven for Cleaning

1. Follow steps above to prepare the oven for cleaning.
2. Close the oven door.
3. Press the CLEAN pad.
4. Press the INCREASE or DECREASE pad until the desired Clean Time is displayed.

Clean Time is normally 3 hours. You can change the Clean Time to anywhere between 2 and 4 hours, depending on how dirty the oven is.

The self-clean cycle will automatically begin after “CLEAN” is displayed. The words “ON” and “LOCK” will appear in the display. It will not be possible to open the oven door until the temperature drops below the lock temperature and the LOCK light goes off.

5. When the LOCK light is off open the door.

NOTE: A fan may automatically turn on to cool internal parts. This is normal and the fan may continue to run even after the oven is turned off.

(continued next page)



OPERATING THE SELF-CLEANING OVEN

(continued)

After a Clean Cycle

When the clean cycle is finished, the word “CLEAN” will go out in the display and the oven will begin to cool. When the oven temperature has fallen below the locking temperature, the word “LOCK” goes out and the door can be opened.

After a clean cycle, you may notice some white ash in the oven. Just wipe it up with a damp cloth. If white spots remain, remove them with a soap-filled steel wool pad. Be sure to rinse thoroughly with a vinegar and water mixture. These deposits are usually a salt residue that cannot be removed by the clean cycle.

If the oven is not clean after 1 clean cycle, the cycle may be repeated.

How to Delay Start of Cleaning

Quick Reminder:

1. Prepare the oven for cleaning.
2. Press the CLEAN pad.
3. Press the INCREASE pad.
4. Press the STOP TIME pad.

The time that appears is 3 hours later than the time of day. Press the INCREASE pad until the Stop Time you desire appears in the display. The self-clean cycle will automatically begin 3 hours before the Stop Time you select.

Delay Start is setting the oven timer to start the clean cycle automatically at a later time than the present time of day.

NOTE: Before beginning, make sure the oven clock shows the correct time of day.

For example: Let's say it's 7:00 and you want the oven to begin self-cleaning at 9:00 after you're finished in the kitchen. The oven is just soiled a normal amount so the normal Clean Time of 3 hours is preferred.

1. Prepare the oven for cleaning,
2. Close the oven door.



3. Press the CLEAN pad.



4. Press the INCREASE pad.

5. Clean Time for heavy soil can be set for 4 hours. If a longer or shorter Clean Time is desired, press the INCREASE or DECREASE pad until the desired Clean Time is displayed.



6. Press the STOP TIME pad. “10:00” appears in the display and “STOP TIME” flashes.

The control automatically sets the Stop Time by adding the Clean Time to the time of day. In this example, the time of day is 7:00 and the Clean Time is 3 hours. Adding 3 hours to the time of day equals 10:00.

7. Change Stop Time from 10:00 to 12:00 by pressing the INCREASE pad until “12:00” appears in the display. The words “DELAY CLEAN” will also appear in the display.

The self-clean cycle will automatically begin at 9:00 and finish at 12:00. The word “ON” will appear in the display at 9:00.

When the oven locks, the word “LOCK” will be displayed and the door will be locked in position. It will not be possible to open the oven door until the temperature drops below the lock temperature.

When the clean cycle is finished, the word “CLEAN” will go out in the display and the oven will begin to cool. When the oven temperature has fallen below the locking temperature, the word “LOCK” goes out and the door can be opened.

8. When the LOCK light is off open the door.

(continued next page)



Questions and Answers

Q. If my oven clock is not set to the correct time of day, can I still self-clean my oven?

A. If the clock is not set to the correct time of day you will not be able to set a delay clean to end at a specific time.

Q. Can I use commercial oven cleaners on any part of my self-cleaning oven?

A. No cleaners or coatings should be used around any part of this oven. If you do use them and do not thoroughly rinse the oven with water, wiping it absolutely clean afterwards, the residue can scar the oven surface and damage metal parts the next time the oven is automatically cleaned.

Q. What should I do if excessive smoking occurs during cleaning?

A. This is caused by excessive soil. Press the CLEAR/OFF pad. Open windows to rid room of smoke. Wait until the oven has cooled and the word "LOCK" is off in the display. Wipe up the excess soil and reset the clean cycle.

Q. Is the "crackling" or "popping" sound I hear during cleaning normal?

Yes. This is the sound of the metal heating and cooling during both the cooking and cleaning functions.

Q. Should there be any odor during the cleaning?

A. Yes, there may be an odor during the first few cleanings. Failure to wipe out excessive soil might also cause a strong odor when cleaning.

Q. What causes the hair-like lines on the enameled surface of my oven?

A. This is a normal condition, resulting from heating and cooling during cleaning. These lines do not affect how your oven performs.

Q. Why do I have ash left in my oven after cleaning?

A. Some types of soil will leave a deposit which is ash. It can be removed with a damp sponge or cloth.

Q. My oven shelves do not slide easily. What is the matter?

A. After many cleanings, oven shelves may become so clean they do not slide easily. To make shelves slide more easily, after each self-cleaning function dampen fingers with a small amount of cooking oil and rub lightly over sides of shelf where they contact shelf supports.

Q. My oven shelves have become gray after the self-clean cycle. Is this normal?

A. Yes. After the self-clean cycle, the shelves may lose some luster and change to a deep gray color.

CARE AND CLEANING

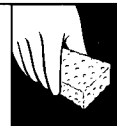

Proper care and cleaning are important so your radiant cooktop will give you efficient and satisfactory service. If soil, mineral deposits from evaporated water spills or metal rub-off from aluminum cookware are not removed, they will burn on the glass cooktop surface and cause permanent discoloration.

Do not use a cooktop cleaner on a hot cooktop. The fumes can be hazardous to your health and can chemically attack the glass surface.

Follow these directions carefully in caring for your cooktop to assure safe and proper maintenance.

BE SURE THAT SURFACE UNIT CONTROL KNOBS ARE TURNED OFF AND ENTIRE COOKTOP IS COOL BEFORE CLEANING.

(continued next page)



CARE AND CLEANING

(continued)

Removal of Packaging Tape

The safest way to remove adhesive left from packing tape on new appliances to assure no damage is done to the finish of the product is an application of a household liquid dishwashing detergent, mineral oil or cooking oil. Apply with a soft cloth and allow to soak. Wipe dry and then apply an appliance polish to thoroughly clean and protect the surface. This procedure is also safe for the face of microwave doors and other plastic and Lexan parts.

NOTE: The plastic tape that is not removed from the chrome trim on oven parts cannot be removed if baked on.

Control Knobs

Control knobs can be pulled straight off the stem for easier cleaning.

Before removing the knobs for cleaning, please note that the knobs on the left side and the knobs on the right side are in the proper OFF position. When replacing the knobs, check the OFF position to insure proper alignment.

Hint: Slip a thin cloth (such as a handkerchief) or a piece of string under and around the knob edge and pull up. Clean the knobs with detergent and warm water, using a soft cloth. **DO NOT** scour the knobs.

To replace the knobs:

1. The knob stem has a groove in each side. The groove on 1 side has a spring clip. The other groove is clear (see illustration).
2. Check the inside of the knob and find the molded rib.
3. Replace the knob by fitting the molded rib inside the knob into the clear groove on the stem.

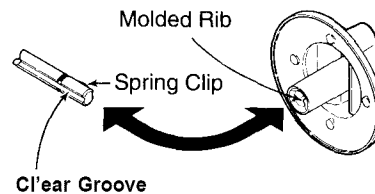

Control Panel

Wash with soap and water. Rinse with clean water and dry with a paper towel. **Do not use scouring pads or abrasive cleaners because they may damage the finish.**

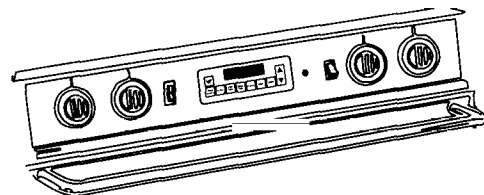

Broiler Pan and Rack

After broiling, remove the broiler pan from the oven. Remove the rack from the pan. carefully pour out the grease in the pan into a proper container. Wash and rinse the pan and rack in hot soapy water.

If food has burned on, sprinkle the rack while hot with detergent and cover with wet paper towels or a dishcloth. Burned-on foods will soak loose while the meal is being served.

The broiler pan and rack may also be cleaned in a dishwasher.

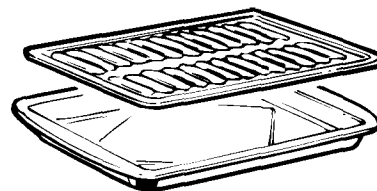

Do not store a soiled broiler pan and rack in the oven. Do not clean in the self-cleaning oven.

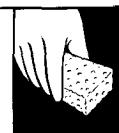

Removable Oven Door

The oven door is removable, but it is heavy. You may need help removing and replacing the door.

Do not lift the door by the handle. This could cause the glass to break or cause damage to the door.

To remove the door, open it a few inches to the special stop position that will hold the door open. Grasp firmly on each side and lift the door straight up and off the hinges.

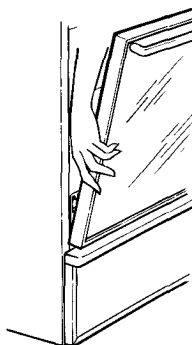

NOTE: Be careful not to place hands between the hinge and the oven door frame as the hinge could snap back and pinch fingers.

To replace the door, make sure the hinges are in the special stop position. Position the slots in the bottom of the door squarely over the hinges. Then lower the door slowly and evenly over both hinges at the same time. If hinges snap back against the oven frame, pull them back out.

TO CLEAN THE DOOR:

Inside of door:

- Because the area inside the gasket is cleaned during the self clean cycle, you do not need to clean this by hand. Any soap left on the liner causes additional stains when the oven is heated.
- The area outside the gasket can be cleaned with a scouring pad.
- Do not rub or clean the door gasket—the fiberglass material of the gasket has an extremely low resistance to abrasion. An intact and well-fitting oven door gasket is essential for energy-efficient oven operation and good baking results. If you notice the gasket becoming worn, frayed or damaged in any way or if it has become displaced on the door, you should have it replaced.

NOTE: The gasket is designed with a gap at the bottom to allow for proper air circulation.

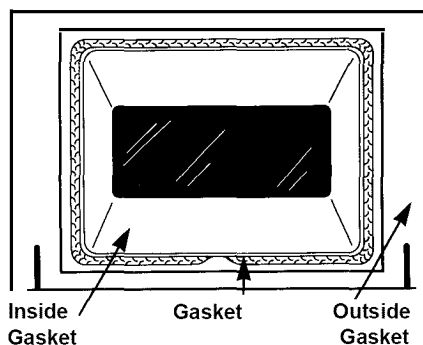

Outside of door:

- Use soap and water to thoroughly clean the top, sides and front of the oven door. Do not let water run down through openings in the top of the door. Rinse well. You may also use a glass cleaner to clean the glass on the outside of the door.
- Spillage of marinades, fruit juices, tomato sauces and basting materials containing acids may cause discoloration and should be wiped up immediately. When surface is cool, clean and rinse.
- **Do not use oven cleaners, cleansing powders or harsh abrasives on the outside of the door.**

NOTE: Do not clean the bake unit or the broil unit. Any soil will burn off when the units are heated. The bake unit can be lifted gently to clean the oven floor. If spillover, residue, or ash accumulate around the bake unit, gently wipe around the unit with warm water.

Oven Shelves

Clean the shelves with a mild abrasive cleanser. After cleaning, rinse the shelves with clean water and dry with a clean cloth.

The oven shelves may be cleaned in the self-cleaning oven. However, they will darken, lose their luster and become hard to slide. Wipe the shelf supports with cooking oil after self-cleaning to make shelves slide more easily.



To remove heavy, burned on soil, soapy metal pads may be used. After scrubbing, wash with soapy water, rinse and dry.

(continued next page)

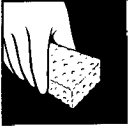

CARE AND CLEANING

(continued)

Oven Light Bulb

The light bulb is located on the back wall of the oven. Before replacing the bulb, **disconnect electrical power to the range** at the main fuse or circuit breaker panel or unplug the range from the electrical outlet. Let the bulb cool completely before removing it. For your safety, do not touch a hot bulb with a damp cloth. If you do, the bulb will break.

To remove: Unscrew the cover and remove the bulb.

To replace: Put in a new 40-watt **appliance bulb**.

NOTE: A 40-watt appliance bulb is smaller than a standard 40-watt household bulb.

- Install and tighten the cover.
- Reconnect electrical power to the range.

DO NOT REMOVE SCREWS.

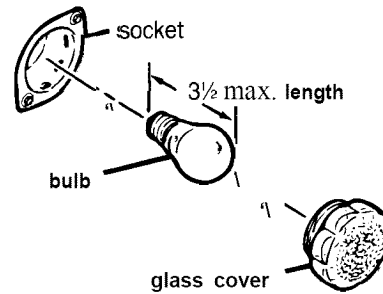

Removable Storage Drawer

The storage drawer is a good place to store cookware and bakeware. Do not store plastics and flammable material in the drawer.

Do not overload the storage drawer. If the drawer is too heavy, it may slip off the track when opened. To open the drawer, grasp the center of the handle and pull straight out.

The storage drawer may be removed for cleaning under the range.

To remove: Pull the drawer straight out and lift over the guide stops.

To replace: Lift over the guide stops and slide the drawer into place.

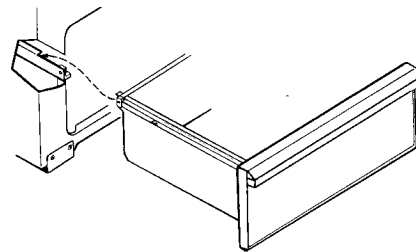

To clean both the inside and the outside: Wipe with soap and water. Rinse well.

Do not use cleansing powders or harsh abrasives which may scratch the surface.

Oven Vent

The oven vent is located at the rear of the cooktop. **Do not obstruct this opening.** Keep the vent clean.

Metal Parts

Do not use steel wool, abrasives, ammonia or commercial oven cleaners. To safely clean surfaces; wash, rinse and then dry with a soft cloth.

Glass Surfaces

To clean the outside glass finish, use a glass cleaner. Rinse and polish with a dry cloth. Do not allow the water or cleaner to run down inside openings in the glass while cleaning.

Painted Surfaces

Painted surfaces include the outside oven door, sides, control panel and drawer front. Clean these with soap and water or a vinegar and water solution. **Do not use commercial oven cleaners, cleansing powders, steel wool or harsh abrasives on any painted surface.**

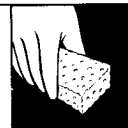

Glass Ceramic Cooktop Cleaning

Cleaning of glass ceramic cooktops is different from cleaning a standard porcelain finish.

To maintain and protect the surface of your new glass ceramic cooktop follow these basic steps.

DAILY CLEANING:

Use only Cook Top Cleaning Creme on Glass Ceramic.

For normal, light soil:

1. Rub a small amount of Cook Top Creme onto soiled area using a dry paper towel. Wipe until all soil and creme are removed. Frequent cleaning leaves a protective coating of silicone which is essential in preventing scratches and abrasions.
2. Clean surface with Cook Top Cleaning Creme after each use.

For heavy, burned on soil:

1. Apply a few drops of Cook Top Cleaning Creme to the (cool) soiled area.
2. Using a dry paper towel, rub creme into the burned on area.
3. Carefully scrape remaining soil with razor scraper. Hold scraper at a 30° angle against the ceramic surface.
4. If any soil remains, repeat the steps listed above. For additional protection, after all soil has been removed, polish the entire surface with the Cook Top Cleaning Creme.

NOTE: Using a razor scraper will not damage the surface if the 30° angle is maintained. **Store the razor scraper out of reach of children.**

Special Care:

Sugary spillovers (such as jellies, fudge, candy syrups) or melted plastics can cause pitting of the surface of your cooktop unless the spill is removed while still hot. **Special care should be taken when removing hot substances.** Follow these instructions carefully and remove soil while spill is still hot.

1. Turn off all surface units affected by the spillover. Remove hot utensils.
2. Wearing an oven mitt, hold the razor scraper at a 30° angle to the cooktop and scrape the hot spill to a cool area outside the surface unit. Be sure to use a new, sharp razor scraper. do not use a dull or nicked blade.
3. With the spill in a cool area, use a dry paper towel to remove any excess. Any spillover remaining should be left until the surface of the cooktop has cooled. Do not continue to use the soiled surface unit until all of the spillover has been removed. Follow the steps under Heavy Soil to continue the cleaning process.



General Information:

As the Cook Top Cleaning Creme cleans, it leaves a protective silicone coating on the cooktop surface. This coating helps to prevent build-up of mineral deposits (water spots) and will make future cleaning easier. Dishwasher detergents remove this protective coating and therefore make the cooktop more susceptible to staining.

PRECAUTIONS:

- Most cleaners contain ammonia, chemicals and abrasives which can damage the surface of your cooktop. Use **only the Cook Top Cleaning Creme for proper cleaning and protection of your glass ceramic surface.**
- If you slide aluminum or copper cookware across the surface of your cooktop, they may leave metal markings which appear as scratches. If this should happen, use the razor scraper and Cleaning Creme to remove these markings. Failure to remove these residues immediately may leave permanent marks.
- If pots with a thin overlay of aluminum, copper, or enamel are allowed to boil dry, the overlay may bond with the glass ceramic and leave a black discoloration. This should be removed immediately before heating again or the discoloration may be permanent.
- Use of window cleaner may leave an iridescent film on the cooktop. Cook Top Cleaning Creme will remove this discoloration.
- Water stains (calcium deposits) are removable using Cook Top Cleaning Creme or full strength white vinegar.

(continued next page)

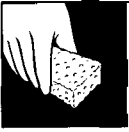

CARE AND CLEANING

(continued)

Anti-Tip Device

1. Before placing range in the counter, notice the location of the stability bracket which is already attached to the back of the range. This location should work for most installations. However, it may be more convenient to hook the stability chain to the unit when the stability bracket is attached to the upper set of holes in the back of range. See Fig. A. The upper level set of holes are intended for use with a backsplash kit. If the backsplash is not being used, make sure that there are no structural supports for the countertop which will interfere with the stability bracket when located in the upper set of holes.

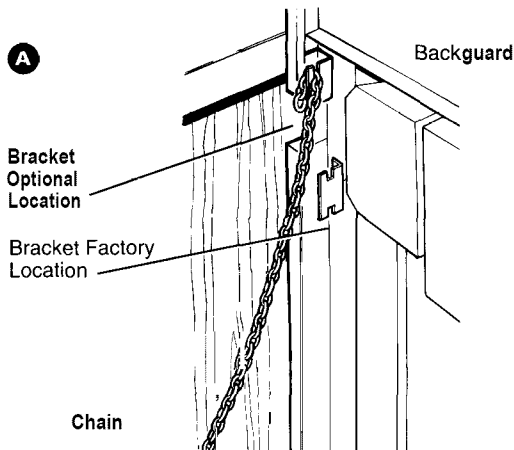

2. Fasten 1 end of the stability chain to the floor or wall with the long screw and washer supplied. See Fig. B. Make certain the screw is going into the wall-plate at the base of the wall or 1 of the studs in the base of the wall. See Fig. C. Whether you attach the chain to the wall or floor, be certain that the screw is in at least 3/4 inch thickness of wood other than baseboard and that there are no electrical wires or plumbing in the area which the screw could penetrate. Attach the stability chain in a location which will allow the chain to be in line with the bracket side to aide as much as possible when attached to the unit. Test to see if the chain is securely fastened by tugging on the chain.

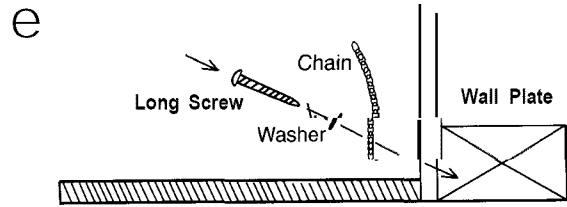
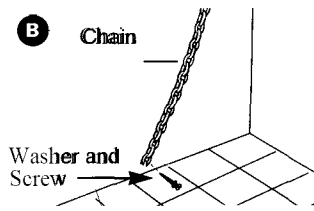

3. Temporarily attach the loose end of the chain to the rear of the countertop with the tape from the packaging. See Fig. D.
4. Place the range in the counter cutout leaving just enough room between the back of the range and the wall to reach the stability bracket.
5. Hook the loose end of the chain onto the bracket by slipping the nearest link of the chain into the slot in the bracket. See Fig. A and make sure the chain is pulled as tight as possible and that there is no excess slack in the chain after the chain is attached to the bracket.

A CAUTION: Excessive slack in the chain could allow the range to tip over.

6. Slide the range all the way back into the counter. Once the range is pushed back in place, there will be a small amount of slack in the chain. This is normal.

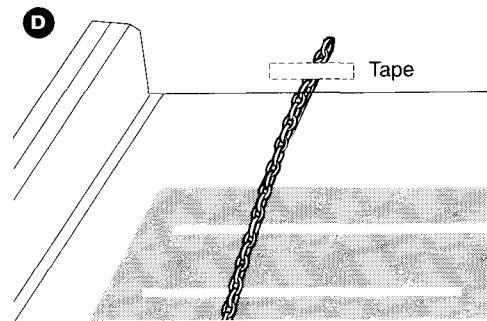

NOTE:

- If attaching to masonry, you can buy suitable screws and anchors at hardware stores. Use a masonry drill to drill the required holes.
- If range is removed for cleaning or any other reason, make sure chain is reattached.

QUESTIONS? USE THIS PROBLEM SOLVER

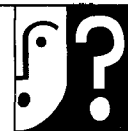

PROBLEM	POSSIBLE CAUSE
"F-" AND A NUMBER FLASH ON DISPLAY	<ul style="list-style-type: none"> • If the time display flashes "F-" and a number, you have a function error code. Press the CLEAR/OFF pad. Allow oven to cool for 1 hour. If the failure code repeats, disconnect all power to the range. Call for service.
COOKTOP FEELS HOT	<ul style="list-style-type: none"> • Because the surface units heat by conduction, the cooktop surface may seem hotter than you are used to. This is normal. Make sure flat-bottom pans are used.
SURFACE UNITS WILL NOT MAINTAIN A ROLLING BOIL OR FRYING RATE IS NOT FAST ENOUGH	<ul style="list-style-type: none"> • Pans which are absolutely flat must be used. • Pan bottoms should closely match the diameter of the cooking zone selected.
FOODS COOK SLOWLY	<ul style="list-style-type: none"> • Improper cookware being used. Pan bottoms should be flat, fairly heavy weight and the same diameter as the cooking zone selected.
SURFACE UNITS DO NOT WORK PROPERLY	<ul style="list-style-type: none"> • Difficulty may be in the main distribution panel of your house, caused by a blown oven-circuit fuse, a tripped oven-circuit breaker, the main fuse or the main circuit breaker depending on the nature of the power supply. If a circuit breaker is involved, reset it. If the control box uses fuses, the oven fuse (a cartridge-type) should be changed BUT ONLY BY SOMEONE FAMILIAR WITH ELECTRICAL CIRCUITS. If after doing 1 of these procedures the fuse blows or circuit breaker trips again, call for service. NOTE: Apartment tenants or condominium owners should ask their building management to perform this check before calling for service. • Cooktop surface unit controls are not properly set, or the wrong control knob is set for the surface unit you are using.
TINY SCRATCHES (MAY APPEAR AS CRACKS) OR ABRASIONS ON RADIANT COOKTOP GLASS SURFACE	<ul style="list-style-type: none"> • Incorrect cleaning methods have been used, or coarse particles (salt or sand) are between cookware and surface of cooktop, or the cookware with a rough bottom has been used. Use recommended cleaning procedure, be sure cookware bottoms are clean before use, and use cookware with smooth bottoms. Tiny scratches are not removable but will become less visible in time as a result of cleaning.
METAL MARKINGS (MAY APPEAR AS SCRATCHES)	<ul style="list-style-type: none"> • Do not slide aluminum cookware across the surface. Use recommended cleaning procedure to remove marks. • Incorrect cleaning materials have been used, encrusted boilovers or grease spatters remain on the surface. Use a razor scraper and recommended cleaning procedure.
DARK STREAKS OR SPECKS	<ul style="list-style-type: none"> • Use a razor scraper and recommended cleaning procedure.
AREAS OF DISCOLORATION ON COOKTOP	<ul style="list-style-type: none"> • Mineral deposits from water or food can be removed with Cook Top Cleaning Creme.
HOT SUGAR MIXTURES/ PLASTIC MELTED TO THE SURFACE	<ul style="list-style-type: none"> • Turn the surface unit to LO, wipe the hot cooktop with several dry paper towels. Use a razor scraper held at a 30° angle to the cooktop to scrape the hot spill to a cool area outside the surface unit. Let the cooktop cool. Clean with Cook Top Cleaning Creme.
FREQUENT CYCLING OFF AND ON OF SURFACE UNITS	<ul style="list-style-type: none"> • Incorrect cookware used. Use only flat cookware to minimize cycling.

(continued next page)



THE PROBLEM SOLVER

(continued)

PROBLEM	POSSIBLE CAUSE
FOOD DOES NOT BROIL PROPERLY	<ul style="list-style-type: none">•Oven controls not properly set. See the Broiling section.•Door not left ajar as recommended.•Improper shelf position being used. See the Broiling Guide.•Food is being cooked on hot pan.•Cookware is not suited for broiling.•Aluminum foil used on the broiler pan rack has not been fitted properly and slit as recommended.
FOOD DOES NOT ROAST OR BAKE PROPERLY	<ul style="list-style-type: none">•Oven controls not properly set.•Shelf position is incorrect.•Incorrect cookware or cookware of improper size is being used.•A foil tent was not used when needed to slow down browning during roasting.
OVEN WILL NOT WORK	<ul style="list-style-type: none">•Plug on range is not completely inserted in the electrical outlet.•The circuit breaker in your house has been tripped, or a fuse has been blown.•Oven controls not properly set.
OVEN TEMPERATURE TOO HOT OR TOO COLD	<ul style="list-style-type: none">•Oven thermostat needs adjustment. See the Adjusting Thermostat section.
CLOCK AND TIMER DO NOT WORK	<ul style="list-style-type: none">•Make sure the electrical plug is plugged into a live, properly grounded power outlet.•Check for power outage.•See the Oven Control, Clock and Timer section.
OVEN LIGHT DOES NOT COME ON	<ul style="list-style-type: none">•Bulb may be loose or burned out, especially if the oven control/clock is working.•Switch operating oven light is broken; call for service.
OVEN WILL NOT SELF-CLEAN	<ul style="list-style-type: none">•Oven temperature is too high to set self-clean operation. Allow the range to cool to room temperature and reset the controls.
DOOR WON'T OPEN AFTER SELF-CLEAN CYCLE	<ul style="list-style-type: none">•When the temperature has fallen below the safe locking temperature the door can be opened.
OVEN NOT CLEAN AFTER CLEAN CYCLE	<ul style="list-style-type: none">•Oven controls not set properly.•Heavily soiled ovens require 3 ½ to 4-hour clean time.•Heavy spillovers should be cleaned up before starting clean cycle.
CONTROL BEEPS AFTER ENTERING OVEN TIME OR STOP TIME	<ul style="list-style-type: none">•This is reminding you to enter a bake temperature.
“BURNING” OR “OILY” ODOR EMITTING FROM OVEN WHEN TURNED ON	<ul style="list-style-type: none">•This is normal in a new oven and will dissipate in time. To speed the process, set a self-clean cycle (see Operating the Self-Cleaning Oven section) lasting a minimum of 3 hours.

**If you need more help.. call, toll free:
GE Answer Center™
800.626.2000**

With the purchase of your new GE appliance, receive the assurance that if you ever need information or assistance from GE, we'll be there. All you have to do is call—toll-free!

h-Home Repair Service **800-GE-CARES (800-432-2737)**

A GE consumer service professional will provide expert repair service, scheduled at a time that's convenient for you. Many GE Consumer Service company-operated locations offer you service today or tomorrow, or at your convenience (7:00 a.m. to 7:00 p.m. weekdays, 9:00 a.m. to 2:00 p.m. Saturdays). Our factory-trained technicians know your appliance inside and out—so most repairs can be handled in just 1 visit.

GE Answer Center® **800.626.2000**

Whatever your question about any GE major appliance, GE Answer Center® information service is available to help. Your call—and your question—will be answered promptly and courteously. And you can call any time. GE Answer Center® service is open 24 hours a day, 7 days a week.

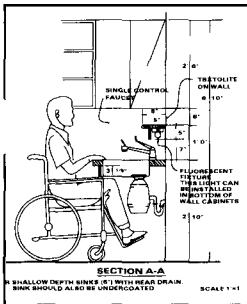

For Customers With Special Needs... **800.626.2000**

Upon request, GE will provide Braille controls for a variety of GE appliances, and a brochure to assist in planning a barrier-free kitchen for persons with limited mobility. To obtain these items, free of charge, call 800.626.2000.”

Consumers with impaired hearing or speech who have access to a TDD or a conventional teletypewriter may call 800-TDD-GEAC (800-833-4322) to request information or service.

Service Contracts **800-626-2224**

You can have the secure feeling that GE Consumer Service will still be there after your warranty expires. Purchase a GE contract while your warranty is still in effect and you'll receive a substantial discount. With a multiple-year contract, you're assured of future service at today's prices.

Parts and Accessories **800-626-2002**

Individuals qualified to service their own appliances can have needed parts or accessories sent directly to their home. The GE parts system provides access to over 47,000 parts...and all GE Genuine Renewal Parts are fully warranted. VISA, Mastercard and Discover cards are accepted.

User maintenance instructions contained in this booklet cover procedures intended to be performed by any user. Other servicing generally should be referred to qualified service personnel. Caution must be exercised, since improper servicing may cause unsafe operation.

YOUR GENERAL ELECTRIC RANGE WARRANTY

Staple sales slip or cancelled check here. Proof of original purchase date is needed to obtain service under warranty.

WHAT IS COVERED

FULL ONE-YEAR WARRANTY

For one year from date of original purchase, we will provide, free of charge, parts and service labor in your home to repair or replace **any part of the range** that fails because of a manufacturing defect.

This warranty is extended to the original purchaser and any succeeding owner for products purchased for **ordinary** home use in the 48 mainland states, Hawaii and Washington, D.C. In Alaska the warranty is the same except that it is **LIMITED** because you must pay to ship the product to the service shop or for the service technician's travel costs to your home.

All warranty service will be provided by our Factory Service Centers or by our authorized Customer Care[®] servicers during normal working hours.

Should your appliance need service, during warranty period or beyond, call 800-GE-CARES (800-432-2737).

WHAT IS NOT COVERED

- Service trips to your home to teach you how to use the product

Read your Use and Care material

If you then have any questions about operating the product, please contact your dealer or our Consumer Affairs office at the address below, or call, toll free:

GE Answer Center[®]
800.626.2000
consumer information service

- Improper installation.

If you have an installation problem, contact your dealer or installer. You are responsible for providing adequate electrical, gas, exhausting and other connecting facilities as described in the Installation Instructions provided with the product.

- Replacement of house fuses or resetting of circuit breakers.

- Failure of the product if it is used for other than its intended purpose or used commercially.
- Damage to product caused by accident, fire, floods or acts of God.

WARRANTOR IS NOT RESPONSIBLE FOR CONSEQUENTIAL DAMAGES.

Some states **do not allow the** exclusion or limitation of incidental or consequential damages, so the above limitation or exclusion may not apply to you. **This warranty gives you specific legal rights, and you may also have other rights which vary from state to state. To know what your legal rights are in your state, consult your local or state consumer affairs office or your state's Attorney General.**

Warrantor: General Electric Company

**If further help is needed concerning this warranty, write:
Manager—Consumer Affairs, GE Appliances, Louisville, KY 40225**

Part No. 164D2588P231

Pub No. 49-8432

MNU078 Rev. 5

2-93 CG

JSP38
JSP38GS
JSP39GR
JSP40AS

Printed in LaFayette, GA