

TOSHIBA

Color Television

OWNER'S MANUAL

CN27D90

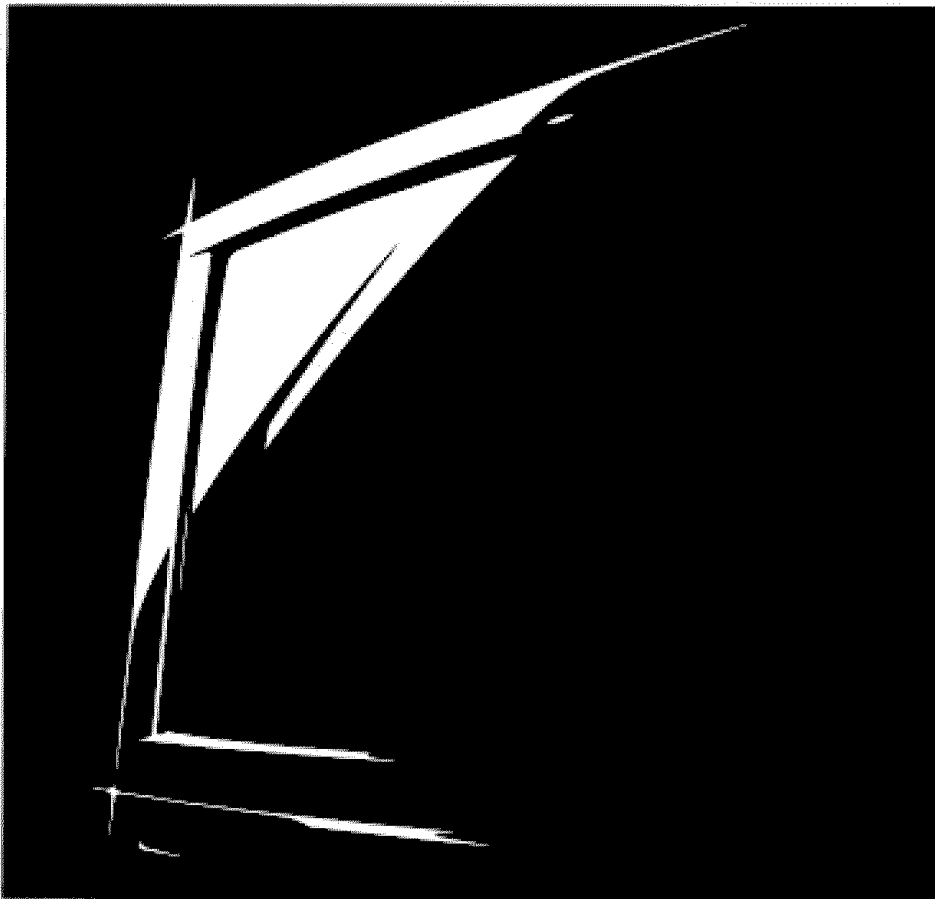

SET UP

PREPARATION

BASIC OPERATION

ADVANCED
OPERATION

EQUIPMENT
CONNECTIONS

REFERENCE
SECTION

Dear Customer

Congratulations! You have purchased one of the finest Color TV's on the market!

This manual will help you use the many exciting and useful features to make your TV viewing more enjoyable than ever before.

Before operating your TV set, please read all these safety and operating instructions completely and then retain for future reference.

Customer's Record

You will find the model number and serial number on the back of your TV set.

Record these numbers in the spaces provided below. Refer to them whenever you call upon your TOSHIBA dealer regarding this product.

Model Number _____

Serial Number _____

SAFETY PRECAUTIONS

WARNING:

TO REDUCE THE RISK OF FIRE OR ELECTRIC SHOCK, DO NOT EXPOSE THIS APPLIANCE TO RAIN OR MOISTURE.

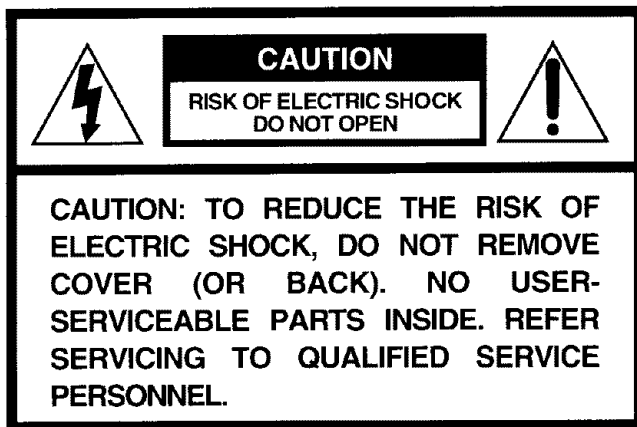

CAUTIONS:

TO PREVENT ELECTRIC SHOCK, DO NOT USE THIS POLARIZED PLUG WITH AN EXTENSION CORD RECEPTACLE OR OTHER OUTLET UNLESS THE PRONGS CAN BE FULLY INSERTED INTO THE OUTLET TO PREVENT ANY EXPOSURE OF THE PRONGS ON THE POLARIZED PLUG.

Avoid displaying stationary images on your TV screen for extended periods of time. Stationary patterns generated by PIP display, computer displays, video games, stock market reports etc. can become permanently engrained on the picture tube. This damage is not protected by your warranty as it is the result of misuse. Should you wish to use your TOSHIBA Television to display still images, it is always advisable to reduce brightness and contrast settings. Never leave a PIP display, computer display or video game unattended.



The lightning symbol in the triangle tells you that the voltage inside this product may be strong enough to cause an electric shock. **DO NOT TRY TO SERVICE THIS PRODUCT YOURSELF.**



The exclamation point in the triangle tells you that important operating and maintenance instructions follow this symbol.

This TV set may be used only with TOSHIBA stand model ST2704. Use with other stands may result in instability causing possible injury.

NOTE TO CATV SYSTEM INSTALLER:

This reminder is provided to call the CATV system installer's attention to Article 820-40 of the NEC that provides guidelines for proper grounding and, in particular, specifies that the cable ground shall be connected to the grounding system of the building, as close to the point of cable entry as practical.

TABLE OF CONTENTS

Set Up

Installing your TV set	4
Antenna/Cable TV general information	5
Home antenna connection	6
Cable TV connection	7
Antenna/Cable TV and VCR connections	8

Preparation

Location of controls (TV set)	10
Location of controls (Remote Control)	12
Before using the Remote Control	13
Using the Remote with VCR or	
Cable TV converter	14
Programming the Remote Control	15
Menu function (general instructions)	18
TV channels	20
Selecting the antenna input	21
Programming channel memory	22

Basic Operation

Watching TV programs	24
Convenient Remote functions	25
Adjusting the Picture	26
Adjusting the Sound	27
Selecting Stereo/SAP broadcasts	28

Advanced Operation

Enhancing the Surround sound effect	29
Watching Picture in Picture (PIP)	30
Captioning channels	32
Locking channels	34
Operating closed captioning feature	36
Changing on-screen display language	38
Activating on-screen demonstration	39

Equipment Connections

Monitor panel	40
Connecting a standard VCR	41
Connecting a VCR with an S-video jack	42
Connecting a camcorder	43
Connecting an audio amplifier	44
Connecting external speakers	45

Reference Section

Cleaning and care	46
Specifications	46
Before calling service personnel	47
Limited warranty	48

INSTALLING YOUR TV SET

WARNING:

TO AVOID INJURY TO A CHILD OR ADULT:

- Do not place the TV on an uneven floor or on unstable stand.
- Do not stand or climb on the TV.
- Do not put a VCR or any heavy object on top of the TV.

DO NOT:

- Place your TV set in a room where direct lighting strikes the screen.
- Place your TV set too close to a wall, in a confined area or in a very warm location.
- Change the plug's safety prong.

DO:

- Use soft and indirect lighting.
- Sit at least 6 feet away from the set.
- Provide normal air circulation for reliable long life.
- Plug into an electrical outlet with standard house power (120 volt AC, 60 Hz).

CAUTION:

As a safety feature, the plug has one prong wider than the other. It will fit only one way into a standard electrical outlet. If the plug will not fit into the outlet, try turning it around. If the plug will not fit either way, the outlet is probably old and non-standard. You will need to have a new outlet installed by an electrician. DO NOT CHANGE THE SAFETY FEATURE OF THE PLUG.

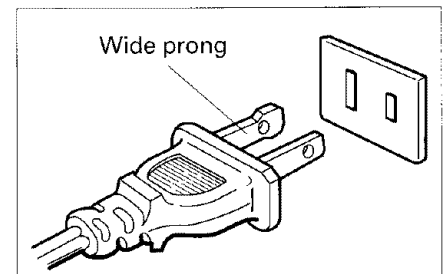

ANTENNA/CABLE TV GENERAL INFORMATION

- You can use either an indoor or outdoor antenna to receive VHF and/or UHF channels.
- Channels 2-13 are VHF channels, and channels 14-69 are UHF channels.
- We recommend using an outdoor antenna for better picture quality.
- You can receive Cable TV by contacting your local cable company.
- Cable TV delivers both VHF and UHF channels and other channels not available to your antenna.

TYPES OF ANTENNA CABLES

Shown below are two basic types of antenna cables. Signals from a home antenna may be conveyed by either type. Cable TV signals will always be conveyed by a 75 ohm coaxial cable.

- 1 A 75 ohm coaxial cable is generally a round cable with F-type connectors that can easily be attached to a terminal without tools.

Optional F-type connector



- 2 A 300 ohm cable is a flat "twin-lead" cable that can be attached to a terminal through an antenna adapter supplied as an accessory.

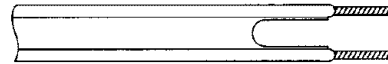

ANTENNA CONNECTION PANEL

There are two separate 75 ohm F-type connector terminals and a converter output terminal as shown below.

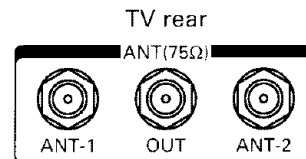

The ANT-1 and ANT-2 terminals are for connecting a VHF/UHF antenna or a cable TV system. The signal, which is input on the ANT-1, also is output from the OUT terminal whenever the RF switcher in the TV is in the ANT-2 position. You can switch between the ANT-1 and ANT-2 positions by pressing the ANT 1/2 button on the Remote Control or the ANT/VIDEO button on the TV. See page 21.

HOME ANTENNA CONNECTION

Connecting a single lead-in cable

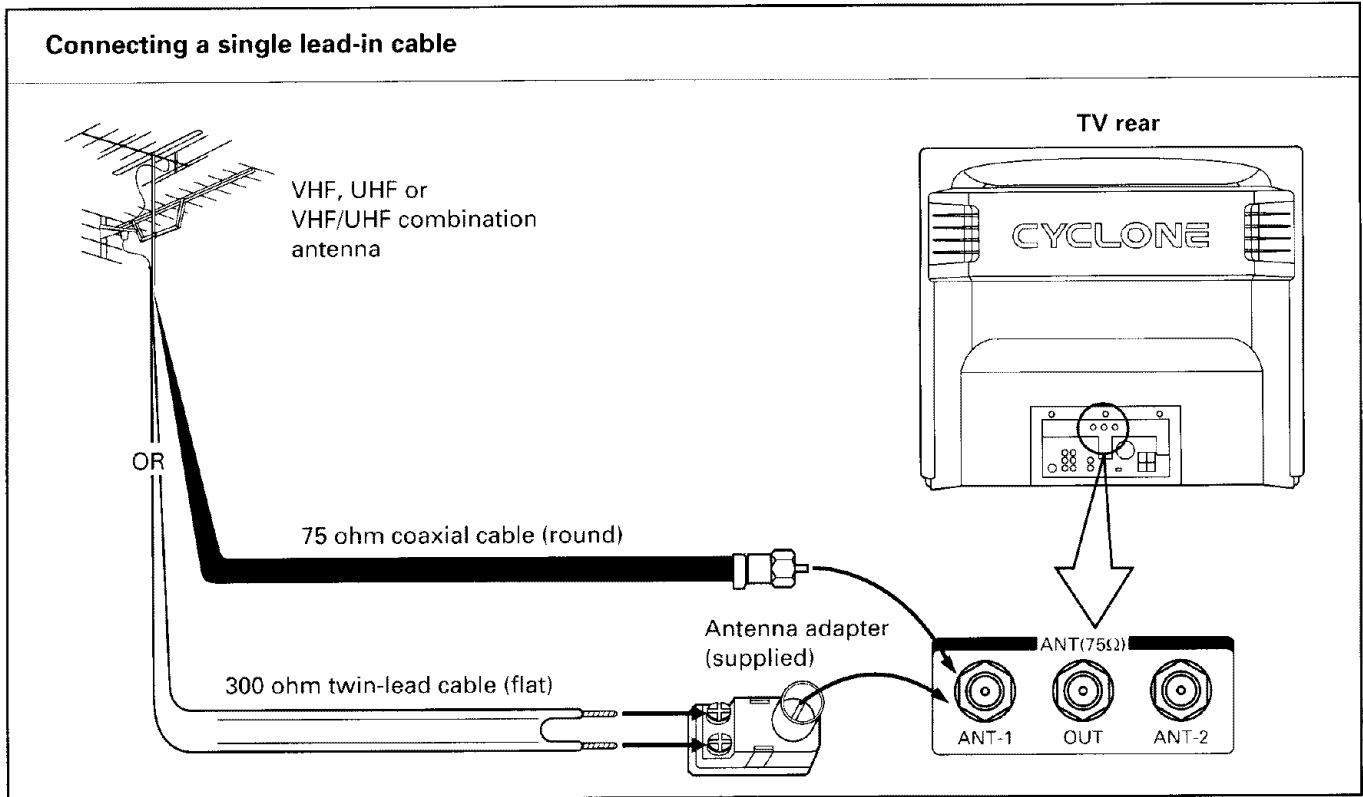

Connecting both VHF and UHF lead-in cables

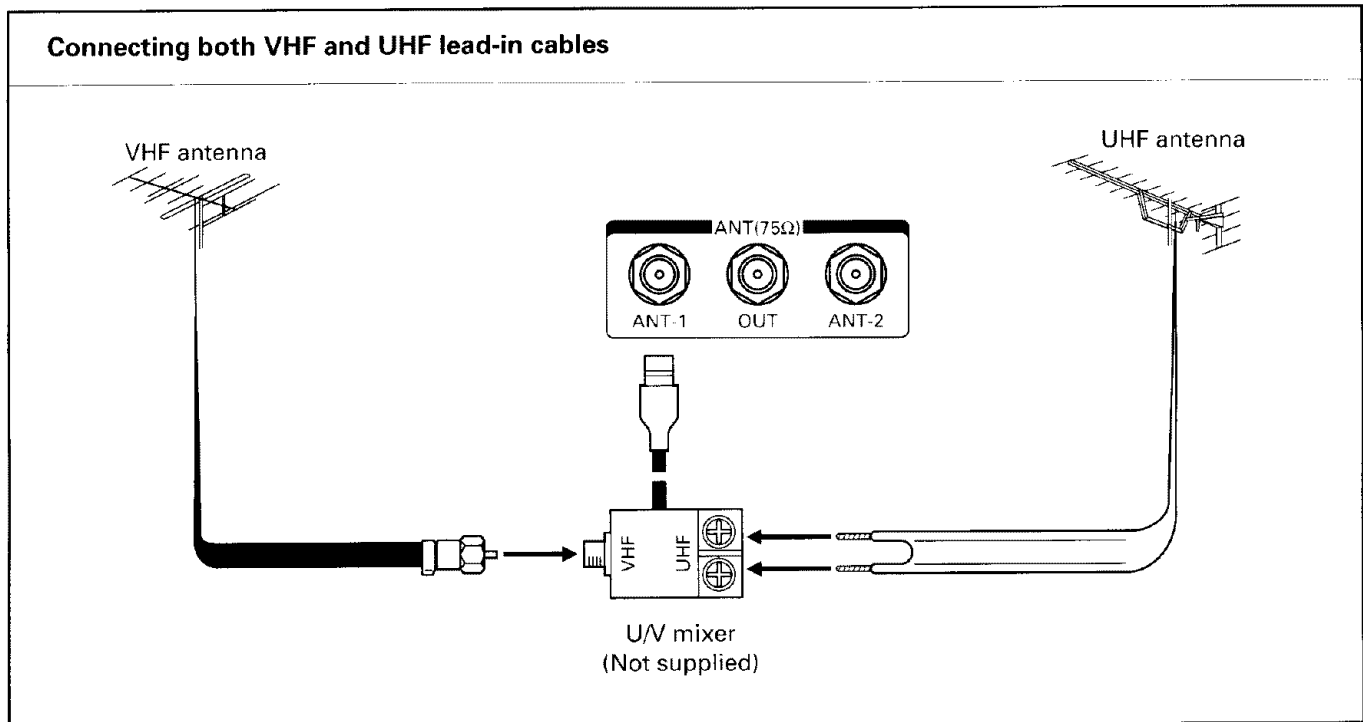

Note: You can connect another signal source like a cable TV system or video game to the ANT-2 terminal.

CABLE TV CONNECTION

Generally, the incoming cable for a Cable TV system can be connected directly to the TV antenna terminal just like a home antenna connection. Simply attach it to the ANT-1 (or ANT-2) terminal. You will be able to receive unscrambled cable channels.

SET UP

Cable without a decoder box (Unscrambled channels)



Note: You can connect another signal source like a home antenna or video game to the ANT-2 terminal.

Some cable companies offer "premium pay channels". Since the signals of these premium pay channels are scrambled, a cable TV converter/decoder is generally provided to the subscriber by the cable TV company. This decoder box is necessary for normal viewing of the scrambled channels. For more specific instructions on installing cable TV, consult your cable TV company.

Home antenna connection / Cable TV connection

Cable with a decoder box (Unscrambled and Scrambled channels)

You can choose between viewing unscrambled channels and scrambled channels by pressing the ANT 1/2 button or the ANT/VIDEO button. See page 21.

The unscrambled channels will come thru the ANT-1 terminal when the "ANT 1" mode is selected.

The scrambled channels from the decoder box will come thru the ANT-2 terminal when the "ANT 2" mode is selected. Place your TV on channel 3 or 4 to match your converter's output channel and select channels using the converter's channel keys.

Note: The descrambler device may or may not be a part of the cable converter.

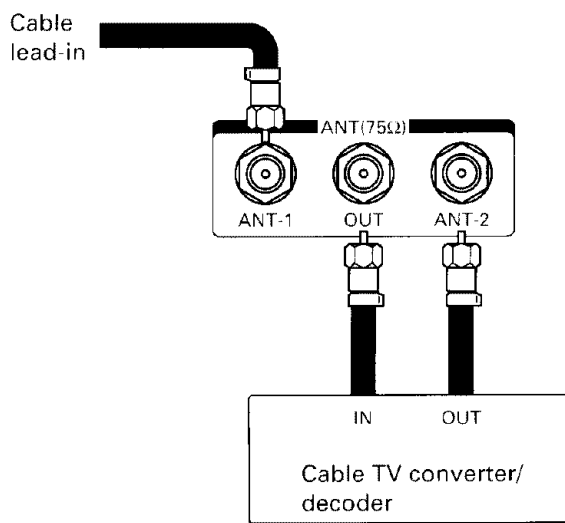

ANTENNA/CABLE TV AND VCR CONNECTIONS

Antenna/Cable connection via VCR (simplified method)

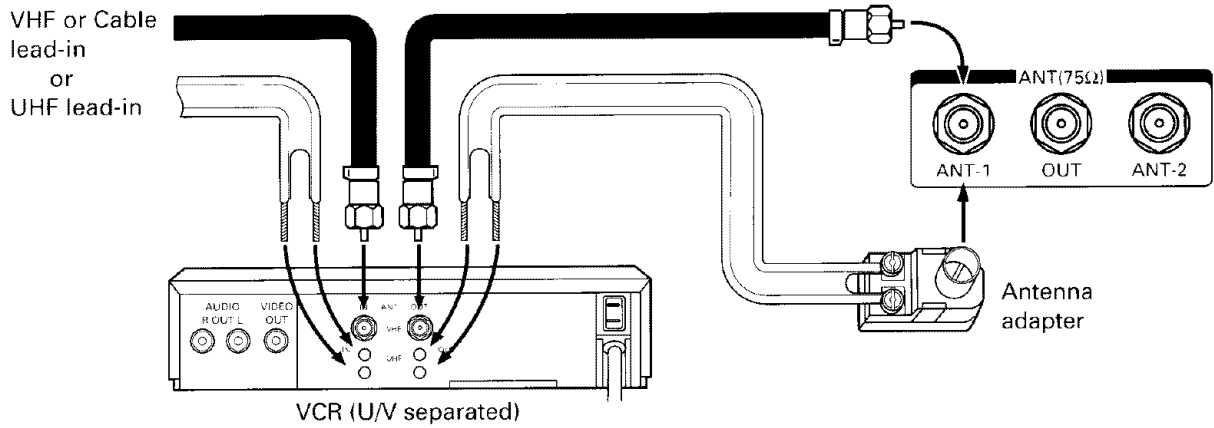

Notes:

- On many VCR's, playing tapes causes the VCR's TV/VCR switching to disconnect the antenna signals from the TV. If you cannot select a certain channel, try pressing the TV/VCR button on the Remote Control.
- If you connect both VHF and UHF lead-in cables, use an optional U/V mixer. See page 6.

Using a 2-way signal splitter

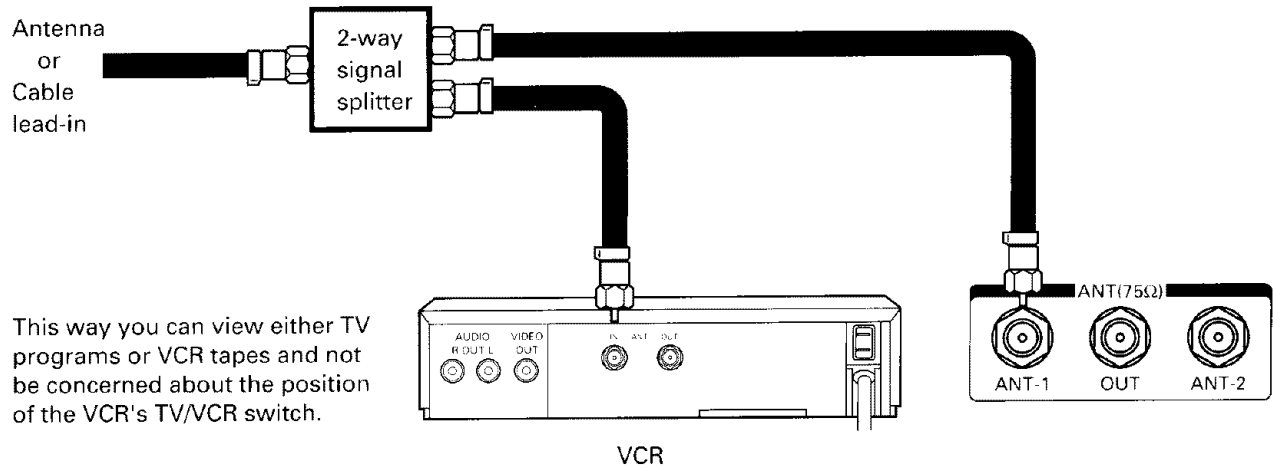

Note: When connected either way, the VIDEO/AUDIO connections from the VCR to the TV are required for (stereo) playback from VCR's. See pages 41 and 42 for connection details.

Cable with a decoder box and a VCR

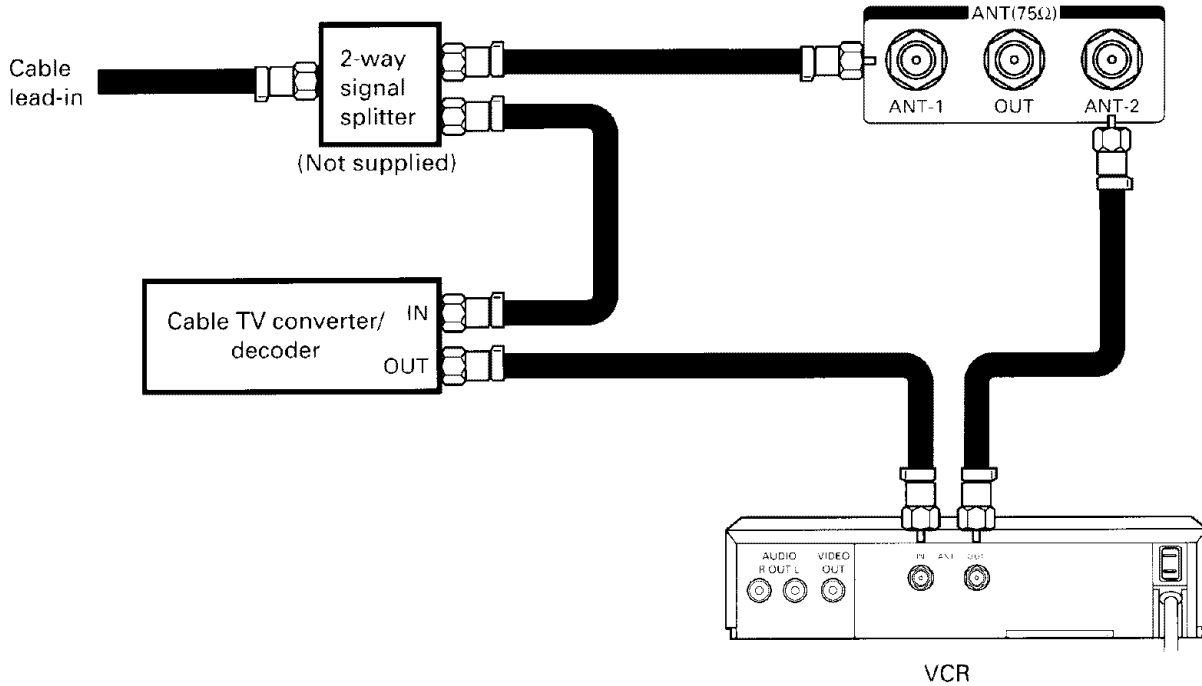

The unscrambled channels will come thru the ANT-1 terminal whenever the ANT 1/2 button or the ANT/VIDEO button is in "ANT 1" mode.

The scrambled channels from the decoder box will come thru the VCR and the ANT-2 terminal whenever the ANT 1/2 button or the ANT/VIDEO button is in "ANT 2" mode. Place your TV and VCR on channel 3 or 4 to match your converter's output channel. See page 21.

Note: When connected this way, the VIDEO/AUDIO connections from the VCR to the TV are required for stereo tape playback from stereo VCR's. See pages 41 and 42 for connection details.

LOCATION OF CONTROLS (TV set)

For specific use of each control, consult the corresponding page numbers in brackets.

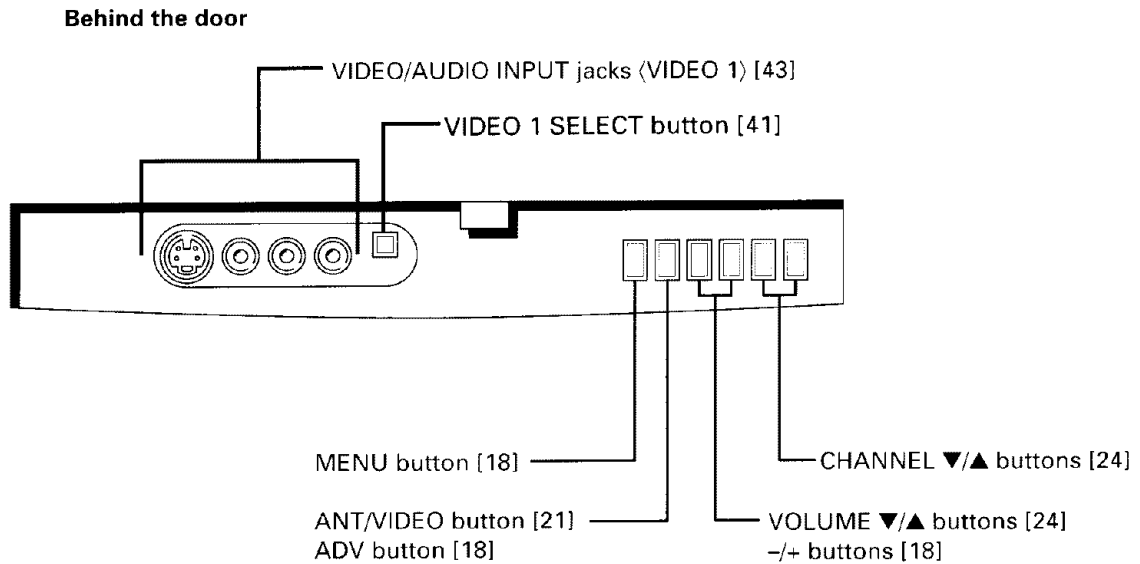
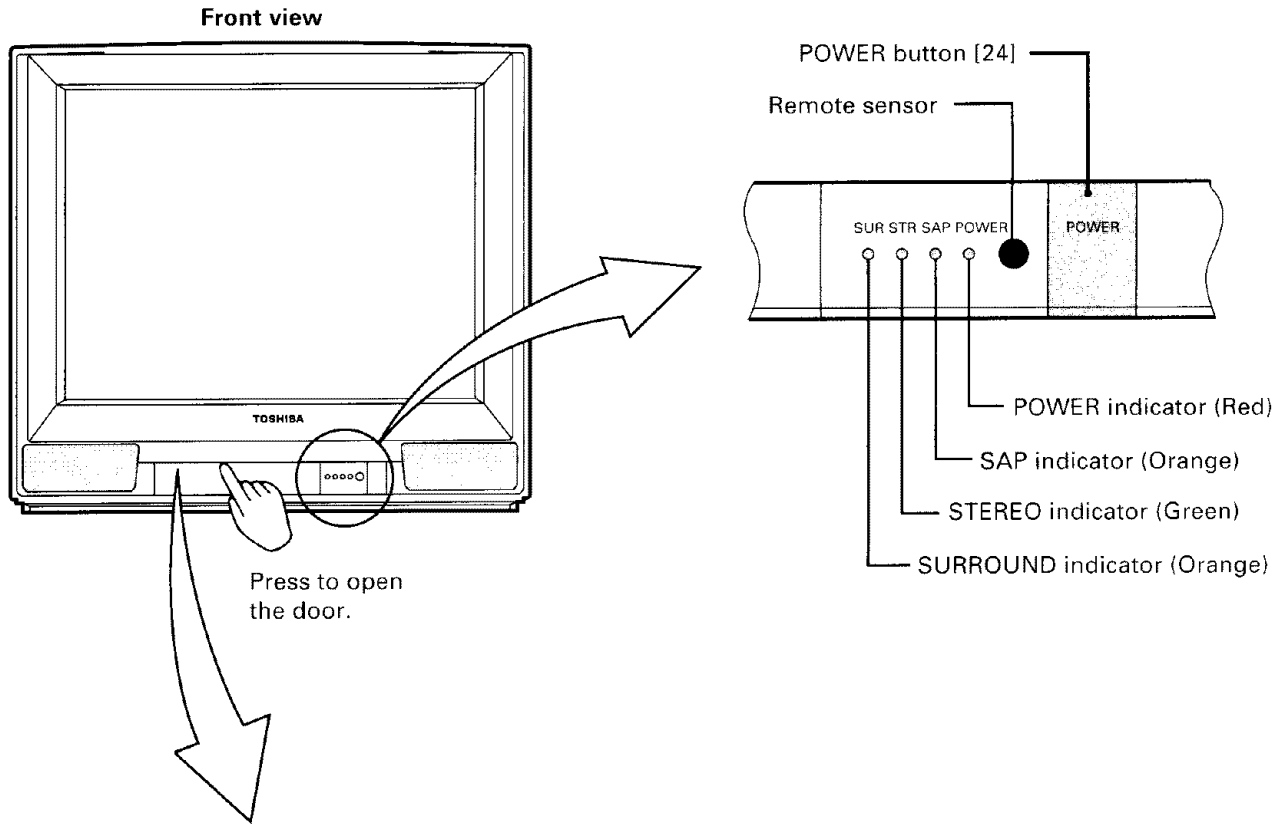

Rear view

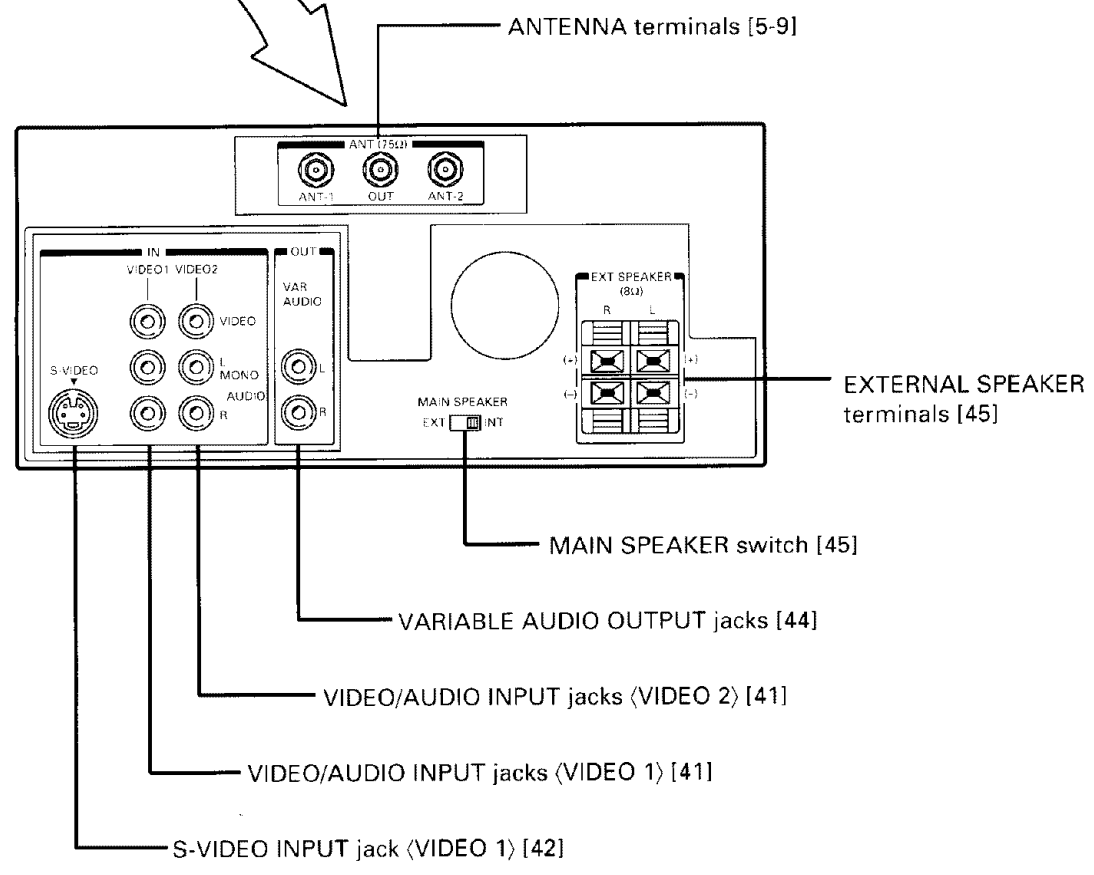
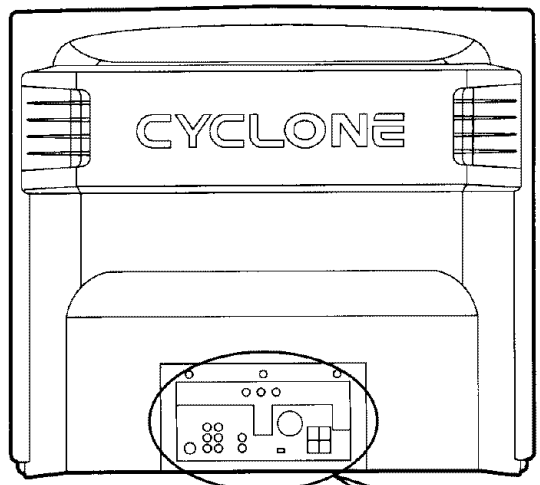

LOCATION OF CONTROLS (Remote Control)

Only the buttons that are used to operate the TV set are described here.
For details on the use of each control, refer to pages in brackets.

Aim at the remote sensor on the TV

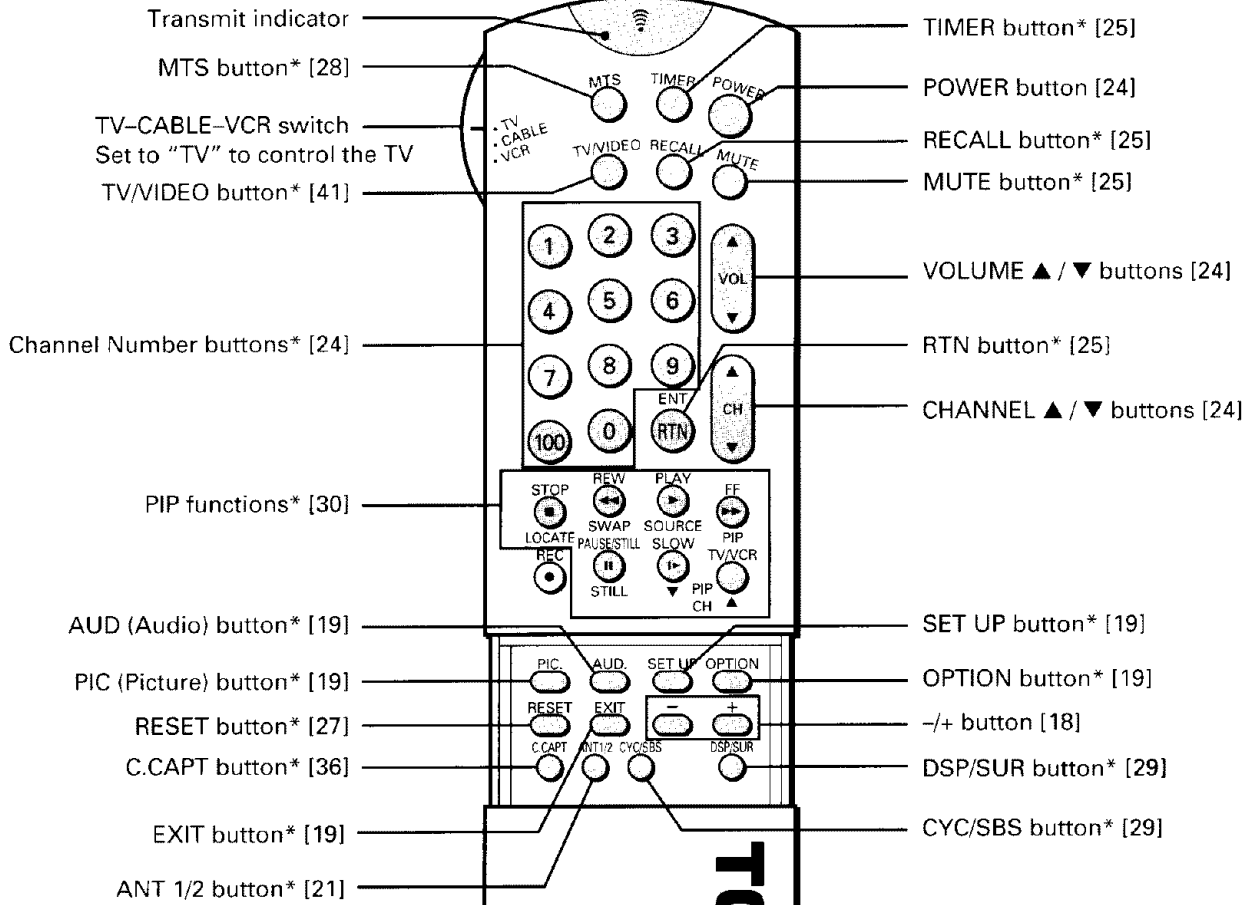

To operate buttons inside the cover, slide the cover down and toward you.

* These functions do not have duplicate locations on the TV set. They can be controlled only with the Remote Control.

BEFORE USING THE REMOTE CONTROL

INTRODUCTIONS

With this Remote Control, you can operate your TV and most models of remote-controlled VCR's and Cable TV Converters even if they are different brands. However, this Remote Control must be programmed to control other brands of VCR's and/or Converters. If you will be using your TV set with a TOSHIBA VCR, your Remote has already been preprogrammed for you.

- Before attempting to operate your Remote Control, install the batteries according to the section "INSTALLING AND REPLACING BATTERIES" shown below.
- For more detailed instructions, see the section "PROGRAMMING THE REMOTE CONTROL" on page 15.

Notes:

- After installing new batteries, the Remote Control will set itself to the codes for TOSHIBA's TV and VCR. If you are using the Remote Control to operate equipment that uses different codes, it will have to be reprogrammed for those codes.
- This Remote Control may have functions not available on the original remote control.
- These functions may or may not operate your VCR or Cable TV Converter. Refer to the owner's manuals supplied with the equipments to see which functions are available.
- The remote control supplied with your VCR or Cable TV Converter may have keys not duplicated on this Remote Control. If these functions are desired, the original remote will have to be used.

PREPARATION

INSTALLING AND REPLACING BATTERIES

- 1 Place the Remote Control with the face down. Press down on the ridged area of the battery cover and slide it off.

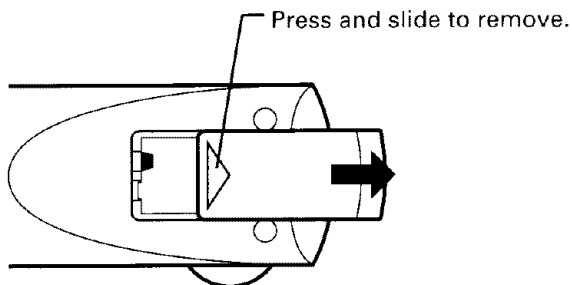

- 2 Place two "AA" size batteries, matching the + and - signs on each battery to the + and - signs of the battery compartment.

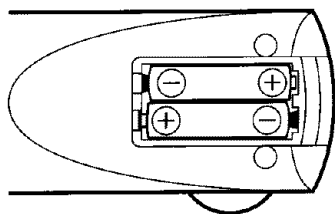

- 3 Replace the battery cover until the lock snaps.

TIPS FOR BEST OPERATION

- For optimum performance, aim the Remote Control directly at the TV from a distance no more than 23 ft (7m) and be sure there is no obstruction between the Remote Control and the TV.
- If your Remote Control does not always adjust the TV as you wish, you probably need to replace the batteries. See the directions at the left.
- Remove dead batteries immediately to prevent battery acid from leaking into the battery compartment.
- If you do not intend to use the Remote Control for a long period, remove the batteries.

CAUTION:

- Do not throw your batteries into a fire. Dispose of your batteries in a designated disposal area.
- Do not combine used old batteries with new ones.
- Do not mix battery types.

Location of controls (Remote Control) / Before using the Remote Control

USING THE REMOTE WITH VCR OR CABLE TV CONVERTER

- To control TOSHIBA VCR, first set the TV-CABLE-VCR switch to "VCR" position. The buttons shown below will then control the VCR. The rest of the buttons operate the TV as usual.
If you have another brand of VCR, you can probably program your Remote to control it.
Details are on page 15.
- To control a cable TV converter, this Remote Control must be programmed to recognize the brand of your converter.
See page 15.
Set the TV-CABLE-VCR switch to "CABLE" position whenever you control the cable TV converter.

Aim at the VCR or cable TV converter

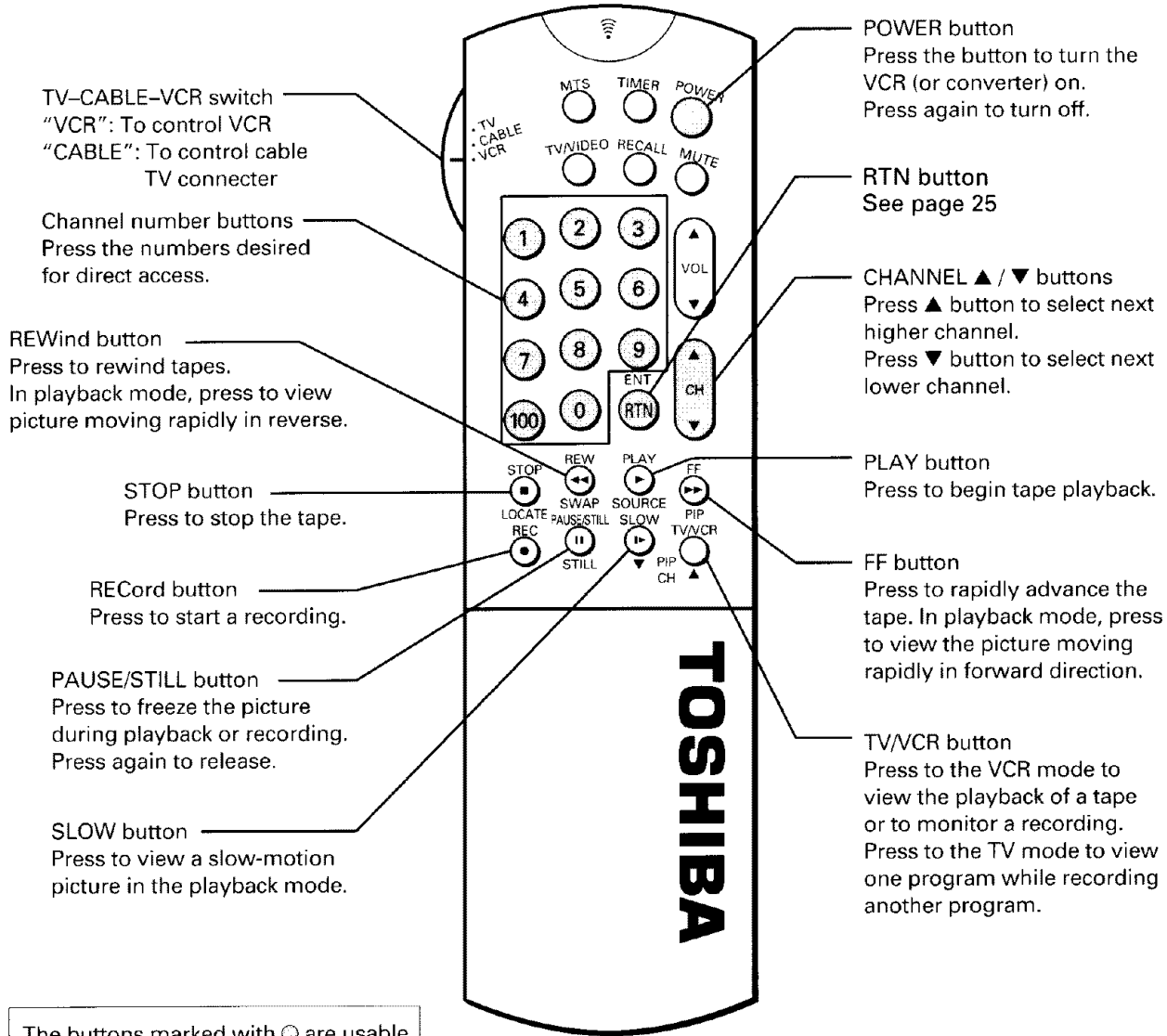

The buttons marked with ○ are usable to control the cable TV converter

PROGRAMMING THE REMOTE CONTROL

- This Remote Control is preprogrammed to operate TOSHIBA VCR's.
- To use VCR's other than Toshiba models (or Cable converter), perform the following procedures before operating.

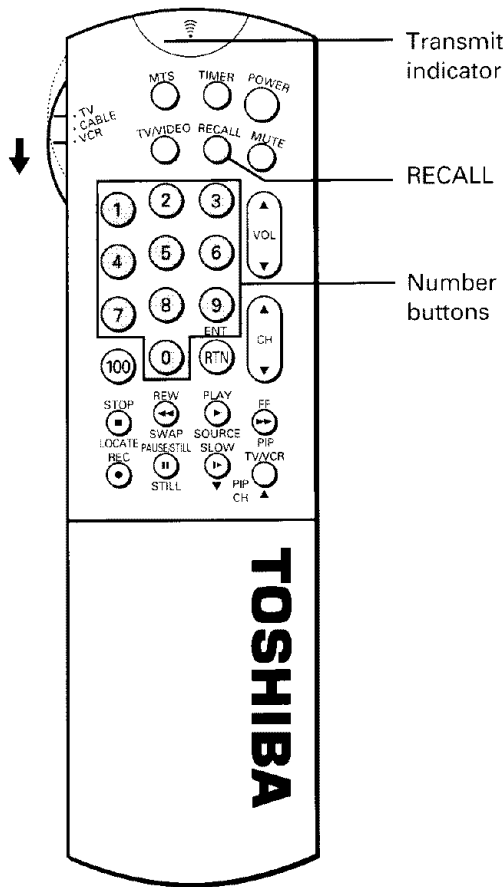

TO CONTROL OTHER BRANDS OF VCR'S AND CABLE TV CONVERTERS

1 Refer to the "**VCR code table**" (or "**Cable TV converter code table**") on pages 16 and 17 to find the code number that corresponds to the brand name of your VCR (or your converter).

If more than one number is listed, try each one separately until you find the one that works.

2 Set the **TV-CABLE-VCR** switch to VCR (or CABLE).

3 Hold down **RECALL** while pressing the **Number** buttons for the three digit code number for your brand of VCR (or converter). The transmit indicator lights up for 1 second when the programming is completed.

When an operation error has occurred, the indicator blinks. Press **RECALL** again to reset.

4 Point the Remote Control at the VCR (or at the converter) and press **POWER** to test the code number.

- If the **right number was entered**, the VCR should turn on.
- If the **VCR does not respond to the Remote Control**, repeat steps 1 to 4 with another code number.

Notes:

- You have to reprogram the Remote Control when you change its batteries.
- Some newer VCR's are capable of working on either of two remote codes. These VCR's have a switch labeled "VCR1/VCR2". If your VCR has this kind of switch, and does not respond to all the code numbers for your VCR brand name, set the switch to another position ("VCR1" or "VCR2") and reprogram the Remote Control.

For future reference, write the code you used.

VCR CODE: _____

CABLE CODE: _____

PREPARATION

Using the Remote with VCR or Cable TV converter / Programming the Remote Control

PROGRAMMING THE REMOTE CONTROL (Continued)

• The code numbers listed below are the newest ones at the time of printing. New code numbers may or may not have been added since printing.

VCR code table

BRAND NAME	CODE NUMBER	BRAND NAME	CODE NUMBER	BRAND NAME	CODE NUMBER
Aiko	297	Goodmans	019,039,056,081,091,297	Osaki	019,056,091
Aiwa	019	Gradiente	019	Otto Versand	100
Akai	060,068,080,125,261	Graetz	060,123	Pallidium	091
Alba	039,228,297	Granada	065,100,123	Panasonic	054,096,244
Amstrad	019	Grundig	100	Penney	054,056,057,059,061,259
Anitech	091	Harman/Kardon	057	Pentax	061,084,124
ASA	056,100	Hem	091	Perdio	019
Audiovox	056	Hinari	091,227	Philco	054
Baird	123	Hitachi	019,060,061,084,124	Philips	054,081,100,129
Bell & Howell	123	Imperial	019	Phonola	100
Broksonic	140,203,230	Interfunk	100	Pilot	056
Bush	091,228,297	ITT	060,065,123,125	Pioneer	086,100
Canon	054	JCL	054	Portland	039
Capehart	039	Jensen	060	Proline	019
Carver	100	JVC	027,060,086	Pulsar	058
CCE	091,297	Kendo	125	Pye	100
CGE	019	Kenwood	057,060,065,086	Quartz	065
Cimline	091	Lloyd	019	Quasar	054,115
Condor	039	Loewe	056	Quelle	100
Craig	066,259	Loewe opta	100	Radiola	100
Crown	297	Logik	019,259	RCA	054,061,084,096,124,168,221
Curtis Mathes	054	Luxor	062,065,125	RCA Unified	079
Daewoo	039,064,065,297	LXI	056	Realistic	019,054,056,065,066,067,081,085,123,259
Dansai	091	Magnavox	019,054,100,129,168	Rex	060
Daytron	039	Manesth	064,091	Ricoh	053
De Graaf	061	Marantz	054,057,081,100	Roadstar	056,091,259
Decca	019,100	Marta	056	Runco	058
Dual	060	Matsui	227,228	Saba	060
Dumont	019,100,123,124	MEI	054	Saisho	227,228
Dynatech	019	Memorex	019,054,056,058,065,066,067,123	Salora	062,065,125
Electronic	019	MGA	062,080	Samsung	064,259
Emerson	019,021,056,080,140,203,227,228,230,231,313	Minolta	061,124	Sansui	060,086
ESC	297	Mitsubishi	062,080,086,100,192,233,261	Sanyo	065,066,123,259
Ferguson	060	MTC	019,259	SBR	100
Fidelity	019	Multitech	019,091	Scaub Lorenz	019,060
Finlandia	100,123,129	Murphy	019	Schneider	019,091,100,129
Finlux	019,061,100,123,124	NEC	057,059,060,069,086	Scott	064,140,203,229,231
First line	062,091	Neckermann	100	Sears	054,056,061,065,066,073,085,123,124
Fisher	065,066,073,085,123	Nikko	056	SEI	100
Frontech	039	Noblex	259	Sentra	039
Funai	019	Nokia	060,065,123,125,259	Sharp	076,081
GE	054,079,084	Nordmende	060	Shintom	091
GEC	100	Optonica	067,081	Siemens	056,123
General	071	Orion	140,227,228	Sinudyne	100
Go Video	251,298				
Goldstar	056,057				

Cable TV converter code table

BRAND NAME	CODE NUMBER	BRAND NAME	CODE NUMBER	BRAND NAME	CODE NUMBER
Sony	051,052,053,054	ABC	026,030,032,036	Unika	172
STS	061	Archer	058,172	United Artists	026
Sunstar	019	Century	172	United Cable	022
Sylvania	054,062,100,129	Citizen	172	Universal	058,096,172,210
Symphonic	019	Colour Voice	044,050	Viewstar	046,079
Tashiko	019	Comtronics	059,079	Zenith	019
Tatung	019,060,100	Eastern	021		
Teac	019,060	Garrard	172		
Technics	054	Gemini	034,089		
Teknika	019,054,056,071	General			
Telefunken	060,206	Instrument	030		
Tenosal	091	Hamlin	028,039,278,292		
Tensai	019	Hitachi	030		
Thomson	060	Jasco	172		
Thorn	060	Jerrold	022,030,031,033, 034,043,045		
Toshiba	060,062,064,085, 229,231,385	Macom	052		
Totevision	056,259	Magnavox	046		
Triumph	227	Memorex	019		
Unitech	259	Movie Time	175		
Universum	019,056,068,100, 125	NSC	089,175		
Vector Research	057,059	Oak	026,038		
Victor	027,060,086	Panasonic	040		
Video Concepts	059,080	Paragon	019		
Videosonic	259	Philips	044,046,047,048, 049,050,079		
Wards	019,054,061,066, 067,081,09 1,168,231,259	Pioneer	163		
Yamaha	057,060	Pulsar	019		
Yoko	259	PVP Stereo			
Zenith	052,053,058	Visual Matrix	022		
		RCA	040		
		Regal	039,278,292		
		Regency	021		
		Rembrandt	089		
		Runco	029		
		Samsung	059,163		
		Scientific Atlanta	025,027,036,296		
		Signal	034,059		
		Signature	030		
		SL Marx	059		
		Sprucer	040		
		Standard			
		Components	174		
		Starcom	022,034		
		Stargate	034,059		
		STS	175		
		Tocom	031,032,078		
		Toshiba	019		

PREPARATION

Programming the Remote Control

MENU FUNCTION (General Instructions)

We suggest you familiarize yourself with the procedure before using the Menu function.

To adjust any TV feature, the use of the Menu function is required. The adjustments that can be made to the TV appear on the screen.

MENU BUTTON (on TV)

Each time you press **MENU**, the Picture, Audio, Set up or Option menu on-screen display is selected in order, then press **ADV**.

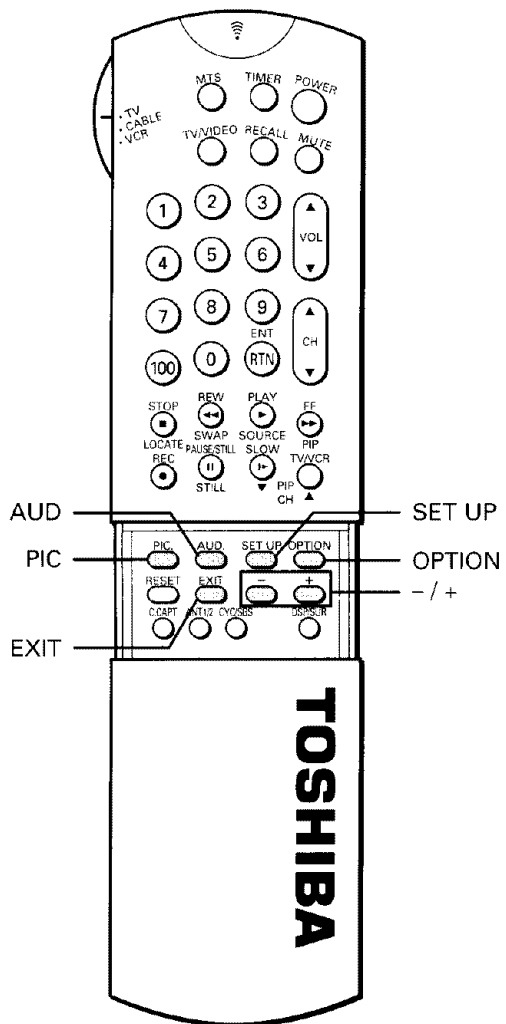
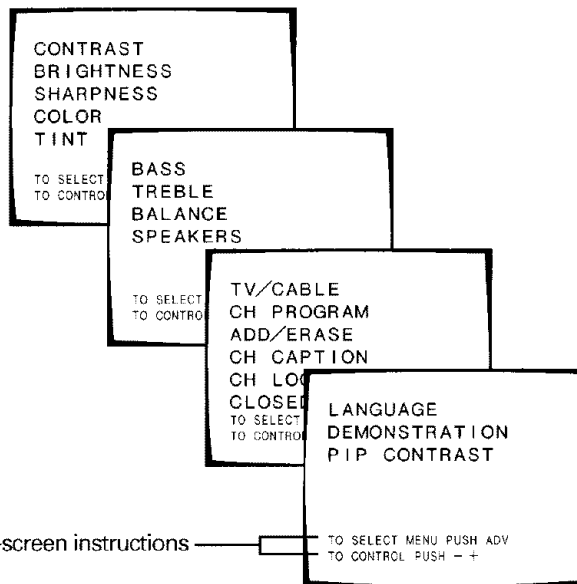
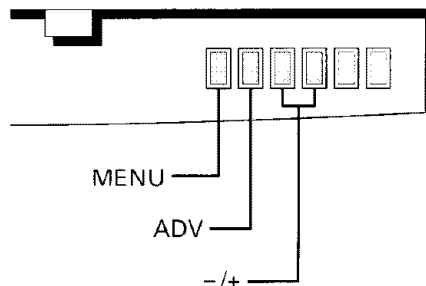

ADV BUTTON (on TV)

Use this **ADV** after you have pressed **MENU** to select the function you want to adjust.

Each time you press **ADV**, the function to be adjusted will be selected in order.

The selected function will be displayed in magenta.

-/+ BUTTONS (on TV and on Remote)

Use these **-/+** after you have pressed **ADV** or any of the four menu buttons (**PIC**, **AUD**, **SET UP** or **OPTION**).

Example: CONTRAST adjustment mode display

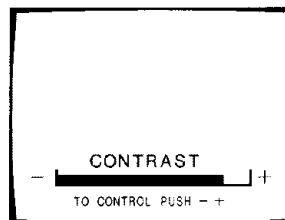

Pressing **+** increases the picture contrast.

Pressing **-** decreases the picture contrast.

PIC (Picture) BUTTON (on Remote)

Press **PIC** repeatedly until the Picture menu function you want to adjust is selected. The selected function will be displayed in magenta, then press **-/+** to adjust the setting. Details for each function begin on page 26.

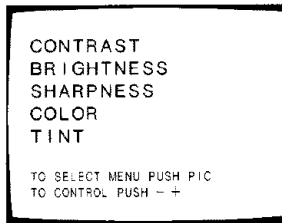

AUD (Audio) BUTTON (on Remote)

Press **AUD** repeatedly until the Audio menu function you want to adjust is selected. The selected function will be displayed in magenta, then press **-/+** to adjust the setting. Details for each function begin on page 27.

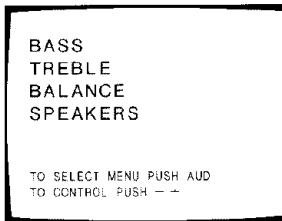

SET UP BUTTON (on Remote)

Press **SET UP** repeatedly until the Set up menu function you want to adjust is selected. The selected function will be displayed in magenta, then press **-/+** to adjust the setting. Details for each function begin on page 22.

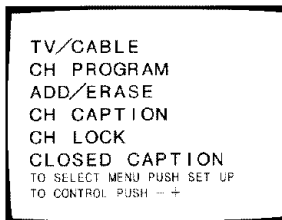

OPTION BUTTON (on Remote)

Press **OPTION** repeatedly until the Option menu function you want to adjust is selected. The selected function will be displayed in magenta, then press **-/+** to adjust the setting. Details for each function begin on pages 31 and 38.

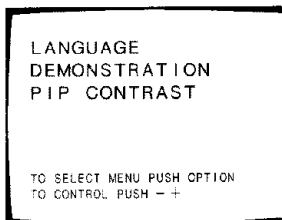

EXIT BUTTON (on Remote)

The above four menu displays will automatically disappear from the screen if no control has been operated for about 15 seconds, and all other menu displays also disappear after about 6 seconds.

If you want to clear the screen of all on-screen displays instantly, press **EXIT**.

Notes:

- The **ADV** button on the TV will function as the **ANT/VIDEO** button when no menu display is on the screen.
- The **-/+** buttons on the TV will function as the **VOLUME ▼/▲** buttons when no menu display is on the screen.

TV CHANNELS

This TV will receive the following TV signals:

1. TV: Off the air TV signals. (VHF channels 2 thru 13 and UHF channels 14 thru 69)
2. STD CABLE: Standard (or IRC: Incremental Related Carrier) cable TV signals.
3. HRC CABLE: Harmonic Related Carrier cable TV signals.
4. IRC CABLE: Incremental Related Carrier cable TV signals.

For each of these systems, your TV has exact frequencies built into it to ensure precise tuning. For precise tuning, the TV/CABLE function must be set to match your TV or CABLE system. (See page 22.) The following chart shows channels available in each system and how your TV displays them. When you connect your TV to a cable TV system and if you are not sure what system they are using, proceed with the following section "HOW TO FIND YOUR TYPE OF CABLE SYSTEM" or consult your local cable company to check if your system is STD, HRC or IRC.

HOW TO FIND YOUR TYPE OF CABLE SYSTEM

- 1** Select the "STD CABLE" mode following the instructions on page 22.
- 2** Select various channels and confirm whether the channel will lock immediately with perfect picture. If the channels seem to take a few seconds to lock in, your cable system may be one of the other cable systems. In this case, continue with the following steps.
- 3** Select the "HRC CABLE" mode and try above procedure again.
- 4** If you are having problem with only channel 5 or 6, you may have an IRC system so change the mode to the "IRC CABLE".

TV/CABLE CHANNEL REFERENCE CHART

Number on this TV	Corresponding channel number		14	14	A	70		70
	TV off the air	Cable TV STD/HRC/IRC						
			⋮	⋮	⋮	⋮		⋮
			35	35	V	93		93
1	—	A-8	36	36	W	94		94
2	2	2	37	37	AA	95		A-5
3	3	3	38	38	BB	96		A-4
4	4	4	⋮	⋮	⋮	97	Not used	A-3
5	5	5 (A-7)	61	61	YY	98		A-2
6	6	6 (A-6)	62	62	ZZ	99		A-1
7	7	7	63	63	AAA	100		100
8	8	8	64	64	BBB	101		101
9	9	9	65	65	65	⋮		⋮
10	10	10	66	66	66	124		124
11	11	11	67	67	67	125		125
12	12	12	68	68	68			
13	13	13	69	69	69			

Note: The above chart is typical of many cable system channel allocations. However, the numbering system may differ in your area. If in doubt, consult your local cable company.

SELECTING THE ANTENNA INPUT

Your TV has two separate antenna inputs (ANT-1 and ANT-2) that allow you to connect two different signal sources, if desired.

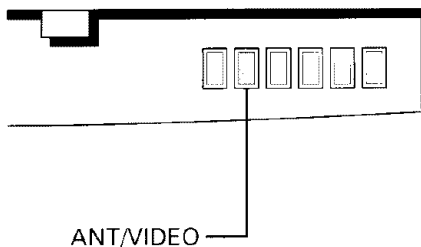

USING THE ANT 1/2 BUTTON (on the Remote Control)

Each time you press the button, the ANT 1 mode and ANT 2 mode will alternate. The selected mode will be displayed in magenta to show which antenna source you are watching. Select the mode that matches the antenna terminal you use.

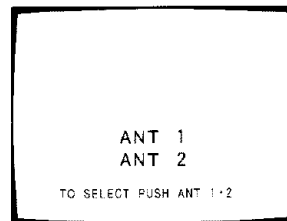

Note:

This button does not function in the VIDEO mode.

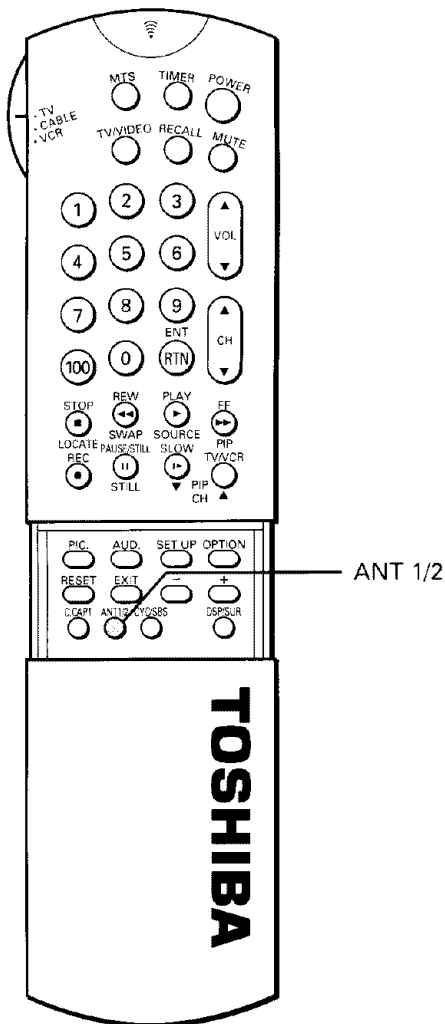

USING THE ANT/VIDEO BUTTON (on the TV)

Each time you press the button, the ANT 1 VIDEO 1, VIDEO 2 or ANT 2 mode will be selected in order. The selected mode will be displayed in magenta to show which signal source you are watching. Press the button until "ANT 1" or "ANT 2" is displayed in magenta to match the antenna terminal you use.

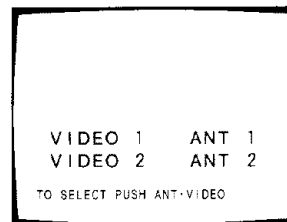

Note:

This button functions as the ADV button while any of four menu displays (Picture, Audio, Set up or Option) are on the screen.

PREPARATION

TV channels / Selecting the antenna input

PROGRAMMING CHANNEL MEMORY

The channel memory is the list of TV channel numbers your TV will stop on when you press the CHANNEL ▲ or ▼ button. **First, use the TV CABLE and CHANNEL PROGRAM functions to preset all active channels in your area automatically.** If necessary, arrange the preset channels with the ADD/ERASE functions so that you can tune into only desired channels.

Note: If you utilize both "ANT-1" and "ANT-2" terminals, perform channel programming for each input source.

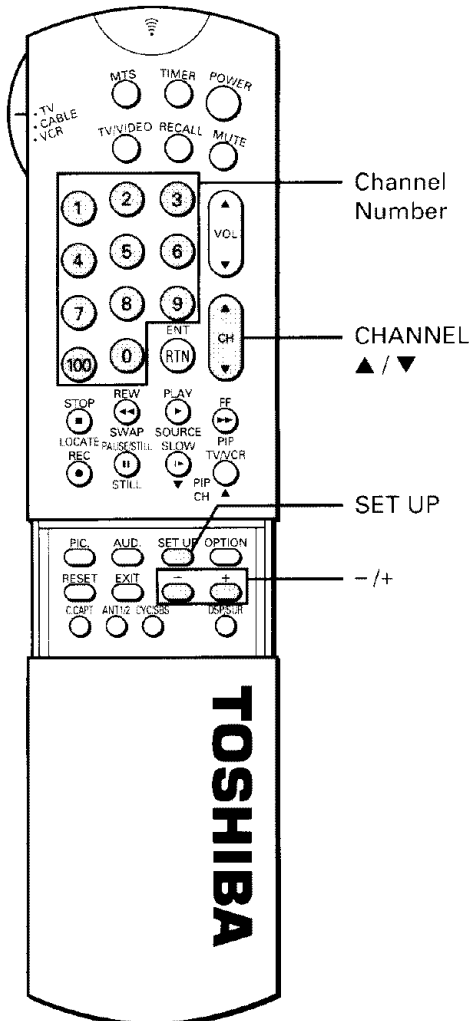
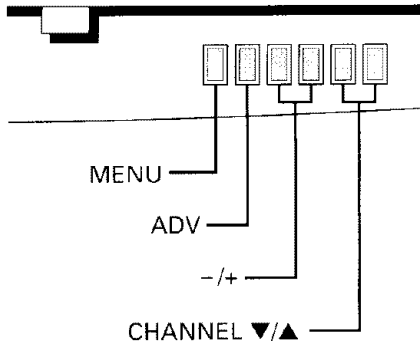

TV/CABLE FUNCTION

- 1 Press **POWER** to turn on the TV.
- 2 Press **SET UP** on the Remote Control (or **MENU** on the TV) to display the Set up menu on the screen.
- 3 Press **SET UP** repeatedly (or **ADV** on the TV) until "TV/CABLE" is displayed in magenta.
- 4 Press - or + until the mode that corresponds to your TV signal system is displayed in magenta. Each time you press the button, the TV, STD CABLE, HRC CABLE or IRC CABLE mode will be selected in order.

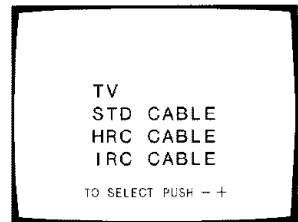
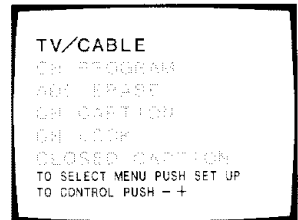

CH PROGRAM FUNCTION

- 1 Select "CH PROGRAM" following steps 2 and 3 above.
- 2 Press - or + to start channel programming. The TV will automatically cycle through all the TV or CABLE channels on the mode selected by the TV/CABLE function and store active channels in the channel memory.
- 3 When channel programming is complete, you will see the message at the right.
- 4 Press **CHANNEL ▲** or **▼** to make sure the channel programming has been done properly.

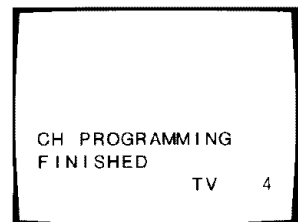
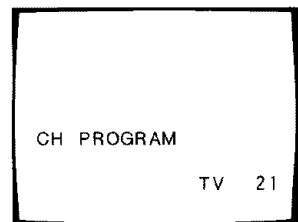
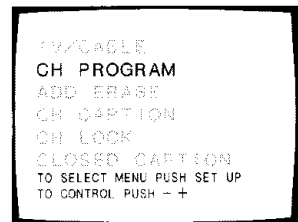

ADD ERASE FUNCTION

First follow the instructions "CH PROGRAM FUNCTION" and then add or erase individual channels as desired.

- 1** Select the channel you want to erase using the **CHANNEL ▲** or **▼** button, or select the channel you want to add using the **Channel Number** buttons.

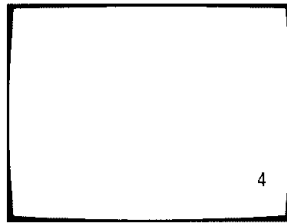

- 2** Press **SET UP** on the Remote Control (or **MENU** on the TV) to display the Set up menu on the screen.

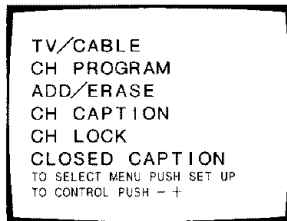

- 3** Press **SET UP** repeatedly or (**ADV** on the TV) until "ADD/ERASE" is displayed in magenta.

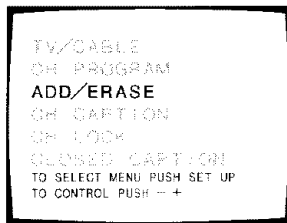

- 4** Press **-** or **+** :
To erase the channel
Press the button until "CH ERASE" is displayed in magenta indicating that the channel has been erased from the memory.

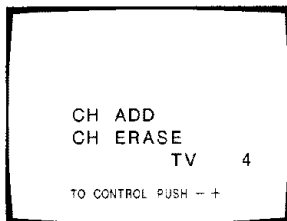

- To add the channel**
Press the button until "CH ADD" is displayed in magenta indicating that the channel has been memorized.

- 5** Repeat steps 1 to 4 for other channels.

You have now completed the channel programming.

WATCHING TV PROGRAMS

- First set the TV-CABLE-VCR switch to "TV" position.

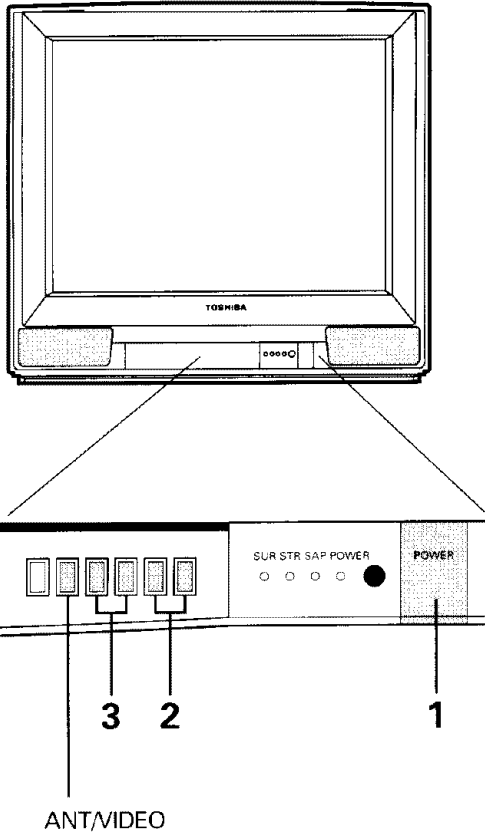

- 1 Press **POWER** to turn on the TV.

To turn off the TV, press **POWER** again.

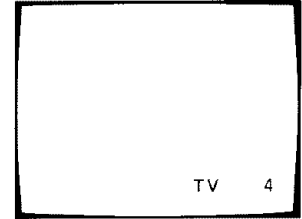

- 2 Select a channel in one of the following two ways.

- **To scan the memorized channels in numerical sequence**

Press **CHANNEL ▲** to select the next higher channel.

Press **CHANNEL ▼** to select the next lower channel.

Press the button again to select the next memorized channels.

- **To select a channel directly**

Press the **Channel Number** buttons (0-9 and 100).

To select channel 4, press "4" (or press "0", "4").

To select channel 38, press "3", "8".

To select channel 125, press "100", "2", "5" in sequence.

If you cannot select certain channels, either TV (off the air) or CABLE channels

Check if the TV/CABLE function is properly set. See page 22.

- 3 Press **VOLUME ▲/▼** to adjust the volume.

To increase the volume, press **▲**.

To decrease the volume, press **▼**.

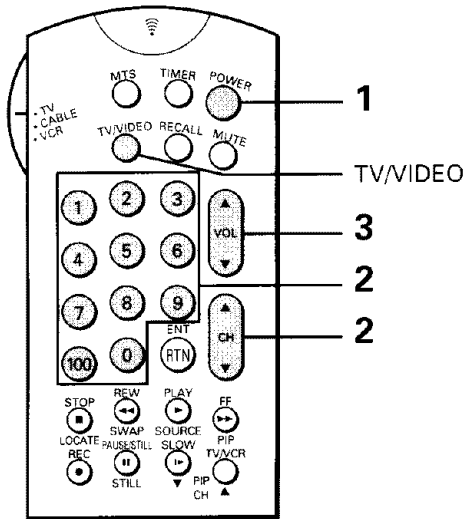
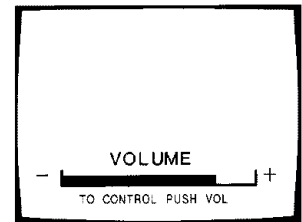

Note:

The **VOLUME ▲/▼** buttons on the TV function as the menu +/- buttons while any of the menu displays (Picture, Audio, Set up or Option) are on the screen.

Watching Video Input

The **TV/VIDEO** button (or **ANT/VIDEO** button) is used to view the signals coming from other devices like VCR's or Video Disc Players connected to this TV. Details are on page 41.

Auto-Power-Off

If a vacant channel is tuned or TV broadcast for a day is finished, the TV will automatically turn off after about 15 minutes.

This feature does not operate in the **VIDEO** mode.

Last Mode Memory

If the power is cut off while you are viewing the TV and the power is resupplied, the TV is turned on automatically by the **Last Mode Memory** feature. If the power is going to be off or when you leave home for a long time, remove the power plug from the wall outlet to prevent the TV from turning on in your absence.

ADJUSTING THE PICTURE

You can adjust the picture quality (CONTRAST, BRIGHTNESS, SHARPNESS, COLOR and TINT) to suit your personal preference.

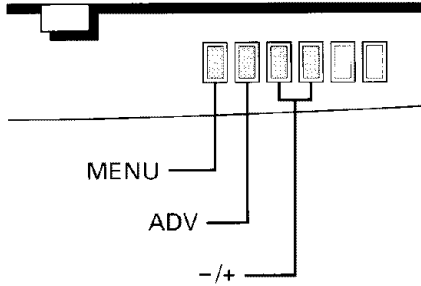

TO ADJUST THE PICTURE QUALITY

- 1 Press **PIC** on the Remote Control (or **MENU** on the TV) to display the Picture menu.
- 2 Press **PIC** (or **ADV** on the TV) until the item you want to adjust is displayed in magenta.
- 3 Press **-** or **+** to adjust the level.

Example: CONTRAST adjustment mode display

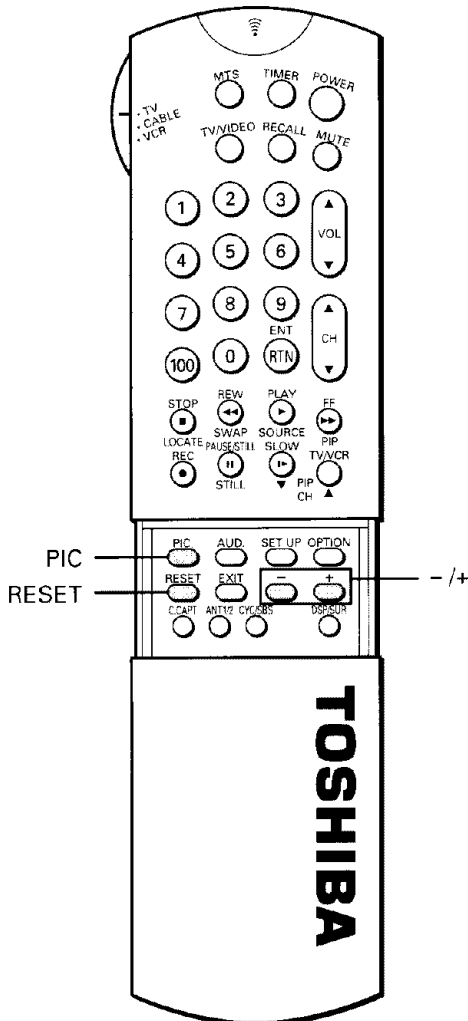
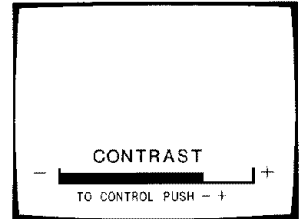

Press **PIC** or **MENU** (while the bar display remains on the screen). The new setting will appear in the PICTURE menu.

Item	Pressing	
	-	+
CONTRAST	lower	higher
BRIGHTNESS	darker	lighter
SHARPNESS	softer	sharper
COLOR	paler	deeper
TINT	reddish	greenish

To reset the picture adjustments

Press **RESET**. (See the next page for details.)

ADJUSTING THE SOUND

You can adjust the AUDIO functions (BASS, TREBLE and BALANCE) to suit your personal preference.

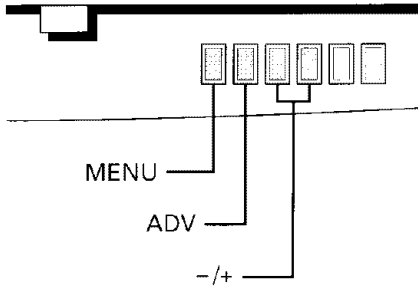

TO ADJUST THE SOUND QUALITY

- 1 Press **AUD** on the Remote Control (or **MENU** on the TV) to display the AUDIO menu on the screen.
- 2 Press **AUD** (or **ADV** on the TV) until the item you want to adjust is displayed in magenta.
- 3 Press **-** or **+** to adjust the level.

Example: BASS adjustment mode display

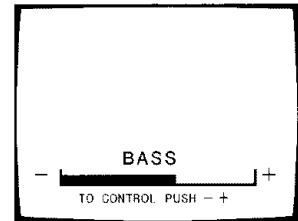
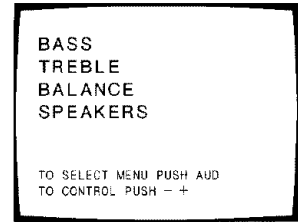

Press **AUD** or **MENU** (while the bar display remains on the screen). The new setting will appear in the AUDIO menu.

Item	Pressing	
	-	+
BASS	weaker	stronger
TREBLE	weaker	stronger
BALANCE	decreases the right channel	decreases the left channel

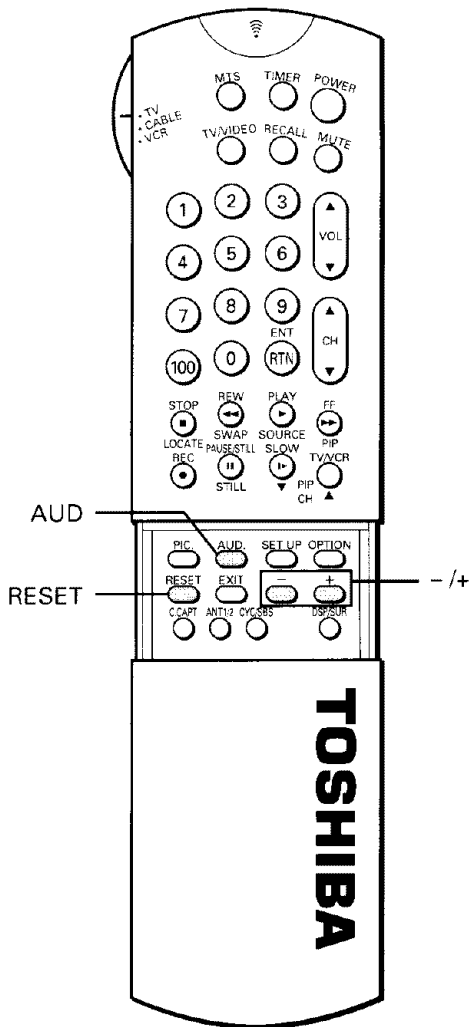

RESET BUTTON (on the Remote Control)

To reset the PICTURE and AUDIO adjustments to the factory-preset level (maximum CONTRAST and all other adjustments centered)

Press **RESET**.

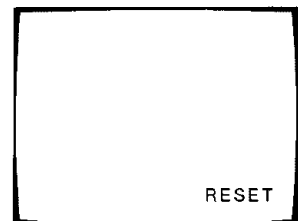

Note:
The "SPEAKERS" function is explained on page 44.

SELECTING STEREO/SAP BROADCASTS

The MTS (Multi-channel TV Sound) feature allows you to improve your TV viewing with high fidelity stereo sound. MTS also provides for an extra channel, SAP (Second Audio Program), used to transmit a second language or other audio information.

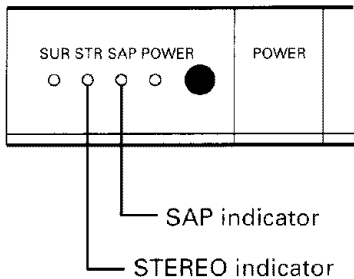

LISTENING TO STEREO SOUND

- 1 When the TV receives a stereo broadcast, the STEREO indicator (green) will light up.
- 2 Press **MTS** until "STEREO" is displayed on the screen in magenta.

Normally this function can be left in the STEREO mode. Your TV will then automatically reproduce either stereo or monaural sound, whichever is broadcast.

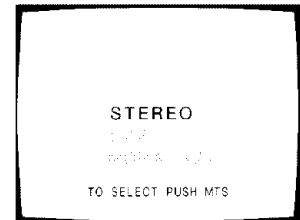

If the stereo sound is noisy

If a broadcast signal is not strong enough, and noise-free stereo sound is not available, select the MONAURAL mode. The noise should be reduced.

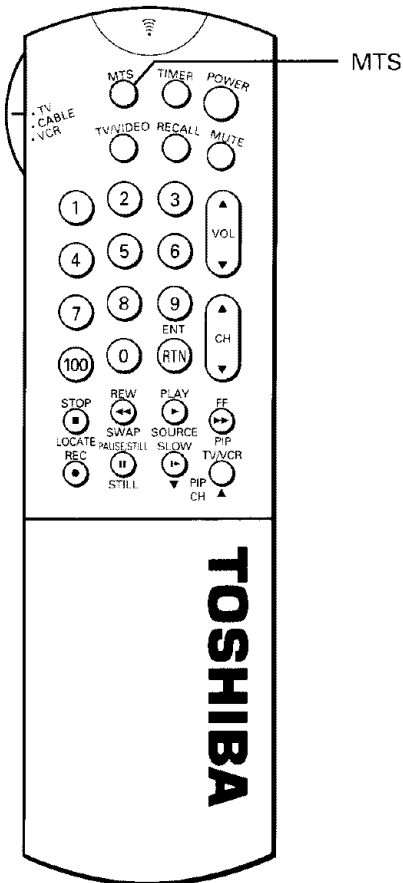

LISTENING TO SECOND LANGUAGE

- 1 When the TV receives a SAP broadcast, the SAP indicator (orange) will light up.
- 2 Press **MTS** until "SAP" is displayed in magenta. You will hear only the second language from the left and right speakers.

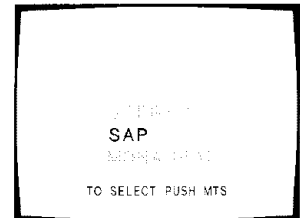

Notes:

- Be sure you have selected the STEREO mode if broadcast is in stereo.
- The MTS button will not function in the VIDEO mode.

ENHANCING THE SURROUND SOUND EFFECT

The Surround function expands the audio listening field wider than you would believe possible from a TV's speakers. Toshiba's CYCLONE ABX is a deep bass reproduction system.

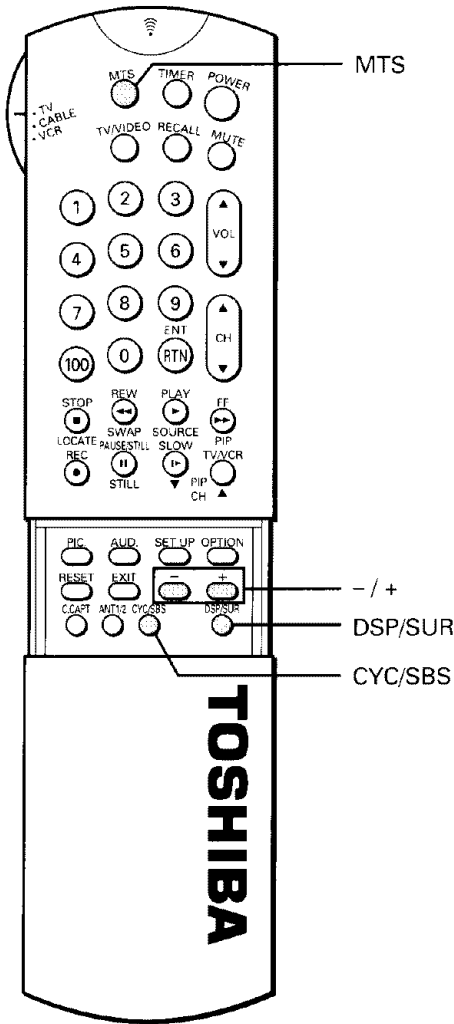

TO ACTIVATE THE SURROUND FUNCTION

- 1 Press **MTS** to select the STEREO mode.
- 2 Press **DSP/SUR** on the Remote Control to call up the Surround ON/OFF mode on-screen display as shown.

Press **DSP/SUR** until "SURROUND ON" is displayed in magenta.

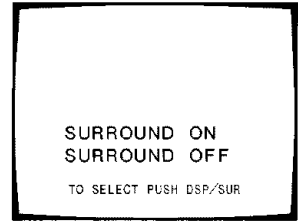

The Surround function has now been activated.

- 3 **To adjust the Surround level**
Press - or + while the Surround ON/OFF mode display shown above is on the screen to call up the Surround adjustment mode display.

Press + to increase Surround level.
Press - to decrease Surround level.

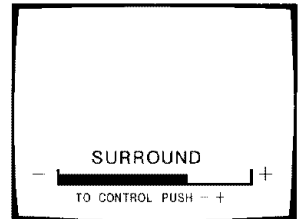

To deactivate the Surround
Select "SURROUND OFF" in the Surround ON/OFF mode display.

TO ACTIVATE THE CYCLONE WOOFER

- 1 Press **CYC/SBS** on the Remote Control to call up the CYCLONE ON/OFF mode display.

Press **CYC/SBS** until "CYCLONE ON" is displayed in magenta.

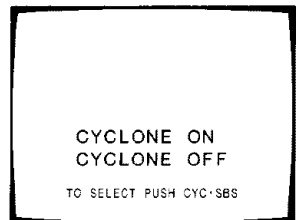

The CYCLONE woofer has now been activated.

- 2 **To adjust the CYCLONE volume**
Press - or + while the CYCLONE ON/OFF mode display shown above is on the screen to call up the CYCLONE volume adjustment mode display.

Press + to increase CYCLONE volume.
Press - to decrease CYCLONE volume.

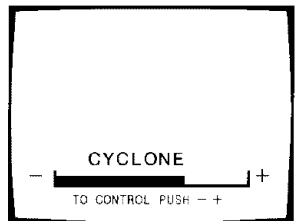

To deactivate the CYCLONE woofer
Select "CYCLONE OFF" in the CYCLONE ON/OFF mode display.

Note on the Surround function
Normally you can leave the MTS button set to "STEREO" and the Surround function set to "ON". The TV will automatically produce either Surround stereo or monaural, whatever is broadcast.

WATCHING PICTURE IN PICTURE (PIP)

This TV is capable of displaying two pictures simultaneously. This is called the Picture-in-Picture function. A TV broadcast picture, or a picture from external source equipment such as a VCR, can be displayed as a small picture.

Note: The signal sources from the ANT-2 terminal cannot be displayed as a small picture.

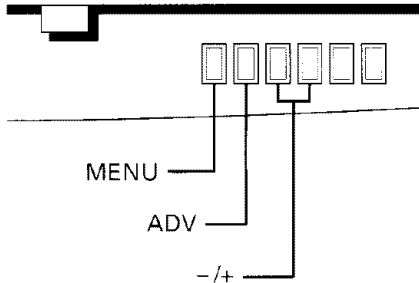

TO DISPLAY THE PIP

- 1 To open up the PIP window**
Press **PIP** once.
The 1/9 size picture will appear.

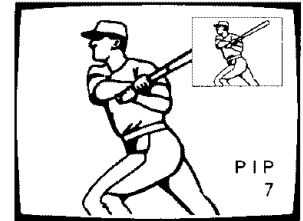

- 2 To change the window size**
Press **PIP** again.
The 1/16 size picture will appear.

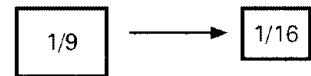

- 3 To make the PIP window disappear**
Press **PIP** again.

Each time you press **PIP**, above 1, 2 or 3 will be selected cyclically.

TO CHANGE TV CHANNELS IN PIP

Press **PIP CH** ∇/\blacktriangle to select the desired program for the small picture.
Press " \blacktriangle " to select the next higher channel in channel memory.
Press " ∇ " to select the next lower channel in channel memory.

TO DISPLAY A PICTURE FROM AN EXTERNAL SOURCE

Connect the other source (VCR, camcorder, etc.), to one of the VIDEO inputs.

Press **SOURCE** repeatedly to select input source.
The selected mode will be displayed in magenta.
Select "VIDEO 1" or "VIDEO 2".

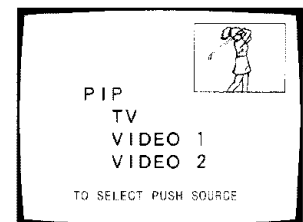

TO CHANGE THE POSITION OF THE PIP

Press **LOCATE** to move the PIP to the next corner.

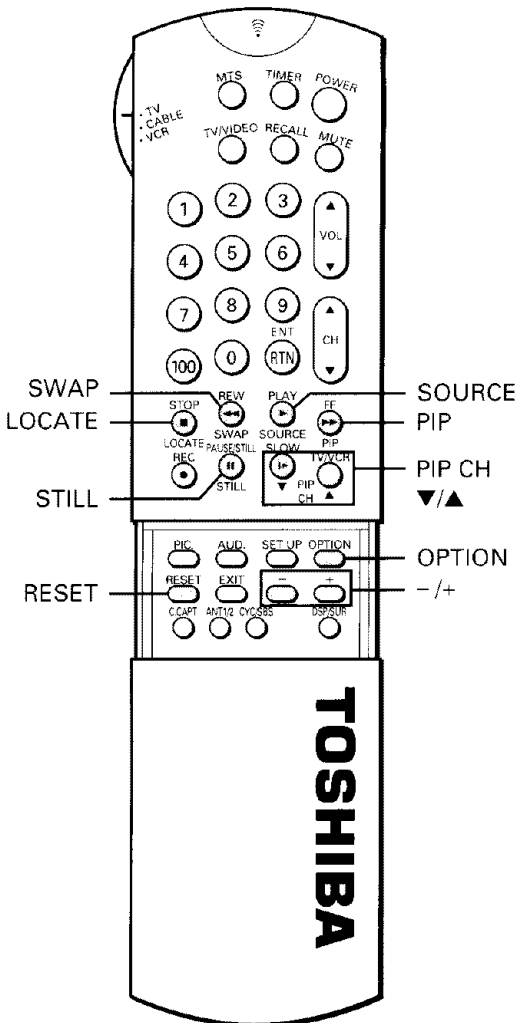
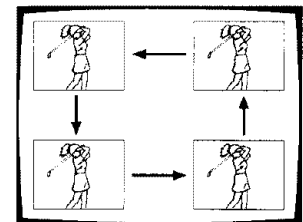

TO FREEZE THE SMALL PICTURE

Press **STILL** once while the PIP is on the screen to freeze the PIP picture.
To return to an action picture, press **STILL** again.

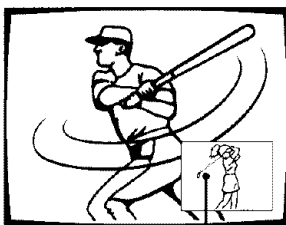

Still picture

TO SWITCH THE MAIN AND SMALL PICTURE

Press **SWAP** once to switch the PIP picture with the main picture

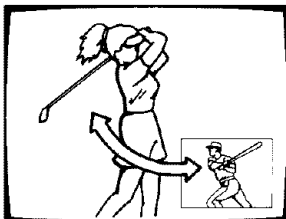

ADJUSTING PIP CONTRAST

1 Press **PIP** to display the PIP.

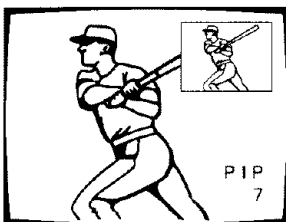

2 Press **OPTION** on the Remote Control (or **MENU** on the TV) to display the Option menu on the screen.

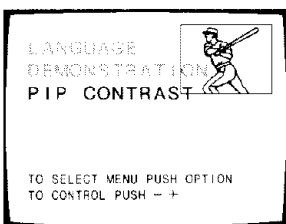

3 Press **OPTION** repeatedly (or **ADV** on the TV) until "PIP CONTRAST" is displayed in magenta.

4 Press **-** or **+** to call up the PIP CONTRAST adjustment mode display on the screen.

Press **+** to increase contrast.
Press **-** to decrease contrast.
Press and hold either button until your desired contrast is obtained.

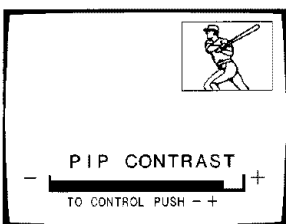

Note: If the **RESET** button is pressed, the PIP contrast will be reset to the maximum (factory-preset level).

CAPTIONING CHANNELS

This feature allows you to enter a four letter channel identifier of your choice that will appear over the channel number display. The caption can be anything you want (for example the station call letters).

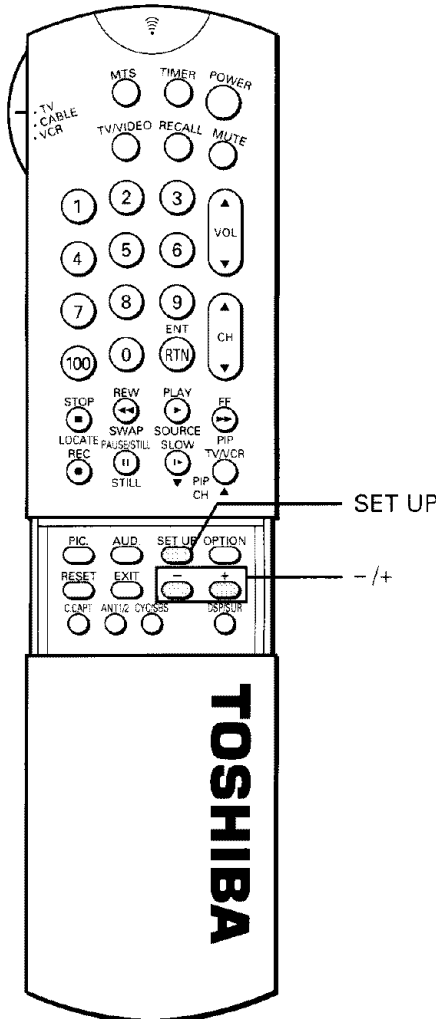

TO CAPTION CHANNELS

- 1 Select the channel you want to caption.

Example: To assign "ABCD" to channel 4.

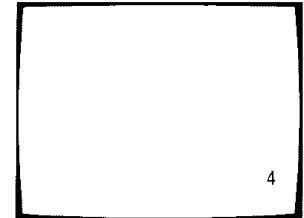

- 2 Press **SET UP** on the Remote Control to display the SET UP menu on the screen.

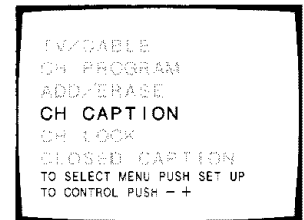

- 3 Press **SET UP** repeatedly until "CH CAPTION" is displayed in magenta.

- 4 Press - or + to call up the caption setting mode display shown below on the screen.

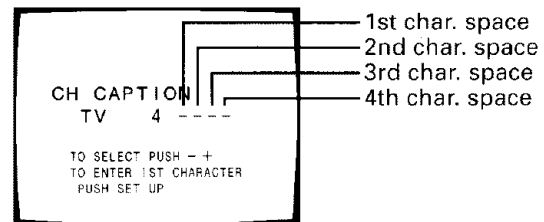

Letters of alphabet, numbers and other graphic symbols are available for captioning.

Each time you press the - or + button, the character to be displayed will change in the following order.

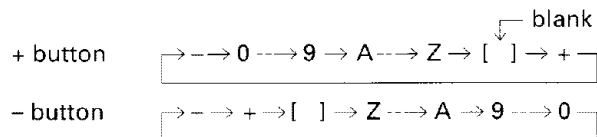

- 5 Press - or + to put a character "A" in the 1st character space.

Press the button until the character you want appears on the screen.

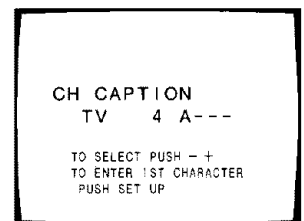

- 6 Press **SET UP** once to enter the 1st character and to advance to the next character space.

- 7** Repeat steps 5 and 6 to enter the 2nd, 3rd and 4th characters "B", "C", "D". When the on-screen message at the right appears, the channel caption has been stored in the memory.

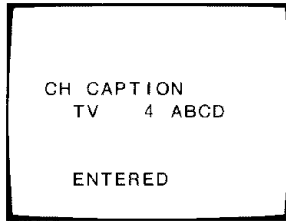

- 8** Repeat steps 1 through 7 for other channels. You can caption up to 32 channels. The caption will appear when you turn the TV on, select a channel, or press the RECALL button.

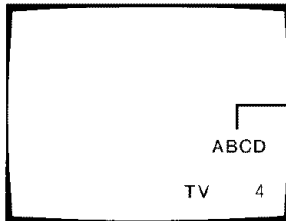

Channel caption

TO CLEAR YOUR CAPTIONING

- 1** Select the channel which has the caption you want to erase.
- 2** Call up the channel caption setting mode display following steps 2 to 4 in the previous page.
- 3** Enter "[blank]" or "-" in all character spaces.

LOCKING CHANNELS

With this function you can lock out specific channels (for example a channel that you do not want your children to watch) by entering your own 4-digit code. The TV will not be able to tune them for the next 24 hours, unless you cancel the locked out channels. This TV has 4 memory spaces total for the TV mode and CABLE mode respectively.

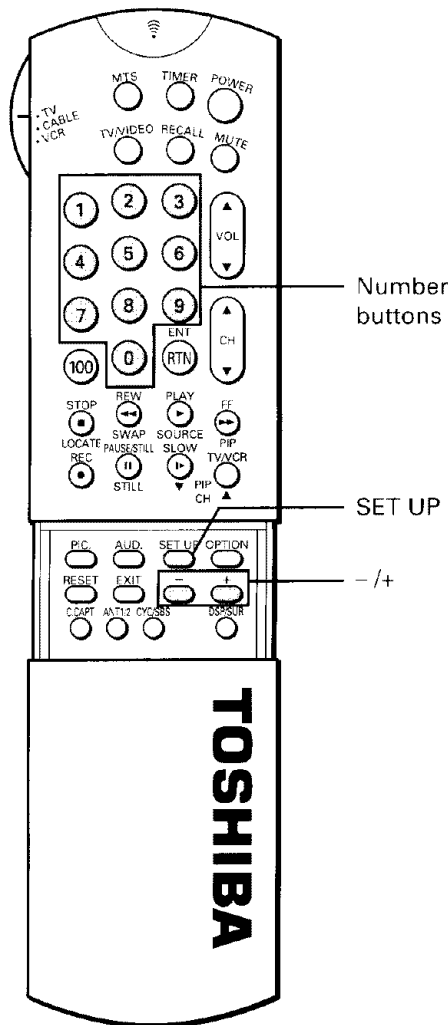

TO LOCK OUT CHANNELS

- 1 Select a channel you want to lock out.

Example: channel 4

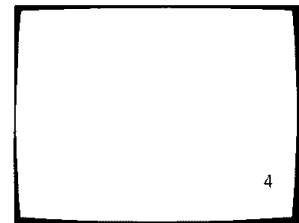

- 2 Press **SET UP** on the Remote Control to display the Set up menu on the screen.

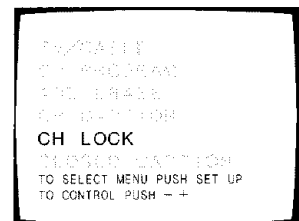

- 3 Press **SET UP** repeatedly until "CH LOCK" is displayed in magenta.

- 4 Press - or + to call up the channel lock adjustment mode display shown below. Each time you press the button, "SET" and "CLEAR" alternate. Select "SET".

SET
⇕
CLEAR

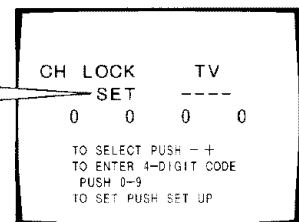

- 5 Press **Number** buttons (0 - 9) to enter a 4-digit code. The numbers you enter will replace the dashes in the display. **Pick a number that is easy to remember.**

Example: To enter "1234".
Press 1, 2, 3, and 4 in order.

1---→ 12---→ 123---→ 1234

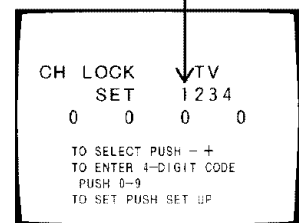

- 6** Press **SET UP** to lock out the channel.
The display at the right will appear on the screen for about 4 seconds.

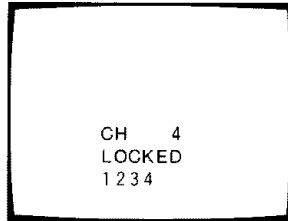

- 7** Repeat steps 1 to 5 for other channels.
This TV has 4 memory spaces total for the TV mode and CABLE mode respectively.

Note: If a different code number is used whenever you lock out a channel, the last one has priority over the preceding ones.

- 8** Select another channel, or turn off the TV if desired.

TO RESTORE CHANNELS

- 1** Select "CLEAR" following the steps 2 to 4 in the previous page.

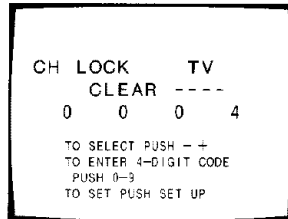

- 2** Press the 4-digit code used to lock out the channels with the **Number** buttons.

- 3** Press **SET UP**.
If you have entered the correct code
The display shown at the right appears.

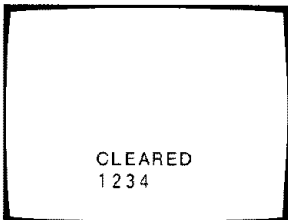

If a wrong code has been entered
These messages appear. Try to enter the correct code again.

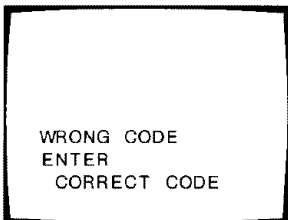

If you want to know the channels you have locked out

Call up the channel lock adjustment mode using the SET UP button and +/- buttons.

OPERATING CLOSED CAPTIONING FEATURE

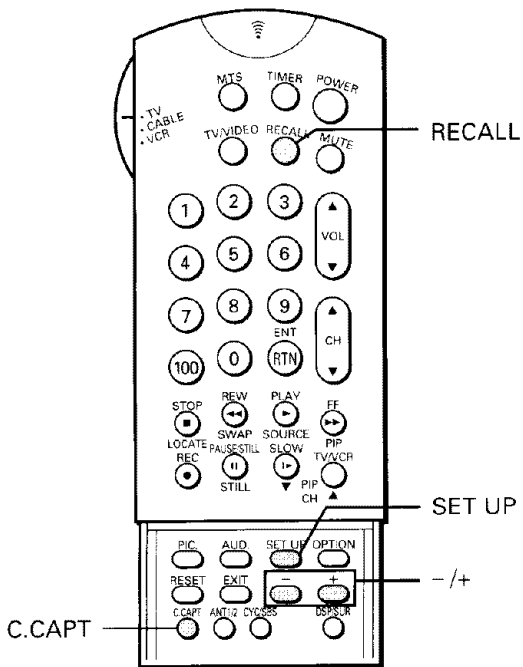
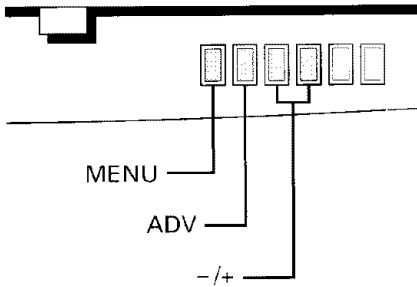

TO VIEW CAPTIONS

Closed captioning is a printed version of the dialogue, narration, and/or sound effects of a TV program. Captions will appear at either the top or bottom of the screen during captioned broadcasts as shown. Captioning is especially helpful for hearing impaired individuals.

- 1 Select the desired program.
- 2 Press **RECALL** to check if the program is being captioned. If it is, the word "CAPTION" is displayed on the screen. The captioned programs are usually notated on your local TV listings by its service marks such as "CC".

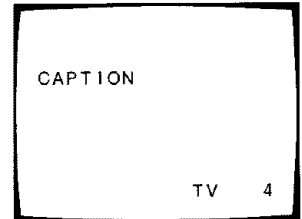

- 3 Press **C.CAPT** on the Remote Control to call up the closed caption mode display. Usable selections are displayed in yellow.

Press **C.CAPT** repeatedly until "CAPTION 1" or "CAPTION 2" is displayed in magenta. The CAPTION 2 mode may be utilized for alternate languages if they are being transmitted.

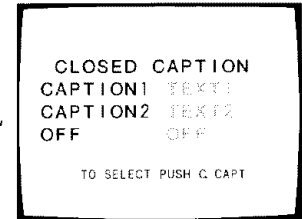

You can also select this feature using the on-screen menu function.

- 1 Press **SET UP** on the Remote Control (or **MENU** on the TV) to display the Set up menu on the screen.
- 2 Press **SET UP** repeatedly (or **ADV** on the TV) until "CLOSED CAPTION" is displayed in magenta.
- 3 Press **-** or **+** to select "CAPTION 1" or "CAPTION 2".

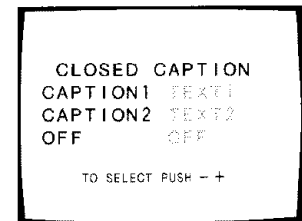
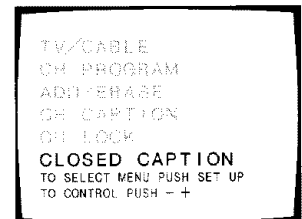

To deactivate this feature

Select "OFF" in the closed caption mode display.

Note:

- A closed-captioned signal may not be decoded in the following situations.
- When a video tape has been dubbed.
 - When the signal reception is weak.
 - When the signal reception is non-standard.

TO VIEW TEXT

Text is information that is presented using from one half to full television screen. It is usually not related to the program. For example, it could be a listing of the closed-captioned programs, news, weather information or stock market reports.

- 1 Select the desired program.
- 2 Press **RECALL** to check if the program includes TEXT information. If it does, the word "TEXT" is displayed on the screen.

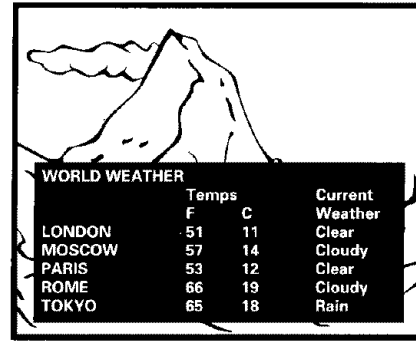
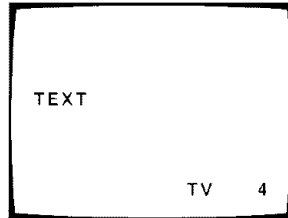

	Temps		Current Weather
	F	C	
LONDON	51	11	Clear
MOSCOW	57	14	Cloudy
PARIS	53	12	Clear
ROME	66	19	Cloudy
TOKYO	85	18	Rain

- 3 Press **C.CAPT** on the Remote Control to call up the closed caption select mode display. Usable selections are displayed in yellow. Press **C.CAPT** repeatedly until "TEXT 1" or "TEXT 2" is displayed in magenta.

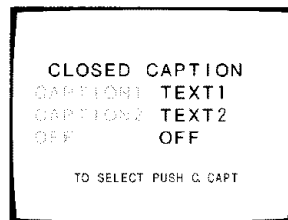

You can also select this feature using the on-screen menu function.

- 1 Press **SET UP** on the Remote Control (or **MENU** on the TV) to display the Set up menu on the screen.
- 2 Press **SET UP** repeatedly (or **ADV** on the TV) until "CLOSED CAPTION" is displayed in magenta.
- 3 Press **-** or **+** to select "TEXT 1" or "TEXT 2".

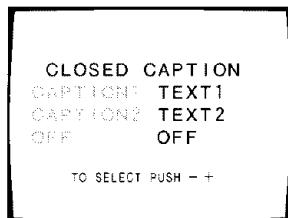
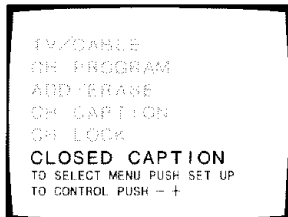

To deactivate this feature

Select "OFF" in the closed caption mode display.

Note:

If you select a Caption format channel and the "TEXT" mode, the TEXT screen will always be displayed. However, if TEXT character signals are not transmitted, the characters are not displayed.

CHANGING ON-SCREEN DISPLAY LANGUAGE

Three different languages (ENGLISH, FRENCH and SPANISH) are available for the on-screen displays (adjustment menus, and messages), and you can choose the desired one.

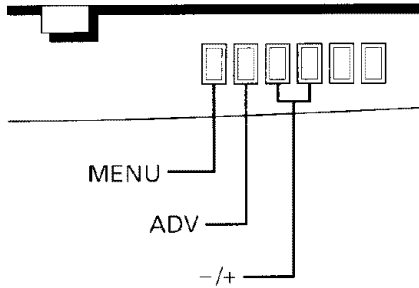

TO SELECT A LANGUAGE

- 1 Press **OPTION** on the Remote Control (or **MENU** on the TV) to display the Option menu on the screen.
- 2 Press **OPTION** repeatedly or (or **ADV** on the TV) until "LANGUAGE" is displayed in magenta.
- 3 Press **-** or **+** until your desired language is displayed in magenta.

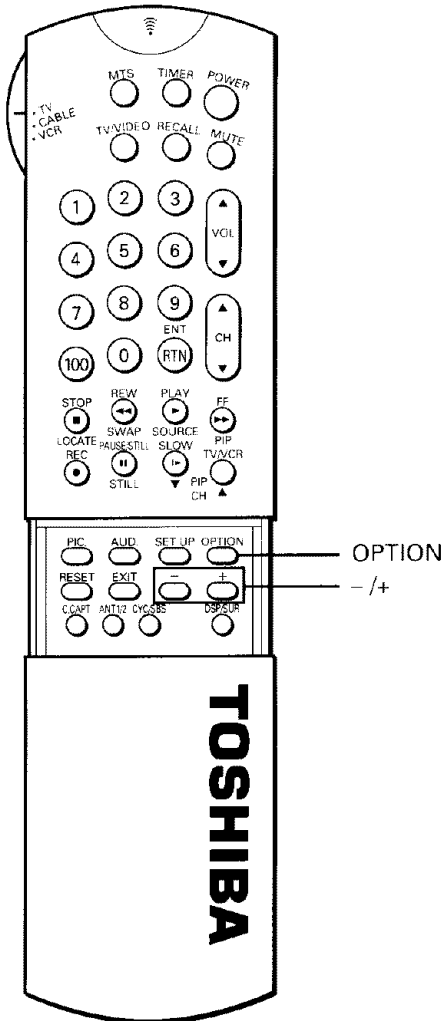
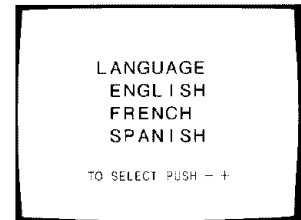
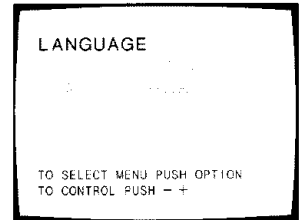

Example: Picture menu display

"ENGLISH"

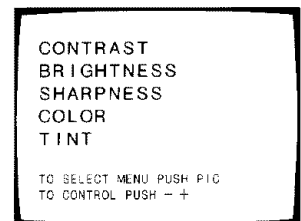

"FRENCH"

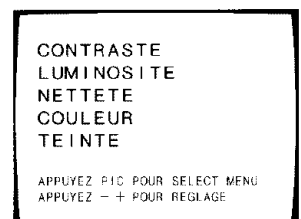

"SPANISH"

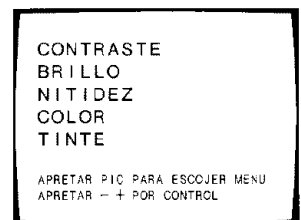

ACTIVATING ON-SCREEN DEMONSTRATION

When this function is activated, your TV will automatically display a variety of its on-screen menus and special features. This function is provided for demonstration purpose only. You may not need to use this function.

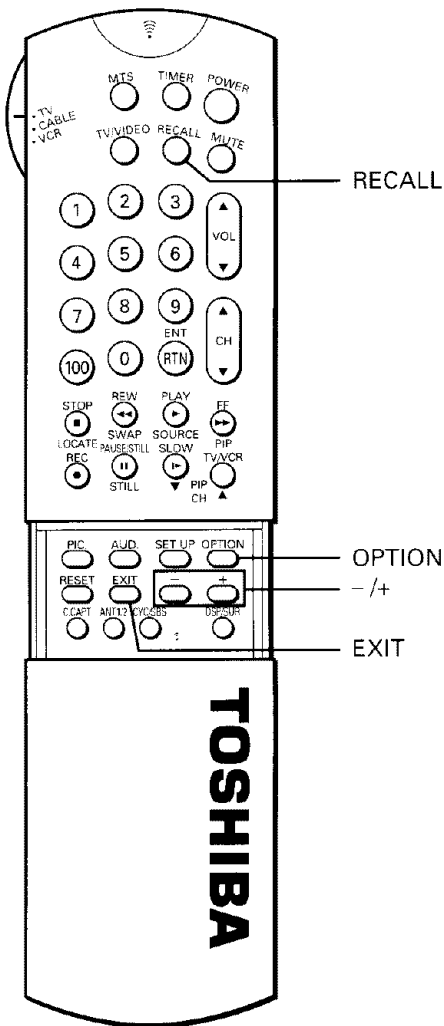
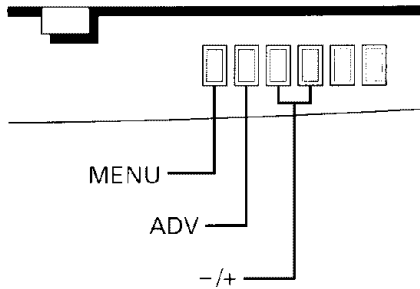

TO START THE AUTO DEMONSTRATION

- 1 Press **OPTION** on the Remote Control (or **MENU** on the TV) to display the Option menu on the screen.
- 2 Press **OPTION** repeatedly (or **ADV** on the TV) until "DEMONSTRATION" is displayed in magenta.
- 3 Press **-** or **+** until "DEMO START" is displayed on the screen in magenta. The on-screen demonstration will start after about 6 seconds.

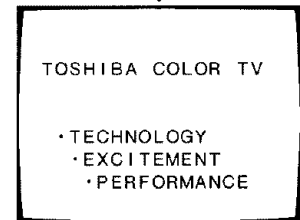
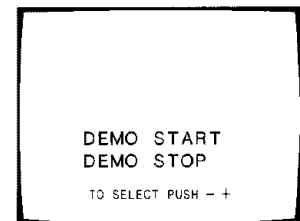
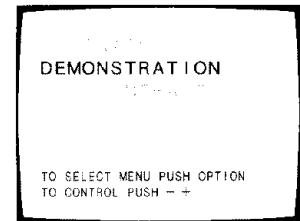

To stop the demonstration

Press **RECALL** or **EXIT**, or select "DEMO STOP" in step 3 above.

Note: The PIP CONTRAST function is described on page 31.

MONITOR PANEL

This TV set is equipped with S-VIDEO INPUT jacks, VIDEO/AUDIO INPUT jacks, VARIABLE AUDIO OUTPUT jacks, and EXTERNAL SPEAKER terminals for connecting your desired video/audio equipment.

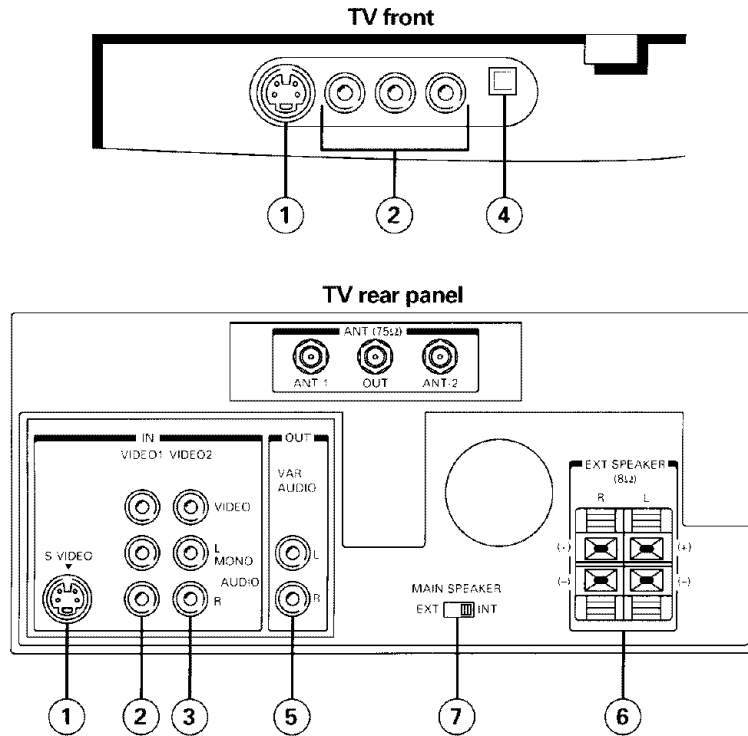

- ① **S-VIDEO IN Jacks** – provide for direct S-video connection from an **SVHS** VCR or a video disc player. The TV's VIDEO 1 AUDIO jacks can also be used to connect the VCR's audio cables. Connection details are on pages 42 and 43.
- ② ③ **VIDEO 1/VIDEO 2 IN Jacks** – provide for direct connection of video devices (VCR, video disc player, camcorder, etc.) with video/audio outputs. Connection details are on pages 41 and 43.
- ④ **VIDEO 1 SELECT Button** – lets you switch between two signal sources connected to the Front VIDEO 1 and Rear VIDEO 1 jacks. See page 41 for details.
- ⑤ **VARIABLE AUDIO OUT Jacks** – feed volume-controlled stereo audio out from whatever is displayed on the screen, allows connection of audio amplifier and lets you adjust sound level with TV's remote. Connection details are on page 44.
- ⑥ **EXTERNAL SPEAKER Terminals** – provide for direct connection of external speakers. Connection details are on page 45.
- ⑦ **MAIN SPEAKER Switch** – lets you turn off TV's built-in speakers so that sound will instead come through speakers connected to EXTERNAL SPEAKER terminals. See page 45 for details.

CONNECTING A STANDARD VCR

Connect VIDEO1 or VIDEO2 IN jacks on the TV rear panel to the video/audio output jacks of an installed VCR, video disc player, etc. for playback of video material.

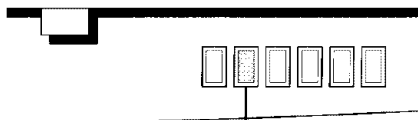
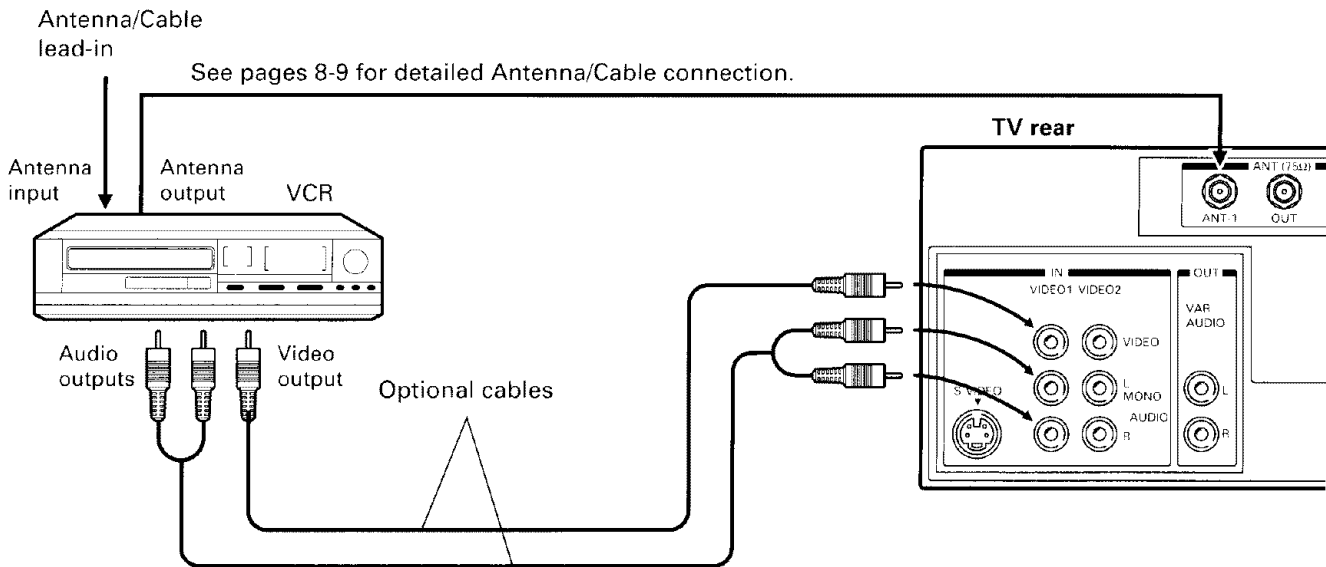

ANT/VIDEO

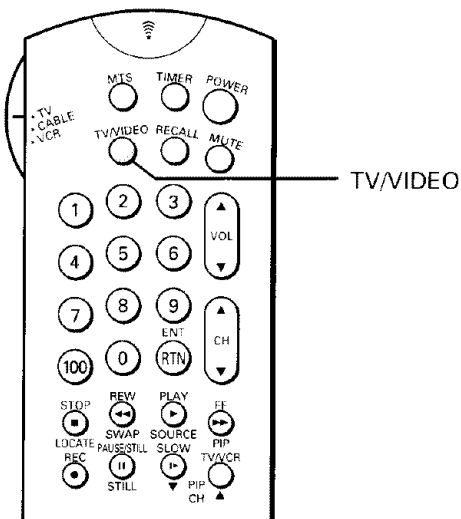

TO SELECT VIDEO INPUT SOURCE

To operate your TV and video equipment properly, refer to the instructions furnished with the video equipment.

- 1 Turn the TV and VCR ON.
- 2 Press **TV/VIDEO** on the Remote Control (or **ANT/VIDEO** on the TV) to select the appropriate source. Each time you press the button, TV, VIDEO 1 or VIDEO 2 source will be selected in order. The selected source will be displayed in magenta.
- 3 Push the VIDEO 1 SELECT button on the TV set to the inner position (■) to select the Rear "VIDEO 1".
 - Inner position for Rear "VIDEO 1".
 - Outer position for Front "VIDEO 1".
 Normally set this button in the inner position.
- 4 Operate your VCR normally.

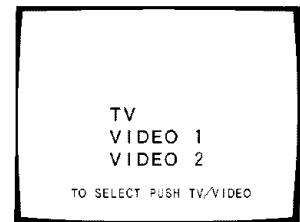

Notes:

- The VIDEO 2 IN jacks can also be used for connecting a second piece of video equipments with video/audio outputs. To view video from equipment connected to the VIDEO 2 IN jacks, select "VIDEO 2".
- If you connect a monaural VCR, connect the audio output of the VCR to the L/MONO jack of VIDEO 1/2 on the TV.

CONNECTING A VCR WITH AN S-VIDEO JACK

If you connect a VCR with an S-video jack to the "S-VIDEO" jack on the back of the TV, you must also connect the audio cables to the AUDIO jacks of "VIDEO 1 IN" on the back of the TV. The S-video cable only carries the video signal. Audio signals are separate.

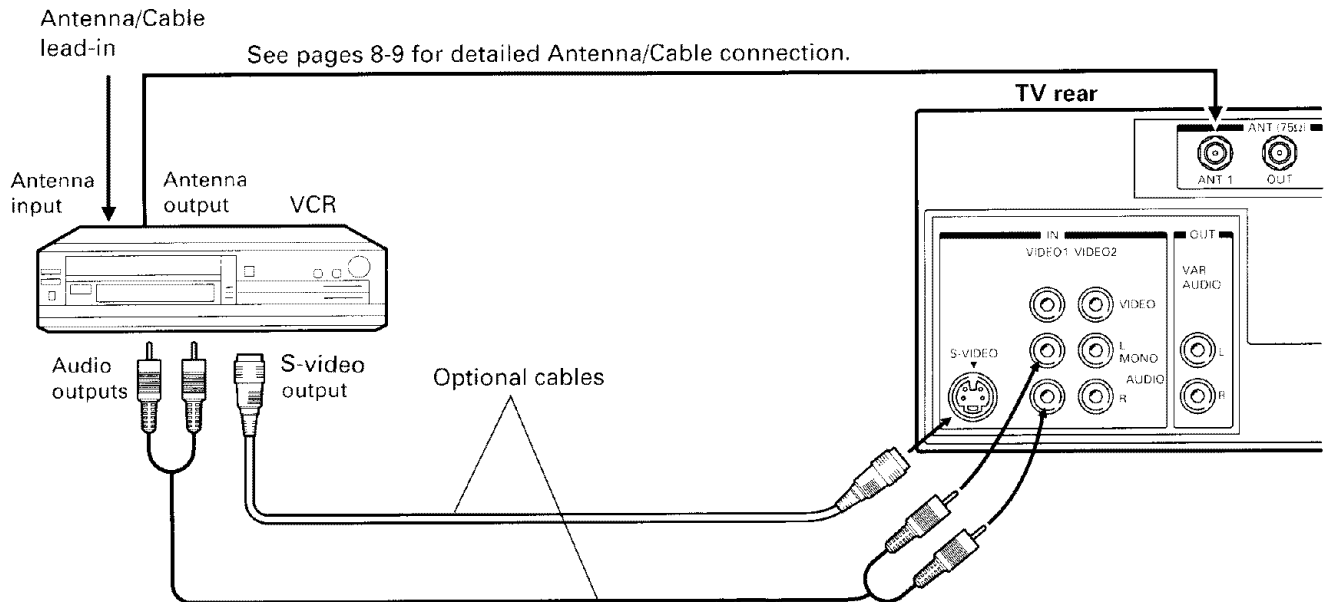

TO SELECT VIDEO INPUT SOURCE

- 1 Turn the TV and VCR ON.
- 2 Press **TV/VIDEO** on the Remote Control (or **ANT/VIDEO** on the TV) to select the "VIDEO 1" mode.
- 3 Push the VIDEO 1 SELECT button on the TV to the inner position (▲).
- 4 Operate your VCR normally.

Notes:

- If you connect a monaural VCR, connect the audio output of the VCR to the L/MONO jack of VIDEO 1 on the TV.
- The S-VIDEO jack has priority over the phono-type (yellow) video jack when both are used.
- The S-VIDEO terminal accepts SEPARATED Luminance/Chrominance (Y-C) signals conforming to the NTSC standard.

CONNECTING A CAMCORDER

This connection allows you to play back tapes in the camcorder and watch them on the TV.

— **If you have a camcorder with an S-video jack**, connect the s-video cable to the S-VIDEO jack of the Front "VIDEO 1 IN" jacks.

— **If you have a standard camcorder**, connect the video cable to the VIDEO jack of the Front "VIDEO 1 IN" jacks.

With either video connection, connect the audio cables.

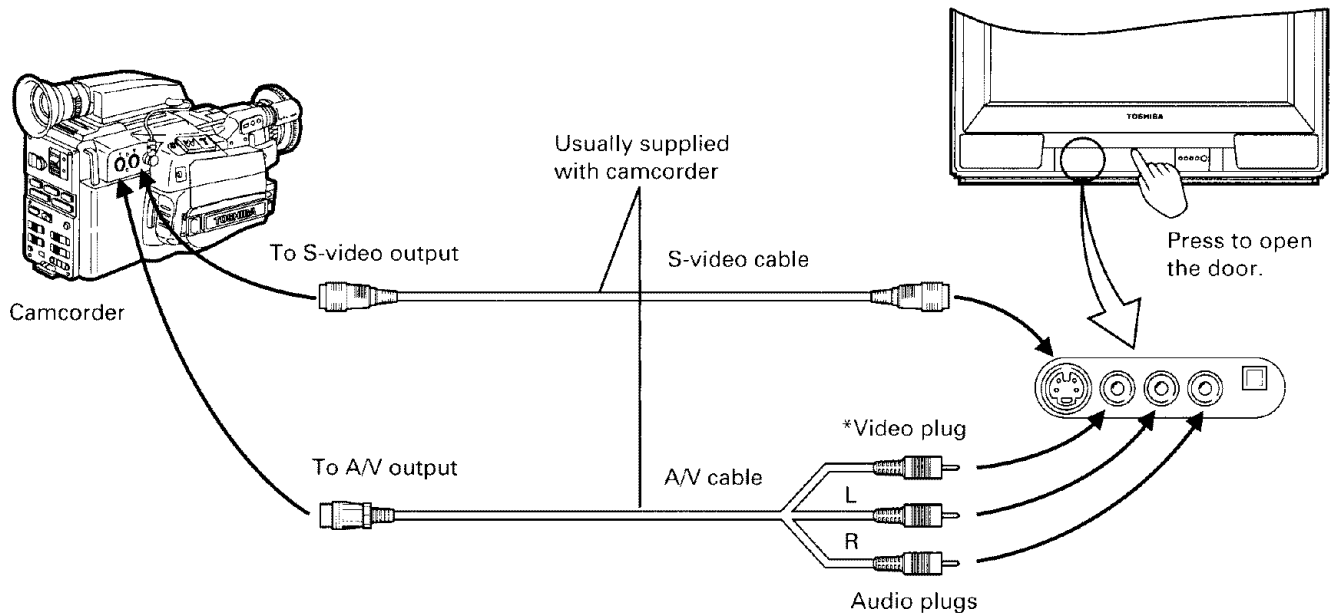

SELECTING VIDEO SOURCES

To operate your TV and camcorder properly, refer to the instructions furnished with the connected camcorder.

- 1 Turn the TV and the camcorder ON.
- 2 Press **TV/VIDEO** on the Remote Control (or **ANT/VIDEO** on the TV) to select the "VIDEO 1" mode.
- 3 Push the VIDEO 1 SELECT button on the TV set to the outer position (■).
- 4 Operate your camcorder normally.

Notes:

* When the S-video cable is connected to the S-VIDEO INPUT jack, the Video plug does not have to be connected.

- If you connect a monaural camcorder, connect the audio output of the camcorder to the L/MONO jack.

CONNECTING AN AUDIO AMPLIFIER

Connect the VARIABLE AUDIO OUT jacks to the external input jacks on the stereo amplifier. You will be able to change and mute volume with the TV's remote control. You will also be able to control bass, treble and balance functions.

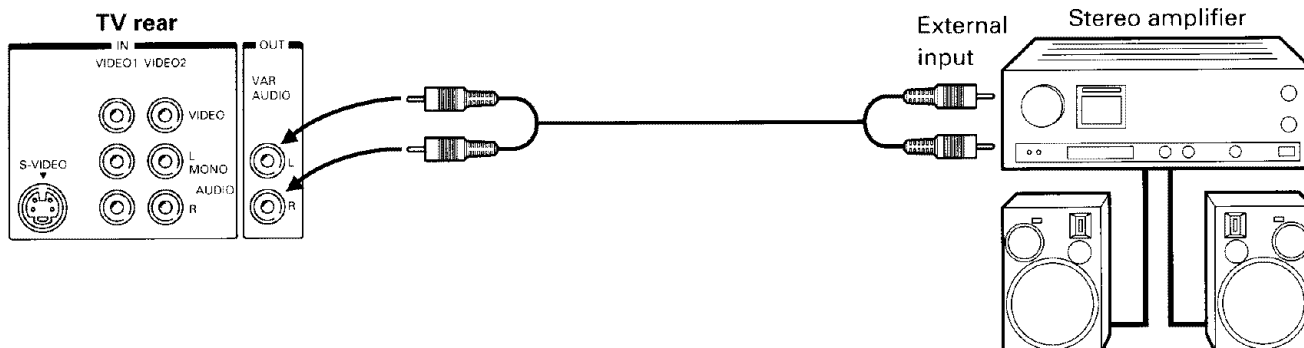

PREPARING FOR USE

- 1 Turn the TV and stereo amplifier ON.
- 2 Adjust the VOLUME control on the TV for a moderate listening level.
- 3 Disconnect the built-in speakers following the instructions at the right.
- 4 Adjust the volume control on the stereo amplifier for a moderate listening level.
- 5 Control of the audio can now be done using the audio function buttons (VOLUME, MUTE, BASS, TREBLE and BALANCE) on the TV's remote control.

TO DISCONNECT THE BUILT-IN SPEAKERS

- 1 Press **AUD** on the Remote Control until "SPEAKERS" in the Audio menu is displayed in magenta.

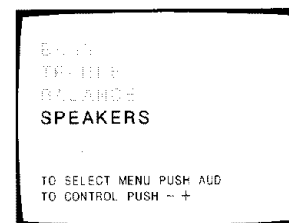

- 2 Press - or + until "SPEAKERS OFF" is displayed on the screen in magenta.

The built-in main speakers will be disconnected.

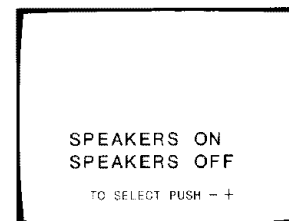

To use the built-in speakers again

Select "SPEAKERS ON" in step 2 above.

Note: If necessary, deactivate the CYCLONE woofer.

CONNECTING EXTERNAL SPEAKERS

You can connect speakers to the EXTERNAL SPEAKER terminals on the TV set to enhance sound from the TV.

Before connecting the speakers, turn the TV off.

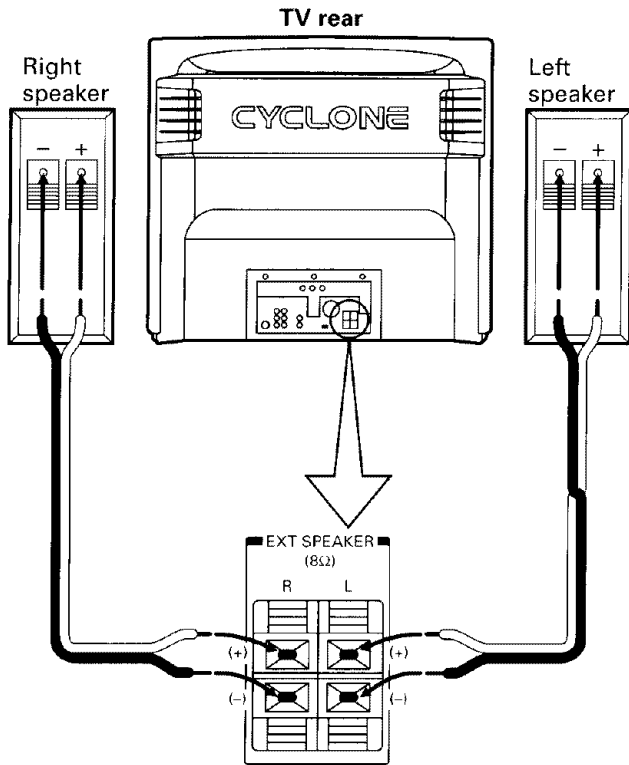

PREPARING FOR USE

- 1 Connect the speaker leads. While depressing the button, insert the wire. Then, release the button. Match the right and left channels and +/- polarities of the TV speaker terminals and external speakers.

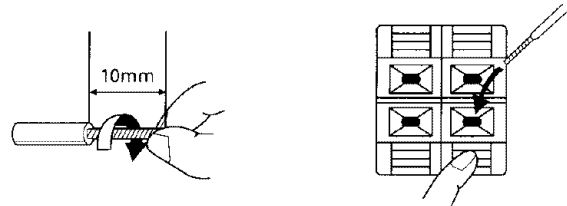

Twist wire core.

- 2 Set the MAIN SPEAKER switch to "EXT". The built-in TV speakers are disconnected.

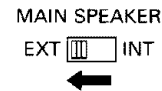

CAUTIONS:

- Do not connect external speakers to more than one audio source at a time. You will damage your equipment if you connect the same speaker system to both the TV and amplifier.
- Use only external speakers with an impedance rating of 8 ohms and input power of 7 W or greater.

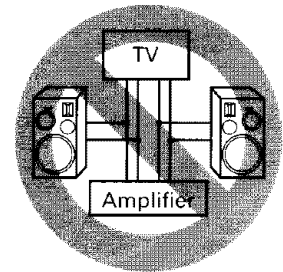

Note: The CYCLONE woofer is not affected by the MAIN SPEAKER switch. If necessary, deactivate the CYCLONE. See page 29.

CLEANING AND CARE

WARNING: TV sets use High Voltage. Do not try to remove the cabinet back. Refer servicing to qualified service personnel.

- To clean the TV screen:
 1. First remove the plug from the power outlet to avoid possible shock hazard.
 2. Use a clean cellulose sponge or chamois cloth dampened with a solution of mild detergent and warm water to clean TV screen and trim. Do not use too much water on the TV screen. Water spills into the cabinet may cause damage to the TV. Avoid excess water.
 3. Remove any extra moisture with the same cloth or a dry one.
 - To maintain the finish and appearance of the cabinet, polish it from time to time with a quality furniture polish.
- Note:** Never use strong solvents such as thinner, benzene or other chemicals on or near cabinet, as they might damage the finish of the cabinet.

SPECIFICATIONS

TELEVISION SYSTEM	NTSC standard
CHANNEL COVERAGE	VHF: 2 through 13 UHF: 14 through 69 CABLE TV: mid band (A-8 through A-1, A through I) super band (J through W) hyper band (AA through ZZ, AAA, BBB) ultra band (65 through 94, 100 through 125)
POWER SOURCE	120V AC, 60Hz
POWER CONSUMPTION	108W (average)
AUDIO POWER	Main: 7W + 7W Sub-woofer: 10W
SPEAKER TYPE	Main speakers: Two 2-3/4" × 5" oval CYCLONE woofer: One 4" round
VIDEO/AUDIO TERMINALS	S-VIDEO INPUT Y-INPUT: 1V(p-p), 75 ohm, negative sync. C-INPUT: 0.286V (p-p) (burst signal), 75 ohm VIDEO 1/VIDEO 2 INPUT VIDEO: 1V(p-p), 75 ohm, negative sync. AUDIO: 150mV (rms) (30% modulation, 47k ohm) VARIABLE: AUDIO OUTPUT 0-350mV (rms) (30% modulation, 4.7k ohm) EXTERNAL SPEAKER TERMINALS Accept speakers of impedance 8 ohm, input power 7W or greater
DIMENSIONS	Width: 27-41/64 inches (702mm) Height: 24-37/64 inches (624mm) Depth: 19-39/64 inches (498mm)
MASS	88.4lbs (40.1kg)
SUPPLIED ACCESSORIES	Remote Control with 2 "AA" size batteries Antenna adapter

Design and specifications are subject to change without notice.

BEFORE CALLING SERVICE PERSONNEL

Before calling service personnel, please check the following chart for a possible cause of the problem you are experiencing. A minor adjustment on your part may eliminate the problem and restore your TV reception.

Symptoms	Check	Adjustments
<ul style="list-style-type: none"> No picture, no sound 	<ul style="list-style-type: none"> Be sure power cord is plugged in. May be station trouble. Check antenna connections. Check antenna for broken wires. 	<ul style="list-style-type: none"> Press POWER button. Try another channel.
<ul style="list-style-type: none"> No sound, picture OK 	<ul style="list-style-type: none"> May be station trouble. Check if SPEAKERS ON/OFF function (page 44) or MAIN SPEAKER switch (page 45) is properly set. 	<ul style="list-style-type: none"> Try another channel. Adjust VOLUME.
<ul style="list-style-type: none"> Poor sound, picture OK 	<ul style="list-style-type: none"> May be station trouble. Check antenna connections. May be local interference from appliance. Check if SPEAKERS ON/OFF function or MAIN SPEAKER switch is properly set. 	<ul style="list-style-type: none"> Try another channel. Adjust VOLUME. Adjust BASS, TREBLE, or BALANCE control. Re-orient antenna.
<ul style="list-style-type: none"> Poor picture, sound OK Snowy picture Lines in picture Distorted picture Weak picture 	<ul style="list-style-type: none"> May be local interference from appliance. Check antenna connections. Check antenna for broken wires. May be station trouble. 	<ul style="list-style-type: none"> Try another channel. Adjust BRIGHTNESS. Adjust CONTRAST. Adjust SHARPNESS. Re-orient antenna.
<ul style="list-style-type: none"> Poor reception of broadcast channels 	<ul style="list-style-type: none"> Check antenna connections. Check antenna for broken wires. If VCR is connected, check TV/VCR switch. 	<ul style="list-style-type: none"> Try another channel. Re-orient antenna.
<ul style="list-style-type: none"> No UHF, VHF OK 	<ul style="list-style-type: none"> Be sure TV•CABLE function (page 22) is in "TV" mode. 	
<ul style="list-style-type: none"> Unable to select a certain channel 	<ul style="list-style-type: none"> That channel may be locked out with CH LOCK function (page 34), or erased with the ADD/ERASE function (page 23). 	
<ul style="list-style-type: none"> Multiple images (ghosts) 	<ul style="list-style-type: none"> May be station trouble. Check antenna connections. 	<ul style="list-style-type: none"> Try another channel. Re-orient antenna.
<ul style="list-style-type: none"> Poor color or No color 	<ul style="list-style-type: none"> May be station trouble. Check antenna connections. Check antenna for broken wires. May be local interference from appliance. Check if station is broadcasting in color. If you change the direction of the TV while the TV is activated, the picture may suffer from color shading. If so, turn off the TV and allow for about 30 minutes to cool, then turn on the TV again. The picture should improve. 	<ul style="list-style-type: none"> Try another channel. Re-orient antenna. Adjust TINT. Adjust COLOR.
<ul style="list-style-type: none"> No stereo or SAP sound from a known MTS broadcast 	<ul style="list-style-type: none"> Check if MTS button is properly set. 	
<ul style="list-style-type: none"> Remote control does not work 	<ul style="list-style-type: none"> Check if TV-CABLE-VCR switch is properly set. Be sure power cord is plugged in. Check battery in Remote Control. 	<ul style="list-style-type: none"> Change batteries.

LIMITED WARRANTY

Toshiba America Consumer Products, Inc. ("TACP") and Toshiba Hawaii Inc. ("THI") make the following limited warranties. These limited warranties extend to the original consumer purchaser or any person receiving this set as a gift from the original consumer purchaser and to no other purchaser or transferee.

Limited One (1) Year Warranty

TACP and THI warrant this product and its parts against defects in materials or workmanship for a period of one (1) year after the date of original retail purchase. During this period, TACP and THI will repair a defective product or part, without charge to you. Authorized TACP/THI service station personnel will come to your home when warranty service is required. Depending on the type of repair required, the service will either be performed in your home or the set will be taken to the authorized TACP/THI service station for repair and returned to your home at no cost to you.

Limited Two (2) Year Warranty of Picture Tube

TACP and THI further warrant the picture tube in this product against defects in materials or workmanship for a period of two (2) years after the date of original retail purchase. During this period, TACP and THI will replace a defective picture tube without charge to you, except that if a defective picture tube is replaced after one (1) year from the date of the original retail purchase, you pay labor charges involved in the replacement.

Owner's Manual and Registration Card

You should read this owner's manual thoroughly before operating this product. You should also insure that your name and address are on file as owner of a TACP/THI product by completing and mailing the enclosed registration card within ten days after you, or the person who has given you this product as a gift, purchased this product. This is one way to

enable TACP/THI to provide you with better customer service and improved products. Failure to return the card will not affect your rights under this warranty so long as you retain other proof of purchase such as a bill of sale.

Your Responsibility

The above warranties are subject to the following conditions:

- (1) You must retain your bill of sale or provide other proof of purchase.
- (2) All warranty servicing of this product must be made by an Authorized TACP/THI Service Station.
- (3) These warranties are effective only if the product is purchased and operated in the U.S.A.
- (4) Labor service charges for set installation, set up, adjustment of customer controls and installation or repair of antenna systems are not covered by this warranty. Reception problems caused by inadequate antenna systems are your responsibility.
- (5) Warranties extend only to defects in materials or workmanship as limited above and do not extend to any product or parts which have been lost or discarded by you or to damage to products or parts caused by misuse, accident, improper installation, improper maintenance or use in violation of instructions furnished by us; or to units which have been altered or modified without authorization of TACP/THI or to damage to products or parts there of which have had the the serial number removed, altered, defaced or rendered illegible.

Step-By-Step Procedures-How to Obtain Warranty Service

If, after following all of the operating instructions in this manual and checking the section "BEFORE CALLING SERVICE PERSONNEL", you find that service is needed:

- (1) Contact one of the TACP/THI Service Centers listed below for warranty service or call the TACP toll free number **800-631-3811** within thirty (30) days after you find a defective product or part to find the nearest TOSHIBA Authorized Service Station or authorized TOSHIBA Dealer.
- (2) Please present your bill of sale or other proof to the Authorized Service Station. "Authorized TACP/THI service station personnel will come to your home when warranty services required. Depending on the type of repair required, the service will either be performed in your home or the set will be taken to the authorized TACP/THI service station for repair and returned to your home at no cost to you."
- (3) If you have any question about service, please contact one of the following TACP/THI Service Centers:

IN THE CONTINENTAL UNITED STATES
Should your unit require service. Call



NORTHEAST	MIDWEST	WEST	SOUTHEAST	SOUTHWEST	HAWAII
82 Totowa Road, Wayne, New Jersey 07470	1010 Johnson Drive, Buffalo Grove, Illinois 60089-6900	5490 E. Francis St., Ontario, California 91761	6115 Jimmy Carter Blvd., Suite C2, Norcross, Georgia 30071-4607	1421 Champion Drive, Suite 304, Carrollton, Texas 75006	327 Kamakee Street, Honolulu, Hawaii 96814

ALL WARRANTIES IMPLIED BY STATE LAW, INCLUDING THE IMPLIED WARRANTIES OF MERCHANTABILITY AND FITNESS FOR A PARTICULAR PURPOSE, ARE EXPRESSLY LIMITED TO THE DURATION OF THE LIMITED WARRANTIES SET FORTH ABOVE. Some states do not allow limitations on how long an implied warranty lasts, so the above limitation may not apply to you. **WITH THE EXCEPTION OF ANY WARRANTIES IMPLIED BY STATE LAW AS HEREBY LIMITED, THE FOREGOING EXPRESS WARRANTY IS EXCLUSIVE AND IN LIEU OF ALL OTHER WARRANTIES, GUARANTEES, AGREEMENTS AND SIMILAR OBLIGATIONS OF MANUFACTURER OR SELLER WITH RESPECT TO THE REPAIR OR REPLACEMENT OF ANY PRODUCT OR PARTS.**

NO EVENT SHALL TACP OR THI BE LIABLE FOR CONSEQUENTIAL OR INCIDENTAL DAMAGES. Some states do not allow the exclusion or limitation of incidental or consequential damages so the above limitation may not apply to you.

No person, agent, distributor, dealer, service station or company is authorized to change, modify or extend the terms of these warranties in any manner whatsoever. The time within which an action must be commenced to enforce any obligation of TACP and THI arising under this warranty or under any statute, or law of the United States or any state thereof, is hereby limited to one year from the date you discover or should have discovered, the defect. This limitation does not apply to implied warranties arising under state law. Some states do not permit limitation of the time within which you may bring an action beyond the limits provided by state law so the above provision may not apply to you. This warranty gives you specific legal rights and you may also have other rights which vary from state to state.

TOSHIBA AMERICA CONSUMER PRODUCTS, INC.

HEAD OFFICE/82 TOTOWA ROAD, WAYNE, NEW JERSEY 07470

FACTORY SERVICE CENTERS/NORTHEAST: 82 TOTOWA ROAD, WAYNE, NEW JERSEY 07470

MIDWEST: 1010 JOHNSON DRIVE, BUFFALO GROVE, ILLINOIS 60089-6900

WEST: 5490 E. FRANCIS ST., ONTARIO, CALIFORNIA 91761

SOUTHWEST: 1421 CHAMPION DRIVE, SUITE 304 CARROLLTON, TEXAS 75006

SOUTHEAST: 6115 JIMMY CARTER BLVD., SUITE C2, NORCROSS, GEORGIA 30071-4607

TOSHIBA HAWAII, INC.

HEAD OFFICE/327 KAMAKEE STREET, HONOLULU, HAWAII 96814, U.S.A. PHONE: (808)521-5377

MANUFACTURED BY

TOSHIBA AMERICA CONSUMER PRODUCTS, INC.

PRINTED IN USA

(94-07)

TOSHIBA

23562102