

# **OWNERS MANUAL**

# IMPORTANT PERSONAL SAFETY INSTRUCTIONS

Products with a  label have been listed with Underwriter's Laboratories, Inc. – those with a CSA tag have been listed with Canadian Standards Association. Nevertheless, as with any other equipment using electricity and moving parts, there is a potential hazard.

**WARNING** – When using your dishwasher, follow basic precautions, including the following:

1. Read all instructions before using the dishwasher.
2. Use the dishwasher only for its intended function.
3. Disconnect electrical power to dishwasher before attempting to service.
4. To avoid electrical shock hazard, the sides and back must be enclosed and the front panels must be attached before electrical power is applied to the dishwasher. Refer to the installation instructions for proper grounding procedures.
5. Connect to a properly rated, protected and sized power supply circuit to avoid electrical overload.
6. Children should never be permitted to operate, or play in, with, or around this dishwasher.
7. To reduce the risk of injury when loading items to be washed, sharp or pointed items should be located with the handles up. Also, load sharp items so they are not likely to damage the door seal.
8. Be careful not to touch the heating element on the bottom of the tub during or at the completion of a cycle. It may be hot.
9. Use only detergents and rinse additives designed for an automatic dishwasher. Never use soap, laundry detergent, or hand washing detergent in your dishwasher. Keep these products out of reach of children.
10. Do not sit, stand on or abuse the door or dish racks of the dishwasher.
11. Under certain conditions, hydrogen gas may be produced in a hot water system that has not been used for two weeks or more. **Hydrogen gas is explosive.** If the hot water system has not been used for such a period, turn on all hot water faucets and let the water flow from each for several minutes. This will release any accumulated hydrogen gas. As the gas is flammable, do not smoke or use an open flame during this process.
12. Do not wash plastic items unless marked "dishwasher safe" or the equivalent. For plastic items not so marked, check the manufacturer's recommendations.
13. Do not tamper with controls.
14. Always remove the door to the washing compartment when removing an old dishwasher from service or discarding it.

**SAVE THESE INSTRUCTIONS**

# LOADING INFORMATION

## Before Washing

Typically, the majority of loads contain items of varying size and type. That's why your new Maytag dishwasher is designed to accommodate a variety of dishes, glasses, stemware, utensils and pots and pans.

The following illustrations and information will help you become more familiar with your dishwasher racking system. After a few dishloads, you will be able to determine the best arrangement for your items.

- **Don't Prerinse. Simply scrape off any bones or large food particles.** The disposer in your dishwasher will handle the occasional pits, fruit seeds and popcorn. These items will be chopped into small pieces during drain and removed with the drain water. You may hear a chopping noise during drain. This is normal.
- If connected to a food waste disposer, **make certain the disposer is empty before starting the dishwasher.** This allows proper draining.
- **Remove certain foods** (such as mustard, mayonnaise, lemon juice, vinegar, salt or dressings) **from stainless steel flatware as soon as possible.** These foods may cause rusting and pitting if allowed to remain in contact with the surface for an extended period of time.
- **Scrape or soak items with burnt on foods** as they require more energy than the rest of the load to clean satisfactorily.
- **Soak or wipe a starchy film from utensils** used to cook foods such as potatoes, pasta, rice, oatmeal, etc...as they require more energy than the rest of the load to clean satisfactorily.

## General Recommendations

- Place all items in the racks so they are separated and facing center. This ensures the water spray can reach soiled surfaces for good washing and rinsing results.
- Wedge flat, lightweight items (such as plastic lids) next to the silverware basket or along the sides and back of the racks.
- Load items so they do not rest over the top of the wash tower. This water spray is needed to properly clean items in the upper rack.
- Avoid blocking the upper and lower spray arms by not allowing items to extend beyond the racks.
- Place glasses in any row of the racks for proper cleaning and rinsing. **Do not load glasses over the tines.**

## Upper Rack

*(Features vary depending on model)*

The upper rack is designed with great flexibility and versatility. Glasses, cups, stemware, light-weight plastics, small plates, bowls, pans, long-handled utensils etc. can be loaded in this rack.

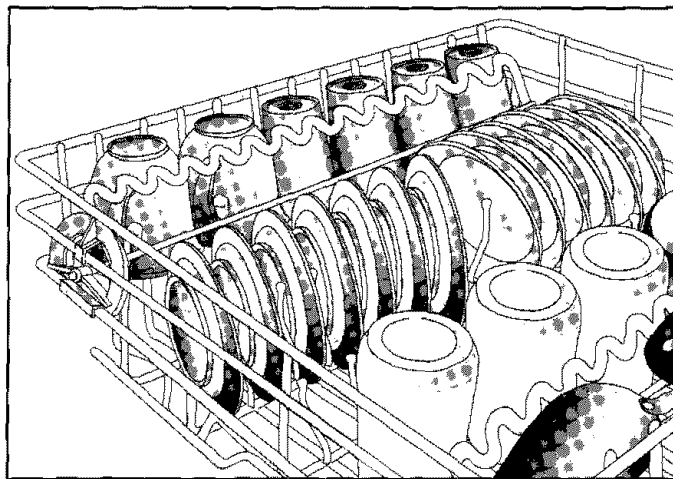

Items can be centered behind a single tine or loaded at an angle to maximize space. For best results, leave a small space between pieces so they do not touch during the cycle.

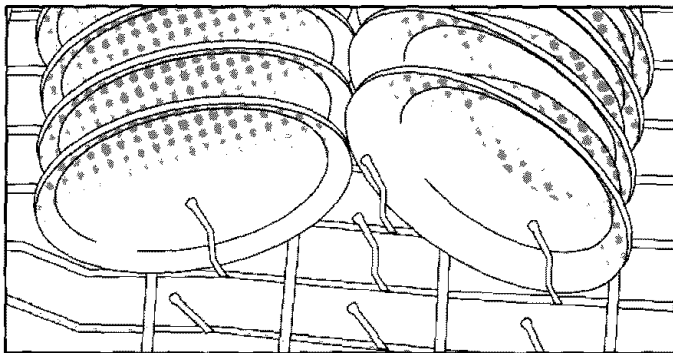

Glasses, tumblers, stemware and cups can be placed in the top rack. **Do not load these items over the tines.** It makes them more difficult to rinse.

### Correct

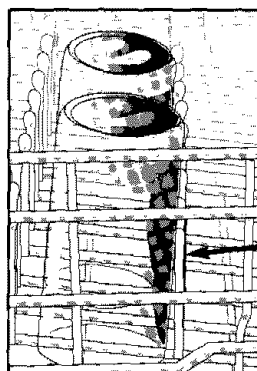

### Incorrect

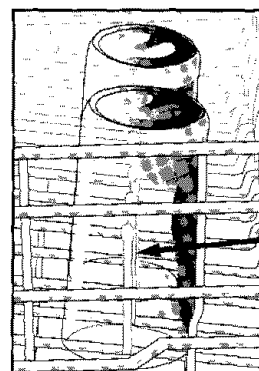

Tine out

Tine in

Place stemware in the Stem-Lock area(s) for added support. The curved design on the Vari-Lock Support (left) and Stack-Rack (right) holds stemware in place. Taller stemware will fit better on the right side as the rack is deeper there.

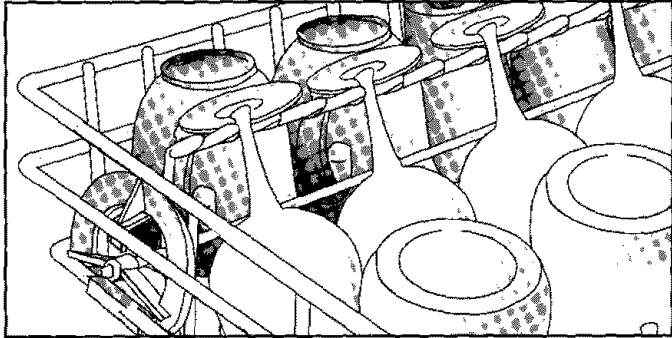

The Vari-Lock Snagger on the left (select models) can be adjusted by grasping the wire and rotating it left or right as needed. Simply move the wire to the left to snug items against the rack or to the right and rest it on top of lightweight cups or plastics. **Do not load items on top of the wire.**

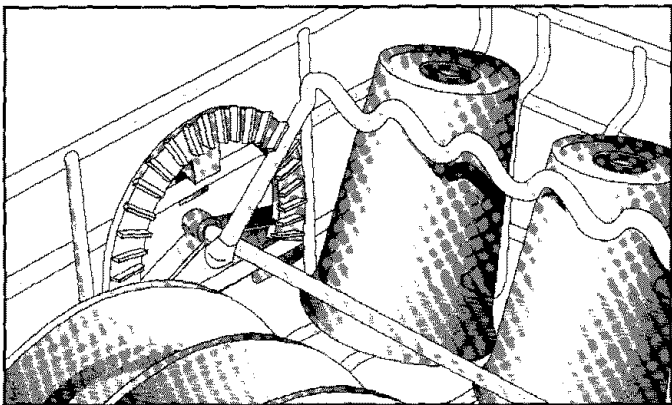

The Stack-Rack design on the right side of the upper rack folds up or down for loading flexibility of a variety of items. Fold it down to hold long-handled knives, spatulas and spoons or short items like cups or juice glasses. Fold it up for taller items like glasses, bowls, plates, etc.

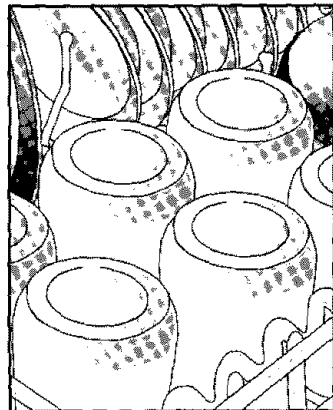
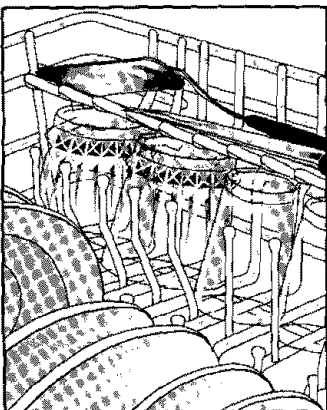

## Lower Rack

*(Features vary depending on model)*

The lower rack is designed to accommodate a variety of large items such as dinner plates, mixing bowls, pots and pans, baking dishes, etc.

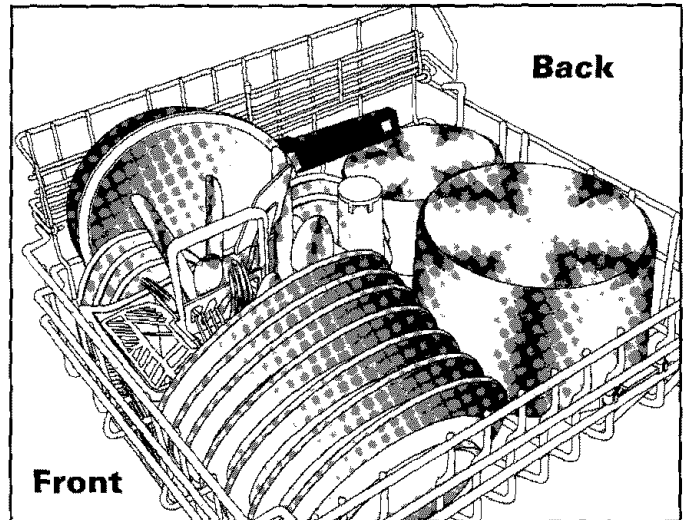

Tall items such as bakeware and large platters can be placed on the left side or across the back of this rack.

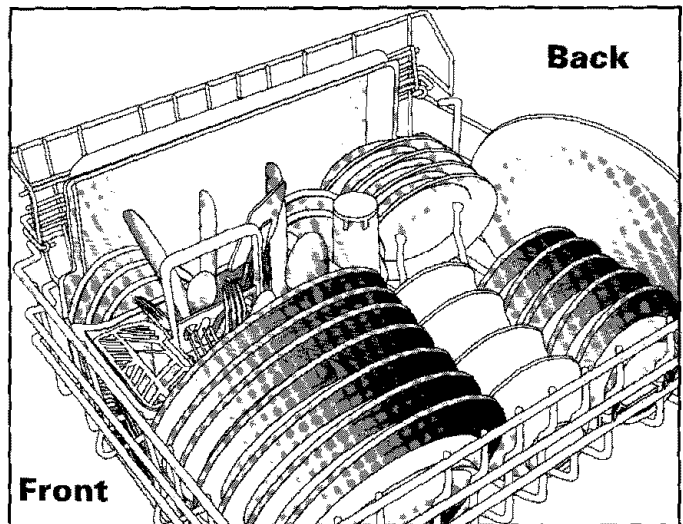

With the Stack-Rack shelf (select models) raised, thin items like cookie sheets or pizza pans may be placed along the left side. With the shelf down, two levels of glasses and cups can also be loaded.

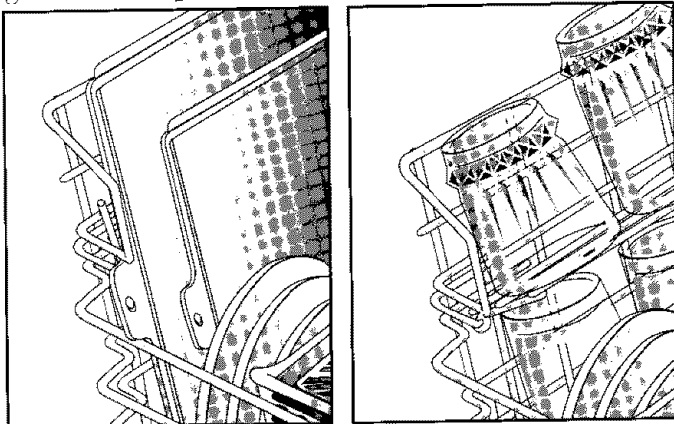

Convertible tines can be positioned to provide narrow spacing for loading dinner plates or wide spacing for loading deep bowls, pots or pans.

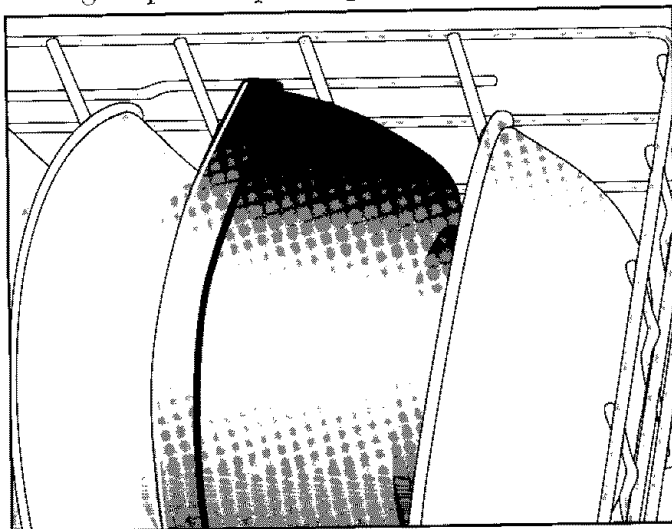

Create-A-Space tines across the center of the lower rack allow small saucers and bowls to be loaded between rows of plates.

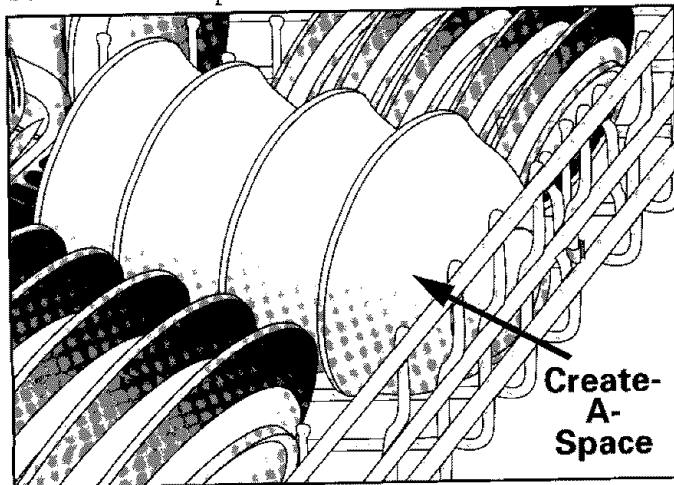

## Removable Utensil Basket

*(Design varies depending on model)*

The basket can be removed for ease in loading and unloading items. Place items in the basket with some handles up and some down. This prevents them from nesting together and improves cleaning results. (Most knives or sharp, pointed items should be placed in the basket with the handles up. Be sure thin, finely pointed items do not extend through the basket and block the lower wash arm.)

Use the covered section of the basket for small, light-weight items like baby spoons, plastic measuring spoons, small plastic items, etc. Close the cover.

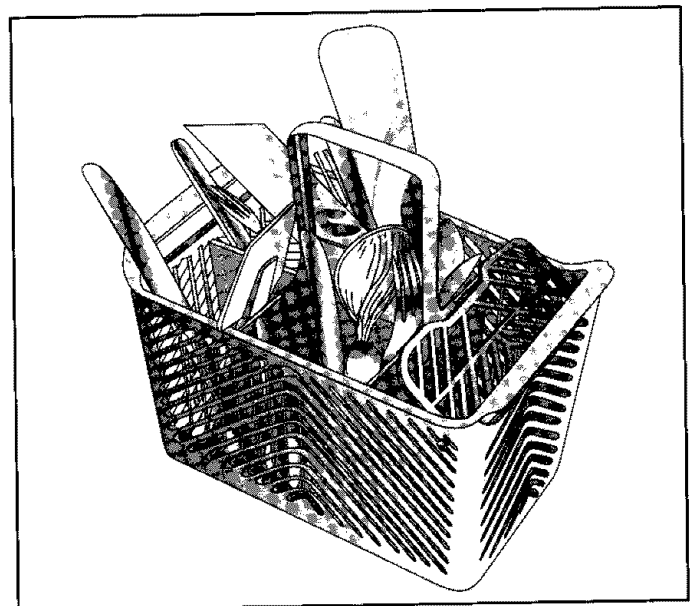

## ADDING DETERGENT

Use a detergent designed specifically for use in an automatic dishwasher. Be sure it is fresh and stored in a cool, dry place (not under the sink).

**Never use laundry detergent or hand dishwashing detergent in your dishwasher as it will cause severe oversudsing and possible leaks.**

### Recommended Amount

The amount of detergent to use depends on the water hardness (measured in grains per gallon — gpg) and the amount of soil on the dishes. Too little detergent results in poor cleaning, hard water filming and spotting and poor drying. Too much detergent causes permanent etching/cloudiness.

As a rule, use 1 teaspoon of detergent per grain of water hardness. Use a minimum of 3 teaspoons in soft water. Place the recommended amount of detergent in both cups for Normal and longer cycles. **Do not divide the recommended amount between the cups.**

The following chart includes specific recommendations. (Refer to the package directions on concentrated detergents.)

Water Hardness*	Detergent Use
Soft (0-3 gpg)	3 teaspoons
Medium (4-9 gpg)	4-9 teaspoons
Hard (10-12 gpg)	10-12 teaspoons

\*Your local water utility or state university extension service can tell you the degree of water hardness in your area.

For water hardness of 13-14 gpg add more detergent (1 teaspoon for each gpg) to the beginning of the main wash portion of the cycle. Unlatch the door. Open it slowly and add detergent to the bottom of the tub. The dishwasher will continue through the cycle.

If water hardness is 15 gpg or harder, it is virtually impossible to get good results with *any* dishwasher. The only solution is a mechanical water softener to improve water quality and detergent effectiveness.

### Detergent Placement

Add detergent just before starting the cycle.

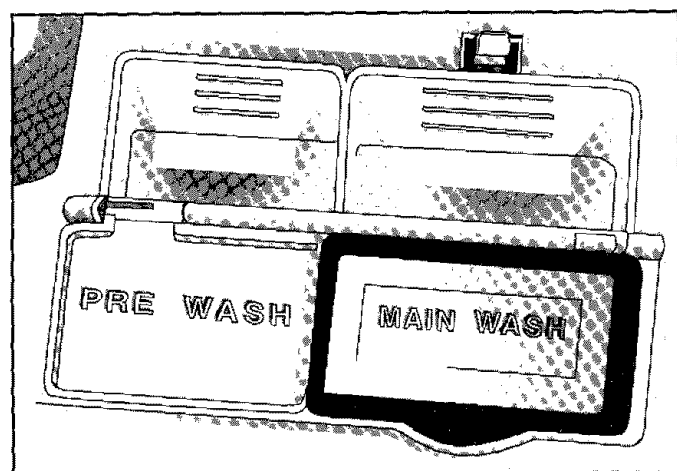

For **Normal & Heavy Wash** cycles place the recommended amount of detergent in both the PRE WASH and MAIN WASH cups. Close the cover. The dishwasher automatically releases detergent.

A **Light/China** cycle requires detergent in the main wash cup (right side) only. Close the cover after adding detergent.

**Rinse & Hold** does not use detergent.

## CHECKING RINSE AID

**Regular use of a rinse aid improves drying and reduces spotting and filming.**

Your Maytag Jetclean™ dishwasher features an automatic rinse aid dispenser located near the detergent cups in the door.

The clear window in the center of the dispenser cap allows you to see if there is rinse aid in the reservoir. When the window is colored, there is rinse aid in the dispenser. When the window becomes clear, it is time to refill the dispenser. (As a guide, check the dispenser monthly.)

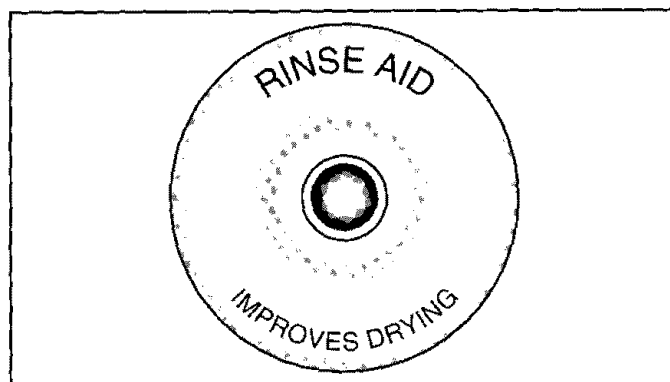

To add rinse aid to the dispenser, turn the cap counter-clockwise to open. Remove the cap and pour liquid rinse aid into the opening. Replace the cap and turn it clockwise.

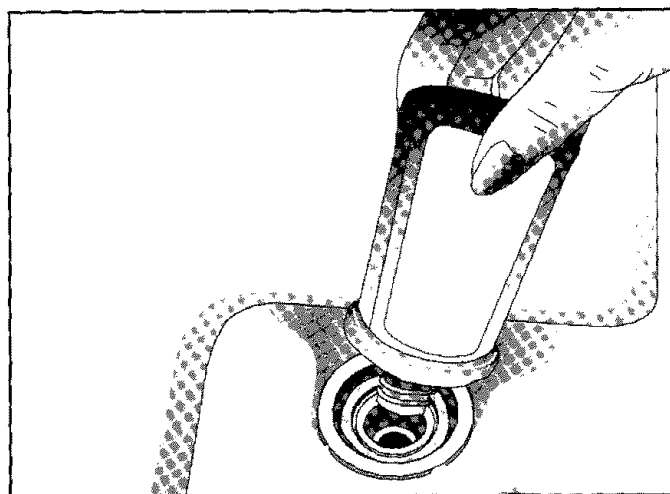

## ENSURING HOT WATER

For good cleaning and drying results, hot water is necessary. The incoming water temperature should be 120–140°F to properly activate the detergent and melt greasy food soils.

If for any reason (such as laundering, showers, etc.) the incoming water temperature is below 120°F (49°C), select the Temp Sense option to have the dishwasher thermostatically heat the water to proper temperature.

To check the incoming water temperature, turn on the hot water faucet nearest the dishwasher and let it run into a glass in the sink. Place a candy thermometer in the glass and check the temperature once it has stopped rising. If the temperature is below 120°F (49°C), have a qualified person raise the water heater thermostat setting.

Before starting the dishwasher, turn on the hot water faucet and let it run until the water is hot.

## CONNECTING A CONVERTIBLE (SELECT MODELS)

1. Turn on the faucet at the sink until hot water comes out. Turn off the faucet.
2. Pull the connector from the recess in the back of the dishwasher as shown.

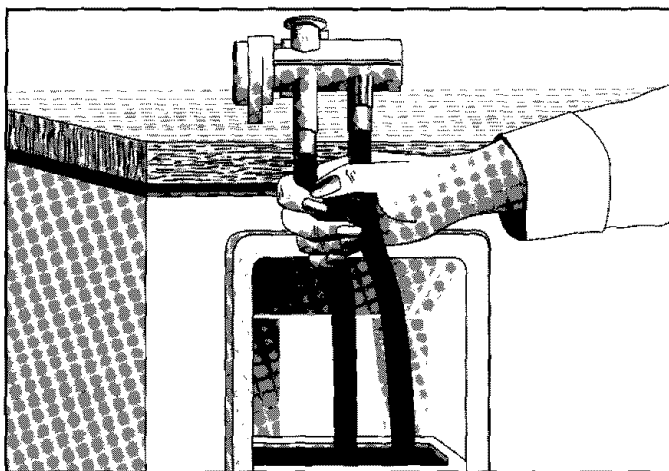

3. Press down on the thumb release and lift the connector onto the faucet.

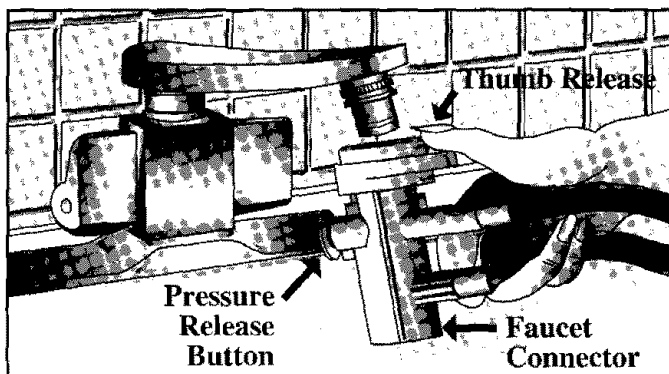

4. Remove pressure from the thumb release and tug slightly on the connector to be sure it is securely in place.
5. Turn the hot water on full force.
6. Check that the sink drain is open so water from the dishwasher can drain properly.
7. Pull the electrical cord from the recess. Plug it into a properly grounded outlet.
8. Select the proper cycle for the load and start the dishwasher.

**Note:** When disconnecting a convertible dishwasher, be sure to turn the water supply off and press the pressure release button BEFORE removing the connector.

## SELECTING CYCLES & OPTIONS

Your dishwasher features several cycles and options to provide good cleaning and drying results for a variety of loads. The following information will help you select the appropriate cycle and options for each.

### Cycles

CYCLE	SEQUENCE	WATER USE
<b>HEAVY WASH</b> provides a longer cycle for items with heavy or baked-on food soils.	PreWash 2 Rinses Main Wash 2 Rinses Dry	11 Gal.
<b>NORMAL WASH</b> is designed for loads containing normally soiled dishes.	PreWash Rinse Main Wash 2 Rinses Dry	9 Gal.
<b>LIGHT/CHINA</b> is designed for lightly soiled loads and china and crystal items.	Rinse Main Wash 2 Rinses Dry	7 Gal.
<b>QUICK WASH/RINSE (Delay Start models)</b> washes dusty or very lightly soiled items you plan to store or reuse immediately. Towel drying is necessary.	Wash 2 Rinses OFF	5 Gal.
<b>RINSE &amp; HOLD</b> rinses dishes being held for a full load to reduce potential food odor in the dishwasher.	Rinse OFF	2 Gal.

**DELAY START** allows you to program the dishwasher to operate at a more convenient time or during off-peak energy rate hours. Simply turn the knob to the desired number of delay hours and latch the door shut.

*(Cycles are located around the knob on the right side of the panel)*

#### Select models

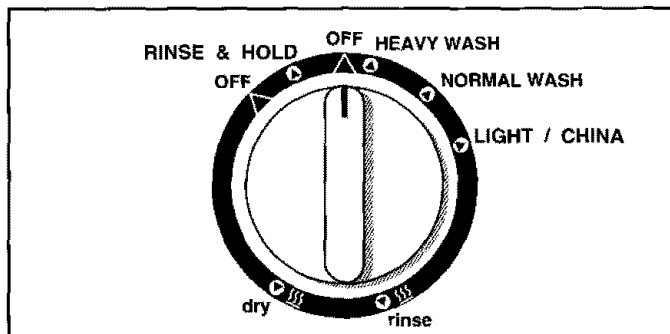

#### Delay Start models

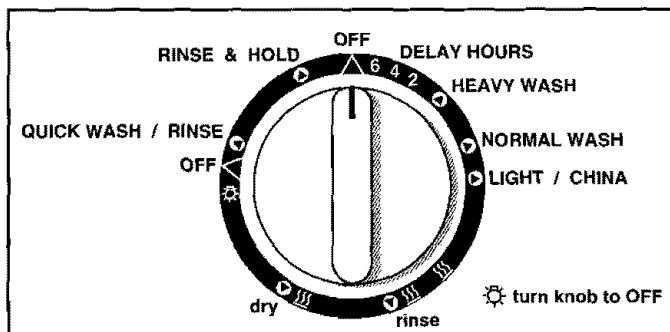

#### Options

*(Located on buttons on the left side of the panel)*

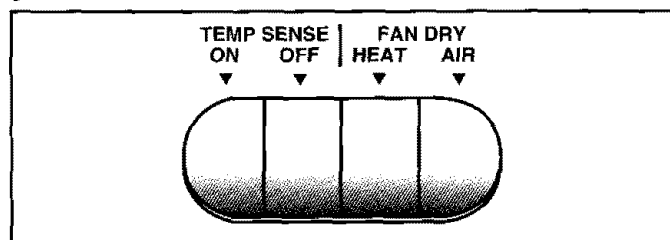

**TEMP SENSE ON** checks the main wash and final rinse water temperatures and will extend the heating and water circulation at until proper water temperature is reached.

**TEMP SENSE OFF** cancels the water temperature checks in the main wash and final rinse.

**FAN DRY HEAT** improves drying results by turning the heating element on during a portion of fan dry.

**FAN DRY AIR** turns the heating element off during the fan dry portion of the cycle. Towel drying of some items may be necessary.

**Note:** With either dry option, it is normal to notice vapor coming out of the vent area.



## STARTING THE DISHWASHER

After loading the dishwasher and adding detergent, set the control knob to the desired cycle and press the appropriate option button(s).

**NOTE:** Water heating and dry options can be used separately or together.

Next, run the water from the hot water tap to clear the line of cold water before starting. Connect select convertible models to the faucet. See page 6.

Then, press the door until it latches. The cycle will begin with a drain prior to fill.

### Indicator Light

**DELAY START** (select models) glows when this option is selected. The light stays on until the start of the cycle.

**HEATING DELAY** glows to indicate that the cycle is being extended to heat the water to proper temperature. The light corresponds to the  symbol around the control knob.

### Adding a Forgotten Item

For best cleaning, the forgotten item should be added early in the cycle.

1. Unlatch the door.
2. Wait for the water circulation to stop.
3. Open the door and add the item.
4. Close and latch the door.
5. The cycle resumes automatically.

## SPECIAL TIPS

### • Use HOT Water

Hot water dissolves and activates the detergent, dissolves grease from the load and improves drying results. Refer to page 6 for more information.

### • Use Proper Detergent Amount

For best soil removal, good drying results and prevention of filming, etching and spotting, the proper amount of detergent must be used. Refer to page 5 for recommended amounts.

### • Use a Rinse Aid

Regular use of a rinse aid improves drying results and reduces spotting and filming. See page 5 for more information.

### • Load the Dishwasher Properly

To ensure soiled surfaces get adequate wash action, carefully follow the loading instructions on pages 2-4.

### • Select the Proper Cycle

The cycle selection depends on the amount of food soil on the load. See page 7 for cycle descriptions.

### • Select Fan Dry Heat

For improved drying select FAN DRY HEAT.

# WASHING SPECIAL ITEMS

Knowing what can and cannot be washed in your dishwasher is important. Most tableware, cookware and silverware can be washed safely in your dishwasher. However, if you have any doubts about an item, check with the manufacturer. If you cannot reach the manu-

facturer, simply test-wash one small item for several washes before attempting to wash an entire set.

**NOTE: It is the user's responsibility to determine if dishware should be washed in a dishwasher.**

Material	Dishwasher Safe?	Special Information	Material	Dishwasher Safe?	Special Information
<b>Aluminum</b>	Yes, except anodized aluminum and some cookware.	High water temperature and detergents may affect finish. Check cleaning instructions.	<b>Pewter</b>	No	High water temperature and detergents may discolor or pit finish.
<b>Cast Iron</b>	No	Seasoning will be removed, and iron will rust.	<b>Disposable Plastics</b>	No	Cannot withstand high water temperatures and detergents.
<b>China/ Stoneware</b>	Yes, except antique or hand-painted china.	Always check manufacturer's recommendation before washing. Antique hand-painted or over-the-glaze patterns may fade. Gold leaf may discolor. If in doubt, test-wash a small item for several weeks before washing entire set.	<b>Plastics</b>	Yes (If labeled "dishwasher safe")	Always check manufacturer's recommendation before washing. Plastics vary in their capacity to withstand high water temperatures and detergents.
<b>Crystal</b>	Yes, except antique or lightweight delicate crystal.	Always check manufacturer's recommendation before washing. Some types of leaded crystal may etch with repeated washings. If in doubt, test wash a small item for several weeks before washing an entire set.	<b>Stainless Steel</b>	Yes	Run a Rinse & Hold Cycle (select models) if not washing immediately. Prolonged contact with foods containing salt, vinegar, milk products or fruit juice could damage finish.
<b>Glass</b>	Yes, except milkglass.	Milkglass will yellow with repeated dishwasher washing.	<b>Sterling Silver or Silverplate</b>	Yes, except with commercial "darkening".	Run a Rinse & Hold Cycle (select models) if not washing immediately. Prolonged contact with food containing salt, acid or sulfide (eggs, mayonnaise and seafood) could damage finish. Commercial "darkening" may be removed by detergent.
<b>Gold-Plated Flatware</b>	No	Will discolor.	<b>Tin</b>	No	May rust.
			<b>Wooden Items</b>	No	Always check manufacturer's recommendation before washing. Wood may warp, crack or discolor.

## WATER CONDITIONS

**Hard Water** containing calcium minerals can cause a lime film or deposit on the tub and dishes. You may first notice this as “cloudy” glasses.

**To confirm if the film is due to hard water, soak a glass approximately 5 minutes in undiluted white vinegar. Rinse and dry. If the film is removed, it is due to hard water (if not removed, see Soft Water).**

*To correct:*

1. Adjust the detergent amount to the degree of water hardness. (See pg. 5)
2. Check water temperature. (See pg. 6)
3. Use a rinse aid to improve the sheeting action of the water. (See pg. 5)

*To remove film from the dishwasher:*

*(Try one of the following.)*

1. A damp cloth and mild scouring powder.
2. A half-cup white vinegar in a Normal cycle with detergent in the MAIN WASH cup only.

**Soft Water** can promote etching if too much detergent is used, items are prerinsed or the water temperature is too high. It is a permanent film which pits or erodes the surface of the glass.

The beginning stages can be identified by a “rainbow” look — shades of blue, purple, brown or pink when the glass is held at an angle to the light. In advanced stages the surface appears frosted, spotted or cloudy.

Etching can happen in any dishwasher and there is no relationship to the cost or quality of the glass.

*To prevent:*

1. Adjust the detergent amount to water hardness. (See pg. 5)
2. Adjust the water temperature. (See pg. 6)
3. Don't prerinse. This removes food soils and aggravates etching.

**Rust Minerals** can turn the dishes or tub interior a brown, red or black color if iron or manganese is in the water.

*To prevent:*

1. Drain your home's water heater once a year to flush away any mineral deposits.
2. Check with a water treatment company like Culligan or Kinetico to see if a filter is needed in the home.

*To remove:*

*(Do not use this method on metal items.)*

1. Use a rust removing compound like RoVer Rust Remover (available from Maytag Parts Distributors by using Part No. 57961).
2. Select the Normal cycle. Add 1/2 cup RoVer Rust Remover to the tub bottom and fill the MAIN WASH cup with detergent. Let the dishwasher complete the cycle. Refer to the rust remover package for more information.

The only permanent solution is to install special filters which can remove iron and manganese from the water.

## ENERGY SAVING TIPS

1. Don't prerinse!
2. Wash full loads. The same amount of electricity and water are used.
3. Load correctly for best washing results.
4. Operate the dishwasher during off-peak hours. Check your local utility for rates.

## MAINTAINING THE DISHWASHER

Your new Maytag Jetclean™ dishwasher requires little maintenance attention. However, if you are going on vacation, leaving a summer home or storing the dishwasher for an extended period of time, you may want to review the following information.

### Dishwasher Interior

The inside design is normally self-cleaning. However, you may want to periodically check the bottom of the dishwasher tub to see if any large particles have not gone through the strainer portion of the module.

You may also want to wipe the edge of the inner door liner to remove any food soil splashes which occurred during loading.

### Odors

Any odor inside the dishwasher is likely related to a chemical (chlorine) odor from the detergent or a food odor from soiled items sitting in the dishwasher. Try using a different detergent, especially a lemon-scented one, or purchase a fresh package and see if the odor decreases.

We also recommend using the Rinse & Hold feature if dishes are to be held for a couple of days before washing. This will remove most food soils that may cause an odor.

For a strong odor, try *one* of the following:

1. Place baking soda in both sides of the detergent cup. Select Light/China and let the water circulate for about 10 minutes. Stop the dishwasher by unlatching the door and let stand overnight. Then restart the dishwasher by latching the door and let it complete the cycle.
2. Select the Light/China cycle and let the dishwasher fill with water. Then open the door and pour one cup of chlorine bleach into the bottom of the dishwasher. Latch the door and let the dishwasher complete the cycle.

### Storage/Moving

Fill both detergent cups with a fresh-scented dishwasher detergent or baking soda and select a Normal cycle. Allow the dishwasher to complete the cycle. Then turn the water supply off and set the dishwasher to drain. Operate the drain twice to ensure most of the water is removed. Last, disconnect the electrical supply and prop open the door.

### Dishwasher Exterior

The front of the dishwasher can be cleaned with a soft damp cloth and liquid spray cleaner. Do not use any abrasive powders or cleaning pads.

### Convertible Models Only

These feature a wrap-around cabinet and cherrywood veneer top. Rollers on the base of the dishwasher allow it to be rolled up to the sink when in use and placed in a more convenient location when not in use.

Before the first use, wipe the wood top with a damp cloth to remove surface dust. Dry. Then saturate a cloth with mineral oil and apply a heavy coat to the top. Let this stand overnight. The next day, apply a thin coat of mineral oil and rub with a soft dry cloth. Repeat every few months to maintain its appearance.

**Do not use the wood top as a cutting surface or a resting place for warm/hot cookware as this can damage the top.**

Clean the cabinet with a soft damp cloth and liquid spray cleaner. Apply an appliance wax to the cabinet about once a year.

# BEFORE YOU CALL...

Check these points to help save you time and money:

<p><b>Won't Fill</b></p>	<ul style="list-style-type: none"> <li>• Be sure door is latched securely.</li> <li>• Be sure the water is turned on.</li> <li>• Check that the dial/pad is properly selected for a cycle.</li> <li>• Allow time for select models to drain/pause before filling.</li> <li>• Check your home's circuit breaker or fuse box.</li> <li>• Check inlet hose for a kink.</li> <li>• Check water valve inlet for sediment and clean if necessary.</li> </ul>
<p><b>Won't Drain/Water in Tub Bottom</b></p>	<ul style="list-style-type: none"> <li>• If hooked up to a food waste disposer, be sure the knock-out is removed from the disposer inlet.</li> <li>• Be sure the drain hose is elevated at least 32" so water cannot siphon back into the tub.</li> <li>• Check for a food obstruction in the drain or disposer.</li> <li>• Check drain hose for a kink.</li> <li>• Check your home's circuit breaker or fuse box.</li> <li>• Check that the cycle is completed.</li> </ul>
<p><b>Detergent Cup Not Empty</b></p>	<ul style="list-style-type: none"> <li>• Check that the cycle is completed.</li> <li>• Be sure dispenser is not blocked.</li> <li>• Use fresh detergent stored in a cool, dry place.</li> </ul>
<p><b>Seems Noisy</b></p>	<ul style="list-style-type: none"> <li>• A water valve hiss during fill is normal.</li> <li>• Water circulation sounds are normal.</li> <li>• A ticking noise is a normal timer sound.</li> <li>• A thumping sound may be a wash arm bumping an item that is extending beyond the racks.</li> <li>• Chopping or grinding sounds may be heard during drain as the internal food disposer chops hard items like fruit seeds, nuts, etc.</li> <li>• Humming during drain is normal.</li> <li>• A snap noise is the detergent cup lid hitting the door liner when the dishwasher door is opened at the end of the cycle. This is normal.</li> <li>• Proper installation affects the noise level.</li> </ul>
<p><b>Cycle Takes Too Long— (Heating Delay light stays on)</b></p>	<ul style="list-style-type: none"> <li>• Temp Sense has been selected and the cycle is extended if the water temperature is low. (See pg. 7)</li> <li>• Check to see that the incoming water temperature is at least 120–140°F.</li> </ul>
<p><b>Has An Odor</b></p>	<ul style="list-style-type: none"> <li>• Dishes being held for a full load may need to be run through a Rinse &amp; Hold cycle while waiting (select models).</li> <li>• Many dishwashers have a "new" smell when first installed. It dissipates with use.</li> <li>• A chemical odor is usually the chlorine bleach in dishwashing detergents. You may want to try another brand.</li> <li>• Dishwasher not draining properly. (See "Won't Drain" section.)</li> </ul>
<p><b>Leaks</b></p>	<ul style="list-style-type: none"> <li>• Check that the dishwasher is level. (Refer to the Installation Instructions.)</li> <li>• Suds can cause the dishwasher to overflow. Measure the detergent carefully and use only detergents designed for use in a dishwasher. Less detergent is needed in soft water. Try another brand if sudsing continues.</li> <li>• Follow directions closely on how to add a forgotten item (see pg. 8).</li> <li>• To avoid rinse aid leaking from the dispenser, be sure the lid is securely attached.</li> </ul>



# DISHWASHER WARRANTY

## Full One Year Warranty

For ONE (1) year from the date of original retail purchase, any part which fails in normal home use will be repaired or replaced free of charge.

## Limited Two Year Warranty

After the first year from the date of original retail purchase, through the second year, parts which fail in normal home use will be repaired or replaced free of charge for the part itself, with the owner paying all other costs, including labor, mileage and transportation.

## Limited Third Through Fifth Year Warranty

After the second year from the date of original retail purchase, through the fifth year, all of the following components which fail in normal home use will be repaired or replaced free of charge for the part itself, with the owner paying all other costs, including labor, mileage and transportation. These components include:

Any parts of the Jetclean system for all models, including the complete power module assembly, center spray nozzle, spray arms, top wash arm hose, and motor.

Computer Touch Control models only – any microprocessor and touch pad assemblies.

All models against rust, including exterior cabinet and front panels of convertible models, the exterior front panels and accessory side panels or built-in models, and nylon coated racks (available on selected models).

## Full Twenty Year Warranty

First through the twentieth year

From the date of original retail purchase through the twentieth year, should the tub develop a water leak in normal home use, the dishwasher itself will be replaced **FREE OF CHARGE**.

First through the twentieth year

From the date of original retail purchase through the twentieth year, should the door liner develop a water leak in normal home use, repair or replacement of the door liner will be made **FREE OF CHARGE**.

**PLEASE NOTE:** These full warranties and the limited warranty apply when the dishwasher is located in the United States or Canada. Dishwashers located elsewhere are covered by the limited warranty only, including parts which fail during the first year.

## Canadian Residents

This warranty covers only those dishwashers installed in Canada that have been listed with Canadian Standards Association unless the dishwashers are brought into Canada due to transfer of residence from the United States to Canada.

The specific warranties expressed above are the **ONLY** warranties provided by the manufacturer. This Warranty gives you specific legal rights, and you may also have other rights that vary from state to state.

## To Receive Warranty Service

To locate an authorized service company in your area contact the Maytag dealer from whom your appliance was purchased; or call Maytag Customer Service at the number listed below. Should you not receive satisfactory warranty service, please call or write:

Maytag Customer Assistance  
c/o Maytag Customer Service  
P.O. Box 2370  
Cleveland, TN 37320-2370  
**U.S. 1-800-688-9900**  
**CANADA 1-800-688-2002**

When contacting Maytag Customer Service be sure to provide the complete model and serial number of your appliance, the name and address of the dealer from whom you purchased the appliance and the date of purchase.

**Should you still have a problem**, write to: Major Appliance Consumer Action Program, 20 North Wacker Drive, Chicago, Illinois 60606. MACAP is an industry sponsored but independent group of consumer experts who receive and act on complaints from appliance owners.

**NOTE:** When writing about an unsolved service problem, please include the following information:

- (a) Your name, address and telephone number;
- (b) Model number and serial number (found on the upper left corner of the tub opening) of your appliance;
- (c) Name and address of your dealer and the date the appliance was bought;
- (d) A clear description of the problem you are having.
- (e) Water hardness, detergent brand and amount, water temperature, and cycle used.

**MAYTAG • One Dependability Square • Newton, Iowa 50208**