



GAS RANGE

Use & Care Guide

For questions about features, operation/performance, parts, accessories or service, call: **1-800-253-1301**.

or visit our website at...
www.whirlpool.com

Table of Contents	2
-------------------------	---

To the installer: Please leave this instruction book with the range.

To the consumer: Please read and keep this book for future reference.

TABLE OF CONTENTS

RANGE SAFETY	3
The Anti-Tip Bracket	4
PARTS AND FEATURES	5
COOKTOP USE	6
Cooktop Controls	6
Power Failure	6
Cooktop Lockout	6
Sealed Surface Burners	7
Home Canning	7
Cookware	7
ELECTRONIC OVEN CONTROLS	8
Display	8
Start	8
Off/Cancel	9
Clock	9
Range Lights	9
Tones	9
Fahrenheit and Celsius	9
Timer	9
Control Lockout	9
Add 1 Minute	10
Oven Temperature Control	10
OVEN USE	10
Aluminum Foil	10
Positioning Racks and Bakeware	10
Split Oven Rack	11
Bakeware	11
Meat Thermometer	12
Oven Vent	12
Baking and Roasting	12
Broiling	12
Hold Warm Feature	13
Timed Cooking	14
Warming Drawer	15
RANGE CARE	16
Self-Cleaning Cycle	16
General Cleaning	17
Oven Light	19
Oven Door	19
Storage Drawer	19
Warming Drawer	20
TROUBLESHOOTING	20
ASSISTANCE OR SERVICE	22
Accessories	22
WARRANTY	24

RANGE SAFETY

Your safety and the safety of others are very important.

We have provided many important safety messages in this manual and on your appliance. Always read and obey all safety messages.



This is the safety alert symbol.

This symbol alerts you to potential hazards that can kill or hurt you and others.

All safety messages will follow the safety alert symbol and either the word "DANGER" or "WARNING."

These words mean:

⚠ DANGER

You can be killed or seriously injured if you don't immediately follow instructions.

⚠ WARNING

You can be killed or seriously injured if you don't follow instructions.

All safety messages will tell you what the potential hazard is, tell you how to reduce the chance of injury, and tell you what can happen if the instructions are not followed.

WARNING: If the information in this manual is not followed exactly, a fire or explosion may result causing property damage, personal injury or death.

- Do not store or use gasoline or other flammable vapors and liquids in the vicinity of this or any other appliance.
- **WHAT TO DO IF YOU SMELL GAS:**
 - Do not try to light any appliance.
 - Do not touch any electrical switch.
 - Do not use any phone in your building.
 - Immediately call your gas supplier from a neighbor's phone. Follow the gas supplier's instructions.
 - If you cannot reach your gas supplier, call the fire department.
- Installation and service must be performed by a qualified installer, service agency or the gas supplier.

The California Safe Drinking Water and Toxic Enforcement Act requires the Governor of California to publish a list of substances known to the State of California to cause cancer, birth defects, or other reproductive harm, and requires businesses to warn of potential exposure to such substances.

WARNING: This product contains a chemical known to the State of California to cause cancer, birth defects, or other reproductive harm.

This appliance can cause low-level exposure to some of the substances listed, including benzene, formaldehyde, carbon monoxide, toluene, and soot.

The Anti-Tip Bracket

The range will not tip during normal use. However, the range can tip if you apply too much force or weight to the open door without the anti-tip bracket fastened down properly.



⚠ WARNING

Tip Over Hazard

A child or adult can tip the range and be killed.

Connect anti-tip bracket to rear range foot.

Reconnect the anti-tip bracket, if the range is moved.

See the installation instructions for details.

Failure to follow these instructions can result in death or serious burns to children and adults.

Anti-Tip Bracket

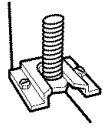

Range Foot

Making sure the anti-tip bracket is installed:

- Slide range forward.
- Look for the anti-tip bracket securely attached to floor.
- Slide range back so rear range foot is under anti-tip bracket.

IMPORTANT SAFETY INSTRUCTIONS

WARNING: To reduce the risk of fire, electrical shock, injury to persons, or damage when using the range, follow basic precautions, including the following:

- **WARNING:** TO REDUCE THE RISK OF TIPPING OF THE RANGE, THE RANGE MUST BE SECURED BY PROPERLY INSTALLED ANTI-TIP DEVICES. TO CHECK IF THE DEVICES ARE INSTALLED PROPERLY, SLIDE RANGE FORWARD, LOOK FOR ANTI-TIP BRACKET SECURELY ATTACHED TO FLOOR, AND SLIDE RANGE BACK SO REAR RANGE FOOT IS UNDER ANTI-TIP BRACKET.
- **WARNING:** NEVER use this appliance as a space heater to heat or warm the room. Doing so may result in carbon monoxide poisoning and overheating of the oven.
- **WARNING:** NEVER cover any slots, holes or passages in the oven bottom or cover an entire rack with materials such as aluminum foil. Doing so blocks air flow through the oven and may cause carbon monoxide poisoning. Aluminum foil linings may also trap heat, causing a fire hazard.
- **CAUTION:** Do not store items of interest to children in cabinets above a range or on the backguard of a range – children climbing on the range to reach items could be seriously injured.

- Proper Installation – The range, when installed, must be electrically grounded in accordance with local codes or, in the absence of local codes, with the *National Electrical Code, ANSI/NFPA 70*. Be sure the range is properly installed and grounded by a qualified technician.
- This range is equipped with a three-prong grounding plug for your protection against shock hazard and should be plugged directly into a properly grounded receptacle. Do not cut or remove the grounding prong from this plug.
- Disconnect power before servicing.
- Injuries may result from the misuse of appliance doors or drawers such as stepping, leaning, or sitting on the doors or drawers.
- Maintenance – Keep range area clear and free from combustible materials, gasoline, and other flammable vapors and liquids.
- Storage in or on the Range – Flammable materials should not be stored in an oven or near surface units.
- Top burner flame size should be adjusted so it does not extend beyond the edge of the cooking utensil.

For self-cleaning ranges –

- Before Self-Cleaning the Oven – Remove broiler pan and other utensils. Wipe off all excessive spillage before initiating the cleaning cycle.

SAVE THESE INSTRUCTIONS

PARTS AND FEATURES

This manual covers several different models. The range you have purchased may have some or all of the parts and features listed. The locations and appearances of the features shown here may not match those of your model.

Control Panel

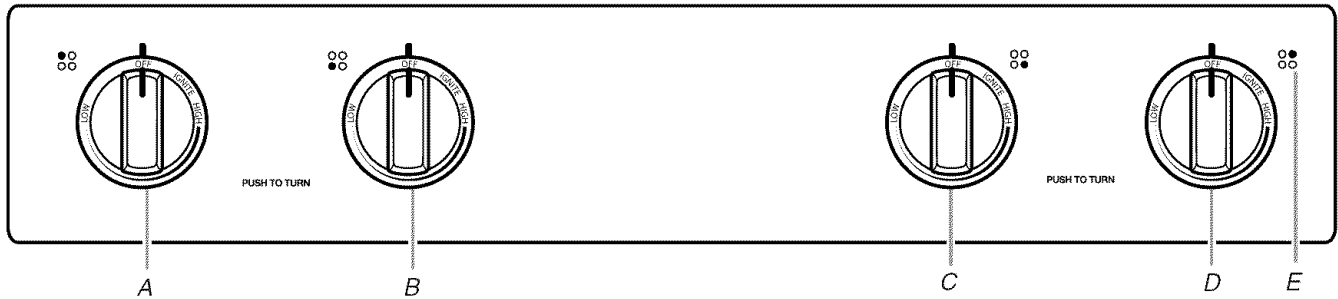

A. Left rear burner control

B. Left front burner control
(Power™ burner on some models)

C. Right front burner control

D. Right rear burner control
(ACCUSIMMER® burner on some models)

E. Surface burner locator

Range

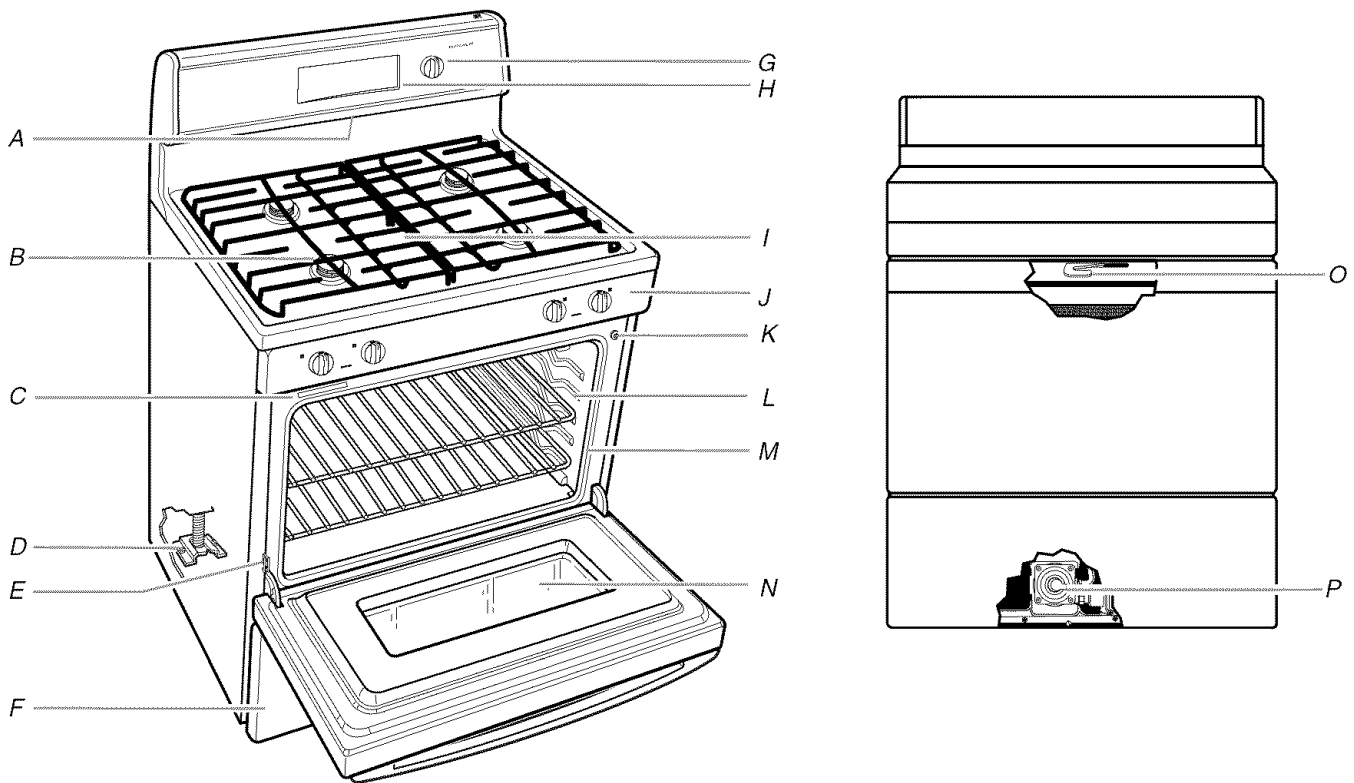

A. Oven vent

B. Surface cooking area

C. Model/serial rating plate

D. Anti-tip bracket

E. Oven door hinge

F. Storage drawer (warming drawer on some models)

G. Warming drawer control (on some models)

H. Electronic oven control

I. Center grate (on some models)

J. Surface burner control

K. Automatic oven light switch

L. Oven rack

M. Gasket

N. Oven door window

O. Self-clean latch

P. Gas regulator

Parts and Features not shown

Oven light

Broiler pan and grid (on some models)

Roasting rack (on some models)

Storage drawer liner (on some models)

COOKTOP USE

Cooktop Controls

⚠ WARNING



Fire Hazard

Do not let the burner flame extend beyond the edge of the pan.

Turn off all controls when not cooking.

Failure to follow these instructions can result in death or fire.

Electric igniters automatically light the surface burners when control knobs are turned to IGNITE.

Before setting a control knob, place filled cookware on the grate. Do not operate a burner using empty cookware or without cookware on the grate.

To Set:

1. Push in and turn knob counterclockwise to IGNITE.
All 4 surface burners will click. Only the burner with the control knob turned to IGNITE will produce a flame.
2. Turn knob to anywhere between HIGH and LOW. Use the following chart as a guide when setting heat levels.

SETTING	RECOMMENDED USE
IGNITE	■ Light the burner.
HIGH	■ Start food cooking. ■ Bring liquid to a boil.
Between HIGH and LOW	■ Hold a rapid boil. ■ Quickly brown or sear food. ■ Fry or sauté foods. ■ Cook soups, sauces and gravies. ■ Stew or steam foods.
LOW	■ Keep food warm. ■ Simmer.

REMEMBER: When range is in use or (on some models) during the Self-Cleaning cycle, the entire cooktop area may become hot.

NOTE: On some models, the cooktop will not operate when the range is in a self-cleaning mode.

To Clean:

IMPORTANT: Before cleaning, make sure all controls are off and the oven and cooktop are cool. Do not use oven cleaners, bleach or rust removers.

Power™ Burner (on some models)

The right front burner or both front burners (on some models) are designed to give ultra-high power when fully on. They can be used to rapidly bring liquid to a boil and to cook large quantities of food.

ACCUSIMMER® Burner (on some models)

The right rear burner has an adjustable heat setting for more precise simmering and low temperature cooking.

Power Failure

Ranges With Cooktop Lockout

IMPORTANT: The cooktop will automatically be locked:

- When power is first supplied to the range.
- When power is restored after a power failure.
- When “PUSH”/“OFF” is blinking on the display.

To Clear the Automatic Cooktop Lockout

1. Press OFF/CANCEL
2. Set the clock.

Ranges Without Cooktop Lockout

In case of prolonged power failure, the surface burners can be lit manually. Hold a lit match near a burner and turn knob counterclockwise to IGNITE. After burner lights, turn knob to setting.

Cooktop Lockout (on some models)



Night light/cooktop lockout keypad



Cooktop lockout icon

The Cooktop Lockout helps to avoid unintended use of the surface burners. If a control knob is turned to Ignite when the Cooktop Lockout is on, you will hear clicking and you may see the igniter sparking, but the burner will not light.

To Lock the Cooktop:

1. Turn all surface burners to the OFF position.
2. Press and hold the NIGHT LIGHT/COOKTOP LOCKOUT keypad for 3 seconds.

A single tone will sound. “Loc,” “LOCKED,” and the cooktop icon will appear in the display.

To Unlock the Cooktop:

1. Turn all surface burners to the OFF position.
2. Press and hold the NIGHT LIGHT/COOKTOP LOCKOUT keypad for 3 seconds.

A single tone will sound. “Loc OFF” will be displayed for 3 seconds. “LOCKED” and the cooktop icon will disappear from the display.

Sealed Surface Burners

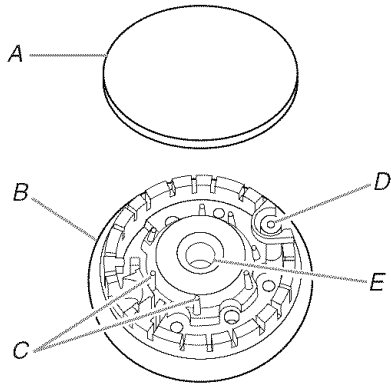

- A. Burner cap
- B. Burner base
- C. Alignment pins
- D. Igniter
- E. Gas tube opening

IMPORTANT: Do not obstruct the flow of combustion and ventilation air around the burner grate edges.

Burner cap: Always keep the burner cap in place when using a surface burner. A clean burner cap will help avoid poor ignition and uneven flames. Always clean the burner cap after a spillover and routinely remove and clean the caps according to the "General Cleaning" section.

Gas tube opening: Gas must flow freely throughout the gas tube opening for the burner to light properly. Keep this area free of soil and do not allow spills, food, cleaning agents or any other material to enter the gas tube opening. Protect it from spillovers by always using a burner cap.

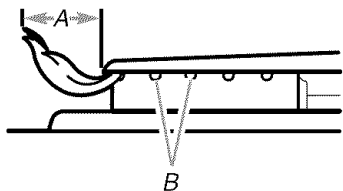

- A. 1-1½" (25-38 mm)
- B. Burner ports

Burner ports: Check burner flames occasionally for proper size and shape as shown above. A good flame is blue in color, not yellow. Keep this area free of soil and do not allow spills, food, cleaning agents or any other material to enter the burner ports.

To Clean:

IMPORTANT: Before cleaning, make sure all controls are off and the oven and cooktop are cool. Do not use oven cleaners, bleach or rust removers.

1. Remove the burner cap from the burner base and clean according to "General Cleaning" section.
2. Clean the gas tube opening with a damp cloth.

3. Clean clogged burner ports with a straight pin as shown. Do not enlarge or distort the port. Do not use a wooden toothpick. If the burner needs to be adjusted, contact a trained repair specialist.

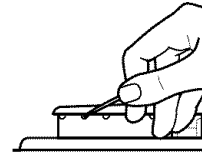

4. Replace the burner cap, making sure the alignment pins are properly aligned with the burner cap.



- A. Incorrect
- B. Correct

5. Turn on the burner. If the burner does not light, check cap alignment. If the burner still does not light, do not service the sealed burner yourself. Contact a trained repair specialist.

Home Canning

When canning for long periods, alternate the use of surface burners between batches. This allows time for the most recently used areas to cool.

- Center the canner on the grate.
- Do not place canner on 2 surface burners at the same time.
- For more information, contact your local agricultural department. Companies that manufacture home canning products can also offer assistance.

Cookware

IMPORTANT: Do not leave empty cookware on a hot surface cooking area, element or surface burner.

Ideal cookware should have a flat bottom, straight sides and a well-fitting lid, and the material should be of medium-to-heavy thickness.

Rough finishes may scratch the cooktop or grates. Aluminum and copper may be used as a core or base in cookware. However, when used as a base they can leave permanent marks on the cooktop or grates.

Cookware material is a factor in how quickly and evenly heat is transferred, which affects cooking results. A nonstick finish has the same characteristics as its base material. For example, aluminum cookware with a nonstick finish will take on the properties of aluminum.

Cookware with nonstick surfaces should not be used under the broiler.

Use the following chart as a guide for cookware material characteristics.

COOKWARE	CHARACTERISTICS
Aluminum	<ul style="list-style-type: none"> Heats quickly and evenly. Suitable for all types of cooking. Medium or heavy thickness is best for most cooking tasks.
Cast iron	<ul style="list-style-type: none"> Heats slowly and evenly. Good for browning and frying. Maintains heat for slow cooking.
Ceramic or Ceramic glass	<ul style="list-style-type: none"> Follow manufacturer's instructions. Heats slowly, but unevenly. Ideal results on low to medium heat settings.
Copper	<ul style="list-style-type: none"> Heats very quickly and evenly.
Earthenware	<ul style="list-style-type: none"> Follow manufacturer's instructions. Use on low heat settings.
Porcelain enamel-on-steel or cast iron	<ul style="list-style-type: none"> See stainless steel or cast iron.
Stainless steel	<ul style="list-style-type: none"> Heats quickly, but unevenly. A core or base of aluminum or copper on stainless steel provides even heating.

ELECTRONIC OVEN CONTROLS

Style 1 - Electronic Oven Controls (on some models)

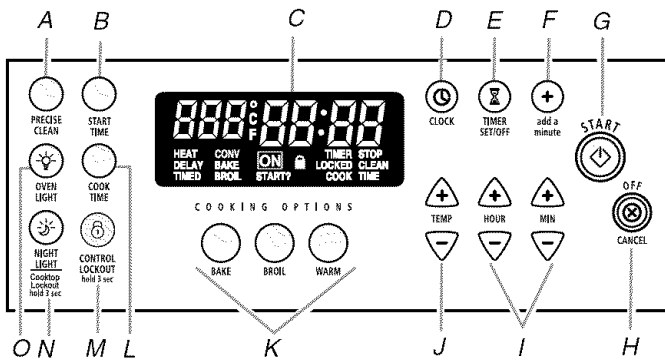

- | | |
|-------------------|--------------------------------|
| A. Precise Clean™ | I. Hour/minute |
| B. Start time | J. Temperature |
| C. Oven display | K. Cooking functions |
| D. Clock | L. Cook time |
| E. Timer set/off | M. Control lockout |
| F. Add a minute | N. Night light/cooktop lockout |
| G. Start | O. Oven light |
| H. Off/cancel | |

Style 2 - Electronic Oven Controls (on some models)

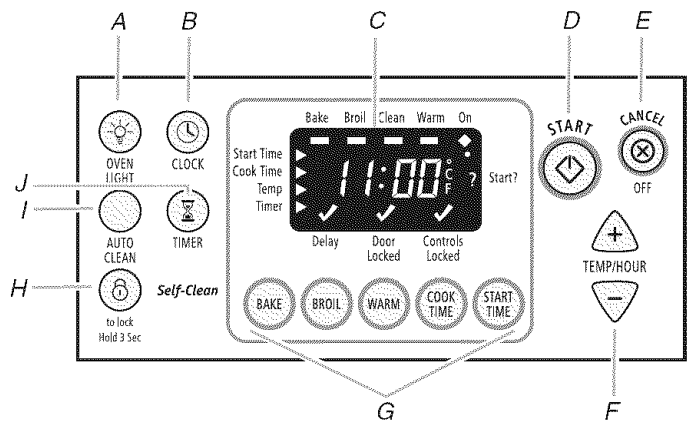

- | | |
|---------------|----------------------|
| A. Oven light | F. Temp/hour |
| B. Clock | G. Cooking functions |
| C. Display | H. Control lockout |
| D. Start | I. Auto clean |
| E. Cancel/Off | J. Timer |

Style 3 - Electronic Oven Controls (on some models)

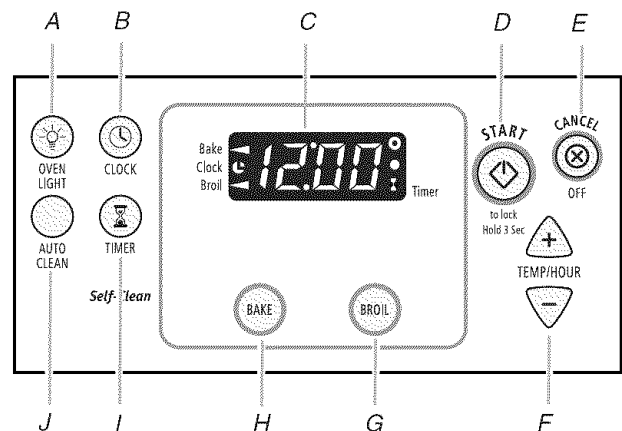

- | | |
|---------------|---------------|
| A. Oven light | F. Temp/Time |
| B. Clock | G. Broil |
| C. Display | H. Bake |
| D. Start | I. Timer |
| E. Cancel/Off | J. Auto clean |

Display

When the oven is not in use, the display shows the time of day. When performing a timed cook function, the display will show either hours and minutes, or minutes and seconds.

Style 1 - Electronic Oven Control

When power is first supplied to the range, "PUSH"/"OFF". Press OFF/CANCEL to unlock the cooktop lockout. A flashing time will then appear in the display. Press OFF/CANCEL to clear the flashing time, then set the clock.

Styles 2 and 3 - Electronic Oven Control

When power is first supplied to the appliance, a flashing time will appear on the display. Press OFF/CANCEL to clear flashing time from the display.

If flashing time appears, a power failure has occurred. Press OFF/CANCEL and reset the clock if needed.

Start

The Start pad begins any oven function and the kitchen timer. If the Start pad is not pressed within 5 seconds after pressing a function pad, the “START?” or “PUSH?” indicator light will flash as a reminder. On some models, “START?” will appear on the display.

If the Start pad is not pressed within 1 minute after pressing a function pad, the oven display will return to the time of day mode and the programmed function will be canceled.

Off/Cancel

The Off/Cancel pad stops any function except the Clock, Timer and Control Lock.

Clock

On some models, this is a 12-hour clock that shows a.m. and p.m.

To Set:

Before setting, make sure the oven and Timer are off.

1. Press CLOCK.
2. Depending on your model, press the HR or MIN or TEMP/HOUR “up” or “down” arrow pads to set the time of day, including a.m. or p.m.
3. Press CLOCK or START.

The clock display can be turned off/on (on some models) by pushing and holding the Clock keypad for 5 seconds.

Range Lights



Oven light



Night light

Oven Light

While the oven door is closed, press OVEN LIGHT keypad to turn the light on or off. The oven light will come on when the oven door is opened. The oven light will not come on during the self-clean cycle.

Night Light (on some models)

Press the NIGHT LIGHT/COOKTOP LOCKOUT keypad to turn the night light on and off.

Tones

Tones are audible signals, indicating the following:

One tone

- Valid pad press
- Oven is preheated (long tone)
- Function has been entered
- Reminder, repeating each minute after the end-of-cycle tones

Three tones

- Invalid pad press

Four tones

- End of cycle
-

Style 1 - Electronic Oven Control

Reminder Tones: The audible tones at the end of a cook time or timer may be set to beep once (Off) or continue to beep once per minute (rEP On). Press and hold the TIMER SET/OFF keypad for 5 seconds to turn tones on or off. “Off” or “rEP On” will flash in the display.

Sound: All audible tones can be turned off. Press and hold the COOK TIME keypad for 5 seconds to turn tones on or off. “Off” or “Snd On” will flash in the display.

Volume: The tone volume can be set to “Lo” or “Hi.” Press and hold the START TIME keypad for 5 seconds to set the volume to high or low. “Lo” or “Snd HI” will flash in the display.

Styles 2 & 3 - Electronic Oven Control

Reminder Tones: The audible tones at the end time may be set to beep once or continue to beep. Press and hold the TIMER keypad for 5 seconds to enter the Options mode. “Opt” will be displayed. Cycle through the options (“12hr” or “hr”), (“LOn” or “LOff”), to (“b” or “b1”) using the TEMP/HOUR keys. Choose on or off using the TIMER keypad. Press CANCEL to exit mode.

Fahrenheit and Celsius

The temperature is preset at Fahrenheit, but can be changed to Celsius on some models.

To Change: Press and hold BROIL for 5 seconds. A tone will sound, and “°C” will appear on the display. Repeat to change back to Fahrenheit. To exit mode, press OFF/CANCEL.

Timer

The Timer can be set in hours or minutes up to 12 hours and 59 minutes, and counts down the set time. The Timer does not start or stop the oven.

To Set:

1. Press TIMER SET/OFF or TIMER. The timer indicator light will light up on some models. If no action is taken after 1 minute, the display will return to the time of day mode.
2. Depending on your model, press the HR or MIN or TEMP/HOUR “up” or “down” arrow pads to set the length of time to cook.
3. Press START or TIMER SET. When the set time ends, end-of-cycle tones will sound, then, if enabled, reminder tones will sound every minute on some models.
4. Press TIMER SET/OFF or TIMER twice anytime to cancel the Timer and reminder tones.

Remember, do not press the Off/Cancel pad because the oven will turn off.

To display the time of day for 5 seconds when the timer is counting down, press CLOCK.

Control Lockout

Control Lockout shuts down the control panel keypads to avoid unintended use of the oven. When the control is locked, only the CLOCK, OVEN LIGHT and TIMER keypads will function.

Style 1 - Electronic Oven Control



Control lockout



Control lockout icon

To Lock Controls:

1. Check that the oven is off and no delayed timed cooking is programmed.
2. Press and hold CONTROL LOCKOUT for 3 seconds.
A single tone will sound. "Loc," "LOCKED," and the control lockout icon will be displayed.

To Unlock Controls:

1. Press and hold CONTROL LOCKOUT for 3 seconds.
A single tone will sound. "Loc," "LOCKED," and the control lockout icon will disappear from the display.

Style 2 - Electronic Oven Control



Control lockout



Control lockout icon

To Lock Controls:

1. Check that the oven is off and no delayed timed cooking is programmed.
2. Press and hold CONTROL LOCKOUT for 3 seconds.
A single tone will sound. "Loc" and the control lockout icon will be displayed.

To Unlock Controls:

1. Press and hold CONTROL LOCKOUT for 3 seconds.
A single tone will sound. "Loc" and the control lockout icon will disappear from the display.

Style 3 - Electronic Oven Control

Control Lockout is not available on Style 3 oven controls.

Add 1 Minute (on some models)

Time may be added to the kitchen Timer in 1-minute increments, up to 12 hours and 59 minutes, by touching the ADD 1 MIN pad. Touching ADD 1 MIN will add 1 minute of time to the kitchen Timer only.

Oven Temperature Control

IMPORTANT: Do not use a thermometer to measure oven temperature because opening the oven door may cause burner cycling to give incorrect readings.

The oven provides accurate temperatures; however, it may cook faster or slower than your previous oven, so the temperature calibration can be adjusted. It can be changed in Fahrenheit or Celsius.

A minus sign means the oven will be cooler by the displayed amount. The absence of a minus sign means the oven will be warmer by the displayed amount. Use the following chart as a guide.

ADJUSTMENT °F (ADJUSTMENT °C)

COOKS FOOD

10°F (5°C)	...a little more
20°F (10°C)	...moderately more
30°F (15°C)	...much more
-10°F (-5°C)	...a little less
-20°F (-10°C)	...moderately less
-30°F (-15°C)	...much less

To Adjust Oven Temperature Calibration:

1. Press and hold BAKE for 5 seconds until the oven display shows the current calibration, for example "0°F CAL" or "00."
2. Press the TEMP or TEMP/HOUR "up" or "down" arrow pad(s) to increase or to decrease the temperature in 10°F (5°C) amounts. The adjustment can be set between 30°F (15°C) and -30°F (-15°C).
3. Press START.

OVEN USE

Odors and smoke are normal when the oven is used the first few times, or when it is heavily soiled.

IMPORTANT: The health of some birds is extremely sensitive to the fumes given off. Exposure to the fumes may result in death to certain birds. Always move birds to another closed and well-ventilated room.

Aluminum Foil

IMPORTANT: To avoid permanent damage to the oven bottom finish, do not line the oven bottom with any type of foil, liners or cookware.

- On those models with bottom vents, do not block or cover the oven bottom vents.
- Do not cover entire rack with foil because air must be able to move freely for best cooking results.
- To catch spills, place foil on rack below dish. Make sure foil is at least ½" (1.3 cm) larger than the dish and that it is turned up at the edges.

Positioning Racks and Bakeware

IMPORTANT: To avoid permanent damage to the porcelain finish, do not place food or bakeware directly on the oven door or bottom.

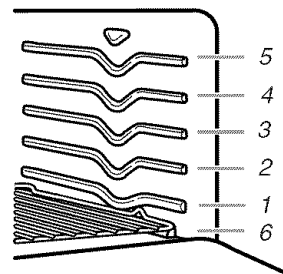

RACKS

- Position racks before turning on the oven.
- Do not move racks with bakeware on them.
- Make sure racks are level.

To move a rack, pull it out to the stop position, raise the front edge, then lift out. Use the following illustration and chart as a guide.

FOOD	RACK POSITION
Frozen pies, large roasts, turkeys, angel food cakes	1 or 2
Bundt cakes, most quick breads, yeast breads, casseroles, meats	2
Cookies, biscuits, muffins, cakes, nonfrozen pies	2 or 3
Extra-large items	6

BAKEWARE

To cook food evenly, hot air must be able to circulate. Allow 2" (5 cm) of space around bakeware and oven walls. Use the following chart as a guide.

NUMBER OF PAN(S)	POSITION ON RACK
1	Center of rack.
2	Side by side or slightly staggered.
3 or 4	Opposite corners on each rack. Make sure that no bakeware piece is directly over another.

Split Oven Rack (on some models)

Split-Rack with Removable Insert

The split-rack with removable insert is a space maximizer. When the two are attached, they make a full rack. The insert can also be removed to provide room for large items such as a turkey and casseroles. Do not place more than 25 lbs (11.3 kg) on the split-rack.

The insert can also be used on the counter for a cooling rack.

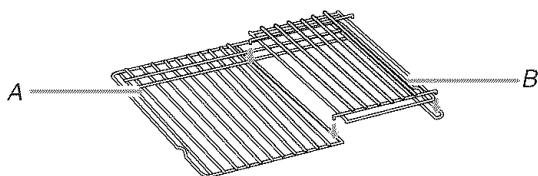

A. Split-rack
B. Removable insert

If you would like to purchase a split-oven rack, one may be ordered. See "Assistance or Service" section to order. Ask for Part Number 4396927.

To Use Racks:

1. Place a full rack on position 1 or 2, and the split-rack on position 3 or 4.
2. Place large items on the right side of the full rack.
3. Place deeper, covered dishes on the left side of the full rack.
4. Place shallow dishes on the split-rack.

5. When finished cooking, slowly remove items.

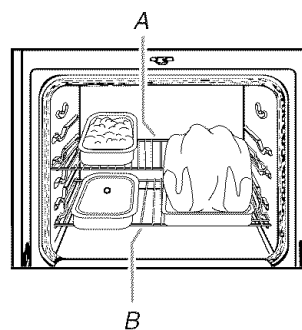

A. Rear rack section
B. Front rack section

Bakeware

The bakeware material affects cooking results. Follow manufacturer's recommendations and use the bakeware size recommended in the recipe. Use the following chart as a guide.

BAKEWARE/ RESULTS	RECOMMENDATIONS
Light colored aluminum	<ul style="list-style-type: none"> ■ Use temperature and time recommended in recipe. ■ Light golden crusts ■ Even browning
Dark aluminum and other bakeware with dark, dull and/or nonstick finish	<ul style="list-style-type: none"> ■ May need to reduce baking temperatures 25°F (15°C). ■ Use suggested baking time. ■ For pies, breads and casseroles, use temperature recommended in recipe. ■ Place rack in center of oven.
Insulated cookie sheets or baking pans	<ul style="list-style-type: none"> ■ Place in the bottom third of oven. ■ May need to increase baking time. ■ Little or no bottom browning
Stainless steel	<ul style="list-style-type: none"> ■ May need to increase baking time. ■ Light, golden crusts ■ Uneven browning
Stoneware/Baking stone	<ul style="list-style-type: none"> ■ Follow manufacturer's instructions. ■ Crisp crusts
Ovenproof glassware, ceramic glass or ceramic	<ul style="list-style-type: none"> ■ May need to reduce baking temperatures 25°F (15°C). ■ Brown, crisp crusts

Meat Thermometer

On models without a temperature probe, use a meat thermometer to determine doneness of meat, poultry and fish. The internal temperature, not appearance, should be used to determine doneness. A meat thermometer is not supplied with this appliance.

- Insert the thermometer into the center of the thickest portion of the meat or inner thigh or breast of poultry. The tip of the thermometer should not touch fat, bone or gristle.
 - After reading the thermometer once, push it into the meat $\frac{1}{2}$ " (1.3 cm) more and read again. If the temperature drops, cook the meat or poultry longer.
 - Check all meat, poultry and fish in 2 or 3 different places.
-

Oven Vent

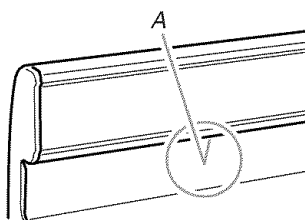

A. Oven vent

The oven vent releases hot air and moisture from the oven, and should not be blocked or covered. Blocking or covering the oven vent will cause poor air circulation, affecting cooking and cleaning results. Do not set plastics, paper or other items that could melt or burn near the oven vent.

Baking and Roasting

ACCUBAKE® Temperature Management (on some models)

The ACCUBAKE® system electronically regulates the oven heat levels during preheat and bake to maintain a precise temperature range for optimal cooking results. The bake and broil burners cycle on and off in intervals. This feature is automatically activated when the oven is in use.

Before baking and roasting, position racks according to the "Positioning Racks and Bakeware" section. When roasting, it is not necessary to wait for the oven preheat conditioning time to end before putting food in unless recommended in the recipe.

To Bake or Roast:

1. Press BAKE.
2. Press TEMP or TEMP/HOUR "up" or "down" arrow pad to set a temperature other than 350°F (175°C) in 5°F (3°C) amounts. The bake range can be set between 170°F and 500°F (75°C and 260°C).

When the oven temperature is greater than 170°F (77°C), no preheat conditioning time will be shown in the display. The preheat conditioning time will not change if the temperature is reset before the countdown time ends.

3. Press START. The temperature can be changed after this step. The start pad does not need to be pressed again.

If baking and roasting while the minute timer is counting down, the set temperature can be seen for 5 seconds by pressing BAKE.

4. Press OFF/CANCEL when finished.

Preheating

After the start pad is pressed, the oven will enter a timed preheat conditioning. "PrE" (on some models) and the countdown time will appear on the display. When the preheat conditioning time ends, a tone will sound and the selected temperature will appear on the display.

Preheat temperatures are affected by varying factors such as room temperature and peak energy usage times. It is normal for the temperature showing on the display and the actual oven temperature to differ due to the cycling of the burners.

Waiting an additional 10 minutes, after the preheat conditioning time ends, to put food in the oven is suggested when baking foods with leavening ingredients, such as yeast, baking powder, baking soda and eggs.

Broiling

Broiling uses direct radiant heat to cook food. Changing the temperature when Custom Broiling allows more precise control when cooking. The lower the temperature, the slower the cooking. Thicker cuts and unevenly shaped pieces of meat, fish and poultry may cook better at lower broiling temperatures.

- For best results, use a broiler pan and grid (provided on some models). They are designed to drain juices and help avoid spatter and smoke.

If you would like to purchase a broiler pan, one may be ordered. See "Assistance or Service" section to order. Ask for Part Number 4396923.

- For proper draining, do not cover the grid with foil. The bottom of the pan may be lined with aluminum foil for easier cleaning.
- Trim excess fat to reduce spattering. Slit the remaining fat on the edges to avoid curling.
- Pull out oven rack to stop position before turning or removing food. Use tongs to turn food to avoid the loss of juices. Very thin cuts of fish, poultry or meat may not need to be turned.
- After broiling, remove the pan from the oven when removing the food. Drippings will bake on the pan if left in the heated oven, making cleaning more difficult.

Before broiling, position rack according to the Broiling Chart. It is not necessary to preheat the oven before putting food in unless recommended in the recipe. Position food on grid in the broiler pan, then place it in the center of the oven rack. Close the door.

To Broil:

1. Press BROIL.
2. Press START.
3. Press OFF/CANCEL when finished.

To Custom Broil:

1. Press BROIL.
2. Press TEMP or TEMP/HOUR "up" or "down" arrow pad to change the temperature in 5°F (5°C) amounts. The broil range can be set between 300°F (150°C) and HI (525°F [275°C]).
3. Press START.
4. Press OFF/CANCEL when finished.

BROILING CHART

For best results, place food 3" (7 cm) or more from the broil burner. Times are guidelines only and may need to be adjusted for individual tastes. Recommended rack positions are numbered from the bottom (1) to the top (5). For diagram, see the "Positioning Racks and Bakeware" section.

FOOD	RACK POSITION	Approximate Time (minutes)	
		SIDE 1	SIDE 2
Steak 1" (2.5 cm) thick			
medium rare	4	14-15	7-8
medium	4	15-16	8-9
well-done	4	18-19	9-10
Ground meat patties* ¾" (2 cm) thick			
well-done	4	13-14	6-7
Pork chops 1" (2.5 cm) thick	4	21-22	10-11
Ham slice, precooked ½" (1.25 cm) thick	4	8-10	4-5
Frankfurters	4	6-7	3-4
Lamb chops 1" (2.5 cm) thick	4	15-17	8-9
Chicken bone-in pieces	3	18-20	18-20
boneless breasts	4	12-16	11-16
Fish Fillets ¼-½" (0.6-1.25 cm) thick	4	8-10	4-5
Fish Steaks ¾-1" (2-2.5 cm) thick	4	15-18	7-9

*Place up to 9 patties, equally spaced, on broiler grid.

Hold Warm Feature (on some models)

⚠ WARNING

Food Poisoning Hazard

Do not let food sit in oven more than one hour before or after cooking.

Doing so can result in food poisoning or sickness.

IMPORTANT: Food must be at serving temperature before placing it in the warmed oven. Food may be held up to 1 hour; however, breads and casseroles may become too dry if left in the oven during Hold Warm.

The Hold Warm feature allows hot cooked foods to stay at serving temperature. It can also be used at the end of a timed cook.

Style 1 - Electronic Oven Control

To Use:

1. Press WARM.
2. Set the temperature (optional).
Press the TEMP "up" or "down" arrow pad to raise or lower the temperature in 5°F (5°C) amounts to set a temperature other than 170°F (75°C). The warm range is 170°F-200°F (75°C-93°C).
3. Press START.
4. Press OFF/CANCEL when finished.

To Add to the End of a Set Cook Time:

1. Press BAKE.
2. Set the temperature (optional).
Press the TEMP "up" or "down" arrow pad to set a temperature other than 350°F (177°C).
3. Press COOK TIME.
4. Press the HOUR/MIN "up" or "down" arrow pads to set cook time.
5. Press WARM.
A 1 hour warm time will automatically be set.
6. Set the warm temperature (optional).
Press the TEMP "up" or "down" arrow pad to raise or lower the temperature in 5°F (5°C) amounts to set a temperature other than 170°F (75°C). The warm range is 170°F-200°F (75°C-93°C).
7. Press START.
The display will show the cook time counting down. When cook time ends, the display will show a warming time.
When warming time ends, the oven will automatically shut off and "End" and COOK TIME will show on the display. Four tones will sound, and then four 1-second reminder tones will sound every minute thereafter.
8. Press OFF/CANCEL or open the oven door to stop reminder tones and remove "End" from display. The time of day will return to the display.

Style 2 - Electronic Oven Control

To Use:

1. Press WARM.
2. Temperature is set at 170° (75°C) for 60 minutes.
3. Press START.
4. Press OFF/CANCEL when finished.

⚠ WARNING

Food Poisoning Hazard

Do not let food sit in oven more than one hour before or after cooking.

Doing so can result in food poisoning or sickness.

Timed Cooking allows the oven to be set to turn on at a certain time of day, cook for a set length of time, and/or shut off automatically. Delay start should not be used for food such as breads and cakes because they may not bake properly.

Style 1 - Series Electronic Controls (see “Electronic Oven Controls” section)

To Set a Timed Cook:

1. Press BAKE (optional).
2. Press the TEMP “up” or “down” arrow pads to enter a temperature other than the one displayed.
3. Press COOK TIME.
4. Press the HOUR and MIN “up” or “down” arrow pads to enter the desired cooking time.
5. Press START. The display will count down the time.
When the time ends, the oven will shut off automatically and “End” will appear on the display. End-of-cycle tones will sound, then, if enabled, reminder tones will sound every minute.
6. Open and close the oven door to clear the display and/or stop reminder tones.

To Set a Delayed Timed Cook:

Before setting, make sure the clock is set to the correct time of day. See “Clock” section.

1. Press BAKE (optional).
2. Press the TEMP “up” or “down” arrow pads to enter a temperature other than the one displayed.
3. Press START TIME.
4. Press the HOUR and MIN “up” or “down” arrow pads to enter the desired start time.
5. Press COOK TIME.
6. Press the HOUR and MIN “up” or “down” arrow pads to enter the desired cooking time.
7. Press START. “DELAY,” “TIMED,” “BAKE,” and “ON” will appear on the display.

When the start time is reached, the oven will automatically turn on. The oven will automatically turn off after the programmed cook time. “End” will appear on the display, End-of-cycle tones will sound, and if enabled, reminder tones will sound every minute.

8. Open and close the oven door to clear the display and/or stop reminder tones.

Styles 2 & 3 - Series Electronic Oven Control (see “Electronic Oven Controls” section)

To Set a Timed Cook:

1. Press BAKE. The bake indicator light will light up.
2. Set the temperature (optional).
3. Press the TEMP/HOUR “up” or “down” arrow pads to enter a temperature other than the one displayed.
4. Press COOK TIME. The cook time oven indicator light will light up.
5. Press TEMP/HOUR “up” or “down” arrow pads to enter the desired cooking time.
6. Press START/ENTER. The display will count down the time. When the time ends, the oven will shut off automatically and “End” will appear on the display.
7. Press OFF/CANCEL or open the oven door to clear the display.

To Set a Delayed Timed Cook:

Before setting, make sure the clock is set to the correct time of day. See “Clock” section.

1. Press BAKE. The bake indicator will light up.
2. Set the temperature (optional).
3. Press the TEMP/HOUR “up” or “down” arrow pads to enter a temperature other than the one displayed.
4. Press COOK TIME. The cook time oven indicator light will light up.
5. Press the TEMP/HOUR “up” or “down” arrow pads to enter the desired cooking time.
6. Press START TIME. The start time/delay oven indicator light will light up.
7. Press the TEMP/HOUR “up” or “down” arrow pads to enter the time of day to start.
8. Press START/ENTER.

When the start time is reached, the oven will automatically turn on. The temperature and/or time settings can be changed anytime after pressing START/ENTER by repeating steps 1-7. When the set cook time ends, the oven will shut off automatically and “End” will appear on the display.

9. Press OFF/CANCEL or open the oven door to clear the display.

Warming Drawer (on some models)

⚠ **WARNING**

Food Poisoning Hazard

Do not let food sit for more than one hour before or after cooking.

Doing so can result in food poisoning or sickness.

The Warming Drawer is ideal for keeping hot cooked foods at serving temperature. It may also be used for warming breads and pastries.

Different types of food may be placed in the warming drawer at the same time. For best results, do not hold foods longer than 1 hour. For smaller quantities or heat-sensitive foods, such as eggs, do not hold longer than 30 minutes.

Food must be at serving temperature before being placed in the warming drawer. Breads, pastries, and fruit pies may be heated from room temperature on the HI setting.

Remove food from plastic bags and place in oven-safe container. Cover foods with a lid or aluminum foil.

Do not cover with plastic wrap.

Empty serving dishes and ovenproof dishes can be heated while the warming drawer is preheating.

Before using the warming drawer, wash the tray that lines the bottom of the drawer with soap and water. See “General Cleaning” section.

The warming drawer comes with a liner that helps keep the drawer clean.

Do not place food to be warmed directly on warming drawer liner.

To Use:

1. Place cooked food(s) in warming drawer.
2. Push in and turn rotary control to desired temperature (between 140°F [60°C] and 185°F [85°C]).
3. Turn rotary control to off when finished.

Warming Drawer Settings:

The warming drawer is preset for a “Lo” temperature, but can be changed by pressing the TEMP “up” arrow pad. Use the following chart as a guide when selecting a different temperature other than “Lo.”

SETTINGS	TEMPERATURES
“dr Lo” (Low) keeps soft rolls warm	100°F (38°C)
“dr 2” (Medium Low)	140°F (60°C)
“dr 3” (Medium)	160°F (71°C)
“dr 4” (Medium High)	180°F (82°C)
“dr HI” (High) keeps french fries crisp and warm	195°F (91°C)

Warming Drawer Temperature Chart

Different foods require different settings in order to maintain the ideal serving temperature. Use the following chart as a guide.

FOOD	SETTING
Appetizers	dr HI
Biscuits	dr LO
Chicken	
Boneless, Breaded	dr HI
Nuggets	dr HI
Coffee Cake	dr LO
Dinner Plate (1)	
Salisbury Steak, Mashed Potatoes, Corn	dr HI
Fish Pieces	
Breaded	dr HI
Battered	dr HI
French Fries	dr HI
Gravy	dr 4
Ham, Boneless	dr 3
Hard Rolls	dr LO
Lasagna	dr 4
Pastries	
Prepackaged, baked	dr 4
Prepackaged, frozen	dr LO
Pie	
Single Crust	dr LO
Double Crust	dr LO
Pizza	dr 4
Potatoes, Baked	dr 4
Quiche	dr 3
Roast, Boneless	dr 4
Roasted Chicken	dr 4
Soft Rolls	dr LO

RANGE CARE

Self-Cleaning Cycle (on some models)

⚠ WARNING



Burn Hazard

Do not touch the oven during the Self-Cleaning cycle.

Keep children away from oven during Self-Cleaning cycle.

Failure to follow these instructions can result in burns.

IMPORTANT: The health of some birds is extremely sensitive to the fumes given off during the Self-Cleaning cycle. Exposure to the fumes may result in death to certain birds. Always move birds to another closed and well-ventilated room.

Self-clean the oven before it becomes heavily soiled. Heavy soil results in longer cleaning and more smoke.

Keep the kitchen well-ventilated during the Self-Cleaning cycle to help get rid of heat, odors, and smoke.

Do not block the oven vent(s) during the Self-Cleaning cycle. Air must be able to move freely. Depending on your model, see "Oven Vent" or "Oven Vents" section.

Do not clean, rub, damage or move the oven door gasket. The door gasket is essential for a good seal.

Prepare Oven:

- Remove the broiler pan, grid, cookware and bakeware and, on some models, the temperature probe from the oven.
- Remove any foil from the oven because it may burn or melt, damaging the oven.
- Remove oven racks to keep them shiny and easy to slide. See "General Cleaning" section for more information.
- Hand clean inside door edge and the 1½" (3.8 cm) area around the inside oven cavity frame, being certain not to move or bend the gasket. This area does not get hot enough during self-cleaning to remove soil. Do not let water, cleaner, etc. enter slots on door frame. Use a damp cloth to clean this area.
- Wipe out any loose soil to reduce smoke and avoid damage. At high temperatures, foods react with porcelain. Staining, etching, pitting or faint white spots can result. This will not affect cooking performance.

How the Cycle Works

IMPORTANT: The heating and cooling of porcelain on steel in the oven may result in discoloring, loss of gloss, hairline cracks and popping sounds.

Before self-cleaning, check that the door is completely closed or the door will not lock and the self-clean cycle will not begin.

Do not wipe down any inside surfaces until the oven has completely cooled down. Applying a cool damp cloth to the inner door glass before it has cooled completely could result in the glass breaking.

To stop the self-clean cycle at any time, press the OFF/CANCEL keypad. If the temperature is too high, the oven door will remain locked and "cool" and "locked" will be displayed.

The oven light will not work during the self-cleaning cycle.

Style 1 - Electronic Oven Control

The PRECISE CLEAN™ function self-cleaning cycle is a "one touch" step that uses very high temperatures and dissolves soil to a powdery ash. PRECISE CLEAN™ function setting will automatically determine the length of cleaning time needed based on the number of times the oven has been used since the last self-cleaning cycle. Maximum clean time is 4 hours 30 minutes, and the minimum is 2 hours 30 minutes.

The oven will automatically shut off once it is clean. The door will not unlock until the oven cools.

The cooktop burners will not function during the self-cleaning cycle.

Self-clean can only be run once in a 12-hour time period. If a self-clean cycle is canceled after the oven has reached temperature, you will have to wait 12 hours to restart.

To Self-Clean Using PRECISE CLEAN™ Function

1. Press PRECISE CLEAN™ function.
2. Press START.
The oven door will automatically lock. "CLn," "LOCKED," "ON," "CLEAN," the Cooktop Lockout icon, and the time remaining will be displayed.
3. When the self-clean cycle is complete "END" will be displayed, and "PUSH"/"OFF" will blink alternately.
4. Press OFF/CANCEL.
"LOCKED," "END," and the Cooktop Lockout icon will disappear from the display. "PUSH"/"OFF" will stop blinking, and clock will show the time of day.
5. Once the oven is completely cooled, remove ash with a damp cloth.

To Delay Start Self-Clean Using PRECISE CLEAN™ Function

1. Press PRECISE CLEAN™ function.
2. Press START TIME.
3. Press the HOUR/MIN "up" and "down" arrow pads to set the desired start time.
4. Press START.
The oven door will automatically lock. "DELAY," "LOCKED," "CLEAN," "ON" and the Cooktop Lockout icon will be displayed.
5. When the self-clean cycle is complete "END" will be displayed and "PUSH"/"OFF" will blink alternately.
6. Press OFF/CANCEL.
"LOCKED," "END," and the Cooktop Lockout icon will disappear from the display. "PUSH"/"OFF" will stop blinking, and clock will show the time of day.
7. Once the oven is completely cooled, remove ash with a damp cloth.

Style 2 - Electric Oven Control

The AUTO-CLEAN cycle time is adjustable, from 2 hours 30 minutes and 4 hours 30 minutes in 15-minute increments. Suggested clean times are 2 hours 30 minutes for light soil and 4 hours 30 minutes for heavy soil. The last 30 minutes of the cycle is for cool down.

To Self-Clean Using AUTO-CLEAN

1. Press AUTO-CLEAN.
2. Press the TEMP/HOUR “up” or “down” arrow pad to set the desired self-clean cycle time.
3. Press START.
The oven door will automatically lock. The “DOOR LOCKED” and “CLEAN” indicator lights will be displayed. The time remaining will also be displayed.
4. When the self-clean cycle is complete and the oven cools, the “DOOR LOCKED” and “CLEAN” indicator lights will turn off.
5. Once the oven is completely cooled, remove ash with a damp cloth.

To Delay Start Self-Clean Using AUTO-CLEAN

1. Press AUTO-CLEAN.
2. Press the TEMP/HOUR “up” and “down” arrow pads to set the desired self-clean cycle time.
3. Press START TIME.
4. Press the TEMP/HOUR “up” and “down” arrow pads to set the desired start time.

5. Press START.
The oven door will automatically lock. “DOOR LOCKED” and “CLEAN” indicator lights will be displayed.
6. When the self-clean cycle is complete and the oven cools, the “DOOR LOCKED” and “CLEAN” indicator lights will turn off.
7. Once the oven is completely cooled, remove ash with a damp cloth.

Style 3 - Electric Oven Control

The AUTO-CLEAN cycle can be set at one of two levels, HI clean time (4 hours 30 minutes) or LO clean time (3 hours 30 minutes). Suggested clean times are 3 hours 30 minutes for light soil and 4 hours 30 minutes for heavy soil. The last 30 minutes of the cycle is for cool down.

To Self-Clean

1. Press AUTO-CLEAN to set the clean time to HI (4 hours 30 minutes).
2. Press the TEMP/HOUR “down” arrow keypad to choose between LO and HI clean time.
3. Press START.
4. The oven door will automatically lock. The “CLEAN” indicator light will be displayed. The time remaining will also be displayed.
5. When the self-clean cycle is complete and oven cools, the “CLEAN” indicator light will turn off.
6. Once the oven is completely cooled, remove ash with a damp cloth.

Delay start self-clean cycle is not available with Style 3 models.

General Cleaning

IMPORTANT: Before cleaning, make sure all controls are off and the oven and cooktop are cool. Always follow label instructions on cleaning products. Do not wipe down any of the inside surfaces until the oven has completely cooled down. Applying a cool damp cloth to the inner door glass before it has cooled completely could result in the glass breaking.

Soap, water and a soft cloth or sponge are suggested first unless otherwise noted.

EXTERIOR PORCELAIN ENAMEL SURFACES (on some models)

Food spills containing acids, such as vinegar and tomato, should be cleaned as soon as the entire appliance is cool. These spills may affect the finish.

Cleaning Method:

- Glass cleaner, mild liquid cleaner or nonabrasive scrubbing pad:
Gently clean around the model and serial number plate because scrubbing may remove numbers.
- All-Purpose Appliance Cleaner Part Number 31662 (not included):
See “Assistance or Service” section to order.

STAINLESS STEEL (on some models)

To avoid damage to stainless steel surfaces, do not use soap-filled scouring pads, abrasive cleaners, Cooktop Polishing Creme, steel-wool pads, gritty washcloths or some paper towels. Rub in direction of grain to avoid damaging.

Cleaning Method:

- Stainless Steel Cleaner & Polish Part Number 31462 (not included):
See “Assistance or Service” section to order.
- Liquid detergent or all-purpose cleaner:
Rinse with clean water and dry with soft, lint-free cloth.
- Vinegar for hard water spots.

METALLIC PAINT (on some models)

Do not use abrasive cleaners, cleaners with bleach, rust removers, ammonia or sodium hydroxide (lye) because paint surface may stain.

COOKTOP CONTROLS

Do not use steel wool, abrasive cleansers or oven cleaner. Do not soak knobs. When replacing knobs, make sure knobs are in the Off position.

On some models, do not remove seals under knobs.

Cleaning Method:

- Soap and water or dishwasher:
Pull knobs straight away from control panel to remove.

CONTROL PANEL

Do not use abrasive cleaners, steel-wool pads, gritty washcloths or some paper towels. Damage may occur.

Cleaning Method:

- Glass cleaner and soft cloth or sponge:
Apply glass cleaner to soft cloth or sponge, not directly on panel.
- All-Purpose Appliance Cleaner Part Number 31662 (not included):
See "Assistance or Service" section to order.

PORCELAIN-COATED GRATES AND CAPS

Food spills containing acids, such as vinegar and tomato, should be cleaned as soon as the cooktop, grates and caps are cool. These spills may affect the finish.

To avoid chipping, do not bang grates and caps against each other or hard surfaces such as cast iron cookware.

Do not reassemble caps on burners while wet.

Do not clean in the Self-Cleaning cycle.

Cleaning Method:

- Nonabrasive plastic scrubbing pad and mildly abrasive cleanser:
Clean as soon as cooktop, grates and caps are cool.
- Dishwasher (grates only, not caps):
Use the most aggressive cycle. Cooked-on soils should be soaked or scrubbed before going into a dishwasher.
- Gas Grate and Drip Pan Cleaner Part Number 31617:
See "Assistance or Service" section to order.

SURFACE BURNERS

See "Sealed Surface Burners" section.

OVEN DOOR EXTERIOR

Cleaning Method:

- Glass cleaner and a soft cloth or sponge:
Apply glass cleaner to soft cloth or sponge, not directly on panel.
- All-Purpose Appliance Cleaner Part Number 31662 (not included):
See "Assistance or Service" section to order.

OVEN CAVITY

Do not use oven cleaners.

Food spills should be cleaned when oven cools. At high temperatures, foods react with porcelain and staining, etching, pitting or faint white spots can result.

Cleaning Method:

- Self-Cleaning cycle: See "Self-Cleaning Cycle" first.

OVEN RACKS AND ROASTING RACKS

Cleaning Method:

- Self-Cleaning cycle:
See "Self-Cleaning Cycle" first. Remove racks or they will discolor and become harder to slide. If this happens, a light coating of vegetable oil applied to the rack guides will help them slide.
- Steel-wool pad

BROILER PAN AND GRID (on some models)

Do not clean in the Self-Cleaning cycle.

Cleaning Method:

- Mildly abrasive cleanser:
Scrub with wet scouring pad.
- Solution of ½ cup (125 mL) ammonia to 1 gal. (3.75 L) water:
Soak for 20 minutes, then scrub with scouring or steel-wool pad.
- Oven cleaner:
Follow product label instructions.

Porcelain enamel only, not chrome

- Dishwasher

STORAGE DRAWER (on some models)

Make sure drawer is cool and empty before cleaning.

For more information, see "Storage Drawer" section.

Cleaning Method:

- Mild detergent

Drawer Liner (on some models)

Remove all stored items from drawer and lift out drawer liner.

- Clean with mild detergent.
- All-Purpose Appliance Cleaner Part Number 31662 (not included):
See "Assistance or Service" section to order.

WARMING DRAWER and TRAY (on some models)

Make sure drawer is cool and remove tray.

Cleaning Method:

- Mild detergent (for both)
- All-Purpose Appliance Cleaner Part Number 31662 (not included):
See "Assistance or Service" section to order.

Oven Light

The oven light is a standard 40-watt appliance bulb. Before replacing, make sure the oven and cooktop are cool and the control knobs are in the off position.

To Replace:

1. Unplug range or disconnect power.
2. Turn the glass bulb cover in the back of the oven counterclockwise to remove.

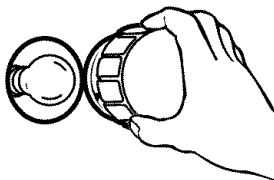

3. Turn bulb counterclockwise to remove from socket.
 4. Replace bulb, then bulb cover by turning clockwise.
 5. Plug in range or reconnect power.
-

Oven Door

For normal range use, it is not suggested to remove the oven door. However, if removal is necessary, make sure the oven is off and cool. Then, follow these instructions. The oven door is heavy.

To Remove:

1. Open oven door all the way.
2. Flip up the hinge latch on each side.

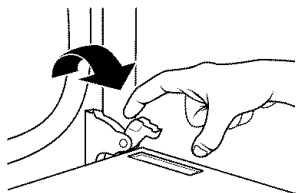

3. Close the oven door as far as it will shut.
4. Lift the oven door while holding both sides. Continue to push the oven door closed and pull it away from the oven door frame.

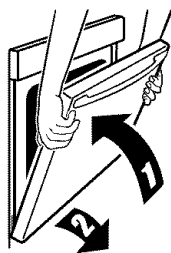

To Replace:

1. Insert both hanger arms into the door.



2. Open the oven door. You should hear a “click” as the door is set into place.
 3. Move the hinge levers back to the locked position. Check that the door is free to open and close. If it is not, repeat the removal and installation procedures.
-

Storage Drawer

The storage drawer can be removed. Before removing, make sure drawer is cool and empty.

To Remove:

1. Pull the storage drawer straight back past the drawer stop notch and the end of the side rails.

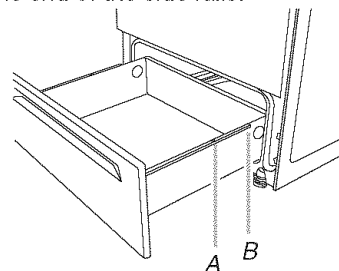

A. Drawer stop notch
B. End of side rail

2. Lift up the back of the drawer and pull the drawer out.

To Replace:

1. Lift up the back of the drawer and place it inside the range in its fully forward position.
2. Lift up the front of the drawer to a level position.
3. Slowly push the drawer into the range until the drawer side rails engage with the gap in the drawer glides.

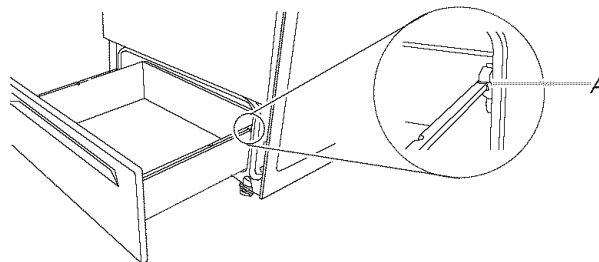

A. Engage drawer glide.

4. Once the drawer is fully engaged on both sides, slide the drawer back into the closed position.

NOTE: When you are removing and replacing the storage drawer, a slight push may be needed to move the drawer stop notch past the drawer glides.

Warming Drawer (on some models)

Remove all items from inside the warming drawer, and allow the range to cool completely before attempting to remove the drawer.

To Remove:

1. Open drawer to its fully open position.
2. Locate the black triangle-shaped tabs on both sides of the drawer.

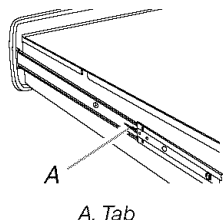

3. Press the tab down on the right side, and lift tab up on the left side at the same time, then pull drawer out another inch.

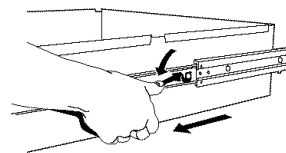

4. Holding the drawer by its sides, slowly pull it all the way out.

To Replace:

1. Align the drawer glides with the receiving guides.

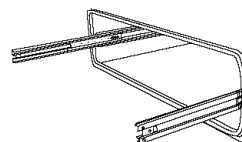

2. Push drawer in all the way.
3. Gently open and close the drawer to ensure it is seated properly on the slides.

TROUBLESHOOTING

Try the solutions suggested here first in order to avoid the cost of an unnecessary service call.

Nothing will operate

- **Is the power supply cord unplugged?**
Plug into a grounded 3 prong outlet.
- **Household fuse blown or circuit breaker tripped?**
Replace the fuse or reset the circuit breaker. If the problem continues, call an electrician.
- **Is the main or regulator gas shutoff valve in the off position?**
See Installation Instructions.
- **Is the range properly connected to the gas supply?**
Contact a trained repair specialist or see Installation Instructions.

Surface burners will not operate

- **Is the "Cooktop Lockout" set?**
See "Cooktop Lockout" section.
- **Is the oven in self-clean?**
Surface burners will not operate during self-clean cycle.
- **Is a delayed self-clean set?**
Surface burners will not operate until the self-clean cycle is complete.
- **Is the control knob set correctly?**
Push in knob before turning to a setting.
- **Is this the first time the surface burners have been used?**
Turn on any one of the surface burner knobs to release air from the gas lines.
- **Are the burner ports clogged?**
See "Sealed Surface Burners" section.

Surface burner flames are uneven, yellow and/or noisy

- **Are the burner ports clogged?**
See "Sealed Surface Burners" section.
- **On models with caps, are the burner caps positioned properly?**
See "Sealed Surface Burners" section.
- **Is propane gas being used?**
The appliance may have been converted improperly. Contact a service technician or see "Assistance or Service" section.

Surface burner makes popping noises

- **Is the burner wet?**
Let it dry.

Excessive heat around cookware on cooktop

- **Is the cookware the proper size?**
Use cookware about the same size as the surface cooking area, element or surface burner. Cookware should not extend more than 1/2" (1.3 cm) outside the cooking area.

Cooktop cooking results not what expected

- **Is the proper cookware being used?**
See “Cookware” section.
- **Is the control knob set to the proper heat level?**
See “Cooktop Controls” section.
- **Is the appliance level?**
Level the appliance. See the Installation Instructions.

Oven will not operate

- **Is this the first time the oven has been used?**
Turn on any one of the surface burner knobs to release air from the gas lines.
- **Is the electronic oven control set correctly?**
See “Electronic Oven Control” section.
- **On some models, is the Control Lockout set?**
See “Control Lockout” section.

Oven burner flames are yellow or noisy

- **Is propane gas being used?**
The appliance may have been converted improperly. Contact a service technician or see “Assistance or Service” section.

Cooling fan runs during baking, broiling or cleaning

- It is normal for the fan to automatically run while the oven is in use to cool the electronic control.

Oven temperature too high or too low

- **Does the oven temperature calibration need adjustment?**
See “Oven Temperature Control” section.

Display shows messages

- **Is the display showing a flashing time?**
There has been a power failure. Clear the display. See “Display(s)” section. On some models, reset the clock, if needed. See “Clock” section.
- **Is the display showing a letter followed by a number?**
Depending on your model, press OFF/CANCEL, OFF or CANCEL/OFF to clear the display. See “Display(s)” section. If it reappears, call for service. See “Assistance or Service” section.
- **Is the display showing a flashing “PUSH?” or “START?”?**
See the “START” section in the “Electronic Oven Controls” section.

Self-Cleaning cycle will not operate

- **Is the oven door open?**
Close the oven door all the way.
- **Has the function been entered?**
See “Self-Cleaning Cycle” section.
- **On some models, has a delay start Self-Clean cycle been set?**
See “Self-Cleaning Cycle” section.
- **Has a delay start been set?**
See “Timed Cooking” section.
- **Has a self-clean cycle been run in the past 12 hours?**
If a self-clean cycle has been run, or canceled after the oven has reached temperature, you will have to wait 12 hours to restart.

Oven cooking results not what expected

- **Is the appliance level?**
Level the appliance. See the Installation Instructions.
- **Is the proper temperature set?**
Double-check the recipe in a reliable cookbook.
- **Is the proper oven temperature calibration set?**
See “Oven Temperature Control” section.
- **Was the oven preheated?**
See “Baking and Roasting” section.
- **Is the proper bakeware being used?**
See “Bakeware” section.
- **Are the racks positioned properly?**
See “Positioning Racks and Bakeware” section.
- **Is there proper air circulation around bakeware?**
See “Positioning Racks and Bakeware” section.
- **Is the batter evenly distributed in the pan?**
Check that batter is level in the pan.
- **Is the proper length of time being used?**
Adjust cooking time.
- **Has the oven door been opened while cooking?**
Oven peeking releases oven heat and can result in longer cooking times.
- **Are baked items too brown on the bottom?**
Move rack to higher position in the oven.
- **Are pie crust edges browning early?**
Use aluminum foil to cover the edge of the crust and/or reduce baking temperature.

ASSISTANCE OR SERVICE

Before calling for assistance or service, please check "Troubleshooting." It may save you the cost of a service call. If you still need help, follow the instructions below.

When calling, please know the purchase date and the complete model and serial number of your appliance. This information will help us to better respond to your request.

If you need replacement parts

If you need to order replacement parts, we recommend that you use only FSP® replacement parts. FSP® replacement parts will fit right and work right because they are made with the same precision used to build every new WHIRLPOOL® appliance.

To locate FSP® replacement parts in your area, call us or your nearest Whirlpool designated service center.

Call the Whirlpool Customer eXperience Center toll free: **1-800-253-1301**.

Our consultants provide assistance with:

- Features and specifications on our full line of appliances.
- Installation information.
- Use and maintenance procedures.
- Accessory and repair parts sales.
- Specialized customer assistance (Spanish speaking, hearing impaired, limited vision, etc.).
- Referrals to local dealers, repair parts distributors and service companies. Whirlpool designated service technicians are trained to fulfill the product warranty and provide after-warranty service, anywhere in the United States.

To locate the Whirlpool designated service company in your area, you can also look in your telephone directory Yellow Pages.

For further assistance

If you need further assistance, you can write to Whirlpool Corporation with any questions or concerns at:

Whirlpool Brand Home Appliances
Customer eXperience Center
553 Benson Road
Benton Harbor, MI 49022-2692

Please include a daytime phone number in your correspondence.

Accessories

Accessories U.S.A.

To order accessories, call the Whirlpool Customer eXperience Center toll free at **1-800-442-9991** and follow the menu prompts. Or visit our website at www.whirlpool.com and click on "Parts & Accessories."

Stainless Steel Cleaner and Polish

(stainless steel models)

Order Part Number 31462

All-Purpose Appliance Cleaner

Order Part Number 31662

Gas Grate and Drip Pan Cleaner

Order Part Number 31617

Notes

WHIRLPOOL CORPORATION MAJOR APPLIANCE WARRANTY

LIMITED WARRANTY

For one year from the date of purchase, when this major appliance is operated and maintained according to instructions attached to or furnished with the product, Whirlpool Corporation or Whirlpool Canada LP (hereafter "Whirlpool") will pay for Factory Specified Parts and repair labor to correct defects in materials or workmanship. Service must be provided by a Whirlpool designated service company. This limited warranty is valid only in the United States or Canada and applies only when the major appliance is used in the country in which it was purchased. Outside the 50 United States and Canada, this limited warranty does not apply. Proof of original purchase date is required to obtain service under this limited warranty.

ITEMS EXCLUDED FROM WARRANTY

This limited warranty does not cover:

1. Service calls to correct the installation of your major appliance, to instruct you on how to use your major appliance, to replace or repair house fuses, or to correct house wiring or plumbing.
2. Service calls to repair or replace appliance light bulbs, air filters or water filters. Consumable parts are excluded from warranty coverage.
3. Repairs when your major appliance is used for other than normal, single-family household use or when it is used in a manner that is contrary to published user or operator instructions and/or installation instructions.
4. Damage resulting from accident, alteration, misuse, abuse, fire, flood, acts of God, improper installation, installation not in accordance with electrical or plumbing codes, or use of consumables or cleaning products not approved by Whirlpool.
5. Cosmetic damage, including scratches, dents, chips or other damage to the finish of your major appliance, unless such damage results from defects in materials or workmanship and is reported to Whirlpool within 30 days from the date of purchase.
6. Any food loss due to refrigerator or freezer product failures.
7. Costs associated with the removal from your home of your major appliance for repairs. This major appliance is designed to be repaired in the home and only in-home service is covered by this warranty.
8. Repairs to parts or systems resulting from unauthorized modifications made to the appliance.
9. Expenses for travel and transportation for product service if your major appliance is located in a remote area where service by an authorized Whirlpool servicer is not available.
10. The removal and reinstallation of your major appliance if it is installed in an inaccessible location or is not installed in accordance with published installation instructions.
11. Major appliances with original model/serial numbers that have been removed, altered or cannot be easily determined. This warranty is void if the factory applied serial number has been altered or removed from your major appliance.

The cost of repair or replacement under these excluded circumstances shall be borne by the customer.

DISCLAIMER OF IMPLIED WARRANTIES; LIMITATION OF REMEDIES

CUSTOMER'S SOLE AND EXCLUSIVE REMEDY UNDER THIS LIMITED WARRANTY SHALL BE PRODUCT REPAIR AS PROVIDED HEREIN. IMPLIED WARRANTIES, INCLUDING WARRANTIES OF MERCHANTABILITY OR FITNESS FOR A PARTICULAR PURPOSE, ARE LIMITED TO ONE YEAR OR THE SHORTEST PERIOD ALLOWED BY LAW. WHIRLPOOL SHALL NOT BE LIABLE FOR INCIDENTAL OR CONSEQUENTIAL DAMAGES. SOME STATES AND PROVINCES DO NOT ALLOW THE EXCLUSION OR LIMITATION OF INCIDENTAL OR CONSEQUENTIAL DAMAGES, OR LIMITATIONS ON THE DURATION OF IMPLIED WARRANTIES OF MERCHANTABILITY OR FITNESS, SO THESE EXCLUSIONS OR LIMITATIONS MAY NOT APPLY TO YOU. THIS WARRANTY GIVES YOU SPECIFIC LEGAL RIGHTS, AND YOU MAY ALSO HAVE OTHER RIGHTS WHICH VARY FROM STATE TO STATE OR PROVINCE TO PROVINCE.

If outside the 50 United States and Canada, contact your authorized Whirlpool dealer to determine if another warranty applies.

If you need service, first see the "Troubleshooting" section of the Use & Care Guide. After checking "Troubleshooting," you may find additional help by checking the "Assistance or Service" section or by calling Whirlpool. In the U.S.A., call **1-800-253-1301**. In Canada, call **1-800-807-6777**.

9/07

Keep this book and your sales slip together for future reference. You must provide proof of purchase or installation date for in-warranty service.

Write down the following information about your major appliance to better help you obtain assistance or service if you ever need it. You will need to know your complete model number and serial number. You can find this information on the model and serial number label located on the product.

Dealer name _____
Address _____
Phone number _____
Model number _____
Serial number _____
Purchase date _____

W10162213A

© 2007 Whirlpool Corporation.
All rights reserved.

© Registered Trademark/TM Trademark of Whirlpool, U.S.A.

10/07
Printed in U.S.A.