

SEARS

**OWNER'S
MANUAL**

**MODEL NO.
625.348320**

Caution:
Read and Follow
All Safety Rules and
Operating Instructions
Before First Use of
This Product.

If you have questions when
installing, operating or main-
taining your softener, and
when setting the timer, call
this toll-free number...

1-800-426-9345

SAVE THIS MANUAL

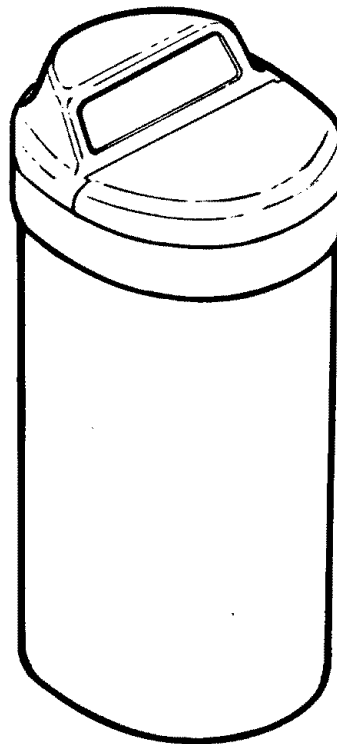

**SOLID STATE
Water Softener**

- ◆ Warranty
- ◆ Start Up / Setting Timer
- ◆ How It Works
- ◆ Care Of / Troubleshooting
- ◆ Specifications
- ◆ Repair Parts

Use plastic bag and tie provided, to hang manuals nearby
the softener for future reference.

Sears, Roebuck and Co., Hoffman Estates, IL 60179 USA

WARRANTY

SEARS RESIDENTIAL WATER SOFTENER

FULL ONE YEAR WARRANTY ON WATER SOFTENER

For one year from the date of purchase, when this water softener is installed and maintained in accordance with our instructions, Sears will repair, free of charge, defects in material or workmanship in this water softener.

FULL TEN YEAR WARRANTY AGAINST LEAKS

For ten years from the date of purchase, Sears will furnish and install a new current model water softener tank or salt storage drum, free of charge, if either the tank or drum develop a leak.

TO OBTAIN WARRANTY SERVICE, SIMPLY CONTACT THE NEAREST SEARS SERVICE CENTER THROUGHOUT THE UNITED STATES. This warranty applies only while this product is in use in the United States.

This warranty gives you specific legal rights, and you may have other rights which vary from state to state.

Sears, Roebuck and Co., D/817 WA, Hoffman Estates, IL 60179

If you want your water softener professionally installed, talk to your Sears Salesman. He will arrange for a prompt, quality installation by Sears Authorized Installers.

SEARS INSTALLATION POLICY

All installation labor arranged by Sears shall be performed in a neat, workmanlike manner in accordance with generally accepted trade practices. Further, all installations shall comply with all local laws, codes, regulations, and ordinances. Customer shall also be protected, during installation, by insurance relating to Property Damage, Workman's Compensation and Public Liability.

SEARS INSTALLATION WARRANTY

In addition to any warranty extended to you on the Sears merchandise involved, which warranty becomes effective the date the merchandise is installed, should the workmanship of any Sears arranged installation prove faulty within one year, Sears will, upon notice from you, cause such faults to be corrected at no additional cost to you.

FACTS AND FIGURES TO KEEP

Fill in the blanks below and keep this book in a safe place so you always have these facts.

Water Softener Model No.† _____

Serial Number _____

Date Installed _____

Water Hardness _____ Grains Per Gallon

Iron Content _____ Parts Per Million

*pH _____ Taste And/Or Odor _____

Water Pressure _____ Pounds/Square Inch

Water Flow Rate _____ Gallons Per Minute

† The model number is on the rating decal, located on the rim, under the salt hole cover.

TABLE OF CONTENTS

	PAGE NO.	
SECTION 1	SOFTENER START UP	
A.	SAFETY GUIDES	4
B.	CHECK LIST OF STEP-BY-STEP GUIDES TO INSTALL	5
C.	PROGRAM THE TIMER	6
D.	SANITIZING THE WATER SOFTENER	7
E.	FILL THE STORAGE TANK WITH SALT	8
SECTION 2	HOW YOUR WATER SOFTENER WORKS	
A.	FACE PLATE TIMER FEATURES	9-10
B.	SOFT WATER SERVICE AND REGENERATION	11-13
SECTION 3	CARE OF YOUR SOFTENER	
A.	SALT: REFILLING STORAGE TANK, SALT BRIDGE	14
B.	KEEPING THE WATER SOFTENER CLEAN	15
C.	KEEP THE SOFTENER FROM FREEZING	16
D.	HELPFUL HINTS CHECKLIST	17
SECTION 4	OTHER THINGS TO KNOW	
A.	HOW TO "FINE-TUNE" YOUR WATER SOFTENER	18-20
B.	DIMENSIONS/SPECIFICATIONS	21
SECTION 5	SERVICE TECH INFORMATION	
A.	ELECTRICAL CONNECTIONS	22
B.	REGENERATION CYCLE TIMES	23
C.	TROUBLESHOOTING	24-26
D.	ROTARY VALVE SERVICE	27
E.	WATER FLOW THROUGH THE SOFTENER VALVE	28-30
SECTION 6	REPAIR PARTS	32-35

1A.

SAFETY GUIDES

▲ Read all steps, guides and rules carefully before installing and using your new water softener. Follow all steps exactly to correctly install. Failure to follow them could cause personal injury or property damage. Reading this book will also help you to get all of the benefits from your water softener.

▲ Your water softener will remove hardness minerals and “clear water” iron from water, up to the limits shown on page 21. It will not remove other types of iron, acids, tastes and odors, etc. It will not purify polluted water or make it safe to drink.

▲ Protect the softener and piping from freezing. Damage from freezing voids the softener warranty. See page 16.

CAUTIONS

PLEASE READ AND COMPLY WITH THE FOLLOWING GUIDES TO PREVENT DAMAGE TO THE SOFTENER OR OTHER PROPERTY, PERSONAL INJURY, OR POSSIBLE FATAL SHOCK.

▲ THIS SOFTENER WORKS ON 24 VOLTS ONLY. BE SURE TO USE THE TRANSFORMER INCLUDED, AND PLUG IT INTO A 120V OUTLET.

▲ Unplug the transformer right away if the power cable should become damaged or frayed. Make repairs before plugging back into the power outlet.

▲ Always unplug the softener from electrical power before removing outer valve covers.

1B. CHECK LIST OF ALL STEP-BY-STEP GUIDES TO INSTALL

Refer to the Installation Manual, part no. 7141417, for step-by-step guides.

To be sure you have done all the steps to install the softener, read the following list. Page numbers referred to are in the *Installation Manual*.

- ✓ Is the house water flow going INTO the softener valve INLET? Trace piping to be sure. See pages 10 and 11.
- ✓ Is the plumbing bypass valve (or 3 valves) set for SERVICE? See page 18.
- ✓ Is the valve drain hose connected the right way, and without sharp bends or kinks that could stop or reduce water flow? See page 16.
- ✓ Is the softener power cable connected to the transformer, and is the transformer plugged into **an inside**, 120V-60Hz electrical outlet? See page 20.
- ✓ Be sure to restart the water heater. See page 20.

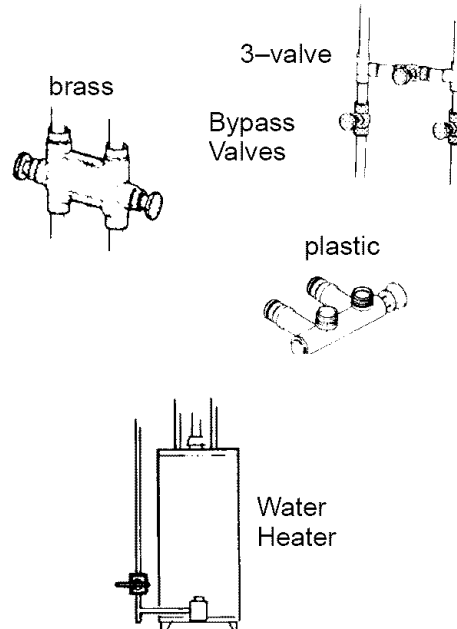
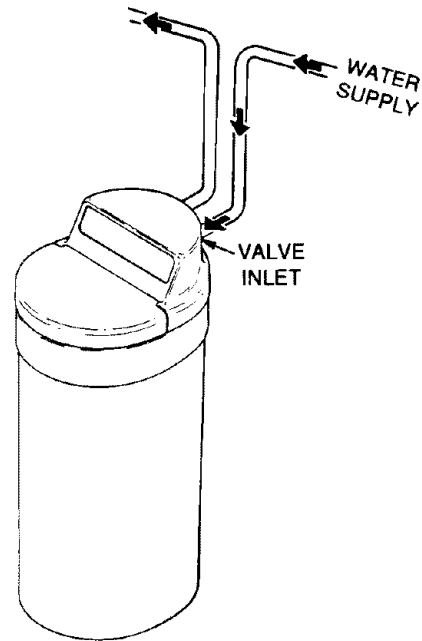

1C. PROGRAM THE TIMER

FIG. 1

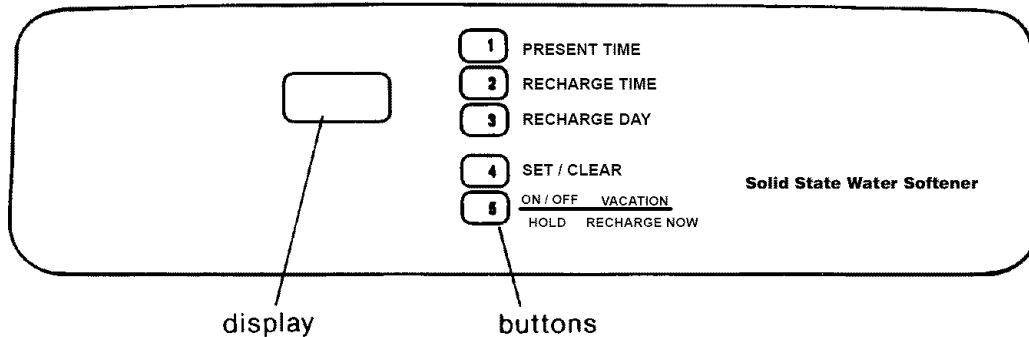

1. SET THE TIMER

When the transformer is plugged into the electrical outlet, 12:00 AM, SUnDay began to flash in the time display. Set the **time of day** and present **day of week** as follows:

A. SET TIME OF DAY

1. Press the PRESENT TIME AND DAY button [1] once. The hour display continues to flash.
2. Press the SET/CLEAR button [4] until the present hour of the day shows in the display. Be sure AM for morning hours, or PM for afternoon and evening hours shows.

NOTE:

Press SET/CLEAR and quickly release to move the hour display ahead 1 at a time to the correct hour. Or, *hold* the SET/CLEAR button to move the display ahead 2 hours each second, to the correct hour.

3. Press button [1] once to steady the hour display, and minutes begin to flash. Repeat step A2 to set the correct minutes.
4. Press button [1] again to steady the minute display (day will begin flashing). Figure 2 shows the timer set at 3:30 PM. See step B to set the present day.

B. SET PRESENT DAY OF WEEK

1. Press the SET/CLEAR button [4] to set the present day of the week in the display.

NOTE:

Press SET/CLEAR and quickly release to move the day display 1 at a time. Or, *hold* the SET/CLEAR button to move the day display ahead 2 days each second.

2. Press the PRESENT TIME AND DAY button [1] again to steady the entire display. Figure 2 shows the timer set at TUESday.

FIG. 2

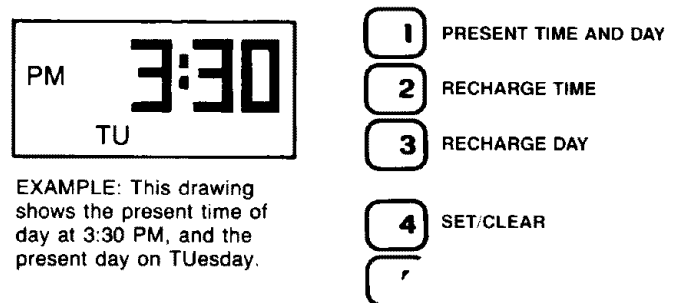

EXAMPLE: This drawing shows the present time of day at 3:30 PM, and the present day on TUESday.

No other settings are needed after installing your water softener. The softener is factory set to regenerate every Monday, Wednesday and Saturday (beginning at 2:00 AM). For most families, this gives enough soft water for their needs. **However, if you want the softener to regenerate at a different time, or on different days, or to set for the most efficiency, see "Fine-Tuning Your Water Softener," page 18.**

SEE PAGE 9 FOR OTHER TIMER CONTROLS AND FEATURES.

1D. SANITIZING THE WATER SOFTENER

Care is taken at the factory to keep your water softener clean and sanitary. Materials used to make the softener will not infect or contaminate your water supply, and will not cause bacteria to form or grow. However, during shipping, storage, installing and operating, bacteria could get into the softener. For this reason, sanitizing as follows is suggested^① when installing.

1. Lift the salt hole cover and use a pail or hose to fill the salt storage tank with at least 3 gallons of water.
2. Remove the brinewell cover (FIG. 3) and pour about 3/4 ounce of common 5.25% household bleach (Clorox, Linco, BoPeep, White Sail, Eagle, etc.) in the softener brinewell.
3. Press the **ON/OFF-HOLD** button and *hold for 3 seconds* to start a recharge. This first recharge does several things.
 - It draws the bleach into and through the softener to sanitize it.
 - It fills the salt tank to the water level needed.
 - It gets all the air out of the resin tank.
 - It makes the resin bed (see page 11) ready for service.

NOTES:

This recharge takes about 2 hours.

You can sanitize the softener *with or without* salt in the storage tank.

FIG. 3

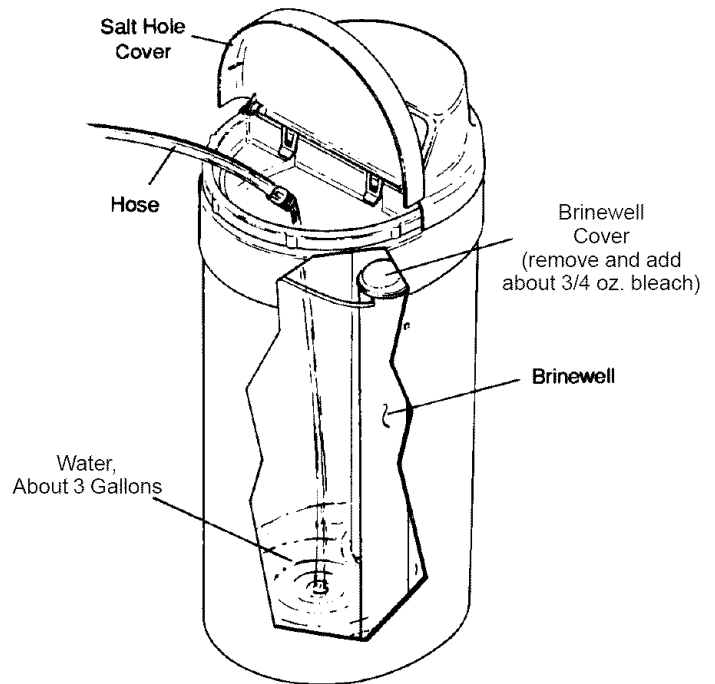

^① Recommended by the Water Quality Association. On some water supplies, the water softener may need periodic disinfecting. Sanitize with or without salt in the storage tank.

1E. FILL THE STORAGE TANK WITH SALT

Brine (salt dissolved in water) is needed for each and every regeneration. The water for making brine is metered into the salt storage tank by the softener. However, you must keep the tank filled with salt.

Fill the tank with NUGGET or PELLET water softener salt. DO NOT use rock salts, as they have dirt and sediments that will stop the softener from working.

Before filling, be sure the brinewell cover is in place on the top of the brinewell. Salt storage capacity is shown on page 21.

NOTES:

In humid areas, it is best to fill the storage tank half-full, and to refill it more often. Salt bridging (see page 14) occurs more often when conditions are humid.

WATER SOFTENING SALT WITH IRON REMOVING ADDITIVES — Some salts have an additive to help the softener handle iron in the water supply. Although this additive may help to keep the softener resin clean, it may also release corrosive fumes that will weaken and shorten the life of some softener parts.

FIG. 4

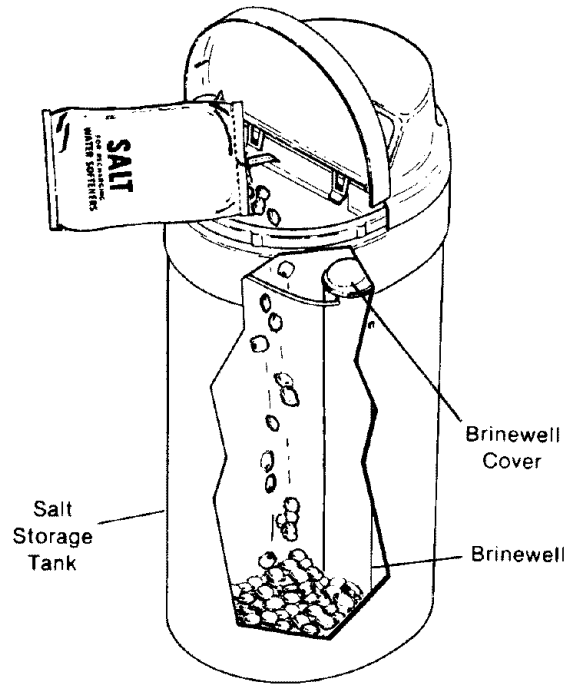

SODIUM INFORMATION: Water softeners using sodium chloride for regeneration add sodium to the water. Persons who are on sodium restricted diets should consider the added sodium as part of their overall sodium intake.

For example, if your water supply is 15 grains hard, you would have to drink 3 quarts of softened water to consume 335 milligrams of sodium. That is equivalent to eating 2-1/2 slices of white bread.

Persons who are concerned about their drinking water should consider a Sears Drinking Water System that will remove or reduce in excess of 90% of the sodium and other drinking water contaminants.

YOU HAVE NOW FINISHED THE WATER SOFTENER START UP. AFTER THE SANITIZING RECHARGE, ON PAGE 7, THE SOFTENER WILL BE GIVING YOU SOFT WATER.

2A. FACE PLATE TIMER FEATURES

RECHARGE NOW — If you have guests visiting, or other times when you use more water than usual, you could begin to run out of soft water. If the softener is not scheduled to regenerate for another day or 2, you would get hard water until then. If this happens, or you think it might happen, press and *bold* in the HOLD-RECHARGE NOW button [5] for 3 seconds until **RCHG** shows. **RCHG** will flash in the display during the regeneration, which lasts under 2 hours.

NOTE:

Avoid using HOT water while the softener regenerates, because bypass hard water will refill the water heater (see “Automatic Bypass,” page 13).

FIG. 5

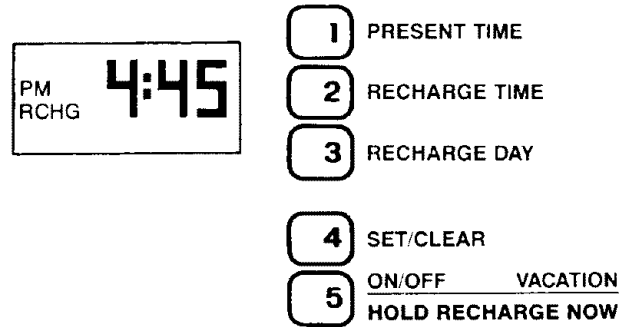

VACATION — The day you leave on vacation, or other long absence, press (**do not hold in**) the ON/OFF VACATION button [5]. VAC begins to flash in the display (FIG. 6). The timer will keep time, but the softener will not regenerate to waste water and salt.

NOTE:

While in VACATION, the softener will go through a regeneration if the RECHARGE NOW feature is used (see above).

To shut off the water supply to the softener, use the plumbing bypass valve(s), FIG. 16, page 21.

WHEN YOU RETURN, press the VACATION button again to return the softener to service, and the correct time of day in the display. **Remember to do this or the softener will not regenerate and you will soon have hard water.**

FIG. 6

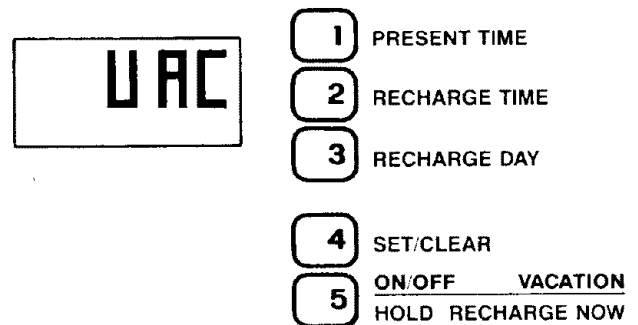

ERROR CODE — An error code could appear in the face plate display if a problem occurs in the softener electronics. If you see an error code instead of the present time of day, please call your local Sears Service Department for service.

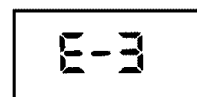

Continued

2A. FACE PLATE TIMER FEATURES

TIMER “POWER-OUTAGE MEMORY” — If electrical power to the timer goes off, the “memory” built into timer circuitry keeps **all** settings for 6 hours (minimum) or more. The display is blank and the softener will not regenerate. When electrical power comes on, 1 of 2 things will happen.

1. The present time of day will show, meaning the timer memory has kept all settings.

NOTE:

If the softener was **in** a regeneration when power was lost, it will now finish the cycle.

2. The display will show a time, but it will be flashing. The timer memory did **not** keep the time settings and they must be reset (page 6).

The flashing display is to remind you to reset the timer.

NOTE:

When power comes on, the flashing display returns to a time of 12:00 AM Sunday, then begins to keep time again. If you do not reset all time settings, the softener will regenerate 3 days each week. However, regeneration will most likely be on the wrong days and at the wrong time.

If the softener was in a regeneration when power went off, the valve will return to service position without finishing the regeneration cycle. If your water tastes salty:

— use RECHARGE NOW (see page 9) to start another regeneration, or

— open 1 or more soft water faucets and allow to run until the salt taste is gone.

2B. SOFT WATER SERVICE AND REGENERATION

SERVICE

When the softener is giving you soft water, it is called "Service". During service, hard water comes from the house main water pipe into the softener. Inside the softener resin tank is a bed made up of thousands of tiny, plastic resin beads (FIG. 7). As hard water passes through the bed, each bead attracts and holds the hardness minerals. This is called ion-exchanging. It is much like a magnet attracting and holding metals. Water without the hardness minerals (soft water) flows out of the softener and into the house soft water pipes.

After a period of time, the resin beads become coated with hardness minerals and they have to be cleaned. This cleaning is called recharge, or regeneration.

Regeneration is started at about 2:00 a.m. (factory setting) by the timer. It takes place in 5 stages or cycles. These are:

- | | | | |
|---|-------------|---|------------|
| 1 | FILL | 4 | BACKWASH |
| 2 | BRINING | 5 | FAST RINSE |
| 3 | BRINE RINSE | | |

FIG. 7 WATER FLOW THROUGH THE SOFTENER IN SERVICE

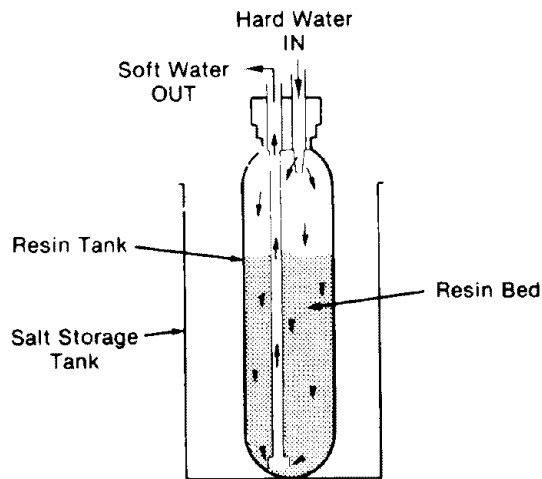

REGENERATION

1 FILL: Salt, dissolved in water, is called brine. Brine is needed to clean the hardness minerals from the resin beads. To make the brine, soft water flows into the salt storage area during the fill cycle as shown in FIG. 8.

The length of the fill cycle is factory set to provide softening capacity for an average family. You can reset this time when "fine-tuning" the water softener, pages 18 through 20.

FIG. 8 WATER FLOW THROUGH THE SOFTENER IN FILL

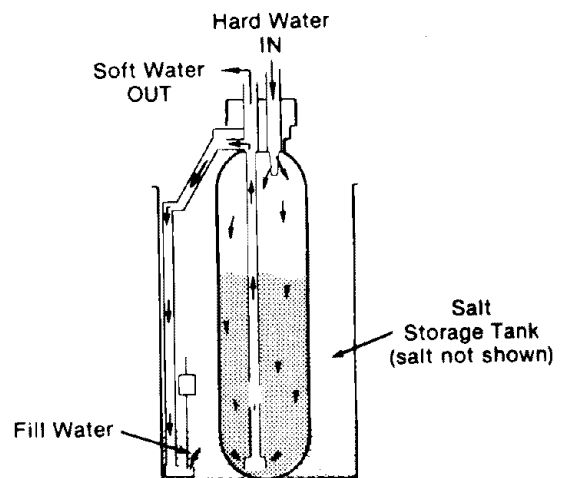

2B. SOFT WATER SERVICE AND REGENERATION

2] BRINING: During brining, the brine is moved from the salt storage area, into the resin tank. Inside the resin tank, brine cleans hardness minerals from the resin beads and they are discharged out the drain. How much brine is needed to clean the resin depends on:

- the amount of resin in the softener.
- how fast the brine goes through the bed.

The nozzle and venturi (FIG. 9) makes the suction to take brine from the salt tank and put it into the resin tank. It keeps the brine flow down to a very slow rate to get the best resin cleaning with the least salt.

3] BRINE RINSE: After all of the brine goes into the resin tank, the brine valve closes. Water keeps flowing the same way it did during brining, except the brine flow has stopped. Hardness minerals and brine flush from the resin tank to the drain.

FIG. 9 WATER FLOW THROUGH THE SOFTENER IN BRINING AND BRINE RINSE

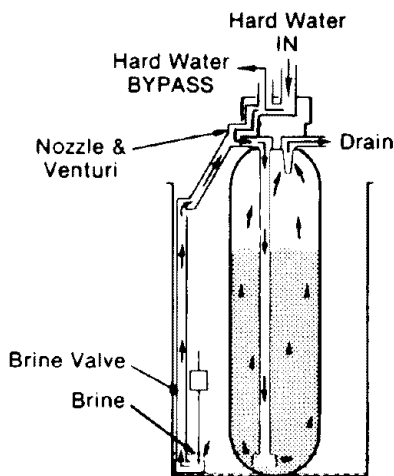

4] BACKWASH: During backwash, water flows UP through the resin tank (FIG. 10) at a fast rate to flush iron minerals, dirt and sediments from the bed and to the drain. The bed lifts and expands for good cleaning.

FIG. 10 WATER FLOW THROUGH THE SOFTENER IN BACKWASH

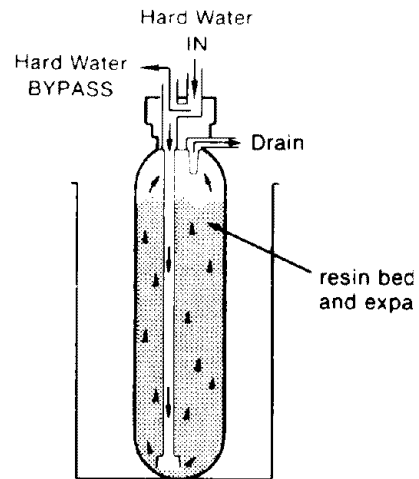

5] FAST RINSE: Backwash is followed by a fast flow of water down through the resin tank. The fast flow packs the resin bed and gets it ready for return to service (FIG. 11).

After fast rinse, the softener returns to service. Hard water goes into the resin tank where the resin bed again takes out the hardness minerals. Soft water goes to the house soft water pipes.

FIG. 11 WATER FLOW THROUGH THE SOFTENER IN FAST RINSE

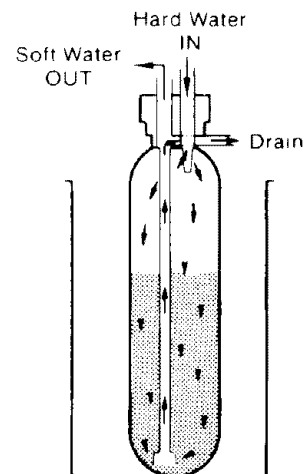

2B. SOFT WATER SERVICE AND REGENERATION

AUTOMATIC BYPASS

During the brining, brine rinse and backwash cycles of regeneration, HARD water goes through the softener valve and to the house pipes. If a faucet is opened, hard water is there for your needs. However, you should not use HOT water, if possible, because the water heater will refill with hard water. The softener regenerates from 2:00 AM to about 4:00 AM, (you can set anytime), a time when not much water is used.

If you get up early in the morning and you can hear the softener regenerating, change the time setting. Set the recharge time to 12:00 AM or 1:00 AM (page 18). Then regeneration will start and end that much earlier and your water heater will not refill with hard water if a hot faucet is opened.

3A. SALT...REFILLING STORAGE TANK/BREAKING A SALT BRIDGE

WHEN TO REFILL WITH SALT: Check the salt level a few weeks after you install the softener and every week after that. **Refill when the storage tank is about 1/3 full.** Never let the softener use all the salt before refilling. Without salt, you will soon have hard water.

IMPORTANT:

You will have a loss in softening capacity and may get partly hard water if less than 10 inches of salt is in the storage tank.

PLEASE SEE PAGE 8 FOR SALT FILLING DIRECTIONS.

SALT BRIDGE

Sometimes, a hard crust or salt bridge forms in the salt storage tank. It is usually caused by high humidity or the wrong kind of salt. When the salt bridges, an empty space forms between the water and salt. Then, salt will not dissolve (melt) in the water to make brine. Without brine, the resin bed does not regenerate and you will have hard water.

If the storage tank is full of salt, it is hard to tell if you have a salt bridge. Salt is loose on top, but the bridge is under it. The following is the best way to check for a salt bridge.

Salt should be loose all the way to the bottom of the tank. Hold a broom handle, or like tool, up to the softener as shown in FIG. 12. Make a pencil mark on the handle, 1, or 2, below the top height of the rim. Then, carefully push it straight down into the salt. If a hard object is felt before the pencil mark gets to the top of the tank, it's most likely a salt bridge. Carefully push into the bridge in a few places to break it. **Do not try to break the salt bridge by pounding on the outside of the salt tank. You may damage it.**

If the wrong kind of salt made the bridge, take it out. Then fill the tank with nugget or pellet salt only.

FIG. 12 A SALT BRIDGE

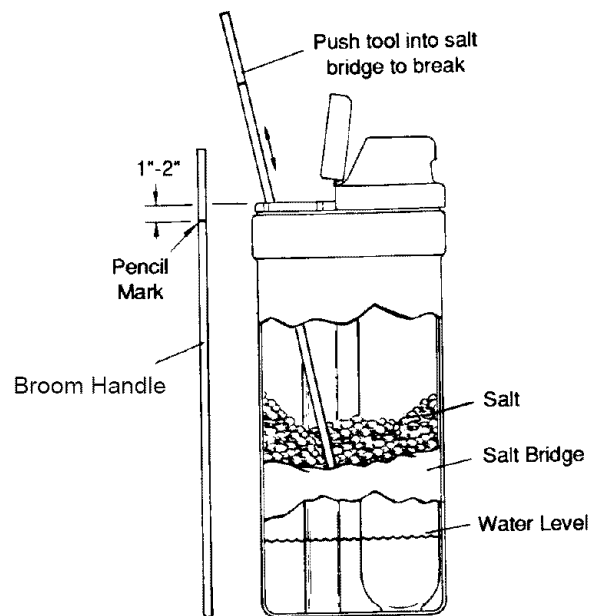

3B. KEEPING THE WATER SOFTENER CLEAN

COVERS

To keep your new Sears water softener looking nice, apply a coat of paste wax and repeat once a year. When dusty, wipe it with a damp cloth to keep it sparkling.

NOTE:

Never use cleaners having ammonia or abrasives. They may scratch and dull the surface.

NOZZLE AND VENTURI

A clean nozzle and venturi (FIG. 13) is a must for the softener to work right. This small unit moves brine from the salt storage tank to the resin tank during regeneration. If it becomes plugged with sand, silt, dirt, etc., the softener will not work and you will get hard water.

To get to the nozzle and venturi, remove the softener top cover. Be sure the softener is in service cycle (no water pressure at nozzle and venturi), then turn off the cap from the nozzle and venturi housing. **DO NOT LOSE THE LARGE O-RING SEAL.** Lift out the screen support and screen, then the nozzle and venturi. Wash and rinse the parts in warm water until clean. If needed, use a small brush to remove iron or dirt. Also check and clean the gasket, small screen and flow plug.

Carefully replace all parts in the correct order. Lubricate the o-ring seal with silicone grease or Vaseline and place in position. Install and tighten the cap, **by hand only. Do not overtighten and break the cap or housing.**

FIG. 13

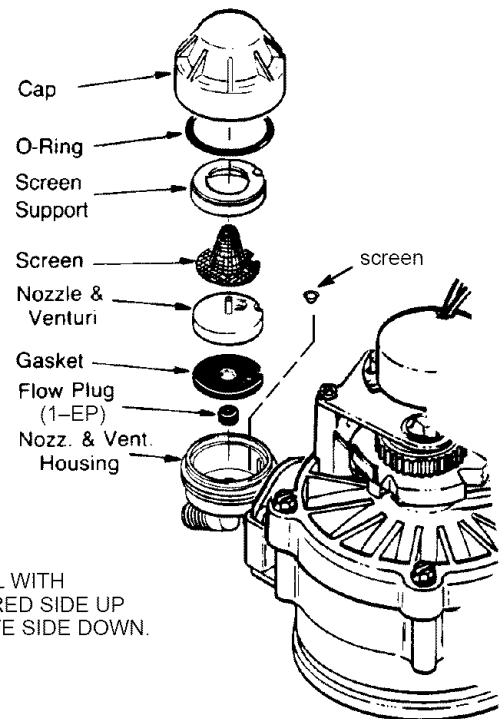

*INSTALL WITH
NUMBERED SIDE UP
CONCAVE SIDE DOWN.

IRON FROM THE RESIN BED

Your water softener takes hardness minerals (calcium and magnesium) out of the water. Also, it can control some "clear water" iron (see maximum allowed in the specifications on page 21). With clear water iron, water from a faucet is clear when first put into a glass. After 15 to 30 minutes, the water begins to cloud or turn rust colored. A water softener **WILL NOT** remove any iron which makes the water cloudy or rusty as it comes from the faucet (called red water iron). To take red water iron out of water, or over the maximum of clear

water iron, an iron filter or other equipment is needed. Your local Sears store has trained people to help you with iron water problems.

If your water supply has clear water iron, even though less than the maximum allowed, regular resin bed cleaning is needed. Sears has resin bed cleaner, Stock No. 42-34426 for this. Clean the bed at least every 6 months. If iron shows up in the soft water before 6 months, clean more often. Printed instructions are on the resin bed cleaner bottle.

IF YOU HAVE QUESTIONS ABOUT CLEANING AND MAINTAINING YOUR SOFTENER, CALL TOLL FREE, NUMBER 1-800-426-9345.

3C. KEEP THE SOFTENER FROM FREEZING

If the softener is installed where it could freeze (summer cabin, lake home, etc.), you must drain all water from it to stop possible freeze damage. To drain the softener —

1. Close the shut-off valve on the house main water pipe, near the water meter or pressure tank.
2. Open a faucet in the soft water pipes to vent pressure in the softener.
3. Looking at FIG. 16 on page 21, move the stem in a single bypass valve to bypass. Close the inlet and outlet valve in a 3-valve bypass system, and open the bypass valve. If you want water in the house pipes again, reopen the shut-off valve on the main water pipe.
4. Unplug the transformer at the wall outlet. Remove the salt hole cover and the main cover. Take off both drain hoses.
5. Carefully remove the large holding clips at the softener inlet and outlet (see Key No. 61, on page 34). Separate the softener from the adaptors or bypass valve.
6. Remove the brinewell cover and disconnect the brine valve tubing at the nozzle and venturi assembly (see page 34). Lift the brine valve out of the brinewell. Tip the brine valve upside down to drain out water.

FIG. 14 DRAIN WATER FROM THE SOFTENER

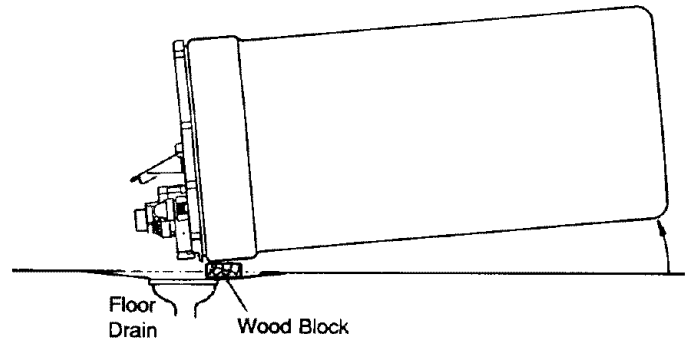

7. Looking at FIG. 14, lay a piece of 2 inch thick board near the floor drain. Move the softener close to the drain. SLOWLY and CAREFULLY tip it over until the rim rests on the wood block with the inlet and outlet over the drain. **Do not allow the softener's weight to rest on the inlet and outlet fittings or they will break.**
8. Tip the bottom of the softener up a few inches and hold until all water has drained. Leave the softener laying like this until you are ready to use it. Plug the inlet and outlet with rags to keep dirt, bugs, etc. out.

3D. HELPFUL HINTS CHECKLIST

... TO HELP YOU SAVE MONEY

NOTE:

Read "ERROR CODE", page 9. If your water softener fails to work, make the following easy checks. Often, you will find what's wrong yourself and you won't have to call and wait for service. If, after making the checks, your softener still does not work right, call your Sears Service Department, or call toll free, number 1-800-426-9345 for telephone assistance.

PROBLEM	CAUSE	CORRECTION
NO SOFT WATER	No salt in the storage tank	Refill with salt (see page 8). Use the RECHARGE NOW button to start a regeneration (see page 9).
	Transformer unplugged at the wall outlet, or power cable disconnected	Check for loss of power and correct. Reset the times, then use the RECHARGE NOW button to start a regeneration (see page 9).
	Fuse blown, circuit breaker popped, or circuit switched off—SEE PAGE 10, "TIMER POWER-OUTAGE MEMORY".	Replace fuse, reset circuit breaker, or switch circuit on. Reset times and use the RECHARGE NOW button to start a regeneration.
	Timer in the vacation (VAC) position	See VACATION feature to return the softener to service (page 9).
	No regenerations set on the timer	See pages 18-20 to select and program a schedule. Use the RECHARGE NOW button to start an immediate regeneration.
	Manual bypass valve(s) in bypass position	See FIG. 16, page 21. Move stem in single bypass valve to SERVICE.
	Salt in storage tank bridged	Refer to page 14 to break.
	Dirty, plugged or damaged nozzle & venturi	Take apart and clean (see page 15) or replace damaged parts.
	Valve drain hose plugged	Hose must not have kinks, sharp bends, or any water flow blockage (see page 16 in your installation manual).
	Low or high system water pressure (Low pressure may disrupt brine draw during recharge. High pressures may cause inner valve parts failure.)	If pressure is low, increase well pump output to a minimum of 20 psi. Add a pressure reducing valve, in the supply pipe to the softener, if day time pressure is over 100 psi (see installation manual).
WATER HARD SOMETIMES	Regenerations too few	Refer to pages 18-20 to find correct setting.
	More water being used	See pages 18-20 for correct regeneration setting.
	Hot water used when softener is regenerating	Avoid using hot water as the water heater refills with hard water (see "Automatic Bypass" on page 13).
	Possible increase in water hardness	Ask your Sears retail or catalog store for a new water analysis.
	Leaking faucet or toilet valve	A small leak will waste hundreds of gallons of water in a few days. Fix all plumbing leaks and always fully close faucets.

4A. HOW TO “FINE-TUNE” YOUR SOFTENER

It is not hard to fine-tune your softener, but it does take a few minutes of your time to do it right. You may save up to 500 pounds or more of salt each year with proper tuning. Read the following carefully.

To have soft water all the time, the softener must regenerate, or recharge a certain number of times in each 7 day period. How many times to regenerate (set the timer) depends on 3 things.

1. The number of people in your home — tells you how much water is used.
2. The grains per gallon (GPG) hardness of your water supply — listed on your water analysis report (see page 2 in your Installation Manual, or page 2 of this manual).

NOTE:

If your water supply contains iron, compensate for it by adding to the water hardness number. *For example, assume your water is 15 gpg hard and contains 2 ppm iron. Add 5 to the hardness number for each 1 ppm of iron. In this example, you would use 25 for your hardness number.*

	15 gpg hardness
2 ppm iron x 5 = 10	<u>+10</u>
(times)	25 HARDNESS NUMBER

3. How much salt is used each regeneration — determined by the length of the fill cycle (see pages 19 and 20).

REGENERATION TABLE: The table (page 20) makes it easy for you to pick the best regeneration and fill time setting to use.

Step 1 — Go down the side of the table to the number of persons in your family, or the number of people in the house using water.

Step 2 — Across the top of the table, find the column listing the grains per gallon hardness of your water, or hardness number for iron water.

Step 3 — Read across and down the table to find the point where steps 1 and 2 meet. At this meeting point, suggested days to regenerate, and fill cycle minutes needed are shown.

TO SET THE TIMER FOR DAYS OF REGENERATION AND FILL MINUTES, DO THE FOLLOWING.

NOTE:

Remember, the timer is factory set for Monday, Wednesday and Saturday regenerations starting at 2:00 AM. Fill time is factory set for 16 minutes.

1. SET DAYS AND TIME OF REGENERATION, OR RECHARGE

- a. Press the RECHARGE TIME button 2 once to display the factory set regeneration days and starting time (flashing). To change the regeneration start time, do step b following. Otherwise go to step c.

FIG. 15

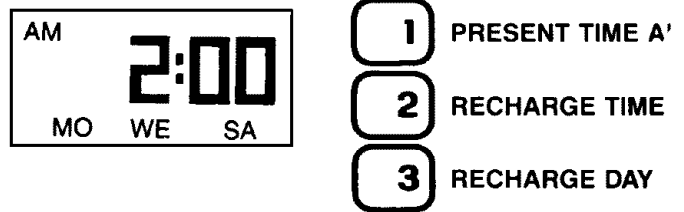

NOTE:

Read “Automatic Bypass” page 13, when choosing a regeneration starting time other than 2:00 AM.

- b. Press the SET/CLEAR button 4 until the desired regeneration starting time shows in the display.

NOTE:

Press SET/CLEAR and quickly release to move the display ahead 1 hour at a time. Or, *hold* the SET/CLEAR button to move the display ahead 2 hours each second.

WRITE IN YOUR RESULTS HERE.

1. M T W TH F S SU Suggested days to regenerate
 —circle suggested days—

2. _____ Fill Cycle minutes needed

4A. HOW TO “FINE-TUNE” YOUR SOFTENER

- c.** Press the RECHARGE DAY button [3] and SUn-day begins to flash.

— If you *want* regenerations on Sunday (from regeneration table), press the SET/CLEAR button [4] to display **ON**.

— If you *do not want* Sunday regenerations, press SET/CLEAR button [4] to display **OFF**.

- d.** Press the RECHARGE DAY button [3] again to display a flashing MOn-day and ON (factory set recharge). As you did in step c, use the SET/CLEAR button [4] to change the display from ON to OFF, or from OFF to ON.

- e.** Press RECHARGE DAY button [3] to display a flashing TUEsday, WEDnesday, etc., each time using the SET/CLEAR button [4] to display either ON or OFF as needed.

After recharge is either set or cancelled for SATurday, press the PRESENT TIME AND DAY button [1] once again to return the present time and day display.

2. SET THE FILL CYCLE MINUTES

- a.** Press and *bold* the RECHARGE TIME button [2] until FILL shows in the display, then release button [2]. After a few seconds, the fill cycle minutes (factory setting...16) will flash.

- b.** Press the SET/CLEAR button [4] to set the minutes of fill cycle needed, as shown in the regeneration table.

NOTE:

You may get hard water between regenerations if you set the timer for fewer fill minutes than the Regeneration Table shows you to set. A higher setting than needed will waste salt.

NOTE:

Press SET/CLEAR and quickly release to move the display ahead 1 minute at a time. Or, *bold* the SET/CLEAR button to move the display ahead 2 minutes each second. THE DISPLAY BEGINS OVER AT 0 AFTER PASSING 59.

- c.** Press PRESENT TIME AND DAY button [1] to return the present time and day display.

TO SET THE PRESENT TIME OF DAY, AND DAY OF WEEK, SEE PAGE 6.

IF YOU NEED HELP TO PROGRAM THE TIMER, CALL TOLL FREE,
NUMBER 1-800- 426-9345.

4A. HOW TO "FINE-TUNE" YOUR SOFTENER

	REGENERATION TABLE										
	WATER HARDNESS – GRAINS PER GALLON										
	Up to 5	6 to 10	11 to 15	16 to 20	21 to 25	26 to 30	31 to 35	36 to 40	41 to 45	46 to 50	
1 PERSON IN THE HOUSEHOLD	M 7	M 7	M 7	M 7	M 8	M 11	M 14	M TH 7	M TH 7	M TH 8	1 PERSON IN THE HOUSEHOLD
2 PERSONS IN THE HOUSEHOLD	M 7	M 7	M 11	M TH 7	M TH 8	M TH 11	M TH 7	M W S 9	M T TH S 7	M T TH S 8	2 PERSONS IN THE HOUSEHOLD
3 PERSONS IN THE HOUSEHOLD	M 7	M 11	M TH 7	M TH 11	M W S 8	M T TH S 7	M T TH S 9	M T TH F S 8	M T TH F S SU 7	M T TH F S SU 8	3 PERSONS IN THE HOUSEHOLD
4 PERSONS IN THE HOUSEHOLD	M 7	M TH 7	M TH 11	M W S 9	M T TH S 8	M T TH F S 8	M T TH F S SU 7	EVERY DAY 7	EVERY DAY 8	EVERY DAY 9	4 PERSONS IN THE HOUSEHOLD
5 PERSONS IN THE HOUSEHOLD	M 8	M TH 8	M W S 8	M T TH S 8	M T TH F S 8	M T TH F S SU 8	EVERY DAY 8	EVERY DAY 9	EVERY DAY 12	EVERY DAY 15	5 PERSONS IN THE HOUSEHOLD
6 PERSONS IN THE HOUSEHOLD	M 11	M TH 11	M T TH S 7	M T TH F S 8	M T TH F S SU 8	EVERY DAY 8	EVERY DAY 11	EVERY DAY 14			6 PERSONS IN THE HOUSEHOLD
7 PERSONS IN THE HOUSEHOLD	M TH 7	M TH 7	M T TH S 9	M T TH F S SU 7	EVERY DAY 8	EVERY DAY 11	EVERY DAY 14		/	/	7 PERSONS IN THE HOUSEHOLD
8 PERSONS IN THE HOUSEHOLD	M TH 7	M W S 9	M T TH F S 8	EVERY DAY 7	EVERY DAY 9	EVERY DAY 14		/	/	/	8 PERSONS IN THE HOUSEHOLD
9 PERSONS IN THE HOUSEHOLD	M TH 7	M T TH S 7	M T TH F S SU 7	EVERY DAY 8	EVERY DAY 12		/	/	/	/	9 PERSONS IN THE HOUSEHOLD
10 PERSONS IN THE HOUSEHOLD	M TH 8	M T TH S 8	M T TH F S SU 8	EVERY DAY 9	EVERY DAY 15		/	/	/	/	10 PERSONS IN THE HOUSEHOLD

LEGEND:

M	T	W
TH	F	
S	SU	

← **DAYS TO REGENERATE:** M = Monday, T = Tuesday, W = Wednesday
 TH = Thursday, F = Friday, S = Saturday, SU = Sunday
 (factory set for Monday, Wednesday and Saturday)

2

← **MINUTE-LENGTH OF FILL CYCLE NEEDED**
 (factory set for 16 minutes)

MINUTES OF FILL @ 0.1 GPM														
MIN. →	7	8	9	10	11	12	13	14	15	16	17	19	20	25 ← MIN.
LBS. →	2.0	2.3	2.6	2.9	3.2	3.5	3.8	4.1	4.4	4.6	4.9	5.5	5.8	7.2 ← LBS.
POUNDS OF SALT USED EACH REGENERATION														

4B. DIMENSIONS/SPECIFICATIONS

FIG. 16 BYPASS VALVES

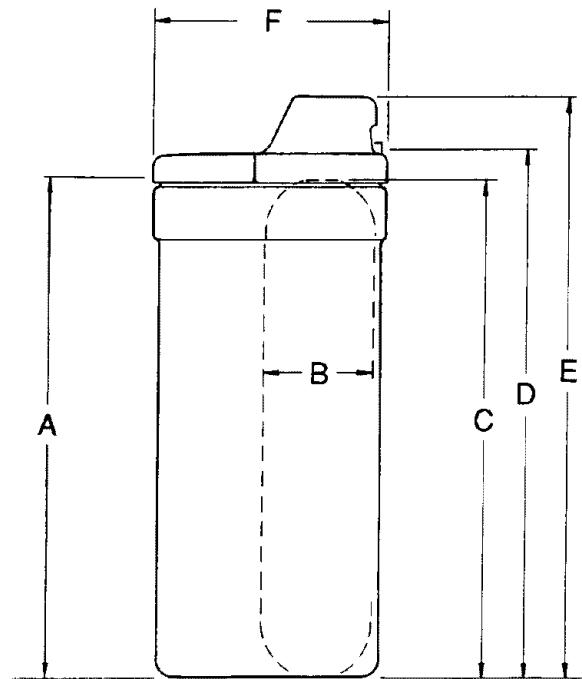
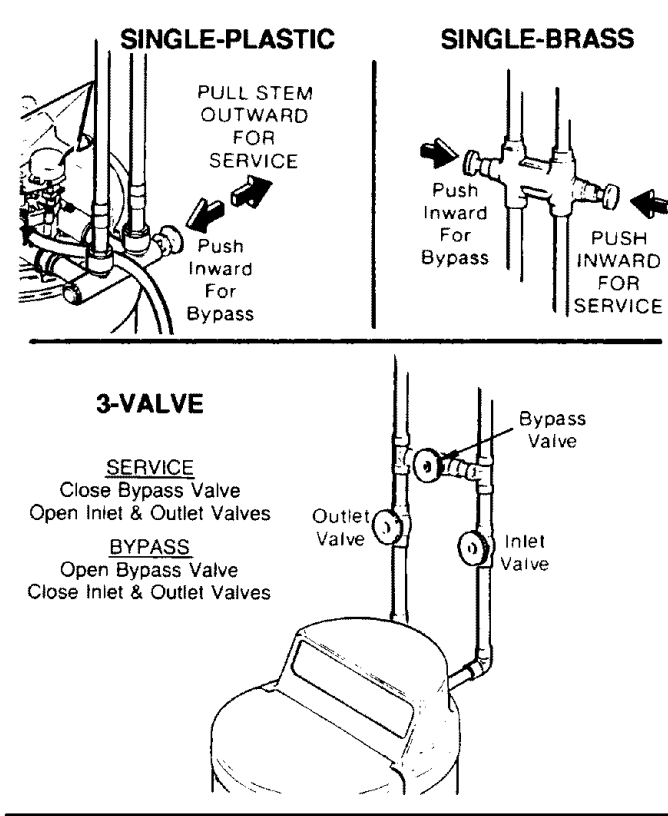

	INCHES	CM
A Salt Tank Height	40-1/4	102.2
B Resin Tank Diameter(nominal)	8	20.3
C Resin Tank Height (nominal)	40	101.6
D Inlet-Outlet Height	41-1/2	105.4
E Overall height	46	116.8
F ¹ Length	19-1/2	49.5
F ² Width	16-1/2	41.9
— Distance between inlet-outlet center lines	3-3/8	8.6

MODEL NO. 625.348320

NOTE:

Please see the rating decal for water softener operating capacity, salt usage and service flow rate/pressure loss performance specifications. Performance specifications are validated by the Water Quality Association (WQA). The rating decal is located on the rim, under the salt hole cover (see page 32).

WATER SUPPLY TO WATER SOFTENER

MINIMUM WATER SYSTEM FLOW (gpm)	3
MINIMUM-MAXIMUM WATER PRESSURE (psi)	20-120
MAXIMUM WATER TEMPERATURE (°F)	120
MAXIMUM WATER HARDNESS (gpg)	50
MAXIMUM "CLEAR WATER" IRON (ppm)	2

SALT FOR WATER SOFTENER

TYPE OF SALT NEEDED	Nugget/Pellet
ALTERNATE TYPE OF SALT	Pure, evaporated, compacted water softener salt
STORAGE CAPACITY (pounds)	200

OTHERS

TYPE OF ION EXCHANGE MATERIAL (resin)	High Capacity
AMOUNT OF RESIN (cu.ft.)	.52
REGENERATION (RECHARGE) CYCLE TIME (min.)	
FILL (factory setting-time is adjustable)	16
BRINING/BRINE RINSE	80
BACKWASH	12
FAST RINSE	4
TOTAL REGENERATION TIME (factory setting)	118

gpm = gallons per minute
gpg = grains per gallon

psi = pounds per square inch
ppm = parts per million

5A. ELECTRICAL CONNECTIONS

IMPORTANT:

Keep this manual with your water softener. If repairs are needed, the service technician must have the information on the following pages. For telephone assistance, call toll free, 1-800-426-9345.

WIRING SCHEMATIC

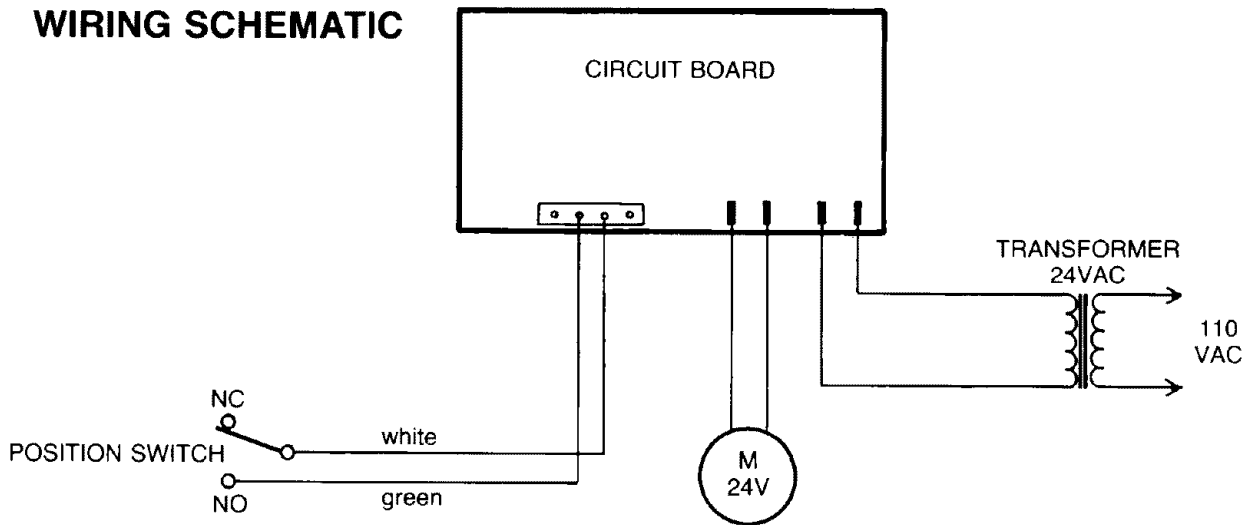

FACEPLATE TIMER

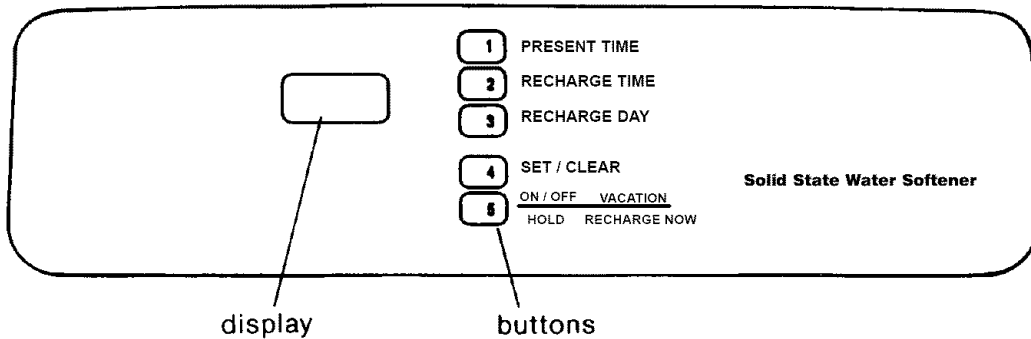

5B. REGENERATION CYCLE TIMES

SEE REGENERATION TABLE ON PAGE 20, AND SPECIFICATIONS, PAGE 21.

CYCLE FLOW RATES (GALLONS PER MINUTE)	
FILL (flow to salt storage tank)	0.1 (1.1 liters)
BRINING	.16 (.6 liters)
BRINE RINSE	.11 (.4 liters)
BACKWASH	1.8 (6.8 liters)
FAST RINSE	1.8 (6.8 liters)

} (flow to drain)

TO SET DOUBLE BACKWASH (Softener has a backwash and fast rinse cycle before brining, and after brining, which is beneficial on some kinds of iron bearing water):

USE BUTTONS **4** (SET/CLEAR), and **1** (PRESENT TIME AND DAY)

1. Press and *bold* **4** entire display comes on.
 - ▶ Press **1** to display 3 dashes
 - ▶ Press **4** to display **dbl**
 - ▶ Press **1** to display 18:88

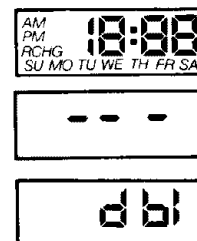

2. Press **4** to return present time.

REPEAT ABOVE STEPS **TO CANCEL** DOUBLE BACKWASH.

CYCLE SEQUENCE WITH DOUBLE BACKWASH: 1. Fill 2. Backwash 3. Fast Rinse 4. Brining/Brine Rinse 5. Backwash 6. Fast Rinse — Return to Service

OTHER RECHARGE CYCLE TIME ADJUSTMENTS

Cycle times in specifications are factory settings. Do the following to check for correct cycle times.

NOTE: Removing from electrical power (varies from 6 to 15 hours) resets timer to factory programming.

DISPLAY MUST SHOW TIME AND DAY

1. Press and *bold* **4** ...entire display comes on.



2. Press **2** ...2:08 shows; meaning #2 cycle (brining & br. rinse) and 80 minutes (8 x 10).

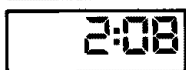

- a. If 2:08 **does** show, go to step 3.

- b. If other than 2:08 (2:00 to 2:15), press **4** until 2:08 shows.

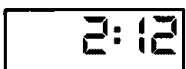

3. Press **2** ...3:12 shows, meaning #3 cycle (backwash) and 12 minutes.

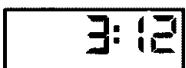

- a. If 3:12 **does** show, go to step 4.

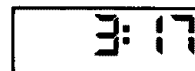

- b. If other than 3:12 (3:00 to 3:30), press **4** until 3:12 shows.

NOTE: Instead of programming a double backwash, a longer single backwash is beneficial on some types of iron water.

4. Press **2** ...4:04 shows; meaning #4 cycle (fast rinse) and 4 minutes.

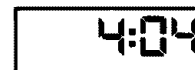

- a. If 4:04 **does** show, go to step 5.

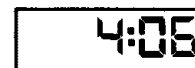

- b. If other than 4:04 (4:00 to 4:30), press **4** until 4:04 shows.



5. Press **2** ...18:88 shows.

6. Press **4** ...to return to present time and day.

TO SET MINUTE — LENGTH OF FILL CYCLE (factory setting, 16 minutes)

USE BUTTONS **2** (RECHARGE TIME), **4** (SET/CLEAR), and **1** (PRESENT TIME AND DAY)

1. Press and *bold* **2** until FILL shows, then 16 (factory setting).

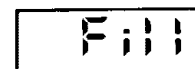

- ▶ Press **4** to set the desired fill minutes (from regeneration table).

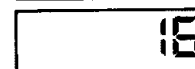

2. Press **1** to return present time and day.

5C. TROUBLESHOOTING

AUTOMATIC ELECTRONIC DIAGNOSTICS

The face plate has a self-diagnostic function for the electrical system (except input power). The face plate monitors the electronic components and circuits for correct operation. If a malfunction occurs, an error code appears in the face plate display.

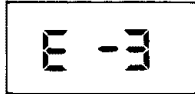

The chart below shows the error codes that could appear, and the possible defects for each code.

While an error code appears in the display, all face plate buttons are inoperable except the SET button. The SET button remains operational so the service person can make the MANUAL ADVANCE DIAGNOSTICS to further isolate the defect.

CODE	POSSIBLE DEFECT	
	MOST LIKELY	LESS LIKELY
E—1	motor inoperative / wiring harness or connection to switch / switch / face plate	
E—2, E—3	face plate	
E—4	face plate / position switch	

PROCEDURE FOR REMOVING ERROR CODE FROM FACE PLATE: 1. Unplug transformer 2. Correct defect 3. Plug-in transformer 4. Wait for 6 minutes. The error code will return if the defect was not corrected.

FACE PLATE REPLACEMENT: Be sure the valve is in service position (observe valve cycle indicator. . . see below) when replacing the face plate.

If, after installing and programming the replacement face plate, the valve is is not in service position, do the following to assure correct cycle orientation, or timing, between the face plate and valve.

Use the MANUAL ADVANCE procedures, below. With the RECHARGE NOW button, advance through the recharge cycles until the valve stops in service position, and RECHARGE no longer flashes in the timer.

NOTE: The valve motor may automatically drive through several valve positions while searching for service.

MANUAL ADVANCE DIAGNOSTIC

Use the following procedures to advance softener valve through regeneration cycles to check operation.

Remove top cover to observe valve rotation.

DISPLAY MUST SHOW TIME AND DAY

1. Press and *bold* [4] for 3 seconds until 18:88 displays. 
2. Press [3] to display position (P) switch open or closed indicator.

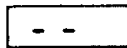
If the valve is in service, fill, brining, backwash or fast rinse (see markings on cam under motor), the display will show...(- -), meaning the position switch is open. 

While the valve is rotating from 1 cycle to another, the display will show (- P), meaning the position switch is closed.

3. To advance valve, press [5] each time you want to move into next cycle. (Pressing [5] while valve is rotating has no affect.)

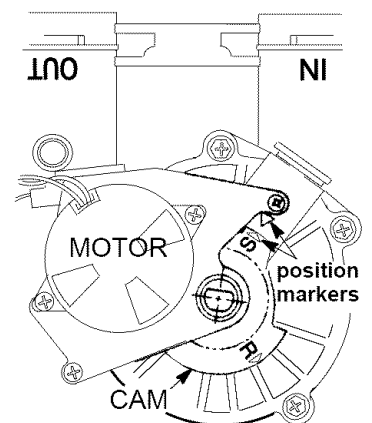

—Press and *bold* [5] for 3 seconds to move softener into fill cycle. Remove brinewell cover and, using a flashlight, observe fill water entering tank.

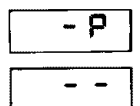

continued

5C. TROUBLESHOOTING

- a. If it **does not** move into fill, valve motor is inoperative. Check all wiring and connections.
- b. If water **does not** enter tank, see “Quick-Check Troubleshooting,” page 26.

— After fill, press [5] to move softener into brining. A slow flow of water to drain begins. Verify brine draw from brine tank. See flow rates on page 23.

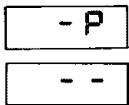

NOTE: WHILE IN MANUAL ADVANCE, THE TIME DISPLAY WILL AUTOMATICALLY RETURN TO THE PRESENT TIME IF A BUTTON IS NOT PRESSED WITHIN 4 MINUTES.

- c. If softener does not draw brine...see “Quick-Check Troubleshooting”.

NOTE: Be sure a salt bridge is not preventing water with salt contact.

—Again press [5] to move softener into backwash. Look for a fast flow of water from drain hose. See flow rates, page 23.

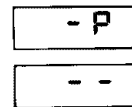

- d. An obstructed flow indicates a plugged top distributor, backwash flow plug, or drain hose.

—Press [5] to move softener into fast rinse. Again look for fast drain flow. Allow softener to rinse for a few minutes to flush out any brine remaining in resin tank from brining cycle test.

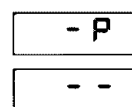

—To return softener to service, press [5].

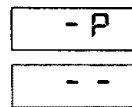

- 4. Press [3] to display 18:88.



- 5. Press [4] to return present time and day.

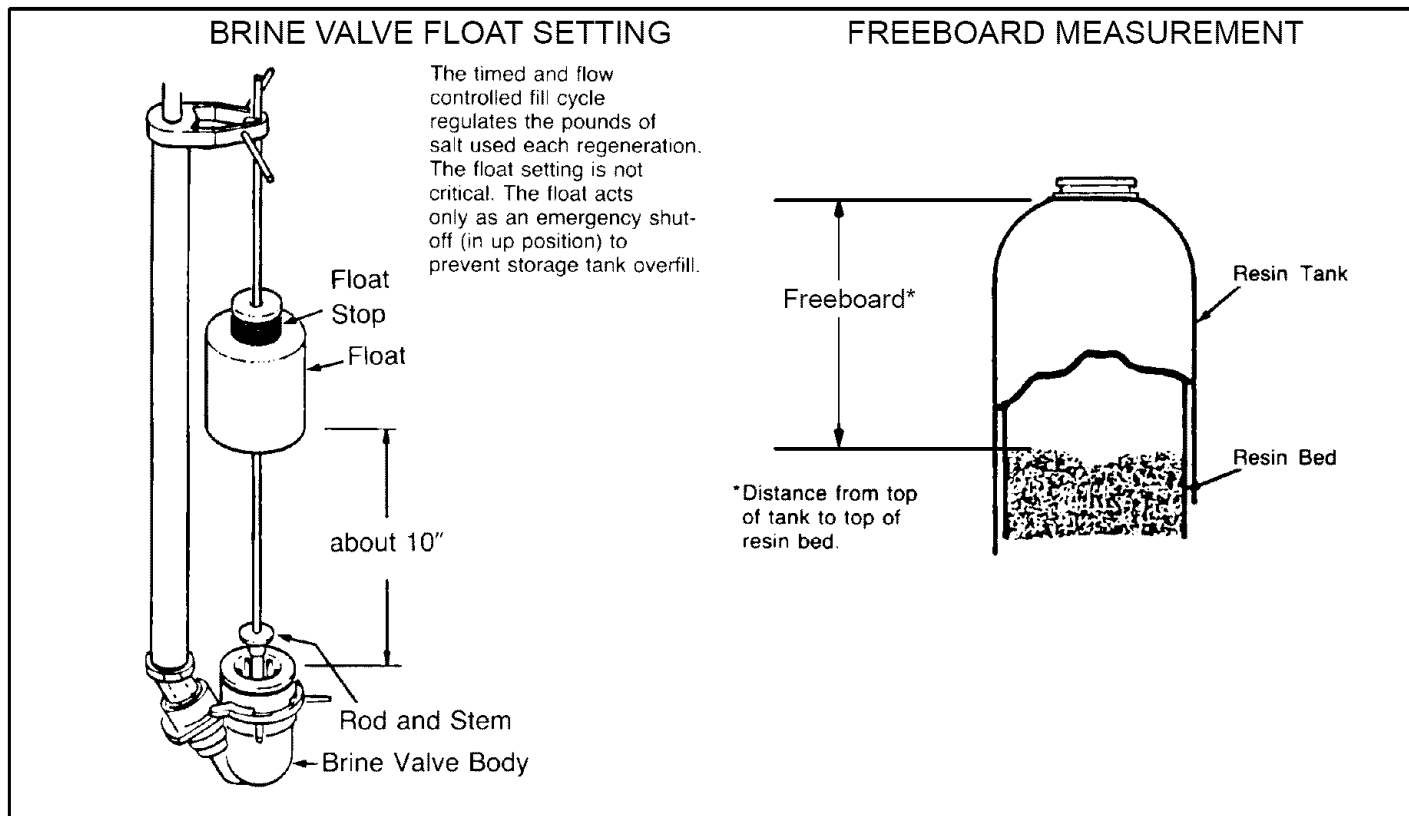
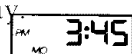

5C. TROUBLESHOOTING

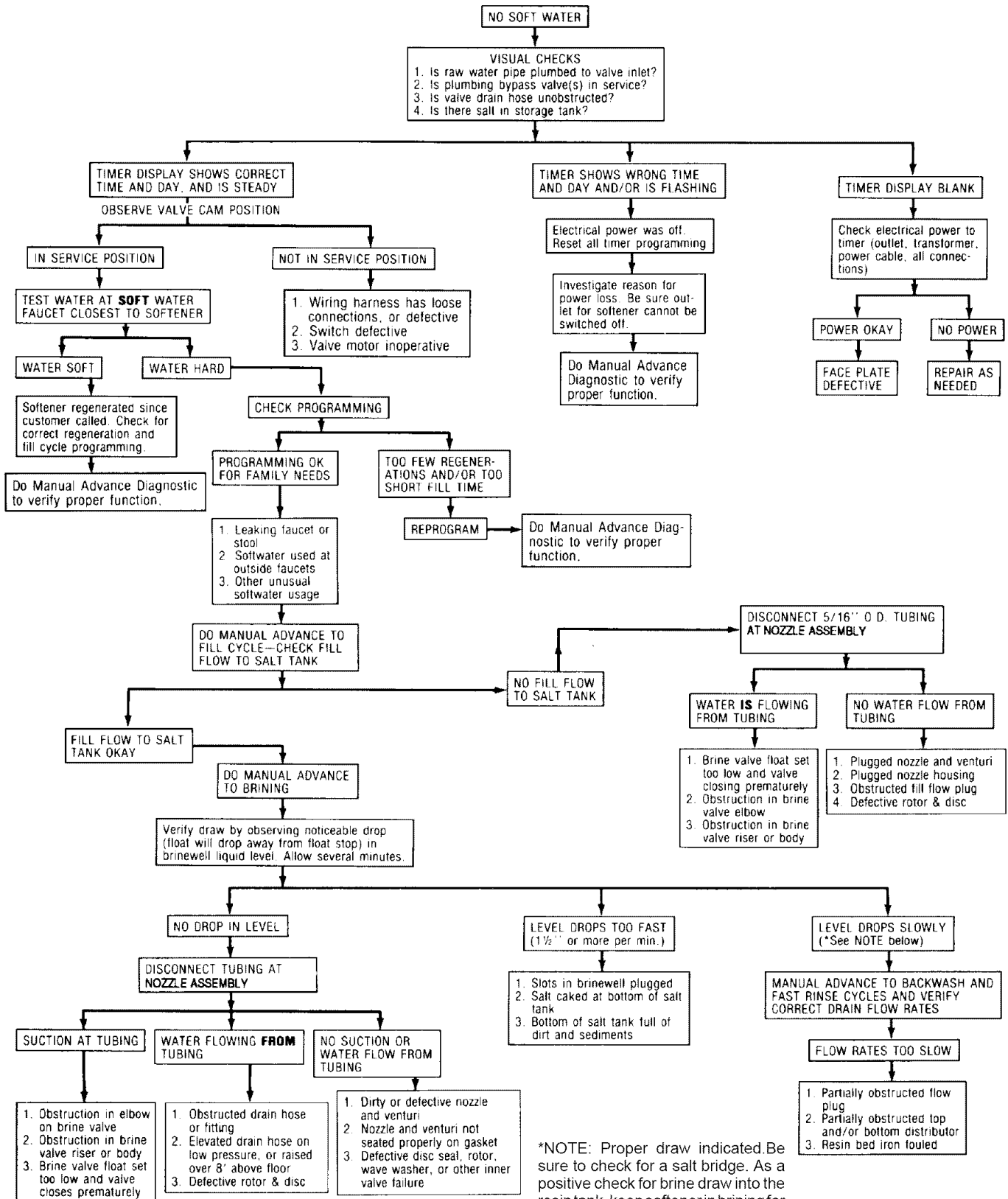

*NOTE: Proper draw indicated. Be sure to check for a salt bridge. As a positive check for brine draw into the resin tank, keep softener in brining for 20 minutes or more. Then, make a taste test for salt at the drain water.

5D. ROTARY VALVE SERVICE

Before working on the valve, **turn off the water supply** and **disconnect from electrical power**. **TO RELIEVE PRESSURE:**

— 3 VALVE BYPASS: Close the inlet valve and open a soft water faucet. Then close the outlet valve and open the bypass valve.

— SEARS SPECIAL BYPASS: Slide the bypass valve stem to bypass position. *Loosen* the 3 hex head screws (see A in drawing) toward the back side of the valve to allow pressure water to bleed out (catch water with a rag).

DISASSEMBLY

To remove a part or group of parts, refer to the valve drawing. A common screwdriver or nut driver, Phillips screwdriver and pliers are the only tools needed to completely disassemble.

SERVICING THE VALVE

Inspect all o-rings, seals and gaskets for wear or defects.

Inspect the bottom surface of the rotor and disc for scratches, chips or wear.

NOTE: If replacement is needed, be sure to use the current replacement part.

ASSEMBLY

Be sure all parts are in place and in the proper position. Lubricate ALL o-rings and seals with FDA approved silicone grease. To install the rotor seal, first place the seal into the valve groove, rounded side down (see cross-section). Apply a light coating of silicone grease to the seal's crossing ribs. Then, carefully center the wear strip on the seal, and push it downward onto the seal.

Install the nozzle and venturi seal and drain seal. Assemble 2 o-rings and the wave washer onto the rotor and disc. Then center the rotor and disc, in the valve body, on the rotor seal.

Lower the cover onto the valve body and rotor shaft. Then install the cover holding screws. **Before tightening the screws, install the valve cam and gear.** Then, **turn the rotor (clockwise only) to service position.** Tighten the screws using a criss-cross pattern. If a torque wrench is available, torque to 30-40 inch pounds.

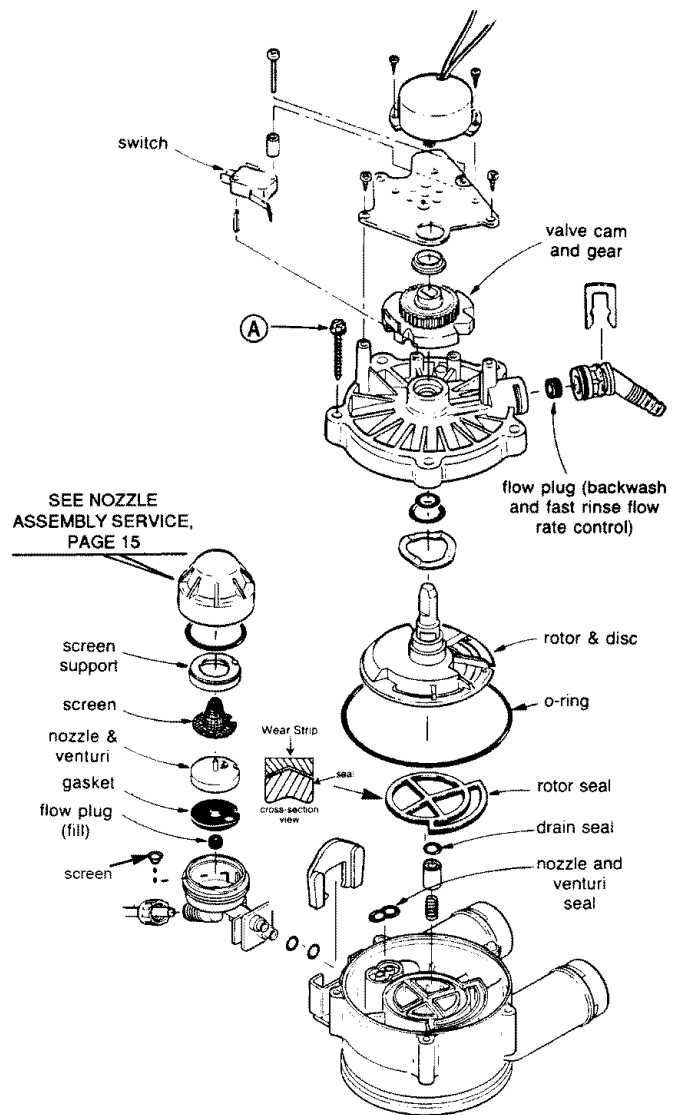

Lubricate the gear on the motor, and the valve cam gear with Molykote grease, or other high quality gear lubricant.

Be sure to orient switch as shown, with lever toward the cam.

5E. WATER FLOW THROUGH THE SOFTENER VALVE

SERVICE CYCLE

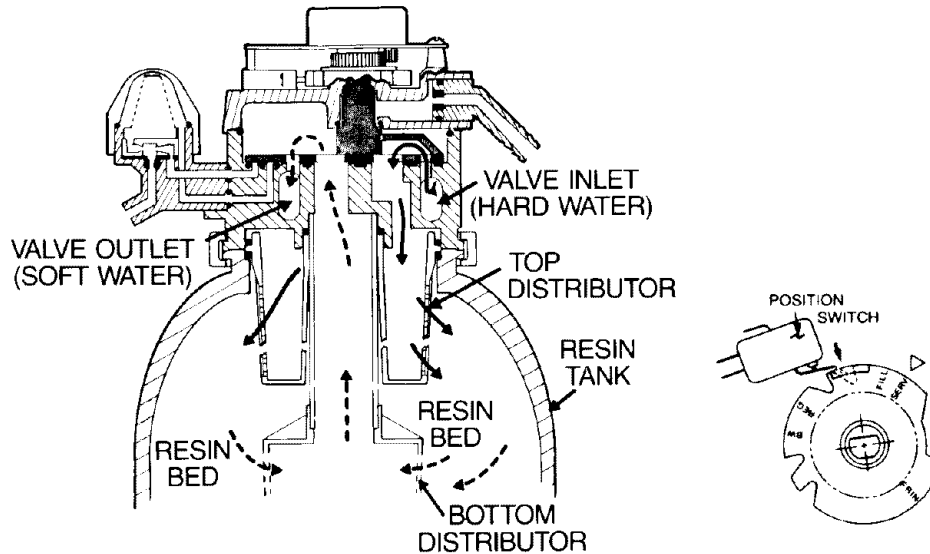

Hard water enters the valve inlet port. Internal valve porting routes the water down and out the top distributor, into the resin tank. Hard water is softened as it passes through the resin bed, then enters the bottom distributor. Soft water flows back into the valve and out the valve outlet, to the house soft water pipes.

FILL CYCLE

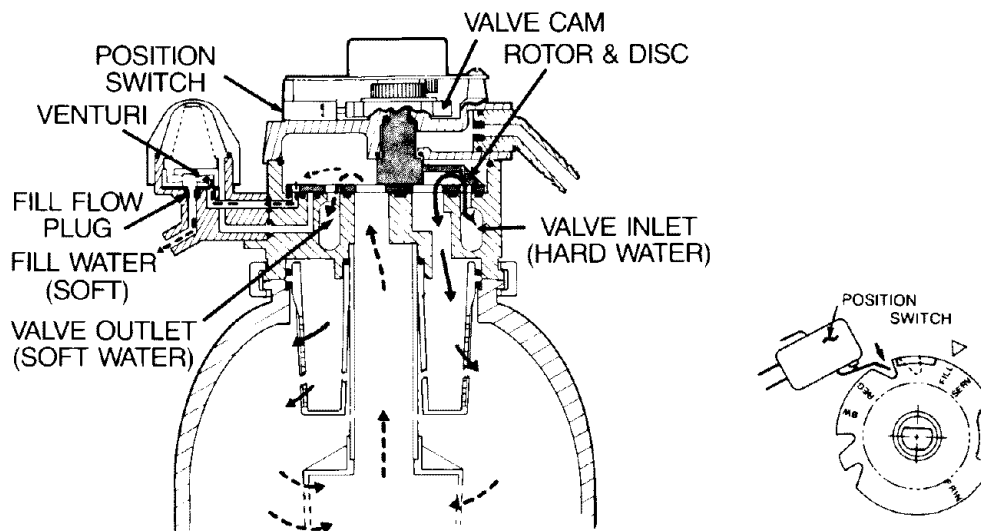

To begin a regeneration, the solid state timer energizes the circuit to the valve motor. The valve motor rotates the rotor and disc and the valve cam until the position switch lever drops to open the motor circuit and position the valve in FILL. As the rotor and disc rotates, the port opens for SOFT water fill through the venturi. Fill flow continues to the brine valve, and into the salt storage tank. Soft water is still available to the house lines.

5E. WATER FLOW THROUGH THE SOFTENER VALVE

BRINING AND BRINE RINSE CYCLES

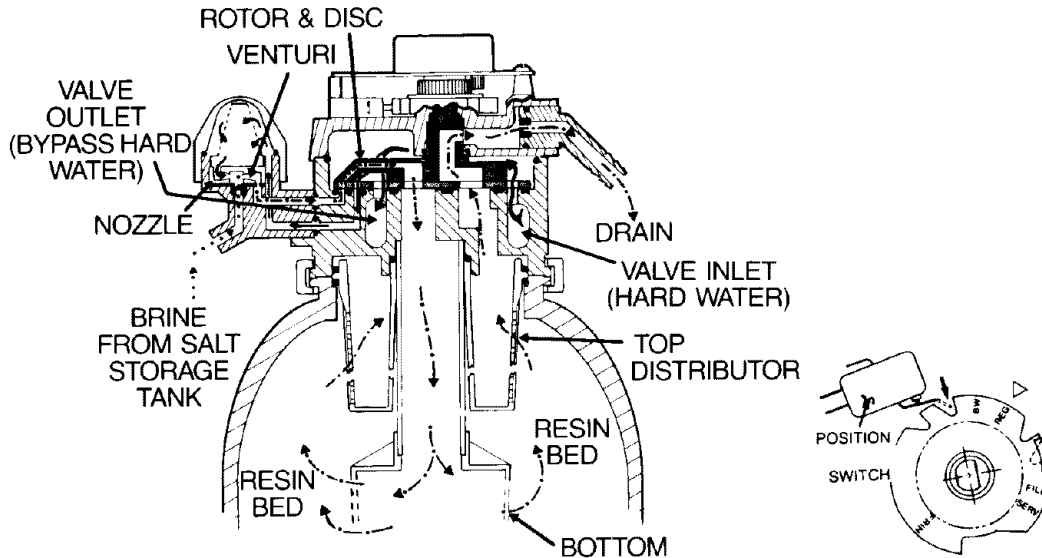

After fill, timer/switch action allows the motor to turn the rotor and disc into BRINING position. Water flow is directed to the nozzle. Suction, created by the nozzle and venturi, draws brine from the salt storage tank and injects it into the resin bed via the bottom distributor. Flow continues out the top distributor and to the drain. Hard water is available at the valve outlet.

When the brine valve closes to end brine draw, water flow continues in the same directions to slowly RINSE brine from the resin bed and to the drain.

BACKWASH CYCLE

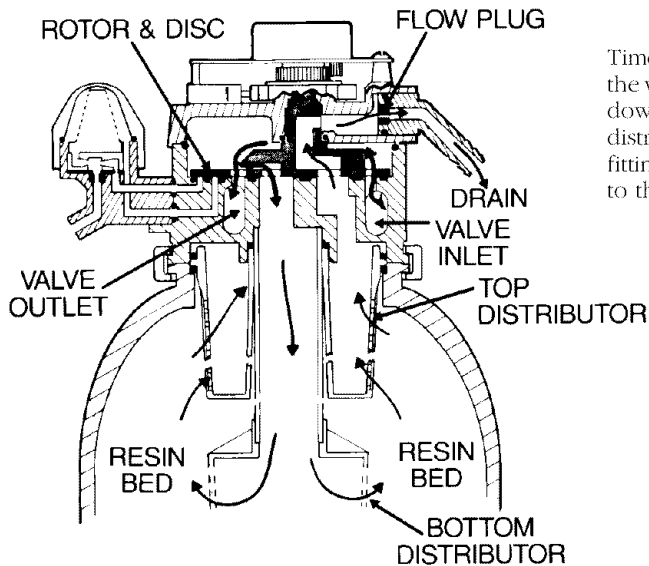

Timer/switch action again allows the motor to turn the rotor & disc to place the valve in BACKWASH, stopping water flow to the nozzle. Water is routed down and out the bottom distributor, up through the bed, and out the top distributor to the drain. The fast flow (controlled by a flow plug in the drain fitting) flushes dirt, sediments, iron deposits, remaining brine and hardness to the drain.

5E. WATER FLOW THROUGH THE SOFTENER VALVE

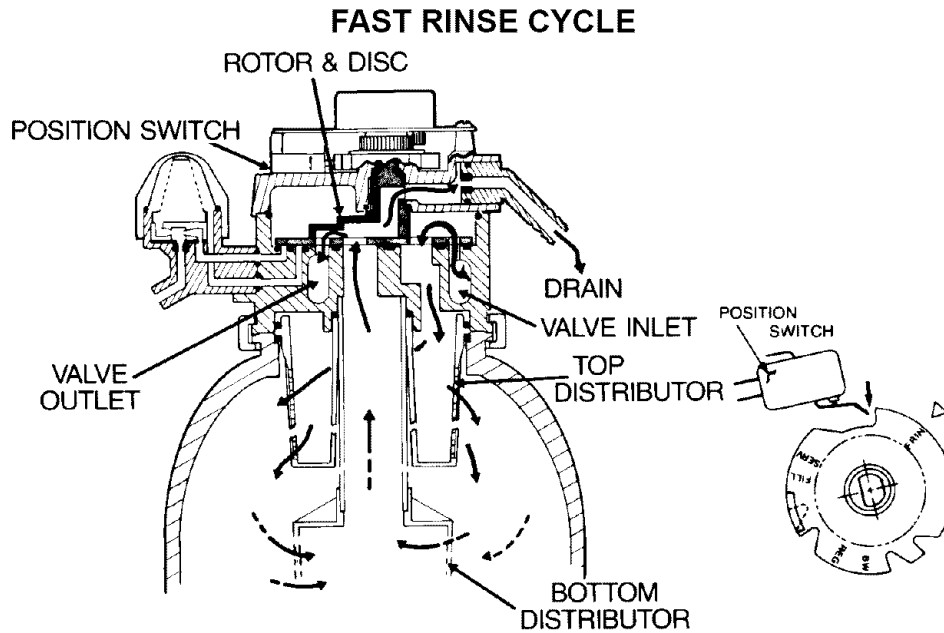

During FAST RINSE, the rotor & disc is positioned so water flow enters the resin tank through the top distributor, and exits through the bottom distributor, to the drain.

The solid state timer again energizes the motor to return the valve to service, and as the valve rotates, the position switch lever drops to open the circuit. The valve remains positioned in service until the timer initiates the next regeneration.

NOTES

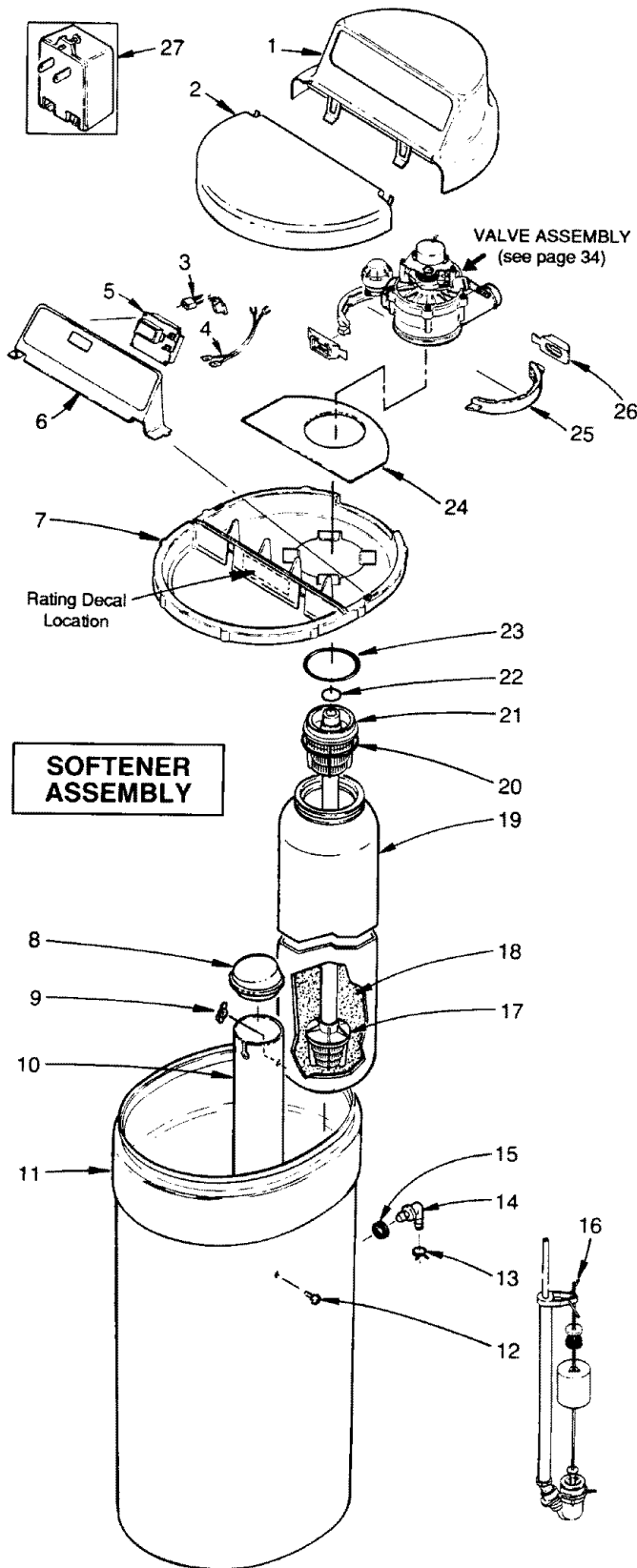

SEARS WATER SOFTENER MODEL NO. 625.348320

KEY NO.	PART NUMBER	DESCRIPTION
1	7137604	Cover (main)
2	7137612	Salt Hole Cover
3	7118333	Wire Harness (switch)
4	7084330	Power Cord (transformer)
5	7144978	Timer Repl. (PWA)
6	7137581	Face Plate (order decal below)
	7155872	Face Plate Decal
7	7137599	Rim
8	7137727	Brinewell Cover
9	7143964	Wing Nut, 1/4"
10	7100819	Brinewell
11	7144619	Salt Storage Tank
12	7143956	Screw, Plastic, 1/4" x 5/8"
13	0900431	Hose Clamp ●
14	1103200	Hose Adaptor ●
15	9003500	Grommet ●
16	7123689	Brine Valve Assy. (also see pg. 33)
17	7105047	Replacement Distributor
18	0501741	Resin
19	7092155	Resin Tank (incl. Key No. 18)
20	7096183	O-Ring, 2-3/4" x 3"
21	7077870	Top Distributor
22	0900215	O-Ring, 13/16" x 1-1/16"
23	7079092	O-Ring, 2-7/8" x 3-1/4"
24	7141001	Vapor Barrier
25	7088041	Clamp Section (2 req.)
26	7088033	Clamp Retainer (2 req.)
27	7095373	Transformer, 24V-10VA ●
◆	7155931	Installation Manual
◆	7155903	Owners Manual

◆ not illustrated

● Included in parts bag...see page 35.

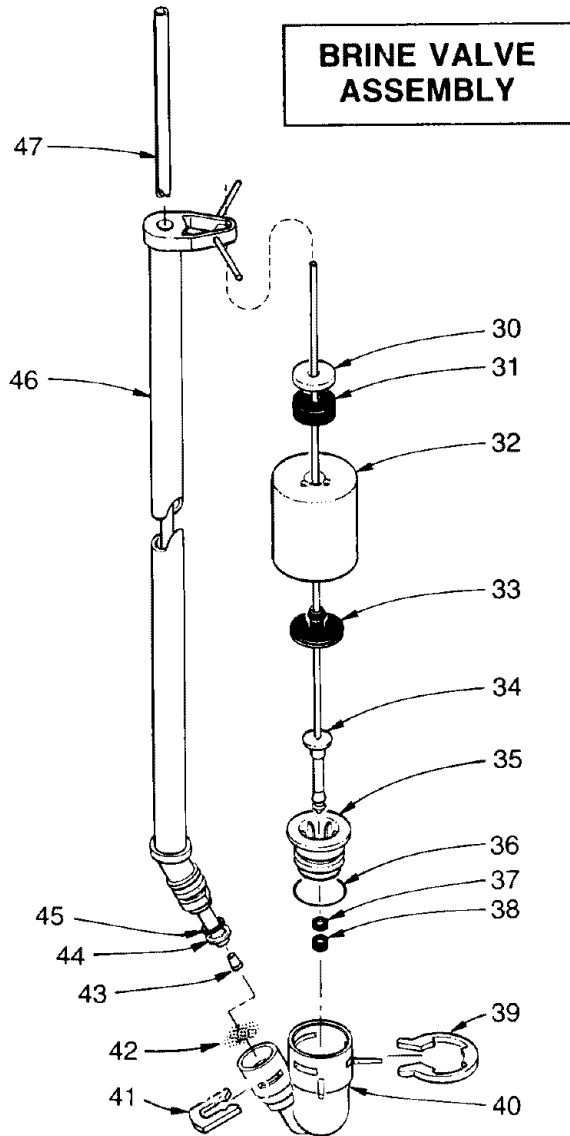

SEARS WATER SOFTENER MODEL NO. 625.348320

KEY NO.	PART NUMBER	DESCRIPTION
30	0505957	Lead Washer
31	0513860	Float Stop
32	7097202	Float (Includes Key No. 33)
33	0516947	Float Seal
34	7093216	Float Rod & Stem
35	7092278	Guide Cap
36	0900535	O-Ring 15/16 x 1-3/16
37	0516211	Seal
38	0516924	Retainer, Bottom Seal
39	7116713	Clip
40	7092252	Brine Valve Body
41	7080653	Clip
42	7131365	Screen
43	7094979	Insert
44	7092294	Retaining Ring
45	7092286	O-Ring, 5/16 x 9/16
46	7095470	Brine Tube
47	7113016	Tubing Assembly (Includes Key Nos. 43, 44 & 45)
48	7112997	Ground Clamp Kit ●

● Included in small parts bag...see page 35.

INLET - OUTLET GROUNDING CLAMPS

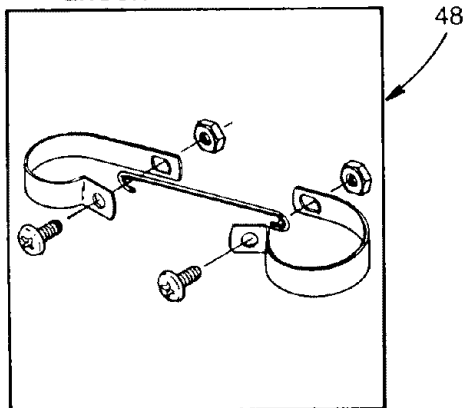

SEARS WATER SOFTENER
MODEL NO. 625.348320

VALVE ASSEMBLY

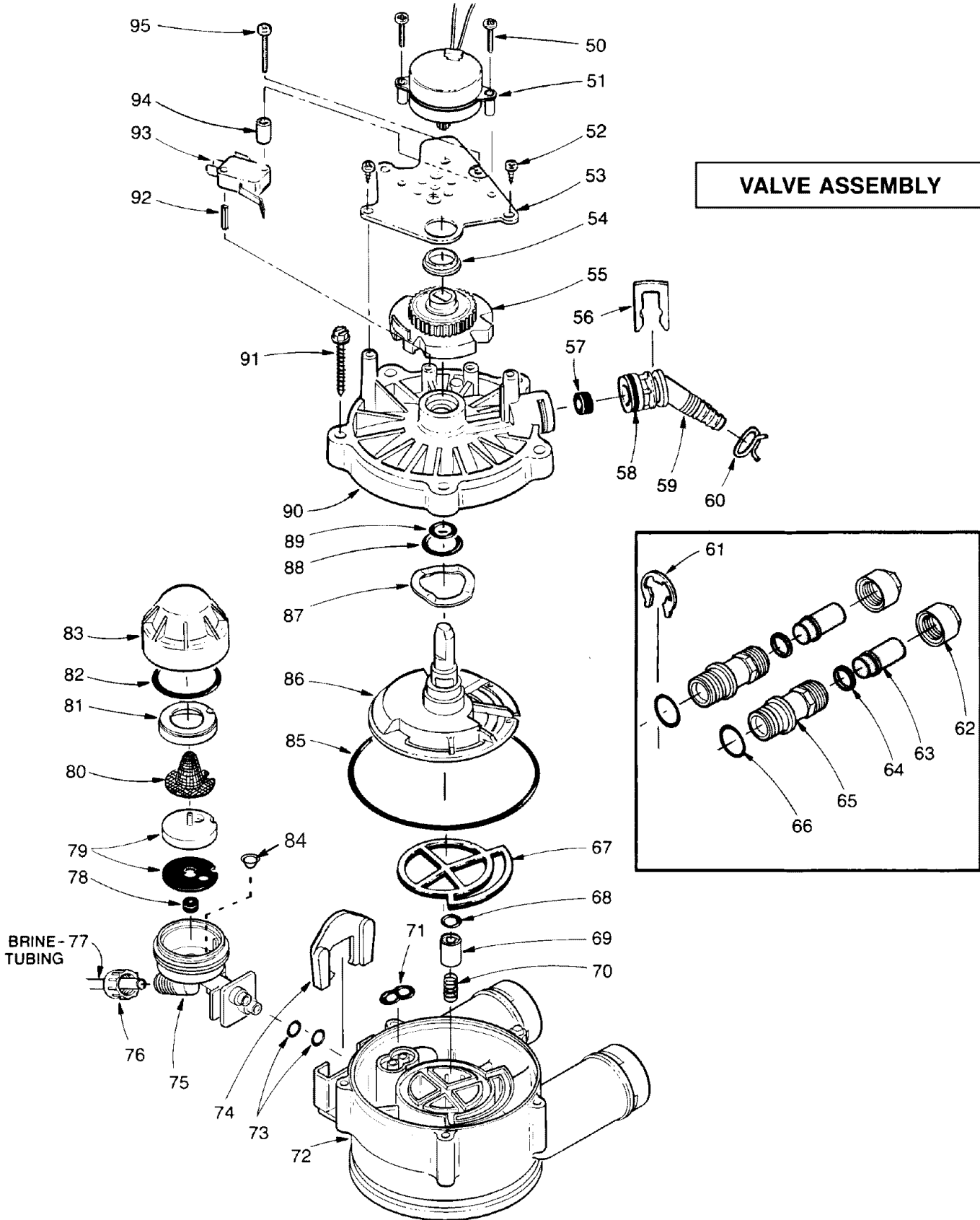

SEARS WATER SOFTENER MODEL NOS. 625.348320 PARTS LIST

KEY NO.	PART NUMBER	DESCRIPTION
50	7131755	Screw, #6-20 x 7/8 (2 req.)
51	7133008	Motor (incl. 2 ea. of Key No. 50)
52	0900857	Screw, #6-20 x 3/8 (2 req.)
53	7117808	Motor Plate
54	0503288	Bearing
55	7113918	Cam and Gear
56	7142942	Clip (Drain)
57	0501228	Flow Plug
58	0900041	O-Ring, 5/8 x 13/16
59	7024160	Drain Hose Adaptor
60	0900431	Hose Clamp ●
61	7116713	Clip (2 req.) ●
62	0507369	Installation Nut (2 req.) ☐
63	0507615	Installation Tube (2 req.) ☐
64	0900570	Washer (2 req.) ☐
◆	42-3441	Installation Kit (includes Key Nos. 62, 63 & 64) ☐
65	2207800	Installation Adaptor (2 req.) ●
66	0900535	O-Ring, 15/16 x 1-3/16 (2 req.) ●
67	7134224	Rotor Seal
68	7092634	O-Ring, 3/8 x 9/16
69	7092642	Plug (Drain Seal)
70	7129889	Spring
71	7081764	Seal (Nozzle & Venturi)
72	7082053	Valve Body
73	0900064	O-Ring, 1/4 x 3/8 (2 req.)
74	7081201	Retainer (Nozzle & Venturi)
75	7081104	Nozzle & Venturi Housing
76	1202600	Nut — Ferrule
77	7089267	Tubing
78	0521829	Flow Plug, .1 gpm

KEY NO.	PART NUMBER	DESCRIPTION
79	7113024	Nozzle and Venturi — Gasket Kit
80	7146043	Screen
81	7089893	Screen Support
82	7039068	O-Ring, 3/8 x 1-3/8
83	7081188	Cap
84	7095030	Cone Screen
85	9001006	O-Ring, 3-3/8 x 3-5/8
86	7103964	Rotor & Disc
87	7082087	Wave Washer
88	7064372	O-Ring, 3/4 x 15/16
89	7064380	O-Ring, 7/16 x 5/8
90	7085263	Valve Cover
91	7074123	Screw, #10-14 x 2 (5 req.)
92	7077472	Expansion Pin
93	7030713	Switch
94	7117816	Spacer
95	7070412	Screw, #4-24 x 1-1/8 (flat head)
◆	7085239	Nozzle & Venturi Assy. (includes Key Nos. 75, and 78 through 84)
◆	7144813	Parts Bag, (includes parts marked with a ●, pages 32, 33 & 35) — order manuals separately, if needed.
◆	7129716	Seal Kit (includes Key Nos. 67, 68, 71, 85, 88 and 89)
◆	42-3433	Drain Hose, 3/8" I.D. x 20' ☐

◆ not illustrated

☐ PARTS NOT INCLUDED WITH MODEL NO. 625.348320, available from Sears.

SEARS

OWNERS MANUAL

**MODEL NO.
625.348320**

The model number of your water softener is found on the rating decal. This decal is on the rim, under the salt cover.

When requesting service or ordering parts, always provide the following information:

- ◆ Product Type
- ◆ Model Number
- ◆ Part Number
- ◆ Part Description

SOLID STATE

WATER SOFTENER

For the repair or replacement parts you need

Call 7 am – 7 pm, 7 days a week

1 – 800 – 366 – PART

(1 – 800 – 366 – 7278)

For in-home major brand repair service

Call 24 hours a day, 7 days a week

1 – 800 – 4 – REPAIR

(1 – 800 – 473 – 7247)

**For the location of a
Sears Repair Service Center in your area**

Call 24 hours a day, 7 days a week

1 – 800 – 488 – 1222

**For information on purchasing a Sears
Maintenance Agreement, or to inquire
about an existing Agreement**

Call 9 am – 5 pm, Monday – Saturday

1 – 800 – 827 – 6655