

SHARP®

LC-20SH7U

LIQUID CRYSTAL TELEVISION
TÉLÉVISEUR ACL
TELEVISOR CON PANTALLA
DE CRISTAL LÍQUIDO

OPERATION MANUAL
MODE D'EMPLOI
MANUAL DE OPERACIÓN



ENGLISH

FRANÇAIS

ESPAÑOL



LC-20SH7U

LIQUID CRYSTAL TELEVISION

ENGLISH

OPERATION MANUAL

- The illustrations and on-screen displays in this operation manual are for explanation purposes and may vary slightly from the actual operations.

IMPORTANT:

To aid reporting in case of loss or theft, please record the TV's model and serial numbers in the space provided. The numbers are located at the rear of the TV.

Model No.:

Serial No.:

INTRODUCTION

WARNING: TO REDUCE THE RISK OF FIRE OR ELECTRIC SHOCK, DO NOT EXPOSE THIS APPLIANCE TO RAIN OR MOISTURE.



CAUTION
RISK OF ELECTRIC SHOCK
DO NOT OPEN



CAUTION: TO REDUCE THE RISK OF ELECTRIC SHOCK, DO NOT REMOVE COVER (OR BACK). NO USER SERVICEABLE PARTS INSIDE. REFER SERVICING TO QUALIFIED SERVICE PERSONNEL.



THIS SYMBOL INDICATES THAT DANGEROUS VOLTAGE CONSTITUTING A RISK OF ELECTRIC SHOCK IS PRESENT WITHIN THIS UNIT.



THIS SYMBOL INDICATES THAT THERE ARE IMPORTANT OPERATING AND MAINTENANCE INSTRUCTIONS IN THE LITERATURE ACCOMPANYING THE APPLIANCE.

The important note is located on the rear of the cabinet.

Important Safeguards

1. **READ INSTRUCTIONS** - All the safety and operating instructions should be read before the appliance is operated.
2. **RETAIN INSTRUCTIONS** - The safety and operating instructions should be retained for future reference.
3. **HEED WARNINGS** - All warnings on the appliance and in the operating instructions should be adhered to.
4. **FOLLOW INSTRUCTIONS** - All operating and use instructions should be followed.
5. **CLEANING** - Unplug TV from the wall outlet before cleaning. Do not use liquid cleaners or aerosol cleaners. Use a damp cloth for cleaning.
EXCEPTION: A product that is meant for uninterrupted service and, that for some specific reason, such as the possibility of the loss of an authorization code for a CATV converter, is not intended to be unplugged by the user for cleaning or any other purpose, may exclude the reference to unplugging the appliance in the cleaning description otherwise required in item 5.

6. **ATTACHMENTS** - Do not use attachments not recommended by the TV manufacturer as they may cause hazards.
7. **WATER AND MOISTURE** - Do not use this TV near water, for example, near a bath tub, wash bowl, kitchen sink, or laundry tub, in a wet basement, or near a swimming pool, and the like.

8. **ACCESSORIES** - Do not place this TV on an unstable cart, stand, tripod, bracket, or table. The TV may fall, causing serious injury to someone, and serious damage to the appliance. Use only with a cart, stand, tripod, bracket, or table recommended by the manufacturer, or sold with the TV.
Any mounting of the appliance should follow the manufacturer's instructions and should use a mounting accessory recommended by the manufacturer. An appliance and cart combination should be moved with care. Quick stops, excessive force, and uneven surfaces may cause the appliance and cart combination to overturn.



9. **VENTILATION** - Slots and openings in the cabinet and the back or bottom are provided for ventilation and to ensure reliable operation of the TV and to protect it from overheating, these openings must not be blocked or covered. The openings should never be blocked by placing the TV on a bed, sofa, rug, or other similar surface. This TV should never be placed near or over a radiator or heat register. This TV should not be placed in a built-in installation such as a bookcase or rack unless proper ventilation is provided or the manufacturer's instructions have been adhered to.

10. **POWER SOURCES** - This TV should be operated only from the type of power source indicated on the marking label. If you are not sure of the type of power supply to your home, consult your appliance dealer or local power company. For TVs intended to operate from battery power, or other sources, refer to the operating instructions.

11. **GROUNDING OR POLARIZATION** - This TV is equipped with a polarized alternating-current line plug (a plug having one blade wider than the other). This plug will fit into the power outlet only one way. This is a safety feature. If you are unable to insert the plug fully into the outlet, try reversing the plug. If the plug should still fail to fit, contact your electrician to replace your obsolete outlet. Do not defeat the safety purpose of the polarized plug.

12. **POWER-CORD PROTECTION** - Power-supply cords should be routed so that they are not likely to be walked on or pinched by items placed upon or against them, paying particular attention to cords at plugs, convenience receptacles, and the point where they exit from the appliance.

13. **OUTDOOR ANTENNA GROUNDING** - If an outside antenna or cable system is connected to the TV, be sure the antenna or cable system is grounded so as to provide some protection against voltage surges and built-up static charges. Article 810 of the National Electrical Code, ANSI/NFPA No. 70, provides information with respect to proper grounding of the mast and supporting structure, grounding of the lead-in wire to an antenna discharge unit, size of grounding conductors, location of antenna-discharge unit, connection to grounding electrodes, and requirements for the grounding electrode. (Fig. A)

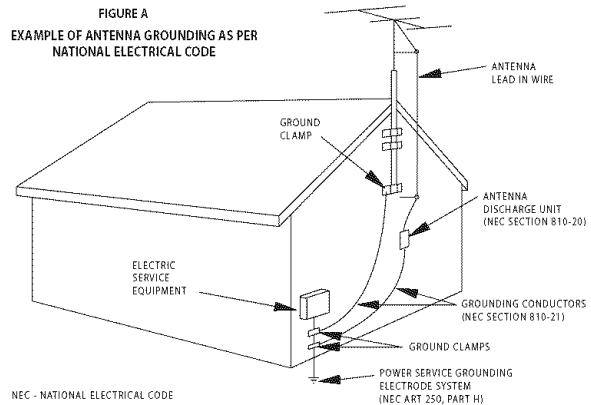

14. **LIGHTNING** - For added protection for this TV receiver during a lightning storm, or when it is left unattended and unused for long periods of time, unplug it from the wall outlet and disconnect the antenna or cable system. This will prevent damage to the TV due to lightning and power-line surges.
15. **POWER LINES** - An outside antenna system should not be located in the vicinity of overhead power lines or other electric light of power circuits, or where it can fall into such power lines or circuits. When installing an outside antenna system, extreme care should be taken to keep from touching such power lines or circuits as contact with them might be fatal.
16. **OVERLOADING** - Do not overload wall outlets and extension cords as this can result in a risk of fire or electric shock.
17. **OBJECT AND LIQUID ENTRY** - Never push objects of any kind into this TV through openings as they may touch dangerous voltage points or short out parts that could result in a fire or electric shock. Never spill liquid of any kind on the TV.
18. **SERVICING** - Do not attempt to service this TV yourself as opening or removing covers may expose you to dangerous voltage or other hazards. Refer all servicing to qualified service personnel.
19. **DAMAGE REQUIRING SERVICE** - Unplug this TV from the wall outlet and refer servicing to qualified service personnel under the following conditions:
 - a. When the power supply cord or plug is damaged or frayed.
 - b. If liquid has been spilled, or objects have fallen into the TV.
 - c. If the TV has been exposed to rain or water.
 - d. If the TV does not operate normally by following the operating instructions. Adjust only those controls that are covered by the operating instructions, as improper adjustment of other controls may result in damage and will often require extensive work by a qualified technician to restore the TV to its normal operation.
 - e. If the TV has been dropped or damaged in any way.
 - f. When the TV exhibits a distinct change in performance, this indicates a need for service.
20. **REPLACEMENT PARTS** - When replacement parts are required, be sure the service technician uses replacement parts specified by the manufacturer that have the same characteristics as the original part. Unauthorized substitutions may result in fire, electric shock, injury to persons or other hazards.
21. **SAFETY CHECK** - Upon completion of any service or repairs to this TV, ask the service technician to perform routine safety checks to determine that the TV is in proper operating condition.
22. **HEAT** - This TV product should be situated away from heat sources such as radiators, heat registers, stoves, or other products (including amplifiers) that produce heat.

✓ **Precautions**

Dear Sharp Customer

Thank you for your purchase of the Sharp Liquid Crystal Television. To ensure safety and many years of trouble-free operation of your product, please read the Important Safeguards carefully before using this product.

CAUTION:

DO NOT PLACE THIS PRODUCT ON AN UNSTABLE CART, STAND, TRIPOD, BRACKET, OR TABLE. THE PRODUCT MAY FALL CAUSING SERIOUS PERSONAL INJURY AND SERIOUS DAMAGE TO THE PRODUCT. USE ONLY WITH A CART, STAND, TRIPOD, BRACKET, OR TABLE RECOMMENDED BY THE MANUFACTURER OR SOLD WITH THE PRODUCT. FOLLOW THE MANUFACTURER'S INSTRUCTIONS WHEN INSTALLING THE PRODUCT AND USE MOUNTING ACCESSORIES RECOMMENDED BY THE MANUFACTURER. A PRODUCT AND CART COMBINATION SHOULD BE MOVED WITH CARE. QUICK STOPS, EXCESSIVE FORCE, AND UNEVEN SURFACES MAY CAUSE THE PRODUCT AND CART COMBINATION TO OVERTURN.



WARNING: FCC Regulations state that any unauthorized changes or modifications to this equipment not expressly approved by the manufacturer could void the user's authority to operate this equipment.

CAUTION: This product satisfies FCC regulations when shielded cables and connectors are used to connect the unit to other equipment. To prevent electromagnetic interference with electric appliances such as radios and televisions, use shielded cables and connectors for connections.

This product utilizes tin-lead solder, and fluorescent lamp containing a small amount of mercury. Disposal of these materials may be regulated due to environmental considerations. For disposal or recycling information, please contact your local authorities or the Electronic Industries Alliance: www.eia.org

CAUTION: TO PREVENT ELECTRIC SHOCK, MATCH WIDE BLADE OF PLUG TO WIDE SLOT, FULLY INSERT.

FCC WARNING This equipment may generate or use radio frequency energy. Changes or modifications to this equipment may cause harmful interference unless the modifications are expressly approved in the manual. The user could lose the authority to operate this equipment if an unauthorized change or modification is made.

RADIO-TV INTERFERENCE

This equipment has been tested and found to comply with the limits for a Class B digital device, pursuant to Part 15 of the FCC Rules. These limits are designed to provide reasonable protection against harmful interference in a residential installation. This equipment generates, uses, and can radiate radio frequency energy and, if not installed and used in accordance with the instructions, may cause harmful interference to radio communications. However, there is no guarantee that interference will not occur in a particular installation. If this equipment does cause harmful interference to radio or television reception, which can be determined by turning the equipment off and on, the user is encouraged to try to correct the interference by one or more of the following measures:

- 1) Reorient or relocate the receiving antenna.
- 2) Increase the separation between the equipment and receiver.
- 3) Connect the equipment into an outlet on a circuit different from that to which the receiver is connected.
- 4) Consult the dealer or an experienced radio/TV technician for help.

This Class B digital apparatus complies with Canadian ICES-003.

Note to CATV system installer:

This reminder is provided to call the CATV system installer's attention to Article 820-40 of the NEC that provides guidelines for proper grounding and, in particular, specifies that the cable ground should be connected to the grounding system of the building as close to the point of cable entry as practical.



Manufactured under license from Dolby Laboratories. "Dolby" and the double-D symbol are trademarks of Dolby Laboratories.



Product that have earned ENERGY STAR® are designed to protect the environment through superior energy efficiency.

INTRODUCTION

- Selecting the location — Select a place with no direct sunlight and good ventilation.

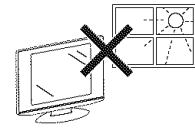

- The Liquid Crystal panel used in this product is made of glass. Therefore, it can break when the product is dropped or applied with impact. Be careful not to be injured by broken glass pieces in case the panel breaks.

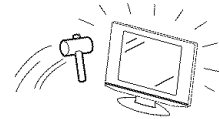

- The Liquid Crystal panel is a very high technology product with 921,600 thin film transistors, giving you fine picture details. Occasionally, a few non-active pixels may appear on the screen as a fixed point of blue, green or red. Please note that this does not affect the performance of your product.

- To prevent fire, never place any type of candle or flames on the top or near the TV set.

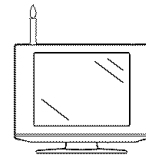

- To prevent fire or shock hazard, do not expose this product to dripping or splashing. No objects filled with liquids, such as vases, should be placed on the product.

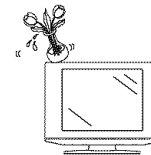

- Turn off the main power and unplug the AC cord from the wall outlet before handling.
- Use a soft cloth and gently wipe the surface of the display panel. Using a hard cloth may scratch the panel surface.
- Use a soft damp cloth to gently wipe the panel when it is really dirty. (It may scratch the panel surface when wiped strongly.)
- If the panel is dusty, use an anti-static brush, which is commercially available, to clean it.
- To protect the panel, do not use a dirty cloth, liquid cleaners or chemical cloth to clean it, such materials may damage the panel surface.
- To clean the outer cabinet, use the same method. Do not use liquid or aerosol cleaners.

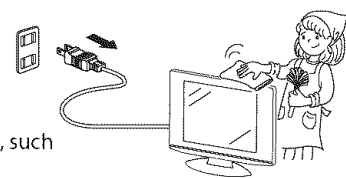

- Do not display a still picture for a long time, as this could cause an afterimage to remain.

- Install the product on the place where the AC cord can be unplugged easily from the AC outlet.

LOCATION

For safe operation and satisfactory performance of the unit, keep the following in mind when selecting a place for its installation:

- Shield it from direct sunlight and keep it away from sources of intense heat.
- Avoid dusty or humid places.
- Avoid places with insufficient ventilation for proper heat dissipation. Do not block the ventilation holes at the top and bottom of the unit. Do not place the unit on a carpet because this will block the ventilation holes.
- Install the unit in a horizontal position.
- Avoid locations subject to strong vibration.
- Do not place the unit near strong magnetic fields.
- Avoid moving the unit to locations where temperature differences are extreme.
- Be sure to unplug the AC power cord from the outlet before carrying the unit.

TO AVOID THE HAZARDS OF ELECTRICAL SHOCK AND FIRE

- Do not handle the power cord with wet hands.
- Do not pull on the power cord when disconnecting it from an AC outlet. Grasp it by the plug.
- If, by accident, water is spilled on the unit, unplug the power cord immediately and take the unit to our authorized service center for servicing.
- Do not place anything directly on top of the unit.

✓ **Features**

- **DTV/TV/CATV**
- You can use your remote control to select channels which are broadcast in digital, conventional analog, standard definition, and high definition formats. Also, cable subscribers can access their cable TV channels.
- **Program Information Display (DTV only)**
- You can display the title, contents and other information of the current DTV program on the TV screen.
- **Auto Channel Scan**
- This unit automatically scans and memorizes channels available in your area, eliminating difficult setup procedures.
- **V-chip**
- This feature allows you to block children's access to inappropriate programs.
- **Closed Caption Decoder**
- Built-in closed caption decoder displays text for closed caption supported programming.
- **MTS/SAP Tuner**
- Audio language can be selected from the remote control.
- **Auto Shut Off Function**
- If there is no signal input from the antenna terminal for 5 minutes or no operation for 180 minutes, the unit will turn itself off automatically if these setting are on.
- **Sleep Timer**
- This feature will automatically turned off the power of the unit at a specific time.
- **Choices for On-screen Language**
- Select your on-screen language:
English, Spanish or French.
- **Stereo Sound Function**
- **PLL Frequency Synthesized Tuning**
- Provides free and easy channel selection and lets you tune directly to any channel using the channel number buttons on the remote control.
- **Component Video Input**
- **S-video Input**
- **AV Input**
- **Digital Audio Coaxial Output**
- **Blue Screen**

✓ **Contents**

INTRODUCTION

Important Safeguards	2
Precautions	3
Features	5
Supplied Accessories	6
Installing the Batteries	6
Tilt Stand	6
Symbols Used in this Manual	6
Remote Control Function	7
Control Panel	8
Rear Panel	8

CONNECTION

Basic Connection	9
External Device Connection	10

INITIAL SETTING

Initial Setup	12
Main Menu	13
Auto Channel Scan	13
Language Selection	14

WATCHING TV

Channel Selection	15
Volume Adjustment	15
Switching Each Mode	16
Switching Audio Mode	16
Screen Information	17
TV Screen Display Mode	18
Sleep Timer	18

OPTIONAL SETTING

Channel Add/Delete	19
Picture Adjustment	20
Closed Caption	20
DTV Closed Caption	21
DTVCC Style	22
Back Light Setting	23
Blue Screen	23
No Signal Off	24
No Operation Off	24
Color Temperature	25
V-chip	25

TROUBLESHOOTING

Troubleshooting Guide	28
-----------------------------	----

INFORMATION

Glossary	30
Cable Channel Designations	30
General Specifications	30
Electrical Specification	30
Other Specifications	30
Calling for Service	31
Limited Warranty	31

Dimensional drawings

- The dimensional drawings for the LCD TV set are shown on the inside back cover.

✓ **Supplied Accessories**

operation manual

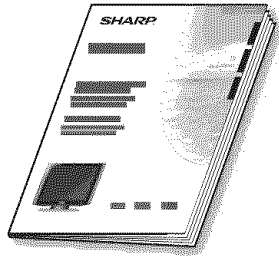

remote control



batteries (AA size x2)

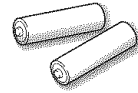

- If you need to replace these accessories, please call our customer support line found on the warranty pages in this manual.
- Depending on your antenna system, you may need different types of combiners (mixers) or separators (splitters). Contact your local electronics store for these items.

✓ **Installing the Batteries**

Install the batteries (AA x 2) matching the polarity indicated inside battery compartment of the remote control.

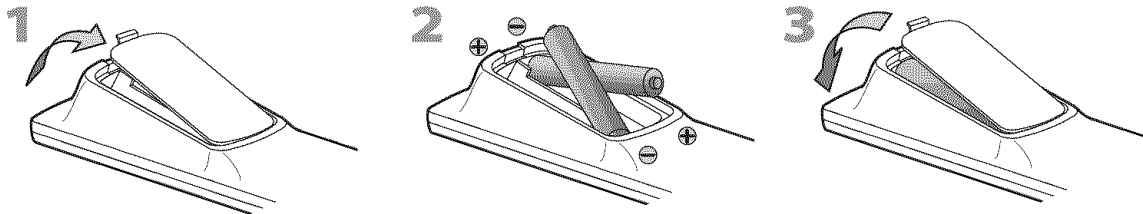

Battery Precautions:

- Be sure to follow the correct polarity as indicated in the battery compartment. Reversed batteries may cause damage to the device.
- Do not mix different types of batteries together (e.g., Alkaline and Carbon-Zinc) or old batteries with fresh ones.
- If the device is not to be used for a long period of time, remove the batteries to prevent damage or injury from possible battery leakage.
- Do not try to recharge batteries; they can overheat and rupture.

✓ **Tilt Stand**

You can adjust the stand to change the angle of the TV (-2.5° to 10°).

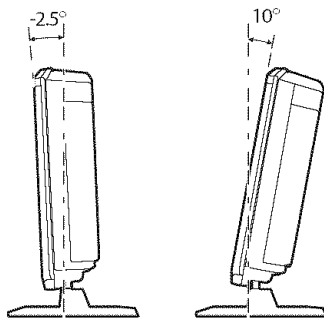

✓ **Symbols Used in this Manual**

The following is the description for the symbols used in this manual.

Description refers to:

DTV : Digital TV operation

TV : Analog TV operation

- If neither symbol appears under the function heading, operation is applicable to both.

✓ Remote Control Function

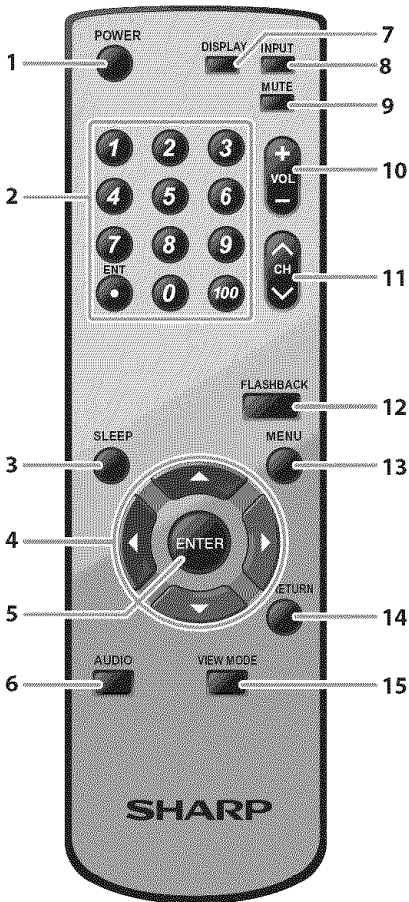

1. **POWER button** (p12)
Press to turn the unit on and off.
2. **Number buttons** (p15)
• Press to select channels.
ENT / ● button
• Press to shift the minor channel from the major channel.
100 button
• Press to select 100 or higher channels. (CATV)
• Press to search if there are minor channels on the currently selected major channel. (DTV)
3. **SLEEP button** (p18)
Press to activate the sleep timer.
4. **◀/▶/▲/▼ buttons** (p12)
Press to move left/ right/ up/ down through the items.
5. **ENTER button** (p12)
Press to decide the command of setting when the main menu is displayed.
6. **AUDIO button** (p16)
Digital Mode (DTV)
• Press to select the audio language.
Analog Mode (TV)
• Press to select the audio mode.
7. **DISPLAY button** (p17)
Digital Mode (DTV)
• Press to display the channel number and the program information.
Analog Mode (TV)
• Press to display the channel number.
External Input Mode
• Press to display the currently selected.
8. **INPUT button** (p16)
• Press to access connected an external device like a DVD player or VCR.
• Press to switch between the digital mode (DTV) and analog mode.
9. **MUTE button** (p15)
Press to turn the sound on and off.
10. **VOL +/- buttons** (p15)
Press to adjust the volume.
11. **CH ^/v buttons** (p15)
Press to select channels.
12. **FLASHBACK button** (p15)
Press to return to previous channel.
13. **MENU button** (p13)
Press to display the main menu.
14. **RETURN button**
Press to return to previous menu operation.
15. **VIEW MODE button** (p18)
Press to select aspect ratio available for the TV screen.

✓ **Control Panel**

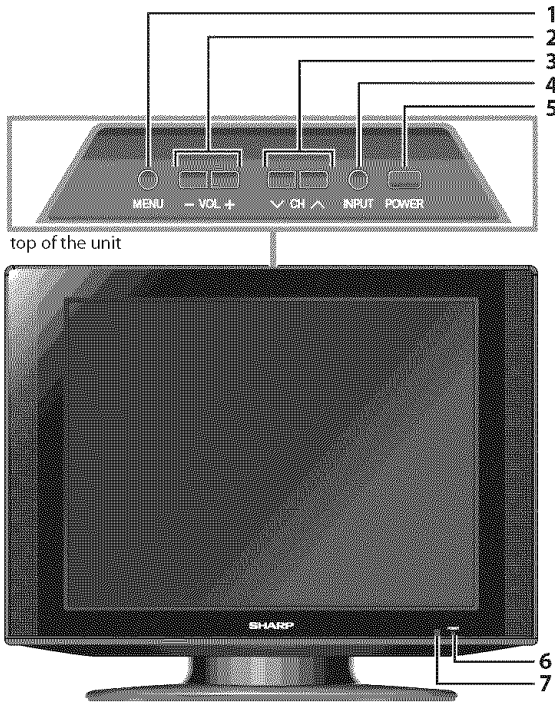

1. **MENU button** (p13)
Press to display the main menu.
2. **VOL - / + buttons** (p15)
Press to adjust the volume.
3. **CH ^/v buttons** (p15)
Press to select channels or move up/down through the main menu items.
4. **INPUT button** (p16)
 - Press to access connected an external device like a DVD player or VCR.
 - Press to switch between the digital mode (DTV) and analog mode.
5. **POWER button** (p12)
Press to turn the unit on and off.
6. **Power Indicator**
Lights up when power is on.
7. **Infrared Sensor Window**
Receives infrared commands transmitted from the remote control.

✓ **Rear Panel**

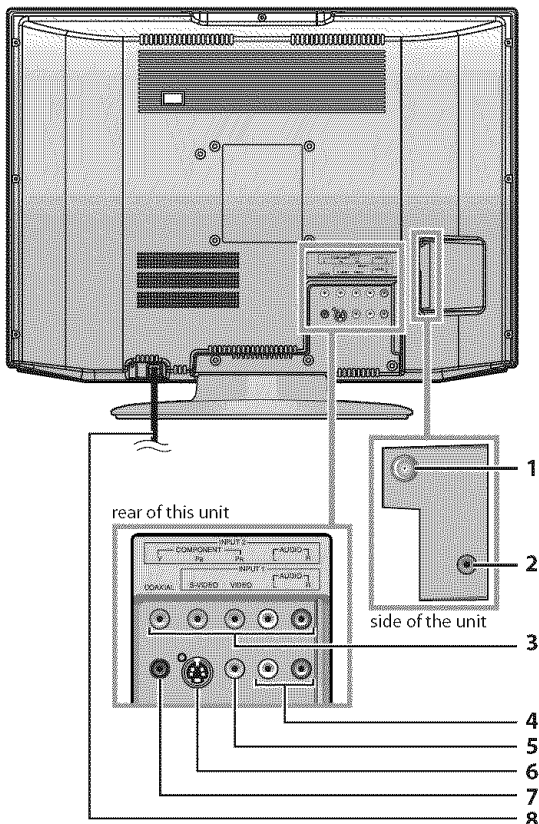

1. **ANT jack** (p9)
RF coaxial cable connection for your antenna or cable box.
2. **HEADPHONE jack**
Headphone connection for personal listening.
3. **COMPONENT and AUDIO input jacks** (p10)
Component video cable connection for an external device.
Use component video and audio output jacks of an external device.
4. **AUDIO input jacks** (p10)
RCA audio cable connection for an external device.
5. **VIDEO input jack** (p11)
RCA video cable connection for an external device.
6. **S-VIDEO input jack** (p10)
S-video cable connection for an external device.
7. **COAXIAL (digital audio) output jack** (p11)
Digital audio coaxial cable connection for a decoder or an audio receiver.
Use digital audio input jack of an external device.
8. **AC power cord**
Connect to a standard AC outlet to supply power to this unit.

Cables not included.

Please purchase the necessary cables at your local store.

Basic Connection

This section describes how to connect the unit to an antenna, cable box, etc.

Note:

• Be sure your antenna or other device is connected properly before plugging in the power cord.

[Antenna Cable Connection]

When connecting the unit to an antenna or cable TV company (without cable box)

Connect the RF coaxial cable on your home outlet to the antenna input jack of this unit.

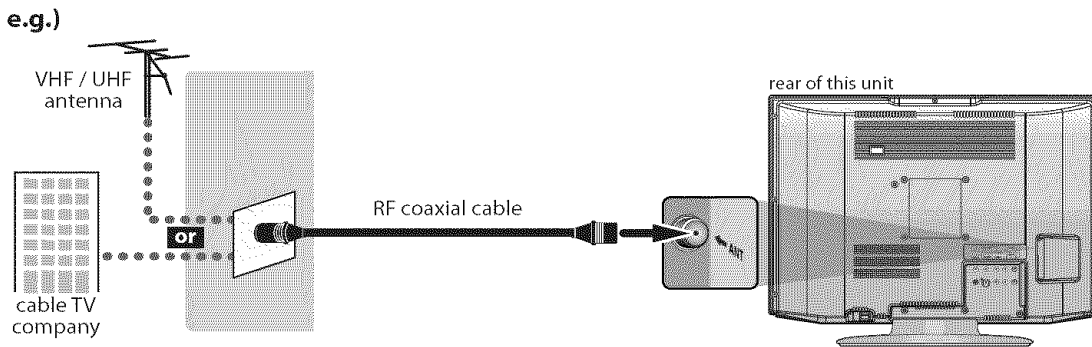

*Once connections are completed, turn on the unit and begin initial setup.
Channel scanning is necessary for the unit to memorize all available channels in your area.
(Refer to "Initial Setup" on page 12.)

Note:

- For your safety and to avoid damage to device, please unplug the RF coaxial cable from the antenna input jack before moving the unit.
- If you use an antenna to receive analog TV, it should also work for DTV reception. Outdoor or attic antennas will be more effective than set-top versions.
- To easily switch your reception source between antenna and cable, install an antenna selector.
- If you connect to the cable system directly, contact the CATV installer.

[Connection to Cable Box]

Connect the RF coaxial cable on your home outlet to the input jack of the cable box.

Use another RF coaxial cable to connect the antenna input jack of the unit to the output jack of the cable box.

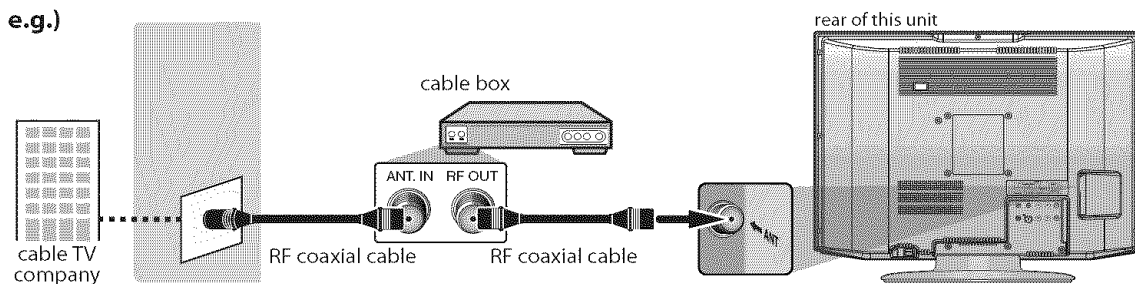

*Required cables and connecting methods differ depending on the cable box.
For more information, please contact your cable provider.

CONNECTION

Cables not included.

Please purchase the necessary cables at your local store.

External Device Connection

[Component Video Cable Connection]

Component video connection offers better picture quality for video devices connected to the unit.

Use a component video cable to connect the unit to external video devices equipped with component video output jacks.

If you connect to the unit's component video input jack, connect RCA audio cables to the audio L/R jacks of INPUT2.

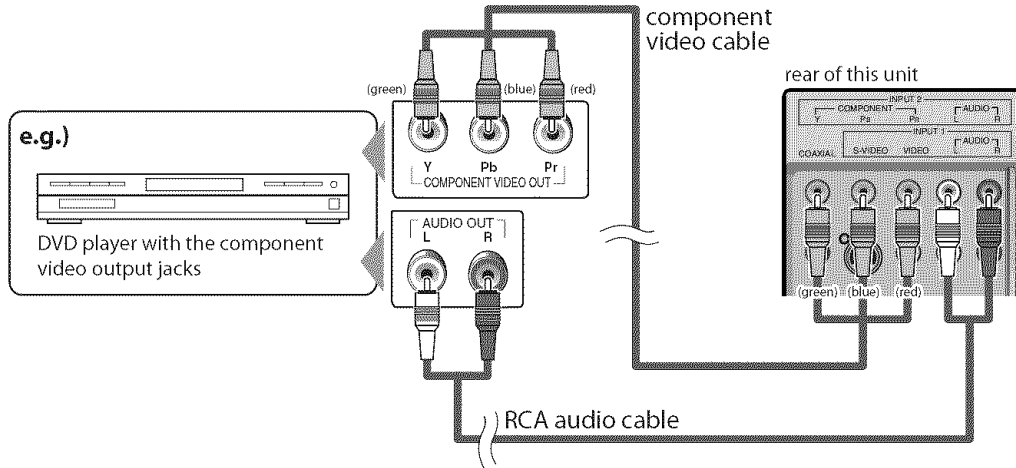

Note:

- This unit accepts 480i / 480p video signals.
- If the external device enables 480p video signal to send to this unit, you can select the display mode either 4:3 (normal) or wide. (Refer to "TV Screen Display Mode" on page 18.)

[S-video Cable Connection]

S-video connection offers good picture quality for video devices connected to the unit.

Use an S-video cable to connect the unit to external video devices equipped with S-video output jack.

If you connect to the unit's S-video input jack, connect RCA audio cables to the audio L/R jacks of INPUT1.

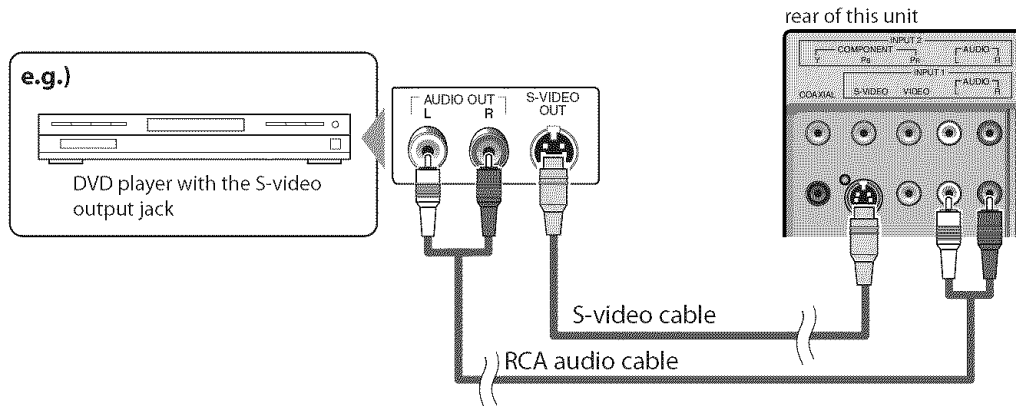

Note:

- If you connect to the S-video jack and the video jack at the same time, the S-video connection will have priority.

Cables not included.

Please purchase the necessary cables at your local store.

[Video Connection]

Video connection offers standard picture quality for video devices connected to the unit.

If you connect to the unit's video input jack, connect RCA audio cables to the audio L/R jacks of INPUT1.

When the audio jack of the video device is monaural, connect the RCA audio cable to the audio L input jack.

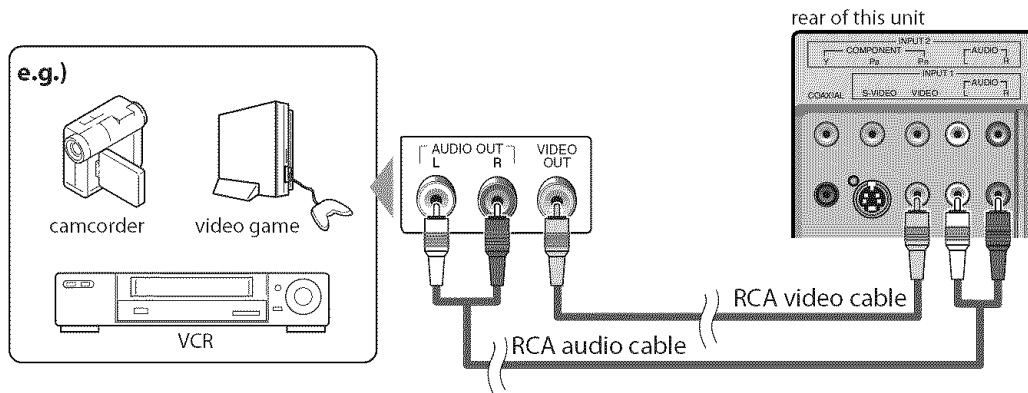
**Note:**

• If you connect to the S-video jack and the video jack at the same time, the S-video connection will have priority.

[Digital Audio Output Connection]

If you connect this unit to an external digital audio device, you can enjoy multi-channel audio like 5.1 ch digital broadcasting sound.

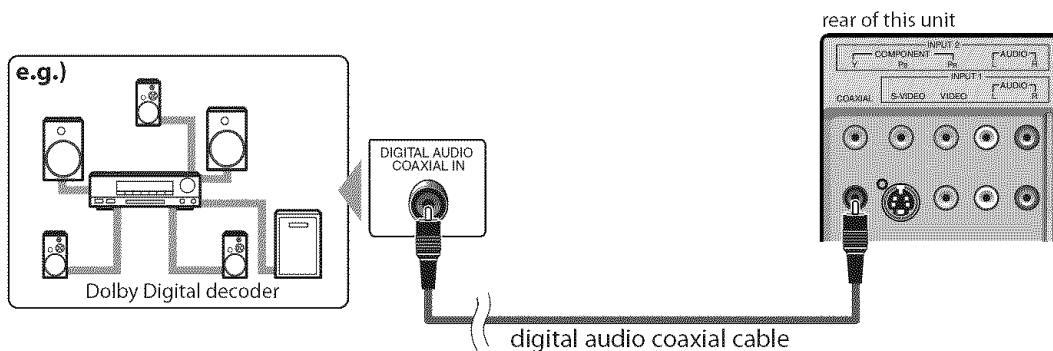

These operations are accessible by remote control. Some may also be accessible by controls on the main unit.

✓ Initial Setup

This section will guide you through the unit's initial setting which includes selecting a language for your on-screen menu and "AUTO PRESET CH", which automatically scans and memorizes viewable channels.

Before you begin:

Make sure if the unit is connected to antenna or cable.

- 1 After making all the necessary connections, press **[POWER]** to turn on the unit.

POWER



- This operation may take a few moments.

- 2 Use **[Cursor ▲/▼]** to select the on-screen language from the choices on the right side of the TV screen. (ENGLISH / ESPAÑOL / FRANÇAIS)

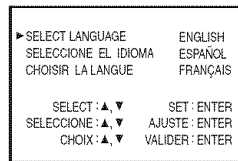
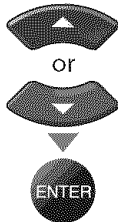

- "INITIAL SETUP" menu on step 3 will be displayed in the selected language after you press **[ENTER]**.

- 3 Use **[Cursor ▲/▼]** to select "AUTO PRESET CH(TV/DTV)" for TV channels or "AUTO PRESET CH(CATV)" for CATV channels, then press **[ENTER]**.

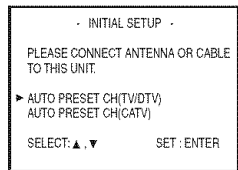
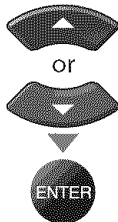

- Scanning and memorizing the channels automatically start.

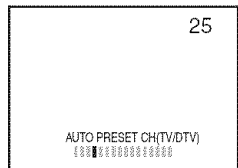

- When the scanning and memorizing are completed, the lowest memorized channel in the broadcasting will be displayed.

Note:

- If you connect the cable system directly, contact the CATV installer.
- If you press **[POWER]** or **[MENU]** during "AUTO PRESET CH", this setting will be canceled.
- The initial auto channel scan function can be executed for either TV/DTV or CATV only once. If you want to scan both TV/DTV and CATV, you need to select "CHANNEL SETUP" in the main menu to scan and memorize other channels after initial presetting is completed. (Refer to page 13.)
- You can cancel or exit the initial "AUTO PRESET CH" menu by pressing **[MENU]**.
- When no channel can be received by "AUTO PRESET CH", "NO TV SIGNALS" is displayed on the TV screen.
- If there is no signal input from the antenna terminal and no operation for several seconds after you turn on the unit, "HELPFUL HINTS" appears. Follow the instructions listed on the TV screen.

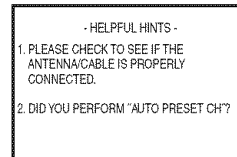

✓ Main Menu

This section describes the overview of the main menu displayed when you press [MENU]. For more details, see the reference page for each item. The main menu consists of the function setting items below.

Press [MENU].

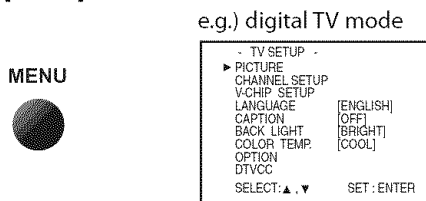

• PICTURE

You can adjust the picture quality.
(Refer to "Picture Adjustment" on page 20.)

• CHANNEL SETUP

You can automatically scan the viewable channels and remove those that are undesired.
(Refer to "Auto Channel Scan" on page 13.)

• V-CHIP SETUP

You can set the viewing limitations.
(Refer to "V-chip" on page 25.)

• LANGUAGE

You can change the language (English, Spanish, French) displayed on the main menu.
(Refer to "Language Selection" on page 14.)

• CAPTION

You can change the display format for closed caption, which displays the dialogue of a TV program or other information across the TV screen.
(Refer to "Closed Caption" on page 20.)

• BACK LIGHT

You can set the desired brightness mode.
(Refer to "Back Light Setting" on page 23.)

• COLOR TEMP.

You can adjust color temperature ("COOL", "WARM", "NORMAL").
(Refer to "Color Temperature" on page 25.)

• DTVCC

In addition to the basic closed caption described on page 20, DTV has its own closed caption called DTVCC.
(Refer to "DTV Closed Caption" on page 21.)

✓ Auto Channel Scan

If you switch cable signal source (e.g., between antenna and CATV) or if you move the TV to a different area after the initial setting, or if you restore the DTV channel you deleted, you will need to perform auto channel scan.

Before you begin:

Make sure if the unit is connected to antenna or cable.

1 Press [MENU] to display the main menu.



2 Use [Cursor ▲/▼] to select "CHANNEL SETUP", then press [ENTER].

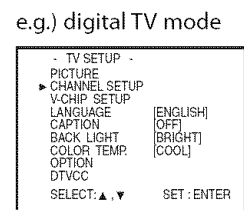
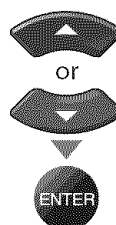

3 Use [Cursor ▲/▼] to select your desired preset type, then press [ENTER].

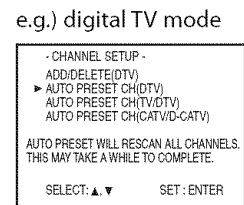
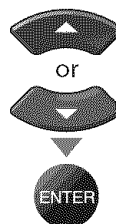

- When aerial antenna is connected, select "AUTO PRESET CH(TV)", "AUTO PRESET CH(DTV)" or "AUTO PRESET CH(TV/DTV)".
- When connected to CATV, select "AUTO PRESET CH(CATV)" or "AUTO PRESET CH(CATV/D-CATV)".
- Scanning and memorizing the channels automatically start.

e.g.) digital TV mode

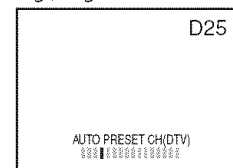

- When the scanning and memorizing are completed, the lowest memorized channel will be displayed.
- When you selected "AUTO PRESET CH(TV/DTV)" or "AUTO PRESET CH(CATV/D-CATV)", the lowest memorized analog channel will be displayed when the scanning and memorizing are completed. If there is no analog channel, the lowest memorized digital channel will be displayed.
- "AUTO PRESET CH(CATV/D-CATV)" may take a while to complete.

Note:

- If you connect the cable system directly, contact the CATV installer.
- If you press [POWER] or [MENU] during auto channel scan, the setting will be canceled.
- When no channel can be received by auto channel scan, "NO TV SIGNALS" will be displayed on the TV screen.
- Channel settings will be saved even if the power fails.
- If you have Spanish or French menus and need English, press [MENU]. Use [Cursor ▲/▼] to select "IDIOMA" or "LANGAGE". Press [ENTER] to select "ENGLISH". Press [MENU] to remove the main menu.
- With regard only to the digital channel, even after the scanning is complete if you unplug the AC power cord before turning off the unit by pressing [POWER], the channel setting may be lost.

✓ Language Selection

You can choose English, Spanish, or French as your on-screen language.

- 1 Press [MENU] to display the main menu.

MENU



- 2 Use [Cursor ▲/▼] to select "LANGUAGE", then press [ENTER] repeatedly to change the setting.

e.g.) digital TV mode

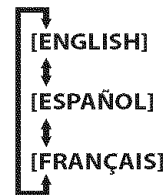
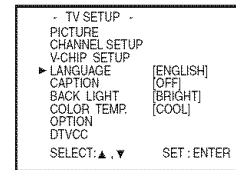
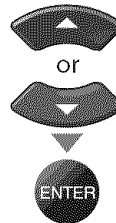

- 3 Press [MENU] to exit.

MENU



✓ Channel Selection

Select channels by pressing [CH ^/∨] or [the Number buttons].

- To select the memorized channels, use [CH ^/∨] or [the Number buttons].
- To select the non-memorized channels use [the Number buttons].

To Use [the Number buttons]

TV

- When selecting analog channel 12



DTV

- When selecting digital channel 12-1

Be sure to press [ENT/●] before entering the minor channel number.

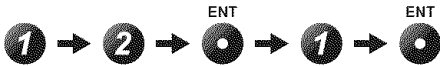

- Press [FLASHBACK] to return to the previously viewed channel.
- When you select a channel larger than 100, press [100] first. Then use [the Number buttons] to press the lower 2-digit numbers.

About digital TV broadcasting:

With its high definition broadcast, digital broadcasting far surpasses analog broadcasting in both its picture and sound quality.

What is the minor channel?

By using high compression technology, digital broadcasting offers a service that enables multiple signals to send simultaneously. Therefore, you can select more than one program per major channel since digital broadcasting technology distinguishes between multiple channels broadcast by a single network.

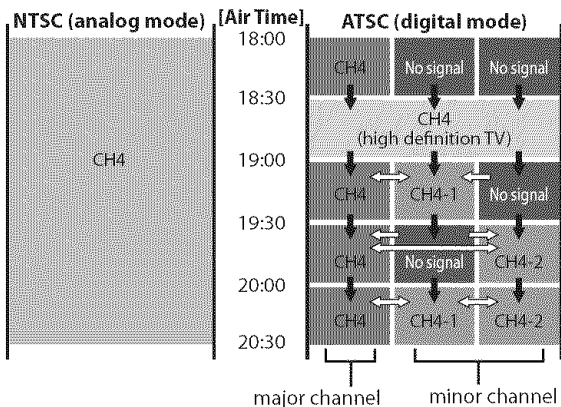

- ➡ : change automatically
- ⇔ : change manually by using [CH ^/∨]

Although, you cannot watch the high definition TV (HDTV) program, the unit converts the HDTV signal down to the standard definition TV signal.

Note:

- "NO SIGNAL" will appear on the TV screen after the minor channel broadcast is over.

✓ Volume Adjustment

This section describes how to adjust the volume. The mute function, which turns the sound off and on, is also described.

Use [VOL +/-] to adjust the audio volume.

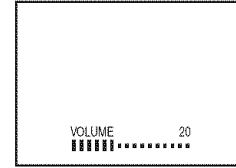

- The volume bar will be displayed at the bottom of the TV screen when adjusting the volume.
- The volume bar display will automatically disappear in a few seconds.

Press [MUTE] to turn off and on the sound.

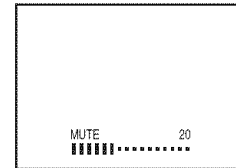

- "MUTE" is displayed on the TV screen for a few seconds.

Press [MUTE] again or [VOL +/-] to recover the original volume.

✓ Switching Each Mode

You can easily switch with the remote control to the DTV (ATSC) and TV (NTSC) or to access an external device when they are connected to the unit.

- 1 Press **[INPUT]** repeatedly to cycle through analog TV, digital TV, INPUT1 and INPUT2.

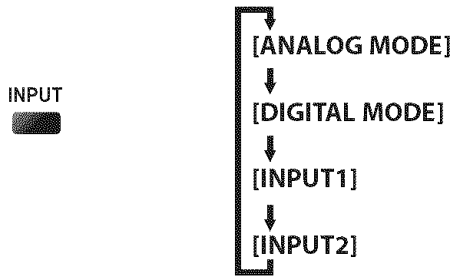

- To use the video or S-video input jack on the unit, select "INPUT1".
- To use the component video input jack on the unit, select "INPUT2".

Note:

• When you switch the analog mode to the digital mode, it may take a while until the digital channel selection is completed. The following TV screen is displayed while switching the mode.

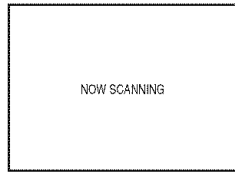

✓ Switching Audio Mode

This section describes how to switch the audio in the analog mode and how to switch the audio language in the digital mode.

TV

While receiving an MTS broadcast, press **[AUDIO]** repeatedly to cycle through the available audio channel.

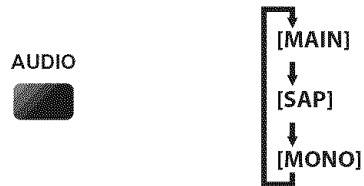

MAIN : Outputs main-audio
SAP : Outputs second audio program
MONO : Outputs mono-audio

- The information display will automatically disappear in 10 seconds.

DTV

- 1 Press **[AUDIO]** to display the currently selected language and the number of available languages.

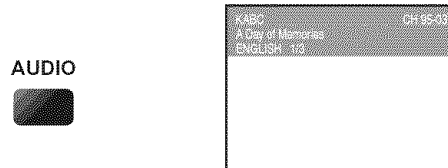

- 2 Press **[AUDIO]** repeatedly to cycle through the available audio languages.

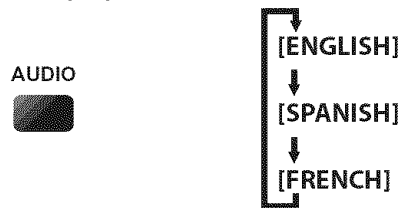

- Available languages differ depending on the broadcast. "OTHER" is displayed when the audio language cannot be acquired, or the acquired languages are other than English, Spanish or French.
- The information display will automatically disappear in 10 seconds.

Note:

• Pressing **[AUDIO]** does not control external audio device.

✓ Screen Information

You can display the currently selected channel or other information such as the audio mode on the TV screen.

TV

In the analog mode, the current channel number is displayed.

Press **[DISPLAY]**.

DISPLAY

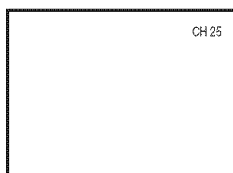

- The current channel number is displayed at the top-right corner of the TV screen.
- To clear the display, press **[DISPLAY]** again.

DTV

In the digital mode, the detailed broadcasting information for the current channel such as program title, program guides are displayed.

Press **[DISPLAY]** repeatedly to cycle through the available display modes.

DISPLAY

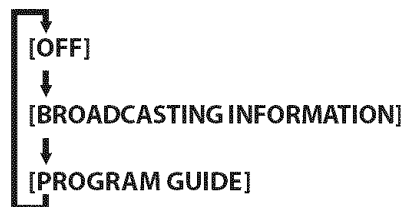

[Broadcasting Information]

- The following information is displayed.
 - 1 channel number
 - 2 broadcast station
 - 3 program title
 - 4 audio language
 (Refer to "Switching Audio Mode" on page 16.)

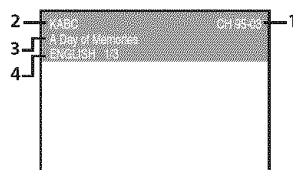

[Program Guide]

- The program guide added to broadcasting information is displayed.

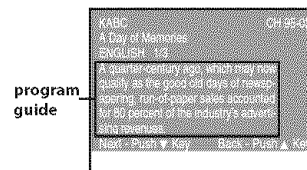

Note:

- When the program guide consists of more than 6 lines, use **[Cursor ▲/▼]** to scroll.
- "No description provided" is displayed when the program guide is not provided.
- While the program guide is displayed, the closed caption function is interrupted.
- In external input mode, the following screen is displayed; e.g.) When an external device is connected to INPUT1 input jack.

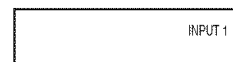

- Available languages differ depending on the broadcast.
- The information display will automatically disappear in 1 minute.
- Pressing **[AUDIO]** does not control external audio device.

✓ TV Screen Display Mode

DTV

2 types of display modes can be selected in the digital mode when the broadcasting station is sending 16:9 video signal.

Press **[VIEW MODE]** repeatedly to switch the TV aspect ratio.

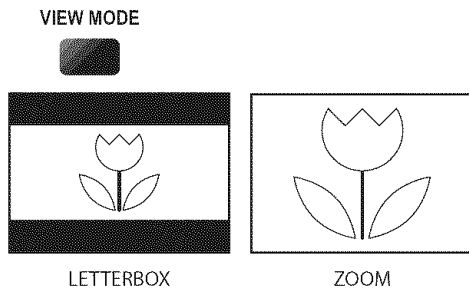

[LETTERBOX]

Display the digital-supported program in full-screen. Black borders will spread in the upper and lower screen.

[ZOOM]

Enlarge and display the center area of the digital-supported program.

The right and left side of image will be cut off.

Note:

- You may not switch the display mode depending on the program.
- In "INPUT 2" of the external input mode, you can also select the display mode either "4:3 (normal)" or "WIDE" when the connected external device outputs 480p video signal and the following is displayed on the TV screen.

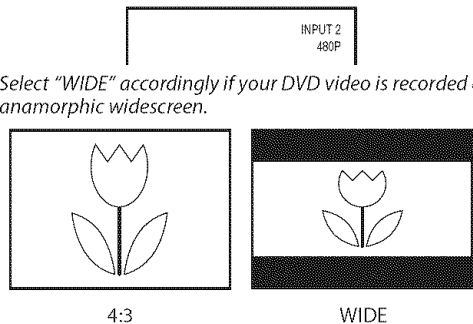

Select "WIDE" accordingly if your DVD video is recorded as anamorphic widescreen.

✓ Sleep Timer

The sleep timer can be set to automatically turn off the unit after an incremental period of time.

1 Press **[SLEEP]** to set the sleep timer.

SLEEP

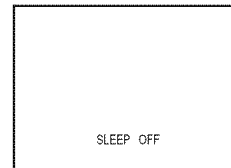

- Sleep timer display appears on the TV screen.

2 Press **[SLEEP]** repeatedly to change the amount of time until shut off.

SLEEP

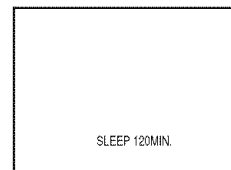

- You can set your unit to turn off after a set period of time (from 30 to 150 minutes).
- Each press of **[SLEEP]** will increase the time by 30 minutes.
- After set up, the sleep timer display can be called up for checking by pressing **[SLEEP]**.

To Cancel the Sleep Timer

Press **[SLEEP]** repeatedly until "SLEEP OFF" is displayed on the TV screen.

Note:

- The sleep timer setting display will automatically disappear in 10 seconds.
- When you disconnect the unit from the AC outlet or when a power failure occurs, the sleep timer setting will be canceled.

Channel Add/Delete

The channel add/delete function lets you add the channel that was not added by the auto channel scan due to the reception status at the initial setting. You can also delete the unnecessary channels.

1 Press **[MENU]** to display the main menu.

MENU



6 Press **[MENU]** to exit.

MENU



2 Use **[Cursor ▲/▼]** to select "CHANNEL SETUP", then press **[ENTER]**.

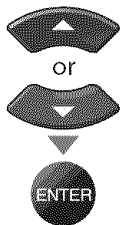

e.g.) digital TV mode

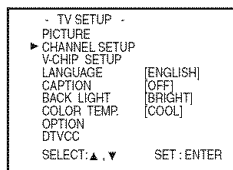

Note:

- "ADD/DELETE(DTV)" or "ADD/DELETE" menu will disappear automatically in about 10 seconds.
- In the digital mode (DTV), you can add or delete channels only for major channel.
- Once you delete a DTV channel, you cannot recover the channel without performing auto channel scan again. (Refer to "Auto Channel Scan" on page 13.)

3 Use **[Cursor ▲/▼]** to select "ADD/DELETE(DTV)" or "ADD/DELETE", then press **[ENTER]**.

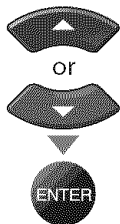

e.g.) digital TV mode

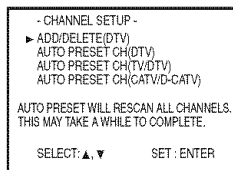

4 Select the channel you want to add or delete. (Refer to "Channel Selection" on page 15.)

e.g.) digital TV mode

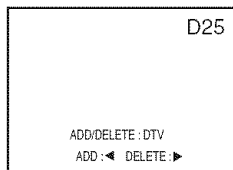

5 Press **[Cursor ◀]** to add the desired channel or press **[Cursor ▶]** to delete the desired channel.

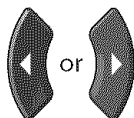

- To add or delete another channels, repeat steps 4-5.
- Color of channel number displayed at the right top of the TV screen indicates;
 - Blue: The selected channel will be added.
 - Red: The selected channel will be deleted.

OPTIONAL SETTING

Picture Adjustment

You can adjust brightness, contrast, color, tint and sharpness.

1 Press [MENU] to display the main menu.

MENU



2 Use [Cursor ▲/▼] to select "PICTURE"; then press [ENTER].

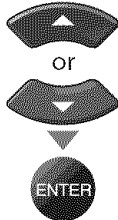

e.g.) digital TV mode

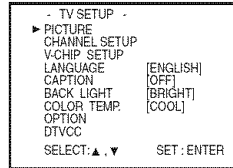

3 Use [Cursor ▲/▼] to select the picture quality type you want to adjust.

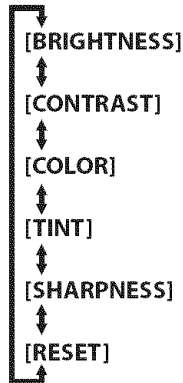
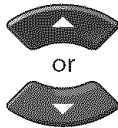

4 Within 5 seconds, use [Cursor ◀/▶] to adjust the quality.

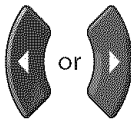

	Cursor ◀	Cursor ▶
BRIGHTNESS	to decrease brightness	to increase brightness
CONTRAST	to decrease contrast	to increase contrast
COLOR	to decrease color	to brighten color
TINT	to add purple	to add green
SHARPNESS	to make soft	to make clear

5 Press [MENU] to exit.

MENU



Note:

- For resetting all picture adjustment items to the factory preset values, use [Cursor ▲/▼] to select "RESET", then press [ENTER], use [Cursor ◀/▶] to select "[YES]", then press [ENTER].
- The picture adjustment setting display will automatically disappear in 10 seconds.

Closed Caption

TV

You can view closed captioning (cc) for TV programs, movies and news. Closed caption refer to text of dialogue or descriptions displayed on-screen for the hearing impaired.

1 Press [MENU] to display the main menu.

MENU



2 Use [Cursor ▲/▼] to select "CAPTION"; then press [ENTER] repeatedly to change the setting.

e.g.) digital TV mode

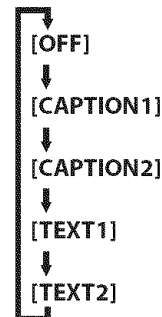
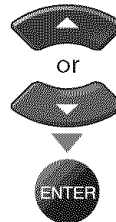
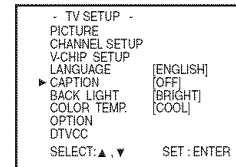

[Caption Mode]

CAPTION1 and TEXT1;

are the primary caption and text services. The captioning or text is displayed in the same language as the program's dialogue (up to 4 lines of script on the TV screen, where it does not obstruct relevant parts of the picture).

CAPTION2 and TEXT2;

are rarely available and broadcasters use them only in special conditions, such as when "CAPTION1" or "TEXT1" is not available.

• There are 3 display modes according to programs:

Paint-on mode: Displays input characters on the TV screen immediately.

Pop-on mode: Once characters are stored in memory, they are displayed all at once.

Roll-up mode: Displays the characters continuously by scrolling (max. 4 lines).

3 Press [MENU] to exit.

MENU



Note:

- To show the closed caption on your TV screen, broadcast signal must contain the closed caption data.
- Not all TV programs and commercials have the closed caption or all types of the closed caption.
- Captions and texts may not match the TV voice exactly.
- Changing channels may delay the closed caption for a few seconds.
- Adjusting or muting the volume may delay the closed caption for a few seconds.
- Abbreviations, symbols and other grammatical shortcuts may be used in order to keep pace with the on-screen action. This is not a problem with the unit.
- The caption or text characters will not be displayed while the main menu or functions display is shown.
- If a black box appears on the TV screen, this means that the closed caption is set to TEXT mode. To clear the box, select "CAPTION 1", "CAPTION 2" or "OFF".
- If the unit receives poor quality television signals, the captions may contain errors, or there might be no captions at all. Some possible causes of poor quality signals are:
 - Automobile ignition noise
 - Electric motor noise
 - Weak signal reception
 - Multiplex signal reception (ghosts or screen flutter)
- The unit retains the closed caption setting if the power fails.

DTV Closed Caption

DTV

In addition to the basic closed caption described on page 20, DTV has its own closed caption called DTVCC. Use this menu to change the settings for DTVCC.

1 Press [MENU] to display the main menu.

MENU



2 Use [Cursor ▲/▼] to select "DTVCC", then press [ENTER].

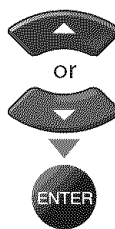

e.g.) digital TV mode

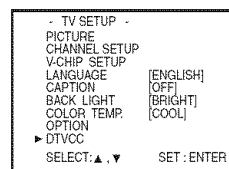

3 Use [Cursor ▲/▼] to select "CAPTION SERVICE", then press [ENTER] repeatedly to change the setting.

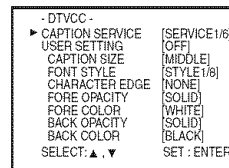
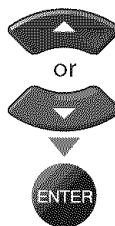

CAPTION SERVICE	OFF	Select if you do not want DTVCC. This is the default.
	SERVICE1~6	Select one of these before changing any other item in "CAPTION" menu. Choose "SERVICE1/6" under normal circumstances.

4 Press [MENU] to exit.

MENU



Note:

- "CAPTION SERVICE" that you can switch differs depending on the broadcast description.

OPTIONAL SETTING

✓ DTVCC Style

DTV

You can change the style of DTV CC such as font, color or size, etc.

1 Press [MENU] to display the main menu.

MENU



2 Use [Cursor ▲/▼] to select "DTVCC", then press [ENTER].

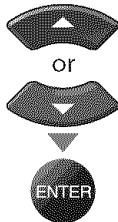

e.g.) digital TV mode

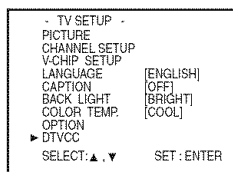

3 Use [Cursor ▲/▼] to select "USER SETTING", then press [ENTER] repeatedly to set to "ON".

• Items in the dotted box are available only when "USER SETTING" is "ON".

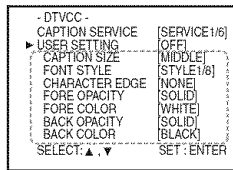
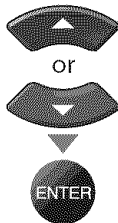

4 Use [Cursor ▲/▼] to select an item, then press [ENTER] repeatedly to change the setting for the item.

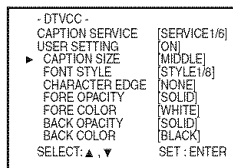
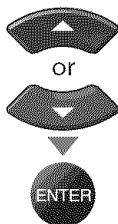

• CAPTION SIZE

Closed captioning font size can be changed as below.

• FONT STYLE

Font style of the displayed caption can be switched as below.

• CHARACTER EDGE

Edge type of the displayed caption can be switched as below.

• FORE COLOR, BACK COLOR

Font and background color of the displayed caption can be switched as below.

• FORE OPACITY, BACK OPACITY

Text and background opacity of the displayed caption can be switched as below.

CAPTION SIZE	MIDDLE, LARGE, SMALL	
FONT STYLE	STYLE1/8	Proportional font used in the menu screen
	STYLE2/8	Monospaced with serifs
	STYLE3/8	Proportionally spaced with serifs
	STYLE4/8	Monospaced without serifs
	STYLE5/8	Proportionally spaced without serifs
	STYLE6/8	Casual font type
	STYLE7/8	Cursive font type
	STYLE8/8	Small capitals
CHARACTER EDGE	NONE, RAISED, DEPRESSED, UNIFORM, SHADOW LEFT, SHADOW RIGHT	
FORE OPACITY	SOLID, TRANSLUCENT, FLASH	
FORE COLOR	WHITE, BLACK, RED, GREEN, YELLOW, BLUE, MAGENTA, CYAN, TRANSPARENT	
BACK OPACITY	SOLID, TRANSLUCENT, FLASH	
BACK COLOR	BLACK, RED, GREEN, BLUE, YELLOW, MAGENTA, CYAN, TRANSPARENT, WHITE	

5 Press [MENU] to exit.

MENU



✓ Back Light Setting

You can set the desired brightness mode.

- 1 Press **[MENU]** to display the main menu.

MENU



- 2 Use **[Cursor ▲/▼]** to select "BACK LIGHT", then press **[ENTER]** repeatedly to change the setting.

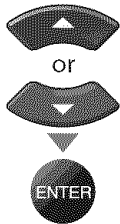

e.g.) digital TV mode

```

- TV SETUP -
PICTURE
CHANNEL SETUP
V-ChIP SETUP
LANGUAGE [ENGLISH]
CAPTION [OFF]
▶ BACK LIGHT [BRIGHT]
  COLOR TEMP. [COOL]
OPTION
DTVCC
SELECT: ▲, ▼    SET: ENTER
    
```

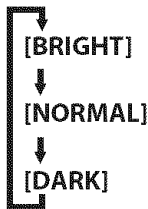

- 3 Press **[MENU]** to exit.

MENU



✓ Blue Screen

When there is no signal input, the TV screen changes to blue back screen.

- 1 Press **[MENU]** to display the main menu.

MENU



- 2 Use **[Cursor ▲/▼]** to select "OPTION", then press **[ENTER]**.

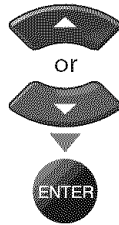

e.g.) digital TV mode

```

- TV SETUP -
PICTURE
CHANNEL SETUP
V-ChIP SETUP
LANGUAGE [ENGLISH]
CAPTION [OFF]
BACK LIGHT [BRIGHT]
  COLOR TEMP. [COOL]
▶ OPTION
  DTVCC
SELECT: ▲, ▼    SET: ENTER
    
```

- 3 Use **[Cursor ▲/▼]** to select "BLUE SCREEN", then press **[ENTER]** repeatedly to set to "ON" or "OFF".

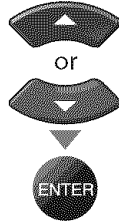

```

- OPTION SETUP -
▶ BLUE SCREEN [OFF]
NO SIGNAL OFF [OFF]
NO OPERATION OFF [OFF]

SELECT: ▲, ▼    SET: ENTER
    
```

[OFF]
↓
[ON]

- 4 Press **[MENU]** to exit.

MENU



OPTIONAL SETTING

✓ **No Signal Off**

You can set the unit to turn itself off automatically when there is no signal input from the antenna terminal and no operation for 5 minutes.

1 Press **[MENU]** to display the main menu.

MENU



2 Use **[Cursor ▲/▼]** to select "OPTION", then press **[ENTER]**.

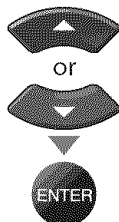

e.g.) digital TV mode

```

- TV SETUP -
PICTURE
CHANNEL SETUP
V-CHIP SETUP
LANGUAGE [ENGLISH]
CAPTION [OFF]
BACK LIGHT [BRIGHT]
COLOR TEMP. [COOL]
▶ OPTION
DTVCC
SELECT: ▲, ▼    SET: ENTER
    
```

✓ **No Operation Off**

You can set the unit to turn itself off automatically when there is no operation for 180 minutes.

1 Press **[MENU]** to display the main menu.

MENU



2 Use **[Cursor ▲/▼]** to select "OPTION", then press **[ENTER]**.

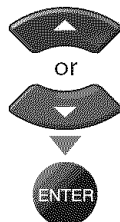

e.g.) digital TV mode

```

- TV SETUP -
PICTURE
CHANNEL SETUP
V-CHIP SETUP
LANGUAGE [ENGLISH]
CAPTION [OFF]
BACK LIGHT [BRIGHT]
COLOR TEMP. [COOL]
▶ OPTION
DTVCC
SELECT: ▲, ▼    SET: ENTER
    
```

3 Use **[Cursor ▲/▼]** to select "NO SIGNAL OFF", then press **[ENTER]** repeatedly to set to "ON" or "OFF".

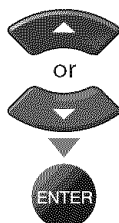

```

- OPTION SETUP -
BLUE SCREEN [OFF]
▶ NO SIGNAL OFF [OFF]
NO OPERATION OFF [OFF]
SELECT: ▲, ▼    SET: ENTER
    
```

[OFF]
↑↓
[ON]

3 Use **[Cursor ▲/▼]** to select "NO OPERATION OFF", then press **[ENTER]** repeatedly to set to "ON" or "OFF".

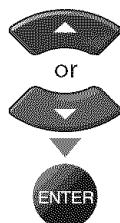

```

- OPTION SETUP -
BLUE SCREEN [OFF]
NO SIGNAL OFF [OFF]
▶ NO OPERATION OFF [OFF]
SELECT: ▲, ▼    SET: ENTER
    
```

[OFF]
↑↓
[ON]

4 Press **[MENU]** to exit.

MENU



4 Press **[MENU]** to exit.

MENU



✓ Color Temperature

You can adjust color temperature of the TV screen.

- 1 Press **[MENU]** to display the main menu.

MENU



- 2 Use **[Cursor ▲/▼]** to select "COLOR TEMP.", then press **[ENTER]** repeatedly to change the setting.

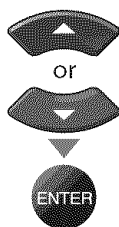

e.g.) digital TV mode

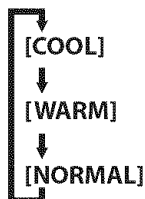
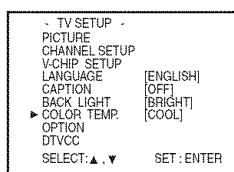

- 3 Press **[MENU]** to exit.

MENU



✓ V-chip

V-chip reads the ratings for programs, then denies access to the programs which exceed the rating level you set. With this function, you can block certain programming inappropriate for children.

- 1 Press **[MENU]** to display the main menu.

MENU



- 2 Use **[Cursor ▲/▼]** to select "V-CHIP SETUP", then press **[ENTER]**.

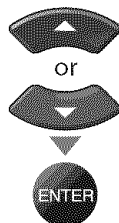

e.g.) analog TV mode

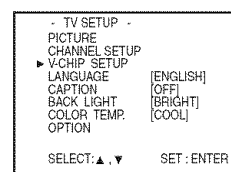

- 3 Use **[the Number buttons]** to enter the 4-digit numbers for your password.

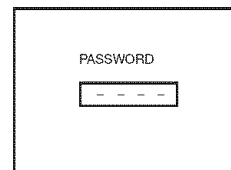
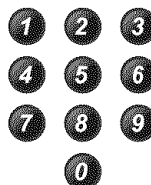

- When you have not set up your password, enter 0000.
 - When the password is correct, the following "V-CHIP SETUP" menu is displayed.
- See the following description for setting each item.

e.g.) analog TV mode

A "A. TV Rating" ⇨ page 26

B "B. MPAA Rating" ⇨ page 27

C "C. Change Password" ⇨ page 27

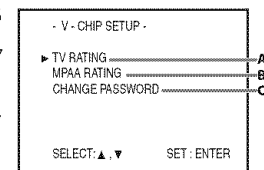

Note:

- "DOWNLOADABLE RATING" will be available when the unit receives a digital broadcast using the new rating system.
- When you select a rating and set it to "BLOCK", the higher ratings will be blocked automatically. The lower ratings will be available for viewing.
- When you set the highest rating to "VIEW", all ratings turn to "VIEW" automatically.
- If the "PROTECTED PROGRAM" message appears during your TV viewing, change to a channel that is not blocked. Then, you can access "V-CHIP SETUP" menu and change the setting to allow all TV viewing.
- To block any inappropriate programming, set your limits in both "TV RATING" and "MPAA RATING".
- The V-chip setting will be retained after a power failure (except the access code reverts to 0000).

A. TV Rating

- 4 Use [Cursor ▲/▼] to select "TV RATING", then press [ENTER].

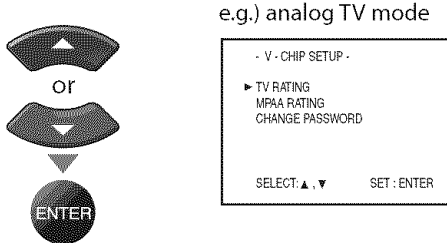

- 5 Use [Cursor ▲/▼] to select the desired rating, then press [ENTER] repeatedly to switch between "VIEW" and "BLOCK".

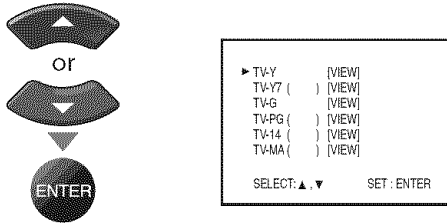

Rating	Category	
TV-Y	Appropriate for all children	lower ↑ ↓ higher
TV-Y7	Appropriate for all children 7 and older	
TV-G	General audience	
TV-PG	Parental guidance suggested	
TV-14	Unsuitable for children under 14	
TV-MA	Mature audience only	

[To Set the Sub Ratings]

As for TV-Y7, TV-PG, TV-14 or TV-MA, you can further set the sub ratings to block specific elements of programming. To set the sub ratings, follow the steps below.

- 1 Use [Cursor ▲/▼] to select the desired main rating, then press [ENTER] twice to show its sub ratings.

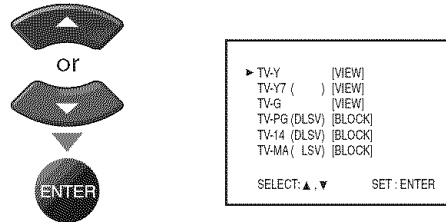

- 2 Use [Cursor ▲/▼], then press [ENTER] repeatedly to change the setting.

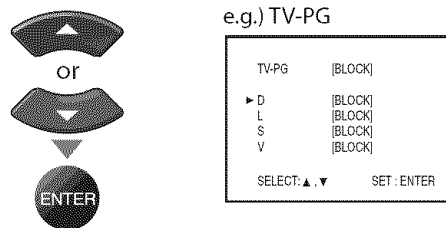

Sub Rating	Category	Rating
FV	Fantasy Violence	TV-Y7
V	Violence	TV-PG
S	Sexual Situation	TV-14
L	Coarse Language	TV-MA
D	Suggestive Dialogue	TV-PG, TV-14

- 6 Press [MENU] to exit.

MENU



Note:

- Blocked sub ratings will appear beside the main rating category in "TV RATING" menu.
- You cannot block a sub rating (D, L, S or V) if the main rating is set to "VIEW".
- Changing the category to "BLOCK" or "VIEW" automatically changes all its sub ratings to the same ("BLOCK" or "VIEW").

B. MPAA Rating

MPAA Rating is the rating system created by MPAA (Motion Picture Association of America).

- 4 Use [Cursor ▲/▼] to select "MPAA RATING", then press [ENTER].

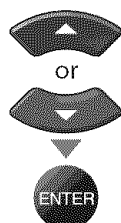

e.g.) analog TV mode

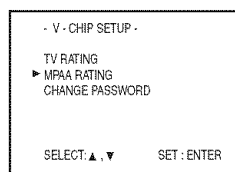

C. Change Password

Although the default code "0000" is supplied with the unit, you can set your own password.

- 4 Use [Cursor ▲/▼] to select "CHANGE PASSWORD", then press [ENTER].

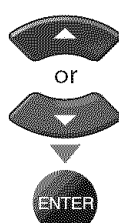

e.g.) analog TV mode

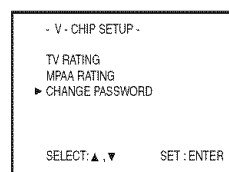

- 5 Use [Cursor ▲/▼], then press [ENTER] repeatedly to change the setting.

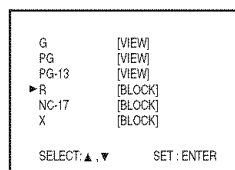
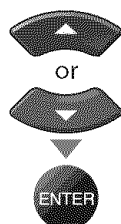

- 5 Press [the Number buttons] on the remote control to enter the new 4-digit password.

• Enter password again in "CONFIRM PASSWORD" space.

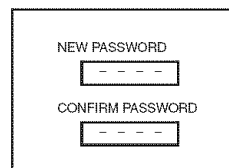
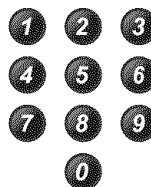

Rating	Category
G	General audience
PG	Parental guidance suggested
PG-13	Unsuitable for children under 13
R	Restricted; under 17 requires accompanying parent or adult guardian
NC-17	No one under 17 admitted
X	Mature audience only

- 6 Press [MENU] to exit.

MENU



Note:

- Make sure new password and confirm password must be exactly the same. If they are different, the space is cleared for reentering.
- Your password will be erased and return to the default (0000) when a power failure occurs. If you forget the password, unplug the power cord for 10 seconds to restore the password to 0000.

- 6 Press [MENU] to exit.

MENU



TROUBLESHOOTING

✓ Troubleshooting Guide

If the unit does not perform properly when operated as instructed in this operation manual, check the following chart once before calling for service.

Symptom	Remedy
No power	<ul style="list-style-type: none"> • Be sure the power cord is plugged in. • If a power failure occurs, unplug the power cord for 30 minutes to allow the unit to reset itself.
No picture or sound	<ul style="list-style-type: none"> • Check if the power is on. • Check the outlet connection. • Check the antenna or cable connection to the main unit. • When the outside antenna is used, check the wire condition and connection. • View other TV channels. The problem might be limited to the broadcasting station. • Turn off the power and wait for about 1 minute, then turn it on again.
No color	<ul style="list-style-type: none"> • Check the antenna or cable connection to the main unit. • When the outside antenna is used, check the wire condition and connection. • View other TV channels. The problem might be limited to the broadcasting station. • Adjust the "COLOR" in the main menu.
Sound OK, picture poor	<ul style="list-style-type: none"> • Check the antenna or cable connection to the main unit. • When the outside antenna is used, check the wire condition and connection. • Electrical interference from nearby appliances may affect picture quality. • Adjust "CONTRAST" and "BRIGHTNESS" in the main menu. • View other TV channels. The problem might be limited to the broadcasting station.
Picture distorted	<ul style="list-style-type: none"> • When the outside antenna is used, check the wire condition and connection. • View other TV channels. The problem might be limited to the broadcasting station.
Weak picture	<ul style="list-style-type: none"> • Check the antenna or cable connection to the main unit. • When the outside antenna is used, check the wire condition and connection. • Adjust "CONTRAST" and "BRIGHTNESS" in the main menu. • View other TV channels. The problem might be limited to the broadcasting station.
Lines or streaks in picture	<ul style="list-style-type: none"> • When the outside antenna is used, check the wire condition and connection. • Electrical interference from nearby appliances may affect picture quality. • View other TV channels. The problem might be limited to the broadcasting station.
Picture blurred	<ul style="list-style-type: none"> • When the outside antenna is used, check the wire condition and connection. • View other TV channels. The problem might be limited to the broadcasting station.
Ghosts in picture	<ul style="list-style-type: none"> • Check the antenna or cable connection to the main unit. • When the outside antenna is used, check the wire condition and connection. • Electrical interference from nearby appliances may affect picture quality. • View other TV channels. The problem might be limited to the broadcasting station.
Bars on screen	<ul style="list-style-type: none"> • When the outside antenna is used, check the wire condition and connection. • Electrical interference from nearby appliances may affect picture quality.
Picture rolls vertically	<ul style="list-style-type: none"> • When the outside antenna is used, check the wire condition and connection. • Electrical interference from nearby appliances may affect picture quality. • View other TV channels. The problem might be limited to the broadcasting station.
Different color marks on screen	<ul style="list-style-type: none"> • Move the unit away from nearby electric appliances. Turn off the power and wait 30 minutes before turning it back on. • View other TV channels. The problem might be limited to the broadcasting station.
Poor reception on some channels	<ul style="list-style-type: none"> • Check the antenna or cable connection to the main unit. • When the outside antenna is used, check the wire condition and connection. • Electrical interference from nearby appliances may affect picture quality. • View other TV channels. The problem might be limited to the broadcasting station.
Picture OK, sound poor	<ul style="list-style-type: none"> • View other TV channels. The problem might be limited to the broadcasting station.
No reception of digital signals	<ul style="list-style-type: none"> • Make sure auto channel scan has been completed (Refer to "Auto Channel Scan" on page 13). Auto channel scan must be completed when you set up the unit for the first time or move it to a location where previously unavailable channels are broadcast. • The selected channel may not be broadcasting. • When auto channel scan is interrupted and not completed, some channels will not be received. Make sure to complete (Refer to "Auto Channel Scan" on page 13).

Symptom	Remedy
The entered channel number changes automatically	<ul style="list-style-type: none"> • Many digital channels have alternate channel numbers. The unit changes the numbers automatically to the ones signifying the broadcasting stations. These are the numbers used for analog broadcasts.
Remote control does not work	<ul style="list-style-type: none"> • Check the antenna or cable connection to the main unit. • Check the batteries of the remote control. • Check if there is an obstacle between the infrared sensor window and the remote control. • Aim the remote control directly at the infrared sensor window on the front of the unit. • Reduce the distance to the unit. • Re-insert the batteries with their polarities (+/- signs) as indicated.
The TV sometimes makes a cracking sound.	<ul style="list-style-type: none"> • This is not a malfunction. This happens when the cabinet slightly expands and contracts according to change in temperature. This does not affect the TV's performance.

Problems with Closed Caption Feature

Misspelled captions are displayed.	<ul style="list-style-type: none"> • Closed captioning production companies may broadcast programs without correcting the misspelling in a live broadcast.
Captions are not entirely displayed, or captions are delayed behind the dialogue.	<ul style="list-style-type: none"> • Captions that are delayed a few seconds behind the actual dialogue are common for live broadcasts. Most captioning production companies can display a dialogue to a maximum of 220 words per minute. If a dialogue exceeds that rate, selective editing is used to insure that the captions remain up-to-date with the current TV screen dialogue.
Captions are displayed as a white box. No caption is displayed in the closed caption-supported program.	<ul style="list-style-type: none"> • Interference from buildings or weather conditions may cause captioning to be incomplete. • Broadcasting station may shorten the program to insert advertisement. The closed caption decoder cannot read the information of the shortened program.
No caption is displayed when playing the videotape containing captions.	<ul style="list-style-type: none"> • The videotape may be illegally copied, or the caption signal might not have been read during copying.
Black box is displayed in the TV screen.	<ul style="list-style-type: none"> • "Text" mode is selected for caption. Select "CAPTION1", "CAPTION2" or "OFF".

Note:

- The LCD panel is manufactured to provide many years of useful life. Occasionally a few non active pixels may appear as a fixed point of blue, green or red. This is not to be considered a defect in the LCD screen.
- Some functions are not available in specific modes, but this is not a malfunction. Read the description in this operation manual for more details on correct operations.

Glossary

ATSC

Acronym that stands for Advanced Television Systems Committee and the name of the digital broadcasting standards.

Aspect Ratio

The width of a TV screen relative to its height. Conventional TVs are 4:3 (in other words, the TV screen is almost square); widescreen models are 16:9 (the TV screen is almost twice as wide as its height).

Component Video

This is a video signal format that conveys each of 3 principal colors of light (red, blue and green) through different signal lines. This allows the viewers to experience picture colors as original as it is. There are several signal formats, including Y / Pb / Pr and Y / Cb / Cr.

Dolby Digital

The system developed by Dolby Laboratories to compress digital sound. It offers stereo sound (2ch) or multi-channel audio.

EDTV (enhanced definition TV)

Enhanced digital format that takes 480-line progressive signal.

HDTV (high definition TV)

Ultimate digital format that produces high resolution and high picture quality.

NTSC

Acronym that stands for National Television Systems Committee and the name of the current analog broadcasting standards.

Password

A stored 4-digit number that allows access to parental control features.

SAP (secondary audio program)

Second-audio channel delivered separately from main-audio channel. This audio channel is used as an alternate in bilingual broadcasting.

SDTV (standard definition TV)

Standard digital format that is similar to the NTSC picture quality.

S-video

Offers higher quality images by delivering each signal, color (c) and luminance (y) independently of each other through separate cables.

Cable Channel Designations

If you subscribe to cable TV, the channels are displayed as 1-135.

Cable companies often designate channels with letters or letter-number combinations. Please check with your local cable company.

The following is a chart of common cable channel designations.

CATV channel	5A	2	3	4	5	6	7	8	9	10	11	12	13	A	B	C	D	E	F	G	H
TV Display	1	2	3	4	5	6	7	8	9	10	11	12	13	14	15	16	17	18	19	20	21
CATV channel	I	J	K	L	M	N	O	P	Q	R	S	T	U	V	W	W+1	W+2	W+3	W+4	W+5	W+6
TV Display	22	23	24	25	26	27	28	29	30	31	32	33	34	35	36	37	38	39	40	41	42
CATV channel	W+7	W+8	W+9	W+10	W+11	W+12	W+13	W+14	W+15	W+16	W+17	W+18	W+19	W+20	W+21	W+22	W+23	W+24	W+25	W+26	W+27
TV Display	43	44	45	46	47	48	49	50	51	52	53	54	55	56	57	58	59	60	61	62	63
CATV channel	W+28	W+29	W+30	W+31	W+32	W+33	W+34	W+35	W+36	W+37	W+38	W+39	W+40	W+41	W+42	W+43	W+44	W+45	W+46	W+47	W+48
TV Display	64	65	66	67	68	69	70	71	72	73	74	75	76	77	78	79	80	81	82	83	84
CATV channel	W+49	W+50	W+51	W+52	W+53	W+54	W+55	W+56	W+57	W+58	A-5	A-4	A-3	A-2	A-1	W+59	W+60	W+61	W+62	W+63	W+64
TV Display	85	86	87	88	89	90	91	92	93	94	95	96	97	98	99	100	101	102	103	104	105
CATV channel	W+65	W+66	W+67	W+68	W+69	W+70	W+71	W+72	W+73	W+74	W+75	W+76	W+77	W+78	W+79	W+80	W+81	W+82	W+83	W+84	W+85
TV Display	106	107	108	109	110	111	112	113	114	115	116	117	118	119	120	121	122	123	124	125	126
CATV channel	W+86	W+87	W+88	W+89	W+90	W+91	W+92	W+93	W+94												
TV Display	127	128	129	130	131	132	133	134	135												

General Specifications

TV format: ATSC / NTSC-M TV standard

Closed caption system:

\$15.122/FCC (digital CC) \$15.119/FCC (analog CC)

Channel coverage (ATSC/NTSC):

Terrestrial VHF: 2~13 **UHF:** 14~69

CATV 2~13, A~W, W+1~W+94 (analog W+1~W+84), A-5~A-1, 5A

Tuning system: Channel frequency synthesized tuning system

Channel access: Direct access keyboard,

Programmable scan, and up/down

Terminals:

Antenna input: VHF/UHF/CATV 75Ω unbalanced (F-type)

S-video input: Mini DIN 4-pin jack x 1 Y: 1Vp-p (75Ω)
C: 286mVp-p (75Ω)

Video input: RCA jack x 1 1Vp-p (75Ω)

Audio input: RCA jack x 4 2V rms
(input impedance: more than 22kΩ)

Component video input:

RCA jack x 3 Y: 1Vp-p (75Ω)
Pb: 700mVp-p (75Ω)
Pr: 700mVp-p (75Ω)

Coaxial digital audio output:

RCA jack x1 500mVp-p (75Ω)

Headphone: 1/8 inches (3.5mm)

Electrical Specification

Sound output: 1W, 8Ω x 2

Other Specifications

Remote control: Digital encoded infrared light system

Operating temperature:

41°F (5°C) to 104°F (40°C)

Power requirements:

120V AC +/- 10%, 60Hz +/- 0.5%

Power consumption (maximum):

60W

LCD: 20 inches VGA panel (640 x 480 pixels)

Dimensions:*1 W: 21⁵/₁₆ inches (540mm)

H: 17³/₁₆ inches (435mm)

D: 8¹⁴/₁₆ inches (225mm)

Weight: 13.3 lbs. (6.0kg)

- Designs and specifications are subject to change without notice and without our legal obligation.
- If there is a discrepancy between languages, the default language will be English.

*1 The dimensional drawings are shown on the inside back cover.

Calling for Service

For location of the nearest Sharp Authorized Service, or to obtain product literature, accessories, supplies, or customer assistance please call 1-800-BE-SHARP.

Limited Warranty

CONSUMER LIMITED WARRANTY

SHARP ELECTRONICS CORPORATION warrants to the first consumer purchaser that this Sharp brand product (the "Product"), when shipped in its original container, will be free from defective workmanship and materials, and agrees that it will, at its option, either repair the defect or replace the defective Product or part thereof with a new or remanufactured equivalent at no charge to the purchaser for parts or labor for the period(s) set forth below.

This warranty does not apply to any appearance items of the Product nor to the additional excluded item(s) set forth below nor to any Product the exterior of which has been damaged or defaced, which has been subjected to improper voltage or other misuse, abnormal service or handling, or which has been altered or modified in design or construction.

In order to enforce the rights under this limited warranty, the purchaser should follow the steps set forth below and provide proof of purchase to the servicer.

The limited warranty described herein is in addition to whatever implied warranties may be granted to purchasers by law. ALL IMPLIED WARRANTIES INCLUDING THE WARRANTIES OF MERCHANTABILITY AND FITNESS FOR USE ARE LIMITED TO THE PERIOD(S) FROM THE DATE OF PURCHASE SET FORTH BELOW. Some states do not allow limitations on how long an implied warranty lasts, so the above limitation may not apply to you.

Neither the sales personnel of the seller nor any other person is authorized to make any warranties other than those described herein, or to extend the duration of any warranties beyond the time period described herein on behalf of Sharp.

The warranties described herein shall be the sole and exclusive warranties granted by Sharp and shall be the sole and exclusive remedy available to the purchaser. Correction of defects, in the manner and for the period of time described herein, shall constitute complete fulfillment of all liabilities and responsibilities of Sharp to the purchaser with respect to the Product, and shall constitute full satisfaction of all claims, whether based on contract, negligence, strict liability or otherwise. In no event shall Sharp be liable, or in any way responsible, for any damages or defects in the Product which were caused by repairs or attempted repairs performed by anyone other than an authorized servicer. Nor shall Sharp be liable or in any way responsible for any incidental or consequential economic or property damage. Some states do not allow the exclusion of incidental or consequential damages, so the above exclusion may not apply to you.

THIS WARRANTY GIVES YOU SPECIFIC LEGAL RIGHTS. YOU MAY ALSO HAVE OTHER RIGHTS WHICH VARY FROM STATE TO STATE.

Model Specific Section

Your Product Model Number & Description: _____

LC-20SH7U LCD Color Television

(Be sure to have this information available when you need service for your Product.)

Warranty Period for this Product: _____

One (1) year parts and ninety (90) days labor from the date of purchase.

Additional Item(s) Excluded from

Warranty Coverage (if any): _____

Non-rechargeable batteries.

Where to Obtain Service: _____

From a Sharp Authorized Servicer located in the United States. To find the location of the nearest Sharp Authorized Servicer, call Sharp toll free at 1-800-BE-SHARP.

What to do to Obtain Service: _____

Ship prepaid or carry in your Product to a Sharp Authorized Servicer. Be sure to have **Proof of Purchase** available. If you ship the Product, be sure it is insured and packaged securely.

TO OBTAIN PRODUCT INFORMATION, CALL 1-800-BE-SHARP OR VISIT www.sharppusa.com



SHARP ELECTRONICS CORPORATION

Sharp Plaza, Mahwah, New Jersey 07430-2135

SHARP CORPORATION

VALID IN CANADA ONLY

SHARP®

LIMITED WARRANTY

Consumer Electronics Products

Congratulations on your purchase!

Sharp Electronics of Canada Ltd. (hereinafter called "Sharp") gives the following express warranty to the first consumer purchaser for this Sharp brand product, when shipped in its original container and sold or distributed in Canada by Sharp or by an Authorized Sharp Dealer:

Sharp warrants that this product is free, under normal use and maintenance, from any defects in material and workmanship. If any such defects should be found in this product within the applicable warranty period, Sharp shall, at its option, repair or replace the product as specified herein.

This warranty shall not apply to:

- (a) Any defects caused or repairs required as a result of abusive operation, negligence, accident, improper installation or inappropriate use as outlined in the owner's manual.
- (b) Any Sharp product tampered with, modified, adjusted or repaired by any party other than Sharp, Sharp's Authorized Service Centres or Sharp's Authorized Servicing Dealers.
- (c) Damage caused or repairs required as a result of the use with items not specified or approved by Sharp, including but not limited to head cleaning tapes and chemical cleaning agents.
- (d) Any replacement of accessories, glassware, consumable or peripheral items required through normal use of the product including but not limited to earphones, remote controls, AC adapters, batteries, temperature probe, stylus, trays, filters, belts, ribbons, cables and paper.
- (e) Any cosmetic damage to the surface or exterior that has been defaced or caused by normal wear and tear.
- (f) Any damage caused by external or environmental conditions, including but not limited to transmission line/power line voltage or liquid spillage.
- (g) Any product received without appropriate model, serial number and CSA/cUL markings.
- (h) Any products used for rental or commercial purposes.
- (i) Any installation, setup and/or programming charges.

Should this Sharp product fail to operate during the warranty period, warranty service may be obtained upon delivery of the Sharp product together with proof of purchase and a copy of this LIMITED WARRANTY statement to an Authorized Sharp Service Centre or an Authorized Sharp Servicing Dealer. In home warranty service may be provided at Sharp's discretion on any Sharp television with the screen size of 27" or larger and on any Sharp Over-the-Range Microwave Oven.

This warranty constitutes the entire express warranty granted by Sharp and no other dealer, service centre or their agent or employee is authorized to extend, enlarge or transfer this warranty on behalf of Sharp. To the extent the law permits, Sharp disclaims any and all liability for direct or indirect damages or losses or for any incidental, special or consequential damages or loss of profits resulting from a defect in material or workmanship relating to the product, including damages for the loss of time or use of this Sharp product or the loss of information. The purchaser will be responsible for any removal, reinstallation, transportation and insurance costs incurred. Correction of defects, in the manner and period of time described herein, constitute complete fulfillment of all obligations and responsibilities of Sharp to the purchaser with respect to the product and shall constitute full satisfaction of all claims, whether based on contract, negligence, strict liability or otherwise.

WARRANTY PERIODS:

	Parts & Labour (exceptions noted)
Audio Products	1 year
Camcorder	1 year
DVD Products	1 year
Projector	1 year (lamp 90 days)
LCD & Plasma Display TV	1 year
Microwave Oven	1 year (magnetron component-4 additional years)
Television Products	1 year (picture tube component-1 additional year)
VCR Products	1 year
Vacuum Cleaner	1 year

To obtain the name and address of the nearest Authorized Sharp Service Centre or Dealer, please contact:
SHARP ELECTRONICS OF CANADA LTD. 335 Britannia Road East, Mississauga, Ontario L4Z 1W9

For more information on this Warranty, Sharp Extended Warranty Offers, Sharp Canada Products, Accessory Sales, Dealer or Service Locations, please call (905) 568-7140
Visit our Web site: www.sharp.ca



Revision 04/22/03

✓ **Dimensional Drawings**

Unit: inch / (mm)

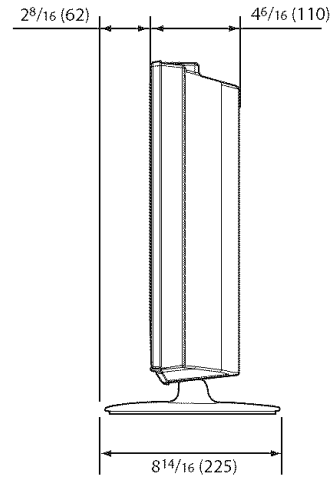
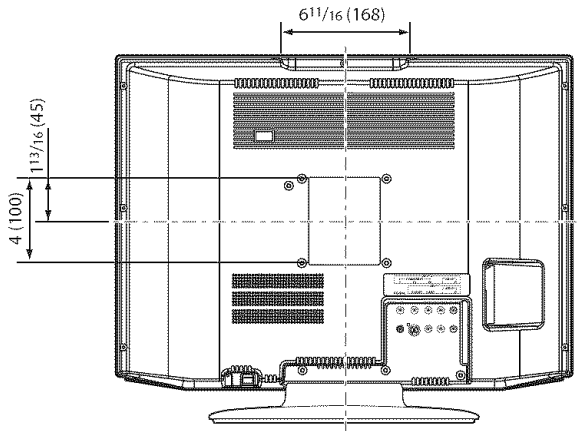
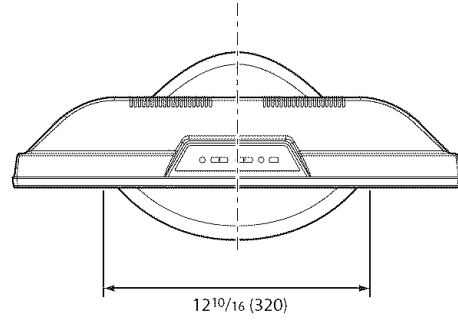
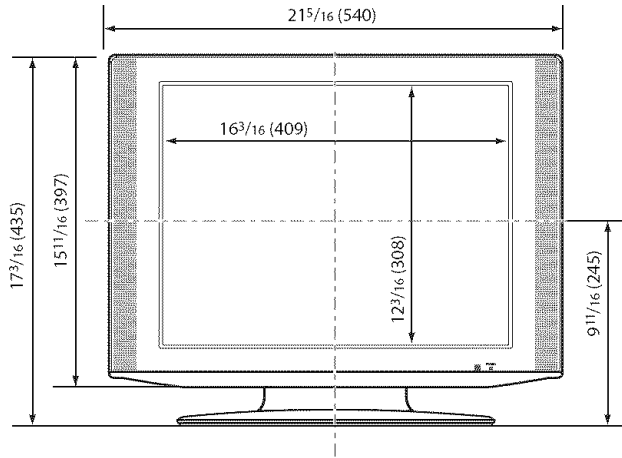

SHARP®

SHARP ELECTRONICS CORPORATION

Sharp Plaza, Mahwah, New Jersey 07430-2135

SHARP CORPORATION

Printed in China
Imprimé en Chine
Impreso en China
9HS1EMN22181
A7145UH
1EMN22181*****