

KitchenAid®

**BUILT-IN ELECTRIC CONVECTION
SINGLE AND DOUBLE OVENS
WITH STEAM ASSIST**

Use & Care Guide

For questions about features, operation/performance, parts, accessories or service, call: **1-800-422-1230**
or visit our website at **www.kitchenaid.com**

Table of Contents..... 2



Models KEBU107 KEBU208

8304531A

TABLE OF CONTENTS

OVEN SAFETY	3	STEAM-ASSISTED COOKING	18
PARTS AND FEATURES	4	Auto Steam.....	18
ELECTRONIC OVEN CONTROL	5	Auto Steam Settings	19
Control Panel.....	5	Manual Steam	20
Interactive Touch Display.....	5	Water Filter Cartridge Replacement	21
Main Menus.....	6	Keep Warm.....	21
Menu Demonstration.....	7	Temperature Probe	22
Settings	7	Timed/Delay Cooking.....	23
Sound (Tones)	8	Dehydrating	23
Display Contrast.....	8	COOKING CHARTS	24
Temp Format (Fahrenheit and Celsius).....	8	Bread Baking Chart.....	24
Calibration (Oven Temperature Control).....	8	Casseroles Baking Chart.....	24
Water Filter/Filtration System.....	8	Desserts Baking Chart	25
Learn Mode	9	Auto SteamVegetable Cooking Chart.....	26
Sabbath Mode.....	9	Auto Steam Seafood Cooking Chart	26
Languages.....	10	Manual Steam Cooking Chart.....	27
Clock	10	Meats and Poultry Roasting Chart.....	28
Start	11	OVEN CARE	30
Timer.....	11	Self-Cleaning Cycle.....	30
Lower Oven Off, Upper Oven Off and Off	11	General Cleaning	31
Control Lock.....	11	Oven Lights	32
OVEN USE	11	Oven Door	32
Aluminum Foil.....	11	TROUBLESHOOTING	33
Positioning Racks and Bakeware	11	ASSISTANCE OR SERVICE	34
Roll-out Rack.....	12	In the U.S.A.	34
Bakeware.....	13	In Canada	34
Meat Thermometer.....	13	WARRANTY	35
Oven Vent(s)	13		
Baking and Roasting	13		
Full and Center Broiling.....	14		
Convection Cooking.....	15		
Convection Bake.....	15		
Convection Roast.....	16		
Convection Broil.....	17		
EasyConvect™ Conversion.....	17		
Proofing Bread	18		

OVEN SAFETY

Your safety and the safety of others are very important.

We have provided many important safety messages in this manual and on your appliance. Always read and obey all safety messages.



This is the safety alert symbol.

This symbol alerts you to potential hazards that can kill or hurt you and others.

All safety messages will follow the safety alert symbol and either the word “DANGER” or “WARNING.” These words mean:

⚠ DANGER

You can be killed or seriously injured if you don't immediately follow instructions.

⚠ WARNING

You can be killed or seriously injured if you don't follow instructions.

All safety messages will tell you what the potential hazard is, tell you how to reduce the chance of injury, and tell you what can happen if the instructions are not followed.

IMPORTANT SAFETY INSTRUCTIONS

WARNING: To reduce the risk of fire, electrical shock, injury to persons, or damage when using the oven, follow basic precautions, including the following:

- Proper Installation – Be sure the oven is properly installed and grounded by a qualified technician.
- Never Use the Oven for Warming or Heating the Room.
- Do Not Leave Children Alone – Children should not be left alone or unattended in area where oven is in use. They should never be allowed to sit or stand on any part of the oven.
- Wear Proper Apparel – Loose-fitting or hanging garments should never be worn while using the oven.
- User Servicing – Do not repair or replace any part of the oven unless specifically recommended in the manual. All other servicing should be referred to a qualified technician.
- Storage in Oven – Flammable materials should not be stored in an oven.
- Do Not Use Water on Grease Fires – Smother fire or flame or use dry chemical or foam-type extinguisher.
- Use Only Dry Potholders – Moist or damp potholders on hot surfaces may result in burns from steam. Do not let potholder touch hot heating elements. Do not use a towel or other bulky cloth.
- Use Care When Opening Door – Let hot air or steam escape before removing or replacing food.
- Do Not Heat Unopened Food Containers – Build-up of pressure may cause container to burst and result in injury.

- Keep Oven Vent Ducts Unobstructed.
- Placement of Oven Racks – Always place oven racks in desired location while oven is cool. If rack must be moved while oven is hot, do not let potholder contact hot heating element in oven.
- DO NOT TOUCH HEATING ELEMENTS OR INTERIOR SURFACES OF OVEN – Heating elements may be hot even though they are dark in color. Interior surfaces of an oven become hot enough to cause burns. During and after use, do not touch, or let clothing or other flammable materials contact heating elements or interior surfaces of oven until they have had sufficient time to cool. Other surfaces of the oven may become hot enough to cause burns – among these surfaces are oven vent openings and surfaces near these openings, oven doors, and windows of oven doors.

For self-cleaning ovens:

- Do Not Clean Door Gasket – The door gasket is essential for a good seal. Care should be taken not to rub, damage, or move the gasket.
- Do Not Use Oven Cleaners – No commercial oven cleaner or oven liner protective coating of any kind should be used in or around any part of the oven.
- Clean Only Parts Listed in Manual.
- Before Self-Cleaning the Oven – Remove broiler pan and other utensils.

SAVE THESE INSTRUCTIONS

The California Safe Drinking Water and Toxic Enforcement Act requires the Governor of California to publish a list of substances known to the State of California to cause cancer, birth defects, or other reproductive harm, and requires businesses to warn of potential exposure to such substances.

WARNING: This product contains a chemical known to the State of California to cause cancer, birth defects, or other reproductive harm.

This appliance can cause low-level exposure to some of the substances listed, including benzene, formaldehyde, carbon monoxide, and toluene.

PARTS AND FEATURES

This manual covers different models. The oven you have purchased may have some or all of the items listed. The locations and appearances of the features shown here may not match those of your model.

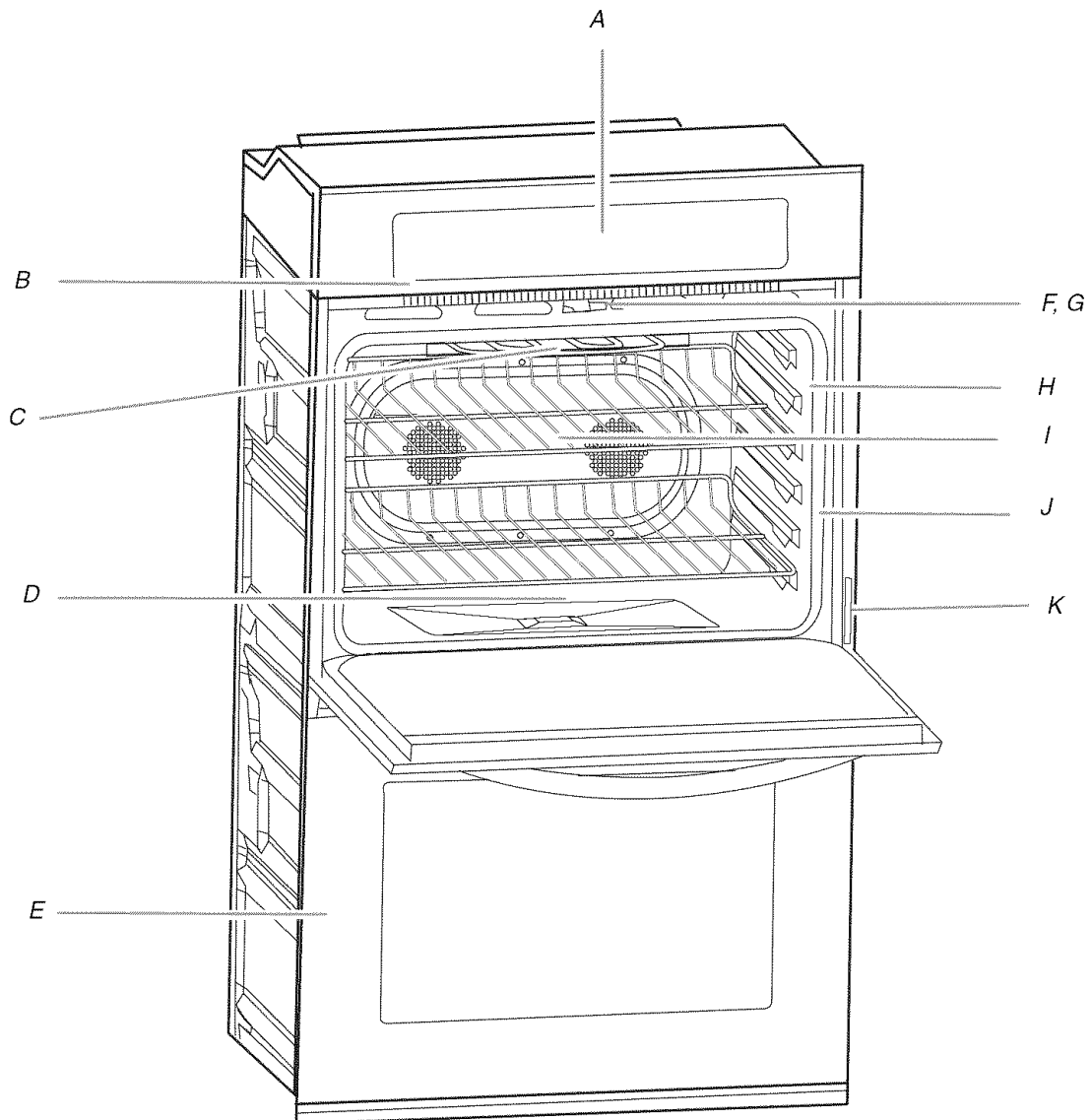

- A. Electronic oven control
- B. Oven vent
- C. Broil elements
- D. CleanBake™ bake element
- E. Lower oven (on double oven models)
- F. Automatic oven light switch

- G. Oven door lock latch
- H. Temperature probe jack
- I. Convection element and fan
- J. Gasket
- K. Model and serial number plate (on right mounting rail)

- Parts and Features not shown**
- Oven lights
 - Third oven rack (roll out rack)
 - Temperature probe
 - True-Broil™ reflector

ELECTRONIC OVEN CONTROL

This manual covers different models. The oven you have purchased may have some or all of the items listed. The locations and appearances of the items shown here may not match those of your model.

The oven's controls are accessed through its control panel and interactive touch display.

NOTE: Due to the sensitivity of the control panel, we have provided special instructions for cleaning the panel as well as the touch screen display. See "General Cleaning" section for cleaning instructions.

Single Oven Control Panel

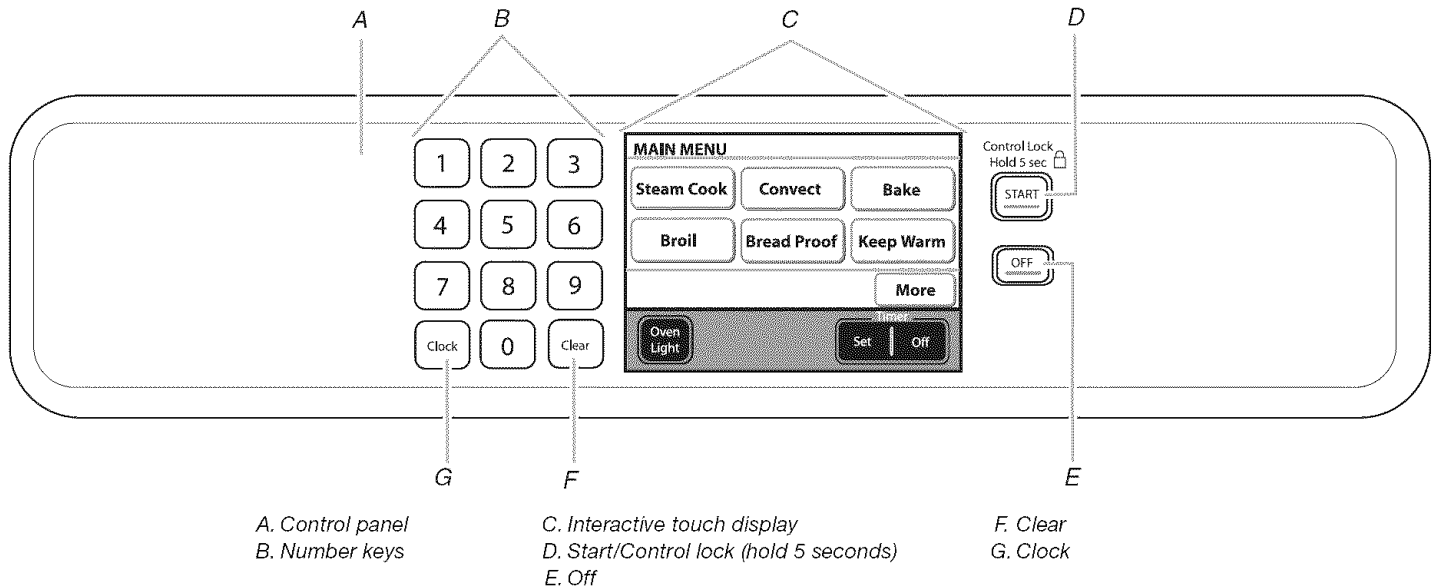

Double Oven Control Panel

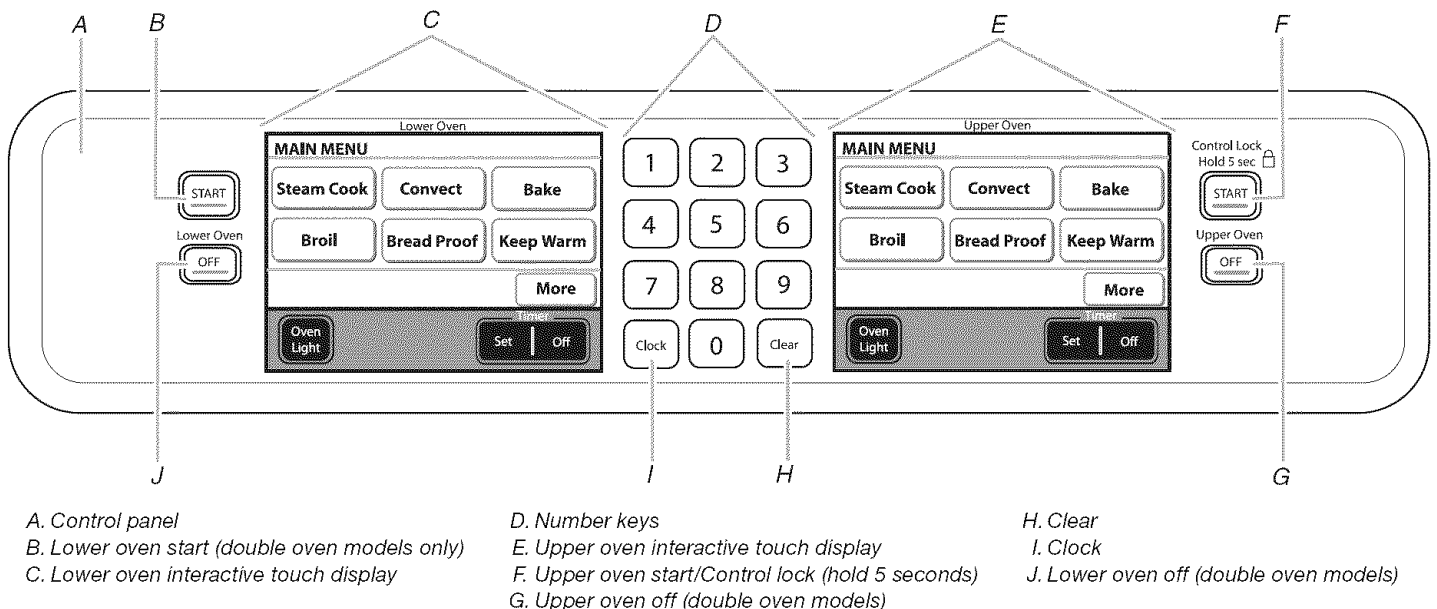

Control Panel

The control panel houses the control menu and function controls. The control pads are very sensitive, and require only a light touch to activate.

For more information about the individual controls, see their respective sections in this manual.

Interactive Touch Display

The display area functions as both a display and an interactive, menu-driven touch control. It is designed to be easily navigable, guiding you through the menus, offering multiple selections, accepting your input and executing your commands. It also provides instructions, tips and graphics. To view the main menu screens, see "Main Menu" section.

Display

When power is first supplied to the appliance or, when power has been interrupted for more than 10 seconds, the clock will be set to 12:00 P.M. To set the time, follow the instructions under "Clock" section. To bypass setting the clock and begin using the oven, touch Start, Off or Clear.

On double oven models, the left display shows the lower oven and the right display shows the upper oven.

When the oven(s) are in use (active mode), the display shows the oven temperature, heat source(s) and timer, if set.

After approximately 2 minutes of inactivity, the display will go into standby (sleep) mode. When the oven is in operation, the display will remain active.

On the single oven, if not in use (sleep mode), the display shows the time of the day. To turn the clock display on/off, see "Clock" section.

On the double oven, if not in use (sleep mode) the right display shows the time of day. To turn the clock display on/off, see "Clock" section.

During programming, the display shows menus and the appropriate selections for the respective cooking function.

Touch Screen

The LCD touch screen is used to make menu selections, adjust settings and input commands.

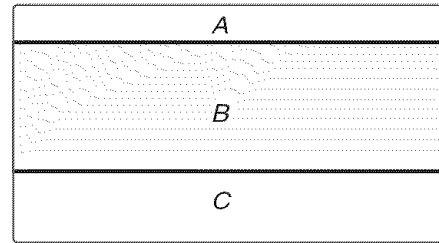

- A. Title/description region
- B. Menu and selection/settings input region
- C. Command input region

Menu selections and input adjustments are made in the center portion of the screen, and the command inputs (OK, Adjust Settings, Browning, Back, etc.) are made in the bottom portion of the screen. Screen titles and descriptions are displayed in the top portion of the screen, which accepts no input. A light to medium pressure touch of the fingertip will activate the menu selection.

Main Menu

From the Main Menu, all automatic cooking programs can be activated; all manual cooking can be programmed; settings can be adjusted; and instructions, preparation and tips can be accessed.

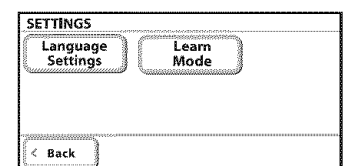
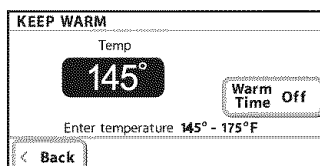
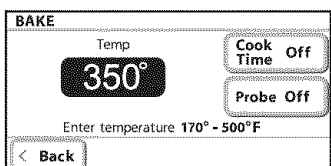
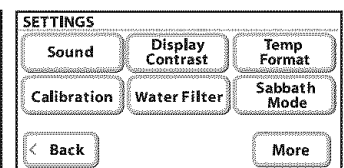
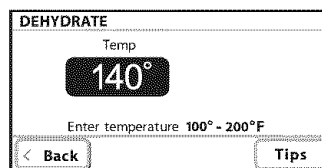
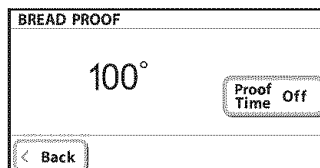
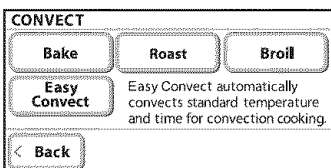
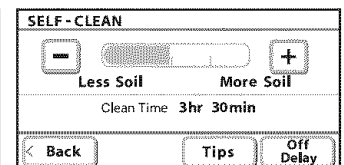
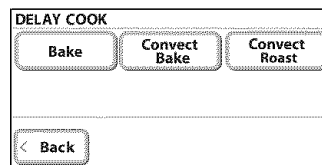
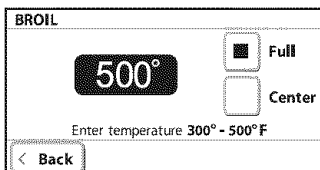
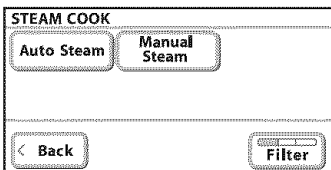
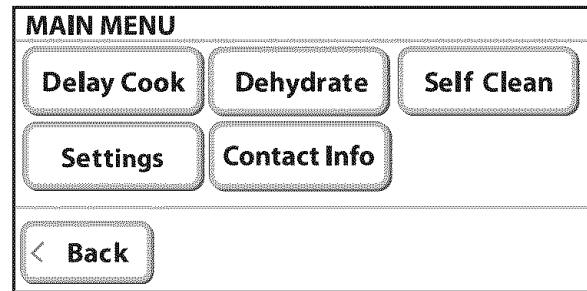
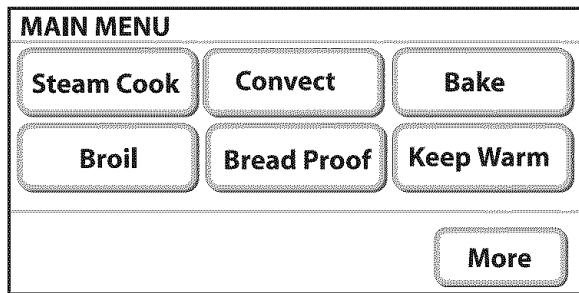

Menu Demonstration

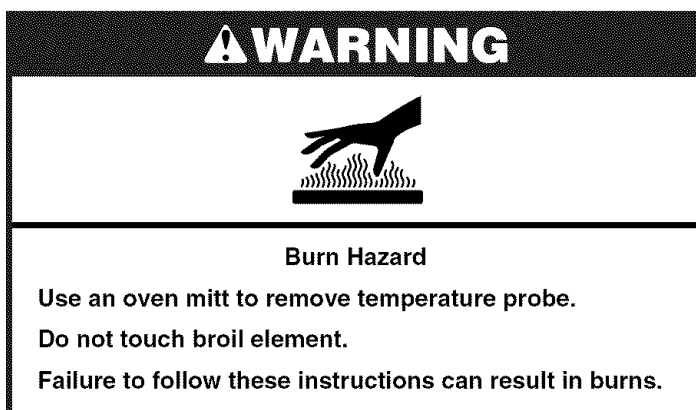

The following demonstrates how to cook a turkey from the Auto Steam menu using a temperature probe.

1. From the Main menu, touch STEAM COOK.

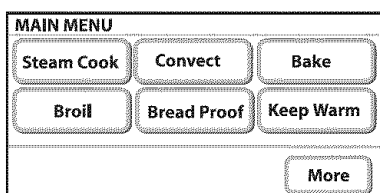

2. From the Main menu, touch AUTO STEAM.

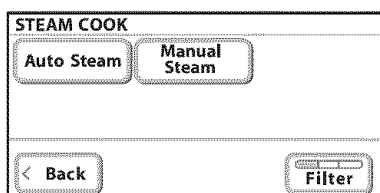

3. From the Main menu, touch POULTRY.

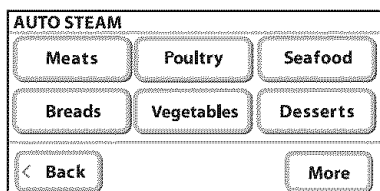

4. From the Auto Steam - Poultry menu, you can input a variety of selections. The menu will display the default settings.

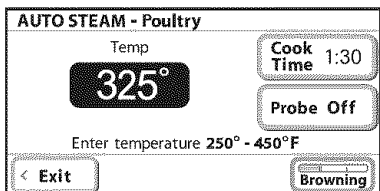

To change the temperature, input the desired temperature using the numerical keys.

5. To cook using the temperature probe, touch PROBE and enter the desired food temperature, using the numerical keys.

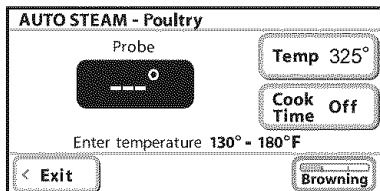

6. To change the level of browning, touch BROWNING. Touch “plus” (+) or “minus” (-) to increase or decrease the desired level. Touch OK.

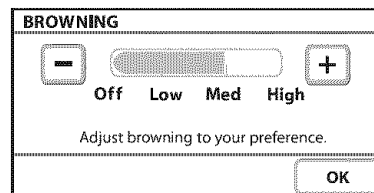

7. Once the setup is complete, the start key will light up. When settings are correct, touch START. You will be prompted to place the food in the oven and connect the temperature probe. Place the food in the oven, connect the temperature probe and touch OK.

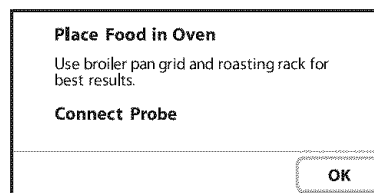

8. Once the oven starts running, the Off key will light up. Touch OFF if you need to shut the oven off during cooking.

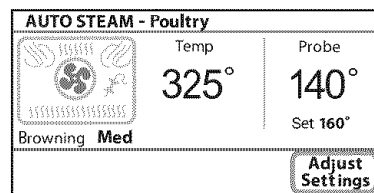

9. When the set probe temperature is reached, the Check Food message appears on the display. The probe temperature begins to blink and the end of cycle tone will sound. Touch OK.

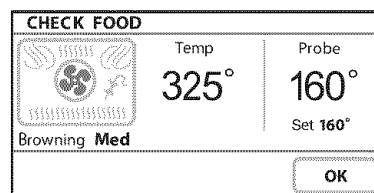

10. Touch OFF when finished cooking.

Always unplug and remove the temperature probe from the oven when removing food. The probe symbol will remain lit in the display until the probe is unplugged.

Settings

Your oven provides you with the ability to control several of the default settings and access information through the on screen display. These include; Sound, Display Contrast, Temp Format, Calibration, Water Filter, Learn Mode, Sabbath Mode, and Languages.

To access the Settings menu, see the following sections.

Sound (Tones)

Tones are audible signals, indicating the following:

One beep

- Valid key touch
- Function has been entered

One chime

- Preheat cycle has been completed

Two chimes

- End of a cooking cycle

Three beeps

- Invalid key touch

Four chimes

- When timer reaches zero
Includes using the Timer for functions other than cooking.

Tone Volume (Sound)

- The preset volume can be changed. On double ovens, you can change the sound from either display. Changing the sound on one display changes the sound for both ovens.

To Change:

1. From the Main menu, touch MORE.
2. Touch SETTINGS.
3. Touch SOUND.
4. To change the sound level, touch the “plus” (+) or “minus” (-) signs to increase or decrease to the desired level.
5. Touch OK.

NOTE: To turn the sound off touch - until the bar disappears to the left.

Display Contrast

To Adjust Display Contrast:

1. From the Main menu, touch MORE.
2. Touch SETTINGS.
3. Touch DISPLAY CONTRAST.
4. Touch + (plus) or - (minus) to increase/decrease the display contrast to the desired setting.
5. Touch OK.

Temp Format (Fahrenheit and Celsius)

The temperature is preset in Fahrenheit, however it can be changed to Celsius.

To Change:

1. From the Main menu, touch MORE.
2. Touch SETTINGS.
3. Touch TEMP FORMAT.
4. Touch °F (Fahrenheit) or °C (Celsius).
5. Touch OK.

Calibration (Oven Temperature Control)

IMPORTANT: Do not use a thermometer to measure oven temperature because opening the oven door during cycling may give incorrect readings.

The oven provides accurate temperatures; however, it may cook faster or slower than your previous oven, so the temperature calibration can be adjusted. It can be changed in Fahrenheit or Celsius.

A minus sign means the oven will be cooler by the displayed amount. The absence of a minus sign means the oven will be warmer by the displayed amount. Use the following chart as a guide.

ADJUSTMENT °F (AUTOMATIC °C CHANGE)	COOKS FOOD
10°F (5°C)	...a little more
20°F (10°C)	...moderately more
30°F (15°C)	...much more
0°F (0°C)	default setting
-10°F (-5°C)	...a little less
-20°F (-10°C)	...moderately less
-30°F (-15°C)	...much less

To Adjust Oven Temperature Calibration:

1. From the Main menu, touch MORE.
2. Touch SETTINGS.
3. Touch CALIBRATION
4. Touch the + (plus) or - (minus) to increase or decrease the temperature.
5. Touch OK.

Water Filter/Filtration System

The Water Filter setting allows you to check the status of the water filter and reset the system after the filter has been replaced.

IMPORTANT: The oven will shut off the steam functions until the filter is replaced.

To Check Filter Status:

1. From the main menu, touch MORE.
2. Touch SETTINGS.
3. Touch WATER FILTER.
4. The status will be displayed. There are 3 water filter states: Good, Replace Filter Soon and Replace Filter. If the filter status is Replace Filter Soon or Replace Filter, the Reset key becomes available.
NOTE: See “Water Filtration Replacement” section.
5. After replacing the filter, touch and hold RESET for approximately 3 seconds to reset the system. The status will change to Good.

NOTE: If you reset the system without replacing the filter, the system will continue to notify you that the filter needs to be replaced. The oven will shut off the steam functions until the filter is replaced. Continuing to reset the system without replacing the filter may cause damage to the oven.

For information on ordering replacement filters, touch ORDER INFO or see “Assistance or Service” section.

6. Touch OK to return to the Settings Menu.

NOTE: It is normal to hear sounds during steam cooking cycles related to the opening and closing of the water inlet valve and water flowing into the steam system.

Learn Mode

The oven has a learn mode which can show you the oven functions and allow you to become comfortable with the controls. When in the learn mode, the oven does not actually turn on and will not warm food.

To Use Learn Mode:

1. From the Main menu, touch MORE.
2. Touch SETTINGS.
3. Touch LEARN MODE.
4. The Learn Mode Main Menu will be displayed.

Sabbath Mode

The Sabbath Mode sets the oven(s) to remain on in a bake setting until turned off. A timed Sabbath Mode can also be set to keep the oven on for only part of the Sabbath.

When the Sabbath Mode is set, only the number and start keys will function, no tones will sound, and the displays will not show messages or temperature changes. The heat sources icons will appear lit on the oven display throughout the Sabbath Mode.

When the oven door is opened or closed, the oven light will not turn on or off and the heating elements will not turn on or off immediately.

If a power failure occurs when the Sabbath Mode is set, the oven(s) will remain in Sabbath Mode but will no longer be actively cooking. The "ON" indicator will no longer be lit. Touch OFF to return to normal operating mode (non-Sabbath Mode, not cooking).

⚠ WARNING



Burn Hazard

Use an oven mitt to remove temperature probe.

Do not touch broil element.

Failure to follow these instructions can result in burns.

NOTE: If you touch Sabbath Mode while the temperature probe is set, a message will appear saying "Probe not available". Remove the probe and touch Continue to enter the untimed Sabbath Mode. Touching Cancel returns you to the Bake mode.

To Enable:

Before the Sabbath Mode can be regularly set, the oven(s) must first be enabled with a one time only setup. On double oven models, each oven will need to be enabled independently.

1. From the Main menu, touch MORE.
2. Touch SETTINGS. Touch MORE.
3. Touch SABBATH MODE.
4. Touch Enable Sabbath Mode option when baking.
5. Touch OK.

To Disable:

The oven(s) can be disabled of the ability to set the Sabbath Mode by repeating the previous steps. See the "To Enable" section. When disabled "SABBATH DISABLED" will appear on the display and remain on for approximately 5 seconds.

The Sabbath Mode cannot be regularly set until re-enabled.

To Set Regularly Untimed:

Sabbath Mode must be enabled before starting the Bake cycle. See the "To Enable" section.

On double oven models only, each oven can be set independently.

1. From the Main menu, touch BAKE.
2. To change the preset temperature, enter the desired temperature using the numerical keys. The temperature can be set between 170°F and 500°F (77°C and 260°C).
3. Do not enter a cook time.
4. When settings are correct, touch START.
5. If the oven temperature is below the set temperature, the Preheat Bar will be displayed showing the status of the preheat cycle. When preheat is complete a tone will sound.
6. Once in the Bake cycle, a Sabbath Mode key will appear in the lower right hand corner of the display.
7. Touch SABBATH MODE. (If Sabbath Mode does not appear in the Bake cycle, refer to the "To Enable" section.)
8. Once in the Sabbath Mode, an End Sabbath key will appear in the lower right hand section of the display. Touch and hold the End Sabbath Mode to return to the regular Bake mode.
9. Touch Upper Oven OFF, Lower Oven OFF or OFF at anytime to turn the oven off.

To Regularly Set Timed:

⚠ WARNING

Food Poisoning Hazard

Do not let food sit in oven more than one hour before or after cooking.

Doing so can result in food poisoning or sickness.

Sabbath Mode must be enabled before starting the Bake cycle. See the "To Enable" section.

On double oven models only, each oven can be set independently.

1. From the Main menu, touch BAKE.
2. To change the preset temperature, enter the desired temperature using the numerical keys. The temperature can be set between 170°F and 500°F (77°C and 260°C).
3. To enter a cook time, touch COOK TIME. Enter the desired cook time using the numerical keys.
4. Once a cooking setup function is complete, the Start key will light up.
5. When settings are correct, touch START.
6. If the oven temperature is below the set temperature, the Preheat Bar will be displayed showing the status of the preheat cycle. When preheat is complete a tone will sound.

7. Once in the Bake cycle, a Sabbath Mode key will appear in the lower right hand corner of the display.
8. Touch SABBATH MODE. (If Sabbath Mode does not appear in the Bake cycle, refer to the "To Enable" section.)
9. Once in the Sabbath Mode, an End Sabbath key will appear in the lower right hand section of the display. Touch and hold the End Sabbath Mode for approximately 3 seconds to return to the regular Bake mode.
10. Once Cook Time has reached 0:00, the Sabbath Mode Complete message is displayed. The completed time information is updated every minute but no End of Cycle tone will sound.
11. Touching the End Sabbath key for approximately 3 seconds exits the Sabbath Mode and returns to the Main Menu.
12. Touch Upper Oven OFF, Lower Oven OFF or OFF at anytime to turn the oven off.

To Set Delayed:

Sabbath Mode must be enabled before starting the Bake cycle. See the "To Enable" section.

1. From the Main menu, touch BAKE.
2. Touch DELAY COOK.
3. Touch BAKE.
4. To change the preset temperature, enter the desired temperature using the numerical keys. The temperature can be set between 170°F and 500°F (77°C and 260°C).
5. Touch COOK TIME. Enter the desired cook time using the numerical keys.
6. Touch DELAY TIME. Enter the amount of time you wish to delay the start of cooking using the numerical keys.
7. Once a cooking setup function is complete, the Start key will light up.
8. When settings are correct, touch the Start key.
9. A Sabbath Mode key will appear in the lower right hand corner of the display.
10. Touch SABBATH MODE. (If Sabbath Mode does not appear in the Bake cycle, refer to the "To Enable" section.)
11. Once the delay time is reached, if the oven temperature is below the set temperature, the Preheat Bar will be displayed showing the status of the preheat cycle. When preheat is complete a tone will sound.
12. Once in the Sabbath Mode, an End Sabbath key will appear in the lower right hand section of the display. Touch and hold the End Sabbath Mode for approximately 3 seconds to return to the regular Bake mode.
13. Once Cook Time has reached 0:00, the Sabbath Mode Complete message is displayed. The completed time information is updated every minute but no End of Cycle tone will sound.
14. Touching the End Sabbath key for approximately 3 seconds exits the Sabbath Mode and returns to the Main Menu.
15. Touch Upper Oven OFF, Lower Oven OFF or OFF at anytime to turn the oven off.

Temperature Change

The oven temperature can be changed when the oven(s) are in the Sabbath Mode. No tones will sound, and the display will not change. The heating elements will not turn on or off for a random time, anywhere from 16 to 24 seconds. It may take up to one-half hour for the oven to change temperature.

Number keys 1 through 0 represent temperatures.

Use the following chart as a guide.

NUMBER KEY	OVEN TEMPERATURE
1	170°F (77°C)
2	200°F (95°C)
3	225°F (107°C)
4	250°F (120°C)
5	300°F (149°C)
6	325°F (163°C)
7	350°F (177°C)
8	375°F (191°C)
9	400°F (204°C)
0	450°F (232°C)

To Change Temperature:

On double oven models, both oven cavities can be set for independent temperatures. However, once Sabbath Mode is running, if the temperature is changed both cavities will use the new temperature.

1. Touch the number key from the chart.
2. Touch START.

Languages

To Change Language Setting:

1. From the Main menu, touch MORE.
2. Touch SETTINGS.
3. Touch LANGUAGES.
4. Touch ENGLISH or FRANÇAIS (French).
5. Touch OK.

Clock

This is a 12-hour clock. Before setting, make sure the oven(s), Timer and Timed Cooking are off.

To Set:

1. Touch CLOCK SET/START.
2. Enter the desired time by touching the numerical keys to set the time of day.
3. Touch AM or PM.
4. Touch OK.
5. To turn the clock display off, touch CLOCK SET/START.
6. Touch ON DISPLAY or OFF DISPLAY.
7. Touch OK.

Start

The START key begins all oven functions except Sabbath Mode. Once a cooking setup function is complete, the START key will light up until touched. If not touched within 2 minutes after entering a cooking function, the display will return to the sleep mode and the programmed function will be canceled.

Timer

The Timer is set in hours and minutes and counts down the set time. Times of more than one hour will count down by the minute. In the last hour, the time will count down by minute and second.

NOTE: The Timer does not start or stop the oven.

To Set:

1. Touch TIMER SET.
2. Use + (plus) or - (minus) keys to adjust the time or enter the desired timer setting by touching the numerical keys.
3. Touch START TIMER.
If Start Timer is not touched, the control will continue to wait. When the set time ends, if enabled, end-of-cycle tones will continuously repeat until the "Timer Off" key is touched.
4. Touch TIMER OFF anytime to cancel the Timer or stop the reminder tones.

If UPPER OVEN OFF or LOWER OVEN OFF key is touched, the respective oven will turn off; however, the timer can only be turned off using the Timer Off key.

Lower Oven Off, Upper Oven Off and Off

The LOWER OVEN OFF, UPPER OVEN OFF and OFF stop oven functions except for the Clock, Timer, and Control Lock. The oven cooling fan may continue to operate even after an oven function has been canceled or completed, depending on the oven temperature.

If the OFF key is touched, the cooking function will be canceled and the display will return to the Main Menu from any menu.

Control Lock

The Control Lock shuts down the control panel keys to avoid unintended use of the oven(s). The Control Lock will remain set after a power failure, if set before the power failure occurs.

When the control is locked, only the TIMER SET/START, TIMER OFF and OVEN LIGHT keys will function.

The Control Lock is preset unlocked, but can be locked.

To Lock Control: Touch and hold START for approximately 5 seconds, until "controls locked" and a lock icon appears in the display and a confirmation tone sounds indicating the oven control has been locked. "Controls locked" and lock icon will appear in the display for approximately 5 seconds.

If a key is touched while the controls are touched, the invalid key touch tone will sound and a reminder message will be displayed indicating the controls are locked.

To Unlock Control: Repeat to unlock the control. A tone will sound and a controls unlocked message will be displayed for approximately 5 seconds.

OVEN USE

Odors and smoke are normal when the oven is used the first few times, or when it is heavily soiled.

During oven use, the heating elements will not remain on, but will cycle on and off throughout oven operation.

IMPORTANT: The health of some birds is extremely sensitive to the fumes given off. Exposure to the fumes may result in death to certain birds. Always move birds to another closed and well-ventilated room.

The oven is equipped with a water filtration system. This system is required for the use of the steam cooking functionality.

IMPORTANT: The oven will shut off the steam functions until the filter is replaced.

The water filter needs to be changed occasionally. The life of the filter will depend on factors such as the amount of steam cooking done and the hardness of the water in your home. The oven has a sensor to determine when the filter needs to be changed.

NOTE: It is normal to hear sounds during steam cooking cycles related to the opening and closing of the water inlet valve and water flowing into the steam system.

Aluminum Foil

IMPORTANT: To avoid permanent damage to the oven bottom finish, do not line the oven bottom with any type of foil, liners or cookware.

- For best cooking results, do not cover entire rack with foil because air must be able to move freely.
 - To catch spills, place foil on rack below dish. Make sure foil is at least ½" (1.3 cm) larger than the dish and that it is turned up at the edges.
-

Positioning Racks and Bakeware

IMPORTANT: To avoid permanent damage to the porcelain finish, do not place food or bakeware directly on bottom of the oven.

RACKS

NOTES:

- Position racks before turning on the oven.
- Do not position racks with bakeware on them.
- Make sure racks are level.

To move a rack, pull it out to the stop position, raise the front edge, then lift out. Use the following illustration and charts as a guide.

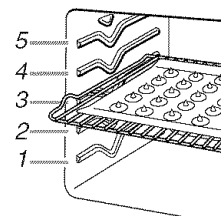

Traditional Cooking

FOOD	RACK POSITION*
Large roasts, turkeys, angel food, bundt cakes, quick breads, pies	1 or 2
Yeast breads, casseroles, meat and poultry	2
Cookies, biscuits, muffins, cakes	2 or 3

*On models with the CleanBake™ feature, foods may be placed on a lower rack position.

Convection Cooking

OVEN SETTING	NUMBER OF RACKS USED	RACK POSITION(S)
Convection Bake	1	1, 2 or 3
Convection Bake	2	2 and 4
Convection Bake	3	1, 3 and 5
Convection Roast	1	1, 2 or 3
Convection Broil	1	3 or 4

BAKEWARE

To cook food evenly, hot air must be able to circulate. For traditional cooking, allow 2" (5 cm) of space around bakeware and oven walls. For convection cooking, allow 1" (2.5 cm) of space around bakeware and oven walls. Use the following chart as a guide.

NUMBER OF PAN(S)	POSITION ON RACK
1	Center of rack.
2	Side by side or slightly staggered.
3 or 4	Opposite corners on each rack. Make sure that no bakeware piece is directly over another.

Roll-out Rack

The roll-out rack allows easy access to position and remove food in the oven. It can be used in rack positions 1 through 4. Do not put the roll-out rack in position 5 because it will not fit.

Open Position

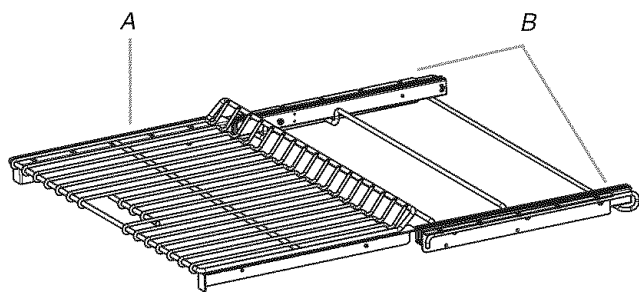

A. Roll-out rack
B. Sliding shelf

Closed and Engaged Position

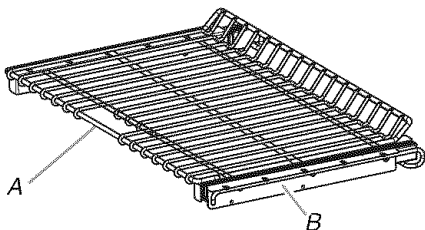

A. Roll-out rack
B. Sliding shelf

To Remove Roll-out Rack:

1. Slide the rack in completely so that it is closed and engaged with the sliding shelf.
2. Using 2 hands, lift up on the front edge of the rack and the sliding shelf together. Slowly push both to the back wall of the oven so the front edge of the sliding shelf sits on the rack guide located on the sides of the oven.

The front edge of the rack and the sliding shelf should be higher than the back edge.

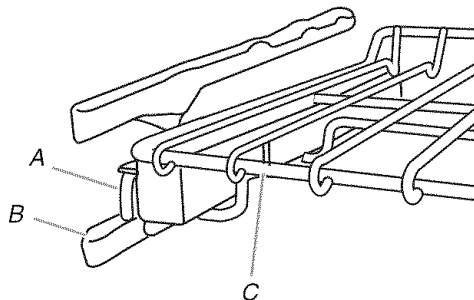

A. Sliding shelf
B. Rack guide
C. Roll-out rack

3. Using 2 hands, lift up the back of the rack and the sliding shelf so that the back and front are level on the rack guide.

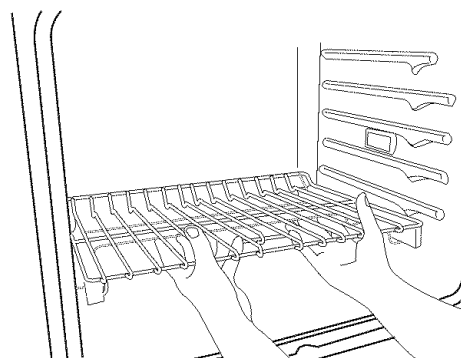

4. Pull the rack and the sliding shelf out.

To Replace Roll-out Rack

1. Using 2 hands, grasp the front of the closed rack and the sliding shelf. Place the closed rack and the sliding shelf on the rack guide.
2. Slowly push the rack and the sliding shelf to the back of the oven until the back edge of the sliding shelf drops.
3. Pull the rack and the sliding shelf slightly forward until the front edge drops and the sliding shelf is on the rack guide.

To avoid damage to the sliding shelves, do not place more than 25 lbs (11.4 kg) on the rack.

Do not clean the roll-out rack in a dishwasher. It may remove the rack's lubricant and affect its ability to slide.

See the "General Cleaning" section for more information.

Bakeware

The bakeware material affects cooking results. Follow manufacturer's recommendations and use the bakeware size recommended in the recipe. Use the following chart as a guide.

BAKEWARE/ RESULTS	RECOMMENDATIONS
Light colored aluminum <ul style="list-style-type: none"> Light golden crusts Even browning 	<ul style="list-style-type: none"> Use temperature and time recommended in recipe.
Dark aluminum and other bakeware with dark, dull and/or nonstick finish <ul style="list-style-type: none"> Brown, crisp crusts 	<ul style="list-style-type: none"> May need to reduce baking temperatures 25°F (15°C). Use suggested baking time. For pies, breads and casseroles, use temperature recommended in recipe. Place rack in center of oven.
Insulated cookie sheets or baking pans <ul style="list-style-type: none"> Little or no bottom browning 	<ul style="list-style-type: none"> Place in the bottom third of oven. May need to increase baking time.
Stainless steel <ul style="list-style-type: none"> Light, golden crusts Uneven browning 	<ul style="list-style-type: none"> May need to increase baking time.
Stoneware/Baking stone <ul style="list-style-type: none"> Crisp crusts 	<ul style="list-style-type: none"> Follow manufacturer's instructions.
Ovenproof glassware, ceramic glass or ceramic <ul style="list-style-type: none"> Brown, crisp crusts 	<ul style="list-style-type: none"> May need to reduce baking temperatures 25°F (15°C).

Meat Thermometer

Use a meat thermometer to determine doneness of meat, poultry and fish. The internal temperature, not appearance, should be used to determine doneness. A meat thermometer is not supplied with this appliance.

- Insert the thermometer into the center of the thickest portion of the meat or inner thigh or breast of poultry. The tip of the thermometer should not touch fat, bone or gristle.
- After reading the thermometer once, push it into the meat ½" (1.3 cm) more and read again. If the temperature drops, cook the meat or poultry longer.
- Check all meat, poultry and fish in 2 or 3 different places.

Oven Vent(s)

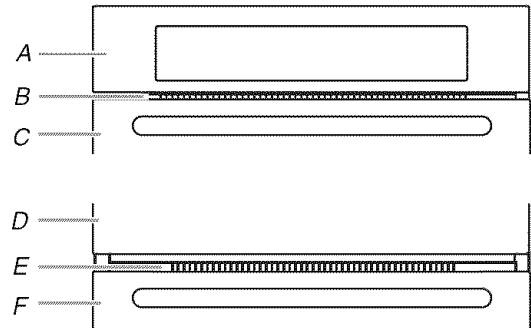

Single and Double Oven

- A. Control panel
- B. Oven vent
- C. Single oven or upper double oven

Double Oven

- D. Upper oven
- E. Oven vent
- F. Lower oven

The oven vent(s) should not be blocked or covered since they allow the release of hot air and moisture from the oven. Blocking or covering vents will cause poor air circulation, affecting cooking and cleaning results.

Baking and Roasting

WARNING



Burn Hazard

Use an oven mitt to remove temperature probe.

Do not touch broil element.

Failure to follow these instructions can result in burns.

During baking or roasting, the bake and broil elements will cycle on and off in intervals to maintain the oven temperature.

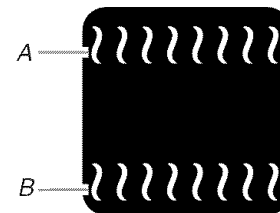

- A. Broil elements
- B. Bake element

If the oven door is opened during baking or roasting, the heating elements (bake, both broils, and convection fan) will turn off approximately 30 seconds after the door is opened. They will turn on again approximately 30 seconds after the door is closed.

To Bake or Roast:

Before baking or roasting, position racks according to the "Positioning Racks and Bakeware" section. When roasting, it is not necessary to wait for the oven to preheat before putting food in, unless recommended in the recipe.

1. From the Main menu, touch BAKE.
2. To change the preset temperature, enter the desired temperature using the numerical keys. The temperature can be set between 170°F and 500°F (77°C and 260°C).
3. To enter a cook time, touch COOK TIME. Enter the desired cook time using the numerical keys.
4. To use the temperature probe, touch PROBE and enter the desired food temperature using the numerical keys.
5. Once a cooking setup function is complete, the Start key will light up.
6. When settings are correct, touch START.
7. If the oven temperature is below the set temperature, the Preheat Bar will be displayed showing the status of the preheat cycle. When preheat is complete a tone will sound.
8. During the preheat and cooking cycle an Adjust Settings key appears on the lower right hand corner of the display. Touch ADJUST SETTINGS to change the desired time, temperature and/or probe settings. Touch START to enter new settings.
9. If the Cook Time has been set or the temperature probe has been used, the Check Food message will appear at the end of the cook time or once the set temperature has been reached.

If enabled, end-of-cycle tones will sound, then reminder tones will sound every minute. Touch OK to clear the message, stop reminder tones, and continue the current cooking cycle.

10. Touch OFF, UPPER OVEN OFF or LOWER OVEN OFF when finished cooking.

Full and Center Broiling

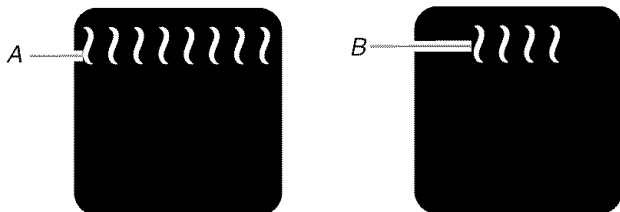

A. Full broil
B. Center broil

Broiling uses direct radiant heat to cook food.

During full broiling, both the inner and outer broil elements heat. During center broiling, only the inner broil element heats. The element(s) cycle on and off in intervals to maintain the oven temperature.

If the oven door is opened during broiling, the broil element(s) will turn off in approximately 30 seconds. When the oven door is closed, the elements will come back on approximately 30 seconds later.

- For best results, use a broiler pan and grid. It is designed to drain juices and help avoid spatter and smoke.

If you would like to purchase a Broiler Pan Kit, it may be ordered. See "Assistance or Service" section to order. Ask for Part Number W10123240.

- For proper draining, do not cover the grid with foil. The bottom of the broiler pan may be lined with aluminum foil for easier cleaning.

- Trim excess fat to reduce spattering. Slit the remaining fat on the edges to avoid curling.
- Pull out oven rack to stop position before turning or removing food. Use tongs to turn food to avoid the loss of juices. Very thin cuts of fish, poultry or meat may not need to be turned.
- After broiling, remove the pan from the oven when removing the food. Drippings will bake on the pan if left in the heated oven, making cleaning more difficult.

To Broil:

Before broiling, position rack according to the Broiling Chart.

When broiling, changing the temperature allows more precise control. The lower the temperature, the slower the cooking. Thicker cuts and unevenly shaped pieces of meat, fish and poultry may cook better at lower broiling temperatures.

Position food on the grid on the broiler pan, then place it in the center of the oven rack with the longest side parallel to the door. It is not necessary to wait for the oven to preheat before putting food in, unless recommended in the recipe.

Close the door.

1. From the Main menu, touch BROIL.
2. To change the preset temperature, enter the desired temperature using the numerical keys. The broil temperature can be set between 300°F and 500°F (149°C and 260°C).
3. The oven defaults to Full broil. Touch CENTER if desired.
4. Once a cooking setup function is complete, the Start key will light up.
5. When settings are correct, touch START.
6. During the cooking cycle an Adjust Settings key appears on the lower right hand corner of the display. Touch ADJUST SETTINGS to change the desired temperature and/or Full/Center settings. Touch START to enter new settings.
7. Touch OFF, UPPER OVEN OFF or LOWER OVEN OFF when finished cooking.

BROILING CHART

For best results, place food 3" (7 cm) or more from the broil elements, rack position 4 is recommended. For diagram, see the "Positioning Racks and Bakeware" section.

A temperature setting of 500°F (260°C) is recommended.

Times are guidelines only and may need to be adjusted for individual foods and tastes.

FOOD	COOK TIME (in minutes)
Beef	
Steak 1" to 1¼" (2.5 cm to 3 cm) thick	
medium-rare	15-17
medium	17-19
well-done	20-24
Pork	
Pork chops 1" (2.5 cm) thick	
medium	16-18
Lamb	
Lamb chops 1" (2.5 cm) thick	
medium-rare	10-12
medium	11-13

FOOD	COOK TIME (in minutes)
Ground Meats	
Ground beef, pork or lamb patties* ¾" (2 cm) thick well-done	16-18
Chicken	
Chicken bone-in pieces (2" to 2½" [5 cm to 6.3 cm])	20-30
boneless pieces (4 oz., [113 g])	12-15
Fish	
Fish ½" to ¾" (1.25 to 2 cm) thick	6-9

*Place up to 12 patties, equally spaced, on broiler grid.

Convection Cooking

In a convection oven, the fan-circulated hot air continually distributes heat more evenly than the natural movement of air in a standard thermal oven. This movement of hot air helps maintain a consistent temperature throughout the oven, cooking foods more evenly, crisping surfaces while sealing in moisture and yielding crustier breads.

Most foods can be cooked by lowering cooking temperatures 25°F to 50°F (14°C to 28°C), and cooking time can be shortened by as much as 30 percent, especially for large turkeys and roasts.

- It is important not to cover foods with lids or aluminum foil so that surface areas remain exposed to the circulating air, allowing browning and crisping.
- Keep heat loss to a minimum by opening the oven door only when necessary.
- Choose cookie sheets without sides and roasting pans with lower sides to allow air to move freely around the food.
- Test baked goods for doneness a few minutes before the minimum cooking time with an alternative method such as using a toothpick.

⚠ WARNING



Burn Hazard

Use an oven mitt to remove temperature probe.

Do not touch broil element.

Failure to follow these instructions can result in burns.

- Use a meat thermometer or the temperature probe to determine the doneness of meats and poultry. Check the temperature of pork and poultry in 2 or 3 places.

Convection Bake

⚠ WARNING



Burn Hazard

Use an oven mitt to remove temperature probe.

Do not touch broil element.

Failure to follow these instructions can result in burns.

The T.H.E.™ (Third Hidden Element) convection element is hidden in the rear panel of the oven cavity, and assisted by the convection fan, provides balanced, efficient heating.

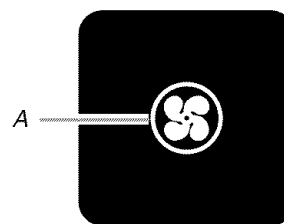

A. T.H.E.™ Convection element (hidden) and fan

Convection baking can be used for baking delicate cakes and pastries, as well as foods on multiple racks. It is helpful to stagger items on the racks to allow a more even flow of heat. If the oven is full, extra cooking time may be needed.

When cooking an oven meal with several different types of foods, be sure to select recipes that require similar temperatures. Cookware should sit in the oven with at least 1" (2.5 cm) of space between the cookware and the sides of the oven.

During convection baking preheat, the T.H.E.™ convection element and broil element and the CleanBake™ element all heat the oven cavity. After preheat, the T.H.E.™ convection element and the CleanBake™ element, and the fan will cycle on and off in intervals to maintain oven temperature.

If the oven door is opened during convection baking, the fan turns off immediately when the door is opened and turns on immediately when the door is closed. Convection, Bake and Broil (only during preheating) elements will turn off approximately 30 seconds after the door is opened. They will turn on again approximately 30 seconds after the door is closed.

- Reduce recipe temperature 25°F (14°C). The cook time may need to be reduced also.

To Convection Bake:

Before convection baking, position racks according to the "Positioning Racks and Bakeware" section. When using 2 racks, place on guides 2 and 4. When using 3 racks, place on guides 1, 3 and 5.

1. From the Main menu, touch CONVECTION BAKE.
2. To change the preset temperature, enter the desired temperature on the numerical keys. The convection bake temperature can be set between 170°F and 500°F (77°C and 260°C).

3. To set the cook time, touch COOK TIME. Enter the desired cook time using the numerical keys.
4. To use the temperature probe, touch PROBE and enter the desired food temperature using the numerical keys.
5. Once a cooking setup function is complete, the Start key will light up.
6. When settings are correct, touch START.
7. During the preheat and cooking cycle an Adjust Settings key appears on the lower right hand corner of the display. Touch ADJUST SETTINGS to change the desired time, temperature and/or probe settings. Touch START to enter new settings.
8. If the oven temperature is below the set temperature, the Preheat Bar will be displayed showing the status of the preheat cycle. When preheat is complete a tone will sound
9. If the Cook Time has been set or the temperature probe has been used, the Check Food message will appear at the end of the cook time or once the set temperature has been reached.
If enabled, end-of-cycle tones will sound, then reminder tones will sound every minute. Touch OK to clear the message, stop reminder tones, and continue the current cooking cycle.
10. Touch OFF, UPPER OVEN OFF or LOWER OVEN OFF when finished cooking.

If the oven door is opened during convection roasting, the fan turns off immediately when the door is opened and turns on immediately when the door is closed. Broil and bake elements will turn off approximately 30 seconds after the door is opened. They will turn on again approximately 30 seconds after the door is closed.

- Reduce recipe temperature 25°F (14°C). The cook time may need to be reduced also.
- For best results, use a broiler pan, grid and roasting rack, designed to drain juices and help avoid spatter and smoke.

If you would like to purchase a Broiler Pan Kit, it may be ordered. See "Assistance or Service" section to order. Ask for Part Number W10123240.

To Convection Roast:

Before convection roasting, position racks according to the "Positioning Racks and Bakeware" section. It is not necessary to wait for the oven to preheat before putting food in, unless recommended in the recipe.

Use the roasting rack on top of the broiler pan and grid. This holds the food above the grid and allows air to circulate completely around all surfaces.

If you would like to purchase a Broiler Pan Kit, it may be ordered. See "Assistance or Service" section to order. Ask for Part Number W10123240.

Convection Roast

⚠ WARNING



Burn Hazard

Use an oven mitt to remove temperature probe.

Do not touch broil element.

Failure to follow these instructions can result in burns.

Convection roasting can be used for roasting meats and poultry, or for baking yeast breads and loaf cakes using a single rack. During convection roasting, the CleanBake™ and broil elements will cycle on and off in intervals to maintain oven temperature, while the fan constantly circulates the hot air.

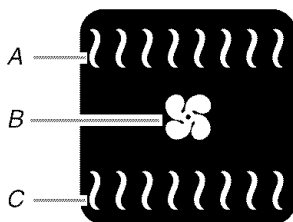

A. Broil heat
B. Convection fan
C. Bake heat

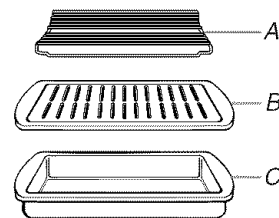

A. Roasting rack
B. Broiler grid
C. Broil pan

1. From the Main menu, touch CONVECTION ROAST.
2. To change the preset temperature, enter the desired temperature on the numerical keys. The convection roast temperature can be set between 170°F and 500°F (77°C and 260°C).
3. To change the cook time, touch COOK TIME. Enter the desired cook time using the numerical keys.
4. To use the temperature probe, touch PROBE and enter the desired food temperature using the numerical keys.
5. Once a cooking setup function is complete, the Start key will light up.
6. When settings are correct, touch START.
7. During the preheat and cooking cycle an Adjust Settings key appears on the lower right hand corner of the display. Touch ADJUST SETTINGS to change the desired time, temperature and/or probe settings. Touch START to enter new settings.

8. If the oven temperature is below the set temperature, the Preheat Bar will be displayed showing the status of the preheat cycle. When preheat is complete a tone will sound.
9. If the Cook Time has been set or the temperature probe has been used, the Check Food message will appear at the end of the cook time or once the set temperature has been reached.
If enabled, end-of-cycle tones will sound, then reminder tones will sound every minute. Touch OK to clear the message, stop reminder tones, and continue the current cooking cycle.
10. Touch OFF, UPPER OVEN OFF or LOWER OVEN OFF when finished cooking.

Convection Broil

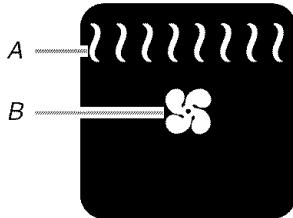

A. Broil heat
B. Convection fan

During convection broiling, the broil elements will cycle on and off in intervals to maintain oven temperature, while the fan constantly circulates the hot air.

The temperature is preset at 450°F (232°C), but can be changed to a different temperature. Cooking times will vary depending on the rack position and temperature and may need to be adjusted.

If the oven door is opened during convection broiling, the fan turns off immediately when door is opened and turns on again immediately when door is closed. Broil elements will turn off approximately 30 seconds after the door is opened. They will turn on again approximately 30 seconds after the door is closed.

To Convection Broil:

Before convection broiling, see “Full and Center Broiling” section for general broiling guidelines. Position rack.

Allow the oven to preheat for 5 minutes. Position food on the unheated grid on the broiler pan, then place it in the center of the oven rack with the longest side parallel to the door.

Close the door.

1. From the Main menu, touch CONVECTION BROIL.
2. To change the preset temperature, enter the desired temperature on the numerical keys. The convection broil temperature can be set between 300°F and 500°F (149°C and 260°C).
3. Once a cooking setup function is complete, the Start key will light up.
4. When settings are correct, touch START.
5. Touch OFF, UPPER OVEN OFF or LOWER OVEN OFF when finished cooking.

EasyConvect™ Conversion

Convection temperatures and times differ from those of standard cooking. The oven can automatically reduce standard recipe temperatures and times for convection cooking.

The conversion may not be exact because foods are grouped in general categories. To ensure optimal cooking results, the oven will prompt a food check at the end of a non-delayed cook time. Use the following chart as a guide.

SETTING	FOODS
Meats & Poultry	Roasts: Pork, Beef and Ham Chicken: Whole and Pieces Meat Loaf Baked potatoes Turkey and large poultry are not included because their cook times vary.
Cookies & Cakes	Cookies, Cakes
Pizza & Snack Foods	Pizza, Convenience foods: french fries, nuggets, and fish sticks
Biscuits & Bread	Biscuits, Breads: Quick and Yeast
Casseroles & Fish	Fish, Casseroles: Including frozen entrees and soufflés
Pies	Pies: Fruit and Custard

To Use:

1. From the Main menu, touch CONVECT.
2. Touch EASYCONVECT.
3. Select the appropriate food category using the chart as a reference.
4. Enter the standard temperature using the numerical keys.
5. Enter the standard cook time using the numerical keys.
6. Once a cooking setup function is complete, the Start key will light up.
7. When settings are correct, touch START. The control will automatically adjust the time and/or temperature for convection cooking.
8. If the oven temperature is below the set temperature, the Preheat Bar will be displayed showing the status of the preheat cycle. When preheat is complete a tone will sound.
9. During the preheat and cooking cycle an Adjust Settings key appears on the lower right hand corner of the display. Touch ADJUST SETTINGS to change the desired time and temperature. Touch START to enter new settings.
10. The Check Food message will appear at the end of the cook time or once the set temperature has been reached.
If enabled, end-of-cycle tones will sound, then reminder tones will sound every minute. Touch OK to clear the message, stop reminder tones, and continue the current cooking cycle.
11. Touch OFF, UPPER OVEN OFF or LOWER OVEN OFF when finished cooking.

Proofing Bread

Proofing bread prepares dough for baking by activating the yeast. Proofing twice is recommended.

To Proof:

Before first proofing, place dough in a lightly greased bowl and cover loosely with wax paper coated with shortening. Place bowl on rack position 2. Place 2 cups (500 ml) of boiling water in broiler pan or cake pan and place on rack position 1. See "Positioning Racks and Bakeware" for diagram. Close door.

1. From the main menu, select Bread Proof. The display will show 100°F (38°C).
2. To set a proof time, touch PROOF TIME.
3. Enter the desired time using the numerical keys.
4. Once a proofing setup function is complete, the Start key will light up.

5. When settings are correct, touch START.

Let dough rise until nearly doubled in size, check at 20 to 25 minutes. Proofing time may vary depending on dough type and quantity.

6. If the Proof Time has been set, the Check Food message will appear at the end of the cook time.

If enabled, end-of-cycle tones will sound, then reminder tones will sound every minute. Touch OK to clear the message, stop reminder tones, and continue the current cooking cycle.

7. Touch OFF, UPPER OVEN OFF or LOWER OVEN OFF when finished proofing.

Before second proofing, shape dough, place in baking pan(s) and cover loosely with plastic wrap coated with cooking spray. Follow same placement, pan and water and control steps above. Before baking, remove plastic wrap.

STEAM-ASSISTED COOKING

Steam-assisted cooking builds on the benefits of convection cooking by helping to retain moisture, texture and flavor in food. Steam or moisture is automatically added during the cooking cycles.

There are 2 categories of steam-assisted cooking: Auto Steam and Manual Steam.

- Steam eliminates the need for the use of parchment paper wraps (for cooking fish), water baths and spritzing during the cooking process.
- When cooking with steam, place meat, poultry, seafood, vegetables, desserts, and casseroles into a cool oven. For best cooking results, allow the oven to cool down from previous cooking before steam cooking. If the oven temperature is above 170°F (77°C), a message will appear telling you the oven is above 170°F (77°C) and recommending you let it cool before proceeding.
- Optimum levels of moisture are introduced at the appropriate time during the cooking cycles.
- Specially developed cycles enhance browning on meats, poultry and bread.
- When baking bread, preheating is required.
- The convection fan will run continuously during all steam functions except Desserts. This function does not use the fan.

Reference the "Cooking Charts" section when using steam-assisted cooking and to help you convert your own recipes.

Auto Steam

Auto Steam has 7 settings: Meats, Poultry, Seafood, Breads, Vegetables, Desserts and Casseroles. Auto Steam settings have preset temperature and time settings to guide the cooking process. Choose the type of food being cooked, and a suggested temperature and time will appear on the display. If desired, both the temperature and time can be changed according to recipe recommendation.

NOTE: For optimal cooking results, avoid opening door during steam-assisted cooking. If the oven door is opened steam production is automatically shut off until the door is closed. If the door is opened during steam cooking a message will appear telling you the door is open and you must close the door to resume cooking.

Auto Steam Time and Temperature Chart

Auto Steam Function	Temperature	Browning	Cook Time	Probe
Meat	325°F (160°C)	High	1:30	Off
Poultry	325°F (160°C)	High	1:30	Off
Seafood	250°F (170°C)	Off	0:25	
Bread	400°F (205°C)		0:30	
Vegetables	250°F (135°C)	Off	0:20	
Dessert	275°F (135°C)		0:30	
Casseroles	350°F (160°C)	Off	0:30	

Auto Steam Settings

Meats

The Meats setting gives best results with tender cuts of meat that would typically be dry roasted.

The Meats setting has 2 phases. During the first phase, the oven temperature will automatically rise above the set temperature for optimal browning conditions.

- Most of the browning will occur during this phase; this is normal.

During the second phase, the temperature is reduced to the set temperature. Steam is added to provide a moist environment to maintain the juiciness of your meat.

- During this phase, very little exterior browning will occur.

NOTE: Restarting the cycle will overcook and/or overbrown food. Instead, change the time and/or temperature.

When using the Meats setting:

- For best results, use a broiler pan and grid, designed to drain juices and help avoid spatter and smoke.

If you would like to purchase a Broiler Pan Kit, it may be ordered. See "Assistance or Service" section to order. Ask for Part Number W10123240.

- Preheating is not recommended.
- Lower standard baking temperature by 25°F (15°C).
- Roasting time may need to be reduced by up to 20 percent compared to convection and traditional roasting times.
- Use a meat thermometer to gauge doneness of food.

With traditional roasting, standing time is included before carving. The internal temperature will usually increase 5°F to 10°F (2°C to 5°C) during standing time. When roasting with the Auto Steam Meats setting, the internal temperature may increase 15°F to 20°F (5°C to 10°C) during stand time; therefore, it is necessary to stop cooking and remove the meat at a lower internal temperature than with conventional roasting.

Poultry

The Poultry setting gives best results with poultry that would typically be roasted without steam.

The Poultry setting has 2 phases. During the first phase, the oven temperature will automatically rise above the set temperature for optimal browning conditions.

- Most of the browning will occur during this phase. This is normal.

During the second phase, the temperature is reduced to the set temperature. Steam is added to provide a moist environment to maintain the juiciness of your poultry.

- During this phase, very little exterior browning will occur.

NOTE: Restarting the cycle will overcook and/or overbrown food. Instead, change the time and/or temperature.

When using the Poultry setting:

- Use a broiler pan, grid and roasting rack for best results.
- Preheating is not recommended.
- Roasting time may need to be reduced up to 20 percent compared to convection and traditional roasting times.
- Use a meat thermometer to gauge doneness of food.

Seafood

The Seafood setting bakes at a lower temperature than traditional baking. This gives you moist, tender, evenly-cooked fish with results similar to those achieved when steaming fish in parchment paper. You can cook shellfish, fillets, steaks or whole fish with this setting.

- Use a broiler pan, grid and roasting rack or a low-sided baking pan for best results.
- Preheating is not recommended.
- Very little to no browning will occur throughout the cycle. If browning is desired, use a higher browning level. The fish will be moister than when conventional baking.

Breads

The Breads setting gives best results when baking yeast breads. With the addition of steam to the cycle, you no longer need to spritz with water or add moisture into the oven to achieve a crispy crust and moist interior.

- Preheating is required.
- Lower standard baking temperature by 25°F (15°C).
- Baking times may be slightly less than with standard baking.
- If you are using a baking stone, place it in the oven on rack position 1 before beginning the cycle. For other bread baking, use rack position 1 or 2.

The oven will preheat to a temperature higher than the set temperature. It will then begin adding steam so the bread dough will go into a moist, hot environment, which is best for rising and crust development.

After preheat, place the bread dough in the oven as quickly as possible and close the door. The oven temperature will reduce to the set temperature, and a small amount of moisture will be added. The remainder of the cycle is dry heat for optimal browning.

Vegetables

The Vegetables setting gives results similar to steaming on a cooktop or in a microwave. This setting also allows you to steam a larger quantity of vegetables than a cooktop or microwave.

- Preheating is not recommended.
- When steaming vegetables use the default setting of 250°F and arrange the vegetables in a single layer on a low-sided baking pan.
- Check vegetables for doneness early. Freshness of the vegetable affects the required cooking time.
- Steaming artichokes, beets, green beans and broccoli is not recommended.

Desserts

The Desserts setting gives best results for delicate desserts such as crème brulee and cheesecake that are typically baked in a water bath. This setting also works well for other custard based dishes, and souffles.

- Preheating is not recommended.
- Lower standard baking temperature by 25°F (15°C).
- Allows the center of a dessert to bake without overcooking the outer edges.
- It is not necessary to cook with a water bath.

Casseroles

The Casseroles setting allows you to bake an uncovered casserole without over browning the edges or drying it out.

- Preheating is not recommended.
- Covering the food is not recommended.
- Cooking time may need to be reduced up to 20 percent compared to traditional cooking times.
- Lower standard baking temperature by 25°F (15°C).
- Allows the center of the casserole to bake without overcooking the outer edges.
- Amount of browning can be controlled by adjusting the browning level.

To Cook with Auto Steam:

⚠ WARNING



Burn Hazard
Use an oven mitt to remove temperature probe.
Do not touch broil element.
Failure to follow these instructions can result in burns.

Before baking and roasting, position racks according to the "Positioning Racks and Bakeware" section.

1. From the Main menu, touch STEAM COOK.
2. Touch the Auto Steam Setting.
3. Touch the desired Auto Steam setting.
4. To change the temperature, enter the desired temperature using the numerical keys.
5. To change the cook time, touch COOK TIME. Enter the desired cook time using the numerical keys.
6. To use the temperature probe, touch PROBE and enter the desired food temperature using the numerical keys.
7. To change the level of browning, touch BROWNING. Touch the plus + (plus) or - (minus) to increase or decrease to the desired level. Touch OK.
8. Once a cooking setup function is complete, the Start key will light up.
9. When settings are correct, touch START.
A message will appear telling you to Place Food in Oven. Place the food in the oven and touch OK. Connect the temperature probe if appropriate.
10. During the cooking cycle an Adjust Settings key appears on the lower right hand corner of the display. Touch ADJUST SETTINGS to change the desired time, temperature, probe and/or Browning settings. Touch START to enter new settings.

11. If the Cook Time has been set or the temperature probe has been used, the Check Food message will appear at the end of the cook time or once the set temperature has been reached.

If enabled, end-of-cycle tones will sound, then reminder tones will sound every minute. Touch OK to clear the message, stop reminder tones, and continue the current cooking cycle.

12. Touch OFF, UPPER OVEN OFF or LOWER OVEN OFF when finished cooking.

NOTE: For breads, if the oven temperature is below the set temperature, the Preheat Bar will be displayed showing the status of the preheat cycle. When preheat is complete a tone will sound and message telling you to Place Food in Oven will appear.

Manual Steam

⚠ WARNING



Burn Hazard
Use an oven mitt to remove temperature probe.
Do not touch broil element.
Failure to follow these instructions can result in burns.

Manual steam allows you to set the temperature, cook time, preheat cycle, browning level, and the amount of steam used during the cooking process.

To Cook with Manual Steam:

Before baking and roasting, position racks according to the "Positioning Racks and Bakeware" section.

1. From the Main menu, touch STEAM COOK.
2. Touch the Manual Steam setting.
3. To change the temperature, enter the desired temperature using the numerical keys.
4. To change the cook time, touch COOK TIME. Enter the desired cook time using the numerical keys.
5. To use the temperature probe, touch PROBE and enter the desired food temperature using the numerical keys.
6. To preheat, touch PREHEAT. Touch ON. Touch OK.
7. To change the level of browning, touch BROWNING. Touch the + (plus) or - (minus) to increase or decrease to the desired level. Touch OK.
8. To change the level of steam intensity, touch STEAM. Touch the + (plus) or - (minus) to increase or decrease to the desired level. Touch OK.
9. Once a cooking setup function is complete, the Start key will light up.

10. When settings are correct, touch START.

A message will appear telling you to Place Food in Oven. Place the food in the oven and touch OK. Connect the temperature probe if appropriate.

11. During the preheat (if used) and cooking cycle an Adjust Settings key appears on the lower right hand corner of the display. Touch ADJUST SETTINGS to change the desired time, temperature, probe and/or Browning settings. Touch START to enter new settings.

12. If the Cook Time has been set or the temperature probe has been used, the Check Food message will appear at the end of the cook time or once the set temperature has been reached.

If enabled, end-of-cycle tones will sound, then reminder tones will sound every minute. Touch OK to clear the message, stop reminder tones, and continue the current cooking cycle.

13. Touch OFF, UPPER OVEN OFF or LOWER OVEN OFF when finished cooking.

NOTE: Preheating when cooking with steam is generally only recommended for breads. If preheat is selected and the oven temperature is below the set temperature, the Preheat Bar will be displayed showing the status of the preheat cycle. When preheat is complete a tone will sound and message telling you to Place Food in Oven will appear.

Water Filter Cartridge Replacement

Water filter cartridge should be replaced when “REPLACE FILTER” appears in the control panel display, or after 1 year of use.

Model W10049700 water filtration system, when used with replacement cartridge 8212695 conforms to NSF/ANSI 42 for specific performance claims as verified and substantiated by test data.

For further information or to order a replacement water filter cartridge visit www.whirlpool.com or call 1-866-986-3223. Ask for Part Number 8212695.

To Replace Water Filter:

Turn filter cartridge to the left to remove cartridge from the filter head.

Install new cartridge. Turn cartridge to the right to reattach to the filter head.

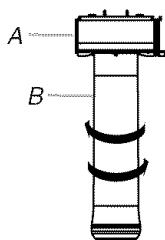

A. Filter head
B. Filter cartridge

If you need Assistance or Service:

Please reference the “Assistance or Service” section.

Keep Warm

⚠ WARNING

Food Poisoning Hazard

Do not let food sit in oven more than one hour before or after cooking.

Doing so can result in food poisoning or sickness.

IMPORTANT: Food must be at serving temperature before placing it in the warmed oven.

The steam-assisted Keep Warm function adds moisture into the oven to keep food from drying out, keeping food warm and moist before serving.

- Do not use Keep Warm to heat cold food. Use only cooked, hot foods with Keep Warm.
- Follow manufacturer's recommendations when warming empty serving bowls and plates.
- For best results, do not cover food with foil or lids.
- Use rack positions 1-4. Do not place food on top rack.
- Check food occasionally if left in the oven for more than 1 hour.
- For best results, hold food in Keep Warm for no longer than 4 hours.

The following chart provides recommendations for different foods within a range of temperatures. The temperature range can be set between 145°F and 200°F (63°C and 93°C). Use these temperatures as a guideline and adjust as required for smaller or larger pieces and quantities of food.

Keep Warm Chart

Setting	Recommended Foods
145°F-160°F (63°C-71°C)	Bread, rolls Fruit pies Coffee cake/pastries
165°F-180°F (74°C-82°C)	Appetizer Casseroles Custard, pumpkin pies Egg dishes Fish* Meats** Poultry Vegetables
185°F-200°F (85°C-93°C)	Bacon*** French toast Pancakes Waffles***

*Fish must be cooked thoroughly until opaque and flaky.

**Beef must be cooked to at least an internal temperature of 145°F (63°C).

***Arrange in a single layer on a wire cooling rack. Set rack on a baking sheet.

To Use:

1. From the Main menu, touch KEEP WARM.
2. To change the temperature, enter the desired temperature using the numerical keys.
3. To change the warm time, touch WARM TIME. Enter the desired warm time using the numerical keys.
4. Once a cooking setup function is complete, the Start key will light up.
5. When settings are correct, touch START.
6. During the warming cycle an Adjust Settings key appears on the lower right hand corner of the display. Touch ADJUST SETTINGS to change the desired time and/or temperature. Touch START to enter new settings.
7. If the Warm Time has been set, the Check Food message will appear at the end of the warm time has been reached. If enabled, end-of-cycle tones will sound, then reminder tones will sound every minute. Touch OK to clear the message, stop reminder tones, and continue the current cooking cycle.
8. Touch OFF, UPPER OVEN OFF or LOWER OVEN OFF when finished warming.

Temperature Probe

⚠ WARNING



Burn Hazard

Use an oven mitt to remove temperature probe.

Do not touch broil element.

Failure to follow these instructions can result in burns.

The temperature probe accurately measures the internal temperature of meat, poultry and casseroles with liquid and should be used in determining the doneness of meat and poultry. It should not be used during full and center broiling, convection broiling, dehydrating or proofing bread.

Always unplug and remove the temperature probe from the oven when removing food.

The temperature probe is available on most cycles including: Auto Steam, Manual Steam, Bake, Convection Bake, Convection Roast, and EasyConvection™ Conversion (Meats, Poultry, Casseroles, or Fish).

To Use:

Before using, insert the probe into the center of the thickest portion of meat or into the inner thigh or breast of poultry, away from fat or bone at an angle as shown in following diagram. Place food in oven and connect the temperature probe to the jack. Keep probe as far away from heat source as possible. Close oven door.

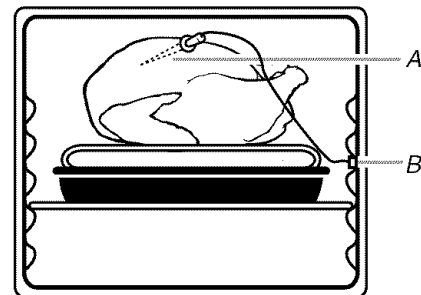

A. Temperature probe jack
B. Temperature probe

1. From the entry selection menu of those cooking functions where a temperature probe is used, touch PROBE.
2. Touch the number keys to enter a probe temperature, if other than 160°F (75°C). The probe temperature is the desired internal temperature of the food when it is done. The temperature can be set between 130°F and 180°F (55°C and 82°C).
NOTE: When using the probe, the Cook Time function may not be used.
3. If the probe is set and connected to the oven, the probe icon is displayed in the oven cavity icon.
If the probe is set and not connected to the oven, a "Probe Not Connected" message will be displayed. The probe icon will be displayed and the icon will blink until the probe is connected.
4. Once the Start key is touched, the probe display appears. If the current probe temperature is below 130°F (54°C), the display shows "Below 130°F (54°C)".
The display shows the current probe temperature once it reaches 130°F (54°C).
5. During cooking cycle an Adjust Settings key appears on the lower right hand corner of the display. Touch ADJUST SETTINGS to change the desired probe temperature. Touch START to enter new settings.
6. When the set probe temperature is reached, the Check Food message appears on the oven display, the probe temperature begins to blink.
If enabled, end-of-cycle tones will sound, then reminder tones will sound every minute. Touch OK to clear the message, stop reminder tones, and continue the current cooking cycle.
7. Touch OFF, UPPER OVEN OFF or LOWER OVEN OFF when finished cooking.
8. Always unplug and remove the temperature probe from the oven when removing food. The probe symbol will remain lit in the display until the probe is unplugged.

Timed/Delay Cooking

⚠ WARNING

Food Poisoning Hazard

Do not let food sit in oven more than one hour before or after cooking.

Doing so can result in food poisoning or sickness.

Timed Cooking allows the oven(s) to cook for a set length of time. Delay Cooking allows the oven(s) to be set to turn on at a certain time of day. Delay start should not be used for food such as breads and cakes because they may not bake properly.

Timed Cooking is available on most cycles including: Bake, Convection Bake, Convection Roast, Easy Convection™ Conversion, Bread Proof, and Keep Warm.

Delay Cooking is available on the Bake, Convection Bake, and Convection Roast cycles.

To Set a Cooking Time:

1. From the entry selection menu of those cooking functions where Cook Time is available, touch COOK TIME.
2. Use the numerical keys to input the desired cook time.
3. Once the Start key is touched, the cook time will be displayed.
4. During cooking cycle an Adjust Settings key appears on the lower right hand corner of the display. Touch ADJUST SETTINGS to change the desired cook time. Touch START to enter new settings.
5. When the end of the cook time is reached, the Check Food message will appear in the oven display.
If enabled, end-of-cycle tones will sound, then reminder tones will sound every minute. Touch OK to clear the message, stop reminder tones, and continue the current cooking cycle.
6. Touch OFF, UPPER OVEN OFF or LOWER OVEN OFF when finished cooking.

NOTE: For best cooking results, if the temperature probe is being used, the Cook Time function should not be used.

To Set a Delay Cooking Time:

Before setting, make sure the clock is set to the correct time of day. See "Clock" section.

1. From the Main menu, touch MORE.
2. Touch DELAY COOK.
3. Use the numerical keys to enter the desired delay time. For example, if you would like the oven to turn on in 1 hour and 20 minutes, enter 1:20.
4. Set the cooking time and adjust cooking temperature.
5. Once the Start key is touched, the Cooking Delayed message appears on the oven display, showing the settings.

A countdown timer will be displayed in the lower left hand portion of the display showing the time remaining until cooking begins.

6. When the start time is reached, the oven will automatically turn on. The minute time countdown will appear on the oven display.
7. When the end of the cook time is reached, the Check Food message will appear in the oven display.
If enabled, end-of-cycle tones will sound, then reminder tones will sound every minute. Touch OK to clear the message, stop reminder tones, and continue the current cooking cycle.
8. Touch OK, OFF, UPPER OVEN OFF or LOWER OVEN OFF when finished cooking.

Dehydrating

Dehydration is a method used to preserve food. Various factors, such as the quality of the fresh food, pretreatment techniques, the size and thickness of the food, and the climate may affect the finished product.

During dehydration, heat is used to force out moisture and air circulation is used to carry the moisture away.

Refer to a reliable book or source for complete information about dehydrating and preserving foods.

To Dehydrate:

Position the racks according to the following chart. See "Positioning Racks and Bakeware" section for diagram.

NUMBER OF RACKS	RACK POSITION(S)
1	3
2	2 and 4
3	1, 3 and 5

1. From the Main menu, touch MORE.
2. Touch DEHYDRATE.
3. To change the preset temperature, enter the desired temperature between 100°F and 200°F (100°C and 200°C) using the numerical keys.
4. During setup a Tips key appears on the lower right hand corner of the display. Touch TIPS to see tips for using the dehydration function.
5. During dehydration cycle an Adjust Settings key appears on the lower right hand corner of the display. Touch ADJUST SETTINGS to change the desired temperature.
6. Touch OFF, UPPER OVEN OFF or, LOWER OVEN OFF when finished dehydrating.

NOTE: The oven will automatically turn off after 12 hours. However, some foods may take more than 12 hours to dehydrate. If this is the case, the oven will need to be restarted.

COOKING CHARTS

Traditional baking oven temperatures and baking times from the recipe are given to help you learn to convert your own recipes.

Bread Baking Chart

For best cooking results, bake on rack positions 1 or 2.

Yeast Breads*

FOOD	OVEN TEMPERATURE	BAKING TIME (in minutes)
Basic White Bread (8½" x 4½" x 2½" [21.6 cm x 11.4 cm x 6.4 cm] pan)		
Recipe: Bake	400°F (200°C)	30
Auto Steam Breads	375°F (190°C)	25 or until golden brown
Sixty-Minute Rolls		
Recipe: Bake	425°F (220°C)	12
Auto Steam Breads	375°F (190°C)	12 or until golden brown
French Bread (approximately 1½ lbs [680 g] loaves)		
Recipe: Bake	450°F (230°C)	30
Auto Steam Breads	400°F (200°C)	30
Honey Oatmeal Bread (8½" x 4½" x 2½" [21.6 cm x 11.4 cm x 6.4 cm] pan)		
Recipe: Bake	375°F (190°C)	40
Auto Steam Breads	325°F (165°C)	35
Light Rye Bread (approximately 1¼ lbs [567 g] loaves)		
Recipe: Bake	350°F (175°C)	30-45
Auto Steam Breads	325°F (165°C)	36-38
Cinnamon Swirl Rounds (12 rolls in a 13" x 9" x 2" [33 cm x 22.9 cm x 5 cm] pan)		
Recipe: Bake	350°F (175°C)	20-25
Auto Steam Breads	325°F (165°C)	19-20

*Yeast bread recipes are from the KitchenAid Stand Mixer Instructions and Recipes, 2001, 9706634 Rev. A.

Casseroles Baking Chart

For best cooking results, bake Casseroles on rack positions 1 or 2.

FOOD	OVEN TEMPERATURE	BROWNING	BAKING TIME (in minutes)
Spicy Chicken and Rice – chicken pieces over rice/vegetable mixture (3 qt [2.8 L] rectangular baking dish)			
Recipe: Bake (covered)	375°F (190°C)		50-60
Auto Steam Casseroles	300°F (175°C)	Low	40-45 or until chicken is done and rice is tender
Macaroni and Cheese (1 qt [0.9 L] casserole)			
Recipe: Bake	350°F (175°C)		25-30
Auto Steam Casseroles	325°F (165°C)	Low	20 or until hot and bubbly
Tuna-Noodle – covered in bread crumbs (1½ qt [1.4 L] casserole)			
Recipe: Bake	375°F (190°C)		20
Auto Steam Casseroles	350°F (175°C)	Off	17 or until hot and bubbly
Hamburger Pie – hamburger/vegetable mix topped with mashed potato mounds (1½ qt [1.4 L] casserole)			
Recipe: Bake	375°F (190°C)		20-25
Auto Steam Casseroles	350°F (175°C)	Off	20 or until heated through

Desserts Baking Chart

For best cooking results, bake on rack positions 1 or 2.

FOOD	OVEN TEMPERATURE	BAKING TIME (in minutes)
Black Satin Fudge Cake (9" [22.9 cm] springform pan)		
Recipe: Bake (in waterbath)	350°F (175°C)	40-45
Auto Steam Desserts	300°F (150°C)	40-45 or until toothpick comes out slightly moist
Bread Pudding (8" x 8" x 2" [20.3 cm x 20.3 cm x 5 cm] baking dish)		
Recipe: Bake	325°F (165°C)	35-40
Auto Steam Desserts	300°F (150°C)	35 or until knife inserted in center comes out clean
Chocolate Souffle (2 qt [1.9 L] souffle dish)		
Recipe: Bake	375°F (190°C)	35-40
Auto Steam Desserts	325°F (165°C)	40-45 or until knife inserted under "top hat" comes out clean
Banana Souffle (1½ qt [1.4 L] souffle dish)		
Recipe: Bake	375°F (190°C)	35
Auto Steam Desserts	325°F (165°C)	37-40 or until golden brown
Cheese Souffle (2 qt [2 L] souffle dish)		
Recipe: Bake	350°F (175°C)	50
Auto Steam Desserts	325°F (165°C)	55 or until knife inserted near center comes out clean
Sweet Potato Puff (9" [22.9 cm] pie plate)		
Recipe: Bake	400°F (200°C)	30
Auto Steam Desserts	375°F (190°C)	28 or until set
Crème Brulee (6 oz [177.4 mL] cups)		
Recipe: Bake (in water bath)	250°F (120°C)	60-90
Auto Steam Desserts	250°F (120°C)	28 or until set
Cheesecake (9" [22.9 cm] springform pan)		
Recipe: Bake (in water bath)	325°F (165°C)	55-60
Auto Steam Desserts	275°F (135°C)	48 or until set

Auto Steam Vegetable Cooking Chart

FOOD	OVEN TEMPERATURE	BROWNING	COOKING TIME (in minutes)
Asparagus Spears	250°F (120°C)	Off	12-16
Acorn Squash 1-1½ lbs (454-680 g)	250°F (120°C)	Off	23-25
Carrots (whole)	250°F (120°C)	Off	20-22
Cauliflower (flowerets)	250°F (120°C)	Off	16-18
Cauliflower (whole)	250°F (120°C)	Off	24-27
Corn on the Cob (without husk)	250°F (120°C)	Off	20-22
Corn on the Cob (with husk, no soaking required)	250°F (120°C)	Off	22-24
Mushrooms (small, whole)	250°F (120°C)	Off	10-11
Potatoes (tiny, new)	250°F (120°C)	Off	25-26
Zucchini (sliced)	250°F (120°C)	Off	10-11
Scalloped Corn (2 qt [1.9 L] dish)			
Recipe: Bake	325°F (165°C)		40-50
Auto Steam Vegetables	300°F (150°C)	Off	27
Stuffed Green Peppers (4 servings)			
Recipe: Bake	375°F (190°C)		15
Auto Steam Vegetables*	325°F (163°C)	Off	20 or until heated through

*Use raw peppers, do not put in boiling water.

Auto Steam Seafood Cooking Chart

FOOD	OVEN TEMPERATURE	BROWNING	COOKING TIME (in minutes)
Fillets, ¼" (0.6 cm) thick	250°F (120°C)	Off	8-9
Fillets, ½" (1.3 cm) thick	250°F (120°C)	Off	11-12
Fillets, 1" (2.5 cm) thick	300°F (150°C)	Off	17-20
Whole, dressed 1" (2.5 cm) thick	340°F (170°C)	Low	13-14
Scallops (U-10 ct)	250°F (120°C)	Off	13-14
Shrimp (16-20 ct)	250°F (120°C)	Off	9-10
Shrimp (26-30 ct)	250°F (120°C)	Off	8-9
Lobster Tail (10-12 oz [283-340 g])	250°F (120°C)	Off	18-19

Manual Steam Cooking Chart

For best cooking results, use rack position 1 or 2 when Manual Steam cooking.

FOOD	PREHEAT	OVEN TEMPERATURE	BROWNING	STEAM PERCENT	COOKING TIME (in minutes)
Crusty Pizza Dough (14" [35.6 cm] pizza pan with toppings)					
Recipe: Bake		450°F (230°C)			15-20
Manual Steam	On	425°F (220°C)	Off	80	11
Lasagna (2 qt [2 L] rectangular baking dish)					
Recipe: Bake		375°F (190°C)			30-35
Manual Steam	Off	350°F (175°C)	Off	100	23 or until heated through
Oven Frittata (10" [25.4 cm] ovenproof skillet)					
Recipe: Bake*		350°F (175°C)			15
Manual Steam (*Cook vegetables in skillet, add eggs and place in oven.)	Off	325°F (165°C)	Off	100	11 or until knife inserted near center comes out clean
Bratwurst (fresh)					
Manual Steam	Off	250°F (120°C)	Off	100	17 or 165°F (74°C) internal temperature
Chicken Breasts (boneless, skinless)					
Manual Steam	Off	350°F (175°C)	Off	80	25 or 165°F (74°C) internal temperature
Meat Loaf (7" x 3" x 2" [17.8 cm x 7.6 cm x 5 cm] loaf) 1 lb (454 g) meat					
Recipe: Bake		350°F (175°C)			45-50
Manual Steam	Off	350°F (175°C)	Off	80	40 or 160°F (71°C) internal temperature

Meats and Poultry Roasting Chart

- Place meat or poultry on the convection roasting rack set on top of the broiler pan.
- Insert a meat thermometer or use the temperature probe provided with the oven.
- For best cooking results, start with meat or poultry at refrigerated temperature and roast on rack position 1 or 2.
- Start in an unheated oven.
- Roast at the oven temperature recommended for the time given or until the thermometer or temperature probe reaches the specified temperature for doneness.
- Cover with foil and let stand for 10 to 20 minutes before carving.
- The temperature will rise during standing time.
- For best cooking results, place poultry into the oven legs first.

FOOD	OVEN TEMPERATURE	BROWNING	COOKING TIME (in hours and minutes)	MINUTES PER 1 LB (454 g)	INTERNAL TEMPERATURE
Beef					
Semi-Boneless Standing Beef Rib Roast (4-5 lbs [1.8-2.3 kg])					
Auto Steam Meats medium-rare	325°F (160°C)	Medium	1:39-2:08	24-26	130°F (54°C)
medium	325°F (160°C)	Medium	1:50-2:22	27-28	145°F (63°C)
Beef Rib Eye Roast, boneless (4-4½ lbs [1.8-2 kg])					
Auto Steam Meats medium-rare	325°F (160°C)	Medium	1:43-1:56	23-26	130°F (54°C)
medium	325°F (160°C)	Medium	1:56-2:10	26-29	145°F (63°C)
Beef Sirloin Roast, boneless (4-5 lbs [1.8-2.3 kg])					
Auto Steam Meats medium-rare	325°F (160°C)	High	1:22-1:42	19-21	130°F (54°C)
medium	325°F (160°C)	High	1:35-1:56	22-24	145°F (63°C)
Pork					
Pork Top Loin Roast, single loin (boneless 2-2½ lbs [1-1.1 kg])					
Auto Steam Meats	325°F (160°C)	High	0:44-0:57	22-25	145°F (63°C)
Pork Top Loin Roast, double loin, tied (boneless 3-4 lbs [1.4-1.8 kg])					
Auto Steam Meats	325°F (160°C)	High	1:27-1:42	22-29	145°F (63°C)
Pork Loin Center Rib Roast (3-4 lbs [1.4-1.8 kg])					
Auto Steam Meats	325°F (160°C)	Medium	1:13-1:40	24-25	145°F (63°C)
Pork Tenderloin (1 lb [454 g])					
Auto Steam Meats	425°F (220°C)	High	0:28-0:29	28-29	145°F (63°C)
Ham, fully cooked shank (9½-10 lbs [4.3-4.5 kg])					
Auto Steam Meats	300°F (150°C)	Low	2:20-2:29	14-15	130°F (54°C)
Lamb					
Leg of Lamb (6-7 lbs [2.7-3.1 kg])					
Auto Steam Meats	325°F (165°C)	Medium	1:40-1:46	15-18	130°F (54°C)
Lamb Loin Roast (1½-1¾ lbs [0.7-0.8 kg])					
Auto Steam Meats	400°F (200°C)	Medium	0:31-0:43	19-24	130°F (54°C)

FOOD	OVEN TEMPERATURE	BROWNING	COOKING TIME (in hours and minutes)	MINUTES PER 1 LB (454 g)	INTERNAL TEMPERATURE
Chicken					
Chicken, broiler-fryer (3½-4½ lbs [1.6-2 kg]) Auto Steam Poultry	350°F (175°C)	High	0:44-0:49	11-13	165°F (74°C)
Chicken, roasting (4-5 lbs [1.8-2.3 kg]) Auto Steam Poultry	350°F (175°C)	High	0:49-0:52	10-12	165°F (74°C)
Chicken, roasting (6-6½ lbs [2.7-2.9 kg]) Auto Steam Poultry	350°F (175°C)	High	1:04-1:15	11-12	165°F (74°C)
Turkey					
Turkey (10-12 lbs [4.5-5.4 kg]) Auto Steam Poultry	325°F (165°C)	Medium	0:59-1:33	6-8	165°F (74°C)
Turkey (14-17 lbs [6.4-7.7 kg]) Auto Steam Poultry	325°F (165°C)	Medium	1:15-1:45	5-6	165°F (74°C)
Turkey (20-22 lbs [9-10 kg]) Auto Steam Poultry	300°F (150°C)	Medium	2:00-2:12	6-7	165°F (74°C)
Turkey Breast, whole (7½-9 lbs [3.4-4.1 kg]) Auto Steam Poultry	325°F (165°C)	Medium	1:15-1:40	9-11	165°F (74°C)
Duck					
Duck (5-6 lbs [2.3-2.7 kg]) Auto Steam Poultry	350°F (175°C)	Medium	1:07-1:12	11-13	165°F (74°C)
Cornish Hens					
Cornish Hens (22 oz [624 g]) Auto Steam Poultry	350°F (175°C)	High	0:37-0:38	26-27	165°F (74°C)

OVEN CARE

Self-Cleaning Cycle

⚠ WARNING



Burn Hazard

Do not touch the oven during the Self-Cleaning cycle.

Keep children away from oven during Self-Cleaning cycle.

Failure to follow these instructions can result in burns.

IMPORTANT: The health of some birds is extremely sensitive to the fumes given off during the Self-Cleaning cycle. Exposure to the fumes may result in death to certain birds. Always move birds to another closed and well-ventilated room.

Self-clean the oven before it becomes heavily soiled. Heavy soil results in longer cleaning and more smoke.

Keep the kitchen well-ventilated during the Self-Cleaning cycle to help get rid of heat, odors, and smoke.

Do not block the oven vent(s) during the Self-Cleaning cycle. Air must be able to move freely. Depending on your model, see "Oven Vent" or "Oven Vents" section.

Do not clean, rub, damage or move the oven door gasket. The door gasket is essential for a good seal.

Prepare Oven:

- Remove a broiler pan, grid, cookware and bakeware and, on some models, the temperature probe from the oven.
- Remove any foil from the oven because it may burn or melt, damaging the oven.
- Remove oven racks to keep them shiny and easy to slide. See "General Cleaning" section for more information.
- Hand clean inside door edge and the 1½" (3.8 cm) area around the inside oven cavity frame, being certain not to move or bend the gasket. This area does not get hot enough during self-cleaning to remove soil. Do not let water, cleaner, etc. enter slots on door frame. Use a damp cloth to clean this area.
- Wipe out any loose soil to reduce smoke and avoid damage. At high temperatures, foods react with porcelain. Staining, etching, pitting or faint white spots can result. This will not affect cooking performance.

How the Cycle Works

IMPORTANT: The heating and cooling of porcelain on steel in the oven may result in discoloring, loss of gloss, hairline cracks and popping sounds.

The Self-Cleaning cycle uses very high temperatures, burning soil to a powdery ash.

The oven is preset for a 3 hour 30 minute clean cycle, however the time can be changed. Suggested clean times are 2 hours 30 minutes for light soil and between 3 hours 30 minutes and 4 hours 30 minutes for average to heavy soil.

Use the following chart as a guide to determine the desired cleaning level.

CLEANING LEVEL	TOTAL CLEANING TIME (includes a 30 minute cool down time)
1 (Quick)	2 hours 30 minutes
2	3 hours
3 (Regular)	3 hours 30 minutes
4	4 hours
5 (Maxi)	4 hours 30 minutes

Once the oven has completely cooled, remove ash with a damp cloth. Do not wipe down any of the inside surfaces until the oven has completely cooled down. Applying a cool damp cloth to the inner door glass before it has cooled completely could result in the glass breaking.

The oven lights will not work during the Self-Cleaning cycle.

On double oven models, only one oven can self-clean at a time. If one oven is self-cleaning, the other oven cannot be set or turned on.

NOTE: The oven has a 2 speed cooling fan motor. During self-cleaning the fan(s) will operate at its highest speed to increase airflow to better exhaust the hotter air through the oven vent(s). An increase of noise may be noticeable during and after the self-cleaning cycle until the oven cools.

To Self-Clean:

Before self-cleaning, make sure the door is closed completely or it will not lock and the cycle will not begin.

1. From the Main menu, touch MORE.
2. Touch SELF CLEAN.
3. Touch + or - to increase or decrease the clean time to the desired level.
4. Touch TIPS to receive instructions on preparing your oven for self-clean. Touch OK to return to the Self-Clean menu.
5. Once the self-clean setup function is complete, the Start key will light up.
6. When settings are correct, touch START.
7. When the end of the self-clean time is reached, the oven will shut off automatically and the Complete message will be displayed. If enabled, end-of-cycle tones will sound, then reminder tones will sound every minute. Touch OK to clear this message, stop reminder tones and return to the Main Menu.

To Delay Start Self-Clean:

1. From the Main menu, touch MORE.
2. Touch SELF CLEAN.
3. Touch + or - to increase or decrease the clean time to the desired level.
4. Touch TIPS to receive instructions on preparing your oven for self-clean. Touch OK to return to the Self-Clean menu.
5. Touch DELAY.
6. Use the + or - to increase or decrease the delay time or use the numerical keys to enter the desired amount of time.
7. Once the self-clean setup function is complete, the Start key will light up.
8. When settings are correct, touch START.
9. Once the Start key is touched, the Delayed Self-Clean will be displayed showing the settings. A countdown timer will be displayed in the lower left hand portion of the display showing the time remaining until self-cleaning begins.

10. When the start time is reached, the oven will automatically turn on. The countdown timer will appear on the oven display. If the door is opened before the self-clean cycle begins, the self-clean cycle will be canceled and a message will appear. Touch OK to return to the Main Menu.
11. When the end of the self-clean time is reached, the oven will shut off automatically and the Complete message will be displayed. If enabled, end-of-cycle tones will sound, then reminder tones will sound every minute. Touch OK to clear this message, stop reminder tones and return to the Main Menu

Once the self-clean cycle starts, the door will automatically lock and "DOOR LOCKED" will appear on the display.

The door will not unlock until the oven cools and the Complete message appears.

To Stop Self-Clean anytime:

Touch OFF, UPPER OVEN OFF or LOWER OVEN OFF. If the oven temperature is too high, the door will remain locked. It will not unlock until the oven cools.

General Cleaning

IMPORTANT: Before cleaning, make sure all controls are off and the oven is cool. Always follow label instructions on cleaning products.

Soap, water and a soft cloth or sponge are suggested first unless otherwise noted.

STAINLESS STEEL (on some models)

Cleaning Method:

Rub in direction of grain to avoid damaging.

- KitchenAid® Stainless Steel Cleaner and Polish Part Number 4396920 (not included) or KitchenAid® Stainless Steel Wipes Part Number 8212510 (not included):

See "Assistance or Service" section to order.

- Liquid detergent or all-purpose cleaner:
Rinse with clean water and dry with soft, lint-free cloth.
- Vinegar for hard water spots

To avoid damage to stainless steel surfaces, do not use soap-filled scouring pads, abrasive cleaners, Cooktop Polishing Creme, steel-wool pads, gritty washcloths or some paper towels.

OVEN DOOR EXTERIOR

Cleaning Method:

- Glass cleaner and a soft cloth or sponge:
Apply glass cleaner to soft cloth or sponge, not directly on panel.
- All-Purpose Appliance Cleaner Part Number 31662 (not included):
See "Assistance or Service" section to order.

OVEN DOOR INTERIOR

Cleaning Method:

- Self-Cleaning cycle:

For optimal door cleaning result, wipe away any deposits with a damp sponge before running cycle.

CONTROL PANEL

Activate the Control Lock to avoid touch screen activation during cleaning. See "Control Lock" section.

Cleaning Method:

- Glass cleaner and soft cloth or sponge:
Apply glass cleaner to soft cloth or sponge, not directly on panel.
- All-Purpose Appliance Cleaner Part Number 31662 (not included):
See "Assistance or Service" section to order.

To avoid damage to the control panel, do not use abrasive cleaners, steel-wool pads, gritty washcloths or some paper towels.

OVEN CAVITY

Do not use oven cleaners.

Food spills should be cleaned when oven cools. At high temperatures, foods react with porcelain and staining, etching, pitting or faint white spots can result.

Cleaning Method:

- Self-Cleaning cycle: See "Self-Cleaning Cycle" first.

OVEN RACKS

Cleaning Method:

- Self-Cleaning cycle:

See “Self-Cleaning Cycle” first. Remove racks or they will discolor and become harder to slide. If this happens, a light coating of vegetable oil applied to the rack guides will help them slide.

- Steel-wool pad

BROILER PAN AND GRID (Accessory)

Do not clean in the Self-Cleaning cycle.

Cleaning Method:

- Mildly abrasive cleanser:

Scrub with wet scouring pad.

- Solution of ½ cup (125 mL) ammonia to 1 gal. (3.75 L) water:

Soak for 20 minutes, then scrub with scouring or steel-wool pad.

- Oven cleaner:

Follow product label instructions.

Porcelain enamel only, not chrome

- Dishwasher

Oven Lights

The oven lights are 12-volt, 5-watt maximum halogen bulbs. They will come on when the oven door is opened. On double oven models, both upper and lower lights will come on when either door is opened. The oven lights will not work during the Self-Cleaning cycle. When the oven door is closed, touch OVEN LIGHT to turn them on or off.

To Replace:

Before replacing bulb, make sure the oven is off and cool.

1. Disconnect power.
2. Remove glass light cover by grasping the front edge and pulling away from oven.

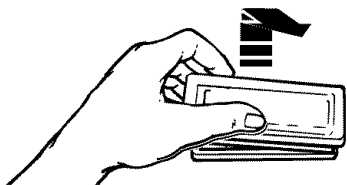

3. Remove bulb from socket.
4. Replace bulb, using tissue or wearing cotton gloves to handle bulb. Do not touch bulb with bare fingers.
5. Replace bulb cover by snapping back into wall.
6. Reconnect power.

Oven Door

IMPORTANT: To avoid oven door glass breakage:

- Do not close the oven door if the racks are not fully inserted into the oven cavity or when bakeware extends past the front edge of an oven rack.
- Do not set objects on the glass surface of the oven door.
- Do not hit glass surfaces with bakeware or other objects.
- Do not wipe down glass surfaces until the oven has completely cooled.

For normal oven use, it is not suggested to remove the oven door. However, if removal is necessary, make sure the oven is off and cool. Then, follow these instructions. The oven door is heavy.

To Remove:

1. Open oven door all the way.
2. Flip up the hinge latch on each side.

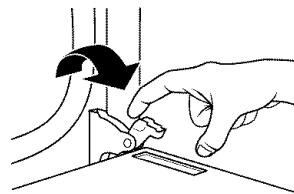

3. Close the oven door as far as it will shut.
4. Lift the oven door while holding both sides.

Continue to push the oven door closed and pull it away from the oven door frame.



To Replace:

1. Insert both hanger arms into the door.



2. Open the oven door.
You should hear a “click” as the door is set into place.
3. Move the hinge levers back to the locked position. Check that the door is free to open and close. If it is not, repeat the removal and installation procedures.

TROUBLESHOOTING

Try the solutions suggested here first in order to avoid the cost of an unnecessary service call.

Nothing will operate

- **Has a household fuse blown, or has a circuit breaker tripped?**
Replace the fuse or reset the circuit breaker. If the problem continues, call an electrician.
 - **Is the appliance wired properly?**
See Installation Instructions.
-

Oven will not operate

- **Is the electronic oven control set correctly?**
See “Electronic Oven Control” section.
 - **Has a delay start been set?**
See “Timed Cooking” section.
 - **Is the Control Lock set?**
See “Control Lock” section.
 - **Is the Sabbath Mode set?**
See “Sabbath Mode” section.
 - **On double oven models, is one oven self-cleaning?**
When one oven is self-cleaning the other oven cannot be set or turned on.
 - **On double oven models, is the correct oven control being used?**
The left control is for the lower oven, the right control is for the upper oven.
-

Oven temperature too high or too low

- **Does the oven temperature calibration need adjustment?**
See “Oven Temperature Control” section.
-

Display shows messages

- **Is the display showing a letter followed by a number?**
Clear the display. See “Display(s)” section. If a letter followed by a number reappears, call for service. See “Assistance or Service” section.
-

Steam cycle will not operate

- **Is the water supply connected to the oven?**
See the Installation Instructions supplied with this oven.
 - **Does the filter need to be replaced?**
The oven will shut off the steam functions until the filter is replaced. See “Water Filter/Filtration System” section.
-

Self-Cleaning cycle will not operate

- **Is the oven door open?**
Close the oven door all the way.
 - **Has the function been entered?**
See “Self-Cleaning Cycle” section.
 - **On some models, has a delay start Self-Clean cycle been set?**
See “Self-Cleaning Cycle” section.
 - **Has a delay start been set?**
See “Timed Cooking” section.
 - **On double oven models, is one oven self-cleaning?**
When one oven is self-cleaning, the other oven cannot be set to self-clean.
-

Oven cooking results not what expected

- **Is the proper temperature set?**
Double-check the recipe in a reliable cookbook.
 - **Is the proper oven temperature calibration set?**
See “Oven Temperature Control” section.
 - **Was the oven preheated?**
See “Baking and Roasting” section.
 - **Is the proper bakeware being used?**
See “Bakeware” section.
 - **Are the racks positioned properly?**
See “Positioning Racks and Bakeware” section.
 - **Is there proper air circulation around bakeware?**
See “Positioning Racks and Bakeware” section.
 - **Is the batter evenly distributed in the pan?**
Check that batter is level in the pan.
 - **Is the proper length of time being used?**
Adjust cooking time.
 - **Has the oven door been opened while cooking?**
Oven peeking releases oven heat and can result in longer cooking times.
 - **Are baked items too brown on the bottom?**
Move rack to higher position in the oven.
 - **Are pie crust edges browning early?**
Use aluminum foil to cover the edge of the crust and/or reduce baking temperature.
-

ASSISTANCE OR SERVICE

Before calling for assistance or service, please check “Troubleshooting.” It may save you the cost of a service call. If you still need help, follow the instructions below.

When calling, please know the purchase date and the complete model and serial number of your appliance. This information will help us to better respond to your request.

If you need replacement parts

If you need to order replacement parts, we recommend that you use only factory specified parts. These factory specified parts will fit right and work right because they are made with the same precision used to build every new KITCHENAID® appliance.

To locate factory specified parts in your area, call us or your nearest KitchenAid designated service center.

In the U.S.A.

Call the KitchenAid Customer eXperience Center toll free: **1-800-422-1230**.

Our consultants provide assistance with:

- Features and specifications on our full line of appliances.
- Installation information.
- Use and maintenance procedures.
- Accessory and repair parts sales.
- Specialized customer assistance (Spanish speaking, hearing impaired, limited vision, etc.).
- Referrals to local dealers, repair parts distributors and service companies. KitchenAid designated service technicians are trained to fulfill the product warranty and provide after-warranty service, anywhere in the United States.

To locate the KitchenAid designated service company in your area, you can also look in your telephone directory Yellow Pages.

For further assistance

If you need further assistance, you can write to KitchenAid with any questions or concerns at:

KitchenAid Brand Home Appliances
Customer eXperience Center
553 Benson Road
Benton Harbor, MI 49022-2692

Please include a daytime phone number in your correspondence.

Accessories U.S.A.

To order accessories, call the KitchenAid Customer eXperience Center toll free at **1-800-442-9991** and follow the menu prompts. Or visit our website at www.kitchenaid.com and click on “Shopping Options.” Go to “Replacement Parts & Accessories” and click on “applianceaccessories.com.” Portable appliances, bakeware, cookware, gadgets and textiles are also available.

Broiler Pan Kit

Order Part Number W10123240

KitchenAid® Replacement Water Filter

Order Part Number 8212695

KitchenAid® Stainless Steel Cleaner and Polish

(stainless steel models)

Order Part Number 4396920

KitchenAid® Stainless Steel Wipes

(stainless steel models)

Order Part Number 8212510

All-Purpose Appliance Cleaner

Order Part Number 31662

In Canada

Call the KitchenAid Canada Customer Interaction Centre toll free: **1-800-807-6777**.

Our consultants provide assistance with:

- Features and specifications on our full line of appliances.
- Use and maintenance procedures.
- Accessory and repair parts sales.
- Referrals to local dealers, repair parts distributors and service companies. KitchenAid Canada designated service technicians are trained to fulfill the product warranty and provide after-warranty service, anywhere in Canada.

For further assistance

If you need further assistance, you can write to KitchenAid Canada with any questions or concerns at:

Customer Interaction Centre
KitchenAid Canada
1901 Minnesota Court
Mississauga, Ontario L5N 3A7

Please include a daytime phone number in your correspondence.

KITCHENAID® BUILT-IN OVEN & MICROWAVE WARRANTY

ONE YEAR LIMITED WARRANTY

For one year from the date of purchase, when this major appliance is operated and maintained according to instructions attached to or furnished with the product, KitchenAid or KitchenAid Canada (hereafter "KitchenAid") will pay for factory specified parts and repair labor to correct defects in materials or workmanship. Service must be provided by a KitchenAid designated service company.

SECOND THROUGH FIFTH YEAR LIMITED WARRANTY ON CERTAIN COMPONENT PARTS

In the second through fifth years from the date of purchase, when this appliance is operated and maintained according to instructions attached to or furnished with the product, KitchenAid or KitchenAid Canada will pay for factory specified parts for the following components if defective in materials or workmanship:

- Electric element
- Solid state touch control system parts

SECOND THROUGH TENTH YEAR LIMITED WARRANTY

On microwave ovens only, in the second through tenth years from date of purchase, when this major appliance is operated and maintained according to instructions attached to or furnished with the product, KitchenAid will pay for factory specified parts for the stainless steel oven cavity/inner door if the part rusts through due to defects in materials or workmanship.

ITEMS KITCHENAID WILL NOT PAY FOR

1. Service calls to correct the installation of your major appliance, to instruct you how to use your major appliance, to replace or repair house fuses or to correct house wiring or plumbing.
2. Service calls to repair or replace appliance light bulbs, air filters or water filters. Those consumable parts are excluded from warranty coverage.
3. Repairs when your major appliance is used for other than normal, single-family household use.
4. Damage resulting from accident, alteration, misuse, abuse, fire, flood, acts of God, improper installation, installation not in accordance with electrical or plumbing codes, or use of products not approved by KitchenAid.
5. Replacement parts or repair labor costs for units operated outside the United States or Canada.
6. Pickup and delivery. This major appliance is designed to be repaired in the home.
7. Repairs to parts or systems resulting from unauthorized modifications made to the appliance.
8. Expenses for travel and transportation for product service in remote locations.
9. The removal and reinstallation of your appliance if it is installed in an inaccessible location or is not installed in accordance with published installation instructions.

DISCLAIMER OF IMPLIED WARRANTIES; LIMITATION OF REMEDIES

CUSTOMER'S SOLE AND EXCLUSIVE REMEDY UNDER THIS LIMITED WARRANTY SHALL BE PRODUCT REPAIR AS PROVIDED HEREIN. IMPLIED WARRANTIES, INCLUDING WARRANTIES OF MERCHANTABILITY OR FITNESS FOR A PARTICULAR PURPOSE, ARE LIMITED TO ONE YEAR OR THE SHORTEST PERIOD ALLOWED BY LAW. KITCHENAID SHALL NOT BE LIABLE FOR INCIDENTAL OR CONSEQUENTIAL DAMAGES. SOME STATES AND PROVINCES DO NOT ALLOW THE EXCLUSION OR LIMITATION OF INCIDENTAL OR CONSEQUENTIAL DAMAGES, OR LIMITATIONS ON THE DURATION OF IMPLIED WARRANTIES OF MERCHANTABILITY OR FITNESS, SO THESE EXCLUSIONS OR LIMITATIONS MAY NOT APPLY TO YOU. THIS WARRANTY GIVES YOU SPECIFIC LEGAL RIGHTS AND YOU MAY ALSO HAVE OTHER RIGHTS, WHICH VARY FROM STATE TO STATE OR PROVINCE TO PROVINCE.

Outside the 50 United States and Canada, this warranty does not apply. Contact your authorized KitchenAid dealer to determine if another warranty applies.

If you need service, first see the "Troubleshooting" section of the Use & Care Guide. After checking "Troubleshooting," additional help can be found by checking the "Assistance or Service" section or by calling KitchenAid. In the U.S.A., call **1-800-422-1230**. In Canada, call **1-800-807-6777**.

9/05

Keep this book and your sales slip together for future reference. You must provide proof of purchase or installation date for in-warranty service.

Write down the following information about your major appliance to better help you obtain assistance or service if you ever need it. You will need to know your complete model number and serial number. You can find this information on the model and serial number label located on the product.

Dealer name _____

Address _____

Phone number _____

Model number _____

Serial number _____

Purchase date _____

