

IMPORTANT MANUAL

Do Not Throw Away

SEARS
operator's
manual

- Assembly
- Operation
- Maintenance
- Repair Parts

MODEL NO.

358.34110 - 2.0/14"



⚠WARNING:

Carefully read and follow Safety Rules, Precautions and Operating Instructions. Failure to do so can result in serious injury.

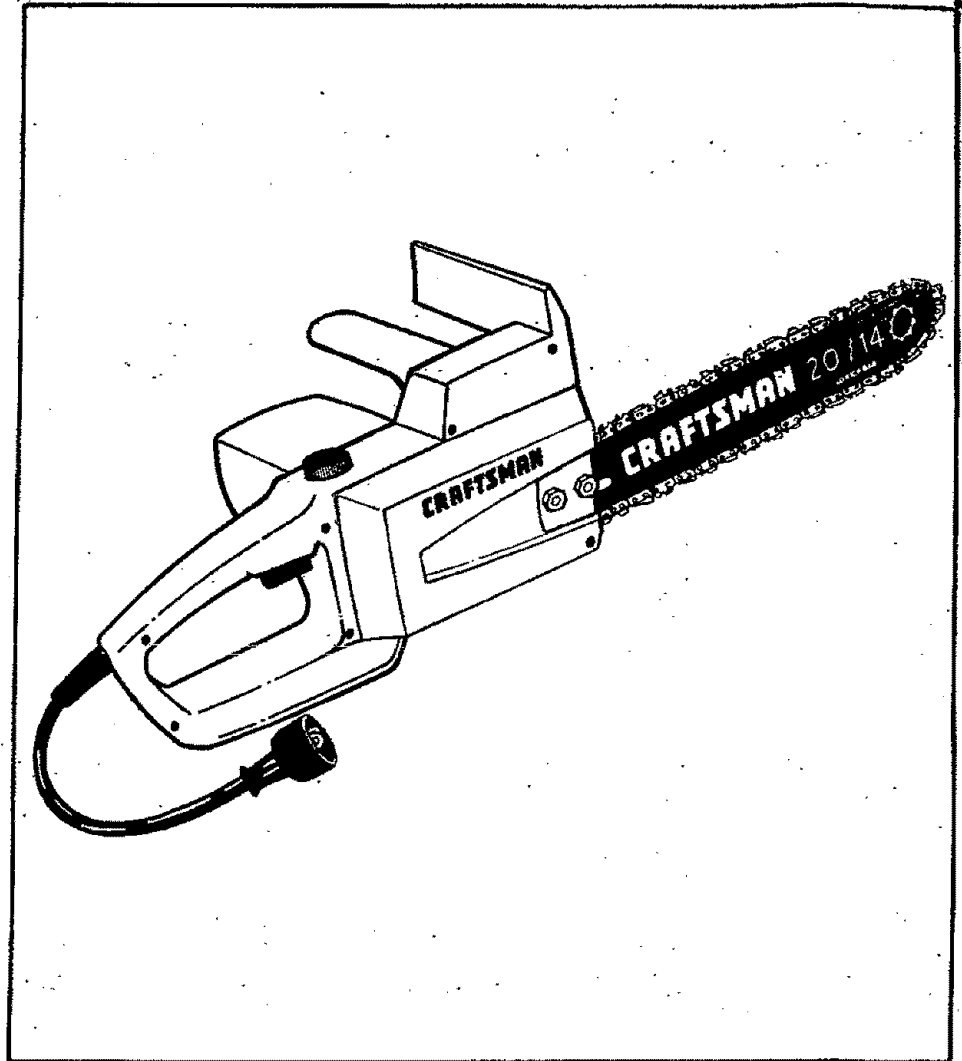

SEARS / CRAFTSMAN®

2.0/14"

ELECTRIC CHAIN SAW

Record in the space provided below the Model No. and Serial No. of your saw. These numbers are located on the name plate decal.

Model No. _____ Serial No. _____

Retain these numbers for future reference.

Sears, Roebuck and Co., Chicago, ILL 60684 U.S.A.

FULL 1 YEAR WARRANTY ON ELECTRIC CHAIN SAW (Excluding Bar & Chain)

For one year from date of purchase, Sears will repair defects in material or workmanship in this Electric Chain Saw at no charge. This warranty excludes bar & chain, which are expendable parts and become worn during normal use.

If this Electric Chain Saw is used for commercial or rental purpose, this warranty applies for only 30 days from date of purchase. WARRANTY SERVICE IS AVAILABLE BY RETURNING THE CHAIN SAW TO THE NEAREST SEARS SERVICE CENTER/DEPARTMENT IN THE UNITED STATES.

This warranty gives you specific legal rights, and you may also have other rights which vary from state to state.

Sears, Roebuck and Co., Sears Tower, Dept. D731CR-W, Chicago, IL 60684

TABLE OF CONTENTS

Specifications	2	B. Tree Felling Techniques	11
SPECIAL SAFETY SECTION	3	C. Bucking	13
Know Your Chain Saw	6	D. Debranching and Pruning	14
Preparing Your Saw For Use	7	Maintenance	15
A. Getting Ready	7	A. Cleaning the Saw	15
B. Power Source and Extension Cord	7	B. Guide Bar and Chain	15
C. Attaching the Bar and Chain	8	C. Sprocket/Gear Assembly	17
D. Chain Tension	9	D. Storage	18
E. Bar and Chain Oil	9	E. Maintenance Accessories	18
Using Your Saw	10	F. Trouble Shooting Chart	19
A. Control Devices	10	Repair Parts List	20
B. Pre-Operation Checks	10	Quick Reference Page	23
C. Starting and Stopping the Saw	10		
Types of Cutting	11		
A. Basic Cutting Technique	11		

SPECIFICATIONS

MODEL	358.34110 (20/14")
POWER SUPPLY	110-120 Volts AC 50-60 Hz
RATED CURRENT	10.5 Amps
MAXIMUM MOTOR OUTPUT	2.0 Horsepower
SPROCKET/DRIVE	Gear Drive
CHAIN—Oregon®	3/8 Pitch, Low Profile Non-Chrome Cutters Replacement Stock No. 71-3617
GUIDE BAR—Lo Kick®	14" Non-Armored Tip Nose Replacement Stock No. 71-36365
OILER	Manual
CHAIN SHARPENING	Manual

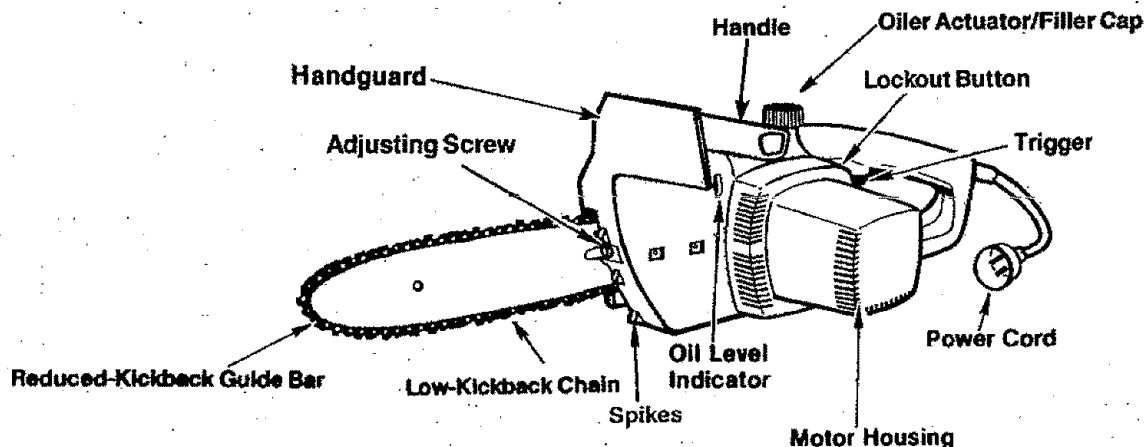

SPECIAL SAFETY SECTION

GUARD AGAINST KICKBACK

Kickback is a dangerous reaction that can lead to serious injury. Do not rely only on the safety devices provided with your saw. As a chain saw user, you must take special safety precautions to help keep your cutting jobs free from accident or injury.

▲ KICKBACK WARNING

Kickback can occur when the moving chain contacts an object at the upper portion of the tip of the guide bar or when the wood closes in and pinches the saw chain in the cut. Contact at the upper portion of the tip of the guide bar can cause the chain to dig into the object and stop the chain for an instant. The result is a lightning fast, reverse reaction which kicks the guide bar up and back toward the operator. If the saw chain is pinched along the top of the guide bar, the guide bar can be driven rapidly back toward the operator. Either of these reactions can cause loss of saw control which can result in serious injury.

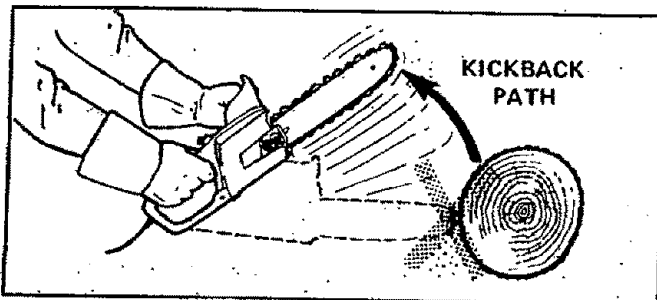

Figure 1

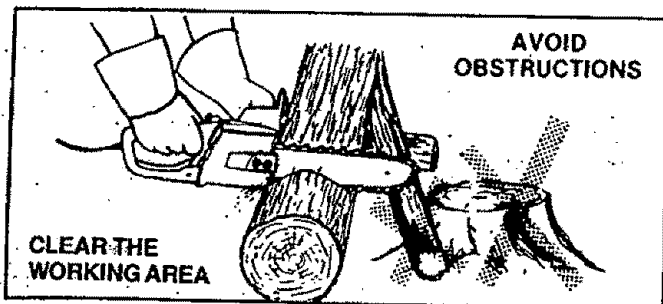

Figure 2

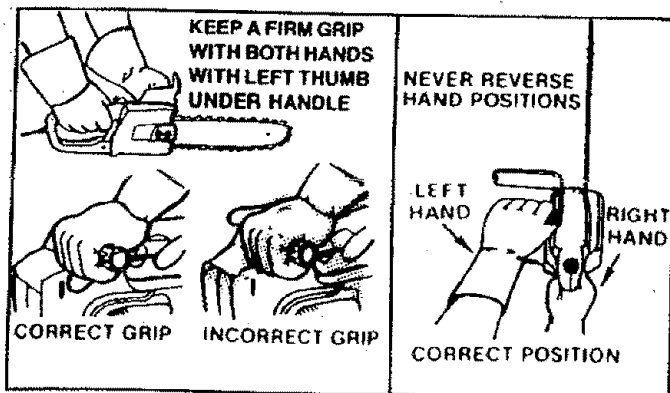

Figure 3

REDUCE THE CHANCE OF KICKBACK

1. Recognize that kickback can happen. With a basic understanding of kickback, you can reduce the element of surprise which contributes to accidents.
2. Never let the moving chain contact any object at the tip of the guide bar. Figure 1.
3. Keep the working area free from obstructions such as other trees, branches, rocks, fences, stumps, etc. Figure 2. Eliminate or avoid any obstruction that your saw chain could hit while you are cutting through a particular log or branch.
4. Keep your saw chain sharp and properly tensioned. A loose or dull chain can increase the chance of kickback. Follow manufacturer's chain sharpening and maintenance instructions. Check tension at regular intervals with the motor stopped, never with the motor running. Make sure that bar clamp nuts are securely tightened after tensioning the chain.
5. Begin and continue cutting only with the chain moving at full speed. If the chain is moving at a slower speed, there is greater chance for kickback to occur.
6. Cut one log at a time.
7. Use extreme caution when reentering a previous cut.
8. Do not attempt plunge or bore cuts.
9. Watch for shifting logs or other forces that could close a cut and pinch or fall into the chain.
10. Use the Reduced-Kickback Guide Bar and Low-Kickback Chain specified for your saw.

MAINTAIN CONTROL

1. Keep a good firm grip on the saw with both hands when the motor is running and don't let go. Figure 3. A firm grip can neutralize kickback and help you maintain control of the saw. Keep the fingers of your left hand encircling and your left thumb under the front handle. Keep your right hand completely around the rear handle whether you are right handed or left handed. Keep your left arm straight with the elbow locked.
2. Never reverse right and left hand positions. Figure 3.
3. Stand with your weight evenly balanced on both feet.
4. Stand slightly to the left side of the saw, to keep your body from being in a direct line with the cutting chain. Figure 3.
5. Do not overreach. You could be drawn or thrown off balance and lose control of the saw.
6. Do not cut above shoulder height. It is difficult to maintain control of the saw above shoulder height.

SPECIAL SAFETY SECTION (continued)

⚠ WARNING

Because a chain saw is a high-speed wood-cutting tool, special safety precautions must be observed to reduce the risk of accidents. Careless or improper use can cause serious injury.

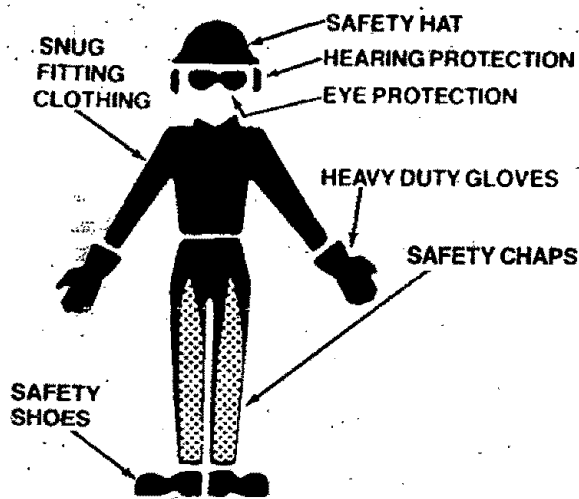



Figure 4

KNOW YOUR SAW

1. Read your Operator's Manual carefully until you completely understand and can follow all safety instructions and operating instructions *before* attempting to operate the unit.
2. Restrict the use of your saw to adult users who understand and follow the safety rules, precautions, and operating instructions found in this manual.

PLAN AHEAD

1.  Wear protective gear. Always use steel-toed safety footwear with non-slip soles; snug-fitting clothing with reinforced cut resistant inserts; heavy-duty non-slip gloves; eye protection such as non-fogging, vented goggles or face screen; an approved safety hard hat; and hearing protection. Secure long hair above shoulder length with a hairnet to prevent entanglement. Frequent users should have hearing checked regularly as chain saw noise may damage hearing.
2. Keep children, bystanders, and animals out of the work area — a minimum of 30 feet. Do not allow people or animals to be near the chain saw or extension cord when starting or operating the chain saw.

3. Do not handle or operate a chain saw when you are fatigued, ill, or upset; or if you have taken alcohol, drugs or medication. You must be in good physical condition and mentally alert. Chain saw work is strenuous. If you have any condition that might be aggravated by strenuous work, check with your doctor before operating a chain saw.
4. Do not attempt to use your saw during bad weather conditions such as strong wind, electrical storms, rain, snow, etc., or at night.
5. Plan your sawing operations carefully in advance. Do not start cutting until you have a clear work area, secure footing, and if you are felling trees, a planned retreat path.
6. Avoid accidental starting. Always unplug the saw when not in use.

AVOID REACTIVE FORCES

Pinch-Kickback and Pull-in occur when the chain is suddenly stopped by being pinched, caught, or by contacting a foreign object in the wood. This results in reversal of the chain force being used to cut wood and causes the saw to move in the opposite direction of chain rotation. Pinch-Kickback drives the saw straight back toward the operator. Pull-in pulls the saw away from the operator. Either reaction can result in the loss of control and serious injury.

To avoid Pinch-Kickback:

1. Be extremely aware of situations or obstructions that can cause material to pinch the top of or otherwise stop the chain.
2. Do not cut more than one log at a time.
3. Do not twist the saw as the bar is withdrawn from an under-cut when bucking.

To avoid Pull-in:

1. Always begin cutting with the chain moving at full speed and the saw frame against the wood.
2. Use wedges made of plastic or wood, (never of metal) to hold the cut open.

SPECIAL SAFETY SECTION (continued)

OPERATE YOUR SAW SAFELY

1. Do not operate a chain saw that is damaged, improperly adjusted, or not completely and securely assembled.
2. Do not use the saw if the trigger switch does not turn the unit on and off properly. Repairs to the trigger switch must be made by your Sears Service Center.
3. Do not operate the saw from a ladder or in a tree.
4. Position all parts of your body to the left of cut when the motor is running.
5. Cut wood only. Do not cut metal, plastics, masonry, non-wood building materials, etc. Do not use your saw to pry or shove away limbs, roots or other objects.
6. Make sure the chain will not make contact with any object before starting the motor. Never try to start the saw when the guide bar is in a cut or kerf.
7. Use extreme caution when cutting small size brush and saplings. Slender material can catch the saw chain and be whipped toward you or pull you off balance.
8. Be alert for springback when cutting a limb that is under tension to avoid being struck by the limb or saw when the tension in the wood fibers is released.
9. Do not force the saw through a cut. Exert light pressure only. Pressure on the saw at the end of a cut could cause loss of control when the cut is completed.
10. Avoid body contact with the chain anytime the saw is plugged into a power source. The chain will continue to move for a short time after the trigger is released.
11. Avoid dangerous situations. Do not expose the saw to rain, or use in damp, wet, gaseous, or explosive locations.
12. Unplug the power connection when the saw is not in use.
3. Keep chain and guide bar clean and properly lubricated.
4. Keep oil cap, screws, and fasteners tight.
5. Keep the handles dry, clean, and free of oil.
6. Stop the saw if the chain strikes a foreign object. Check for alignment, binding, breakage, and mounting of moving parts and any other condition that may affect the operation of the unit. Check guards and all other parts to see if each will operate properly and perform its intended function. Any part that is damaged should be properly repaired or replaced by using the instructions in this manual or by seeing your Sears Service Center.
7. Be certain the saw chain stops moving when the trigger switch is released.
8. Make certain that all hand tools are removed from the saw before connecting the saw to the power source.
9. Never modify your saw in any way. Use only attachments supplied or specifically recommended by the manufacturer.
10. Always replace the left motor housing immediately if the handguard or handle becomes damaged, broken, or otherwise removed.

CARRY AND STORE YOUR SAW SAFELY

1. Never carry your saw while climbing. Both hands are needed for safe climbing.
2. Carry the unit unplugged, by the front handle, finger off the trigger switch, and with the guide bar and chain to the rear.
3. Carry the saw with guide bar and chain covered by the scabbard.
4. Before transporting in any vehicle or storing in any enclosure, allow your saw to cool completely, cover the bar and chain and properly secure to avoid turnover or damage.
5. Drain oil tank before storing your saw for 30 or more days.
6. Store the saw unplugged in a dry place out of the reach of children.

MAINTAIN YOUR SAW IN GOOD WORKING ORDER

1. Unplug the saw before servicing or changing accessories.
2. Your Chain Saw is double insulated to help protect against electric shock. Have all chain saw service (other than the service described in the maintenance section of this manual) performed by your Sears Service Center.

SAFETY NOTICE

Exposure to vibrations through prolonged use of hand tools could cause blood vessel or nerve damage in the fingers, hands, and wrists of people prone to circulation disorders or abnormal swellings. Prolonged use in cold weather has been linked to blood vessel damage in otherwise healthy people. If symptoms occur such as numbness, pain, loss of strength, change in skin color or texture, or loss of feeling in the fingers, hands, or wrists, discontinue the use of this tool and seek medical attention. An anti-vibration system does not guarantee the avoidance of these problems. Users who operate power tools on a continual and regular basis must monitor closely their physical condition and the condition of this tool.

THIS CHAIN SAW IS FOR OCCASIONAL USE ONLY.

Notice:

Refer to the Code of Federal Regulations, Section 1910.266 (5); 2.5.1 of American National Standard Safety Requirements for Pulpwood Logging, ANSI O3.1-1978; and relevant state safety codes when using a chain saw for logging purposes.

SPECIAL SAFETY SECTION (continued)

A. KICKBACK SAFETY FEATURES

- **Reduced-Kickback Guide Bar**, designed with a small radius tip which reduces the size of the kickback danger zone on the bar tip. Figure 5. A Reduced Kickback Guide Bar is one which has been demonstrated to significantly reduce the number and seriousness of kickbacks when tested in accordance with the safety requirements for electric chain saws as set by U.L. 1662.
- **Low-Kickback Chain**, designed with a contoured depth gauge and guard link which deflect the kickback force and allow wood to gradually ride into the cutter. Figure 5. Low-Kickback Saw Chain is chain which has met the kickback performance requirements of ANSI B175.1.
- **Handguard**, designed to reduce the chance of your left hand contacting the chain if your hand slips off the front handlebar.
- **Position of front and rear handlebars**, designed with distance between handles which provides better control, balance, and resistance if kickback occurs.

⚠ WARNING
 Do not operate the chain saw unless the safety devices or their specified replacements are properly installed and maintained according to the instructions in this manual. Do not use any other guide bar and chain combination that is not equivalent to the original equipment or not certified to comply with ANSI B175.1. Failure to follow these instructions can result in serious injury.

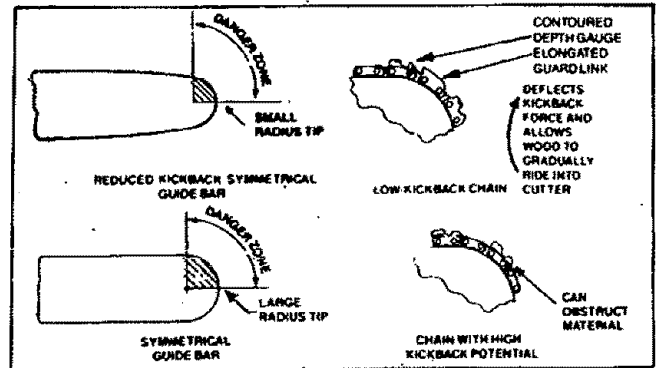

Figure 5

B. DOUBLE INSULATION

Your Chain Saw is double insulated to help protect against electric shock. A double insulated tool is constructed throughout with two separate "layers" of electrical insulation or one double thickness of insulation between the operator and the electrical system of the tool.

Tools built with this insulation system are not intended to be grounded. As a result, the extension cord used

with your saw can be plugged into any conventional 120 volt electrical outlet without concern for maintaining a ground connection.

Safety precautions must be observed when operating any electrical tool. The double insulation system only supplies added protection against injury resulting from a possible electrical insulation failure within the saw.

C. POWER SOURCE AND EXTENSION CORD

1. POWER SOURCE

Use only an A.C. voltage supply identical to that shown on the name plate of the saw to power this chain saw.

⚠ WARNING

All electrical repairs to this saw, including housing, switch, motor, etc., must be diagnosed and repaired by your Sears Service Center. Failure to do so can cause the double insulation construction to become ineffective and result in serious injury.

2.) **Heavy enough to carry the current from the power source to the distance at which the saw is to be used.** Otherwise, loss of power and overheating can occur causing damage to the unit. Refer to Figure 6 for minimum wire gauge recommendations.

3.) **In good condition.** Cord insulation must be intact with no cracks or deterioration. Plug connectors must be undamaged.

b. **Suitable extension cords are available at your Sears Retail or Catalog Store.**

2. EXTENSION CORD

a. The extension cord used to reach the power source must be:

- 1.) **Specifically marked as suitable for outdoor use.** The suffix, W-A, must be included on the cord label.

MINIMUM WIRE GAUGE RECOMMENDATIONS					
AMP	VOLTS	25 FT.	50 FT.	100 FT.	150 FT.
10.5	120	18 A.W.G.	16 A.W.G.	14 A.W.G.	12 A.W.G.

Figure 6

3. IMPORTANT POINTS

- a. Secure the tool cord to the extension cord as shown in Figure 7 to prevent disconnection.
- b. Do not abuse cords. Never carry saw by the power cord or yank it to disconnect. Keep tool cord and extension cord away from heat, oil, and sharp edges.
- c. Guard against electric shock. Avoid body contact with any grounded conductor, such as metal pipes and wire fences.
- d. Avoid entanglement. Keep cords clear of operator, saw chain, and branches at all times.
- e. Avoid dangerous situations. Do not expose the saw to rain, or use in damp, wet, gaseous, or explosive locations.
- f. Inspect extension cords before each use. Replace before using the saw if damaged.

- g. Inspect chain saw cord before each use. Do not use the unit with a damaged cord. Take the unit to a Sears Service Center for repairs.

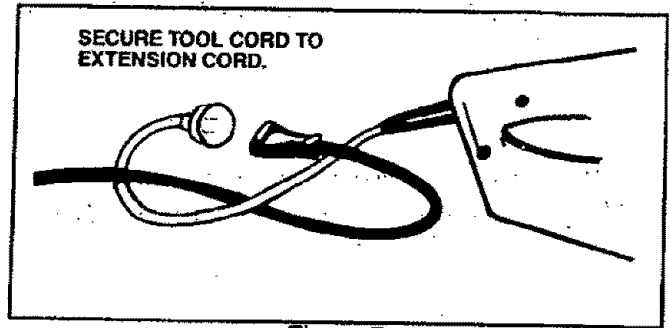

Figure 7

SAVE THESE INSTRUCTIONS

PREPARING YOUR SAW FOR USE

A. INTRODUCTION

- Your saw has been designed with safety in mind and includes the following features as standard equipment:
 - Reduced-Kickback Guide Bar (Lo-Kick®)
 - Low-Kickback Chain (Xtra-GUARD®)
 - Handguard

⚠ WARNING

The following features are included on your saw to help reduce the hazard of kickback. However, such features will not totally eliminate this dangerous reaction. As a chain saw user, do not rely only on safety devices. You must follow all safety precautions, instructions and maintenance in this manual to help avoid kickback and other forces which can result in serious injury.

B. GETTING READY

1. **READ YOUR OPERATOR'S MANUAL CAREFULLY.**
Your Operator's Manual has been developed to help you prepare your saw for use and to understand its safe operation. It is important that you read your manual completely to become familiar with the unit before you begin assembly.
2. **HAVE THE FOLLOWING AVAILABLE:**
 - a. Protective Gloves.
 - b. 9/16 inch wrench or equivalent.
 - c. Standard Screwdriver.
 - d. Bar and Chain Oil (see page 9).

C. CARTON CONTENTS

After you unpack the carton:

1. Check the contents against the list below.
2. Examine the items for damage.
3. Notify your Sears store immediately if a part is missing or damaged.

KEY NO.	CARTON CONTENTS:	QTY.
1	Powerhead	1
2	Guide Bar	1
3	Scabbard	1
4	Chain	1
—	Operator's Manual (Not Shown)	1

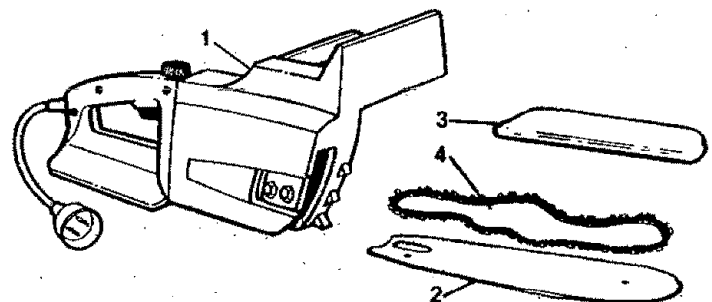

C. ATTACHING THE BAR AND CHAIN

- Your saw is equipped with a Reduced-Kickback Guide Bar and a Low-Kickback Chain.
- Use only the Reduced-Kickback Guide Bar and Low-Kickback Chain specified for your chain saw, when replacing these parts. See "Specifications," page 2.

CAUTION: Wear protective gloves when handling or operating your saw. The chain is sharp and can cut you even when it is not moving!

⚠ WARNING

Avoid accidental starting. Always unplug the saw from the power source before installing a bar and/or chain.

1. Turn unit upside down on a flat surface. Straighten out chain, then lay it on a flat surface.
2. Remove the Bar Clamp Nuts & Bar Clamp Plate. Figure 12.
3. Turn the Adjusting Screw counterclockwise to move the Adjusting Pin almost as far as it will go to the rear. Figure 8. Do not remove Adjusting Pin from the unit.
4. Place the Guide Bar on the saw by fitting the long slot in the Guide Bar over the two mounting studs. Figure 9.
5. Hold chain with cutters facing as shown in Figures 10 and 12.
6. Slide the chain between the right housing and the sprocket. Figure 11 (inset). Place the chain around the sprocket and fit the drive links into the Guide Bar grooves — first the bottom and then the top groove, and then around the guide bar nose. Figure 11.
7. Slide the bar forward and fit the adjusting pin into the round hole in the Guide Bar. Figure 12 (inset).
8. Hold the Guide Bar against the saw frame and install the Bar Clamp Plate. Be sure the tab on the Bar Plate is toward the rear of the Bar. Figure 12.
9. Secure the Bar Clamp Plate with the Bar Clamp Nuts until finger tight *only*.
10. Follow "Chain Tension" Instructions on next page.

CAUTION: If saw chain is installed backwards, the saw will vibrate excessively and will not cut.

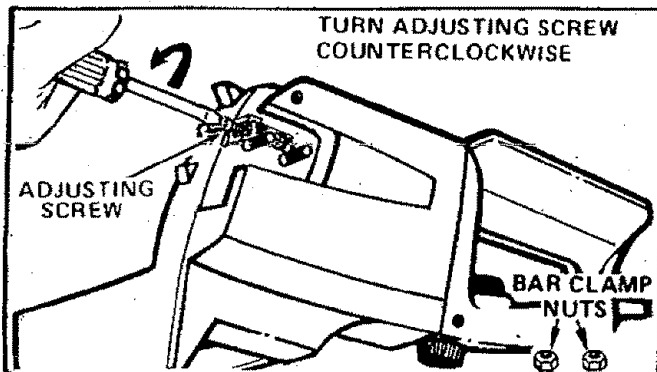

Figure 8

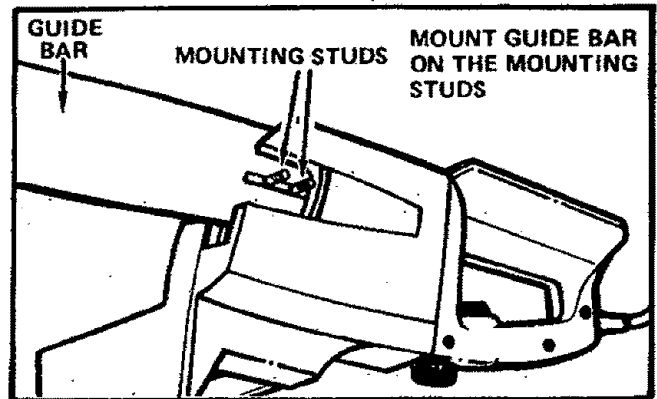

Figure 9

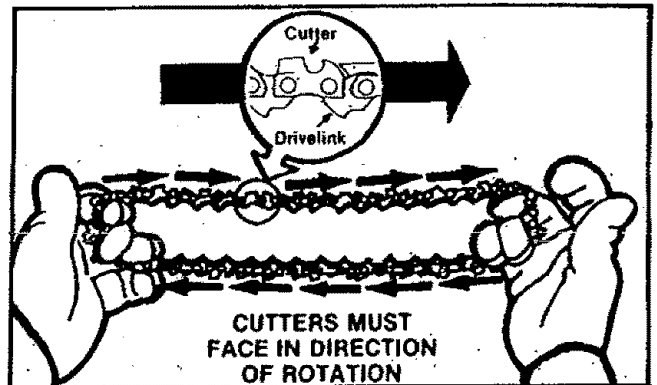

Figure 10

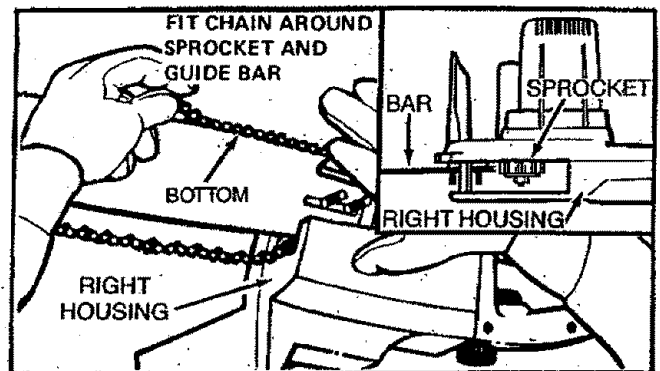

Figure 11

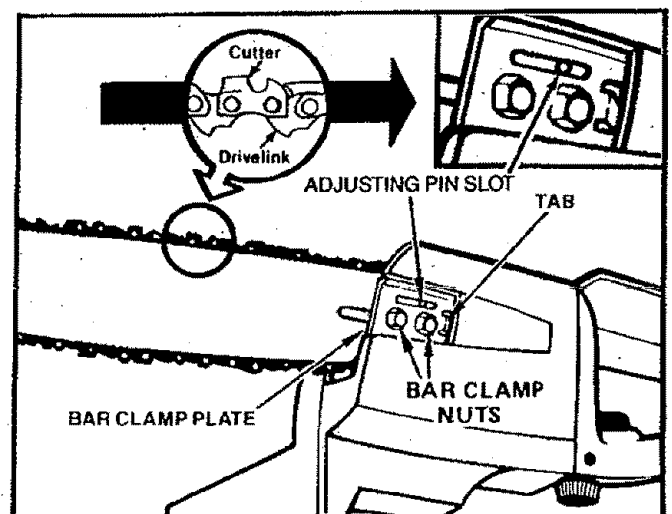

Figure 12

D. CHAIN TENSION

- Chain tension is very important:
 - A loose chain will wear the bar and itself.
 - A loose chain can jump off the bar while you are cutting
 - A tight chain can damage the saw and/or break.
- The chain stretches during use, especially when new. Check tension:
 - each time the saw is used
 - more frequently when the chain is new
 - as the chain warms up to normal operating temperature.

⚠ WARNING

Avoid accidental starting. Always unplug the saw from the power source before adjusting chain tension.

- It is recommended that the saw be turned upside down for chain tensioning.
 - Chain tensioning procedure:
NOTE: The bar clamp nuts must be no more than finger tight to tension the chain correctly.
1. Hold the saw and turn the Adjusting Screw clockwise → until the Tangs on the chain enter the Guide Bar Groove. Figure 13 (inset).
NOTE: To tighten chain, turn the adjusting screw clockwise →. To loosen chain, turn the adjusting screw counterclockwise ←. Figure 13.
 2. With your gloved hand, "snap" the chain several times by pulling down and letting go of the chain. Figure 14. This action removes some of the stiffness in the chain.
 3. Turn the Adjusting Screw clockwise → until the chain tie-straps sag 1/16" below the bar rails. Figure 14 (inset).

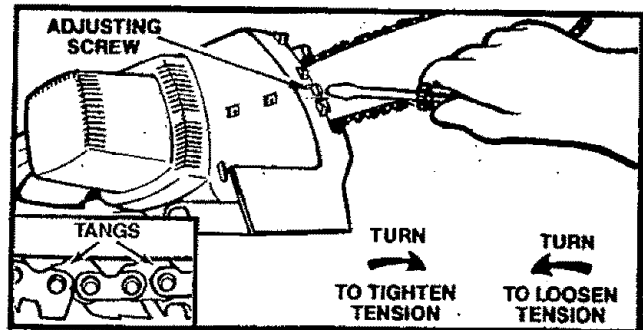

Figure 13

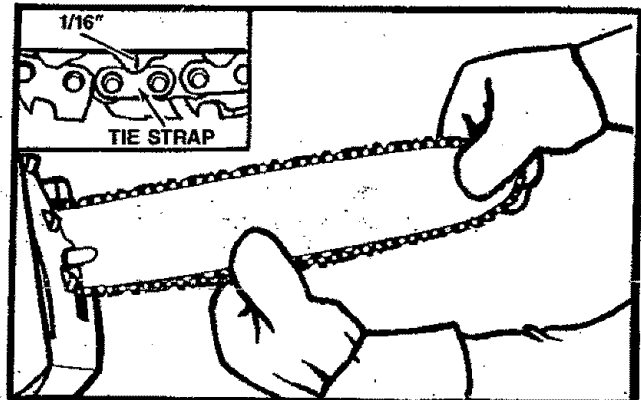

Figure 14

4. Hold the saw and tighten the Bar Clamp Nuts with a 9/16" wrench.
5. Recheck tension.

E. BAR AND CHAIN OIL

- The guide bar and cutting chain require continuous lubrication in order to remain in operating condition.
 - Lack of oil will quickly ruin the bar and chain.
 - Too little oil will cause overheating shown by smoke coming from the chain and/or discoloration of the guide bar rails.
- Use Sears Bar and Chain Lubricant #71-36554 to fill the oil tank. Clean SAE 30W oil may also be used. *Never use waste oil for this purpose.*

1. IMPORTANT POINTS

- a. Fill the oil tank every time you use the saw and recheck after every 15 minutes of use. See "Specifications" for oil cap location.
- b. Wipe off surfaces before filling with oil to avoid saw dust or debris accidentally falling into the tank and causing damage.
- c. Use a funnel to fill the tank. Pour slowly to allow air to escape. Wipe up all spills. Do not use the saw until it is wiped clean and is completely dry from spilled oil.
- d. Replace the oil cap securely to ensure proper operation of the oiler.
- e. Check the oil level indicator frequently during use. Locate the indicator in the saw frame just below and behind the front handle. Figure 15. If oil is not visible in the slot when saw is upright on a level surface, the tank requires filling.

- f. Let saw stand unplugged for 15 minutes before storing. It is normal for a small amount of oil to drip off the bar and chain when the saw is not in use. The excess oil should be wiped from the saw before storing.

2. USING THE MANUAL OILER

Your saw is equipped with an oiler actuator/cap which manually supplies oil to the bar and chain. Figure 15. The oiler actuator/cap must be used regularly and often enough to maintain a thin film of oil on the bar and chain while the saw is cutting. It is recommended that the oiler actuator/cap be operated six (6) times a minute and held for approximately three (3) seconds each time it is pressed.

- a. Operate the oiler by pressing down on the oiler actuator/cap with your right thumb. Figure 15.
- b. Be sure that you continue to grip handles firmly while using the oiler actuator/cap.

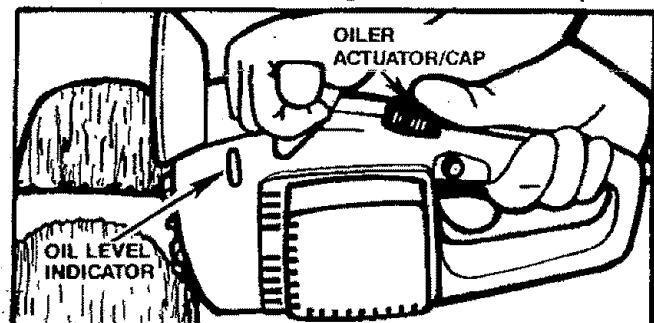

Figure 15

USING YOUR SAW

A. CONTROL DEVICES

Understanding the control devices on your saw is an important part of learning how to properly and safely operate the unit. Figure 16.

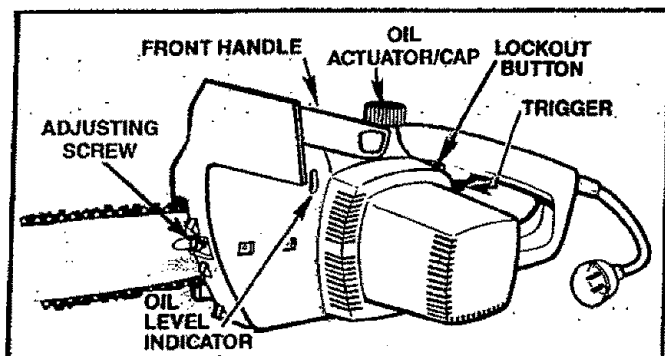

Figure 16

1. The **Trigger Switch** starts or stops the motor and is located in the rear handle. The Trigger Switch is designed to be used with the Lockout Button.
2. The **Lockout Button** is a control feature designed to prevent the motor from being accidentally started. When the rear handle is gripped in a normal cutting position, the Lockout Button can be pushed in by the thumb permitting the index finger to squeeze the Trigger. It is not necessary to maintain pressure on the Lockout button once the Trigger has been engaged.
3. The **Front and Rear handles** are the supports which allow you to grip the saw in the normal cutting position. Your grip on the handles is most important because proper grip gives you maximum ability to control the saw for safe operation. See Figure 3 for proper grip.

B. PRE-OPERATION CHECKS

Before operating your unit always:

1. ✓ Check over safety rules and precautions in this manual. Make certain you completely understand and follow each one.
2. ✓ Check protective gear. Always use eye, hearing, and head protection devices; safety footwear, protective gloves, and snug fitting clothing.
3. ✓ Check the work area. Keep children, bystanders, and animals a safe distance away from the work area when starting or operating the saw — a minimum of 30 feet.
4. ✓ Check weather conditions. Do not use your saw in bad weather, such as strong wind, electrical storms, rain, snow, etc., or at night.
5. ✓ Check the unit for loose bolts, nuts or fittings. Tighten, repair, or replace parts as necessary.
6. ✓ Check tool cord and extension cord. Inspect all wire insulation with care. Do not operate with cracked or deteriorated insulation. Take the saw to your Sears Service Center for all electrical repairs.
7. ✓ Check the saw chain. The chain should be sharp and at the correct tension.
8. ✓ Check the oil tank. The tank should be filled each time the saw is used.
9. ✓ Check the handles. Handles should be dry and free of oil.

C. STARTING AND STOPPING THE SAW

1. Connect the saw to a proper electric power source.
2. Start the saw by pushing the Lockout Button with your right thumb and squeezing the Trigger Switch with your right index finger.
3. Stop the saw by releasing the Trigger Switch.
4. Unplug the connection to the power source.

NOTE: Push in the Lockout Button BEFORE squeezing the Trigger. Any pressure on the Trigger before the Lockout Button is pressed will make the Lockout Button hard to move. It is not necessary to continue pressing the Lockout Button once the Trigger Switch has been engaged.

CAUTION: Damage to the trigger switch can occur if the switch is turned on and off while the saw is cutting. Operate the trigger with firm and decisive action. The saw must be running at full speed before starting the cut and turned off only after leaving the material to avoid damage.

TYPES OF CUTTING

A. BASIC CUTTING TECHNIQUE

1. IMPORTANT POINTS

- Cut wood only. Do not cut metal, plastics, masonry, non-wood building materials, etc. Do not use your saw to pry or shove away limbs, roots or other objects.
- Stop the saw if the chain strikes a foreign object. Inspect the unit and repair or replace parts as necessary.
- Keep the chain out of dirt and sand. Even a small amount of dirt will quickly dull a chain, which increases the possibility of kickback.

▲ KICKBACK WARNING

Kickback can occur when the moving chain contacts an object at the upper portion of the tip of the guide bar or when the wood closes in and pinches the saw chain in the cut. Contact at the upper portion of the tip of the guide bar can cause the chain to dig into the object and stop the chain for an instant. The result is a lightning fast, reverse reaction which kicks the guide bar up and back toward the operator. If the saw chain is pinched along the top of the guide bar, the guide bar can be driven rapidly back toward the operator. Either of these reactions can cause loss of saw control which can result in serious injury.

2. UNDERSTAND REACTIVE FORCES

Pinch-Kickback and Pull-in occur when the chain is suddenly stopped by being pinched, caught, or by contacting a foreign object in the wood. This results in a reversal of the chain force used to cut wood and causes the saw to move in the opposite direction of chain rotation. Either reaction can result in loss of control and possible serious injury.

- Pinch-Kickback:**
 - occurs when the chain on top of the bar is suddenly stopped.
 - drives the saw straight back toward the operator.
- Pull-in:**
 - occurs when the chain on the bottom of the bar is suddenly stopped.
 - pulls the saw forward.

B. TREE FELLING TECHNIQUES

1. PLAN YOUR SAWING OPERATION CAREFULLY IN ADVANCE

- Clear the work area. You need a clear area all around the tree where you can have secure footing.
- Study the natural conditions that can cause the tree to fall in a particular direction.
 - The WIND direction and speed.
 - The LEAN of the tree.
 - WEIGHTED with BRANCHES on one side.
 - Surrounding TREES and OBSTACLES.
- Look for decay and rot. If the trunk is rotted, it can snap and fall toward the operator.
- Check for broken or dead branches which could fall on you while cutting.
- Make sure there is enough room for the tree to fall. Maintain a distance of 2½ tree lengths from the nearest person or other objects. Motor noise can drown out warning call.
- Remove dirt, stones, loose bark, nails, staples, and wire from the tree where cuts are to be made.
- Plan to stand on the up-hill side when cutting on a slope. Figure 17.
- Plan a clear retreat path to the rear and diagonal to the line of fall. Figure 18.

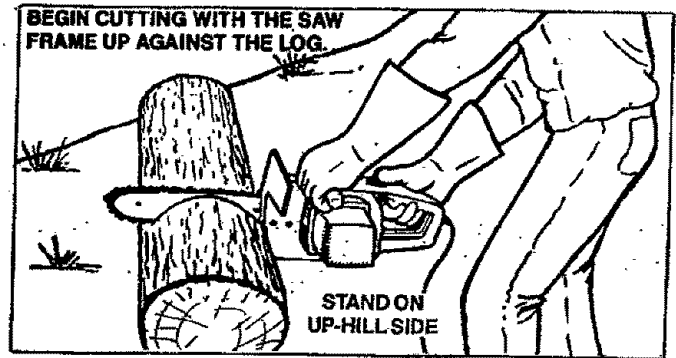

Figure 17

CAUTION: Do not stall the chain in the cut. This will overheat the motor and cause damage.

3. PROCEDURE

Practice cutting a few small logs using the following technique to get the "feel" of using your saw before you begin a major sawing operation

- Assume the proper cutting stance described in the section "Special Safety Section," page 3, — firm grip on front and rear handles, weight evenly balanced on both feet, and body slightly to the left side of the saw.
- Make sure the extension cord is completely away from the saw and your body so the cord cannot be cut or become wrapped around your feet or legs.
- Press the trigger to start the chain moving before beginning the cut.
- Begin cutting with the saw frame and spikes against the log. Figure 17.
- Allow the chain to cut for you. Exert only light downward pressure. If you force the cut, damage to the bar, chain or motor can result.
- Do not put pressure on the saw at the end of the cut to avoid losing control when the cut is complete.
- Release the trigger switch as soon as the cut is completed.
- Unplug the unit after each cutting operation.

2. FELLING SMALL TREES — LESS THAN 6" IN DIAMETER

- a. If you know the direction of fall:
 - 1.) Make a single felling cut on the side away from the direction of fall.
 - 2.) Cut all the way through.
 - 3.) Stop the saw, put it down, and get away quickly on your planned retreat path.
- b. If you are not sure which way the tree will fall, use the notch method described for felling large trees.

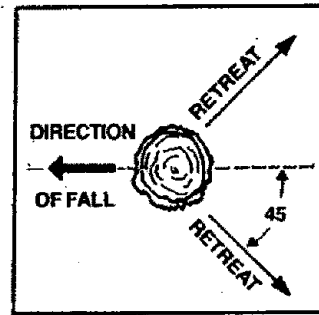

Figure 18

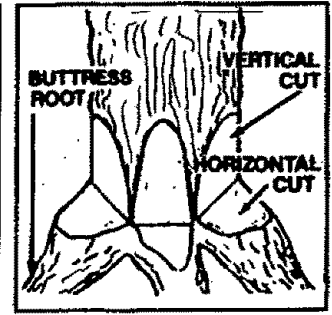

Figure 19

WARNING
Do not cut a tree in any manner that would endanger people, cause property damage, or strike a utility line. Notify the utility company immediately if a tree makes any contact with a utility line.

3. FELLING LARGE TREES — 6" DIAMETER OR MORE

The notch method is used to cut large trees. A notch is cut on the side of the tree in the desired direction of fall. After a felling cut is made on the opposite side of the tree, the tree will tend to fall into the notch.

NOTE: If the tree has large buttress roots, remove before making the notch. Cut into the buttresses vertically, then horizontally. Figure 19.

- a. Make the notch cut. Figure 20.
 - 1.) Cut the bottom of the notch first, through 1/3 of the diameter of the tree.
 - 2.) Complete the notch by making the slant cut.
 - 3.) Remove the notch of wood.
- b. Make the felling cut on the opposite side of the notch about 2" higher than the bottom of the notch.
- c. Leave enough uncut wood between the felling cut and the notch to form a hinge. Figure 21.

NOTE: The hinge helps to keep the tree from twisting and falling in the wrong direction.

- d. Use a wedge if there is any chance that the tree will not fall in the desired direction.

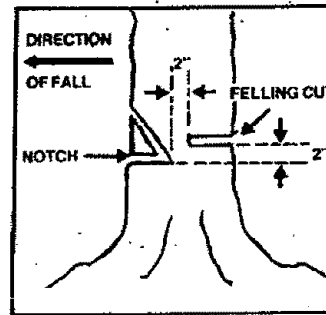

Figure 20

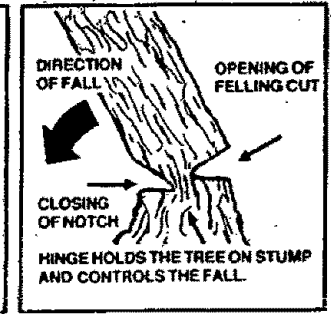

Figure 21

WARNING
Stay on the uphill side of the terrain to avoid the tree rolling or sliding downhill after it is felled.

NOTE: Before the felling cut is complete, drive wedges to open up the cut when necessary to control the direction of fall. Use wood or plastic wedges but *never* metal, to avoid kickback and chain damage.

- e. Be alert for signs that the tree is ready to fall:
 - 1.) cracking sounds
 - 2.) widening of the felling cut
 - 3.) movement in the upper branches.
- f. As the tree starts to fall, *stop the saw; put it down, and get away quickly on your planned retreat path.*
- g. Be extremely cautious with partially fallen trees that may be poorly supported. When a tree doesn't fall completely, set the saw aside and pull down the tree with a cable winch, block and tackle or tractor. To avoid injury, do not cut down a partially fallen tree with your saw.

DON'T PUT YOURSELF IN THESE POSITIONS

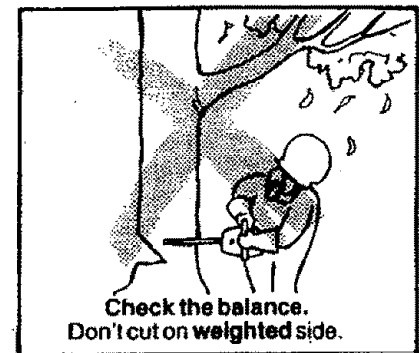
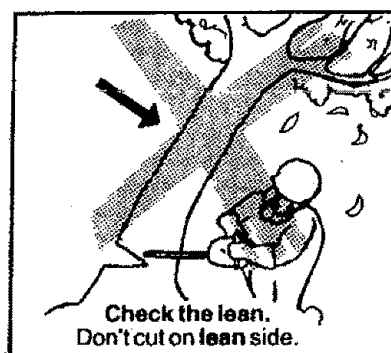
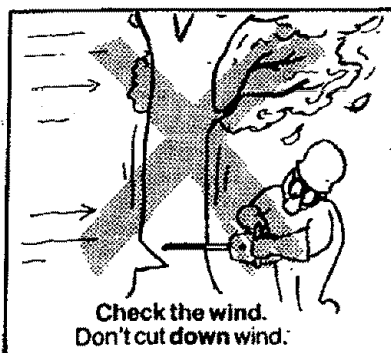

C. BUCKING

- Bucking is the term used for cutting a fallen tree to the desired log size.

1. IMPORTANT POINTS

- Cut only one log at a time.
- Cut shattered wood very carefully. Sharp pieces of wood could be flung toward the operator.
- Use a sawhorse to cut small logs. Never allow another person to hold the log while cutting and never hold the log with your leg or foot.
- Do not cut in an area where logs, limbs and roots are tangled such as in a blown down area. Drag the logs into a clear area before cutting by pulling out exposed and cleared logs first.
- Make the first bucking cut 1/3 of the way through the log and finish with a 2/3 cut on the opposite side. Figures 22, 25 and 26. As the log is being cut, it will tend to bend. The saw can become pinched or hung in the log if you make the first cut deeper than 1/3 of the diameter of the log.
- Give special attention to logs under strain to prevent the saw from pinching. Make the first cut on the pressure side to relieve the stress on the log. Figure 22.

2. TYPES OF CUTTING USED (Figure 23)

- **Overcutting** — begin on the top side of the log with the bottom of the saw against the log; exert light pressure downward.
- **Undercutting** — begin on the under side of the log with the top of the saw against the log; exert light pressure upward. During undercutting, the saw will tend to *push* back at you. Be prepared for this reaction and hold the saw firmly to maintain control.

⚠ WARNING
Never turn the saw upside down to undercut. The saw cannot be controlled in this position.

⚠ WARNING
If saw becomes pinched or hung in a log, don't try to force it out. You could lose control of the saw resulting in personal injury and/or damage to the saw. Stop the saw and drive a wedge of plastic or wood into the cut until saw can be removed easily. Figure 24. Restart the saw and carefully reenter the cut. To avoid kickback and chain damage, do not use a metal wedge. Do not attempt to restart your saw when it is pinched or hung in a log.

3. BUCKING — WITHOUT A SUPPORT

- Overcut with a 1/3 diameter cut.
- Roll log over and finish with an overcut.

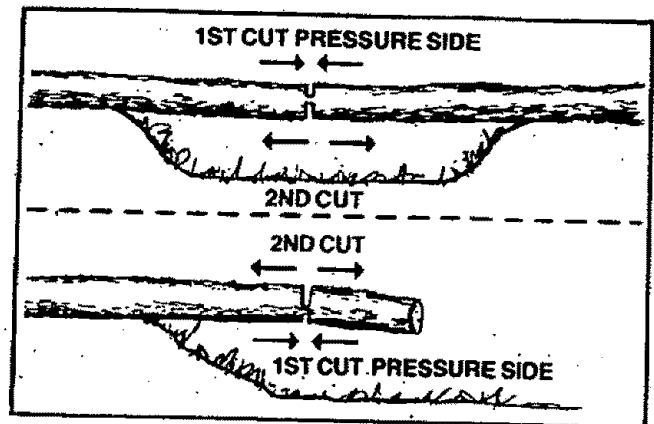

Figure 22

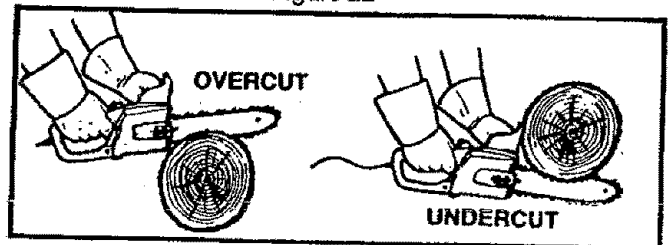

Figure 23

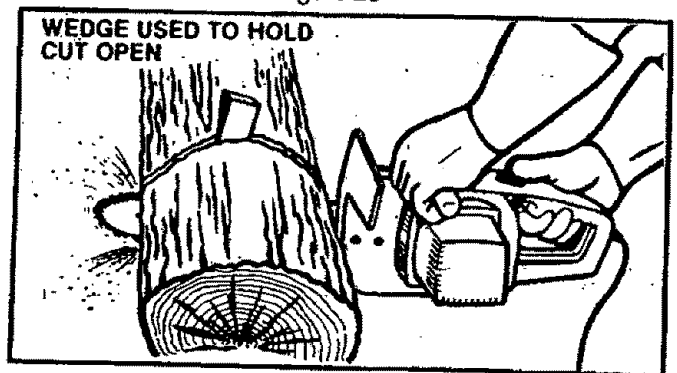

Figure 24

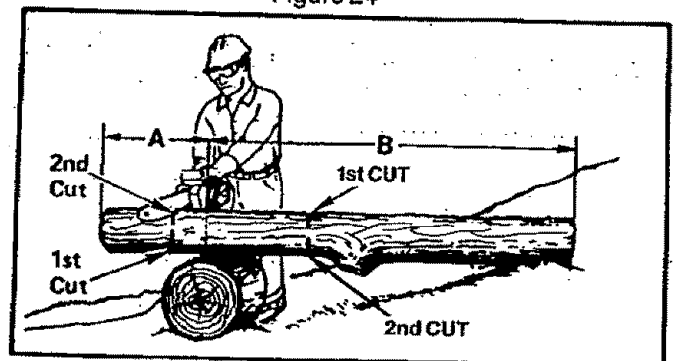

Figure 25

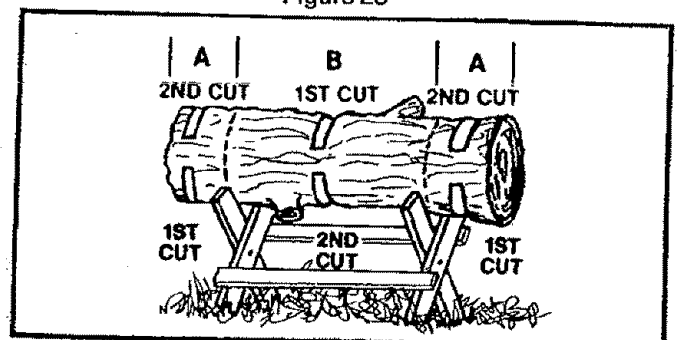

Figure 26

4. BUCKING — USING ANOTHER LOG AS A SUPPORT (Figure 25):

- a. In area A:
 - 1.) Undercut 1/3 of the way through the log.
 - 2.) Finish with an overcut.
- b. In area B:
 - 1.) Overcut, 1/3 of the way through the log.
 - 2.) Finish with an undercut.

5. BUCKING — USING A STAND (Figure 26):

- a. In area A:
 - 1.) Undercut 1/3 of the way through the log.
 - 2.) Finish with an overcut.
- b. In area B:
 - 1.) Overcut 1/3 of the way through the log.
 - 2.) Finish with an undercut.

▲ WARNING
Do not stand on the log being cut. Any portion can roll causing loss of footing and control.

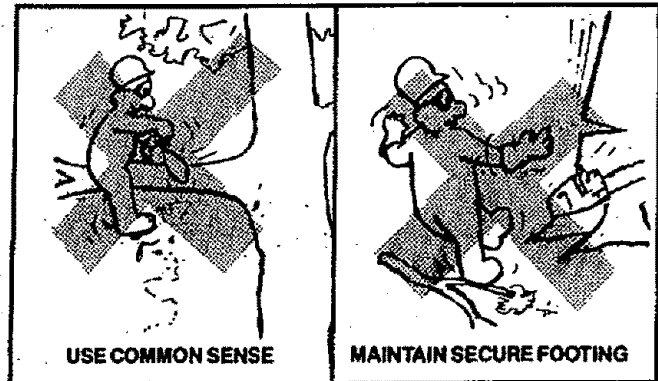

D. DEBRANCHING AND PRUNING

- Work slowly, keeping both hands on the saw with a firm grip. Maintain secure footing and balance.
- Watch out for springpoles. Use extreme caution when cutting small size limbs. Slender material can catch the saw chain and be whipped toward you or pull you off balance.
- Be alert for springback. Watch out for branches that are bent or under pressure as you are cutting to avoid being struck by the branch or the saw when the tension in the wood fibers is released.
- Keep a clear work area. Frequently clear branches out of the way to avoid tripping over them.

▲ WARNING
Never climb into a tree to debranch or prune. Do not stand on ladders, platforms, a log or in any position which can cause you to lose control of the saw.

1. DEBRANCHING

- a. Always debranch a tree after it is cut down. Only then can debranching be done safely and properly.
- b. Leave the larger limbs underneath the felled tree to support the tree as you work.
- c. Start at the base of the felled tree and work towards the top, cutting branches and limbs. Remove small limbs with one cut. Figure 27.
- d. Keep the tree between you and the chain. Cut from the side of the tree opposite the branch you are cutting.
- e. Remove larger, supporting branches with the 1/3, 2/3 cutting techniques described in the bucking section.
- f. Always use an overcut to cut small and freely hanging limbs. Undercutting could cause limbs to fall and pinch the saw.

2. PRUNING

- a. Limit pruning to limbs shoulder height or below. Do not cut if branches are higher than your shoulder. Get a professional to do the job.
- b. Refer to Figure 28 for pruning technique.
 - 1.) Undercut 1/3 of the way through the limb near the trunk of the tree.
 - 2.) Finish with an overcut farther out from the trunk.
 - 3.) Keep out of the way of the falling limb.
 - 4.) Cut the stump flush near the trunk of the tree.

▲ WARNING
Be alert for and guard against kickback. Do not allow the moving chain to contact any other branches or objects at the nose of the guide bar when debranching or pruning. Allowing such contact can result in serious injury.

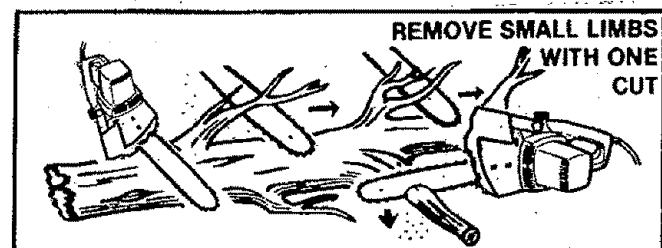

Figure 27

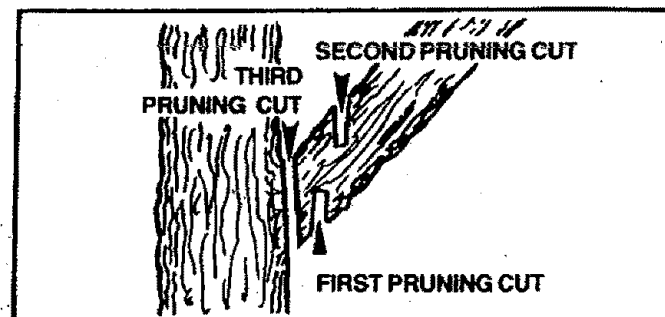

Figure 28

MAINTENANCE

- A good maintenance program of regular inspection and care will increase the service life and help to maintain the safety and performance of your saw.

WARNING

All electrical repairs to this saw, including housing, switch, motor, etc., must be diagnosed and serviced by your Sears Service Center. Failure to do so can cause the double insulation construction to become ineffective and result in serious injury.

- Inspect all wire insulation carefully before each period of use. Do not operate or try to repair the saw if wire insulation is cracked or deteriorated. Take the unit to your Sears Service Center for repair.

- Check the saw for loose bolts, screws, nuts, and fittings daily when the saw is in use. Loose fasteners can cause an unsafe condition as well as damage to your saw. Tighten, repair, or replace as necessary.

WARNING

Avoid accidental starting. Always unplug the saw from the power source before cleaning or performing any maintenance to the saw or when not in use.

A. CLEANING THE SAW

Clean and inspect the saw after each day of use.

1. Remove the bar and chain from the saw.
NOTE: Always clean the Guide Bar and Chain when the chain is sharpened.
2. Use a small brush or the air discharge of a vacuum cleaner to clean debris and sawdust from the air inlet and exhaust slots on housing. Figure 29.
3. Wipe saw clean with rags. Make sure there is no oil film on the handles or saw housing.

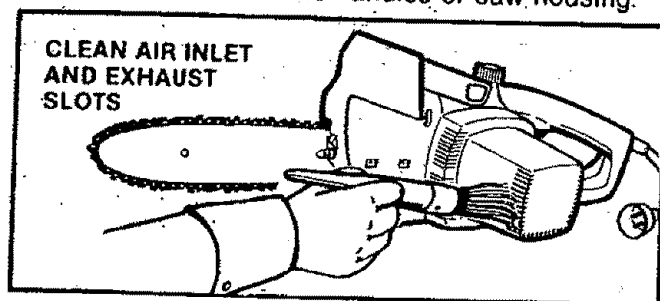

Figure 29

CAUTION: Do not use water, gasoline, kerosene or any type of cleaning fluid to clean the housing. Moisture can cause short circuits. Hydrocarbons will attack and deteriorate the housing.

4. Remove all sawdust and oil from the drive sprocket and bar-mounting pad area of the saw. Figure 30.

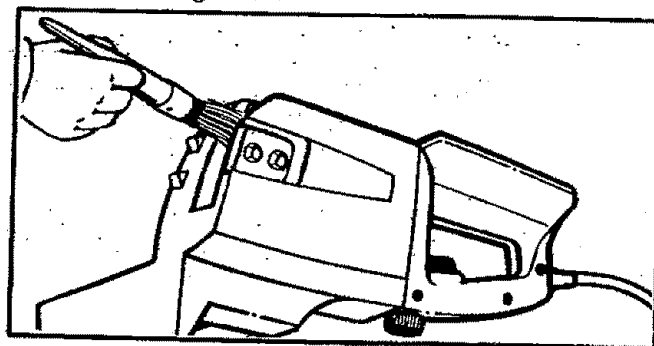

Figure 30

B. GUIDE BAR AND CHAIN

- Increase the service life of your Guide Bar and Chain by:
 - Using the saw properly and as recommended in this manual.
 - Maintaining the correct Chain Tension. See "Chain Tension."
 - Proper lubrication. See "Bar & Chain Lubricant."
 - Regular maintenance as described in this section.
- Remove the Guide Bar from the saw for all maintenance.

CAUTION: Always wear gloves when handling the chain. The chain is sharp enough to cut you even though it is too dull to cut wood.

1. CHAIN MAINTENANCE

• Sharpen the chain when:

- Wood chips are small and powdery. Wood chips made by the saw chain should be about the size of the teeth of the chain.
- Saw has to be forced through the cut.
- Saw cuts to one side.

a. CLEAN TREE SAP FROM THE CHAIN BEFORE IT IS SHARPENED:

- 1.) Soak chain in a petroleum based solvent or a detergent and water solution.
- 2.) Dry chain thoroughly.
- 3.) Immerse the clean chain in light oil until oil seeps into the rivet holes.

NOTE: Do not run a chain which has been cleaned without lubricating it first.

b. SHARPENING INSTRUCTIONS

Items required:

- | | |
|------------------|------------------|
| Gloves | Depth Gauge Tool |
| 5/32" round file | Screwdriver |
| 6" file holder | Vise |
| Flat file | |

1.) Sharpen cutters.

- a.) Support the square rod on the file holder (with 5/32" round file) on the cutter top plate and depth gauge. Figure 31.
- b.) Hold the file holder level with the 30° guide mark parallel to the center of the chain. Figure 32.
- c.) File from inside toward outside of cutter, straight across, on forward stroke only. Use 2 or 3 strokes per cutting edge. Figure 32.
- d.) Keep all cutters the same length. Figure 33.
- e.) File enough to remove any damage to cutting edge (side & top plate) of cutter. Figure 33.
- f.) File 91 G chain to meet specifications shown in Figure 34.

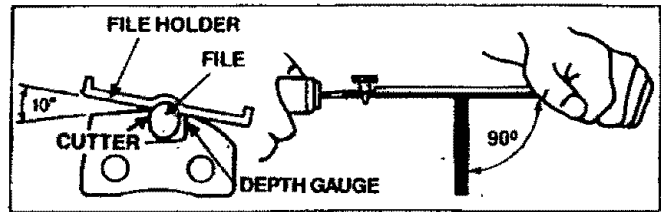

Figure 31

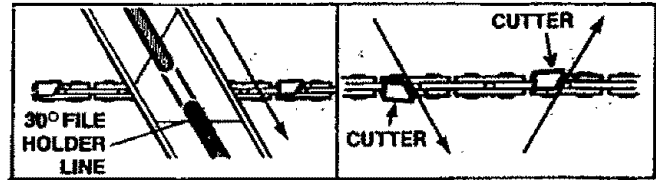

Figure 32

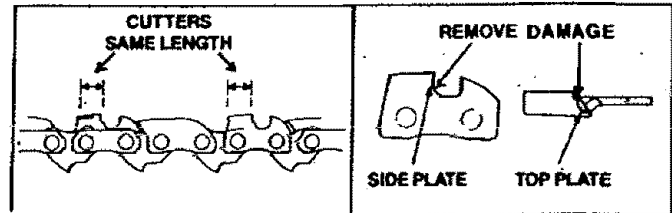

Figure 33

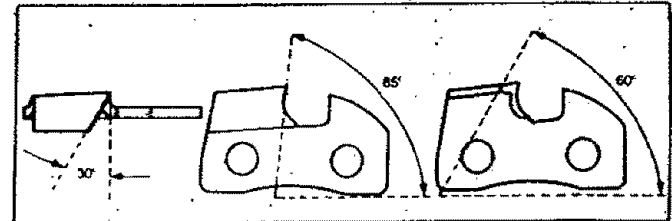

Figure 34

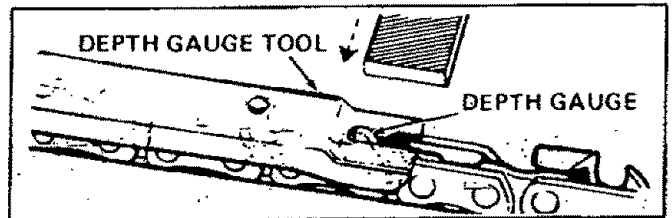

Figure 35

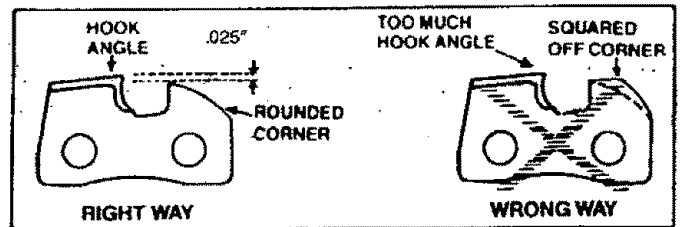

Figure 36

2.) Correct Depth Gauges

NOTE: Avoid contact with other parts of the chain to prevent damage to chain.

- a.) Place depth gauge tool (Catalog No. 71-36557) over each cutter depth gauge. Figure 35.
- b.) File level with the flat file if depth gauge is higher than the depth gauge tool.
- c.) Maintain rounded front corner of depth gauge with a flat file. Figure 35 & 36.

NOTE: The very top of the depth gauge should be flat with the front half rounded off with a flat file.

WARNING

Depth gauge tool is required to insure proper depth gauge filing. Filing the depth gauge too deep will increase the chance of kickback which can result in serious injury.

C. CHAIN REPLACEMENT

- 1) Use only the Low-Kick Chains specified for your saw in "Specifications," for replacement chain.
- 2) Replace the chain when cutters or links break.
- 3) See your Sears Service Center to replace and sharpen individual cutters for matching your chain.
- 4) Always have a worn sprocket/gear assembly replaced by your Sears Service Center when installing a new chain to avoid excessive wear to the chain.

2. GUIDE BAR MAINTENANCE

- Conditions which can require guide bar maintenance:
 - saw cuts to one side
 - saw has to be forced through a cut
 - inadequate supply of oil to bar and chain.
- Check the condition of the guide bar each time the chain is sharpened. A worn guide bar

will damage the chain and make cutting more difficult.

- Replace the guide bar when:
 - the inside groove of the guide bar rails is worn.
 - the guide bar is bent or cracked.
- Use only the Reduced-Kickback Guide Bar specified for your saw in "Specifications," for replacement.
 - a. Remove the guide bar to service.
 - b. Clean oil holes at least once for each five hours of operation.
 - c. Remove sawdust from the guide bar groove periodically with a putty knife or a wire. Figure 37.
 - d. Remove burrs by filing the side edges of the guide bar grooves square with a flat file. Figure 38.
 - e. Restore square edges to an uneven rail top by filing with a flat file. Figure 38.

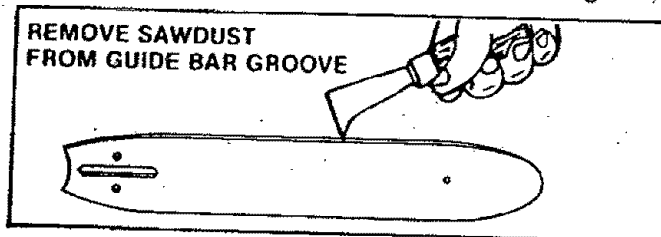

Figure 37

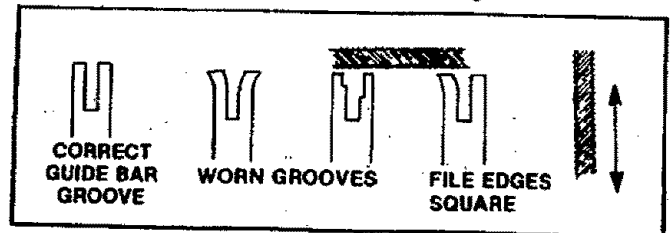

Figure 38

C. SPROCKET/GEAR ASSEMBLY

- Clean the sprocket and surrounding area daily during heavy use of the saw.
- Inspect the sprocket regularly for wear. A worn sprocket will cause the chain to run erratically and will shorten the life of the bar and chain. Figure 39.
- If sprocket is worn (Figure 39), have the sprocket replaced by your Sears Service Center. User Sprocket replacement can cause the double insulation system to become ineffective.

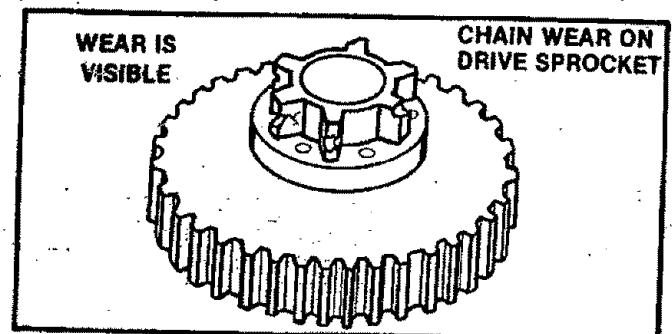

Figure 39

D. STORAGE

When your saw is to be stored for over 30 days always:

1. Store the saw unplugged in a dry place out of the reach of children.
2. Drain oil tank.
3. Remove, clean, and dry the bar and chain.
4. Store the chain in a container filled with oil to prevent rust.
5. Apply a coating of oil to the entire surface of the bar and wrap it in heavy paper, cloth, or plastic.
6. Wipe off the outside surfaces of the unit.

E. MAINTENANCE ACCESSORIES

Available through your nearest Sears Store, Catalog Sales Office, or Service Center, but may not be furnished with your saw.

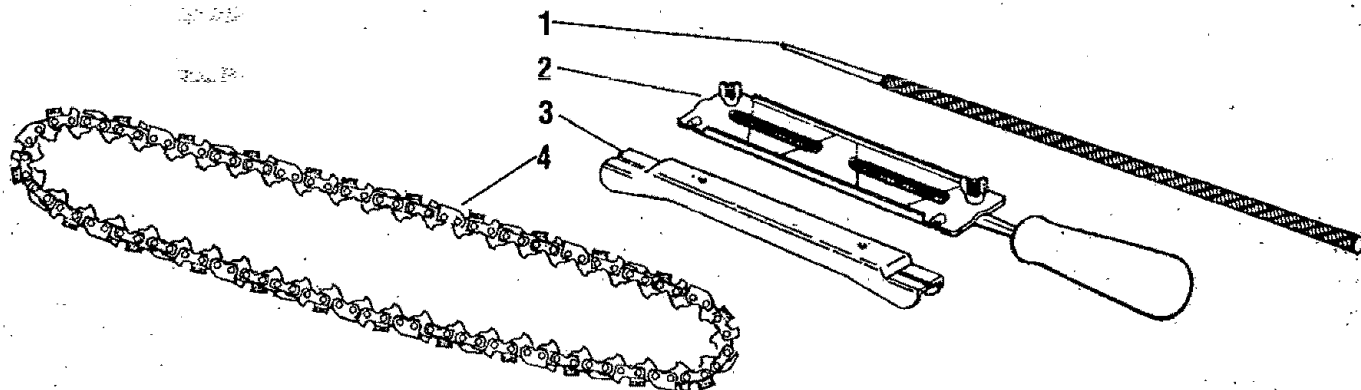

Key No.	Catalog No.	Description
1	71-36524	File (5/32" dia.) Twin pack
2	71-36565	File Guide
3	71-36557	Depth Gauge Tool
4	71-3617	Xtra GUARD® Chain
—	71-36554	Bar and Chain Lubricant - 1 qt.
—	71-36556	Bar and Chain Lubricant - 1 gal.
—	71-36365	Lo-Kick® Guide Bar-14" - (Not Shown)

F. TROUBLE SHOOTING CHART

Read and follow all safety instructions in the Special Safety Section before servicing your saw.

TROUBLE	CAUSE	REMEDY
Oil inadequate for bar and chain lubrication	<ol style="list-style-type: none"> 1. Oil tank empty. 2. Oil outlet clogged. 3. Guide bar oil hole blocked. 	<ol style="list-style-type: none"> 1. Fill oil tank. 2. Contact Sears Service Center. 3. Remove bar and clean.
Chain does not move when trigger switch is engaged.	<ol style="list-style-type: none"> 1. Chain tension too tight. 2. Guide bar rails pinched. 3. Trigger switch failure. 	<ol style="list-style-type: none"> 1. See Chain Tension. 2. Repair or replace. 3. Contact Sears Service Center.
Chain clatters or cuts roughly	<ol style="list-style-type: none"> 1. Chain tension incorrect. 2. Cutters dull, improperly sharpened; depth gauges too high. 3. Sprocket worn. 4. Chain wear due to contact with dirt, sand, or metal object in wood. 5. Cutters damaged after striking foreign material. 	<ol style="list-style-type: none"> 1. See Chain Tension. 2. See Chain Sharpening. 3. Contact Sears Service Center. 4. Resharpener or replace Chain. 5. Sharpen all cutters evenly and uniformly or replace chain. See Chain Sharpening.
Chain stops within the cut	<ol style="list-style-type: none"> 1. Chain cutter tops not filed flat. 2. Guide bar burred or bent; rails uneven. 	<ol style="list-style-type: none"> 1. See Chain Sharpening. 2. Repair or replace guide bar.
Chain cuts at an angle	<ol style="list-style-type: none"> 1. Cutters damaged on one side. 2. Chain dull on one side. 3. Guide bar bent or worn. 	<ol style="list-style-type: none"> 1. Resharpener until all cutters have equal angles and lengths or replace chain. 2. Resharpener until all cutters have equal angles and lengths or replace chain. 3. Replace guide bar.

SEARS CHAIN SAW REPAIR PARTS LIST - MODEL NO. 358.34110-2.0/14"

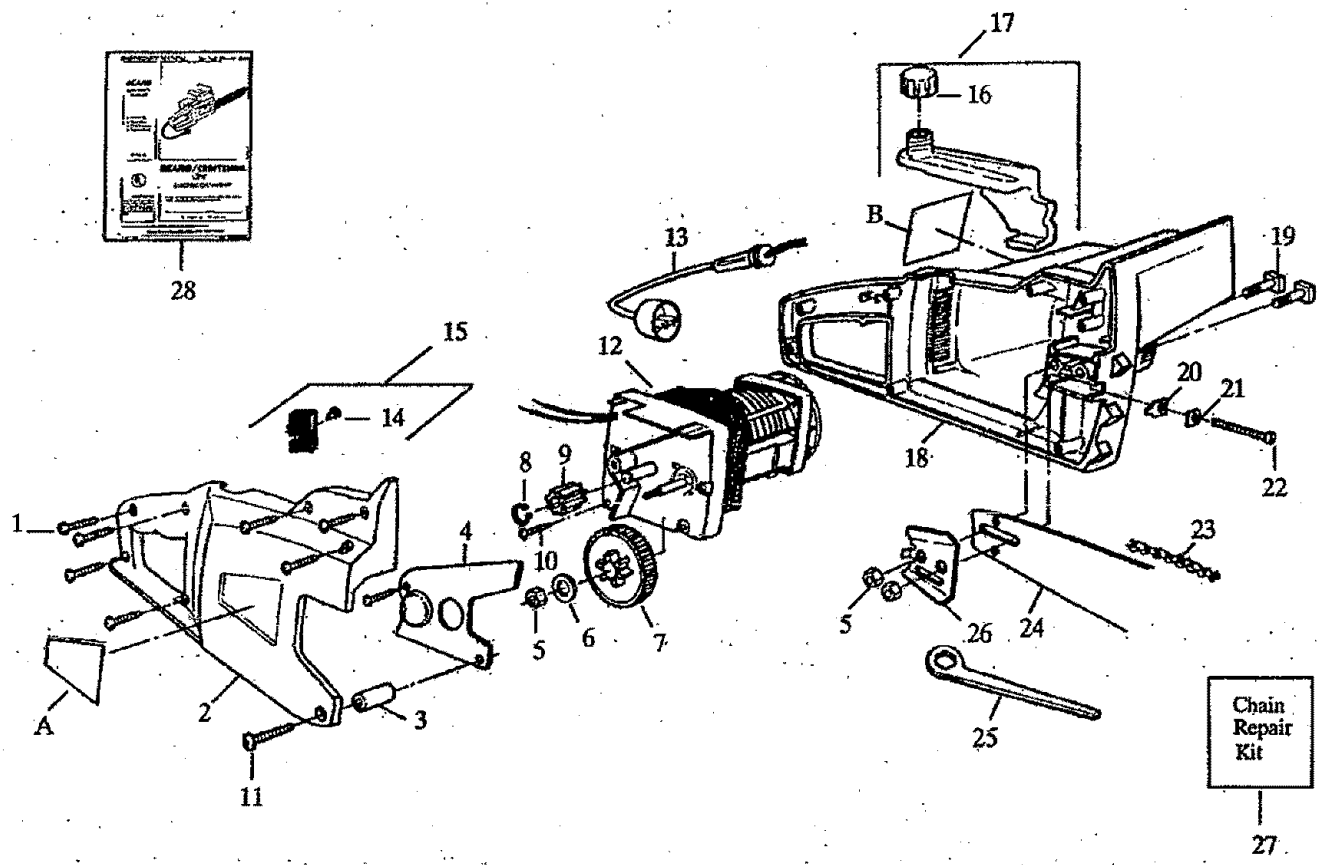

Key No.	Part No.	Description	Key No.	Part No.	Description
1	530-015834	Screw	19	530-015831	Bolt-Bar Mounting
2	530-029204	Housing (Right)	20	530-023492	Pin
3	530-015832	Spacer	21	530-025466	Plate (Bar Adjust.)
4	530-029278	Gear Cover	22	530-015514	Screw
5	530-001721	Nut	23	71-3617	Chain (14")
6	530-015842	Washer	24	71-36365	Bar (14")
7	530-029341	Gear Ass'y W/Bushing	25	530-031063	Wrench
8	STD582031	Retaining Ring	26	530-029285	Plate
9	530-025463	Gear Pinion	27	530-052073	Chain Repair Kit
10	530-015495	Screw	28	530-067576	Operators Manual
11	530-015835	Screw			
12	530-014164	Motor Ass'y (incl. 8, 9 & 10)		Not Shown	
13	530-089765	Cordset		530-025644	Scabbard
14	530-025873	Safety Lock Button		530-061172	Carton
15	530-025518	Switch-W/Safety Lock			
16	530-029282	Oil Cap		Decals	
17	530-014170	Oil Tank Ass'y	A	530-029308	Decal
18	530-014169	Housing (Left) (incl. 19)	B	530-029307	Decal

NOTES

NOTES

QUICK REFERENCE PAGE

Read and follow all Safety Rules, Precautions and Operating Instructions.
Failure to do so can result in serious injury.

	page
SAFETY RULES AND PRECAUTIONS	3
PREPARING YOUR SAW FOR USE	7
1. Wear protective gear — gloves; safety footwear; snug fitting clothing; and eye, hearing, and head protection.	
2. Check for worn, loose, or damaged parts and repair or replace before using the saw.	
3. Check the chain for sharpness and tension.	
4. Keep children, bystanders, and animals a minimum of 30 feet away from the work area.	
5. Plan your sawing operation carefully in advance.	
BAR AND CHAIN OIL	9
1. Fill the oil tank with clean oil each time the saw is used.	
2. Use a funnel to fill the tank and wipe up all spills.	
3. Replace the oil cap securely.	
4. Operate the oiler actuator/cap six times a minute and hold down for approximately three seconds each time the actuator/cap is pressed.	
USING YOUR SAW	10
1. Connect the saw to a proper power source.	
2. Make sure the extension cord is completely away from the saw and cannot be cut.	
3. Start the saw by pushing the lockout button and squeezing the trigger before entering the cut.	
4. Begin cutting with the saw frame against the log.	
5. Allow the chain to cut for you; exert only light downward pressure.	
6. Release the trigger switch as soon as the cut is completed.	
7. Unplug the unit after each cutting operation.	
MAINTENANCE	15
1. Take your saw to a Sears Service Center for all electrical related repairs.	
2. Check the guide bar for wear each time the chain is sharpened.	
3. Install a new sprocket/gear assembly each time a new chain is installed.	
4. Let saw stand unplugged for 15 minutes and wipe oil from saw and bar before storing.	
5. Store saw in a dry place out of the reach of children.	
COMMON CHAIN SAW TERMS	
1. Front Handle — The support handle located at or toward the front of the chain saw.	
2. Rear Handle — The support handle located at or toward the rear of the saw.	
3. Trigger Switch — A device that when operated will complete or interrupt an electrical power circuit to the motor of the chain saw which starts or stops the motor.	
4. Lockout Button — A movable stop that prevents the unintentional operation of the trigger switch until manually actuated.	
5. Oiler Actuator/Cap — A system for oiling the guide bar and saw chain.	
6. Guide Bar — A solid, railed structure that supports and guides the saw chain.	
7. Saw Chain — A loop of chain having cutting teeth (that cut the wood) that is driven by the motor and supported by the guide bar.	
8. Sprocket — The toothed part that drives the saw chain.	
9. Hand Guard — The flat, shielding surface between the front handle and the nose of the guide bar.	
10. Spiked Bumper (Spike) — The pointed tooth or teeth for use when felling or bucking to pivot the saw and maintain position while sawing.	
11. Kickback — The backward and/or upward motion of the guide bar occurring when the saw chain near the nose of the top area of the guide bar contacts any object such as another log or branch, or when the wood closes in and pinches the saw chain in the cut.	
12. Normal Cutting Position — The position assumed in performing the bucking and felling cuts.	
13. Felling — The process of cutting down a tree.	
14. Notch Cut — A notch cut in a tree that directs the fall of the tree.	
15. Felling Cut — The final cut in a tree felling operation made on the opposite side of the tree from the notch cut.	
16. Bucking — The process of cross-cutting a felled tree or log into lengths.	
17. Plunge Cuts/Bore Cuts — The process involved in cutting with the saw chain at the nose (tip) of the guide bar, in order to make a hole. ▲WARNING: Sears does not recommend performing plunge cuts or bore cuts due to the dangers of kickback.	
18. Adjusting pin/Adjusting Screw — A screw and pin system which moves the guide bar forward and backward; Used for chain tensioning.	
19. Powerhead — The part of the saw including the motor, handle, and hand guard.	

SEARS

operator's
manual

MODEL NO.
358.34110 - 2.0/14"

How to Order Repair Parts

SEARS SERVICE
IS AT YOUR SERVICE

The Model Number and Serial Number will be found on the motor housing decal facing the user when holding the saw in the cutting position. Always mention the Model Number when requesting service or repair parts for your Chain Saw.

All parts listed herein may be ordered from any Sears Service Center and most Sears Stores.

WHEN ORDERING REPAIR PARTS ALWAYS GIVE THE FOLLOWING INFORMATION AS SHOWN IN THIS LIST.

1. The PART NUMBER
2. The MODEL NUMBER
358.34110-2.0/14"
3. The PART DESCRIPTION
4. The NAME OF ITEM —
Electric Chain Saw.

If the parts you need are not stocked locally, your order will be electronically transmitted to a Sears Repair Parts Distribution Center for expedited handling.



When you buy merchandise from Sears you get an extra something that nobody else can offer Sears Service.

Across town or across the country, Sears Service follows you, providing trustworthy, competent service technicians using only Sears specified factory parts.

SEARS / CRAFTSMAN.

CHAIN AND BAR LUBRICANT

Available in Gallons (#71-36554)
and in Quarts (#71-36556) at your
nearest Sears Store, Catalog
Sales Office, or Service Center.



Sold by Sears, Roebuck and Co., Chicago, Ill. 60684 U.S.A.