



LN-T4069F  
LN-T4669F

TFT-LCD TELEVISION



# Owner's Instructions

Register your product at [www.samsung.com/global/register](http://www.samsung.com/global/register)  
Record your Model and Serial number here for future reference.

· Model \_\_\_\_\_ · Serial No. \_\_\_\_\_

## Important Warranty Information Regarding Television Format Viewing

Wide screen format LCD Displays (16:9, the aspect ratio of the screen width to height) are primarily designed to view wide screen format full-motion video. The images displayed on them should primarily be in the wide screen 16:9 ratio format, or expanded to fill the screen if your model offers this feature and the images are constantly moving. Displaying stationary graphics and images on screen, such as the dark side-bars on nonexpanded standard format television video and programming, should be limited to no more than 5% of the total television viewing per week.

Additionally, viewing other stationary images and text such as stock market reports, video game displays, station logos, web sites or computer graphics and patterns, should be limited as described above for all televisions. Displaying stationary images that exceed the above guidelines can cause uneven aging of LCD Displays that leave subtle, but permanent burned-in ghost images in the LCD picture. To avoid this, vary the programming and images, and primarily display full screen moving images, not stationary patterns or dark bars. On LCD models that offer picture sizing features, use these controls to view different formats as a full screen picture.

Be careful in the selection and duration of television formats used for viewing. Uneven LCD aging as a result of format selection and use, as well as burned-in images, are not covered by your Samsung limited warranty.

### U.S.A Only

The product unit accompanying this user manual is licensed under certain intellectual property rights of certain third parties. In particular, this product is licensed under the following US patents: 5,991,715, 5,740,317, 4,972,484, 5,214,678, 5,323,396, 5,539,829, 5,606,618, 5,530,655, 5,777,992, 6,289,308, 5,610,985, 5,481,643, 5,544,247, 5,960,037, 6,023,490, 5,878,080, and under US Published Patent Application No. 2001-44713-A1.

This license is limited to private non-commercial use by end-user consumers for licensed contents. No rights are granted for commercial use. The license does not cover any product unit other than this product unit and the license does not extend to any unlicensed product unit or process conforming to ISO/IEC 11172-3 or ISO/IEC 13818-3 used or sold in combination with this product unit. The license only covers the use of this product unit to encode and/or decode audio files conforming to the ISO/IEC 11172-3 or ISO/IEC 13818-3. No rights are granted under this license for product features or functions that do not conform to the ISO/IEC 11172-3 or ISO/IEC 13818-3.

### Other countries

The product unit accompanying this user manual is licensed under certain intellectual property rights of certain third parties. This license is limited to private non-commercial use by end-user consumers for licensed contents. No rights are granted for commercial use. The license does not cover any product unit other than this product unit and the license does not extend to any unlicensed product unit or process conforming to ISO/IEC 11172-3 or ISO/IEC 13818-3 used or sold in combination with this product unit. The license only covers the use of this product unit to encode and/or decode audio files conforming to the ISO/IEC 11172-3 or ISO/IEC 13818-3. No rights are granted under this license for product features or functions that do not conform to the ISO/IEC 11172-3 or ISO/IEC 13818-3.

## SAMSUNG ELECTRONICS NORTH AMERICAN LIMITED WARRANTY STATEMENT

Subject to the requirements, conditions, exclusions and limitations of the original Limited Warranty supplied with Samsung Electronics (SAMSUNG) products, and the requirements, conditions, exclusions and limitations contained herein, SAMSUNG will additionally provide Warranty Repair Service in the United States on SAMSUNG products purchased in Canada, and in Canada on SAMSUNG products purchased in the United States, for the warranty period originally specified, and to the Original Purchaser only.

The above described warranty repairs must be performed by a SAMSUNG Authorized Service Center. Along with this Statement, the Original Limited Warranty Statement and a dated Bill of Sale as Proof of Purchase must be presented to the Service Center. Transportation to and from the Service Center is the responsibility of the purchaser.

Conditions covered are limited only to manufacturing defects in material or workmanship, and only those encountered in normal use of the product.

Excluded, but not limited to, are any originally specified provisions for, in-home or on-site services, minimum or maximum repair times, exchanges or replacements, accessories, options, upgrades, or consumables.

For the location of a SAMSUNG Authorized Service Center, please call toll-free:

**In the United States : 1-800-SAMSUNG (1-800-726-7864)**

**In Canada : 1-800-SAMSUNG**

### Precautions When Displaying a Still Image

A still image may cause permanent damage to the TV screen

- Do not display a still image on the LCD panel for more than 2 hours as it can cause screen image retention. This image retention is also known as "screen burn". To avoid such image retention, reduce the degree of brightness and contrast of the screen when displaying a still image.



Watching the LCD TV in 4:3 format for a long period of time may leave traces of borders displayed on the left, right and center of the screen caused by the difference of light emission on the screen.

Playing a DVD or a game console may cause a similar effect to the screen.

Damages caused by the above effect are not covered by the Warranty.

- Displaying still images from Video games and PC for longer than a certain period of time may produce partial after-images. To prevent this effect, reduce the 'brightness' and 'contrast' when displaying still images.

# Contents

## GENERAL INFORMATION

■ List of Features.....	2
■ Accessories.....	2
■ Viewing the Control Panel.....	3
■ Viewing the Connection Panel.....	4
■ Remote Control.....	5
■ Installing Batteries in the Remote Control.....	6

## CONNECTIONS

■ Connecting VHF and UHF Antennas.....	6
■ Connecting Cable TV.....	7
■ Connecting a DVD Player or Cable Box/Satellite receiver (Set-Top Box) via HDMI.....	8
■ Connecting a DVD Player or Cable Box/Satellite receiver (Set-Top Box) via DVI.....	8
■ Connecting a DVD Player or Cable Box/Satellite receiver (Set-Top Box) via Component cables.....	9
■ Connecting a Camcorder.....	9
■ Connecting a VCR.....	10
■ Connecting a Digital Audio System.....	11
■ Connecting an Amplifier/DVD Home Theater.....	11
■ Connecting a PC.....	11

## OPERATION

■ Turning the TV On and Off.....	12
■ Plug & Play Feature.....	12
■ Changing Channels.....	13
■ Adjusting the Volume.....	14
■ Viewing the Display.....	14
■ Viewing the Menus.....	15
■ Memorizing the Channels.....	15
■ Setting Up Your Remote Control.....	17
■ Remote Control Codes.....	19
■ To Select the Source.....	22
■ To Edit the Input Source Name.....	22

## PICTURE CONTROL

■ Using Automatic Picture Settings.....	23
■ Adjusting the Color Tone.....	24
■ Resetting the Picture Settings to the Factory Defaults.....	24
■ Adjusting the Detailed Settings.....	25
■ Changing the Screen Size.....	28
■ Setting the Active Color.....	29
■ DNle (Digital Natural Image engine).....	29
■ Setting the Auto Motion Plus 120Hz.....	29
■ Setting the HDMI Black Level.....	30
■ Setting the Film Mode.....	30
■ Viewing Picture-in-Picture.....	31
■ Freezing the Picture.....	32

## SOUND CONTROL

■ Customizing the Sound.....	33
■ Using Automatic Sound Settings.....	33
■ Setting the TruSurround XT.....	34
■ Choosing a Multi-Channel Sound (MTS) track - Digital.....	34
■ Choosing a Multi-Channel Sound (MTS) track - Analog.....	35
■ Automatic Volume Control.....	35
■ Selecting the Internal Mute.....	36
■ Adjusting the TV On/Off Melody Sound.....	36
■ Listening to the Sound of the Sub (PIP) Picture.....	37
■ Resetting the Sound Settings to the Factory Defaults.....	37
■ Connecting Headphones.....	37



Symbol



Press



Important



Note

One-Touch  
Button

## CHANNEL CONTROL

■ Selecting the Antenna.....	38
■ Clearing Scrambled Channels - Digital.....	38
■ Adding and Erasing Channels.....	39
■ To Set-Up Your Favorite Channels.....	40
■ Using the Channel Lists.....	41
■ Viewing the Channel Lists.....	41
■ Labeling Channels.....	42
■ LNA (Low Noise Amplifier).....	42
■ Fine Tuning Analog Channels.....	43
■ Checking the Digital-Signal Strength.....	43

## PC DISPLAY

■ Using Your TV as a Computer (PC) Display.....	44
■ Display Modes.....	44
■ Setting up the TV with your PC.....	45
■ Setting the Home Theater PC.....	46

## TIME SETTING

■ Setting the Clock.....	47
--------------------------	----

## FUNCTION DESCRIPTION

■ Selecting a Menu Language.....	50
■ Setting the Blue Screen Mode.....	51
■ Using the Game Mode.....	51
■ Viewing Closed Captions (On-Screen Text Messages) - Analog.....	52
■ Viewing Closed Captions (On-Screen Text Messages) - Digital.....	53
■ Menu Transparency Level.....	54
■ Using the Energy Saving Feature.....	54
■ Setting the Function Help.....	55
■ Digital Noise Reduction.....	55
■ Using the V-Chip.....	56
■ Setting the Light Effect.....	63
■ Upgrading the Software.....	63

## WISELINK

■ Using the WISELINK Function.....	64
■ Using the WISELINK Menu.....	65
■ Using the PHOTO (JPEG) List.....	66
■ Using the MP3 List.....	73
■ Using the Setup Menu.....	75

## ABOUT ANYNET<sup>+</sup>

■ What is Anynet <sup>+</sup> ?.....	77
■ Connecting Anynet <sup>+</sup> Devices.....	77
■ Setting Up Anynet <sup>+</sup> .....	78
■ Scanning and Switching between Anynet <sup>+</sup> Devices.....	78
■ Recording.....	79
■ Listening through a Receiver (Home theater).....	80
■ Troubleshooting for Anynet <sup>+</sup> .....	80

## APPENDIX

■ Troubleshooting.....	81
■ Installing the Stand.....	83
■ Disconnecting the Stand.....	83
■ Auto Wall-Mount Adjustment (Sold separately).....	84
■ Wall Mount Kit Specifications (VESA).....	85
■ Using the Anti-Theft Kensington Lock (depending on the model).....	86
■ Specifications.....	87
■ Dimensions.....	88

## General Information

### List of Features

- Adjustable picture settings that can be stored in the TV's memory.
- Automatic timer to turn the TV on and off.
- A special sleep timer.
- Excellent Digital Interface & Networking :  
With a built-in HD digital tuner, non-subscription HD broadcasts can be viewed with no Cable Box/Satellite receiver (Set-Top Box) needed.
- HDMI/DVI connection of your PC to this TV.
- Remote Control  
The supplied remote can be used to operate the TV as well as most DVD players, Cable Box/Satellite receiver (Set-Top Box) and VCRs.
- Excellent Picture Quality
  - DNIe technology provides life-like clear images.
- SRS TruSurround XT
  - SRS TruSurround XT provides a virtual Dolby surround system.

### Accessories

Please make sure the following items are included with your LCD TV.  
If any items are missing, contact your dealer.

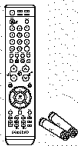

Remote Control & Batteries  
(AAA x 2)  
(BN59-00599A)

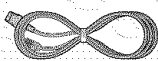

Power Cord  
(3903-000144)



Cleaning Cloth  
(BN63-01798A)



Ferrite Core  
LN-T4669F : 3301-001305

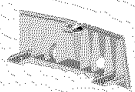

Cover-Bottom  
LN-T4069F : BN63-03911A  
LN-T4669F : BN63-03914A

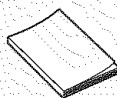

Owner's Instructions

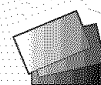

Warranty Card / Registration  
Card / Safety Guide Manual  
(Not available in all locations)

- The items color and shape may vary depending on the model.
- **Ferrite Core (Side Panel Jacks)**

The ferrite cores are used to shield the cables from interference.  
When connecting a cable, open the ferrite core and clip it around the cable near the plug.

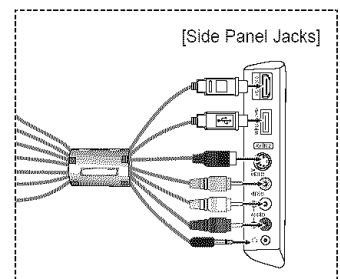

# Viewing the Control Panel

## Buttons on the Lower-Right Part of the Panel

The buttons on the lower-right panel control your TV's basic features, including the on-screen menu. To use the more advanced features, you must use the remote control.

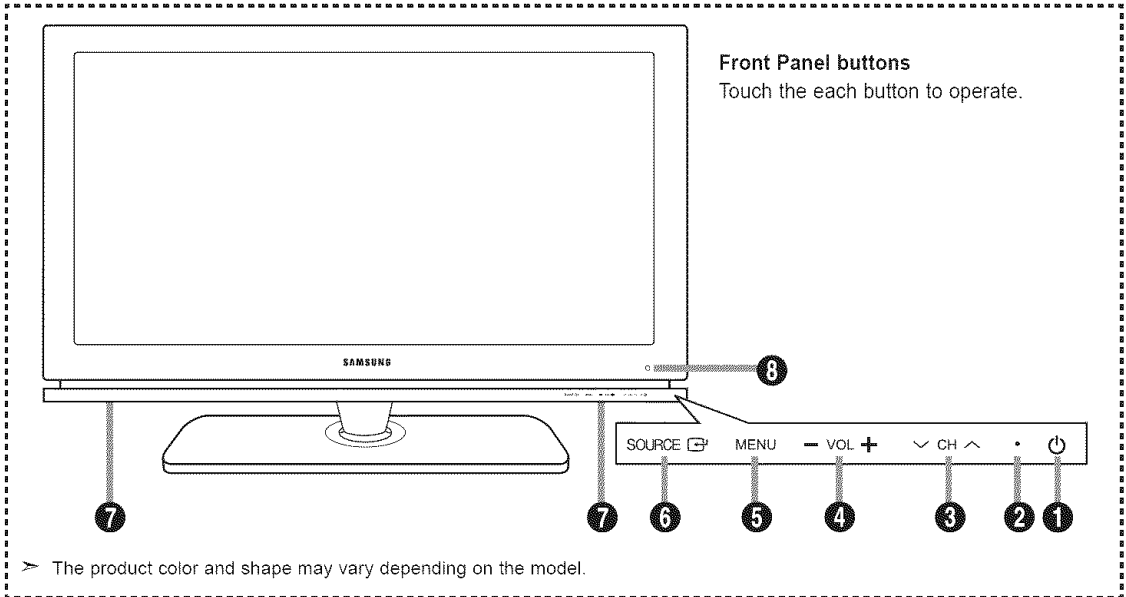

### 1 (POWER)





Press to turn the TV on and off.

### 2 POWER INDICATOR

Blinks and turns off when the power is on and lights up in stand-by mode.



### 3 CH

Press to change channels.

In the on-screen menu, use the  CH  buttons as you would use the  and  buttons on the remote control.

### 4 - VOL +

Press to increase or decrease the volume.

In the on-screen menu, use the - VOL + buttons as you would use the  and  buttons on the remote control.

### 5 MENU

Press to see an on-screen menu of your TV's features.

### 6 SOURCE

Toggles between all the available input sources (TV, AV1, AV2, S-Video1, S-Video2, Component1, Component2, PC, HDMI1, HDMI2, HDMI3).

In the on-screen menu, use this button as you would use the **ENTER** button on the remote control.

### 7 SPEAKERS

### 8 REMOTE CONTROL SENSOR

Aim the remote control towards this spot on the TV.

# Viewing the Connection Panel

## Rear Panel Jacks

Use the rear panel jacks to connect A/V components that will be connected continuously, such as VCR or DVD players. For more information on connecting equipment, see pages 6-11.

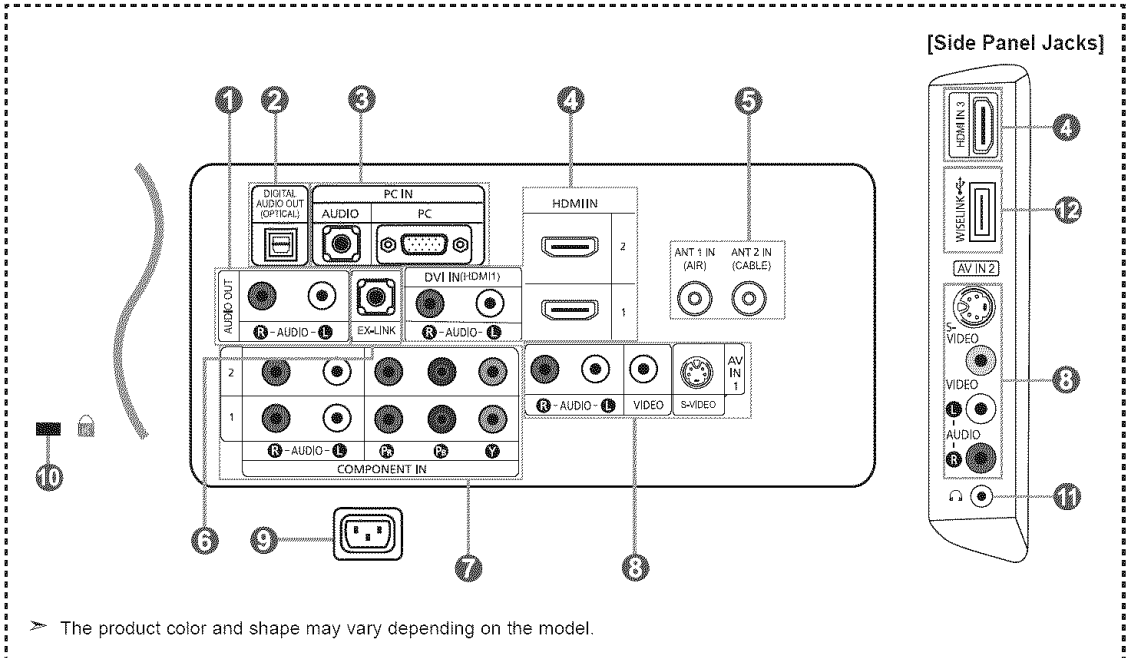

> The product color and shape may vary depending on the model.

- 1 AUDIO OUT**  
Connects to the audio input jacks on your Amplifier/ Home theater.
- 2 DIGITAL AUDIO OUT (OPTICAL)**  
Connects to a Digital Audio component.
- 3 PC IN**  
Connects to the video and audio output jacks on your PC.
- 4 HDMI IN 1,2,3 / DVI IN(HDMI1) (AUDIO R/L)**  
Connects to the HDMI jack of a device with an HDMI output. Use the HDMI IN 1 jack for DVI connection to an external device.  
Use a DVI to HDMI cable or DVI-HDMI adapter (DVI to HDMI) for video connection and the DVI IN (HDMI1) 'R-AUDIO-L' jacks for audio.  
- No sound connection is needed for an HDMI to HDMI connection.  
- When using an HDMI/DVI cable connection, you must use the HDMI IN 1 jack.
- 5 ANT 1 IN / ANT 2 IN**  
Connects to an antenna or cable TV system.
- 6 EX-LINK**  
Connect this to the jack on the optional wall mount bracket. This will allow you to adjust the TV viewing angle using your remote control.
- 7 COMPONENT IN 1,2**  
Connects Component video/audio.
- 8 AV IN 1 / AV IN 2**  
Video and audio inputs for external devices, such as a camcorder or VCR.  
**S-VIDEO**  
Connects an S-Video signal from a camcorder or VCR.
- 9 POWER INPUT**  
Connects the supplied power cord
- 10 KENSINGTON LOCK (depending on the model)**  
The Kensington lock (optional) is a device used to physically fix the system when used in a public place. If you want to use a locking device, contact the dealer where you purchased the TV.  
> The location of the Kensington Lock may be different depending on your TV.
- 11 HEADPHONE**  
Connects a set of external headphones for private listening.
- 12 WISELINK**  
Connect a USB mass storage device to view photo files (JPEG) and play audio files (MP3).

## Remote Control

You can use the remote control up to a distance of about 23 feet from the TV. When using the remote, always point it directly at the TV. You can also use your remote control to operate your VCR, Cable box, DVD player or Cable Box/Satellite receiver (Set-Top Box)

- 1 POWER**  
Turns the TV on and off.
- 2 NUMERIC BUTTONS**  
Press to change the channel.
- 3 -**  
Press to select additional channels(digital and analog) being broadcast by the same station. For example, to select channel "54-3", press "54", then press "-" and "3".
- 4 CH LIST**  
Used to display Channel Lists on the screen.
- 5 ANTENNA**  
Press to select "AIR" or "CABLE".
- 6 VCR/DVD Functions**  
- Rewind  
- Stop  
- Play/Pause  
- Fast/Forward
- 7 VOL  $\ominus$  / VOL  $\oplus$**   
Press to increase or decrease the volume.
- 8  $\times$  (MUTE)**  
Press to temporarily cut off the sound.
- 9 MENU**  
Displays the main on-screen menu.
- 10 S.MODE**  
Press to select the sound mode.
- 11 RETURN**  
Returns to the previous menu.
- 12 P.MODE**  
Press to select the picture mode.
- 13 CAPTION**  
Controls the caption decoder.
- 14 FAV.CH**  
Press to switch to your favorite channels.
- 15 SLEEP**  
Press to select a preset time interval for automatic Shut off.
- 16 SRS**  
Selects SRS TruSurround XT mode.
- 17 SET**  
Sets the remote to control your TV, VCR, Cable, DVD or Set-Top Box
- 18 TV, DVD, STB, CABLE, VCR**  
Press to operate your TV,DVD, STB, CABLE (box) or VCR (See pages 17-21)
- 19** When pressing this button, a number of buttons on the remote control (e.g. TV, DVD, STB, CABLE, VCR, VOL and CH buttons) light up for a few seconds and then turn off to save power. This function is convenient for using the remote at night or when dark.
- 20 SOURCE**  
Press to display all of the available video sources.
- 21 PRE-CH**  
Tunes to the previous channel.
- 22 WISELINK**  
This function enables you to view and play photo (JPEG) and audio files (MP3) from an external device. (Refer to pages 66 (JPEG) and 73 (MP3))
- 23 REC**  
This remote can be used to control recording on Samsung DVD recorders with the Anynet+ feature. (Refer to page 79)
- 24 CH  $\odot$  / CH  $\ominus$**   
Press to change channels.
- 25 EXIT**  
Press to exit the menu.
- 26 UP  $\blacktriangle$  / DOWN  $\blacktriangledown$  / LEFT  $\blacktriangleleft$  / RIGHT  $\blacktriangleright$  / ENTER  $\blacksquare$**   
Use to select on-screen menu items and change menu values.
- 27 INFO**  
Press to display information on the TV screen.
- 28 Anynet+**  
Runs the Anynet+ functions and sets up Anynet+ devices.
- 29 STILL**  
Press to stop the action during a particular scene. Press again to resume normal video.
- 30 P.SIZE**  
Picture size selection.
- 31 PIP**  
Picture-in Picture ON/OFF.
- 32 CH  $\wedge$  /  $\vee$**   
Displays the available channels in sequence. (These buttons change channels in the PIP window only.)
- 33 MTS**  
Press to choose stereo, mono or Separate Audio Program (SAP broadcast).
- 34 RESET**  
When your remote does not work, change the batteries and press the RESET button for 2-3 seconds before use.

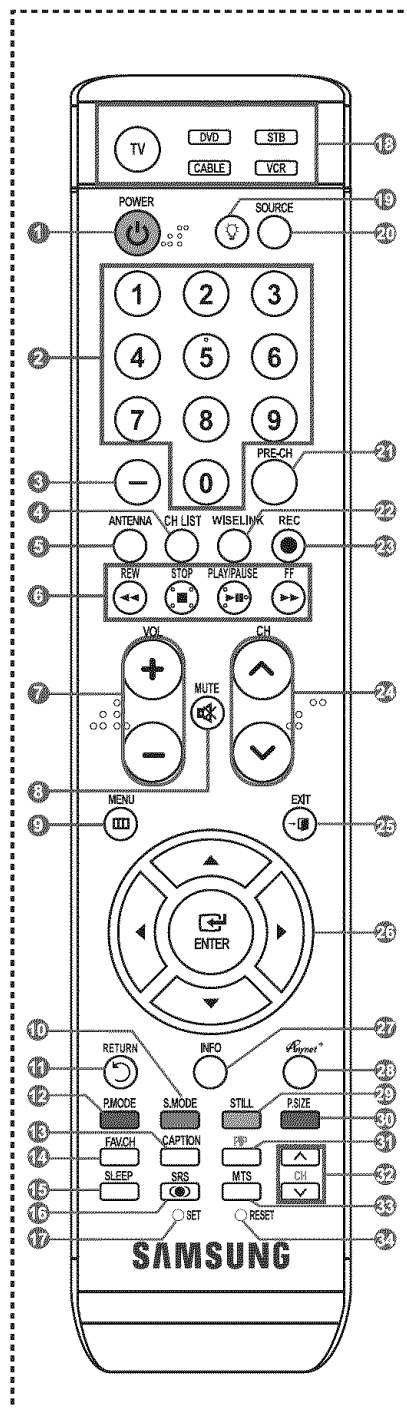

- This is a special remote control for the visually impaired and has Braille points on the POWER, CH, VOL, STOP and PLAY/PAUSE buttons.
- The performance of the remote control may be affected by bright light.

## Installing Batteries in the Remote Control

1. Lift the cover at the back of the remote control upward as shown in the figure.
2. Install two AAA size batteries.
  - Make sure to match the "+" and "-" ends of the batteries with the diagram inside the compartment.
3. Replace the cover.
  - Remove the batteries and store them in a cool, dry place if you won't be using the remote control for a long time.

The remote control can be used up to about 23 feet from the TV.

(Assuming typical TV usage, the batteries should last for about one year.)

➤ **If the remote control doesn't work, check the following:**

1. Is the TV power on?
2. Are the plus and minus ends of the batteries reversed?
3. Are the batteries drained?
4. Is there a power outage or is the power cord unplugged?
5. Is there a special fluorescent light or neon sign nearby?

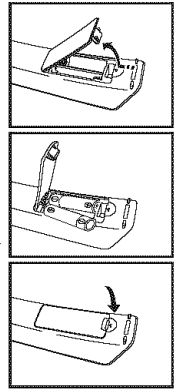

## Connections

### Connecting VHF and UHF Antennas

If your antenna has a set of leads that look like the diagram to the right, see "Antennas with 300 Ω Flat Twin Leads" below.

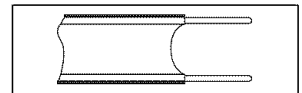

If your antenna has one lead that looks like the diagram to the right, see "Antennas with 75 Ω Round Leads".

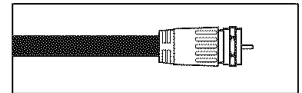

If you have two antennas, see "Separate VHF and UHF Antennas".

#### Antennas with 300 Ω Flat Twin Leads

If you are using an off-air antenna (such as a roof antenna or "rabbit ears") that has 300 Ω twin flat leads, follow the directions below.

1. Place the wires from the twin leads under the screws on a 300-75 Ω adapter (not supplied).  
Use a screwdriver to tighten the screws.

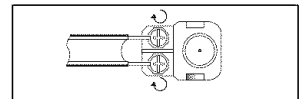

2. Plug the adaptor into the ANT 1 IN (AIR) terminal on the back of the TV.

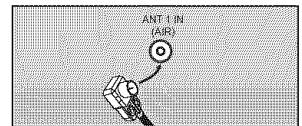

#### Antennas with 75 Ω Round Leads

1. Plug the antenna lead into the ANT 1 IN (AIR) terminal on the back of the TV.

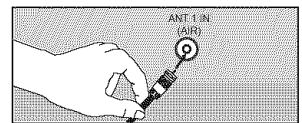

#### Separate VHF and UHF Antennas

If you have two separate antennas for your TV (one VHF and one UHF), you must combine the two antenna signals before connecting the antennas to the TV. This procedure requires an optional combiner-adaptor (available at most electronics shops).

1. Connect both antenna leads to the combiner.
2. Plug the combiner into the ANT 1 IN (AIR) terminal on the bottom of the rear panel.

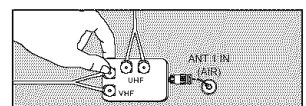
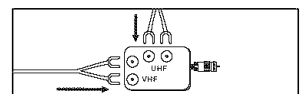



# Connecting Cable TV

To connect to a cable TV system, follow the instructions below.

## Cable without a Cable Box

1. Plug the incoming cable into the ANT 2 IN (CABLE) terminal on the back of the TV.
  - Because this TV is cable-ready, you do not need a cable box to view unscrambled cable channels.

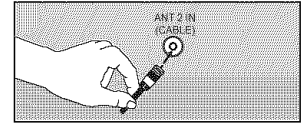

## Connecting to a Cable Box that Descrambles All Channels

1. Find the cable that is connected to the ANT OUT terminal on your cable box.
  - This terminal might be labeled "ANT OUT", "VHF OUT" or simply, "OUT".
2. Connect the other end of this cable to the ANT 2 IN (CABLE) terminal on the back of the TV.

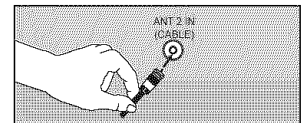
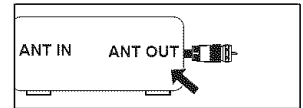

## Connecting to a Cable Box that Descrambles Some Channels

If your cable box descrambles only some channels (such as premium channels), follow the instructions below. You will need a two-way splitter, an RF (A/B) switch and four lengths of RF cable. (These items are available at most electronics stores.)

1. Find and disconnect the cable that is connected to the ANT IN terminal on your cable box.
  - This terminal might be labeled "ANT IN", "VHF IN" or simply, "IN".
2. Connect this cable to a two-way splitter.
3. Connect an RF cable between the OUTPUT terminal on the splitter and the IN terminal on the cable box.
4. Connect an RF cable between the ANT OUT terminal on the cable box and the B-IN terminal on the RF(A/B) switch.
5. Connect another cable between the other OUT terminal on the splitter and the A-IN terminal on the RF (A/B) switch.
6. Connect the last RF cable between the OUT terminal on the RF (A/B) switch and the ANT 2 IN (CABLE) terminal on the rear of the TV.

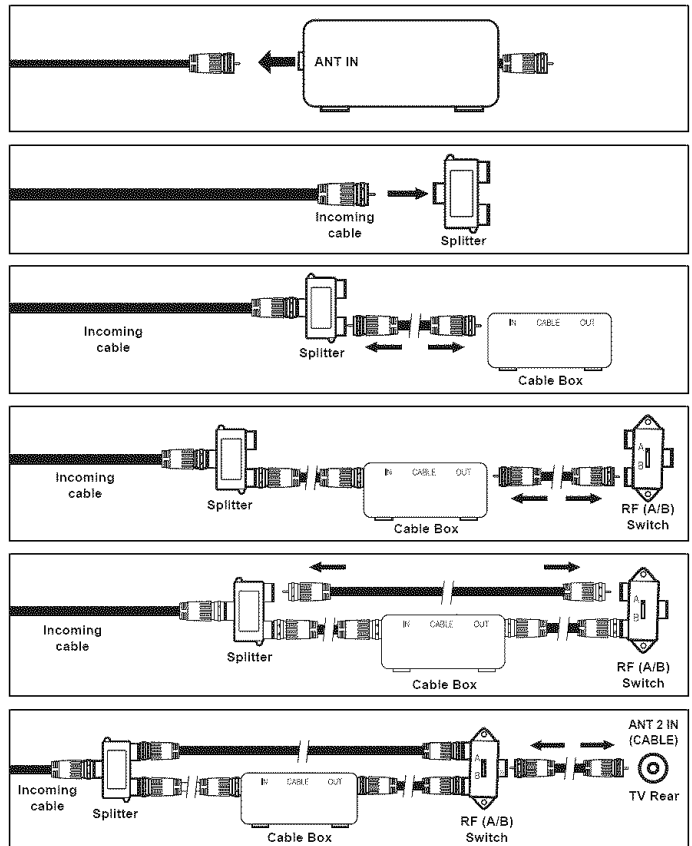

After you have made this connection, set the A/B switch to the "A" position for normal viewing. Set the A/B switch to the "B" position to view scrambled channels. (When you set the A/B switch to "B", you will need to tune your TV to the cable box's output channel, which is usually channel 3 or 4.)

## Connecting a DVD Player or Cable Box/Satellite receiver (Set-Top Box) via HDMI

This connection can only be made if there is an HDMI Output connector on the external device.

1. Connect an HDMI Cable between the HDMI IN (1,2 or 3) jack on the TV and the HDMI jack on the DVD Player or Cable Box/Satellite receiver (Set-Top Box)

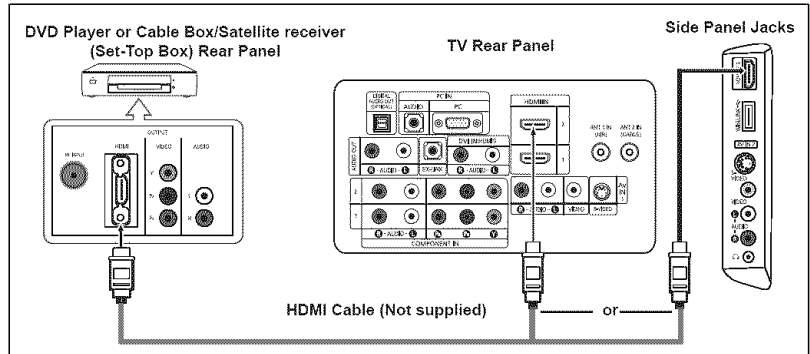

### ➤ What is HDMI?

- HDMI (High-Definition Multimedia Interface), is an interface that enables the transmission of digital audio and video signals using a single cable.
  - The difference between HDMI and DVI is that the HDMI device is smaller in size and has the HDCP (High Bandwidth Digital Copy Protection) coding feature installed
- Each DVD Player or Cable Box/Satellite receiver (Set-Top Box) has a different back panel configuration.
- The TV may not output sound and pictures may be displayed with abnormal color when DVD players/Cable Boxes/Satellite receivers supporting HDMI versions older than 1.3 are connected. When connecting an older HDMI cable and there is no sound, connect the HDMI cable to the HDMI IN 1 jack and the audio cables to the DVI IN (HDMI1) [R-AUDIO-L] jacks on the back of the TV. If this happens, contact the company that provided the DVD player/Cable Box/Satellite receiver to confirm the HDMI version, then request an upgrade.
- HDMI cables that are not 1.3 may cause annoying flicker or no screen display.

## Connecting a DVD Player or Cable Box/Satellite receiver (Set-Top Box) via DVI

This connection can only be made if there is a DVI Output connector on the external device.

1. Connect a DVI to HDMI Cable or DVI-HDMI Adapter between the HDMI IN 1 jack on the TV and the DVI jack on the DVD Player or Cable Box/Satellite receiver (Set-Top Box)
2. Connect Audio Cables between the DVI IN (HDMI 1) [R-AUDIO-L] jack on the TV and the DVD Player or Cable Box/Satellite receiver (Set-Top Box)

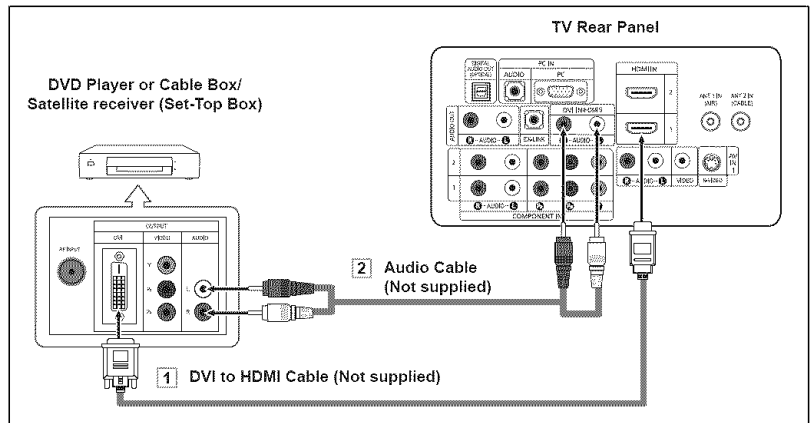

- Each DVD Player or Cable Box/Satellite receiver (Set-Top Box) has a different back panel configuration.
- When connecting a DVD Player or Cable Box/Satellite receiver (Set-Top Box), match the color of the connection terminal to the cable.
- When using an HDMI/DVI cable connection, you must use the HDMI IN1 jack.

## Connecting a DVD Player or Cable Box/Satellite receiver (Set-Top Box) via Component cables

The rear panel jacks on your TV make it easy to connect a DVD Player or Cable Box/Satellite receiver (Set-Top Box) to your TV.

1. Connect a Component Cable between the COMPONENT IN (1 or 2) [Y, P<sub>B</sub>, P<sub>R</sub>] jacks on the TV and the COMPONENT [Y, P<sub>B</sub>, P<sub>R</sub>] jacks on the DVD Player or Cable Box/Satellite receiver (Set-Top Box).
2. Connect Audio Cables between the COMPONENT IN(1 or 2) [R-AUDIO-L] jacks on the TV and the AUDIO OUT jacks on the DVD Player or Cable Box/Satellite receiver (Set-Top Box).

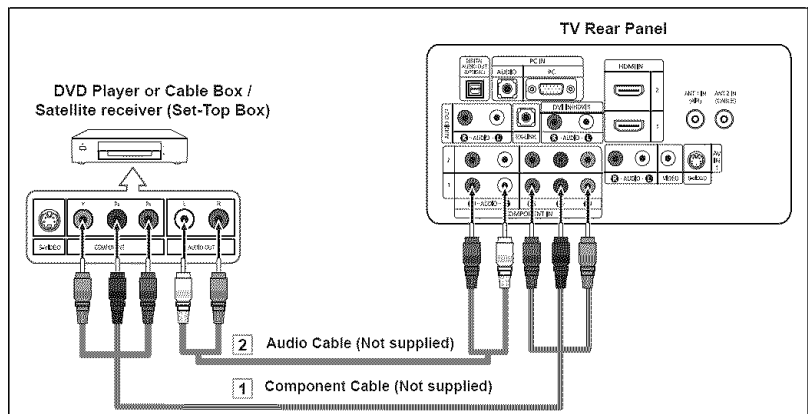

- Component video separates the video into Y (Luminance (brightness), Pb (Blue) and Pr (Red) for enhanced video quality. Be sure to match the component video and audio connections. For example, if connecting the video cable to COMPONENT IN, connect the audio cable to COMPONENT IN also.
- Each DVD Player or Cable Box/Satellite receiver (Set-Top Box) has a different back panel configuration.
- When connecting a DVD Player or Cable Box/Satellite receiver (Set-Top Box), match the color of the connection terminal to the cable.

## Connecting a Camcorder

The side panel jacks on your TV make it easy to connect a camcorder to your TV. They allow you to view the camcorder tapes without using a VCR

1. Connect a Video Cable (or S-Video Cable) between the AV IN2 [VIDEO] (or S-VIDEO) jack on the TV and the VIDEO OUT jack on the camcorder.
2. Connect Audio Cables between the AV IN2 [R-AUDIO-L] jacks on the TV and the AUDIO OUT jacks on the camcorder.

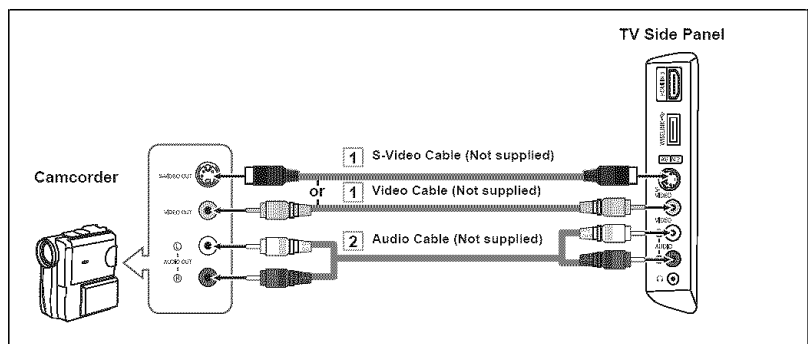

- Each Camcorder has a different back panel configuration.
- When connecting a Camcorder, match the color of the connection terminal to the cable.

# Connecting a VCR

## Video Connection

These instructions assume that you have already connected your TV to an antenna or a cable TV system (according to the instructions on pages 6-7). Skip step 1 if you have not yet connected to an antenna or a cable system.

1. Unplug the cable or antenna from the back of the TV.
2. Connect the cable or antenna to the ANT IN terminal on the back of the VCR.
3. Connect an RF Cable between the ANT OUT terminal on the VCR and the ANT 1 IN (AIR) or ANT 2 IN (CABLE) terminal on the TV.
4. Connect a Video Cable between the VIDEO OUT jack on the VCR and the AV IN 1 (or AV IN 2) [VIDEO] jack on the TV.
5. Connect Audio Cables between the AUDIO OUT jacks on the VCR and the AV IN 1 (or AV IN 2) [R-AUDIO-L] jacks on the TV.

> If you have a "mono" (non-stereo) VCR, use a Y-connector (not supplied) to hook up to the right and left audio input jacks of the TV. If your VCR is stereo, you must connect two cables.

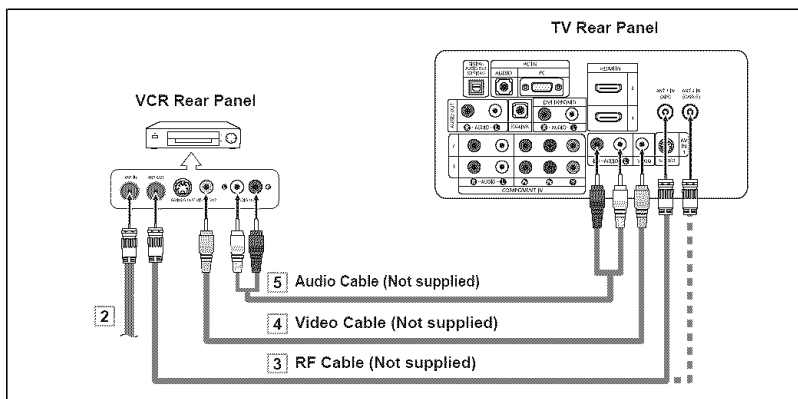
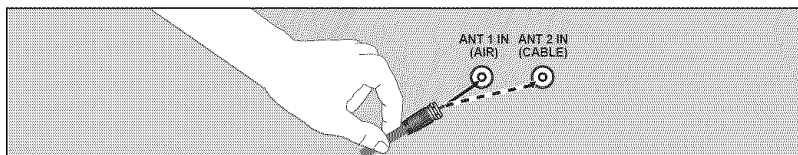

Follow the instructions in "Viewing a VCR or Camcorder Tape" to view your VCR tape.

- > Each VCR has a different back panel configuration.
- > When connecting a VCR, match the color of the connection terminal to the cable.

## S-Video Connection

Your Samsung TV can be connected to an S-Video jack of a VCR. (This connection delivers a better picture when compared to the regular Video connection above.)

1. To begin, follow steps 1–3 in the previous section to connect the antenna or cable to your VCR and your TV.
2. Connect an S-Video Cable between the S-VIDEO OUT jack on the VCR and the AV IN1 [S-VIDEO] jack on the TV.
3. Connect Audio Cables between the AUDIO OUT jacks on the VCR and the AV IN1 [R-AUDIO-L] jacks on the TV.

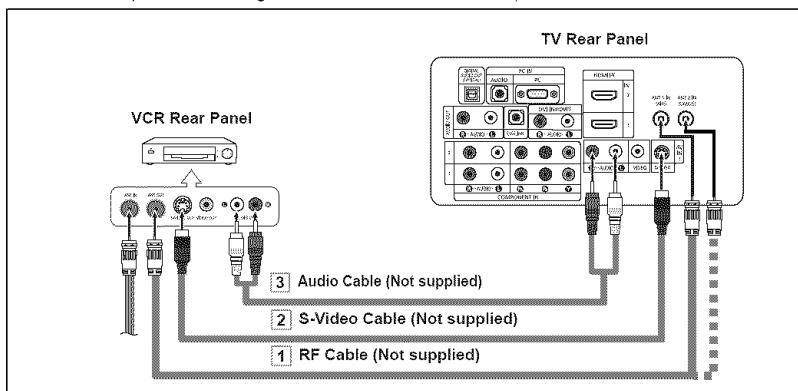

An S-Video cable may be included with a VCR. (If not, check your local electronics store.)

- > Each VCR has a different back panel configuration.
- > When connecting a VCR, match the color of the connection terminal to the cable.

## Connecting a Digital Audio System

The rear panel jacks on your TV make it easy to connect a Digital Audio System to your TV.

1. Connect an Optical Cable between the "DIGITAL AUDIO OUT (OPTICAL)" jacks on the TV and the Digital Audio Input jacks on the Digital Audio System.

When a Digital Audio System is connected to the "DIGITAL AUDIO OUT (OPTICAL)" jack:  
Decrease the volume of the TV and adjust the volume level with the system's volume control.

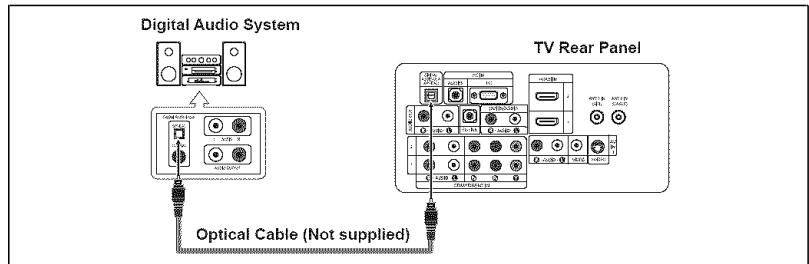

- 5.1CH audio is possible when the TV is connected to an antenna.
- Each Digital Audio System has a different back panel configuration.
- If you have an external device (DVD, Cable/Set top box) connected via HDMI to the TV, audio is not output from the Optical jack.
- When the COMPONENT IN or HDMI IN jacks are connected, the Optical jack on the TV outputs 2 channel audio only. If you want to hear 5.1 channel audio, connect the DIGITAL AUDIO OUT (OPTICAL) jack on the DVD player or Cable/Satellite Box directly to an Amplifier or Home Theater, not the TV.

## Connecting an Amplifier/DVD Home Theater

1. Connect Audio Cables between the AUDIO OUT [R-AUDIO-L] jacks on the TV and AUDIO IN [R-AUDIO-L] jacks on the Amplifier/DVD Home Theater.

When an audio amplifier is connected to the "AUDIO OUT [R-AUDIO-L]" jack: Decrease the volume of the TV and adjust the volume level with the Amplifier's volume control.

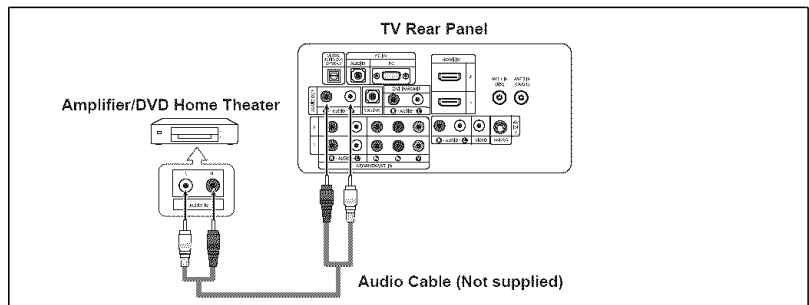

- Each Amplifier/DVD Home Theater has a different back panel configuration.
- When connecting an Amplifier/DVD Home Theater, match the color of the connection terminal to the cable.

## Connecting a PC

### Using the D-Sub Cable

1. Connect a D-Sub Cable between PC IN [PC] connector on the TV and the PC output connector on your computer.
2. Connect a PC Audio Cable between the PC IN [AUDIO] jack on the TV and the Audio Out jack of the sound card on your computer.

### Using the HDMI/DVI Cable

1. Connect a HDMI/DVI cable between the HDMI IN 1 jack on the TV and the PC output jack on your computer.
2. Connect a 3.5 mm Stereo mini-plug/2RCA Cable between the DVI IN (HDMI1) [R-AUDIO-L] jack on the TV and the Audio Out jack of the sound card on your computer.

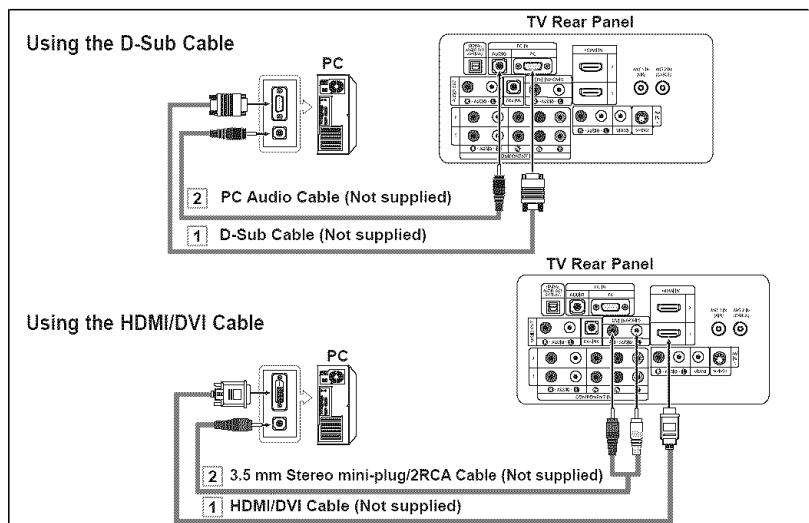

- Each PC has a different back panel configuration.
- When connecting a PC, match the color of the connection terminal to the cable.
- When using an HDMI/DVI cable connection, you must use the HDMI IN1 terminal.

## Operation

### Turning the TV On and Off

Press the **POWER**  button on the remote control.

You can also use the **POWER**  button on the TV.



### Plug & Play Feature

When the TV is initially powered on, basic settings proceed automatically and subsequently:

1. Press the **POWER** button on the remote control.  
The message "Menu language, Shop Mode, Channels and Time will be set." is displayed.  
Press the **ENTER** button, then "Select the language of the OSD" menu is automatically displayed.
2. Press the **▲** or **▼** button to select language, then press the **ENTER** button.  
The message "Select Home Mode when installing this TV at home." is displayed.
3. Press the **◀** or **▶** button to select "Shop" or "Home", then press the **ENTER** button.  
The message "Select the antennas to memorize." is displayed.
  - > We recommend setting the TV to Home mode for the best picture in your home environment.
  - > Shop mode is only intended for use in retail environments.
  - > If the unit is accidentally set to Shop mode and you want to return to Dynamic (Home) mode, press any Volume button and then hold down the **MENU** button for five seconds on the side panel of the TV.
4. Press the **▲** or **▼** button to memorize the channels of the selected connection. Press the **ENTER** button to select "Start".
  - > If the antenna is connected to ANT 1(AIR), select "Air" and if it is connected to ANT 2 (CABLE), select "Cable".
  - > If both ANT 1 (AIR) and ANT 2 (CABLE) are connected, select the "Air + Cable".
  - > In Cable mode, you can select the correct signal source among STD, HRC, and IRC by pressing the **▲** or **▼** button, then press the **ENTER** button. Contact your local cable company to identify the type of cable system that exists in your particular area.
5. The TV will begin memorizing all of the available channels.  
After all the available channels are stored, the Auto program menu reappears. Press the **ENTER** button when channel memorization is complete.  
The message "Select the clock mode." is displayed.
  - > To stop the search before it has finished, press the **ENTER** button with stop selected.
6. Press the **ENTER** button.  
Press the **▲** or **▼** button to select "Auto", then Press the **ENTER** button.  
The message "Set to daylight savings time." is displayed.  
If you select "Manual", "Set current date and time." is displayed. (See page 47)

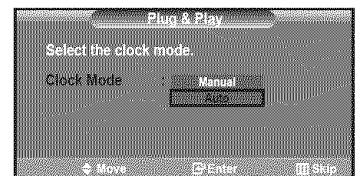
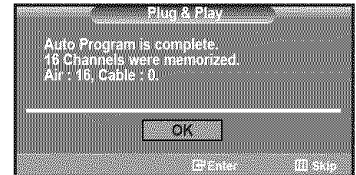
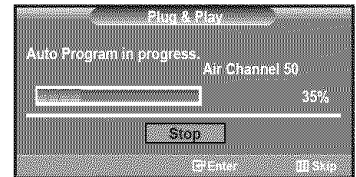
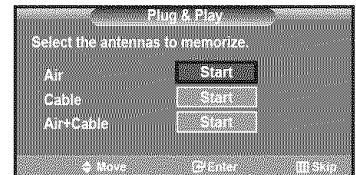
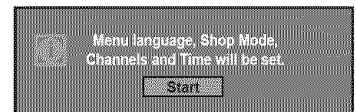

- Press the ▲ or ▼ button to select "On" or "Off", then press the **ENTER** button. The message "Select the time zone in which you live." is displayed.



- Press the ▲ or ▼ button to highlight the time zone for your local area. Press the **ENTER** button. If you have received a digital signal, the time will be set automatically. If not, see page 48 to set the clock.

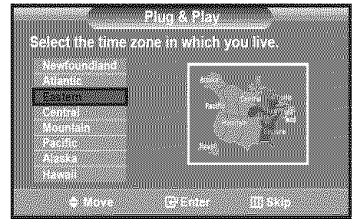

- The message "Enjoy your watching." is displayed. When you have finished, press the **ENTER** button.



*If you want to reset this feature...*

- Press the **MENU** button to display the menu. Press the ▲ or ▼ button to select "Setup", then press the **ENTER** button.
- Press the **ENTER** button again, to select "Plug & Play".
- The message "Menu language, Shop Mode, Channels and Time will be set." is displayed.

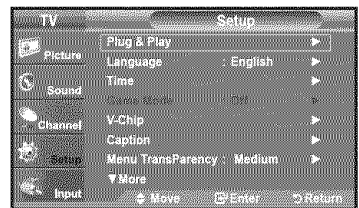

## Changing Channels

### Using the Channel Buttons

- Press the CH+ or CH- button to change channels.
  - When you press the CH+ or CH- button, the TV changes channels in sequence.
  - You will see all the channels that the TV has memorized. (The TV must have memorized at least three channels). You will not see channels that were either erased or not memorized. See page 16 to memorize channels.

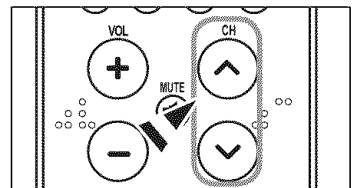

### Using the Number Buttons

- Press the number buttons to go directly to a channel. For example, to select channel 27, press 2, then 7. The TV will change channels when you press the second number.

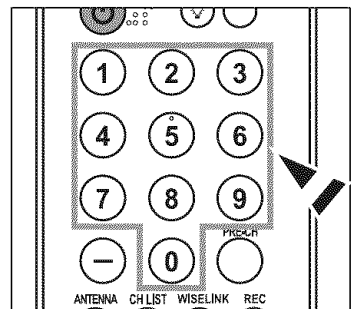

### Using the "-" Button

The "-" button is used to select stations that broadcast a digital signal.

- For example, for Channel 7-1, press 7, then -, then 1.
  - HD indicates the TV is receiving a Digital High Definition signal. SD indicates the TV is receiving a Standard Definition signal.
  - For quick channel change, press the number buttons, then press the **ENTER** button.

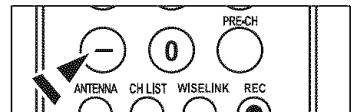

## Using the PRE-CH Button to select the Previous Channel

1. Press the **PRE-CH** button.  
The TV will switch to the last channel viewed.
  - > To quickly switch between two channels that are far apart, tune to one channel, then use the number button to select the second channel. Then use the **PRE-CH** button to quickly alternate between them.

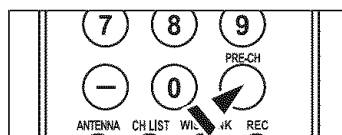

## Adjusting the Volume

### Using the Volume Buttons

1. Press the **VOL** or **VOL** button to decrease or increase the volume.

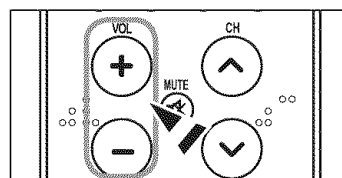

### Using the MUTE button

At any time, you can cut off the sound using the **MUTE** button.

1. Press **MUTE** button and the sound cuts off.  
The word "**MUTE**" will appear in the lower-left corner of the screen.
2. To turn mute off, press the **MUTE** button again or simply press the **VOL** or **VOL** button.

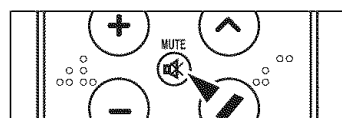

## Viewing the Display

The display identifies the current channel and the status of certain audio-video settings.

1. Press the **INFO** button on the remote control.  
The TV will display the channel, the type of sound, and the status of certain picture and sound settings.

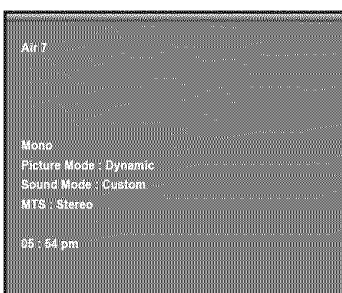

2. Press the **INFO** button once more or wait approximately 10 seconds and the display disappears automatically.

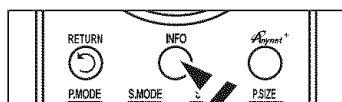



## Viewing the Menu

1. With the power on, press the **MENU** button.  
The main menu appears on the screen. The menu's left side has five icons: Picture, Sound, Channel, Setup, Input.
  2. Use the **▲** or **▼** button to select one of the five icons.  
Then press the **ENTER** button to access the icon's sub-menu.
  3. Press the **EXIT** button to exit.
- The on-screen menu disappears from the screen after about one minute.

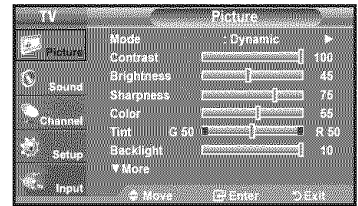

## Memorizing the Channels

Your TV can memorize and store all of the available channels for both "off-air" (Air) and "Cable" channels. After the available channels are memorized, use the **CH** or **CH** button to scan through the channels. This eliminates the need to change channels by entering the channels digits. There are three steps for memorizing channels: selecting a broadcast source, memorizing the channels (automatic) and adding or deleting channels (Channel Lists).

### Selecting the Video Signal-source

Before your television can begin memorizing the available channels, you must specify the type of signal source that is connected to the TV (i.e. an Air or a Cable system).

1. Press the **MENU** button to display the menu.  
Press the **▲** or **▼** button to select "Channel", then press the **ENTER** button.
2. Press the **ENTER** button select "Antenna".  
Press the **▲** or **▼** button to select "Air" or "Cable", then press the **ENTER** button.  
Press the **EXIT** button to exit.

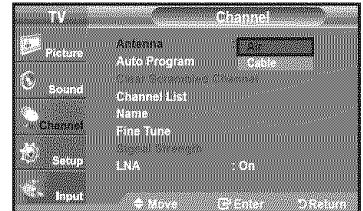
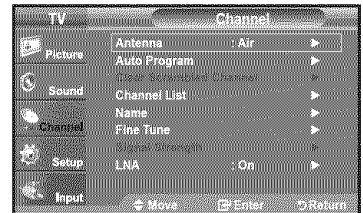

### Storing Channels in Memory (Automatic Method)

1. Press the **MENU** button to display the menu.  
Press the **▲** or **▼** button to select "Channel", then press the **ENTER** button.
2. Press the **▲** or **▼** button to select "Auto Program", then press the **ENTER** button.
3. Press the **▲** or **▼** button to select the antenna connection, then press the **ENTER** button.
  - > Air: "Air" antenna signal.
  - Cable: "Cable" antenna signal.
  - Air+Cable: "Air" and "Cable" antenna signals.
4. When selecting the Cable TV system : Press the **ENTER** button to start the auto program. By default, the cable TV system is set to "STD". If you want to select another type of cable system, press the **▲** or **▼** button to select "STD", "HRC" or "IRC".
  - > STD, HRC and IRC identify various types of cable TV systems. Contact your local cable company to identify the type of cable system that exists in your particular area. At this point the signal source has been selected.Press the **ENTER** button to start the auto program.
  - > To stop the search before it has finished, press the **ENTER** button with "Stop" selected.
5. After all the available channels are stored, the "Auto Program" menu reappears. Press the **EXIT** button to exit.

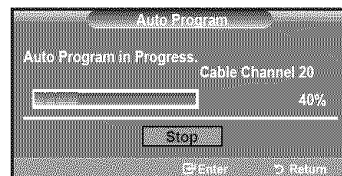
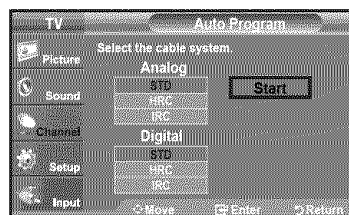
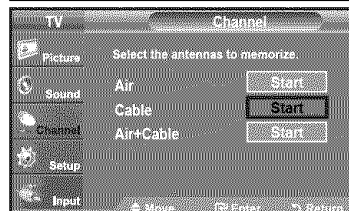
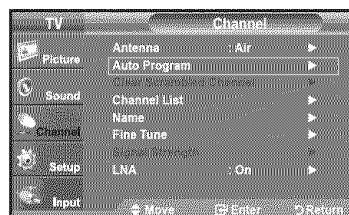

## Setting Up Your Remote Control

After the television has been set up properly, your remote control can operate in five different modes: TV, DVD, Cable, Set-Top Box, VCR. Pressing the corresponding button on the remote control allows you to switch between these modes and control whichever piece of equipment you choose.

- > The remote control might not be compatible with all DVD Players, VCRs, Cable boxes and Set-Top Boxes.

### Setting Up the Remote to Operate Your VCR

1. Turn off your VCR.
2. Press the **VCR** button on your TV's remote control.
3. Press the **SET** button on your TV's remote control.
4. Using the number buttons on your remote control, enter three digits of the VCR code listed on page 19 of this manual for your brand of VCR. Make sure you enter three digits of the code, even if the first digit is a "0".  
(If more than one code is listed, try the first one.)
5. Press the **POWER** button on the remote control.  
Your VCR should turn on if your remote is set up correctly.

If your VCR does not turn on after set up, repeat steps 2, 3 and 4, but try one of the other codes listed for your brand of VCR.  
If no other codes are listed, try each VCR code, 000 through 080.

- > **Note on Using Remote Control Modes: VCR**  
When your remote control is in "VCR" mode, the volume buttons still control your TV's volume.

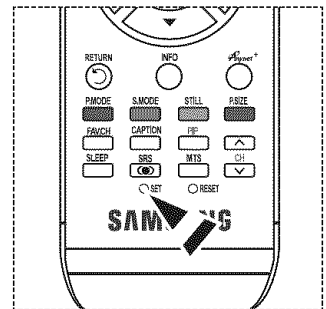
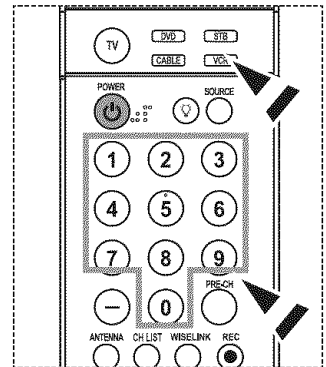

### Setting Up the Remote to Operate Your Cable Box

1. Turn off your cable box.
2. Press the **CABLE** button on your TV's remote control.
3. Press the **SET** button on your TV's remote control.
4. Using the number buttons on your remote control, enter three digits of the cable box code listed on page 20 of this manual for your brand of cable box. Make sure you enter three digits of the code, even if the first digit is a "0". (If there is more than one code listed, try the first one.)
5. Press the **POWER** button on the remote control.  
Your cable box should turn on if your remote is set up correctly.

If your cable box does not turn on after set up, repeat steps 2, 3 and 4, but try one of the other codes listed for your brand of cable box. If no other codes are listed, try each code, 000 through 046.

- > **Note on Using Remote Control Modes: Cable Box**  
When your remote control is in "CABLE" mode, the volume buttons still control your TV's volume.

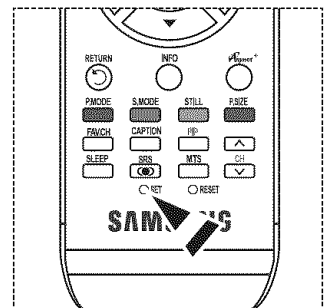
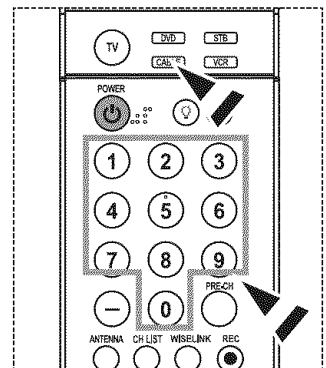

### Setting Up the Remote to Operate Your DVD

1. Turn off your DVD.
2. Press the **DVD** button on your TV's remote control.
3. Press the **SET** button on your TV's remote control.
4. Using the number buttons on your remote control, enter three digits of the DVD code listed on page 20~21 of this manual for your brand of DVD.  
Make sure you enter three digits of the code, even if the first digit is a "0".  
(If there is more than one code listed, try the first one.)
5. Press the **POWER** button on the remote control.  
Your DVD should turn on if your remote is set up correctly.

If your DVD does not turn on after set up, repeat steps 2, 3 and 4, but try one of the other codes listed for your brand of DVD.  
If no other codes are listed, try each code, 000 through 141.

#### > Note on Using Remote Control Modes: DVD

When your remote control is in "DVD" mode, the volume buttons still control your TV's volume.

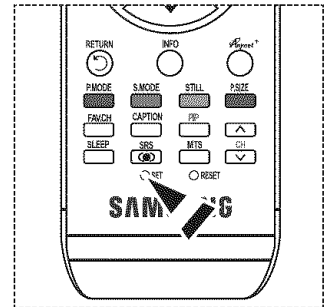
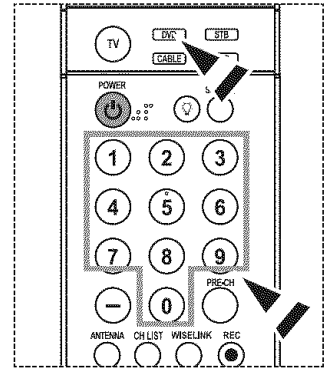

### Setting Up the Remote to Operate Your STB

1. Turn off your STB.
2. Press the **STB** button on your TV's remote control.
3. Press the **SET** button on your TV's remote control.
4. Using the number buttons on your remote control, enter three digits of the STB code listed on page 21 of this manual for your brand of STB.  
Make sure you enter three digits of the code, even if the first digit is a "0".  
(If there is more than one code listed, try the first one.)
5. Press the **POWER** button on the remote control.  
Your STB should turn on if your remote is set up correctly.

If your STB does not turn on after set-up, repeat steps 2, 3 and 4, but try one of the other codes listed for your brand of STB.  
(If no other codes are listed, try each code, 000 through 074.)

#### > Note on Using Remote Control Modes: STB

When your remote control is in "STB" mode, the volume buttons still control your TV's volume.

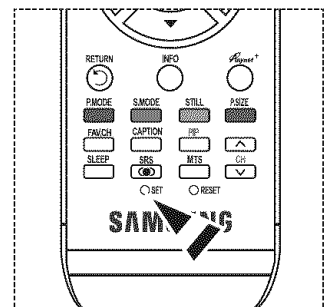
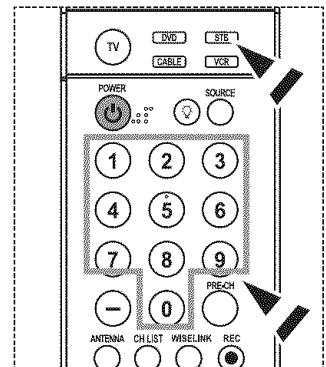

## Remote Control Codes

### > VCR

Brand	Code
SAMSUNG	000 001 002 003 004 005 077 078 079
ADMIRAL	020
AIWA	025
AKAI	004 027 032
AUDIO DYNAMICS	007 026
BELL&HOWELL	018
BROKSONIC	022
CANDLE	002 003 006 008 015 055
CANON	021 056
CITIZEN	002 003 006 008 015 055
COLORTYME	007
CRAIG	002 024
CURTIS MATHES	002 007 008 017 021 025 056 064 066
DAEWOO	003 010 011 012 013 014 015 016
DB	007 026
DIMENSIA	017
DYNATECH	025
ELECTROHOME	034
EMERSON	001 003 006 021 022 025 030 032 034 040 047 050 052 060 063 065 066 067 069 073
FISHER	018 024 028 029 048 051 061
FUNAI	025
GENERAL ELECTRIC	002 005 017 021 056
GO VIDEO	002
HARMAN KARDON	007
HITACHI	019 025 041 042 074
INSTANT REPLAY	021
JC PENNEY	002 007 018 019 021 026 037 041 054 056
JCL	007 008 018 021 026 037
JVC	081 082 083
KENWOOD	007 008 018 021 026 037
KLH	070
KONIA	036
LG(Goldstar)	006 007 008 009 010
LLOYD	025
LOGIK	038
LXI	025
MAGNAVOX	021 056 059
MARANTZ	007 008 018 021 026 037 062
MARTA	006
MEI	021
MEMOREX	006 021 024 025
MGA	034
MIDLAND	005
MINOLTA	019 041 075
MITSUBISHI	019 034 041 046

Brand	Code
MONTGOMERY WARD	020
MTC	002 025
MULTITECH	002 005 025 038
NEC	007 008 018 026 037 062 064
OPTIMUS	020
ORION	073 074 075 076
PANASONIC	021 056 071 072
PENTAX	019 041 075
PENTEX RESEARCH+	008
PHILCO	021 056 059
PHILIPS	021 080
PIONEER	019 026 039 053
PORTLAND	015 049 055
PROSCAN	017
QUARTZ	018
QUASAR	021 056
RADIO SHACK/ REALISTIC	006 018 020 021 024 025 029 034 048 056
RCA	002 017 019 021 035 041 043 057 068 076
SANSUI	026
SANYO	018 024
SCOTT	003 047 052 067
SEARS	006 018 019 024 028 029 041 048 051
SHARP	020 034 045 015
SHIMTOM	027 033 038 058
SIGNATURE	025
SONY	027 033 044
SYLVANIA	021 025 056 059
SYMPHONIC	025
TANDY	018 025
TASHIKA	006
TATUNG	037
TEAC	025 037 068
TECHNICS	021
TEKNIKA	006 021 025 031
TMK	066
TOSHIBA	003 019 029 051 052
TOTEVISION	002 006
UNITECH	002
VECTOR RESEARCH	007 026
VICTOR	026
VIDEO CONCEPTS	007 026
VIDEOSONIC	002
WARDS	002 003 006 019 020 021 024 025 034 038 041
YAMAHA	007 008 018 026 037
ZENITH	023 027 033

➤ **CABLE BOX**

Brand	Code
SAMSUNG	000 001 002 003 004 005 006 007
GI	041
HAMLIN	003 024 031
HITACHI	025 030
JERROLD	038 039
MACOM	025 030
MAGNAVOX	019 023 028
OAK	026
PANASONIC	003 022 027 037 044
PHILIPS	019 021 023 028
PIONEER	004 018 020 044
RCA	014 022 040
REGAL	003

➤ **SAMSUNG DVD**

Product	Code
DVD	000 001 002
DVDR	003 004
BD Record	005 006
VCR COMBO	007 008 009 010 011
VCR Record	012
DHR COMBO	013

➤ **DVD**

Brand	Code
ANAM	030
AUDIOVOX	075
AUDIOLOGIC	085
ANABA	072
APEX DIGITAL	070 071 074 086 083 084 088 111 112
AIWA	114
BROKSONIC	062
BLAUPUNKT	074
B&K	122 123
CURTIS MATHES	027
CYBER HOME	077 078 079 082
CLARION	080 125
CIRRUS	081
CYBER HOME	065
CINEVISION	095
DAEWOO	066
DENON	146
FARENHEIT	067 068
FISHER	090
GPX	060
GO VIDEO	061 089 133 135
GE	069 074
GREENHILL	074
HITACHI	064 113
HITEKER	071
HOYO	073
HARMAN / KARDON	091 110
IRT	089

Brand	Code
REGENCY	015 023
SA	042 043
SCIENTIFIC ATLAN	042 043
SPRUCER	022
STARGATE 2000	036
SYLVANIA	016
TEXSCAN	016
TOCOM	032
UNIVERSAL	033 034
VIEWSTAR	019 021 023 028
WARNER AMEX	046
ZENITH	017 029 035 037 045

Product	Code
Home Theater VCR COMBO	014 015 016
HDD Recorder COMBO	017
TWIN TRAY COMBO	018
STB DVD COMBO	019
DVD Receiver	020
AV Receiver	021

Brand	Code
INTEGRA	092
JBL	091
JVC	022 033 115 116
JATON	073
KENWOOD	051 108 109
KISS	073
KONKA	059 100 106 107
KLH	074 075
LG(Goldstar)	025 031
LOEWE	057
LASONIC	058
MOBILE AUTHORITY	054
MEMOREX	055
MALATA	056
MAGNAVOX	076 093
MINTEK	074 094
MONYKA	073
NORCENT	048 049 050
NEXT BASE	052
NEC	053
NANTAUS	144
NESA	074
OPTOMEDIA ELECTRONICS	105
OPTIVIEW	072
ONKYO	076 092 119
PHILCO	044 045
PRINCETON	046 047
PROSCAN	023

> DVD

Brand	Code
PANASONIC	024 034 124 134 136 137 138
PHILIPS	036 076
ROTEL	117 118
RIO	120
RCA	023 035 074 075 131 132
RAITE	073
ROWA	038
SAMPO	104
SONY	026 029 126 127 128 129 130 141
SHERWOOD	039 041
SVA	042
SYLVANIA	043 093
SHARP	140
SANSUI	062
SANYO	062 090
SHINSONIC	094

> SAMSUNG SET-TOP BOX

Product	Code
Ground wave STB	000 001 002 008 013
CABLE STB	000 004 008 013
Satellite STB	000 003 008 013

> SET-TOP BOX

Brand	Code
ALPHASTAR	023
ANAM	043
CHANNEL MASTER	018 034
CROSSDIGITAL	019
CHAPARRAL	035
DIRECT TV	015 016 017 019 022 045 060 061 062 065 066 067 068
DAEWOO	074
DISH NETWORK SYSTEM	069 070
DISHPRO	069
DRAKE	018 024 032
DX ANTENNA	027
ECHOSTAR	025 069 070 071
EXPRESSVU	069
GOI	069
GE	065
GENERAL INSTRUMENT	046 047 048 063 064
HTS	069
HOME CABLE	056
HITACHI	022
HUGHES NETWORK	015 017
IQ	020
IQ PRISM	020
JANEIL	059
JERROID	063
JVC	069 070
LG(Goldstar)	044 073

Brand	Code
THOMSON	145
TOSHIBA	028 062 076
TECHNICS	139
TVIEW	072
TOKAI	073
TEAC	096
TECHWOOD	097
TREDEX	098 099 101
URBAN CONCEPTS	076
VENTURER	075
VOCOPRO	102
YAMAHA	032 063
YAMAKAWA	040 073
XWAVE	103
ZENITH	076 121

Brand	Code
MAGNAVOX	016 021 036 038 039 040 041 042
MEMOREX	016
MOTOROLA	064
MACOM	018
MINISUBISHI	015
NEXT LEVEL	047 048 064
PHILIPS	015 016 017 021 033 036 038 039 040 041 042 067
PRIMESTAR	046 049 050 063
PANASONIC	058 059 061 062
PAYSAT	016
PROSCAN	065 066
RCA	051 052 053 065 066
RADIOSHACK	064
REALISTIC	057
STAR TRAK	026
STS	020 027
SKY	031
SKY LIFE	005 006 007
SHACK	064
STAR CHOICE	064
SONY	054 060
TOSHIBA	015 017 028 029 030 072
ULTIMATE TV	060 066
UNIDEN	016 021 037 055 056 057
ZENITH	024 031 068

## To Select the Source

Use to select TV or other external input sources such as DVD players or Cable Box/ Satellite receivers (Set-Top Box) connected to the TV. Use to select the input source of your choice.

1. Press the **MENU** button to display the menu.  
Press the **▲** or **▼** button to select "Input", then press the **ENTER** button.
2. Press the **ENTER** button to select "Source List".  
Press the **▲** or **▼** button to select signal source, then press the **ENTER** button.
  - You can choose between the following sets of jacks: AV1, S-Video1, Component1, Component2, PC, HDMI1, or HDMI2 on the TV's rear panel and AV2, S-Video2, or HDMI3 on the TV's side panel.
  - HDMI1, HDMI2, HDMI3 input can only be selected when the external device is turned on and connected via HDMI.
  - You can choose only those external devices that are connected to the TV.

 Press the **SOURCE** button on the remote control to view an external signal source.

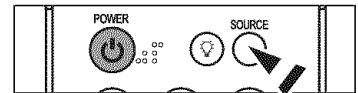
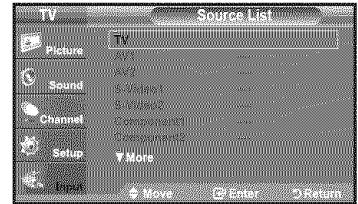

## To Edit the Input Source Name

Name the device connected to the input jacks to make your input source selection easier.

1. Press the **MENU** button to display the menu.  
Press the **▲** or **▼** button to select "Input", then press the **ENTER** button.  
Press the **▲** or **▼** button to select "Edit Name", then press the **ENTER** button.
2. Press the **▲** or **▼** button to select "AV1", "AV2", "S-Video1", "S-Video2", "Component1", "Component2", "PC", "HDMI1", "HDMI2", "HDMI3" input jack, then press the **ENTER** button.
3. Press the **▲** or **▼** button to select "VCR", "DVD", "D-VHS", "Cable STB", "HD STB", "Satellite STB", "PVR STB", "AV Receiver", "DVD Receiver", "Game", "Camcorder", "DVD Combo", "PC", "VOD STB", "TV" input source, then press the **ENTER** button.  
Press the **EXIT** button to exit.
  - When a PC with a resolution of 1920 x 1080@60Hz is connected to the HDMI IN 1 port, you should set the "HDMI1" mode to "PC" in the "Edit Name" of the "Input" mode. If the "HDMI1" mode is not PC, it works depending on the TV setting.

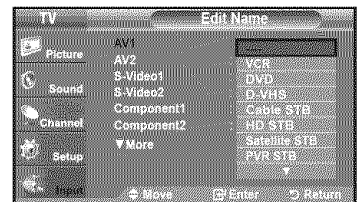
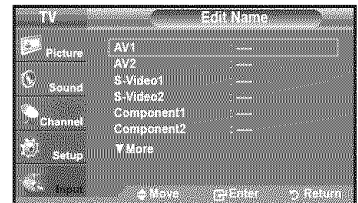



# Picture Control

## Using Automatic Picture Settings

Your TV has Three automatic picture settings ("Dynamic", "Standard" and "Movie") that are preset at the factory. You can activate either Dynamic, Standard, Movie by making a selection from the menu.

1. Press the **MENU** button to display the menu.  
Press the **ENTER** button, to select "Picture".

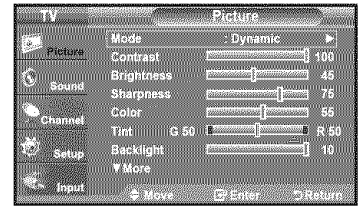

2. Press the **ENTER** button to select "Mode".  
Press the **▲** or **▼** button to select the "Dynamic", "Standard", "Movie" picture setting. Press the **ENTER** button.

- Choose **Dynamic** to increase the clarity and sharpness of the picture.
- Choose **Standard** for the standard factory settings.
- Choose **Movie** for a natural Image without picture enhancements.

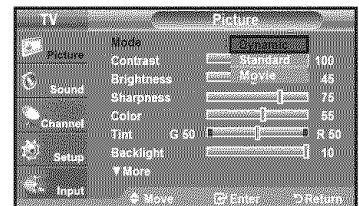

3. Press the **▲** or **▼** button to select "Contrast", "Brightness", "Sharpness", "Color", "Tint(G/R)" or "Backlight", then press the **ENTER** button.

4. Press the **◀** or **▶** button to decrease or increase the value of a particular item.  
For example, if you select "Contrast", pressing the **▶** button increases it.  
Press the **ENTER** button.

Press the **EXIT** button to exit.

- > When you make changes to "Contrast", "Brightness", "Sharpness", "Color", "Tint(G/R)" or "Backlight", the OSD will be adjusted accordingly.
- > When in PC mode, Tint, Sharpness and Color are not available.
- > Each adjusted setting will be stored separately according to its input mode.

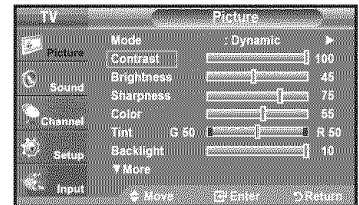

5. Press the **P.MODE** button on the remote control repeatedly to select the desired picture mode.

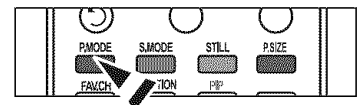

## Adjusting the Color Tone

You can change the color of the entire screen according to your preference.

1. Press the **MENU** button to display the menu.  
Press the **ENTER** button to select "Picture".
2. Press the **▲** or **▼** button to select "Color Tone", then press the **ENTER** button.
3. Press the **▲** or **▼** button to select "Cool2", "Cool1", "Normal", "Warm1" or "Warm2".  
Press the **ENTER** button.
  - When the picture mode is set to "Dynamic" or "Standard", "Warm1" and "Warm2" cannot be selected. "Movie" mode is only available.
  - Each adjusted setting will be stored separately according to its input mode.

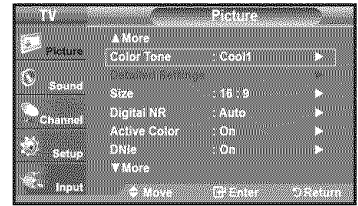

## Resetting the Picture Settings to the Factory Defaults

1. Press the **MENU** button to display the menu.  
Press the **ENTER** button to select "Picture".
2. Press the **▲** or **▼** button to select "Reset", then press the **ENTER** button.  
Press the **▲** or **▼** button to select "Cancel" or "OK" then press the **ENTER** button.  
Press the **EXIT** button to exit.
  - Each mode can be reset.

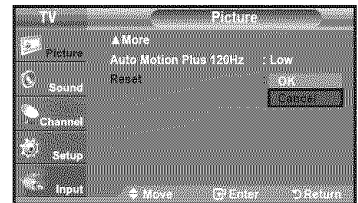

## Adjusting the Detailed Settings

Samsung's new TVs allow you to make even more precise picture settings than previous models. See below to adjust detailed picture settings.

### Activating Detailed Settings

1. Press the **MENU** button to display the menu.  
Press the **ENTER** button to select "Picture".
2. Press the **ENTER** button to select "Mode"  
Press the **▲** or **▼** button to select "Standard" or "Movie", then press the **ENTER** button.
3. Press the **▲** or **▼** button to select "Detailed Settings", then press the **ENTER** button.
  - > "Detailed Settings" is available in "Standard" or "Movie" mode.
  - > If "DNLe" is Off, the "Detailed Settings" cannot be selected when the Picture mode is in "Standard" mode.

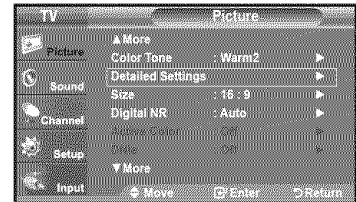
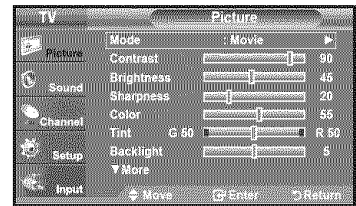

### Activating Black adjust

You can select the black level on the screen to adjust the screen depth.

4. Press the **▲** or **▼** button to select "Black adjust", then press the **ENTER** button.
5. Press the **▲** or **▼** button to select "Off", "Low", "Medium", "High".  
Press the **ENTER** button.

- **Off**: Turns off the black adjustment function.
- **Low**: Sets the black color depth to low.
- **Medium**: Sets the black color depth to medium.
- **High**: Sets the black color depth to high.

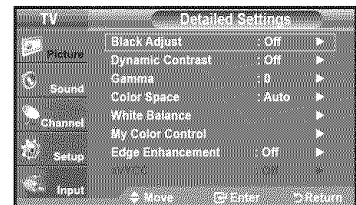

### Activating Dynamic Contrast

You can adjust the screen contrast so that the optimal contrast is provided.

6. Press the **▲** or **▼** button to select "Dynamic Contrast", then press the **ENTER** button.
7. Press the **▲** or **▼** button to select "Off", "Low", "Medium", "High".  
Press the **ENTER** button.

- **Off**: Turns off the dynamic contrast adjustment function.
- **Low**: Sets the dynamic contrast to low.
- **Medium**: Sets the dynamic contrast to medium.
- **High**: Sets the dynamic contrast to high.

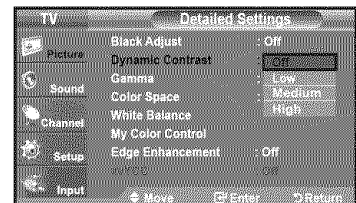
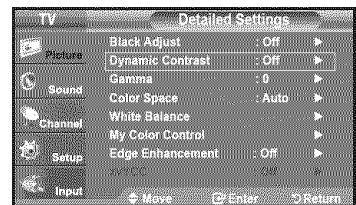

## Activating Gamma

You can adjust the Primary Color (Red, Green Blue) Intensity. (-3 ~ +3)

8. Press the ▲ or ▼ button to select "Gamma", then press the ENTER button.
9. Press the ◀ or ▶ button to decrease or increase the value of a particular item. Press the ENTER button.

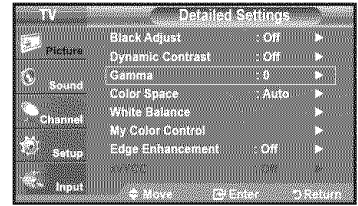

## Changing the Color Space

Color space is a color matrix composed of red, green and blue colors. Select your favorite color space to experience the most natural color.

10. Press the ▲ or ▼ button to select "Color Space", then press the ENTER button.
11. Press the ▲ or ▼ button to select "Auto" or "Wide". Press the ENTER button.

- ♦ **Auto** : Auto Color Space automatically adjusts to the most natural color tone based on program sources.
- ♦ **Wide** : Wide Color Space offers deep and rich color tone.

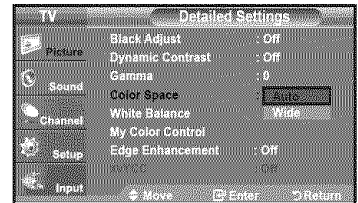
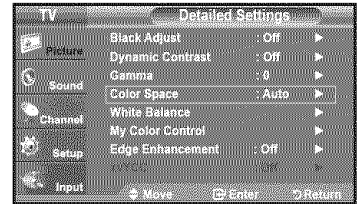

## Activating White Balance

You can adjust the color temperature for more natural picture colors.

12. Press the ▲ or ▼ button to select "White Balance", then press the ENTER button.
13. Select the required option by pressing the ▲ or ▼ button, then press the ENTER button.
14. Press the ◀ or ▶ button to decrease or increase the value of a particular item. Press the ENTER button.

- ♦ **R-Offset**: Adjusts the red color darkness.
- ♦ **G-Offset**: Adjusts the green color darkness.
- ♦ **B-Offset**: Adjusts the blue color darkness.
- ♦ **R-Gain**: Adjusts the red color brightness.
- ♦ **G-Gain**: Adjusts the green color brightness.
- ♦ **B-Gain**: Adjusts the blue color brightness.
- ♦ **Reset**: The previously adjusted white balance will be reset to the factory defaults.

> Changing the adjustment value will refresh the adjusted screen.

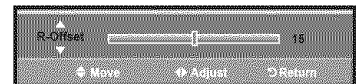
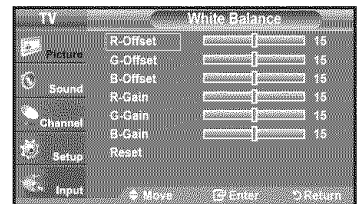

### Activating My Color Control

This setting can be adjusted to suit your personal preferences. When using the My Color Control Feature, the current picture remains in movement.

15. Press the **ENTER** button to select "My Color Control".
16. Press the **▲** or **▼** button to select "Pink", "Green", "Blue", "White" or "Reset". Press the **ENTER** button.
17. Press the **◀** or **▶** button to decrease or increase the value of a particular item. Press the **ENTER** button.

- ♦ **Pink:** Darkens or lightens the pink color
- ♦ **Green:** Darkens or lightens the green color
- ♦ **Blue:** Darkens or lightens the blue color
- ♦ **White:** Darkens or lightens the white color
- ♦ **Reset:** The previously adjusted colors will be reset to the factory defaults.

➤ Changing the adjustment value will refresh the adjusted screen.

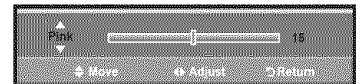
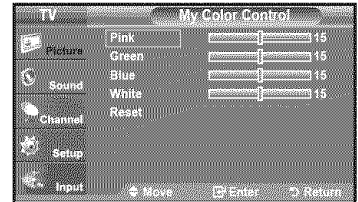
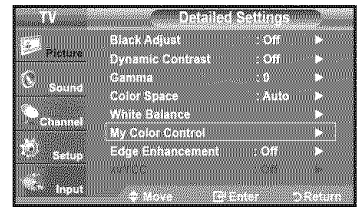

### Activating Edge Enhancement

You can emphasize object boundaries in the picture.

18. Press the **▲** or **▼** button to select "Edge Enhancement", then press the **ENTER** button.
19. Press the **▲** or **▼** button to select "Off" or "On". Press the **ENTER** button.

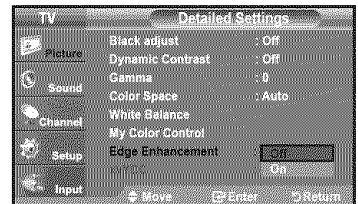

### Activating xvYCC

Setting the xvYCC mode to On increases detail and color space when watching movies from an external device (ie. DVD player) connected to the HDMI or Component IN jacks. You must set the Picture Mode to Movie to enjoy this feature.

20. Press the **▲** or **▼** button to select "xvYCC", then press the **ENTER** button.
  21. Press the **▲** or **▼** button to select "Off" or "On". Press the **ENTER** button.
- Press the **EXIT** button to exit.

- Only available in "HDMI" and "Component" on "Movie" option.
- If xvYCC function is active, PIP cannot be selected.

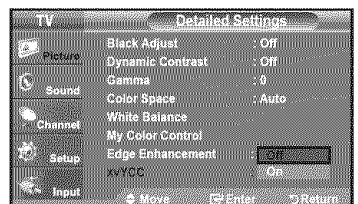
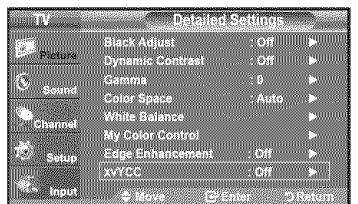

## Changing the Screen Size

Occasionally, you may want to change the size of the image on your screen. Your TV comes with six screen size options, each designed to work best with specific types of video input. Your cable box or satellite receiver may have its own set of screen sizes as well. In general, though, you should view the TV in 16:9 mode as much as possible.

1. Press the **MENU** button to display the menu.  
Press the **ENTER** button, to select "Picture".
2. Press the **▲** or **▼** button to select "Size", then press the **ENTER** button.
3. Press the **▲** or **▼** button to select the screen format you want.  
Press the **ENTER** button.  
Press the **EXIT** button to exit.

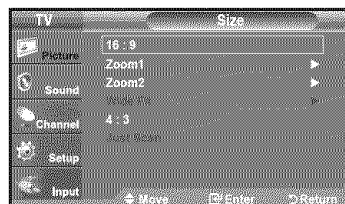
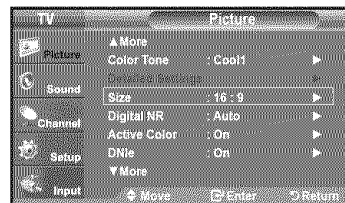

- **16:9** : Sets the picture to 16:9 wide mode.
- **Zoom1** : Magnifies the size of the picture on the screen.
- **Zoom2** : Magnifies the size of the picture more than "Zoom1".
- **Wide Fit** : Enlarges the aspect ratio of the picture to fit the entire screen.
- **4:3** : Sets the picture to 4:3 normal mode.
- **Just Scan** : Use the function to see the full image without any cutoff when HDMI (720p/1080i/1080p), Component (720p/1080i/1080p) or DTV (1080i) signals are input.

- Alternately, you can press the **P.SIZE** button on the remote control repeatedly to change the picture size.

- Temporary image retention may occur when viewing a static image on the set for more than two hours.
- HD (High Definition)  
16:9 - 1080i/1080p (1920x1080), 720p (1280x720)

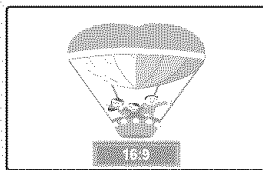
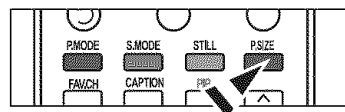

**16:9**  
Sets the picture to 16:9 wide mode.

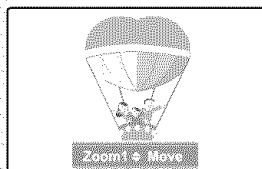

**Zoom1**  
The screen size when Wide screen is vertically enlarged.

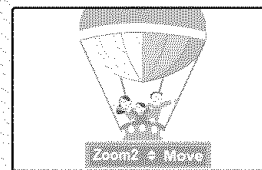

**Zoom2**  
The screen size when the Zoom1 screen is vertically enlarged.

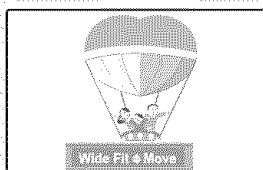

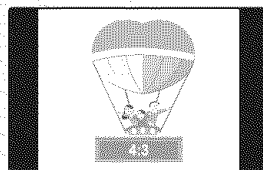

**Wide Fit**  
Enlarges the aspect ratio of the picture to fit the entire screen.

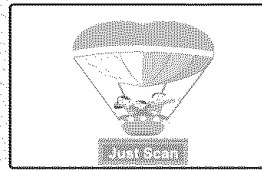

**4:3**  
Sets the picture to 4:3 normal mode.



**Just Scan**  
Use the function to see the full image without any cutoff when HDMI(720p/1080i/1080p), Component (720p/1080i/1080p) or DTV (1080i) signals are input.

- In TV, VIDEO, S-VIDEO and all COMPONENT (480i, 480p) modes, all screen modes can be selected. (16:9, Zoom1, Zoom2, 4:3).
- You can select only the 16:9, 4:3 and Wide Fit screen sizes in the DTV(1080i), Component (720p, 1080i, 1080p) or HDMI (720p, 1080i, 1080P) mode.
- In PC modes, only 16:9 & 4:3 modes can be selected.
- You must select Zoom with **P.SIZE** button on the remote if you want to move the Zoom 1 or 2 picture up or down.
- When watching a DTV's HD signal, you can use Wide Fit. Horizontal zoom (Wide Fit) sets the optical picture format by expanding it both horizontally and vertically. For example, you can reset the picture in 4:3 format to 16:9. Wide Fit does not support all external devices (DVD, VCR etc.).
- When Double (  ,  ) mode has been set in PIP, the Picture Size cannot be set.

## Setting the Active Color

If you turn on this option, the blue and green colors will be more vivid.

1. Press the **MENU** button to display the menu.  
Press the **ENTER** button, to select "Picture".
2. Press the **▲** or **▼** button to select "Active Color", then press the **ENTER** button.
3. Press the **▲** or **▼** button to select "Off" or "On"  
Press the **ENTER** button.

Press the **EXIT** button to exit.

- > "Active Color" is available only in "Dynamic" mode.
- > This function doesn't work when the Input Source is PC.

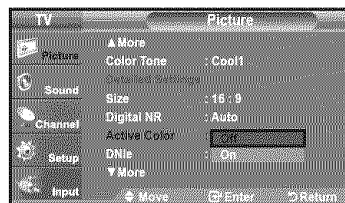
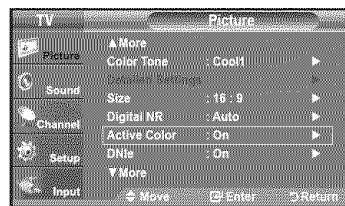

## DNLe (Digital Natural Image engine)

This TV includes the DNLe function to provide high visual quality. If you set DNLe to on, you can view the screen with the DNLe feature activated. Using this function, you can view the difference in the visual quality.

1. Press the **MENU** button to display the menu.  
Press the **ENTER** button, to select "Picture".
2. Press the **▲** or **▼** button to select "DNLe", then press the **ENTER** button.
3. Press the **▲** or **▼** button to select "Off" or "On", then press the **ENTER** button.

- **Off:** Switches off the "DNLe" mode.
- **On:** Switches on the "DNLe" mode.

Press the **EXIT** button to exit.

- > DNLe™ (Digital Natural Image engine) **DNLe™**  
This feature brings you a more detailed image with 3D noise reduction and detailed, contrast and white enhancement.
- > This function doesn't work when the Input Source is PC.
- > The DNLe function is not supported in the Movie mode.

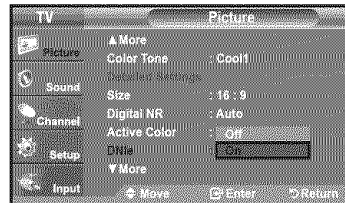
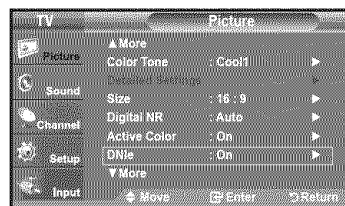

## Setting the Auto Motion Plus 120Hz

Removes drag from fast scenes with a lot of movement to provide a clearer picture.

1. Press the **MENU** button to display the menu.  
Press the **▲** or **▼** button to select "Picture", then press the **ENTER** button.
2. Press the **▲** or **▼** button to select "Auto Motion Plus 120Hz", then press the **ENTER** button.
3. Press the **▲** or **▼** button to select "Off", "Low", "Medium", "High" or "Demo", then press the **ENTER** button.

- **Off:** Switches Auto Motion Plus 120Hz off.
- **Low:** Sets Auto Motion Plus 120Hz to minimum.
- **Medium:** Sets Auto Motion Plus 120Hz to medium.
- **High:** Sets Auto Motion Plus 120Hz to maximum.
- **Demo:** Displays the difference between Auto Motion Plus 120Hz on and off modes. The screen after applying "Auto Motion Plus 120Hz" appears on the left screen.

Press the **EXIT** button to exit.

- > If you enable "Auto Motion Plus 120 Hz", noise may appear on the screen.  
If this occurs, set "Auto Motion Plus 120 Hz" to "Off".

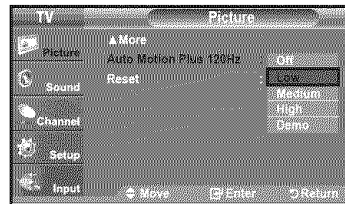
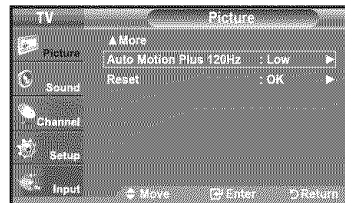

## Setting the HDMI Black Level

You can select the black level on the screen to adjust the screen depth.

1. Press the **MENU** button to display the menu.  
Press the **▲** or **▼** button to select "Setup", then press the **ENTER** button.
2. Press the **▲** or **▼** button to select "HDMI Black Level", then press the **ENTER** button.
3. Press the **▲** or **▼** button to select "Normal" or "Low", then press the **ENTER** button.

• **Normal:** The screen gets brighter.

• **Low:** The screen gets darker.

- This function is active only when the external input connects to HDMI (RGB signals). "HDMI Black Level" function may not be compatible with or external devices.

Press the **EXIT** button to exit.

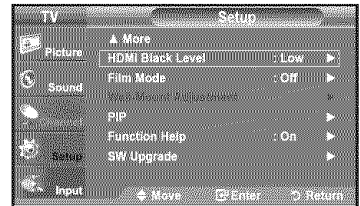

## Setting the Film Mode

The TV can be set to automatically sense and process film signals from all sources and adjust the picture for optimum quality.

1. Press the **MENU** button to display the menu.  
Press the **▲** or **▼** button to select "Setup", then press the **ENTER** button.
  2. Press the **▲** or **▼** button to select "Film Mode", then press the **ENTER** button.
  3. Press the **▲** or **▼** button to select "On" or "Off", then press the **ENTER** button.  
Press the **EXIT** button to exit.
- "Film mode" is supported in TV, VIDEO, S-VIDEO, COMPONENT(480i / 1080i) and HDMI(480i / 1080i).

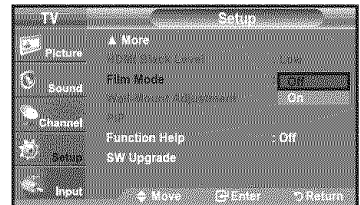



## Viewing Picture-in-Picture

This product has one built-in tuner, which does not allow PIP to function in the same mode. For example, you cannot watch one TV channel in the main screen and a different one in the PIP screen. Please see 'PIP Settings' below for details. You can use the PIP feature to simultaneously watch two video sources. (See page 37 to select the PIP picture sound.)

- > While V-Chip (See page 56) is in operation, the PIP function cannot be used.
- > While xvYCC (See page 27) is in operation, the PIP function cannot be used.

### Activating Picture-in-Picture

1. Press the **MENU** button to display the menu.  
Press the **▲** or **▼** button to select "Setup", then press the **ENTER** button.  
Press the **▲** or **▼** button to select "PIP", then press the **ENTER** button.
2. Press the **ENTER** button again.  
Press the **▲** or **▼** button to select "On", then press the **ENTER** button.
  - > If you turn the TV off while watching in PIP mode and turn it on again, the PIP window will disappear.
  - > You can view Analog TV broadcasts on the PIP screen (sub-picture) when the main picture is from an external device connected to HDMI1, 2, 3, Component1, 2 or PC

Main picture	Sub picture
Component 1, 2 HDMI 1, 2, 3 PC	Analog TV broadcasts only

-  Alternately, you can press the **PIP** button on the remote control repeatedly to activate or deactivate the PIP.

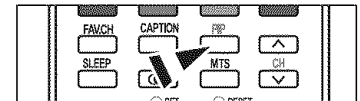
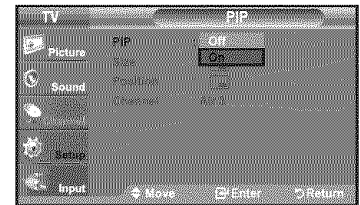
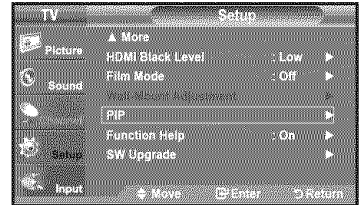

### Changing the PIP Channel

3. Press the **▲** or **▼** button to select "Channel", then press the **ENTER** button.  
Press the **▲** or **▼** button to select the desired channel in the PIP window.  
Press the **ENTER** buttons.
  - > MAIN: PC / HDMI 1,2,3 / Component 1,2
  - PIP: TV(Analog)

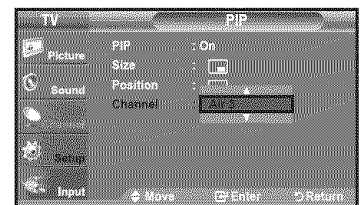
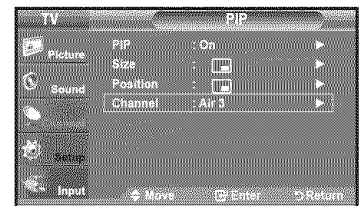

-  Alternately, you can press the PIP Channel buttons on the remote control.

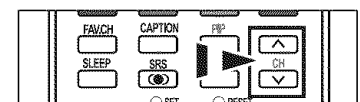

### Changing the Position of the PIP Window

4. Press the ▲ or ▼ button to select "Position", then press the ENTER button. Press the ▲ or ▼ button to select the required option, then press the ENTER button.
  - > In Double Window (□□), and Double Wide (□□) modes, "Position" cannot be selected.

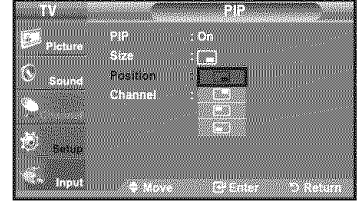
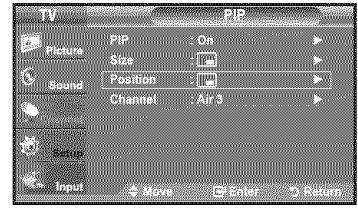

### Changing the Size of the PIP Window

5. Press the ▲ or ▼ button to select "Size", then press the ENTER button. Press the ▲ or ▼ button to select the required option, then press the ENTER button.

Press the EXIT button to exit.

  - > If the main picture is in PC and HDMI 1 mode, "Size" is not available.
  - > You may notice that the picture in the PIP window becomes slightly unnatural when you use the main screen to view a game or karaoke.
  - > You can adjust picture position only by using the [icon] size menu.

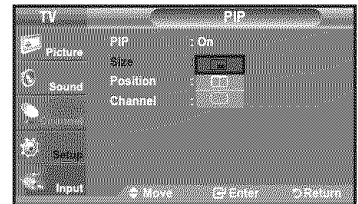
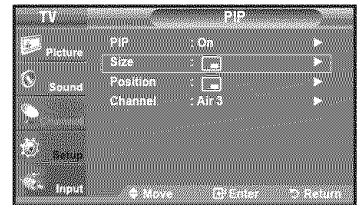

## Freezing the Picture

1. Press the STILL button to freeze a moving picture.
  - > Normal sound will still be heard. Press again to cancel.
  - > While "V-Chip" is in operation, the Still function cannot be used. (See page 56)

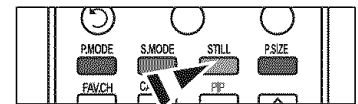

# Sound Control

## Customizing the Sound

The sound settings can be adjusted to suit your personal preference. (Alternatively, you can use one of the "automatic" settings.)

1. Press the **MENU** button to display the menu.  
Press the **▲** or **▼** button to select "Sound", then press the **ENTER** button.
2. Press the **▲** or **▼** button to select "Equalizer", then press the **ENTER** button.
3. Press the **◀** or **▶** button to select a particular frequency to adjust.  
Press the **▲** or **▼** button to increase or decrease the level of the particular frequency.  
Press the **ENTER** button.  
Press the **EXIT** button to exit.

- **L/R Sound Balance Adjustment:** To adjust the sound balance of the L/R speakers.
- **Bandwidth Adjustment (100Hz, 300Hz, 1KHz, 3KHz, 10KHz):** To adjust the level of different bandwidth frequencies.

➤ If you make any changes to the "Equalizer" settings, the sound mode is automatically switched to the "Custom" mode.

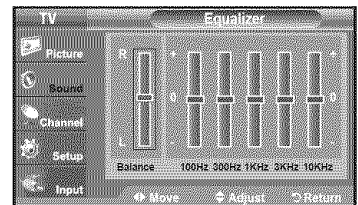
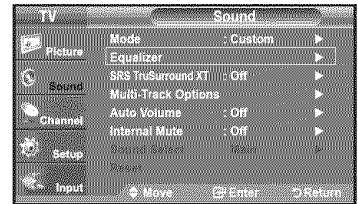



## Using Automatic Sound Settings

Your TV has automatic sound settings ("Standard", "Music", "Movie", "Speech" and "Custom") that are preset at the factory. Or, you can select "Custom", which automatically recalls your personalized sound settings.

1. Press the **MENU** button to display the menu.  
Press the **▲** or **▼** button to select "Sound", then press the **ENTER** button.
2. Press the **ENTER** button to select "Mode".  
Press the **▲** or **▼** button to select "Standard", "Music", "Movie", "Speech", or "Custom" sound setting, then press the **ENTER** button.  
Press the **EXIT** button to exit.

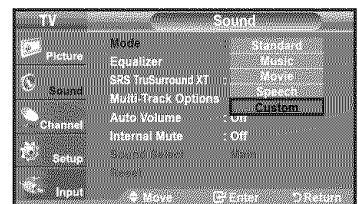
- Choose **Standard** for the standard factory settings.
- Choose **Music** when watching music videos or concerts.
- Choose **Movie** when watching movies.
- Choose **Speech** when watching a show that is mostly dialog (i.e., news).
- Choose **Custom** to recall your personalized settings (see "Customizing the Sound").



-  Press the **S.MODE** button on the remote control repeatedly to select one of the sound settings.

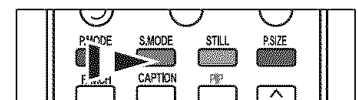

## Setting the TruSurround XT

TruSurround XT is a patented SRS technology that solves the problem of playing 5.1 multichannel content over two speakers. TruSurround delivers a compelling, virtual surround sound experience through any two-speaker playback system, including internal television speakers. It is fully compatible with all multichannel formats.

1. Press the **MENU** button to display the menu.  
Press the **▲** or **▼** button to select "Sound", then press the **ENTER** button.
  2. Press the **▲** or **▼** button to select "SRS TruSurround XT", then press the **ENTER** button.
  3. Press the **▲** or **▼** button to select "On" or "Off", then press the **ENTER** button.  
Press the **EXIT** button to exit.
-  Press the **SRS** button on the remote control to select "On" or "Off".

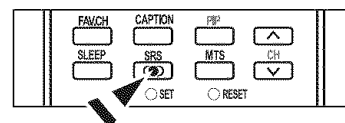
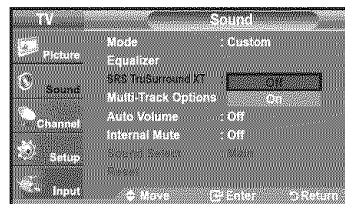
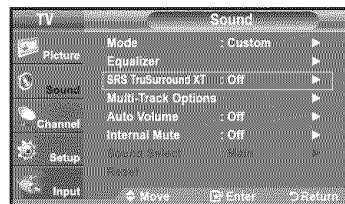

### TRADEMARK & LABEL LICENSE NOTICE



TruSurround XT, SRS and  Symbol are trademarks of SRS Labs, Inc.

TruSurround XT technology is incorporated under license from SRS Labs, Inc.

## Choosing a Multi-Channel Sound (MTS) track - Digital

The digital-TV transmission system is capable of simultaneous transmission of many audio tracks (for example, simultaneous translations of the program into foreign languages). The availability of these additional "multitracks" depends upon the program.

### Preferred Language

1. Press the **MENU** button to display the menu.  
Press the **▲** or **▼** button to select "Sound", then press the **ENTER** button.  
    - > Quick way to access the MTS menu: Just press the "MTS" button on the remote control. You can listen in a language other than your chosen language by pressing the MTS button.
  2. Press the **▲** or **▼** button to select "Multi-Track Options", then press the **ENTER** button.
  3. Press the **ENTER** button to select "Preferred Language".  
Press the **▲** or **▼** button to choose the language (English, Spanish or French) you want, then press the **ENTER** button.  
Press the **EXIT** button to exit.
- > "Multi-Track Options" is available only in TV mode.  
> You can only select the language from among the actual languages being broadcast.

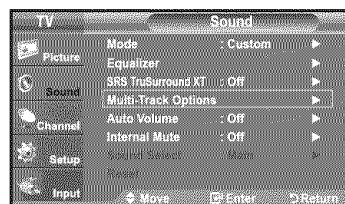

-  You can listen in a language other than the favorite language by pressing the **MTS** button on the remote control.

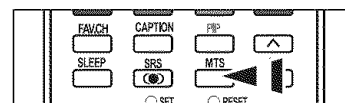

## Choosing a Multi-Channel Sound (MTS) track - Analog

### Multi-Track Sound

1. Press the **MENU** button to display the menu.  
Press the **▲** or **▼** button to select "Sound", then press the **ENTER** button.
2. Press the **▲** or **▼** button to select "Multi-Track Options", then press the **ENTER** button.
3. Press the **▲** or **▼** button to select "Multi-Track Sound", then press the **ENTER** button.  
Press the **▲** or **▼** button to select a setting you want, then press the **ENTER** button.  
Press the **EXIT** button to exit.

- Choose **Mono** for channels that are broadcasting in mono or if you are having difficulty receiving a stereo signal.
- Choose **Stereo** for channels that are broadcasting in stereo.
- Choose **SAP** to listen to the Separate Audio Program, which is usually a foreign-language translation.

> "Multi-Track Options" is available only in TV mode.

-  Press the **MTS** buttons on the remote control repeatedly to select "Mono", "Stereo" or "SAP".

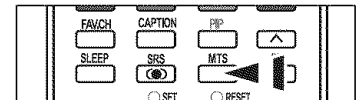
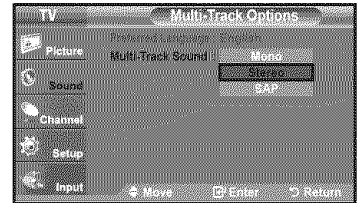
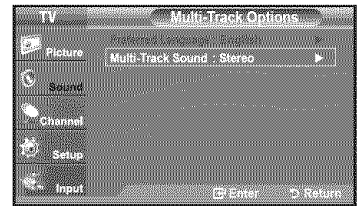

## Automatic Volume Control

Reduces the differences in volume level among broadcasters.

1. Press the **MENU** button to display the menu.  
Press the **▲** or **▼** button to select "Sound", then press the **ENTER** button.
2. Press the **▲** or **▼** button to select "Auto Volume", then press the **ENTER** button.
3. Press the **▲** or **▼** button to set Auto Volume "On" or "Off" then press the **ENTER** button.  
Press the **EXIT** button to exit.

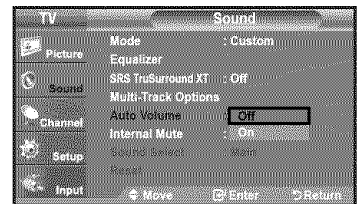
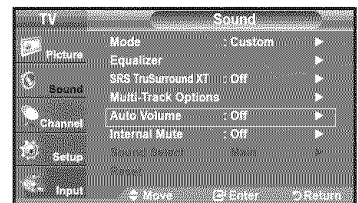

## Selecting the Internal Mute

Sound output from the TV speakers is muted.

1. Press the **MENU** button to display the menu.  
Press the **▲** or **▼** button to select "Sound", then press the **ENTER** button.
2. Press the **▲** or **▼** button to select "Internal Mute", then press the **ENTER** button.

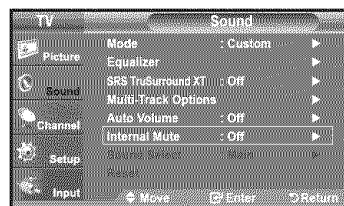

3. Press the **▲** or **▼** button to select "On", then press the **ENTER** button.  
Press the **EXIT** button to exit.
  - When "Internal mute" is set to "On", Sound menus except "Multi-Track Options" and "Sound Select" (in PIP mode) cannot be adjusted.
  - The **VOL**, **VOL** and **MUTE** buttons do not operate when the "Internal Mute" is set to On.

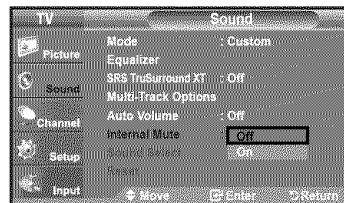

	TV'S Internal Speakers			Audio Out (Optical, L/R Out) to Sound System		
	RF	AV, S-Video	Component, PC, HDMI	RF	AV, S-Video	Component, PC, HDMI
Internal Mute Off	Speaker Output	Speaker Output	Speaker Output	Sound Output	Sound Output	Sound Output
Internal Mute On	Mute	Mute	Mute	Sound Output	Sound Output	Sound Output
Video No Signal	Mute	Mute	Mute	Mute	Mute	Mute

## Adjusting the TV On/Off Melody Sound

A melody sound can be set to come on when the TV is powered On or Off.

1. Press the **MENU** button to display the menu.  
Press the **▲** or **▼** button to select "Setup", then press the **ENTER** button.
2. Press the **▲** or **▼** button to select "Melody", then press the **ENTER** button.
3. Press the **▲** or **▼** button to select "Off", "Low", "Medium" or "High", then press the **ENTER** button.

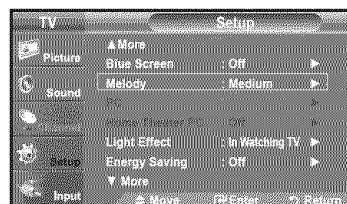

- **Off** : Turns off the melody function.
- **Low** : Sets the melody volume to low.
- **Medium** : Sets the melody volume to medium.
- **High** : Sets the melody volume to high.

Press the **EXIT** button to exit.

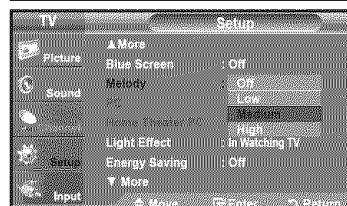

### TRADEMARK & LABEL LICENSE NOTICE



Manufactured under license from Dolby Laboratories.

"Dolby" and the double-D symbol are trademarks of Dolby Laboratories.

## Listening to the Sound of the Sub (PIP) Picture

When the PIP feature is activated, you can listen to the sound of the sub (PIP) picture.

1. Press the **MENU** button to display the menu.  
Press the **▲** or **▼** button to select "Sound", then press the **ENTER** button.
2. Press the **▲** or **▼** button to select "Sound Select", then press the **ENTER** button.
3. Press the **▲** or **▼** button to select "Main" or "Sub", then press the **ENTER** button.  
Press the **EXIT** button to exit.

- **Main:** Used to listen to the sound of the main picture.
- **Sub:** Used to listen to the sound of the sub picture.

➤ You can select this option when "PIP" is set to "On".

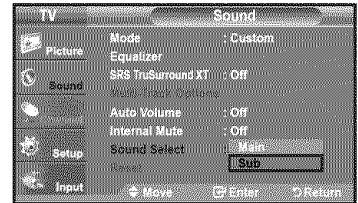
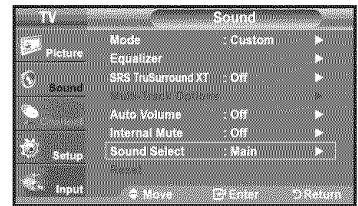

## Resetting the Sound Settings to the Factory Defaults

If Game Mode is On, the Reset Sound function is activated(Refer to page 51). Selecting the Reset function resets the equalizer setting to the factory defaults.

1. Press the **MENU** button to display the menu.  
Press the **▲** or **▼** button to select "Sound", then press the **ENTER** button.
2. Press the **▲** or **▼** button to select "Reset", then press the **ENTER** button.  
Press the **EXIT** button to exit.



## Connecting Headphones

You can connect a set of headphones to your set if you wish to watch a TV program without disturbing the other people in the room.

- When you insert the head set jack into the corresponding port, you can operate only "Multi-Track Option", "Auto Volume" and "Sound Select"(in PIP mode) in Sound menu.
- Prolonged use of headphones at a high volume may damage your hearing.
- You will not receive sound from the speakers when you connect headphones to the system.
- The headphone volume and TV volume are adjusted separately.

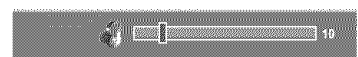

TV Side Panel



## Channel Control

### Selecting the Antenna

1. Press the **MENU** button to display the menu.  
Press the **▲** or **▼** button to select "Channel", then press the **ENTER** button.

2. Press the **ENTER** button to select "Antenna".  
Press the **▲** or **▼** button to select "Air" or "Cable", then press the **ENTER** button.

Press the **EXIT** button to exit.

- If the antenna is connected to ANT 1 IN (AIR), select "Air" and if it is connected to ANT 2 IN (CABLE), select "Cable".

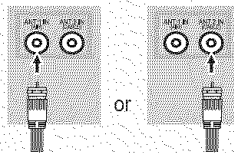

- If both ANT 1 IN (AIR) and ANT 2 IN (CABLE) are connected, select the antenna input you want.  
If the antenna input is not selected properly, noise may appear on the screen.

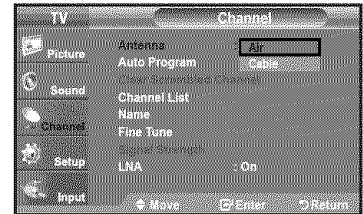
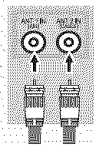

- Press the **ANTENNA** button on the remote control.

### Clearing Scrambled Channels - Digital

The Clear Scrambled Channel function is used to filter out scrambled channels after Auto Program is completed. It removes the scrambled channels from the list by tuning the digital cable channels. This process may take up to 20~30 minutes.

1. Press the **MENU** button to display the menu.  
Press the **▲** or **▼** button to select "Channel", then press the **ENTER** button.
2. Press the **▲** or **▼** button to select "Clear Scrambled Channel", then press the **ENTER** button.  
It searches scrambled channels, which are to be removed from the list.
  - **To stop searching scrambled channels;**  
Press the **ENTER** button to select Stop.  
Press the **◀** button to select "Yes", then press the **ENTER** button.
3. When the scrambled channel searching is completed, press the **ENTER** button.  
Press the **EXIT** button to exit.
  - Only cable mode is available.

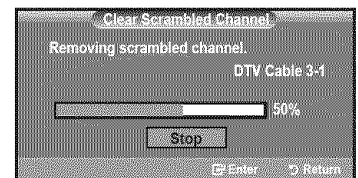
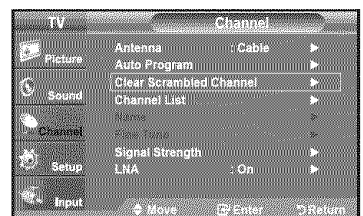



## Adding and Erasing Channels

You can add or delete a channel to display the channels you want. To use the Channel List function, first run "Auto Program".

1. Press the **MENU** button to display the menu.  
Press the **▲** or **▼** button to select "Channel", then press the **ENTER** button.
2. Press the **▲** or **▼** button to select "Channel List", then press the **ENTER** button.



3. Press the **ENTER** button to select "All".



4. Press the **◀**, **▶**, **▲** or **▼** button to select a channel to delete, then press the **ENTER** button.

Press the **▲** or **▼** button to select "Delete", then press the **ENTER** button to delete the channel.

The  mark will disappear.



5. Press the **◀**, **▶**, **▲** or **▼** button to select a channel to add, then press the **ENTER** button.

Press the **▲** or **▼** button to select "Add", then press the **ENTER** button to add the channel.

The  mark will appear and the channel will be added.

Press the **EXIT** button to exit.

➤ All selected channels will be shown on "Added" menu.

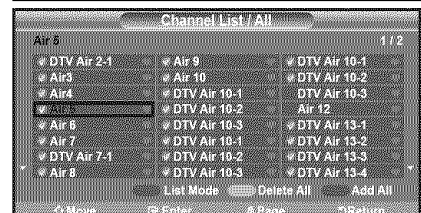

• **P.MODE (Red) button:** Press repeatedly to select "All", "Added" or "Favorite".

• **S.MODE (Green) button:** Press to add all channels deleted.

• **STILL (Yellow) button:** Press to delete all channels memorized.

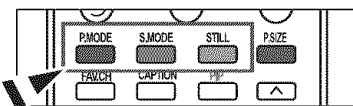

# To Set-Up Your Favorite Channels

You can set channels you watch frequently as favorites.

1. Press the **MENU** button to display the menu.  
Press the **▲** or **▼** button to select "Channel", then press the **ENTER** button.
2. Press the **▲** or **▼** button to select "Channel List", then press the **ENTER** button.
3. Press the **▲** or **▼** button to select "All" or "Added", then press the **ENTER** button.

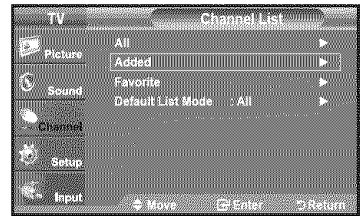
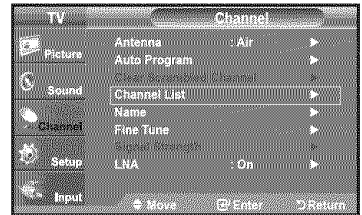

4. Press the **◀**, **▶**, **▲** or **▼** button to select your favorite channels to watch among the labeled channels. Then press the **ENTER** button.  
Press the **▲** or **▼** button to select "Favorite", then press the **ENTER** button.  
The "♥" symbol will be highlighted and the channel will be set as a Favorite. To cancel your Favorite channel selection, press the **ENTER** button until the "♥" symbol is no longer highlighted.

Press the **EXIT** button to exit.

- Only memorized channels can be set as favorite channels.
- All favorite channels will be shown in the "Favorite" menu.

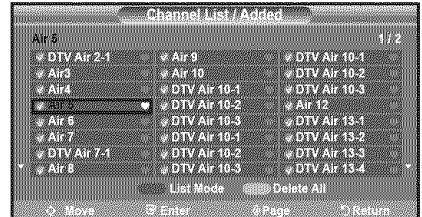
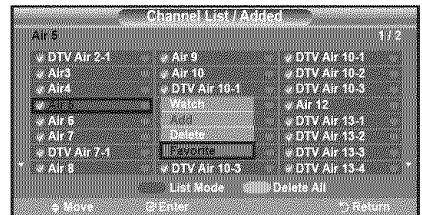

 To select the favorite channels you have set up, press the **FAV.CH** button on the remote control.

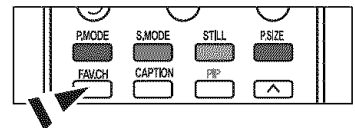

## Using the Channel Lists

Displays the channel list automatically when you press **CH LIST** button on the remote. (Choose All, Added or Favorite)

1. Press the **MENU** button to display the menu.  
Press the **▲** or **▼** button to select "Channel", then press the **ENTER** button.
2. Press the **▲** or **▼** button to select "Channel List", then press the **ENTER** button.  
  - > The Channel list you have chosen will now be set.
3. Press the **▲** or **▼** button to select "Default List Mode" (the channel list you want to appear when you press **CH LIST**), then press the **ENTER** button.  
Press the **▲** or **▼** button to select "All", "Added" or "Favorite" then press the **ENTER** button.

Press the **EXIT** button to exit.

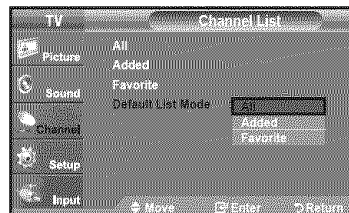

- Alternately, press the **CH LIST** button on the remote control to bring up the Channel Lists.

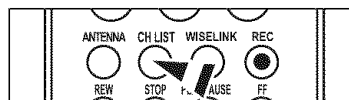

## Viewing the Channel Lists

You can display a list of all channels, added channels or your favorite channels.

1. Press the **MENU** button to display the menu.  
Press the **▲** or **▼** button to select "Channel", then press the **ENTER** button.
2. Press the **▲** or **▼** button to select "Channel List", then press the **ENTER** button.
3. Press the **▲** or **▼** button to select "All", "Added" or "Favorite", then press the **ENTER** button.
4. Press the **▲** or **▼** button to select "Channel", then press the **ENTER** button.  
To toggle between your all channels, add channels or favorite channels, use the **P.MODE** (red) button on the remote control.



- **P.MODE (Red) button:** Press repeatedly to select "All", "Added" or "Favorite"

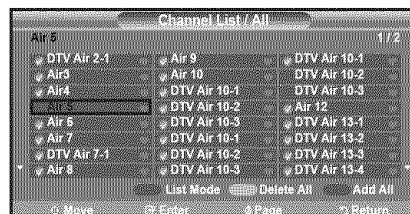
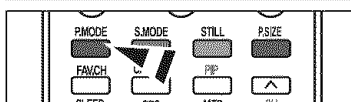

## Labeling Channels

Channels can be labeled so that their call letters appear whenever the channel is selected.

1. Press the **MENU** button to display the menu.  
Press the **▲** or **▼** button to select "Channel", then press the **ENTER** button.  
Press the **▲** or **▼** button to select "Name", then press the **ENTER** button.
2. Press the **▲** or **▼** button to select the channel to be assigned a new name, then press the **ENTER** button.  
Press the **▲** or **▼** button to select a letter, a number or a blank (Results in this sequence: A...Z, 0...9, +, -, \*, /, blank).  
Press the **▶** button to switch to the next field, which will be selected.  
Select a second letter or digit by pressing the **▲** or **▼** button, as above.  
Repeat the process to select the last three digits. When you have finished, press the **ENTER** button to assign the new name.  
To erase the assigned new name, select "Clear" by pressing the **◀** or **▶** button, then press the **ENTER** button.  
Press the **EXIT** button to exit.
  - The names of digital broadcasting channels are automatically assigned and thus cannot be assigned by users.

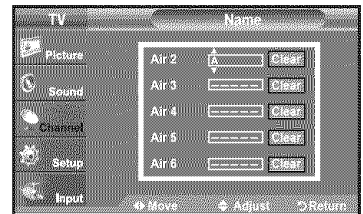
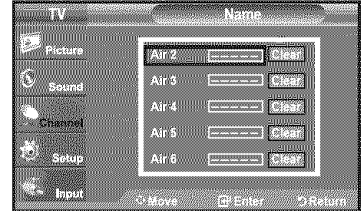
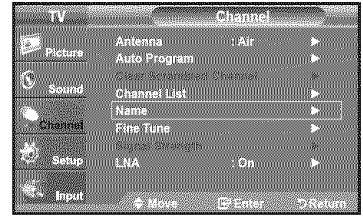

## LNA (Low Noise Amplifier)

If the TV is operating in a weak-signal area, sometimes the LNA function can improve the reception (a low-noise preamplifier boosts the incoming signal).

1. Press the **MENU** button to display the menu.  
Press the **▲** or **▼** button to select "Channel", then press the **ENTER** button.
2. Press the **▲** or **▼** button to select "LNA", then press the **ENTER** button.
3. Press the **▲** or **▼** button to select "On", then press the **ENTER** button.  
Press the **EXIT** button to exit.
  - LNA functions only when antenna is set to Air or Cable.
  - The LNA setting must be made separately for each channel.
  - If the picture is noisy with the LNA set to "On", select "Off".

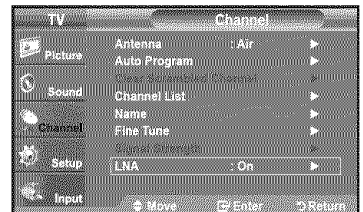

## Fine Tuning Analog Channels

Use fine tuning to manually adjust a particular channel for optimal reception.

1. Press the **MENU** button to display the menu.  
Press the **▲** or **▼** button to select "Channel", then press the **ENTER** button.
2. Press the **▲** or **▼** button to select "Fine Tune", then press the **ENTER** button.
3. Press the **◀** or **▶** button to adjust the fine tuning.  
To store the fine tuning setting in the TV's memory, press the **ENTER** button.
  - > If you do not store the fine-tuned channel in memory, adjustments are not saved.
4. To reset the fine tuning setting, press the **▼** button to select "Reset", then press the **ENTER** button.  
Press the **EXIT** button to exit.
  - > "\*" will appear next to the name of fine-tuned channels.
  - > Only analog TV channels can be fine tuned.

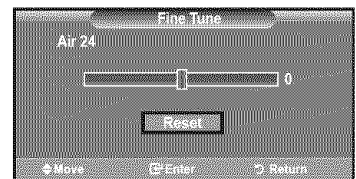
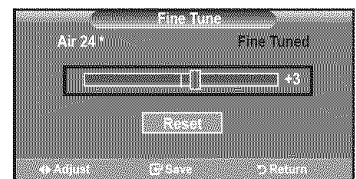
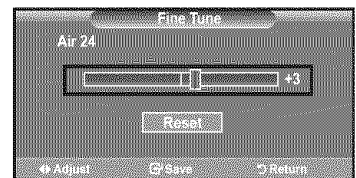
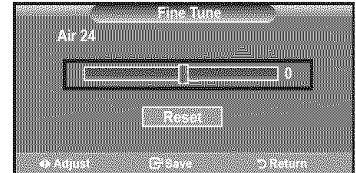
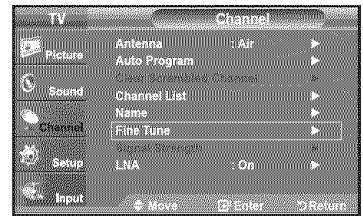

## Checking the Digital-Signal Strength

Unlike analog channels, which can vary in reception quality from "snowy" to clear, digital (HDTV) channels have either perfect reception quality or you will not receive them at all. So, unlike analog channels, you cannot fine tune a digital channel. You can, however, adjust your antenna to improve the reception of available digital channels.

1. Press the **MENU** button to display the menu.  
Press the **▲** or **▼** button to select "Channel", then press the **ENTER** button.
2. Press the **▲** or **▼** button to select "Signal Strength", then press the **ENTER** button.  
If the signal strength meter indicates that the signal is weak, physically adjust your antenna to increase the signal strength.  
Continue to adjust the antenna until you find the best position with the strongest signal.  
Press the **EXIT** button to exit

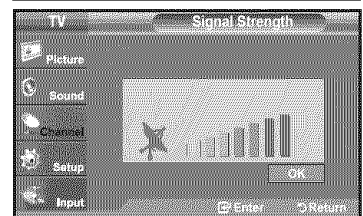

# PC Display

## Using Your TV as a Computer (PC) Display

### Setting Up Your PC Software (Based on Windows XP)

The Windows display-settings for a typical computer are shown below. The actual screens on your PC will probably be different, depending upon your particular version of Windows and your particular video card. However, even if your actual screens look different, the same basic set-up information will apply in almost all cases. (If not, contact your computer manufacturer or Samsung Dealer.)

1. First, click on "**Control Panel**" on the Windows start menu.
2. When the control panel window appears, click on "**Appearance and Themes**" and a display dialog-box will appear.
3. When the control panel window appears, click on "**Display**" and a display dialog-box will appear.
4. Navigate to the "**Settings**" tab on the display dialog-box.

The correct size setting (resolution)

Optimum: 1920 X 1080 pixels

If a vertical-frequency option exists on your display settings dialog box, the correct value is "60" or "60 Hz". Otherwise, just click "OK" and exit the dialog box.

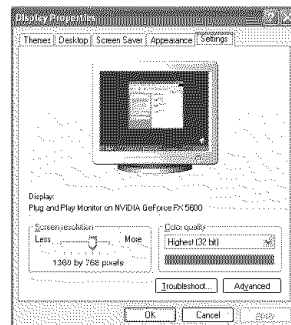

## Display Modes

If the signal from the system equals the standard signal mode, the screen is adjusted automatically. If the signal from the system doesn't equal the standard signal mode, adjust the mode by referring to your videocard user guide; otherwise there may be no video. For the display modes listed below, the screen image has been optimized during manufacturing.

### D-Sub Input

Mode	Resolution	Horizontal Frequency (kHz)	Vertical Frequency (Hz)	Pixel Clock Frequency (MHz)	Sync Polarity (H/V)
IBM	720 X 400	31.469	70.087	28.322	- / +
	640 X 480	31.469	59.940	25.175	- / -
VESA	640 x 480	37.861	72.809	31.500	- / -
	640 x 480	37.500	75.000	31.500	- / -
	800 x 600	35.156	56.250	36.000	+ / +
	800 x 600	37.879	60.317	40.000	+ / +
	800 x 600	48.077	72.188	50.000	+ / +
	800 x 600	46.875	75.000	49.500	+ / +
	1024 x 768	48.363	60.004	65.000	- / -
	1024 x 768	56.476	70.069	75.000	- / -
	1024 x 768	60.023	75.029	78.750	+ / +
	1280 x 1024	79.976	75.025	123.000	+ / +
1920 x 1080	66.500	60.000	138.500	- / +	

### HDMI/DVI Input

Mode	Resolution	Horizontal Frequency (kHz)	Vertical Frequency (Hz)	Pixel Clock Frequency (MHz)	Sync Polarity (H/V)
IBM	640 X 350	31.469	70.086	25.175	+ / -
	720 X 400	31.469	70.087	28.322	- / +
	640 X 480	31.469	59.940	25.175	- / -
VESA	800 x 600	37.879	60.317	40.000	+ / +
	1024 x 768	48.364	60.000	65.000	- / -
	1280 x 1024	63.981	60.020	108.000	+ / +
	1920 x 1080	66.587	59.934	138.500	+ / -

# Setting up the TV with your PC

## How to Auto Adjust

Use the Auto Adjust function to have the TV set automatically adjust the video signals it receives. The function also automatically fine-tunes the settings and adjusts the frequency values and positions.

> This function does not work in DVI-Digital mode.

1. Press the **MENU** button to display the menu.  
Press the **▲** or **▼** button to select "Setup", then press the **ENTER** button.  
Press the **▲** or **▼** button to select "PC", then press the **ENTER** button.  
> Change to the PC mode first.
2. Press the **▲** or **▼** button to select "Auto Adjustment", then press the **ENTER** button.  
Press the **EXIT** button to exit.

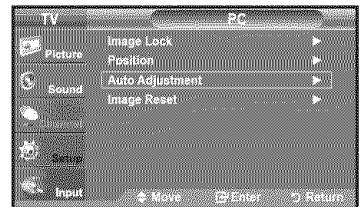
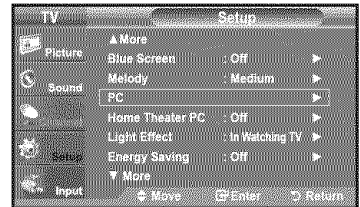

## Adjusting the Screen Quality

The purpose of the picture quality adjustment is to remove or reduce picture noise. If the noise is not removed by fine tuning alone, then make the vertical frequency adjustments on your PC and fine tune again. After the noise has been reduced, re-adjust the picture so that it is aligned on the center of the screen.

1. Press the **MENU** button to display the menu.  
Press the **▲** or **▼** button to select "Setup", then press the **ENTER** button.  
Press the **▲** or **▼** button to select "PC", then press the **ENTER** button.  
> Change to the PC mode first.
2. Press the **ENTER** button to select "Image Lock".
3. Press the **▲** or **▼** button to select "Coarse" or "Fine", then press the **ENTER** button.  
Press the **◀** or **▶** button to adjust the screen quality.

> Vertical stripes may appear or the picture may be blurry.

Press the **ENTER** button.

Press the **EXIT** button to exit.

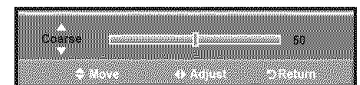
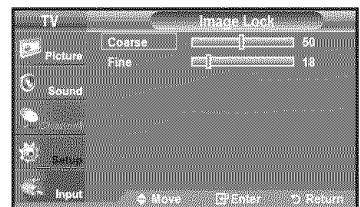

### Changing the Screen Position

1. Press the **MENU** button to display the menu.  
Press the **▲** or **▼** button to select "Setup", then press the **ENTER** button.  
Press the **▲** or **▼** button to select "PC", then press the **ENTER** button.  
➤ Change to the PC mode first.
2. Press the **▲** or **▼** button to select "Position", then press the **ENTER** button.
3. Press the **▲** or **▼** button to adjust the V-Position.  
Press the **◀** or **▶** button to adjust the H-Position.  
Press the **ENTER** button.  
Press the **EXIT** button to exit.

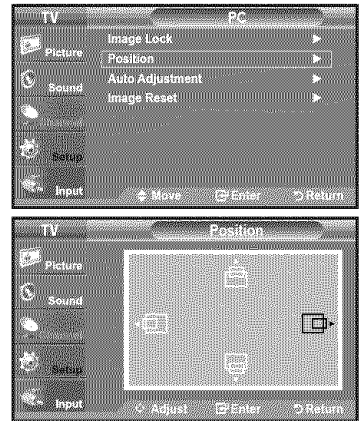

### Initializing the Screen Position or Color Settings

You can replace all image settings with the factory default values.

1. Press the **MENU** button to display the menu.  
Press the **▲** or **▼** button to select "Setup", then press the **ENTER** button.  
Press the **▲** or **▼** button to select "PC", then press the **ENTER** button.  
➤ Change to the PC mode first.
2. Press the **▲** or **▼** button to select "Image Reset", then press the **ENTER** button.  
Press the **EXIT** button to exit.

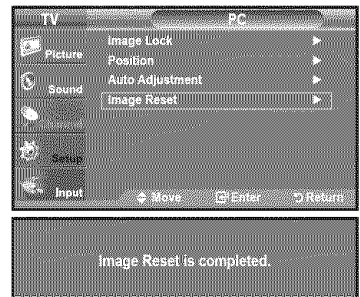

## Setting the Home Theater PC

This function enables you to view higher quality pictures while in PC Mode. After setting the Home Theater PC function to On, you can go into the Detailed Settings menu and make adjustments without affecting settings in the regular TV mode.

1. Press the **MENU** button to display the menu.  
Press the **▲** or **▼** button to select "Setup", then press the **ENTER** button.
2. Press the **▲** or **▼** button to select "Home Theater PC", then press the **ENTER** button.
3. Press the **▲** or **▼** button to select "On" or "Off", then press the **ENTER** button.

- **Off:** Turns off the settings for screen-related functions in PC input mode.
- **On:** Turns on the settings for screen-related functions in PC input mode to provide more dynamic scenes.

Press the **EXIT** button to exit.

- This function is available only in PC mode.

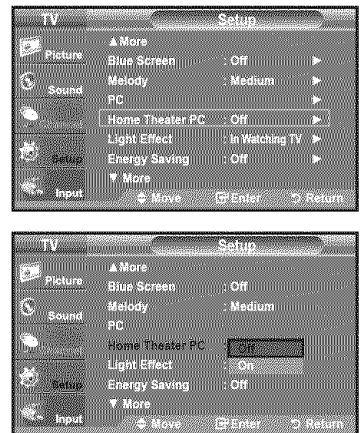



## Time Setting

### Setting the Clock

Setting the clock is necessary in order to use the various timer features of the TV. Also, you can check the time while watching the TV. (Just press the **INFO** button.)

#### Option 1: Setting the Clock Manually

1. Press the **MENU** button to display the menu.  
Press the **▲** or **▼** button to select "Setup", then press the **ENTER** button.  
Press the **▲** or **▼** button to select "Time", then press the **ENTER** button.
2. Press the **ENTER** button to select "Clock".
3. Press the **ENTER** button to select "Clock Mode".  
Press the **▲** or **▼** button to select "Manual", then press the **ENTER** button.
4. Press the **▲** or **▼** button to select "Clock Set", then press the **ENTER** button.
5. Press the **◀** or **▶** button to move to "Month", "Day", "Year", "Hour", "Minute", or "am/pm". Set the date and time you want by pressing the **▲** or **▼** button, then press the **ENTER** button.  
Press the **EXIT** button to exit.
  - > The current time will appear every time you press the **INFO** button.
  - > You can set the month, day, year, hour and minute directly by pressing the number buttons on the remote control.

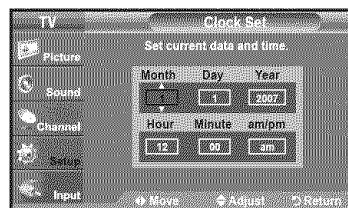
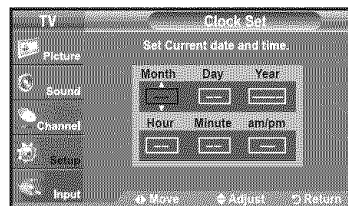
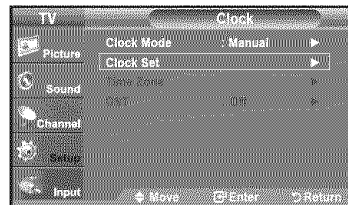
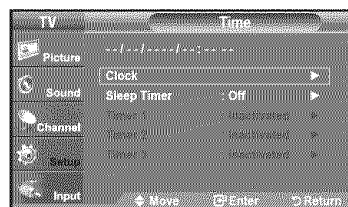

## Option 2: Setting the Clock Automatically

The Clock can be set automatically if you are receiving a digital signal.

1. Press the **MENU** button to display the menu.  
Press the **▲** or **▼** button to select "Setup", then press the **ENTER** button.  
Press the **▲** or **▼** button to select "Time", then press the **ENTER** button.
2. Press the **ENTER** button to select "Clock".
3. Press the **ENTER** button to select "Clock Mode".  
Press the **▲** or **▼** button to select "Auto", then press the **ENTER** button.
4. Press the **▲** or **▼** button to select "Time Zone", then press the **ENTER** button.
5. Press the **▲** or **▼** button to highlight the time zone for your local area,  
then press the **ENTER** button.
6. Press the **▲** or **▼** button to select "DST" (Daylight Saving Time), then press  
the **ENTER** button.  
Press the **▲** or **▼** button to select "On" or "Off", then press the **ENTER** button.  
Press the **EXIT** button to exit.
  - Depending on the broadcast station and signal, the auto time may not be set correctly. If this occurs, set the time manually.
  - The Antenna or cable must be connected in order to set the time automatically.

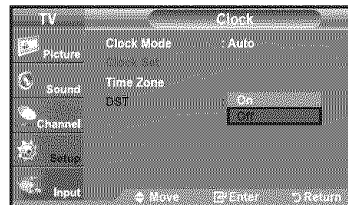
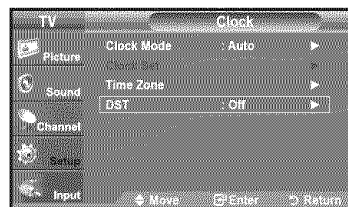
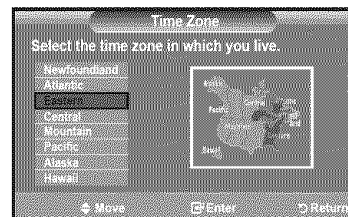
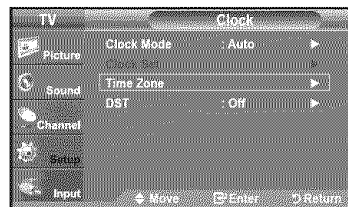
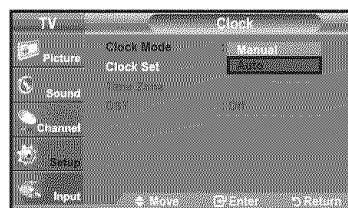
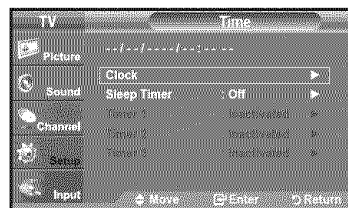
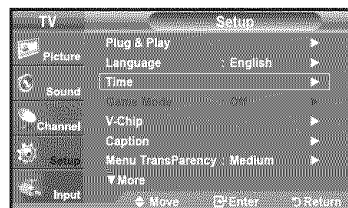

## Setting the Sleep Timer

The sleep timer automatically shuts off the TV after a preset time (30, 60, 90, 120, 150 and 180 minutes).

1. Press the **MENU** button to display the menu.  
Press the **▲** or **▼** button to select "Setup", then press the **ENTER** button.  
Press the **▲** or **▼** button to select "Time", then press the **ENTER** button.
2. Press the **▲** or **▼** button to select "Sleep Timer", then press the **ENTER** button.
3. Press the **▲** or **▼** button to adjust "Minute".
4. Press the **▶** button to select "Activation".  
Press the **▲** or **▼** button to select "On", then press the **ENTER** button.  
Press the **EXIT** button to exit.

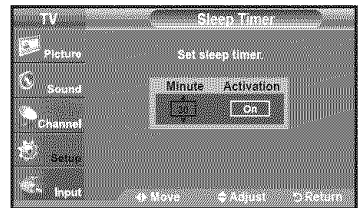
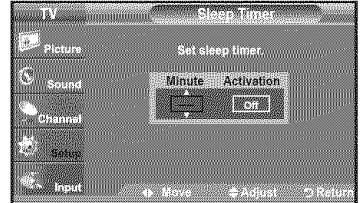
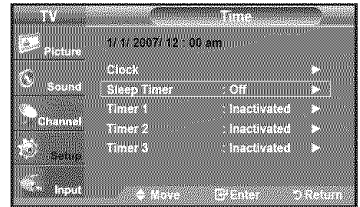

-  Simply press the **SLEEP** button on the remote control for a Quick way to access the sleep timer setting.

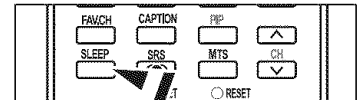

## Setting the On/Off Timer

1. Press the **MENU** button to display the menu.  
Press the **▲** or **▼** button to select "Setup", then press the **ENTER** button.  
Press the **▲** or **▼** button to select "Time", then press the **ENTER** button.
2. Press the **▲** or **▼** button to select "Timer 1", "Timer 2" or "Timer 3", then press the **ENTER** button.
3. Press the **▲** or **▼** button to adjust "Hour", then press the **▶** button to move to the next step.

Set other items using the same method as above.

	Activate or inactivate	Press the <b>▲</b> or <b>▼</b> button
Repeat	Select Once, Everyday, Mon-Fri, Mon-Sat, Sat-Sun Sets the desired day(s) of the week you want the TV to turn on.	Press the <b>▲</b> or <b>▼</b> button
Volume	Select the desired turn on volume level.	Press the <b>▲</b> or <b>▼</b> button
Contents	When the On Timer is active, you can turn on a specific channel or play back contents such as photo or audio files. (Make sure that an USB device is connected to your TV.)	Press the <b>▲</b> or <b>▼</b> button

➤ You can set the hour, minute and channel by pressing the number buttons on the remote control.

### ➤ Auto Power Off

When you set the timer On, the television will eventually turn off, if no controls are operated for 3 hours after the TV was turned on by timer. This function is only available in timer On mode and prevents overheating, which may occur if a TV is on for too long time.

Press the **EXIT** button to exit.

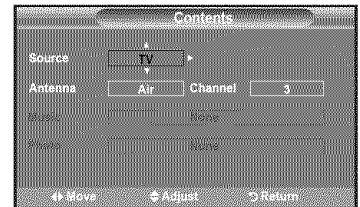
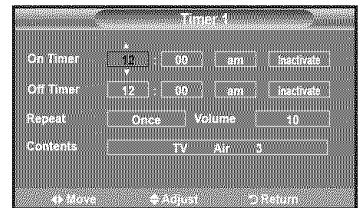
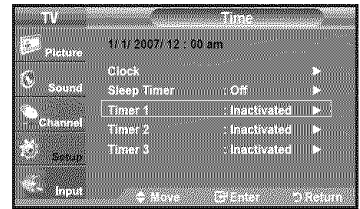

## Function Description

### Selecting a Menu Language

1. Press the **MENU** button to display the menu.  
Press the **▲** or **▼** button to select "Setup", then press the **ENTER** button.  
Press the **▲** or **▼** button to select "Language", then press the **ENTER** button.
2. Press the **▲** or **▼** button to select "English", "Español" or "Français".  
Press the **ENTER** button.  
Press the **EXIT** button to exit.

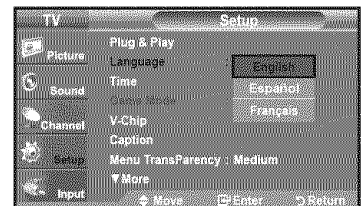

## Setting the Blue Screen Mode

If no signal is being received or the signal is very weak, a blue screen automatically replaces the noisy picture background. If you wish to continue viewing the poor picture, you must set the "Blue Screen" mode to "Off".

1. Press the **MENU** button to display the menu.  
Press the **▲** or **▼** button to select "Setup", then press the **ENTER** button.
2. Press the **▲** or **▼** button to select "Blue Screen", then press the **ENTER** button.
3. Press the **▲** or **▼** button to select "On" or "Off" then press the **ENTER** button.  
Press the **EXIT** button to exit.
  - > Blue Screen is displayed when there is no signal from an external device, regardless of the "Blue Screen" setting.

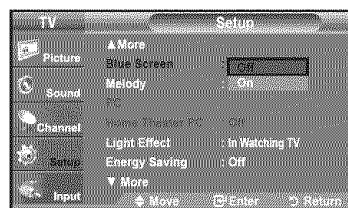
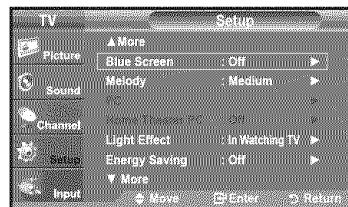

## Using the Game Mode

When connecting to a game console such as PlayStation™ or Xbox™, you can enjoy a more realistic gaming experience by selecting the game menu.

1. Press the **MENU** button to display the menu.  
Press the **▲** or **▼** button to select "Setup", then press the **ENTER** button.
2. Press the **▲** or **▼** button to select "Game Mode", then press the **ENTER** button.
3. Select "On" or "Off" by pressing the **▲** or **▼** button, then press the **ENTER** button.
4. Press the **EXIT** button to exit.
  - > Restrictions on "Game mode" (Caution)
    - To disconnect the game console and connect another external device, set "Game" to Off in the setup menu.
    - If you display the TV menu in "Game mode", the screen shakes slightly.
    - The mark (🎮) appears on the screen which means that "Game Mode" is on with the selected source.
  - > If "Game Mode" is On
    - Picture Mode is automatically changed to "Standard" and users cannot change the mode.
    - Sound Mode is automatically changed to "Custom" and users cannot change the mode. Adjust the sound using the equalizer.
    - The "Reset" in the Sound menu is activated. "Reset" function initializes the "Equalizer" settings to the factory default setting.
  - > "Game Mode" is not available in regular TV/Antenna mode.
  - > If the picture is poor when external device is connected to TV, check if "Game Mode" is "On". Set "Game Mode" to "Off" and connect external devices.

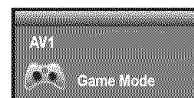
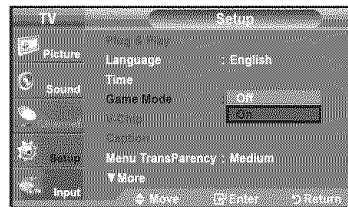
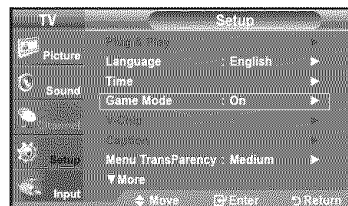

## Viewing Closed Captions (On-Screen Text Messages) - Analog

The Analog Caption function operates in either analog TV channel mode or external signal mode.  
(Depending on the broadcasting signal, the Analog Caption function may operate on digital channels.)

1. Press the **MENU** button to display the menu.  
Press the **▲** or **▼** button to select "Setup", then press the **ENTER** button.
2. Press the **▲** or **▼** button to select "Caption", then press the **ENTER** button.
3. Press the **ENTER** button to select "Caption".  
Press the **▲** or **▼** button to select "On", then press the **ENTER** button.

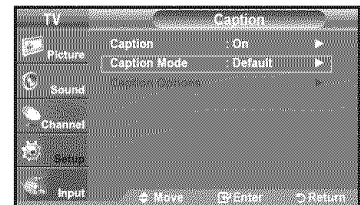
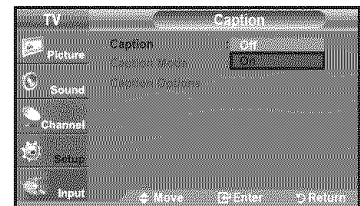
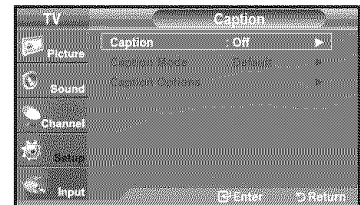
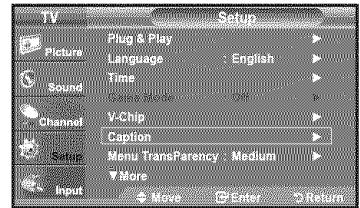

4. Press the **▲** or **▼** button to select "Caption Mode", then press the **ENTER** button.  
Press the **▲** or **▼** button to select submenu (Default, CC1~CC4 or Text1~Text4) you want, then press the **ENTER** button.

Press the **EXIT** button to exit.

- **The default is "CC1".**
- **CC1:** The Primary Synchronous Caption Service. These are captions in the primary language that must be in sync with the sound, preferably matched to a specific frame.
- **CC2:** The Special Non-Synchronous Use Captions. This channel carries data that is intended to augment information carried in the program.
- **CC3:** Secondary Synchronous Caption Service. Alternate program-related caption data, typically second language captions.
- **CC4:** Special Non-Synchronous Use Captions. Similar to CC2.
- **Text1:** First Text Service. This may be various non-program related data.
- **Text2:** Second Text Service. Additional data, usually not program related.
- **Text3/Text4:** Third and Fourth Text Services. These data channels should be used only if Text1 and Text2 are not sufficient.

- The Caption feature doesn't work in Component, HDMI or PC modes.
- The availability of captions depends on the program being broadcast.

- 📌 Press the **CAPTION** button on the remote control to select "On" or "Off".

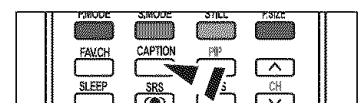

## Viewing Closed Captions (On-Screen Text Messages) - Digital

The Digital Captions function operates on digital channels.

1. Press the **MENU** button to display the menu.  
Press the **▲** or **▼** button to select "Setup", then press the **ENTER** button.
2. Press the **▲** or **▼** button to select "Caption", then press the **ENTER** button.
3. Press the **ENTER** button to select "Caption".  
Press the **▲** or **▼** button to select "On", then press the **ENTER** button.
4. Press the **▲** or **▼** button to select "Caption Mode", then press the **ENTER** button.  
Press the **▲** or **▼** button to select submenu (Default, Service1~Service6, CC1~CC4 or Text1~Text4) you want, then press the **ENTER** button.

5. Press the **▲** or **▼** button to select "Caption Options", then press the **ENTER** button.
  - > "Caption Options" are available only when "Service1~Service6" can be selected in "Caption Mode".
  - > Service1~6 in digital caption mode may not be available depending on the broadcast.
6. Press the **▲** or **▼** button to select "Size", then press the **ENTER** button.  
Press the **▲** or **▼** button to select the desired Caption option, then press the **ENTER** button.  
Press the **▲** or **▼** button to select the desired sub-menu options (see options below), then press **ENTER**.

Press the **EXIT** button to exit.

- > The availability of captions depends on the program being broadcast.
- > "Default" means to follow the standard set by the broadcaster.
- > Foreground and Background cannot be set to have the same color.
- > Foreground Opacity and Background Opacity cannot be both set to Transparent.

- **Size:** This option consists of "Default", "Small", "Standard" and "Large". The default is "Standard".
- **Font Style:** This option consists of "Default", "Style0 ~ Style 7". You can change the font you want. The default is "Style 0".
- **Foreground Color:** This option consists of "Default", "White", "Black", "Red", "Green", "Blue", "Yellow", "Magenta" and "Cyan". You can change the color of the letter. The default is "White".
- **Background Color:** This option consists of "Default", "White", "Black", "Red", "Green", "Blue", "Yellow", "Magenta" and "Cyan". You can change the background color of the caption. The default is "Black".
- **Foreground Opacity:** This option consists of "Default", "Transparent", "Translucent", "Solid" and "Flashing". You can change the opacity of the letter.
- **Background Opacity:** This option consists of "Default", "Transparent", "Translucent", "Solid", and "Flashing". You can change the background opacity of the caption.
- **Return to Default:** This option sets each of "Size", "Font Style", "Foreground Color", "Background Color", "Foreground Opacity" and "Background Opacity" to its default.

- ☐ Press the **CAPTION** button on the remote control to select "On" or "Off".

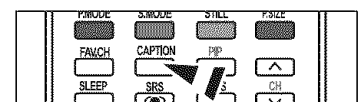
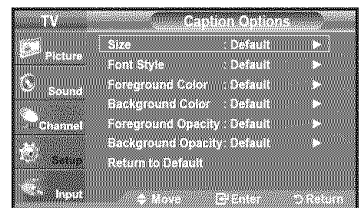
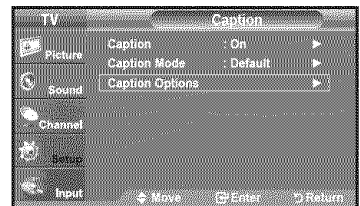
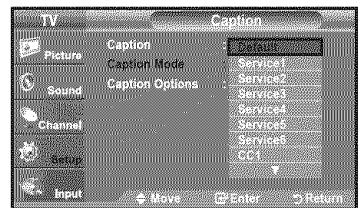
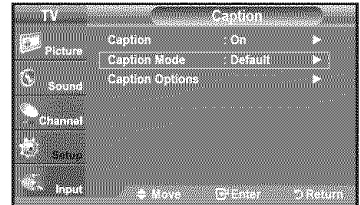
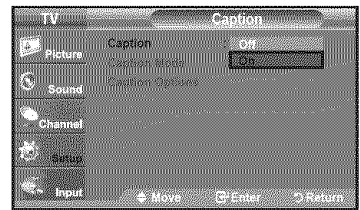

## Menu Transparency Level

Adjusts the transparency of the menu screen.

1. Press the **MENU** button to display the menu.  
Press the **▲** or **▼** button to select "Setup", then press the **ENTER** button.
2. Press the **▲** or **▼** button to select "Menu Transparency", then press the **ENTER** button.
3. Press the **▲** or **▼** button to select level, then press the **ENTER** button.  
Press the **EXIT** button to exit.

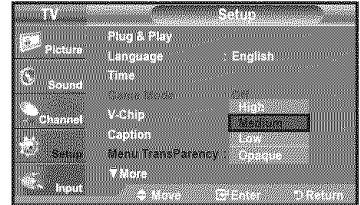
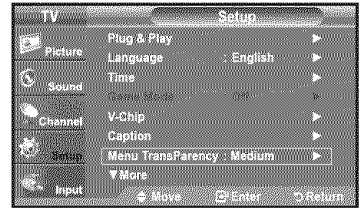

## Using the Energy Saving Feature

This feature adjusts the brightness of the TV in order to reduce power consumption. When watching TV at night, set the "Energy Saving" mode option to "High" to reduce eye fatigue as well as power consumption.

1. Press the **MENU** button to display the menu.  
Press the **▲** or **▼** button to select "Setup", then press the **ENTER** button.
2. Press the **▲** or **▼** button to select "Energy Saving", then press the **ENTER** button.  
Select the required option (Off, Low, Medium, High, Auto) by pressing the **▲** or **▼** button.  
Press the **ENTER** button.

- **Off:** Turns off the energy saving function.
- **Low:** Sets the TV to low energy saving mode.
- **Medium:** Sets the TV to medium energy saving mode.
- **High:** Sets the TV to high energy saving mode.
- **Auto:** Automatically adjusts the brightness of the TV screen in accordance with the scenes.

Press the **EXIT** button to exit.

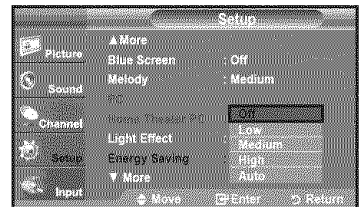
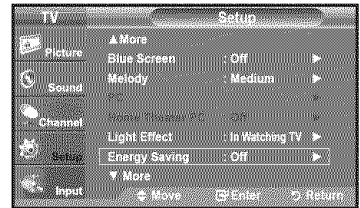



## Setting the Function Help

Displays help on the menu functions.

1. Press the **MENU** button to display the menu.  
Press the **▲** or **▼** button to select "Setup", then press the **ENTER** button.
2. Press the **▲** or **▼** button to select "Function Help", then press the **ENTER** button.
3. Press the **▲** or **▼** button to select "On", then press the **ENTER** button.  
Press the **EXIT** button to exit.
  - The predetermined value of the "Function Help" is On.

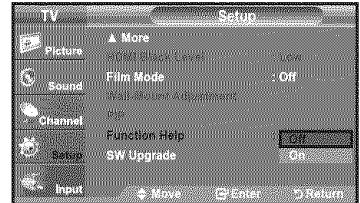
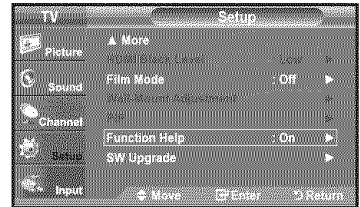

## Digital Noise Reduction

If the broadcast signal received by your TV is weak, you can activate the Digital Noise Reduction feature to help reduce any static and ghosting that may appear on the screen.

1. Press the **MENU** button to display the menu.  
Press the **ENTER** button to select "Picture".
2. Press the **▲** or **▼** button to select "Digital NR", then press the **ENTER** button.
3. Press the **▲** or **▼** button to select "Off", "Low", "Medium", "High", "Auto".  
Press the **ENTER** button.

- **Off**: Turns the screen noise reduction function off.
- **Low**: Reduces screen noise at a low level.
- **Medium**: Reduces screen noise at a medium level.
- **High**: Reduces screen noise at a high level.
- **Auto**: Automatically recognizes and reduces screen noise.

Press the **EXIT** button to exit.

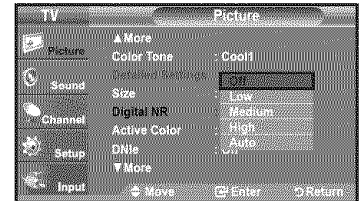
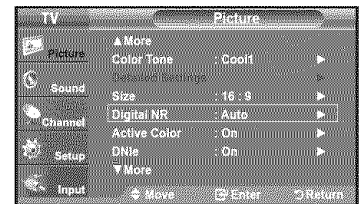

## Using the V-Chip

The V-Chip feature automatically locks out programs that are deemed inappropriate for children. The user must enter a PIN (personal ID number) before any of the V-Chip restrictions are set up or changed.

> When the V-chip feature is activated, the PIP features do not function.

### U.S.A Only

This product is covered by the following U.S.patents :US4,930,158,US4,930,160

### Setting Up Your Personal ID Number (PIN)

1. Press the **MENU** button to display the menu.  
Press the **▲** or **▼** button to select "Setup", then press the **ENTER** button.
2. Press the **▲** or **▼** button to select "V-Chip", then press the **ENTER** button.  
The message "Enter PIN" will appear. Enter your 4 digit PIN number.  
> The default PIN number of a new TV set is "0-0-0-0".

3. The "V-Chip" screen will appear.  
Press the **▲** or **▼** button to select "Change PIN", then press the **ENTER** button.  
The Change PIN screen will appear. Choose any 4 digits for your PIN and enter them. As soon as the 4 digits are entered, the "Confirm new PIN" screen appears. Re-enter the same 4 digits. When the Confirm screen disappears, your PIN has been memorized.

Press the **EXIT** button to exit.

> If you forget the PIN, press the remote-control buttons in the following sequence, which resets the pin to 0-0-0-0 : Power Off. → Mute → 8 → 2 → 4 → Power On.

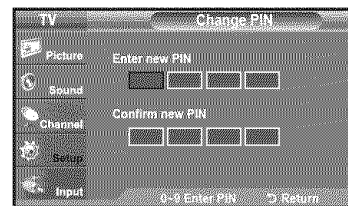
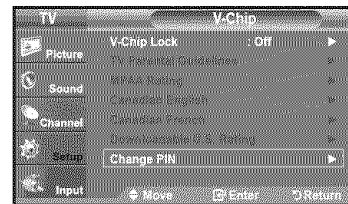
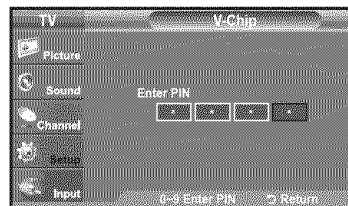

## How to Enable/Disable the V-Chip

1. Press the **MENU** button to display the menu.  
Press the **▲** or **▼** button to select "Setup", then press the **ENTER** button.
2. Press the **▲** or **▼** button to select "V-Chip", then press the **ENTER** button.  
The message "Enter PIN" will appear. Enter your 4 digit PIN number.
3. The "V-Chip" screen will appear.  
To enable the V-Chip feature, press the **ENTER** button so that the "V-Chip Lock" field is "On". (Pressing the **▲** or **▼** button will alternate between "On" and "Off").  
Press the **ENTER** button.  
Press the **EXIT** button to exit.

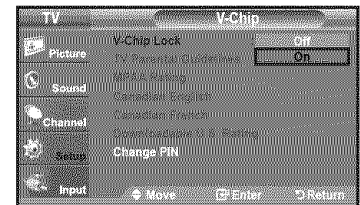
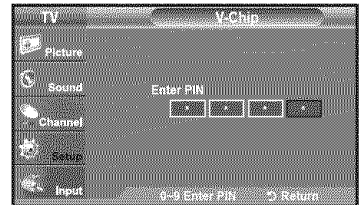
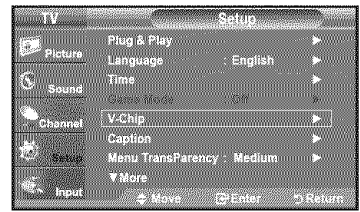

## How to Set up Restrictions Using the "TV Parental Guidelines"

First, set up a personal identification number (PIN) and enable the V-Chip. (See previous section.) Parental restrictions can be set up using either of two methods: The TV guidelines or the MPAA rating.

1. Press the **MENU** button to display the menu.  
Press the **▲** or **▼** button to select "Setup", then press the **ENTER** button.
2. Press the **▲** or **▼** button to select "V-Chip", then press the **ENTER** button.  
The message "Enter PIN" will appear. Enter your 4 digit PIN number.

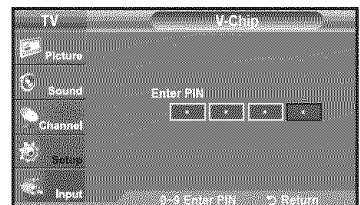

- The "V-Chip" screen will appear. Press the ▲ or ▼ button to select "TV Parental Guidelines", then press the ENTER button.

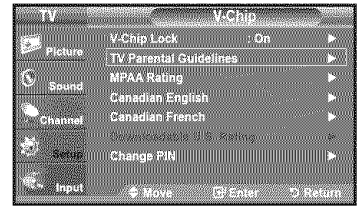

- The "TV Parental Guidelines" screen will appear. Press the ▲ or ▼ button to select one of the six aged based categories:

- TV-Y: Young children
- TV-Y7: Children 7 and over
- TV-G: General audience
- TV-PG: Parental guidance
- TV-14: Viewers 14 and over
- TV-MA: Mature audience

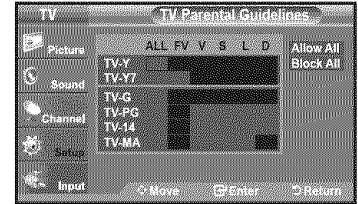

- At this point, one of the TV-Ratings is selected. Press the ENTER button. Depending on your existing setup, the "🔒" symbol will be selected. (Blank = Unblocked, 🔒 = Blocked) While "🔒" is selected, press the ENTER button to block or unblock the category. To select a different TV-Rating, press the ▲ or ▼ button and then repeat the process.

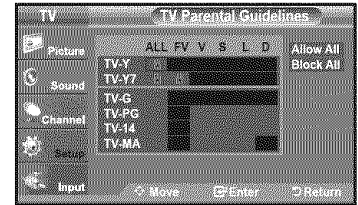

- Allow all: Press to unlock all TV ratings. / Block all: Press to lock all TV ratings.
- The TV-Y, TV-Y7, TV-G, TV-PG, TV-14 and TV-MA have additional options. See the next step to change any of the following sub-ratings:  
FV: Fantasy violence / D: Sexually Suggestive Dialog / L: Adult Language / S: Sexual situation / V: Violence
- The V-chip will automatically block certain categories that are "more restrictive". For example, if you block "TV-Y" category, then TV-Y7 will automatically be blocked. Similarly, if you block the TV-G category, then all the categories in the "young adult" group will be blocked (TV-G, TV-PG, TV-14 and TV-MA). The sub-ratings (D, L, S, V) work together similarly. (See next section.)

- How to set the FV, D, L, S and V sub-ratings. First, select one of these TV-Ratings: TV-Y, TV-Y7, TV-G, TV-PG, TV-14 or TV-MA (See Step 4) and press the ► button. The "🔒" symbol will be displayed for each sub-rating. While "🔒" is selected, press the ENTER button to go to a sub rating. Press ENTER to block the sub rating. To select a different TV-Rating, press the ▲ or ▼ button and then repeat the process.
  - The V-chip will automatically block certain categories that are "More restrictive". For example, if you block "L" sub-rating in TV-PG, then the "L" sub-ratings in TV-14 and TV-MA will automatically be blocked.

- Press the EXIT button to clear all the screens. (Or proceed to the next section, and set up additional restrictions based on the MPAA codes.)
  - These categories consist of two separate groups: TV-Y and TV-Y7 (young children through age 7) and TV-G through TV-MA (everybody else). The restrictions for these two groups work independently: If a household includes very young children as well as young adults, the TV guidelines must be set up separately for each age group. (See next step.)

## How to Set up Restrictions Using the MPAA Ratings: G, PG, PG-13, R, NC-17, X, NR

The MPAA rating system uses the Motion Picture Association of America (MPAA) system and its main application is for movies. When the V-Chip lock is on, the TV will automatically block any programs that are coded with objectionable ratings (either MPAA or TV-Ratings).

1. Press the **MENU** button to display the menu.  
Press the **▲** or **▼** button to select "Setup", then press the **ENTER** button.
2. Press the **▲** or **▼** button to select "V-Chip", then press the **ENTER** button.  
The message "Enter PIN" will appear. Enter your 4 digit PIN number.
3. The "V-Chip" screen will appear. Press the **▲** or **▼** button to select "MPAA Rating", then press the **ENTER** button.

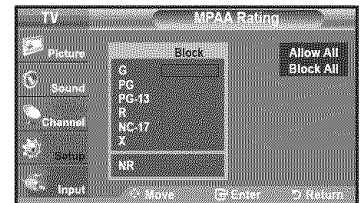
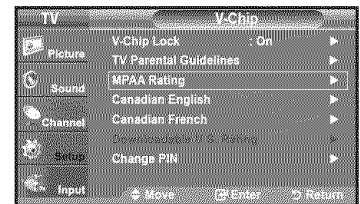
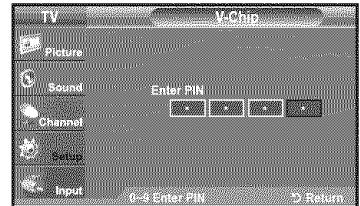
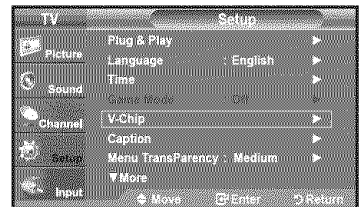

4. The "MPAA Rating" screen will appear. Repeatedly press the **▲** or **▼** button to select a particular MPAA category. Pressing the **▲** or **▼** button will cycle through the MPAA categories:

- **G**: General audience (no restrictions).
- **PG**: Parental guidance suggested.
- **PG-13**: Parents strongly cautioned.
- **R**: Restricted. Children under 17 should be accompanied by an adult.
- **NC-17**: No children under age 17.
- **X**: Adults only.
- **NR**: Not rated.

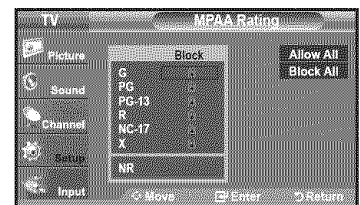

- Allow all: Press to unlock all TV ratings. / Block all: Press to lock all TV ratings.
- While a particular category is selected, press the **ENTER** button to activate it. The "🔒" symbol will be displayed. Press the **ENTER** button to block or unblock the category.
- The V-Chip will automatically block any category that is "more restrictive". For example, if you block the "PG-13" category, then "R", "NC-17" and "X" will automatically be blocked also.

Press the **EXIT** button to exit.

## How to Set up Restrictions Using the 'Canadian English'

1. Press the **MENU** button to display the menu.  
Press the **▲** or **▼** button to select "Setup", then press the **ENTER** button.
2. Press the **▲** or **▼** button to select "V-Chip", then press the **ENTER** button.  
The message "Enter PIN" will appear. Enter your 4 digit PIN number.

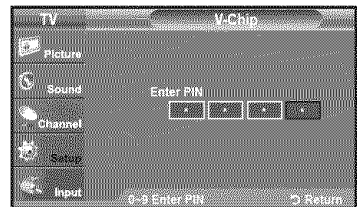
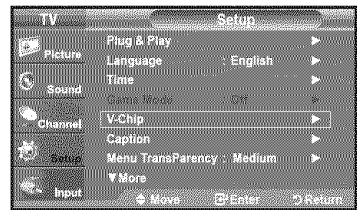

3. The "V-Chip" screen will appear. Press the **▲** or **▼** button to select "Canadian English", then press the **ENTER** button.



4. Press the **▲** or **▼** button to select a appropriate restriction.  
Press the **ENTER** button to activate the restriction selected. The "🔒" symbol is indicated.

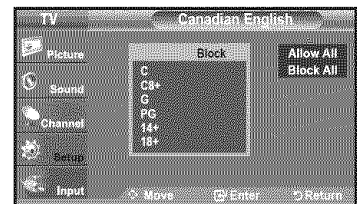

Press the **EXIT** button to exit.

- Allow all: Press to unlock all TV ratings. / Block all: Press to lock all TV ratings.

- **C**: Programming intended for children under age 8.
- **C8+**: Programming generally considered acceptable for children 8 years and over to watch on their own.
- **G**: General programming, suitable for all audiences.
- **PG**: Parental Guidance.
- **14+**: Programming contains themes or content which may not be suitable for viewers under the age of 14.
- **18+**: Adult programming.

- The V-Chip will automatically block any category that is "more restrictive".  
For example, if you block G category, then PG, 14+ and 18+ will automatically be blocked also.

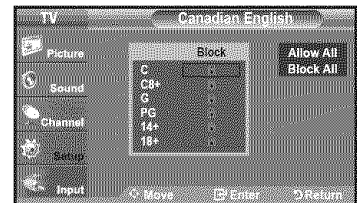

## How to Set up Restrictions Using the 'Canadian French'

1. Press the **MENU** button to display the menu.  
Press the **▲** or **▼** button to select "Setup", then press the **ENTER** button.
2. Press the **▲** or **▼** button to select "V-Chip", then press the **ENTER** button.  
The message "Enter PIN" will appear. Enter your 4 digit PIN number.

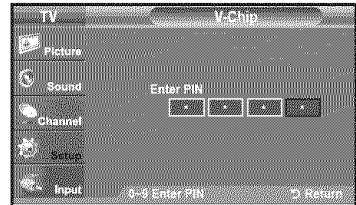
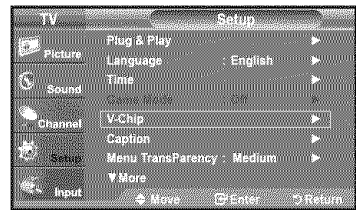

3. The "V-Chip" screen will appear. Press the **▲** or **▼** button to select "Canadian French", then press the **ENTER** button.

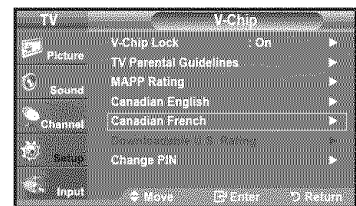

4. Press the **▲** or **▼** button to select an appropriate restriction.  
Press the **ENTER** button to activate the restriction. The "🔒" symbol is indicated.

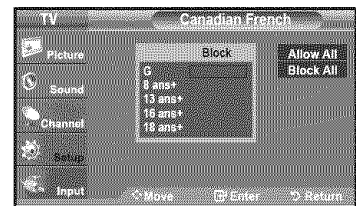

Press the **EXIT** button to exit.

➤ Allow all: Press to unlock all TV ratings. / Block all: Press to lock all TV ratings.

- **G:** General
- **8 ans+:** Programming generally considered acceptable for children 8 years and over to watch on their own.
- **13 ans+:** Programming may not be suitable for children under the age of 13.
- **16 ans+:** Programming is not suitable for children under the age of 16.
- **18 ans+:** Programming restricted to adults.

➤ The V-Chip will automatically block any category that is "more restrictive".  
For example, if you block 8 ans+ category, then 13 ans+, 16 ans+ and 18 ans+ will automatically be blocked also.

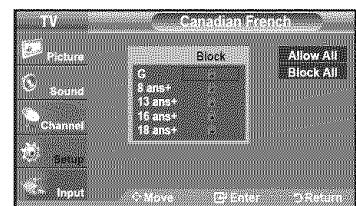

## Using the V-Chip for Digital channels

Parental restriction information can be used while watching DTV channels.

- Press the **MENU** button to display the menu.  
Press the **▲** or **▼** button to select "Setup", then press the **ENTER** button.
- Press the **▲** or **▼** button to select "V-Chip", then press the **ENTER** button.  
The message "Enter PIN" will appear. Enter your 4 digit PIN number.
- The "V-Chip" screen will appear. Press the **▲** or **▼** button to select "Downloadable U.S. Rating", then press the **ENTER** button.
  - If information is not downloaded from the broadcasting station, the Downloadable U.S. rating menu is deactivated.
  - Parental restriction information is automatically downloaded while watching DTV channels. It may take several seconds.
  - The Downloadable U.S. rating menu is available for use after information is downloaded from the broadcasting station. However, depending on the information from the broadcasting station, it may not be available for use.
- Press the **▲** or **▼** button to select a appropriate restriction.  
Press the **ENTER** button to activate the restriction selected. The "🔒" symbol is indicated.  
Press the **EXIT** button to exit.
  - Allow all: Press to unlock all TV ratings. / Block all: Press to lock all TV ratings.
  - Parental restriction levels differ depending on the broadcasting station.
  - The default menu name and Downloadable US rating changes depending on the downloaded information.
  - Even if you set the On-screen display to your desired language, the "Downloadable U.S. Rating" menu will appear in English only.
  - The rating will automatically block certain categories that are more restrictive.
  - The rating titles (For example: Humor Level..etc) and TV ratings (For example: DH,MH,H..etc) may differ depending on the broadcasting station.

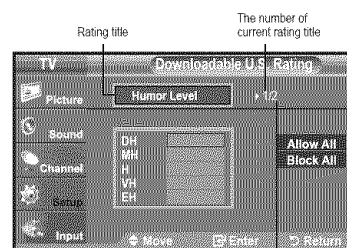
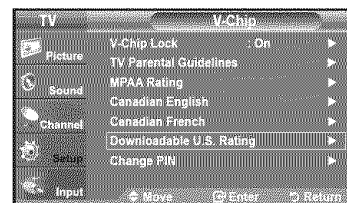
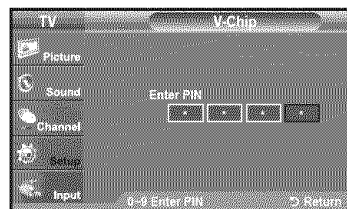
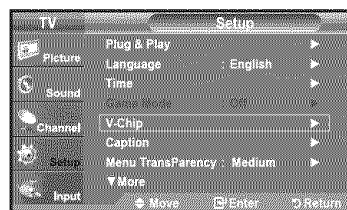

The number of all rating title

## How to Reset the TV after the V-Chip Blocks a Channel ("Emergency Escape")

If the TV is tuned to a restricted channel, the V-Chip will block it. The screen will go blank and the following message will appear:

- Enter your PIN.  
To resume normal viewing, tune to a different channel using **CH** or **CH** button. Under certain conditions (depending on the rating of the local TV programs) the V-Chip might lock out all the channels. In this case, use the V-Chip function for an "emergency escape":
- Press the **MENU** button. Press the **▲** or **▼** button to select "Setup", then press the **ENTER** button.
- Press the **▲** or **▼** button to select "V-Chip", then press the **ENTER** button.
- Enter your PIN, then press the **ENTER** button and press the **▲** or **▼** button to temporarily disable the V-Chip Lock.
  - If you forget the PIN, press the remote-control buttons in the following sequence, which resets the pin to 0-0-0-0 : Power Off. → MUTE → 8 → 2 → 4 → Power On.

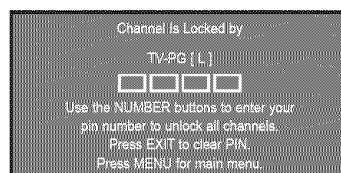
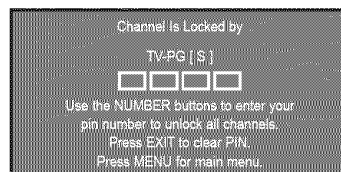



## Setting the Light Effect

You can turn the LED on the front of TV on/off.

1. Press the **MENU** button to display the menu.  
Press the **▲** or **▼** button to select "Setup", then press the **ENTER** button.
2. Press the **▲** or **▼** button to select "Light Effect", then press the **ENTER** button.
3. Press the **▲** or **▼** button to select "Off", "In Standby", "In Watching TV" or "Always", then press the **ENTER** button.

- **Off:** LED will not come on.
- **In Standby:** Turns the LED on in standby mode.
- **In Watching TV:** Turns the LED on while watching TV.
- **Always:** LED will come on after you turn the TV off.

Press the **EXIT** button to exit.

- Set the "Light Effect" to "Off" to reduce power consumption.

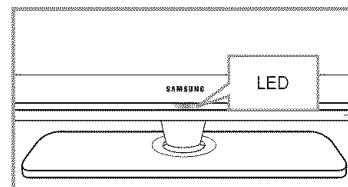
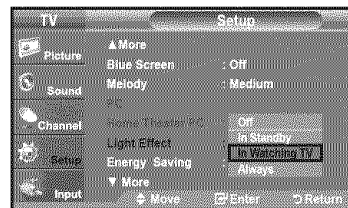
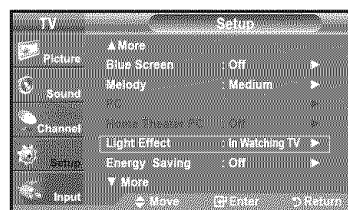

## Upgrading the Software

Samsung may offer upgrades for TV's firmware in the future. Please contact the Samsung call center at 1-800-SAMSUNG (726-7864) to receive information about downloading upgrades and using a USB drive. Upgrades will be possible by connecting a USB drive to the USB port located on located on the side of your TV.

1. Insert a USB drive containing the firmware upgrade into the WISELINK port on the side of the TV.
2. Press the **MENU** button to display the menu.  
Press the **▲** or **▼** button to select Setup, then press the **ENTER** button.
3. Press the **▲** or **▼** button to select Software upgrade, then press the **ENTER** button.
4. Press the **ENTER** button.

The message Scanning for USB... It may take up to 30 seconds. is displayed. Please be careful to not disconnect the power or remove the USB drive while upgrades are being applied. The TV will turn off and turn on automatically after completing the firmware upgrade. Please check the firmware version after the upgrades are complete.

When software is upgraded, video and audio settings you have made will return to their default (factory) settings. We recommend you write down your settings so that you can easily reset them after the upgrade.

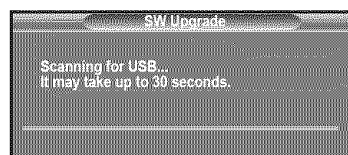
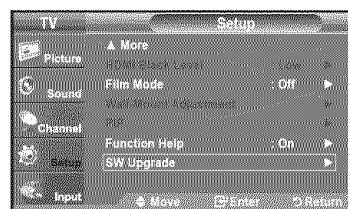
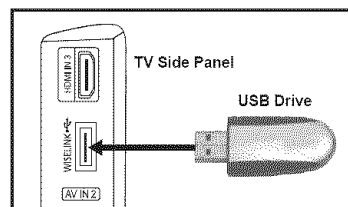

# WISELINK

## Using the WISELINK Function





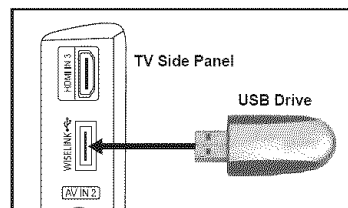



This function enables you to view and listen to photo (JPEG) and audio files (MP3) saved on a USB Mass Storage Class (MSC) device.

Press the **POWER** button on the remote control or front panel.  
Connect a USB device containing JPEG and/or MP3 files to the WISELINK jack (USB jack) on the side of the TV.



- If you enter the WISELINK mode with no USB device connected the message "There is no device connected" will appear. In this case, insert the USB device, exit the screen by pressing the WISE LINK button on the remote control and enter the WISELINK screen again.
- Photo and audio files must be named in English, French or Spanish. If not, the files can not be played. Change the file names to English, French, or Spanish if necessary.
- The file system only supports FAT16/32 (The NTFS file system is not supported)
- Certain types of USB devices may not be compatible with this TV.
- Wiselink only supports the USB Mass Storage Class device (MSC). MSC is a Mass Storage Class Bulk-Only Transport device. Examples of MSC are Thumb drives and Flash Card Readers (Both USB HDD and HUB are not supported.)
- Before connecting your device to the TV, please back up your files to prevent them from damage or loss of data. SAMSUNG is not responsible for any data file damage or data loss.
- Recommended image resolution for Wiselink is 6 mega pixels.
- Please connect directly to the USB port of your TV. If you are using a separate cable connection, there may be a USB Compatibility problem.
- Only MP3 and JPEG file formats are supported.
- We recommend the sequential jpeg format. Progressive jpeg uses a lot of memory and decoding may fail.
- Do not disconnect the USB device while it is "loading."
- Neither PTP (Picture Transfer Protocol) nor MTP (Media Transfer Pprotocol) is supported.
- The playing duration of an mp3 file may be displayed as '00:00:00' if its playing time information is not found at the start of the file.
- The higher the resolution of the image, the longer it takes to display on the screen.
- If the horizontal resolution of an image is higher than 5000, it cannot be decoded.
- If the vertical resolution of an image is higher than 4000, it cannot be decoded.

### Using the Remote Control Button in WISELINK Menu

Button	Operations
	Move the cursor and select an item
	Select the currently selected item.
	Play or pause the Slide Show or MP3 file.
	Return to the previous menu
	Run various functions from the Photo and Music menus.
	Stop the current slide show or MP3 file.
	Page Up or Down (file list item)
	Stop the current function and return to the previous high-level menu.

## Using the WISELINK Menu

1. Press the **MENU** button. Press the **▲** or **▼** button to select "Input", then press the **ENTER** button.
2. Press the **▲** or **▼** button to select "WISELINK", then press the **ENTER** button.

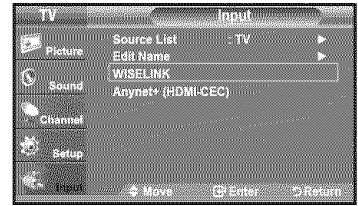

3. Press the **▲** or **▼** button to select the corresponding USB Memory Device, then press the **ENTER** button.
  - The **WISELINK** menu differs depending on the USB Memory Device connected to TV.

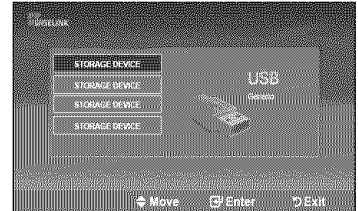

4. Press the **◀** or **▶** button to move to an icon, then press the **ENTER** button.
  - To exit WISELINK mode, press the **WISELINK** button on the remote control.

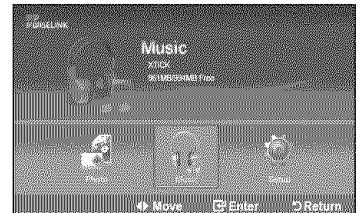

-  Press the **WISELINK** button on the remote control to display a WISELINK menu.

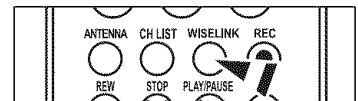

## Using the PHOTO (JPEG) List

This menu shows JPEG files and folders saved on an USB memory device.

1. Complete Steps 1 to 3 of "Using the WISELINK Menu". (Refer to page 65)
2. Press the ◀ or ▶ button to move to "Photo", then press the ENTER button. The saved file information is displayed as a folder or file.

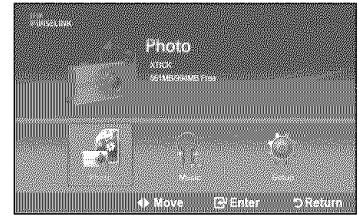

3. Press the ▲, ▼, ◀ and ▶ buttons to select a file, then press the ENTER button.
  - Pressing the ENTER button over a photo icon shows the currently selected photo in full screen.
  - Pressing the ENTER button over a folder icon shows the JPEG files included in the folder.

To exit WISELINK mode, press the WISELINK button on the remote control.



- Moving to a photo may take a few seconds to load the file. At this point, the  icon will appear at the top left of the screen.
- This menu only shows files whose file extension is jpg. Files of other formats such as bmp or tiff will not be displayed.
- The files are displayed on a page. 15 thumbnail photos are displayed per page.
- The thumbnails are numbered from left to right and from top to bottom, from 1 to 15.
- Certain types of USB Digital camera and audio devices may not be compatible with this TV.
- Folders are displayed first and they are followed by all JPEG files in the current folder. The folders and JPEG files are sorted in alphabetical order.
- If the photo is displayed in full screen, you can zoom in and out or rotate the photo on the screen.
- It takes time to show JPEG files as Thumbnail images.
- Photos without EXIF information may not be displayed as thumbnail images in the PHOTO LIST depending on the picture quality and resolution.

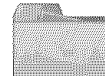

: Folder icon



: Photo icon



: Move to the previous folder stage icon

## Selecting a Photo and Slide Show

1. Complete Steps 1 to 3 of "Using the WISELINK Menu". (Refer to page 65)
2. Press the ◀ or ▶ button to move to "Photo", then press the **ENTER** button.  
The saved file information is displayed as a folder or file.



3. Press the **INFO** button to display "Start Slide Show" or "Deselect All".

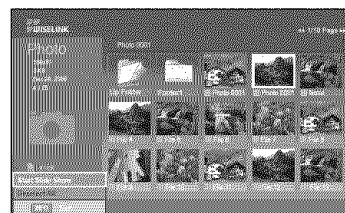

4. Press the ▲ or ▼ button to select "Start Slide Show", then press the **ENTER** button.

- During the slide show, files are displayed in order from the currently shown file.
- MP3 files can be automatically played during the slide show if the Default Background Music is set to On. To enable this function, MP3 files and other photo files must be located in the same folder on the USB Memory Device.



5. Press the **INFO** button during the slide show to set the following options (Slide Show Speed, Background Music, Background Music Setting, List).  
Press the ▲ or ▼ button to select the option, then press the **ENTER** button.
  - After setting the option press the **ENTER** button to make a change.

## Using the Menu during a Slide Show

### Slide Show Speed:

Select to control the slide show speed.

You can select "Slow", "Norm" or "Fast".

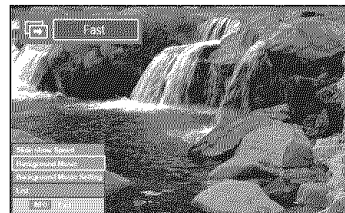

### Background Music:

Select to choose whether you want to play an MP3 file during a slide show.

You can select Music "ON" or "OFF".



### Background Music Setting:

While the slide show is in progress, MP3 files and folders under the same directory are displayed.

Select a folder using the ▲ or ▼ button and press the **ENTER** button.

The selected folder will be highlighted.

Press the **RETURN** button again to return to the slide show screen.

The selected background music is played.

- If you turn Off the Background Music, even if the Background Music Settings have been set up, the background music will not be played.

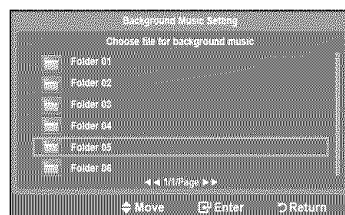



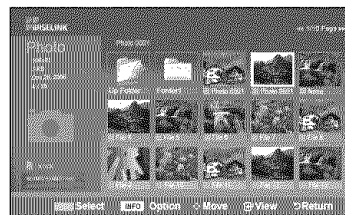

### List:

The file information is displayed as a folder or JPEG file.



To exit WISELINK mode, press the **WISELINK** button on the remote control.

**Slideshow function information icon (Displayed at the top left of the screen).**

Icon	Current OSD	Function
	(Photo) SlideShow	Photo SlideShow is in progress.
	Photo Pause	You are able to pause a SlideShow and Music by pressing the PLAY/PAUSE ►   button on the remote control during a SlideShow. To resume the SlideShow, press the PLAY/PAUSE ►   button on the remote control again.
	Move to Next Photo	Pressing the (right) direction button on the remote control allows you to move to the next photo.
	Move to Previous Photo	Pressing the (left) direction button on the remote control allows you to move to the previous photo

- When selecting a photo file, the photo file information is displayed on the left side of the TV screen, such as the resolution, the date modified and the order of the file in the current directory (e.g. 10th out of 15).

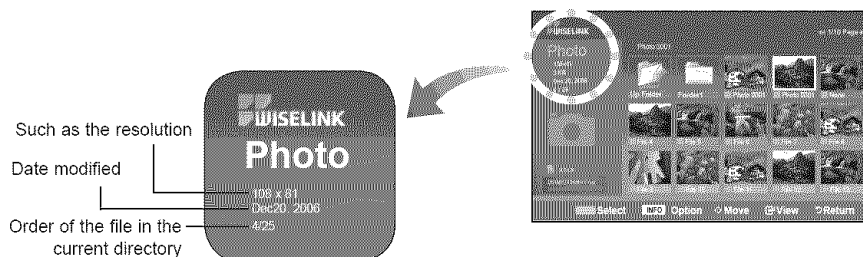

## Rotating

1. Complete Steps 1 to 3 of "Using the WISELINK Menu". (Refer to page 65)
2. Press the ◀ or ▶ button to move to "Photo", then press the **ENTER** button.  
The saved file information is displayed as a folder or file.
3. Press the ▲, ▼, ◀ and ▶ buttons to select a file, then press the **ENTER** button.  
Pressing the button over a photo thumbnail displays the photo in full screen.
4. Press the **INFO** button to display the option (Start Slide Show, Rotate, Zoom, List).  
Press the ▲ or ▼ button to select "Rotate", then press the **ENTER** button.  
Press the ▲ or ▼ button to select the required option (0°, 90°, 180°, 270°), then press the **ENTER** button.  
To exit WISELINK mode, press the **WISELINK** button on the remote control.
  - > The rotated file is not saved.
  - > The Zoom/Slide Show option is disabled when the Rotate option is selected.

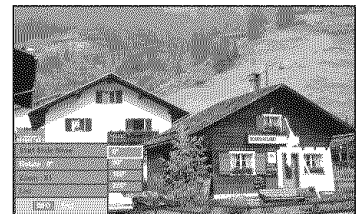
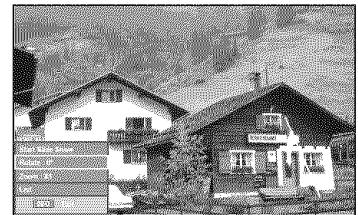
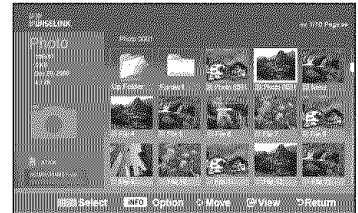
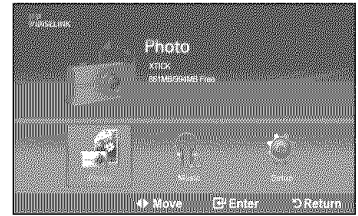

The Rotating function information icon (Displayed at the top left of the screen).

Icon	Current OSD	Function
	Rotating (0°)	This rotates a photo to its original position
	Rotating (90°)	This rotates a photo by 90 degrees
	Rotating (180°)	This rotates a photo by 180 degrees
	Rotating (270°)	This rotates a photo by 270 degrees



## Zooming-in

1. Complete Steps 1 to 3 of "Using the WISELINK Menu". (Refer to page 65)
2. Press the ◀ or ▶ button to move to "Photo", then press the **ENTER** button.  
The saved file information is displayed as a folder or file.

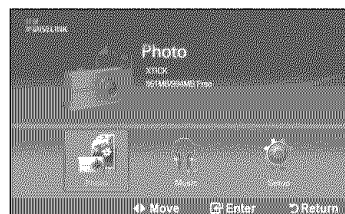

3. Press the ▲, ▼, ◀ and ▶ buttons to select a file, then press the **ENTER** button.  
Pressing the button over a photo thumbnail displays the photo in full screen.

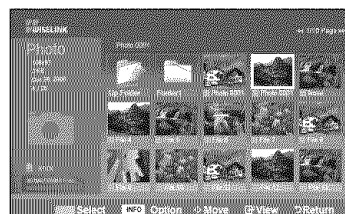

4. Press the **INFO** button to display the option (Start Slide Show, Rotate, Zoom, List).  
Press the ▲ or ▼ button to select "Zoom", then press the **ENTER** button.  
Press the ▲ or ▼ button to select the required option (X1, X2, X4), then press the **ENTER** button.

- Zoom(x 1): Restore the photo to its original size.
- Zoom(x 2): Zoom-in to the photo x2.
- Zoom(x 4): Zoom-in to the photo x4.

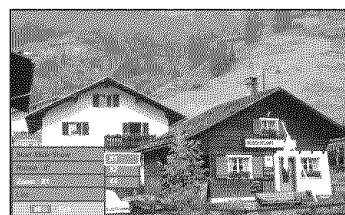





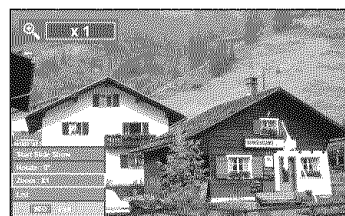

To pan up/down/left/right in the zoomed-in photo, press the **INFO** button to exit option menu, then press the ▲, ▼, ◀ and ▶ buttons.

- Images with a resolution larger than 1280 X 720 are not supported.
- The Rotate/Slide show option is disabled when the Zoom option is selected.

To exit WISELINK mode, press the **WISELINK** button on the remote control.



**Zoom function information icon (Displayed at the top left of the screen).**

Icon	Current OSD	Function
	Zoom (x 2)	Zoom-in to a photo x2.
	Zoom (x 4)	Zoom-in to a photo x4.
	Zoom (x 1)	Restore a photo to its original size.
	Pan Down	Pan down to view the lower part of a zoomed-in photo.
	Pan Up	Pan up to view the upper part of a zoomed-in photo.
	Pan Right	Pan right to view the right side of a zoomed-in photo.
	Pan Left	Pan left to view the left side of a zoomed-in photo.

- The Rotate/Slide show option is disabled when the Zoom option is selected.

## Using the MP3 List

This menu shows MP3 files from among the files saved on a USB memory device.

1. Complete Steps 1 to 3 of "Using the WISELINK Menu". (Refer to page 65)
2. Press the ◀ or ▶ button to move to "Music", then press the **ENTER** button. The saved file information is displayed as a folder or file.

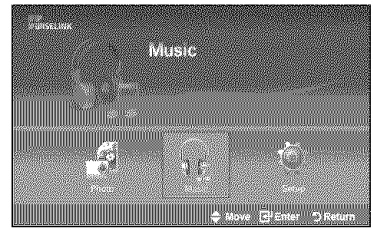

3. Press the ▲ or ▼ button to select a file, then press the **ENTER** button.

To select all files or a file, press the **INFO** button to display the Music menus. Press the **ENTER** button to select "Play", "Repeat Music" or "Deselect All".

- Pressing the **ENTER** button over a musical note icon immediately plays the music file.
- Pressing the **ENTER** button over a folder icon shows the music files included in the folder.

To select a file on the next page, press the **REW** ◀◀ or **FF** ▶▶ button to move to the next page.

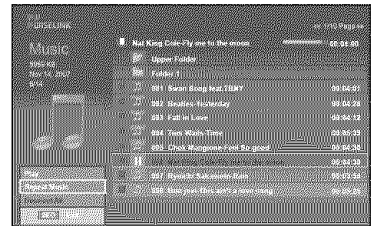

4. Press the **PLAY/PAUSE** ▶|| button while playing an MP3 file to pause the file. Press the **STOP** ■ button to exit Play mode.

To exit WISELINK mode, press the **WISELINK** button on the remote control.

- This menu only shows files with the MP3 file extension. Files with other file extensions are not displayed, even if they are saved on the same USB device.
- The selected file is displayed on the top with its playing time.
- To adjust the music volume, press the **VOL+** or **VOL-** button on the remote control. To mute the sound, press the **MUTE** button on the remote control.
- **FF** ▶▶ or **REW** ◀◀ button do not function during the play.

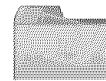

: Folder icon



: Music icon



: Move to the previous folder stage icon

**Music function information icon** (Displayed at the top left of the screen).

Icon	Current OSD	Function
	(Music) All	When all music files are being played.
	(Music) One	When a music file is being played.
	(Music) Play/Pause	When pressing the <b>PLAY/PAUSE</b> ▶   button on the remote control while music is playing. The music stops and the 'Play' text appears at the top of the screen.
	(Music) Stop	When pressing the <b>STOP</b> ■ button on the remote control when music is stopped. The music resumes and the 'Stop' text appears at the top of the screen.

## Music Repeat

1. Complete Steps 1 to 3 of "Using the WISELINK Menu". (Refer to page 65)
2. Press the ◀ or ▶ button to move to "Music", then press the **ENTER** button. The saved file information is displayed as a folder or file.

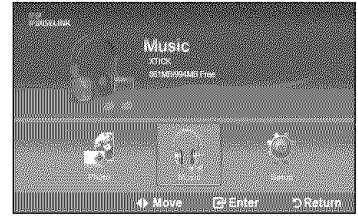

3. Press the ▲ or ▼ button to select a file, then press the **ENTER** button. To select all files or a file, press the **INFO** button to display the Music menus. Press the **ENTER** button to select "Play", "Repeat Music" or "Deselect All".

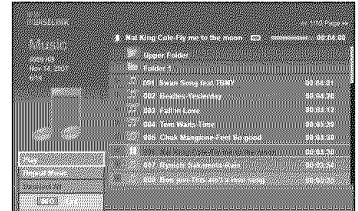

4. Press the **ENTER** button to select "Repeat Music".
  - > Select to repeatedly play MP3 files in the current folder.  
You can select On or Off
  - On: Plays back a music file or all music files repeatedly
  - Off: Doesn't play back the music files repeatedly.

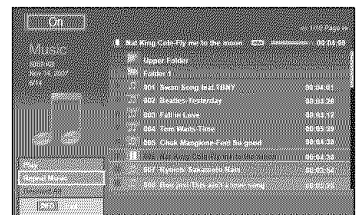

To exit WISELINK mode, press the **WISELINK** button on the remote control.

## Using the Setup Menu

Setup displays the user settings of the WISELINK menu.

1. Complete Steps 1 to 3 of "Using the WISELINK Menu". (Refer to page 65)
2. Press the ◀ or ▶ button to move to "Setup", then press the ENTER button.

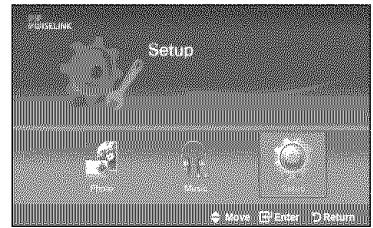

3. Press the ▲ or ▼ button to select an item you want, then press the ENTER button.

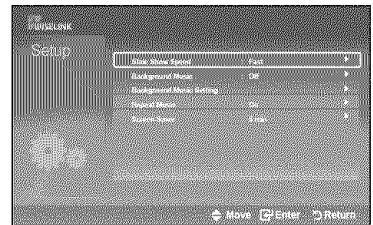

4. Press the ▲ or ▼ button to select the option, then press the ENTER button.



continued...

### Slide Show Speed:

Select to control the slide show speed. You can select "Fast", "Normal" or "Slow".

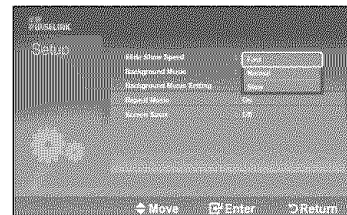

### Background Music :

Select to determine whether to play an MP3 file during a slide show.

You can select Music "On" or Music "Off".

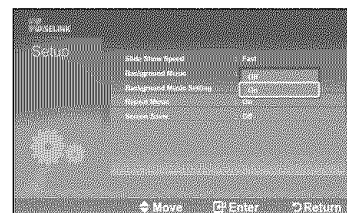

### Background Music Setting:

You can select the background music to play during a slide show. You can also select the background music while a slide show is playing by pressing the **INFO** button and selecting the "Background Music Setting" menu.

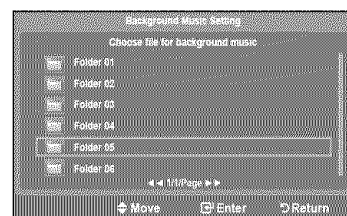

### Repeat Music:

Select to repeatedly play MP3 files in the current folder.

You can select "On" or "Off".

- On: Plays back a music file or all music files repeatedly.
- Off: Doesn't play back the music files repeatedly.

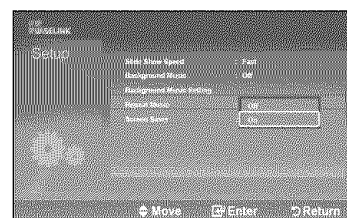

### Screen Saver:

Select to set the waiting time before the screen saver appears.

The screensaver will appear when no button is pressed for 1, 3 or 5 minutes.

To exit WISELINK mode, press the **WISELINK** button on the remote control.

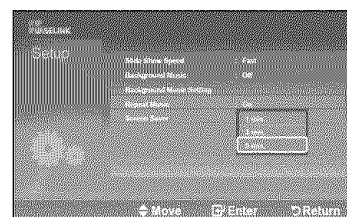

## About Anynet+

### What is Anynet+?

Anynet+ is a function that enables you to control all connected Samsung devices that support Anynet+ with your Samsung TV's remote.

### Connecting Anynet+ Devices

The Anynet+ system can be used only with Samsung devices that have the Anynet+ feature. To be sure your Samsung device has this feature, check if there is an Anynet+ logo on it.

#### To connect to a TV

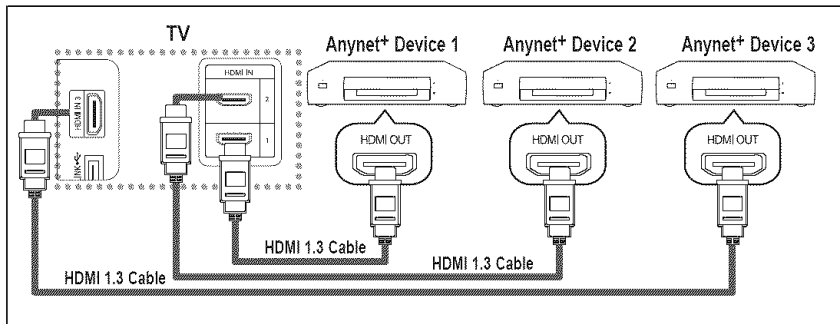

Connect the [HDMI 1], [HDMI 2] or [HDMI 3] jack on the TV and the HDMI OUT jack of the corresponding Anynet+ device using an HDMI cable.

#### To connect to Home Theater

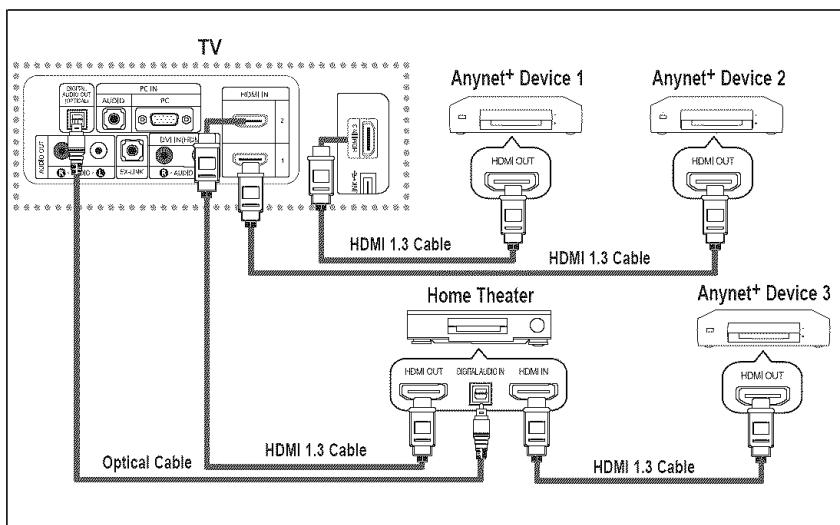

1. Connect the [HDMI 1], [HDMI 2] or [HDMI 3] jack on the TV and the HDMI OUT jack of the corresponding Anynet+ device using an HDMI cable.
2. Connect the HDMI IN jack of the home theater and the HDMI OUT jack of the corresponding Anynet+ device using an HDMI cable.

- Connect the Optical cable between the Digital Audio Out (Optical) jack on your TV and the Digital Audio Input on the Home Theater.
- Connect only one Home Theater.
- When following the connection above, the Optical jack only outputs 2 channel audio. You will only hear sound from the Home Theater's Front Left and Right speakers and the subwoofer. If you want to hear 5.1 channel audio, connect the DIGITAL AUDIO OUT (OPTICAL) jack on the DVD player or Cable/Satellite Box (ie Anynet Device 1 or 2) directly to the Amplifier or Home Theater, not the TV. Please see the home theater's user manual for more information.
- Some HDMI cables may not support Anynet+ functions.
- Anynet+ works when the AV device supporting Anynet+ is in the Standby or On status.
- Anynet+ supports up to 12 AV devices in total. Note that you can connect up to 3 devices of the same type.

## Setting Up Anynet+

The following settings help set the Anynet+ functions.

### To use the Anynet+ Function, Anynet+ (HDMI-CEC) must be set to On

1. Press the **Anynet+** button.  
Press the **▲** or **▼** button to select "Setup", then press the **ENTER** button.
2. Press the **ENTER** button to select "Anynet+ (HDMI-CEC)", then press the **ENTER** button.
3. Press the **▲** or **▼** button to select "On", then press the **ENTER** button.
  - The Anynet+ (HDMI-CEC) function is enabled.
  - If you select Off, Anynet+ (HDMI-CEC) is disabled.
  - When the Anynet+ (HDMI-CEC) function is disabled, all the Anynet+ related operations are deactivated.

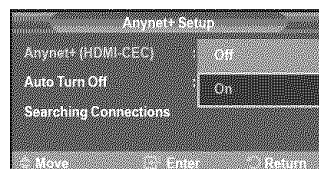

### Setting an Anynet+ Device to turn Off Automatically when the TV is Turned Off

2. Press the **▲** or **▼** button to select **Auto Turn Off**, then press the **ENTER** button.
3. Press the **▲** or **▼** button to select "On", then press the **ENTER** button.
  - The "Auto Turn Off" function is enabled.
  - If you select "Off", the "Auto Turn Off" function is canceled.

Press the **EXIT** button to exit.

- The active source on the TV remote must be set to TV to use the Anynet+ function.
- If you set Auto Turn Off to On, connected external devices are also turned off when the TV is turned off. If an external device is still recording, it may or may not turn off.

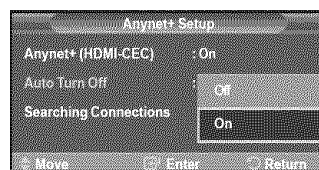

## Scanning and Switching between Anynet+ Devices

1. Press the **Anynet+** button.
  - Anynet+ devices connected to the TV are listed.
2. Press the **▲** or **▼** button to select to a particular device and press the **ENTER** button. It is switched to the selected device.
3. If you cannot find a device you want, press the **▲** or **▼** button to select "Searching Connections", then press the **ENTER** button.

The message "Configuring Anynet+ connection..." is displayed.

When searching devices completes, the connected devices are listed in the Anynet+ menu.

- Switching to the selected devices may take up to 2 minutes. You cannot cancel the operation during the switching operation.
- The time required to scan for devices is determined by the number of connected devices.
- When the device scan is complete, the number of devices found are not displayed.
- Although the TV automatically scans devices when it is turned on using the **POWER** button, devices connected when the TV is already on are not displayed in the device list. In this case, select the Searching Connections menu to search devices.
- If you have selected external input mode by pressing the **SOURCE** button, you cannot use the Anynet+ function. Make sure to switch to an Anynet+ device by using the Anynet+ button.

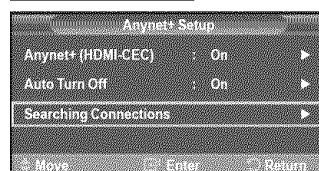



## Anynet+ Menu

The Anynet+ menu changes depending on the type and status of the Anynet+ devices connected to the TV.

Anynet+ Menu	Description
View TV	Switches from Anynet+ to TV broadcast mode.
Record	Starts a recording. (This menu works only for a device supporting recording.)
(Device_Name) Menu	Shows the menu of the connected device. Example: When a DVD Recorder is connected, the DVD Recorder's title menu appears.
(Device_Name) Operation	Shows the play control menu of the connected device. Example: When a DVD Recorder is connected, the play control menu of the DVD Recorder appears.
Connect (Device_Name)	Your TV connects to the corresponding device.
Receiver	Sound is output through the receiver (home theater).
Setup	You can set the Anynet+ (HDMI-CEC), auto turn off, and searching connections for using Anynet+.

## TV Remote Control Buttons Available in Anynet+ Mode

Device Type	Operating Status	Available Buttons
Anynet+ Device	After switching to the device, when the menu of the corresponding device is displayed on the screen.	Numeric buttons ▲/▼/◀/▶/ENTER buttons Color buttons EXIT button
	After switching to the device, while playing a file	◀◀ (Backward search) ▶▶ (Forward search) ■ (Stop) ▶   (Play/Pause)
Device with built-in Tuner	After switching to the device, when you are watching a TV program	CH ▲/▼ button
Audio Device	When Receiver is activated	VOL +/- button MUTE button

- The Anynet+ function only works when the active source on the TV remote control is set to TV.
- The **REC** button works only while in the recordable state.
- You cannot control Anynet+ devices using the buttons on the side of the TV. You can control Anynet+ devices only using the TV remote control.
- The TV remote control may not work under certain conditions. In this case, reselect the Anynet+ device.
- The Anynet+ functions do not operate with other manufacturers' products.
- The ◀◀, ▶▶ operations may differ depending on the device.

## Recording

You can make a recording of a TV program using a recorder.

Press the **REC** button.

Recording begins. (Only when the Anynet+ enabled recording device is connected.)

- You can record the source streams by selecting "Record" after pressing the Anynet+ button.
- Pressing the **REC** button will record whatever you are currently watching. If you are watching video from another device, the video from the device is recorded.
- Before recording, check whether the antenna jack is properly connected to the recording device. To properly connect an antenna to a recording device, refer to the recording devices users manual.

## Listening through a Receiver (Home theater)

You can listen to sound through a receiver instead of the TV speaker.

1. Press the **Anynet+** button.  
Press the **▲** or **▼** button to select "Receiver", then press the **ENTER** button.
  2. Press the **◀** or **▶** button to select to "On", then press the **ENTER** button.  
Now you can listen to sound through the receiver.
  3. Press the **EXIT** button to exit.
- When the receiver (home theater) is set to On, you can hear sound output from the TV's Optical jack. When the TV is displaying a DTV(air) signal, the TV will send out 5.1 channel sound to the Home theater receiver. When the source is a digital component such as a DVD and is connected to the TV via HDMI, only 2 channel sound will be heard from the Home Theater receiver.
- If your receiver supports audio only, it may not appear in the device list.
- The receiver will work when you have properly connected the Optical IN jack of the receiver to the Optical Out jack of the TV.
- When using the WISELINK feature, sound may not output properly through the receiver.
- When listening through the receiver, there are restrictions for using the PIP and audio-related(MTS, Preferred language) menus.

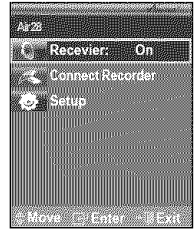

## Troubleshooting for Anynet+

Symptom	Solution
Anynet+ does not work.	<ul style="list-style-type: none"> <li>■ Check if the device is an Anynet+ device. The Anynet+ system supports Anynet+ devices only.</li> <li>■ Connect only one receiver (home theater).</li> <li>■ Check if the Anynet+ device power cord is properly connected.</li> <li>■ Check the Anynet+ device's Video/Audio/HDMI 1.3 cable connections.</li> <li>■ Check whether Anynet+ (HDMI-CEC) is set to On in the Anynet+ setup menu.</li> <li>■ Check whether the TV remote control is in TV mode.</li> <li>■ Check whether it is Anynet+ exclusive remote control.</li> <li>■ Anynet+ doesn't work at a certain condition. (Searching channels, Operating WISELINK)</li> <li>■ When connecting or removing the HDMI 1.3 cable, please make sure to search devices again or restart your TV.</li> <li>■ Check if the Anynet+ Function of Anynet+ device is set on.</li> </ul>
I want to start Anynet+.	<ul style="list-style-type: none"> <li>■ Check if the Anynet+ device is properly connected to the TV and check if the Anynet+ (HDMI-CEC) is set to On in the Anynet+ Setup menu.</li> <li>■ Press the <b>TV</b> button on the TV remote control to switch to TV. Then press the <b>Anynet+</b> button to show the Anynet+ menu and select a menu you want.</li> </ul>
I want to exit Anynet+.	<ul style="list-style-type: none"> <li>■ Select <b>View TV</b> in Anynet+ menu.</li> <li>■ Press the <b>SOURCE</b> button on the TV remote control and select a device other than Anynet+ devices.</li> <li>■ Press any of <b>CH</b>, <b>CH LIST</b>, <b>PRE-CH</b>, and <b>FAV.CH</b> to change the TV mode. (Note that the channel button operates only when a tuner-embedded Anynet+ device is not connected.)</li> </ul>
The message Connecting to Anynet+ device... appears on the screen.	<ul style="list-style-type: none"> <li>■ You cannot use the remote control when you are configuring Anynet+ or switching to a view mode.</li> <li>■ Use the remote control when the Anynet+ setting or switching to view mode is complete.</li> </ul>
The Anynet+ device does not play.	You cannot use the play function when Plug & Play is in progress.
The connected device is not displayed.	<ul style="list-style-type: none"> <li>■ Check whether or not the device supports Anynet+ functions.</li> <li>■ Check whether or not the HDMI 1.3 cable is properly connected.</li> <li>■ Check whether Anynet+ (HDMI-CEC) is set to On in the Anynet+ setup menu.</li> <li>■ Search Anynet+ devices again.</li> <li>■ You can connect an Anynet+ device using the HDMI 1.3 cable only. Some HDMI cables may not support Anynet+ functions.</li> </ul>
The TV program cannot be recorded.	Check whether the antenna jack on the recording device is properly connected.
The TV sound is not output through the receiver.	Connect the optical cable between TV and the receiver.

## Appendix

### Troubleshooting

If the TV seems to have a problem, first try this list of possible problems and solutions.  
If none of these troubleshooting tips apply, call your nearest Samsung service center.

Problem	Possible Solution
Poor picture	Try another channel. Adjust the antenna. Check all wire connections.
Poor sound quality	Try another channel. Adjust the antenna.
No picture or sound	Try another channel. Press the SOURCE button. Make sure the TV is plugged in. Check the antenna connections.
No sound or sound is too low at maximum volume.	First, check the volume of units connected to your TV (digital broadcasting receiver, DVD, cable broadcasting receiver, VCR, etc.). Then, adjust the TV volume accordingly.
Picture rolls vertically.	Check all wire connections.
The TV operates erratically.	Unplug the TV for 30 seconds, then try operating it again.
The TV won't turn on.	Make sure the wall outlet is working.
Remote control malfunctions	Replace the remote control batteries. Clean the upper edge of the remote control (transmission window). Check the battery terminals.
"Check signal cable" message.	Ensure that the signal cable is firmly connected to the PC source.
"Not Supported Mode" message.	Check the maximum resolution and the frequency of the Video Adapter. Compare these values with the data in the Display Modes.
Digital broadcasting screen problem.	Please check the digital signal strength and input antenna.
The image is too light or too dark.	Adjust the Brightness and Contrast. Adjust the Fine tuning.
Black bars on the screen.	Make sure the broadcast you're receiving is High Definition (HD). HD channels sometimes broadcast Standard Definition (SD) programming, which can cause black bars. Set your cable/satellite box to stretch or widescreen mode to eliminate the bars.
Picture has a Red/Green or Pink tint.	Make sure the Component cables are connected to the correct jacks.
Closed Captioning not working.	If you are using a Cable/Satellite box, you must set Closed Captioning on the box, not your TV.
Snowy picture	Your cable box may need a firmware upgrade. Please contact your Cable company.
Ghosting on picture	This is sometimes caused by compatibility issues with your cable box. Try connecting Component cables instead.

Problem	Possible Solution						
Horizontal bars appear to flicker, jitter or shimmer on the image.	Adjust the Coarse tuning and then adjust the Fine tuning.						
Vertical bars appear to flicker, jitter or shimmer on the image.	Adjust the Coarse tuning and then adjust the Fine tuning.						
Screen is black and power indicator light blinks steadily.	On your computer check: Power, Signal Cable. The TV is using its power management system. Move the computer's mouse or press any key on the keyboard.						
Image is not stable and may appear to vibrate when you have a computer connected to the PC input.	<p>If the setting is not correct, use your computer utility program to change the display settings.            &gt; Your TV supports multiscan display functions within the following frequency domain:</p> <table border="1" data-bbox="450 452 1009 589"> <tbody> <tr> <td data-bbox="450 452 731 491">Horizontal frequency (kHz)</td> <td data-bbox="731 452 1009 491">30~60</td> </tr> <tr> <td data-bbox="450 491 731 531">Vertical frequency (Hz)</td> <td data-bbox="731 491 1009 531">60~75</td> </tr> <tr> <td data-bbox="450 531 731 589">PC Maximum refresh rate (at 60 Hz)</td> <td data-bbox="731 531 1009 589">1920 X 1080</td> </tr> </tbody> </table>	Horizontal frequency (kHz)	30~60	Vertical frequency (Hz)	60~75	PC Maximum refresh rate (at 60 Hz)	1920 X 1080
Horizontal frequency (kHz)	30~60						
Vertical frequency (Hz)	60~75						
PC Maximum refresh rate (at 60 Hz)	1920 X 1080						
Image is not centered on the screen.	Adjust the horizontal and vertical position. The screen position must be adjusted on the output source (i.e. STB) with a digital signal.						
The picture appears distorted in the corner of the screen.	If "Just Scan" is selected with some external devices, the picture may appear distorted in the corner of the screen. This symptom is caused by the external devices, not TV.						

The TFT LCD panel uses a panel consisting of sub pixels (6 220 800) which require sophisticated technology to produce. However, there may be few bright or dark pixels on the screen. These pixels will have no impact on the performance of the product.

## Installing the Stand

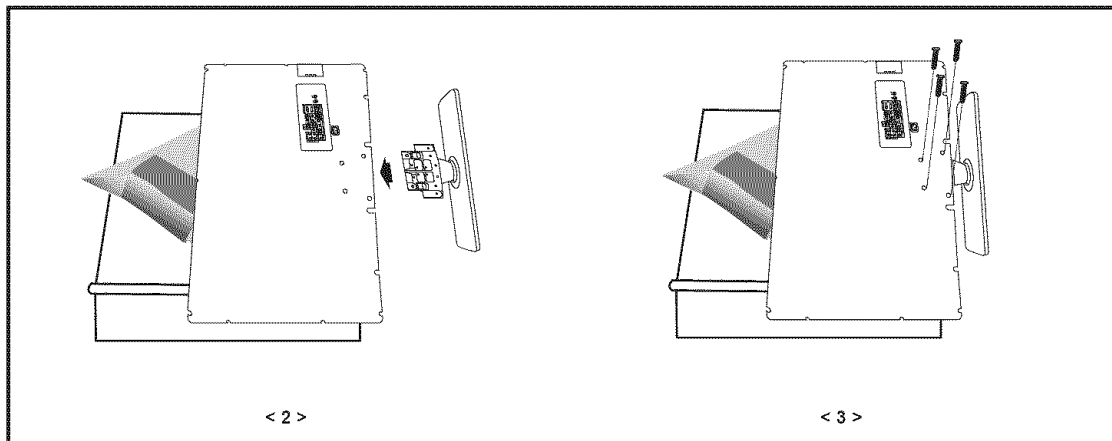

1. Place the TV face down on a soft cloth or cushion on a table.
2. Put the stand into the hole at the bottom of the TV.
3. Insert screw into the hole indicated and tighten.

## Disconnecting the Stand

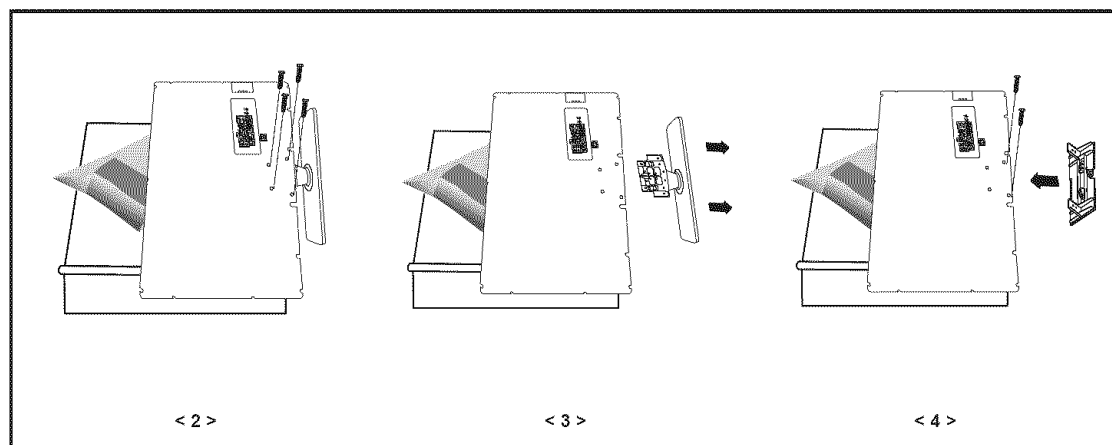

1. Place the TV face down on a soft cloth or cushion on a table.
2. Remove four screws from the back of the TV.
3. Separate the stand from the TV.
4. Cover the bottom hole with a cap.

## Auto Wall-Mount Adjustment (Sold separately)

Once the auto wall mount is installed, your TV's position can be easily adjusted.

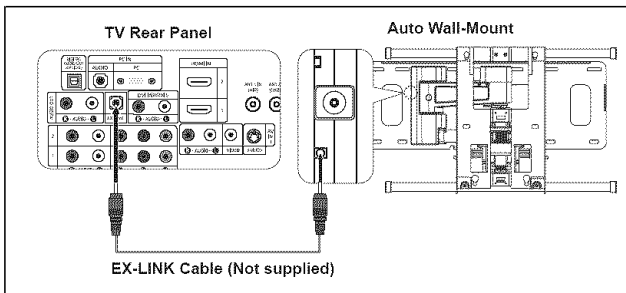

### Entering the menu

- Press the **▲**, **▼**, **◀** or **▶** button on your remote control.
  - The Wall Mount Adjustment screen is displayed.
  - If the Wall Mount Adjustment screen is not displayed when clicking on a direction button while watching your TV, use the menu to display that screen.
    - Press the **MENU** button to display the menu. Press the **▲** or **▼** button to select "Setup", then press the **ENTER** button.
    - Press the **▲** or **▼** button to select "Wall-Mount Adjustment", then press the **ENTER** button.

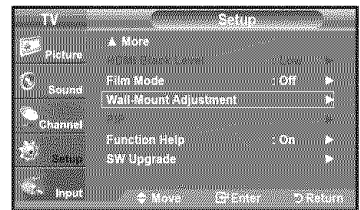

### Remembering the Position

- Adjust to the desired position using the **▲**, **▼**, **◀**, **▶** buttons.
  - If you press an arrow button when no OSD is displayed on the TV screen, the Adjustment screen appears.
  - Press the **INFO** button to reset. Press the **◀** or **▶** button to select "Yes", then press the **ENTER** button. The position is initialized to the default setting.
- Press the blue button. Press the **▲** and **▼** buttons to select a save mode from either Position 1, Position 2 or Position 3 in order to save the current position.
  - To not save the current position, press the **RETURN** button.
  - When selecting a save mode, you cannot use the Color buttons.
- Press the **ENTER** button to save.
  - When Position1 is selected, the message "Current position saved as Position1" is displayed.
- Press the **ENTER** button.
  - The saved Position appears on the left side of the OSD.

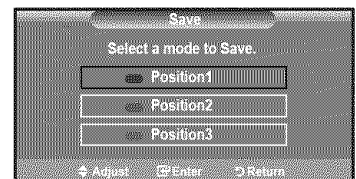
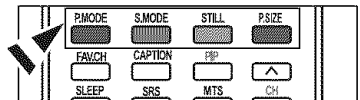
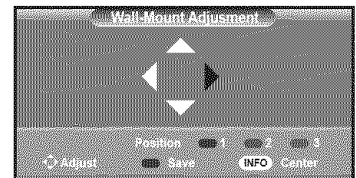

### Moving to the remembered position

- Complete Step 1 of "Entering the menu".
- Pressing a Color (Red, Green, Yellow) button moves the auto wall mount to the saved position.
  - You can move the wall mount to one of the 3 pre-set positions by pressing the Red (Position 1), Green (Position 2) or Yellow (Position 3) buttons.
  - If you adjust the position after moving to a pre-set position, the position display will disappear.

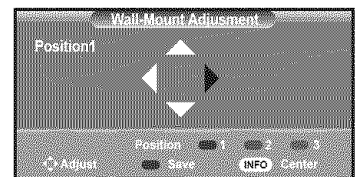

- For installation, refer to the Installation Manual provided with the wall mount.
- For product installation and the installation and moving of the wall mount, make sure to consult a specialized installation company.
- This installation manual is to be used when attaching the wall mount to a wall. When attaching to other building materials, please contact your nearest dealer.
- The auto wall mount will not work when Anynet+ is operating.

## Wall Mount Kit Specifications (VESA)

Install your wall mount on a solid wall perpendicular to the floor.  
 When attaching to other building materials, please contact your nearest dealer.  
 If installed on a ceiling or slanted wall, it may fall and result in severe personal injury.

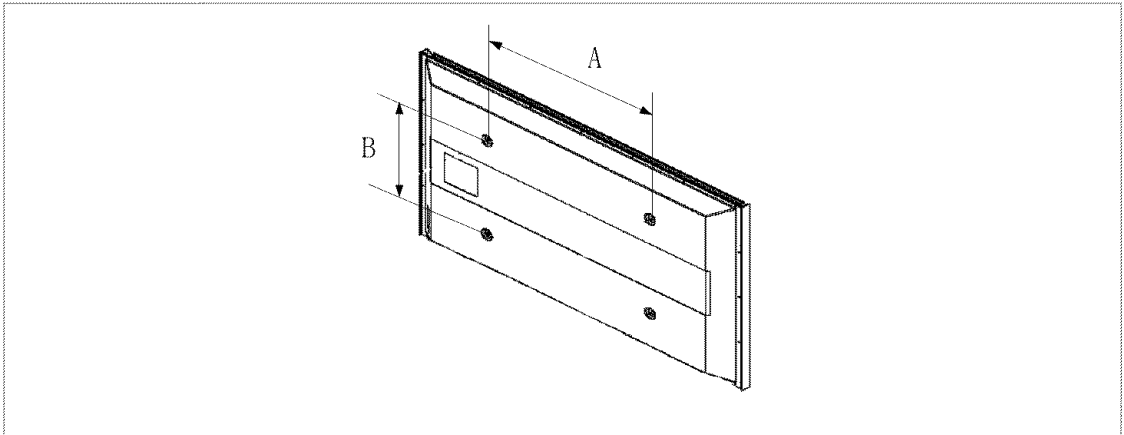

Product Family	inches	VESA Spec. (A * B)	Standard Screw	Quantity
LCD-TV	23~ 26	200 * 100	M4	4
	32 ~ 40	200 * 200	M6	
	46 ~ 52	600 * 400	M8	
	57	700 * 400 (No VESA)		
	57 ~ 70	800 * 400		
	80 ~	1400 * 800		
PDP-TV	42 ~ 50	600 * 400	M8	4
	55 ~ 70	800 * 400		6
	63	No VESA		4
	80 ~	1400 * 800		

- > Standard dimensions for wall mount kits are shown in the table above.
- > When purchasing our wall mount kit, a detailed installation manual and all parts necessary for assembly are provided.
- > Do not use screws longer than the standard dimension, as they may cause damage to the inside of the TV set.
- > For wall mounts that do not comply with the VESA standard screw specifications, the length of the screws may differ depending on their specifications.
- > Do not use screws that do not comply with the VESA standard screw specifications.  
Do not use fasten the screws too strongly, this may damage the product or cause the product to fall, leading to personal injury. Samsung is not liable for these kinds of accidents.
- > Samsung is not liable for product damage or personal injury when a non-VESA or non-specified wall mount is used or the consumer fails to follow the product installation instructions.
- > Our 57" and 63" models do not comply with VESA Specifications. Therefore, you should use our dedicated wall mount kit for this model.
- > Do not exceed 15 degrees tilt when mounting this TV.



Do not install your Wall Mount Kit while your TV is turned on.  
 It may result in personal injury due to electric shock

## Using the Anti-Theft Kensington Lock (depending on the model)

The Kensington lock is a device used to physically fix the system when using it in a public place. The locking device has to be purchased separately. The appearance and locking method may differ from the illustration depending on the manufacturer. Please refer to the manual provided with the Kensington lock for proper use.

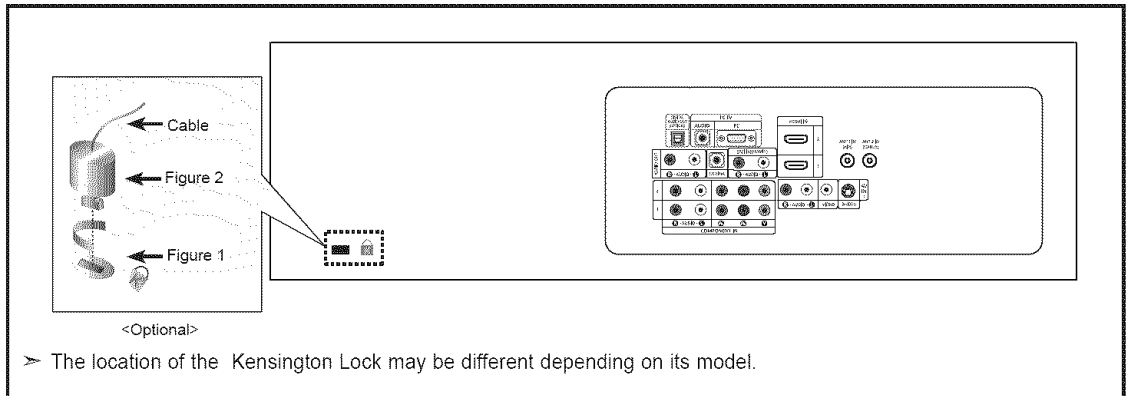

1. Insert the locking device into the Kensington slot on the LCD TV (Figure 1) and turn it in the locking direction (Figure 2).
2. Connect the Kensington lock cable.
3. Fix the Kensington lock to a desk or a heavy stationary object.



## Specifications

Model Name	LN-T4069F	LN-T4669F
Screen Size (Diagonal)	40 inches	46 inches
PC Resolution	1920 x 1080 @ 60 Hz	1920 x 1080 @ 60 Hz
Sound Output	10W X 2	10W X 2
<b>Dimensions (WxDxH)</b>		
Body	39.4 X 3.4 X 25.0 inches (999.8 x 87.0 x 634.3 mm)	44.6 X 4.1 X 28.2 inches (1133.8 x 104.0 x 715.2 mm)
With stand	39.4 X 11.4 X 27.4 inches (999.8 x 289.9 x 696.1 mm)	44.6 X 12.6 X 30.9 inches (1133.8 x 319.9 x 783.7 mm)
<b>Weight</b>		
With Stand	50.0 lbs (22.7 kg)	66.8 lbs (30.3 kg)
Without stand	41.2 lbs (18.7 kg)	55.1 lbs (25.0 kg)
<b>Environmental Considerations</b>		
Operating Temperature	50 °F to 104 °F (10 °C to 40 °C)	50 °F to 104 °F (10 °C to 40 °C)
Operating Humidity	10% to 80%, non-condensing	10% to 80%, non-condensing
Storage Temperature	-4 °F to 113 °F (-20 °C to 45 °C)	-4 °F to 113 °F (-20 °C to 45 °C)
Storage Humidity	5% to 95%, non-condensing	5% to 95%, non-condensing
<b>Stand Swivel (Left / Right)</b>	-20° ~ 20°	-20° ~ 20°

- > Design and specifications are subject to change without prior notice.
- > This device is a Class B digital apparatus.
- > For the power supply and Power Consumption, refer to the label attached to the product.

# Dimensions (LN-T4069F)

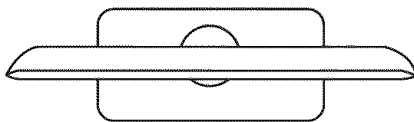

TOP VIEW

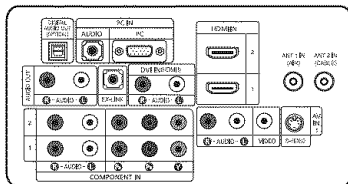

JACK PANEL DETAIL 3.5"H X 9"W

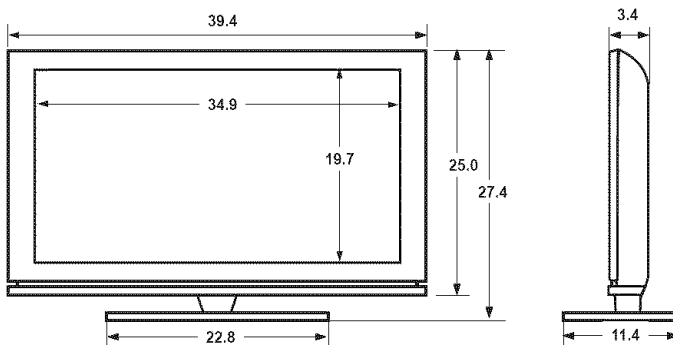

FRONT VIEW / SIDE VIEW

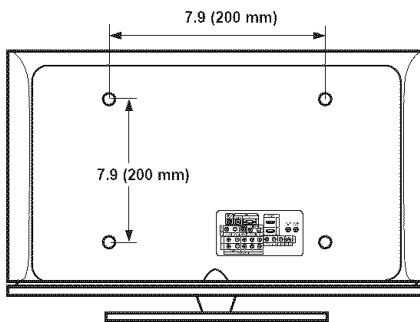

REAR VIEW

NOTE: All drawings are not necessarily to scale.  
 Some dimensions are subject to change without prior notice.  
 Refer to the dimensions prior to performing installation of your TV.  
 Not responsible for typographical or printed errors.  
 © 2007 Samsung Electronics America, Inc.

# Dimensions (LN-T4669F)

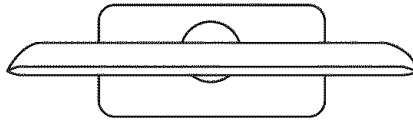

TOP VIEW

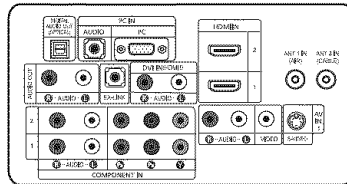

JACK PANEL DETAIL 3.5"H X 9"W

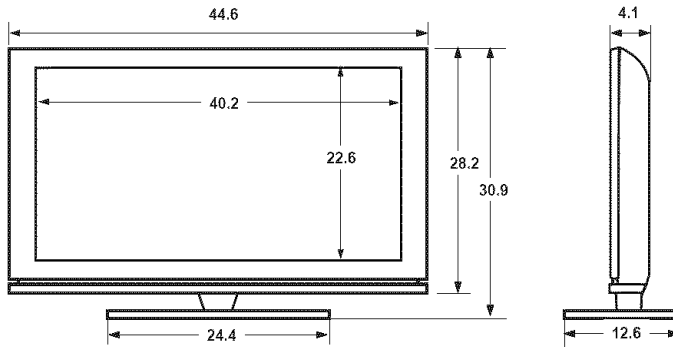

FRONT VIEW / SIDE VIEW

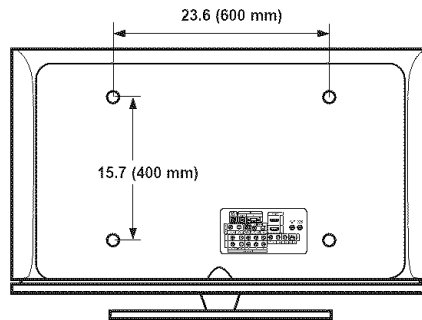

REAR VIEW

NOTE: All drawings are not necessarily to scale.  
 Some dimensions are subject to change without prior notice.  
 Refer to the dimensions prior to performing installation of your TV.  
 Not responsible for typographical or printed errors.  
 © 2007 Samsung Electronics America, Inc.



**Contact SAMSUNG WORLDWIDE**

If you have any questions or comments relating to Samsung products, please contact the SAMSUNG customer care center.

**Comment contacter Samsung dans le monde**

Si vous avez des suggestions ou des questions concernant les produits Samsung, veuillez contacter le Service Consommateurs Samsung.

**Contacte con SAMSUNG WORLDWIDE**

Si tiene alguna pregunta o comentario referente a nuestros productos, por favor contacte con nuestro Servicio de Atención al Cliente.

Country	Customer Care Center ☎	Web Site	Address
CANADA	1-800-SAMSUNG(726-7864)	www.samsung.com/ca	Samsung Electronics Canada Inc., Customer Service 55 Standish Court Mississauga, Ontario L5R 4B2 Canada
			Samsung Electronique Canada Inc., Service à la Clientèle 55 Standish Court Mississauga, Ontario L5R 4B2 Canada
U.S.A	1-800-SAMSUNG(726-7864)	www.samsung.com/us	Samsung Electronics America, Inc. 105 Challenger Road Ridgefield Park, NJ 07660-0511

