

Memorex®

User Guide

32"

Widescreen LCD HDTV
with full function remote control



HDTV
HIGH DEFINITION TELEVISION

Model MLT3221

Please read these instructions completely,
before operating this product.

WEEE

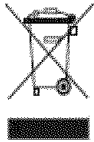

This product contains electrical or electronic materials. The presence of these materials may, if not disposed of properly, have potential adverse effects on the environment and human health. Presence of this label on the product means it should not be disposed of as unsorted waste and must be collected separately. As a consumer, you are responsible for ensuring that this product is disposed of properly.

HDMI™

This TV incorporates High-Definition Multimedia Interface (HDMI™) technology. HDMI, the HDMI logo and High-Definition Multimedia Interface are trademarks or registered trademarks of HDMI Licensing LLC.



Manufactured under license from Dolby Laboratories. Dolby and the double -D symbol are trademarks of Dolby Laboratories.



This Class B Digital apparatus meets all requirements of the Canadian Interference Causing Equipment Regulations.

Get appareil numérique de la class B respecte toutes les exigences du Règlement sur le matériel brouilleur du Canada.

CONTENTS

■ Warnings and Precautions	
Important Safety Instructions	2
■ Chapter 1 Introducing the LCD TV	
Key Features	5
Package Contents	6
Setting Your LCD TV	7
Your LCD TV	9
Your Remote Control	11
■ Chapter 2 Installing the LCD TV	
Connecting a TV Cable or an Antenna	13
Connecting a VCR	18
Connecting a Video Camera or Game Console	19
Connecting a DVD Player	20
Connecting a Digital TV Cable Box or Digital Satellite Receiver	22
Connecting an AV Equipment with HDMI Connector	23
Connecting an AV Equipment with DVI Connector	24
Connecting a PC	25
Connecting an Audio Receiver or a Dolby Digital 5.1 Sound System	26
■ Chapter 3 Using the Features	
Wide Screen Viewing	27
Operating the Menu	28
Customizing the VIDEO Settings	30
Customizing the AUDIO Settings	32
Customizing the TV Settings	34
Customizing the SETUP Settings	36
Using the Program Block Settings	40
Using the Program Guide	45
■ Troubleshooting	46
■ Specification	47

IMPORTANT SAFETY INSTRUCTIONS

FCC NOTICE:

This device complies with Part 15 of the FCC Rules. Operation is subject to the following two conditions: (1) this device may not cause harmful interference, and (2) this device must accept any interference received, including interference that may cause undesired operation.

Warning: Changes or modifications to this unit not expressly approved by the party responsible for compliance could void the user's authority to operate the equipment.

NOTE: This equipment has been tested and found to comply with the limits for a Class B digital device, pursuant to Part 15 of the FCC Rules. These limits are designed to provide reasonable protection against harmful interference in a residential installation. This equipment generates, uses and can radiate radio frequency energy and, if not installed and used in accordance with the instructions, may cause harmful interference to radio communications.

However, there is no guarantee that interference will not occur in a particular installation. If this equipment does cause harmful interference to radio or television reception, which can be determined by turning the equipment off and on, the user is encouraged to try to correct the interference by one or more of the following measures:

- Reorient or relocate the receiving antenna.
- Increase the separation between the equipment and receiver.
- Connect the equipment into an outlet on a circuit different from that to which the receiver is connected.
- Consult the dealer or an experienced radio/TV technician for help.

WARNING:

TO REDUCE THE RISK OF FIRE OR ELECTRIC SHOCK, DO NOT EXPOSE THIS PRODUCT TO RAIN OR MOISTURE.

WARNING:

TO REDUCE THE RISK OF FIRE OR ELECTRIC SHOCK, AND ANNOYING INTERFERENCE, USE THE RECOMMENDED ACCESSORIES ONLY.

SURGE PROTECTORS:

It is recommended to use a surge protector for AC connection. Lightning and power surges ARE NOT covered under warranty for this product.

ATTENTION:

POUR ÉVITER LES CHOC ÉLECTRIQUES, INTRODUIRE LA LAME LA PLUS LARGE DE LA FICHE DANS LA BORNE CORRESPONDANTE DE LA PRISES ET POUSSER JUSQU'AU FOND.

FCC WARNING:

To assure continued compliance, follow the attached installation instructions and use only shielded cables when connecting to other devices. Modifications not authorized by the manufacturer may void user's authority to operate this device.

This Class B digital apparatus complies with Canadian ICES-003.

Cet appareil numérique de la classe B est conforme à la norme NMB-003 du Canada.

This TV is capable of receiving unscrambled digital programming for both cable and external UHF/VHF antenna (ATSC) and also can receive NTSC (cable and external UHF/VHF antenna) programs.

IMPORTANT SAFETY INSTRUCTIONS (CONTINUED)



CAUTION

**RISK OF ELECTRIC SHOCK
DO NOT OPEN**



CAUTION: TO REDUCE THE RISK OF ELECTRIC SHOCK, DO NOT REMOVE COVER (OR BACK). NO USER-SERVICEABLE PARTS INSIDE. REFER SERVICING TO QUALIFIED SERVICE PERSONNEL. (This Caution Marking and Rating Label are located at the rear enclosure of the unit.)



The lightning flash with arrowhead symbol within an equilateral triangle is intended to alert the user to the presence of uninsulated dangerous voltage within the product's enclosure that may be of sufficient magnitude to constitute a risk of electric shock to persons.



The exclamation point within an equilateral triangle is intended to alert the user to the presence of important operating and maintenance (servicing) instructions in the literature accompanying the appliance.

WARNING: TO REDUCE THE RISK OF FIRE OR ELECTRIC SHOCK, DO NOT EXPOSE THIS APPLIANCE TO RAIN OR MOISTURE, TO PREVENT ELECTRIC SHOCK, MATCH THE WIDE BLADE OF THE PLUG TO THE WIDE SLOT AND FULLY INSERT.

Before using the unit, be sure to read all operating instructions carefully. Please note that these are general precautions and may not pertain to your unit. For example, this unit may not have the capability to be connected to an outdoor antenna.

1. READ INSTRUCTIONS

All the safety and operating instructions should be read before the product is operated.

2. RETAIN INSTRUCTIONS

The safety and operating instructions should be retained for future reference.

3. HEED WARNINGS

All warnings on the product and in the operating instructions should be adhered to.

4. FOLLOW INSTRUCTIONS

All operating and use instructions should be followed.

5. CLEANING

Unplug this product from the wall outlet before cleaning. Do not use liquid cleaners or aerosol cleaners. Use a dry cloth for cleaning.

6. ATTACHMENTS

Do not use attachments not recommended by the product's manufacturer as they may cause hazards.

7. WATER AND MOISTURE

Do not use this product near water—for example: near a bathtub, washbowl, kitchen sink or laundry tub; in a wet basement; or near a swimming pool.

8. ACCESSORIES

Do not place this product on an unstable cart, stand, tripod, bracket or table. The product may fall, causing serious injury and serious damage to the product. Use only with a cart, stand, tripod, bracket or table recommended by the manufacturer or sold with the product. Any mounting of the product should follow the manufacturer's instructions, and should use a mounting accessory recommended by the manufacturer.

8A. An appliance and cart combination should be moved with care. Quick stops, excessive force and uneven surfaces may cause the appliance and cart combination to overturn.

9. VENTILATION

Slots and openings in the cabinet and in the back or bottom are provided for ventilation, to ensure reliable operation of the product and to protect it from overheating. These openings must not be blocked or covered. The openings should never be blocked by placing the product on a bed, sofa, rug or other similar surface. This product should never be placed near or over a radiator or heat source. This product should not be placed in a built-in installation such as a bookcase or rack unless proper ventilation is provided or the manufacturer's instructions have been adhered to.

10. POWER SOURCES

This product should be operated only from the type of power source indicated on the marking label. If you are not sure of the type of power supply to your home, consult your appliance dealer or local power company. For products intended to operate from battery power, or other sources, refer to the operating instructions.

11. GROUNDING OR POLARIZATION

This product is equipped with a polarized alternating-current line plug (a plug having one blade wider than the other). This plug will fit into the power outlet only one way. This is a safety feature. If you are unable to insert the plug fully into the outlet, try reversing the plug. If the plug should still fail to fit, contact your electrician to replace your obsolete outlet. Do not defeat the safety purpose of the polarized plug.

12. POWER-CORD PROTECTION

Power-supply cords should be routed so that they are not likely to be walked on or pinched by items placed upon or against them, paying particular attention to cords at plugs, convenience receptacles, and the point where they exit from the appliance.

PORTABLE CART WARNING
(symbol provided by RETAC)



S3126A

IMPORTANT SAFETY INSTRUCTIONS (CONTINUED)

13. LIGHTNING

To protect your product from a lightning storm, or when it is left unattended and unused for long periods of time, unplug it from the wall outlet and disconnect the antenna or cable system. This will prevent damage to the product due to lightning and power-line surges.

14. POWER LINES

An outside antenna system should not be located in the vicinity of overhead power lines or other electric light or power circuits, or where it can fall into such power lines or circuits. When installing an outside antenna system, extreme care should be taken to keep from touching such power lines or circuits as contact with them might be fatal.

15. OVERLOADING

Do not overload wall outlets and extension cords as this can result in a risk of fire or electric shock.

16. OBJECT AND LIQUID ENTRY

Never push objects of any kind into this product through openings as they may touch dangerous voltage points or short out parts that could result in fire or electric shock. Never spill or spray any type of liquid on the product.

17. OUTDOOR ANTENNA GROUNDING

If an outside antenna is connected to the product, be sure the antenna system is grounded so as to provide some protection against voltage surges and built-up static charges. Section 810 of the National Electric Code, ANSI/NFPA 70, provides information with respect to proper grounding of the mast and supporting structure, grounding of the lead-in wire to an antenna discharge product, size of grounding conductors, location of antenna discharge product, connection to grounding electrodes and requirements for grounding electrodes.

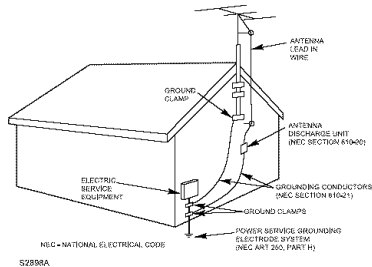

EXAMPLE OF ANTENNA GROUNDING AS PER NATIONAL ELECTRICAL CODE

18. SERVICING

Do not attempt to service this product yourself as opening or removing covers may expose you to dangerous voltage or other hazards. Refer all servicing to qualified service personnel.

19. REPLACEMENT PARTS

When replacement parts are required, be sure the service technician uses replacement parts specified by the manufacturer or those that have the same characteristics as the original part. Unauthorized substitutions may result in fire, electric shock or other hazards.

20. SAFETY CHECK

Upon completion of any service or repairs to this product, ask the service technician to perform safety checks to determine that the product is in proper operating condition.

21. WALL OR CEILING MOUNTING

The product should be mounted to a wall or ceiling only as recommended by the manufacturer.

22. DAMAGE REQUIRING SERVICE

Unplug the product from the wall outlet and refer servicing to qualified service personnel under the following conditions:

- When the power-supply cord or plug is damaged.
- If liquid has been spilled or objects have fallen into the product.
- If the product has been exposed to rain or water.
- If the product does not operate normally by following the operating instructions. Adjust only those controls that are covered by the operating instructions, as an adjustment of other controls may result in damage and will often require extensive work by a qualified technician to restore the product to its normal operation.
- If the product has been dropped or the cabinet has been damaged.
- When the product exhibits a distinct change in performance—this indicates a need for service.

23. HEAT

The product should be situated away from heat sources such as radiators, heat registers, stoves or other products (including amplifiers) that produce heat.

24. NOTE TO CATV SYSTEM INSTALLER

This reminder is provided to call the CATV system installer's attention to Article 820-40 of the NEC that provides guidelines for proper grounding and, in particular, specifies that the cable ground shall be connected to the grounding system of the building, as close to the point of cable entry as practical.

Chapter 1

Introducing the LCD TV

Key Features

Various Audio/Video terminals for external equipment connection

- 2 sets of composite A/V input terminals
- 1 set of S-VIDEO terminals
- 2 sets of component Video input terminals
- 1 VGA/ Audio input terminals
- 2 HDMI/Audio input terminals
- 1 set of Audio(L/R) output terminals
- 2 SPDIF output terminals (Optical x 1 /Coaxial x 1)
- 1 Headphone terminal

The built-in TV tuner to receive HD ATSC

- This function allows the reception of HD broadcasting without the addition of a set top box.

High Definition Multimedia Interface (HDMI)

- High Definition Multimedia Interface (HDMI) is a small, user-friendly interconnect that can carry up to 5 Gbps of combined video and audio in a single cable. This system eliminates the cost, complexity and confusion of multiple cables used to connect current A/V systems.

HDTV Component Video Inputs

- Offers the best video quality for DVD(720p,HD1080i) and digital set-top-box (720p,HD1080i) connections.

3D Digital Noise Reduction

- This function can digitally reduce image noise to provide better picture quality.

Film-Mode Detection (3:2 Reverse Pull Down)

- This function can automatically detect content derived from film and adjust the interlacer's frame matching to provide a more natural-looking, clearer image of the moving picture.

Package Contents

Make sure all of the following contents are included.

- LCD TV

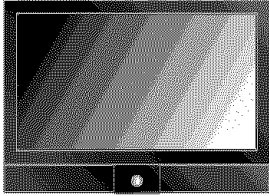

- Bottom Stand(151-700-BF327WV3H) /Screw Driver and 4 Screws

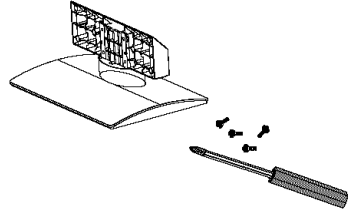

- Remote Control (845-042-GF1XABH)



- VIDEO Cable



- Power Cord (601-181-3200-LIH)



- AUDIO Cable

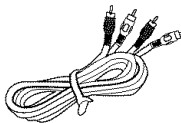

- Warranty Card



- User's Manual



- Quick Start Guide



These items are all you need to set up and operate the LCD TV in its basic configuration.



Make sure all of the above contents are included in the package. If you are missing any items, please contact the customer service department.

Setting Up Your LCD TV

How to install the TV Stand

If you prefer to mount your new TV on a wall instead of attaching it to the stand, please reference the instructions included in the wall mounting kit(not included).



Attach the Stand the TV with the bottom foam packaging material still attached.

Read all instructions before continuing with the stand installation.

- Lift foam packaging material from the top of the LCD out of the box.
- Lift LCD out of the box, with the bottom foam packaging material still attached, and place onto a stable surface.

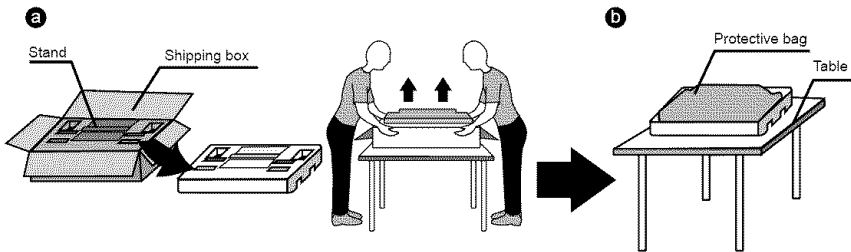

- Remove protective bag from LCD unit, but DO NOT remove the bottom foam packaging material from the TV.
- Locate the place on the back of the TV to attach the stand. Secure the stand to the LCD with all four screws.

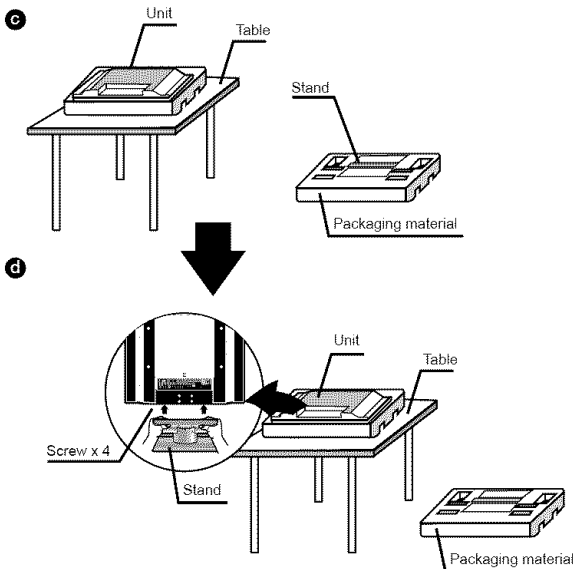

How to setup the TV

- 1** Use a supplied antenna cable to connect the VHF/UHF signal to the LCD TV's ANT. terminal (refer to page15-18).
- 2** Connect the AC power cord at the back of the TV and connect the power cord to wall outlet.
- 3** Insert two AAA batteries in remote control(battery not included).

Step1 Slide the back cover up to open the battery compartment of the remote control.

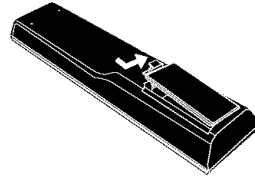

Step2 Insert two AAA size batteries. Make sure to match the (+) and (-) ends of the batteries with the (+) and (-) ends indicated in the battery compartment. Slide the cover back into place.

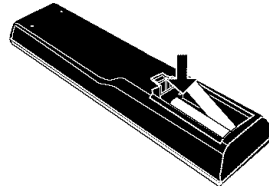

Do not use caustic cleaners (porcelain, stainless steel, toilet, or oven cleaner etc.) on the remote, as it may suffer damage.

- 4** Connect other an external AV device (refer to page18-26).

Your LCD TV

Front/Right Side View and Controls

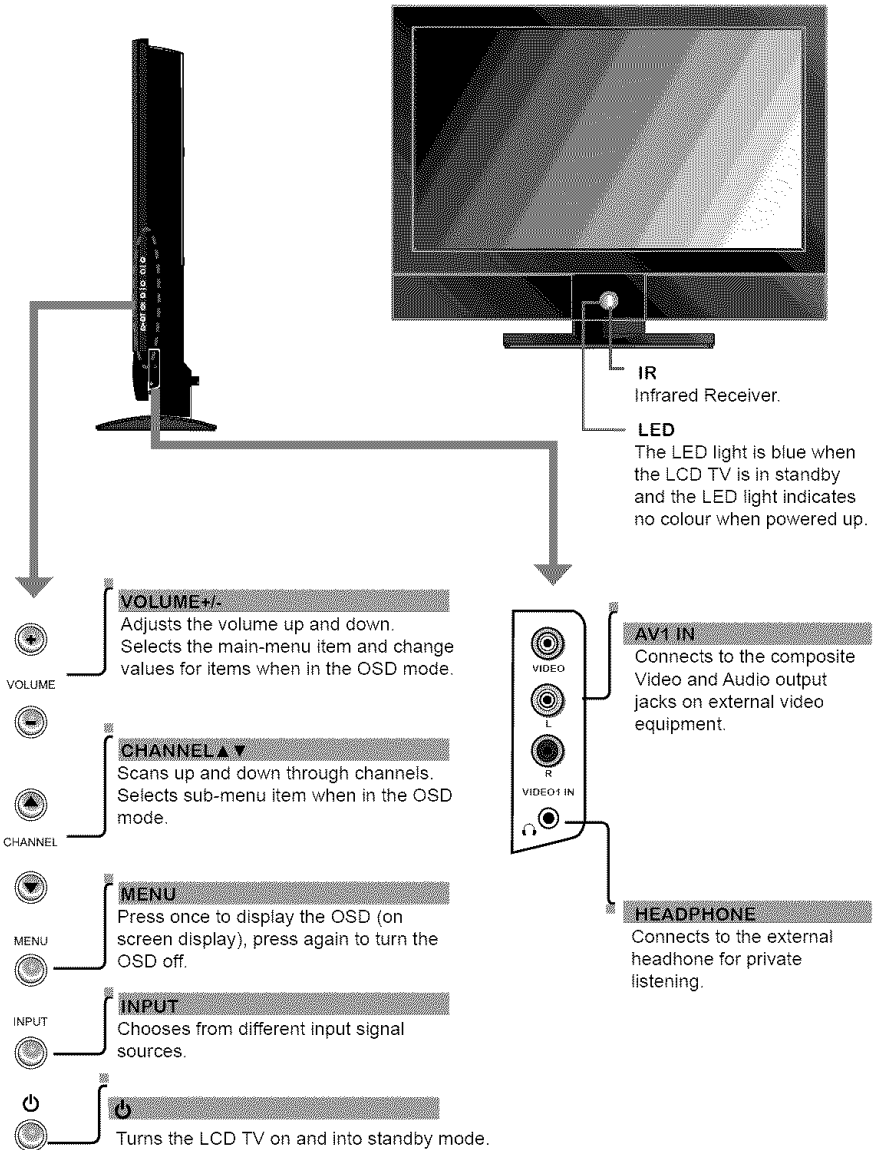

Rear View and Jacks

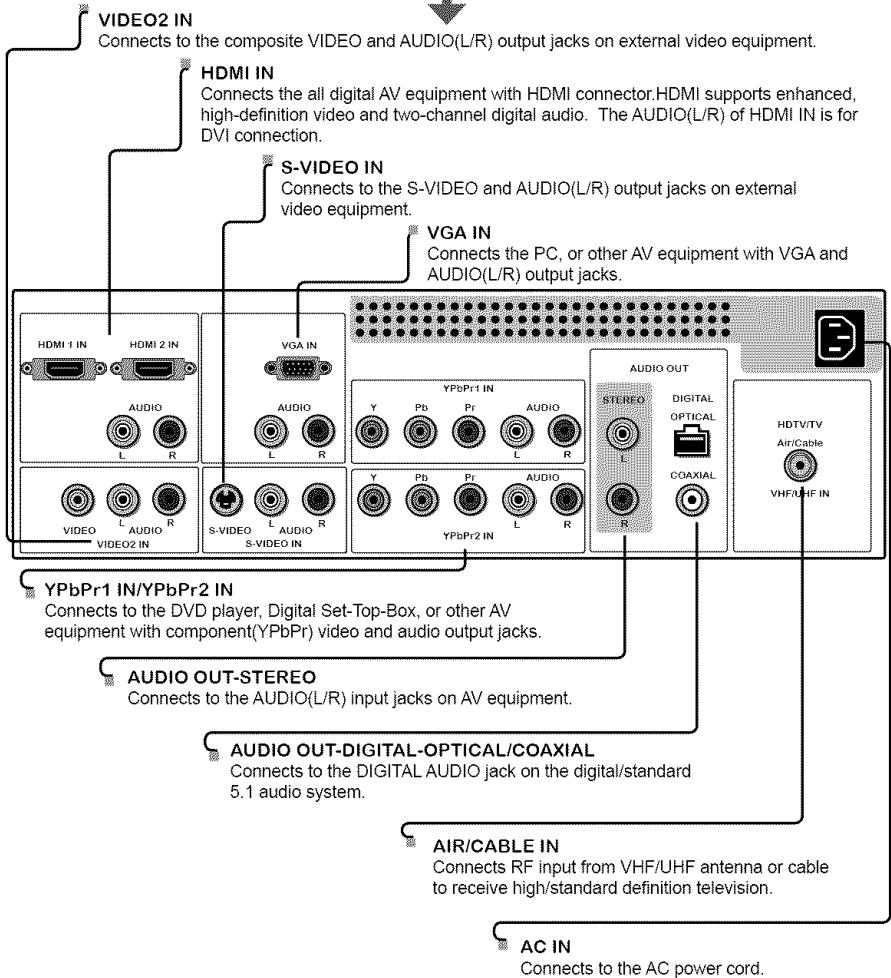
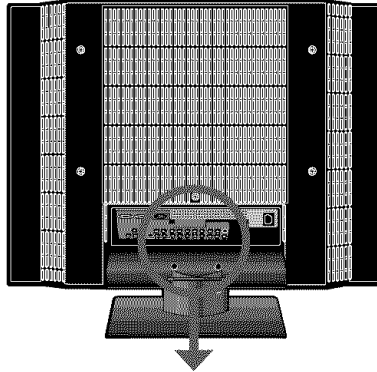

Your Remote Control

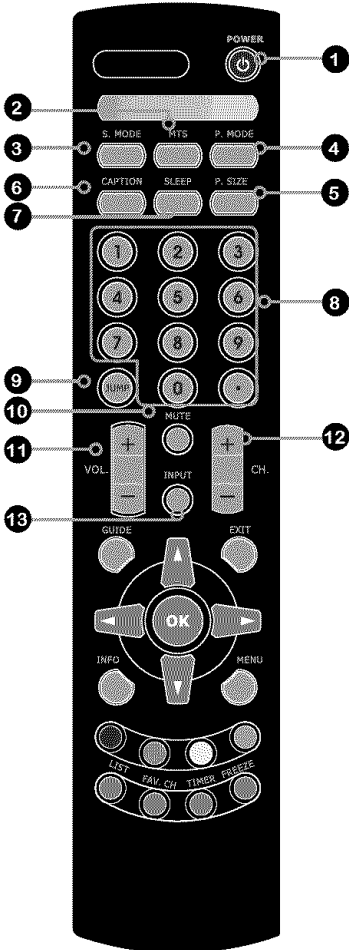

845-042-GF1XABH

- 1** Turns the LCD TV on and off.
- 2** **MTS** Cycles through the multi-channels TV sound(MTS) options: SAP/MONO/STEREO
- 3** **S.MODE** Selects sound effect options: Surround/Live/Dance/Techno/Classic/Soft/Rock/Pop/Off.
- 4** **P.MODE** Selects picture mode: Vivid/Hi-Bright/Cinema/Sport/User
- 5** **P.SIZE** Cycles through Wide mode settings : NORMAL /FULL/WIDE
- 6** **CAPTION** Cycles through the Closed Caption:
 ▪ Analog Closed Caption:CC1/CC2/CC3/CC4/T1/T2/T3/T4/Off
 ▪ Digital Closed Caption:Service1/Service2/Service3/Service4/Service5/Service6/Off
- 7** **SLEEP** Cycles through the LCD TV sleep timer: OFF/10/20/30/40/50/60/90/120 mins
- 8** **0-9** Select and switch to a channel by using 0-9 buttons.
- In HDTV mode, use with 0-9 and • buttons to select a digital channels.
- 9** **JUMP** Returns to previously selected channel.
- 10** **MUTE** Mutes and restores the audio
- 11** **VOL.+/-** Increases and decreases volume.
- 12** **CH.+/-** Scans up and down the channels
- 13** **INPUT** Pressing **INPUT** display the source list, use **▲▼** to select the video equipment connected to the video inputs of your LCD TV : TV/VIDEO1/VIDEO2/VIDEO3/VIDEO4/VIDEO5/VIDEO6/VIDEO7/COMPUTER

Input Source
✓ TV(CABLE/AIR)
VIDEO1 (SIDE)
VIDEO2 (REAR)
VIDEO3 (S-VIDEO)
VIDEO4 (YPbPr1)
VIDEO5 (YPbPr2)
VIDEO6 (HDMI1)
VIDEO7 (HDMI2)
COMPUTER(VGA)

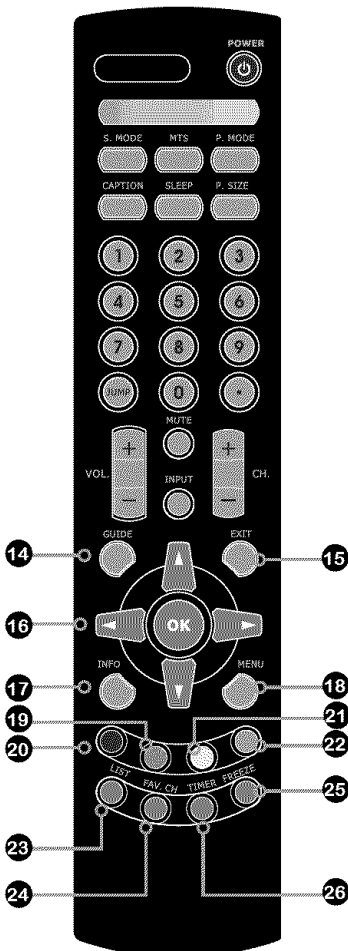

14 GUIDE Displays the Program Guide on the screen. Pressing again to turn GUIDE off.

15 EXIT Exits the OSD menu.

16 ▲▶▶▶◀◀◀ OK Cycles through OSD options and selects individual menu items. **OK** confirms option settings.

17 INFO Pressing repeatedly displays a variety of information such as the current channel and the input source.

18 MENU Displays the OSD menu on the screen.

19 ● GREEN In Program Guide, press to select first program of next day.

20 ● RED In Program Guide, press to select first program of previous day.

21 ● YELLOW In Program Guide, press to view previous page of detailed program description.

22 ● BLUE In Program Guide, press to view next page of detailed program description.

23 LIST Displays the received channel list

Channel List	
7-1	KABC-DT
8-1	KOED-HD
8-2	KOED-SD
8	GCT
12	
13	
15	

24 FAV.CH Pressing **FAV.CH** display favorite channels.

25 FREEZE In TV mode, pressing **FREEZE** to freeze the current picture, press again to restore the picture.

26 TIMER Displays the current time on the screen.



Effective range:

The remote can control the LCD TV from up to 5m away, if pointed directly at the receiver.

Chapter 2

Installing the LCD TV

Refer to the owner's manual of any external equipment to be connected.

When connecting any external equipment, do not connect any AC power cords to wall outlets until all other connections are completed.

Connecting a TV Cable or an Antenna

Antenna Connection

The antenna requirements for good color TV reception are more important than those for a black & white TV reception. For this reason, a good quality outdoor antenna is strongly recommended. The following is a brief explanation of the type of connection that is provided with the various antenna systems.

- A 75-ohm system is generally a round cable (not included) with F-type connector that can easily be attached to a terminal without tools.

F-type connector



75-ohm coaxial cable (round)

- A 300-ohm system is a flat twin-lead cable (not included) that can be attached to a 75-ohm terminal through a 300-75-ohm adapter (not included).

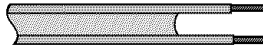

300-ohm twin-lead cable (flat)

Use one of the following two diagrams when connecting an outdoor antenna.

A: Shows how to use a VHF/UHF combination outdoor antenna.

B: Shows how to use a separate VHF and/or UHF outdoor antenna.

A. Combination VHF/UHF antenna

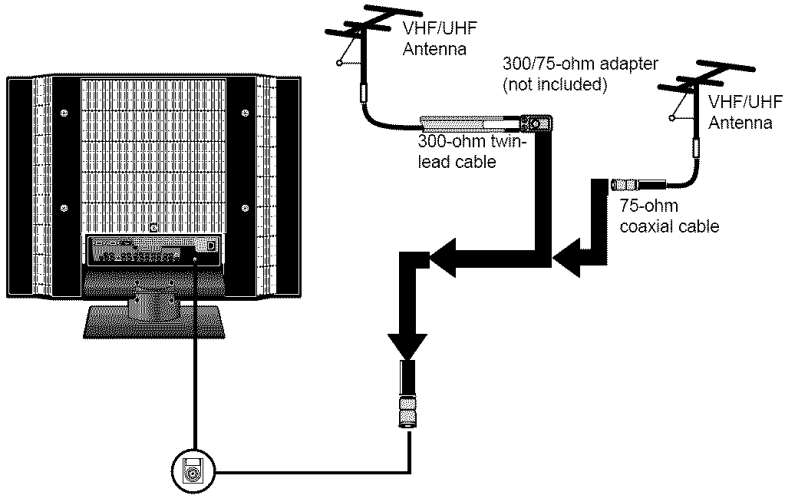

B. Separate VHF and/or UHF antennas

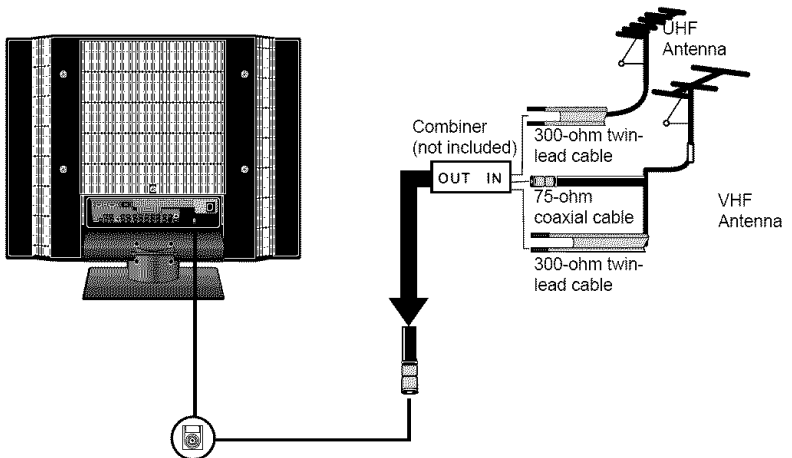

Cable TV (CATV) Connection

This reminder is provided to call the CATV system installer's attention to Article 820-40 of the National Electrical Code (NEC) that provides guidelines for proper grounding and, in particular, specifies that the cable ground shall be connected to the grounding system of the building accurately, or as close to the point of cable entry as possible. Use of this TV for other than private viewing of programs broadcasted on UHF, VHF or transmitted by cable companies for the use of the general public may require authorization from the broadcast/cable company, and/or program owner.

- **A 75-ohm coaxial cable connector is built into the set for easy hookup. When connecting the 75-ohm coaxial cable to the set, connect the 75-ohm cable into the ANT. terminal.**
- **Some cable TV companies offer premium pay channels. Since the signals of these premium pay channels are scrambled, a cable TV converter/descrambler is generally provided to the subscriber by the cable TV company.**

This converter/descrambler is necessary for normal viewing of scrambled channels. (Set your TV to channel 3 or 4, typically one of these channels is used. If this is unknown, consult your cable TV company.)

For more specific instructions on installing cable TV, consult your cable TV company. One possible method of connecting the coverter/descrambler provided by your cable TV company is shown in the diagram below.

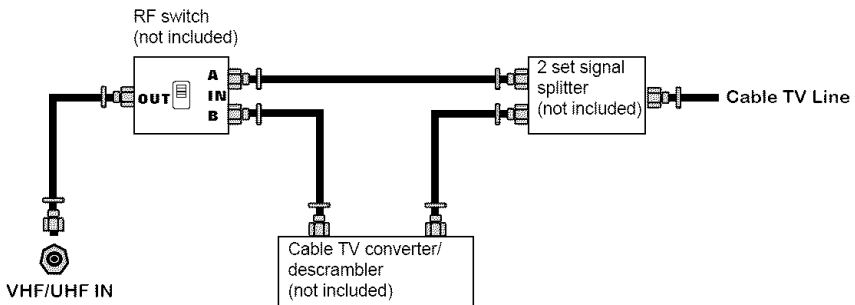

- **The RF switch (not included) is required to provide two inputs (A and B). Setting the RF switch to position A allows viewing of all unscrambled channels by using the TV channel keys.**
- **Setting the RF switch to position B allows viewing of all scrambled channels via the converter/descrambler by using the converter channel keys.**

- 1 Use a supplied antenna cable to connect the TV signal to the LCD TV's TV CABLE terminal.

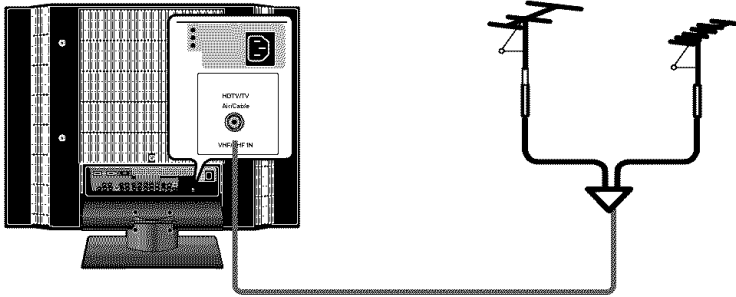

- 2 Connect the AC power cord at the back of the TV and connect the power cord to wall outlet.

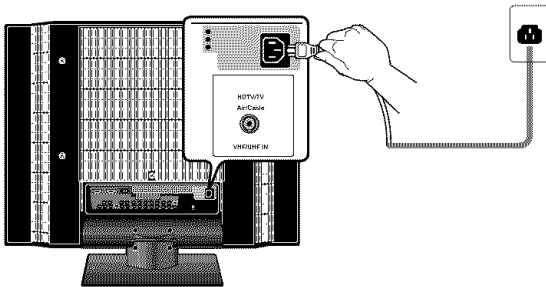

- 3 Press the ^{POWER} button on the remote to turn on the LCD TV.

 Always disconnect the LCD TV from the main voltage when the LCD TV will not be used for a long period of time. The POWER button on the front panel is only used for switching the LCD TV into standby, it does not disconnect the device from the main voltage. To completely disconnect the main voltage, please remove the power plug from the socket.

- 4 Press the **INPUT** button on the remote to display the Input Source List. Use the **▲▼** buttons to select **TV** and press the **OK** button.

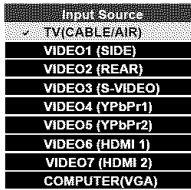

- 5 Press the **MENU** button on the remote control to display the Main menu, and use the **◀▶** buttons to select the **TV**.

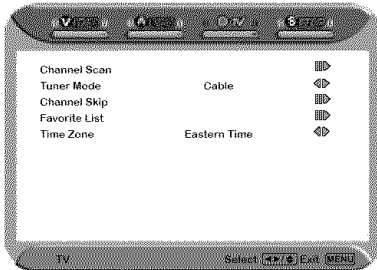

- 6 Press the **▼** button to select **Channel Scan**, and press the **OK** button. The **Channel Scan** automatically creates a list of receivable channels. Press the **MENU** button at any time to interrupt the memorization process (the list cannot be created if interrupted)

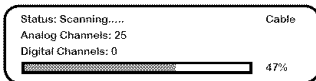

! The Channel Scanning will create a list of receivable channels for the current input (antenna or cable). You will be required to run Channel Scanning for each RF input to create a list of available channels from both inputs.

- 7 Press the **OK** button to display the received channel list. Then press **▲▼** to select a channel and press again the **OK** button to display the channel detail.

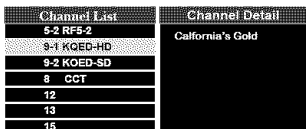

Or, use the **• (Input)** button with **0-9** buttons to select digital channel(for example 9.1)

! The digital main channel might include many subchannels (for example 9-1, 9-2. .) that are showing program at the same time.

Connecting a VCR

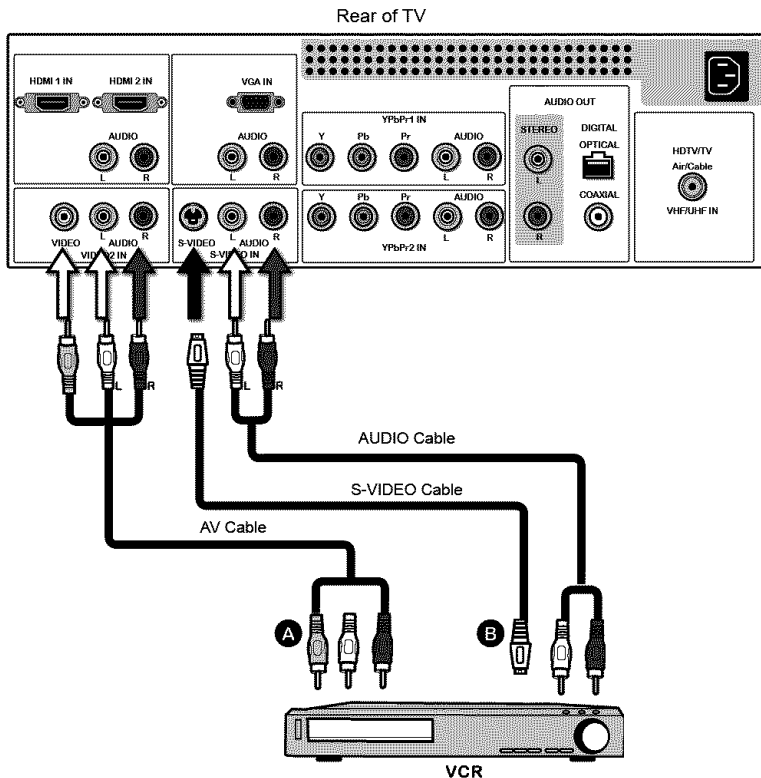

1

METHOD A:

Use a composite cable to connect the VCR's composite video/audio jacks to the LCD TV's VIDEO2 IN jacks.

METHOD B:

Use an audio cable to connect the VCR's audio output jacks to the LCD TV's audio inputs. Use a S-Video cable to connect the VCR's s-video output jack to the LCD TV's S-VIDEO IN input jack.

2

Connect all AC power sources, before turning on the power switch of the LCD TV or other connected equipment.

3

Press the  button on the remote to turn on the LCD TV.

4

To watch a videotape, press the **INPUT** button on the remote to select **VIDEO2**(METHOD A), or **VIDEO3** (METHOD B).

Connecting a Video Camera or Game console

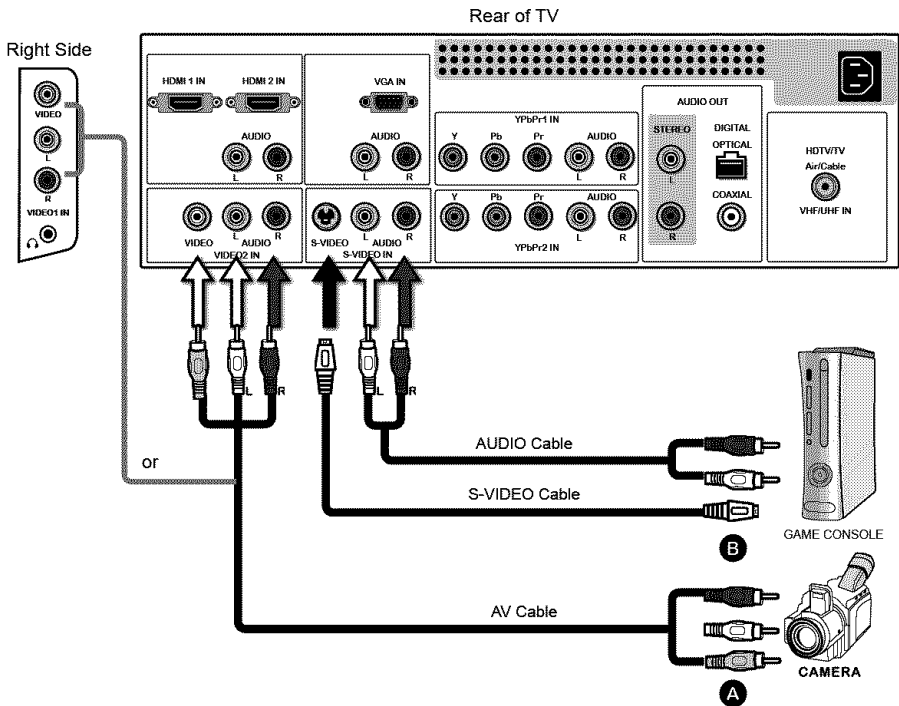

1

METHOD A:

Use a composite cable to connect the video camera's or game console's composite video/audio jacks to the LCD TV's VIDEO2 IN jacks or VIDEO1 IN jacks.

METHOD B:

Use an audio cable to connect the video camera's or game console's audio output jacks to the LCD TV's audio inputs. Use an S-Video cable to connect the video camera's or game console's s-video output jack to the LCD TV's S-VIDEO IN input jack.

2

Connect all AC power sources, before turning on the power switch of the LCD TV or other connected equipment.

3

Press the  button on the remote to turn on the LCD TV.

4

To watch a video vis camera or game console, press the **Input** button on the remote to select **VIDEO2/VIDEO1**(METHOD A), or **VIDEO3** (METHOD B).



Not all cameras have the ability to connect to a TV. Please check your video camera user guide for compatibility.

Connecting a DVD Player

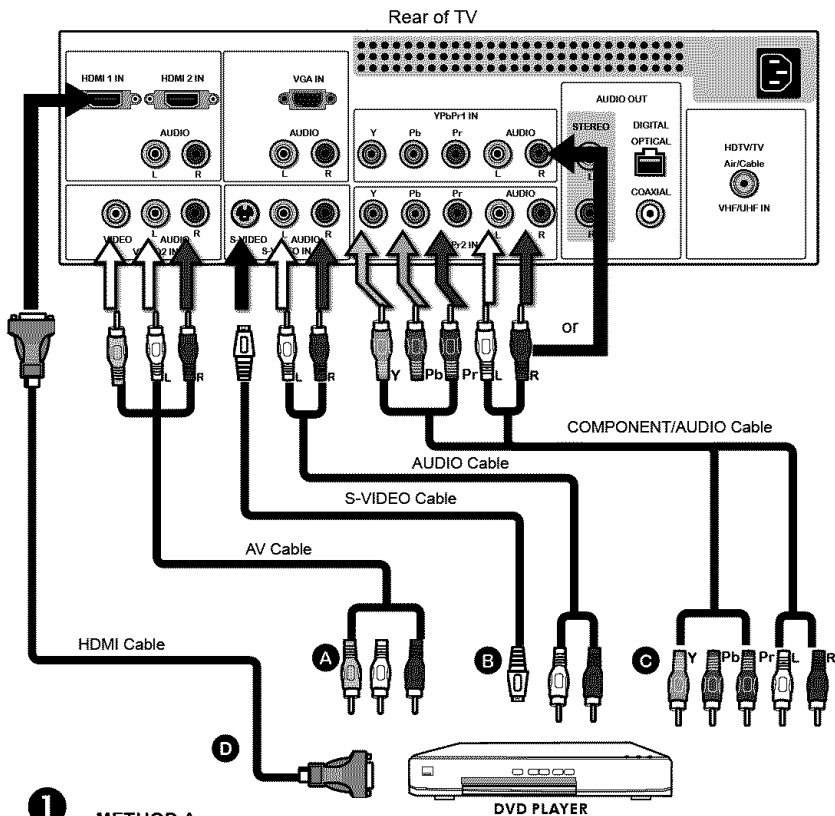

1

METHOD A:

Use a composite cable to connect the DVD player's composite video/audio jacks to the LCD TV's VIDEO2 IN jacks.

METHOD B:

Use an audio cable to connect the DVD player's audio output jacks to the LCD TV's audio inputs. Use an S-Video cable to connect the DVD player's s-video output jack to the LCD TV's S-VIDEO IN input jack.

METHOD C:

Use a component cable to connect the DVD player's component output jacks to the LCD TV's YPbPr1 IN or YPbPr2 IN input jacks.

Use an audio cable to connect the DVD player's component audio jacks to the LCD TV's audio input jacks.

METHOD D:

Use a HDMI cable to connect the DVD player's HDMI output jacks to the LCD TV's HDMI 1 IN or HDMI 2 IN input jacks.



The component video jacks on your DVD player are sometimes labeled YPbPr, or YCbCr. For an explanation of component video, see your DVD player's user guide.

- 2 Connect all AC power sources, before turning on the power switch of the LCD TV or other connected equipment.
- 3 Press the  button on the remote to turn on the LCD TV.
- 4 To watch a DVD, press the **Input** button on the remote to select **VIDEO2**(METHOD A), or **VIDEO3** (METHOD B), or **VIDEO4/VIDEO5** (METHOD C).



For best picture quality, if your equipment has component video output, use a component cable instead of a composite video or S-video cable.

Connecting a Digital TV Cable Box or Digital Satellite Receiver

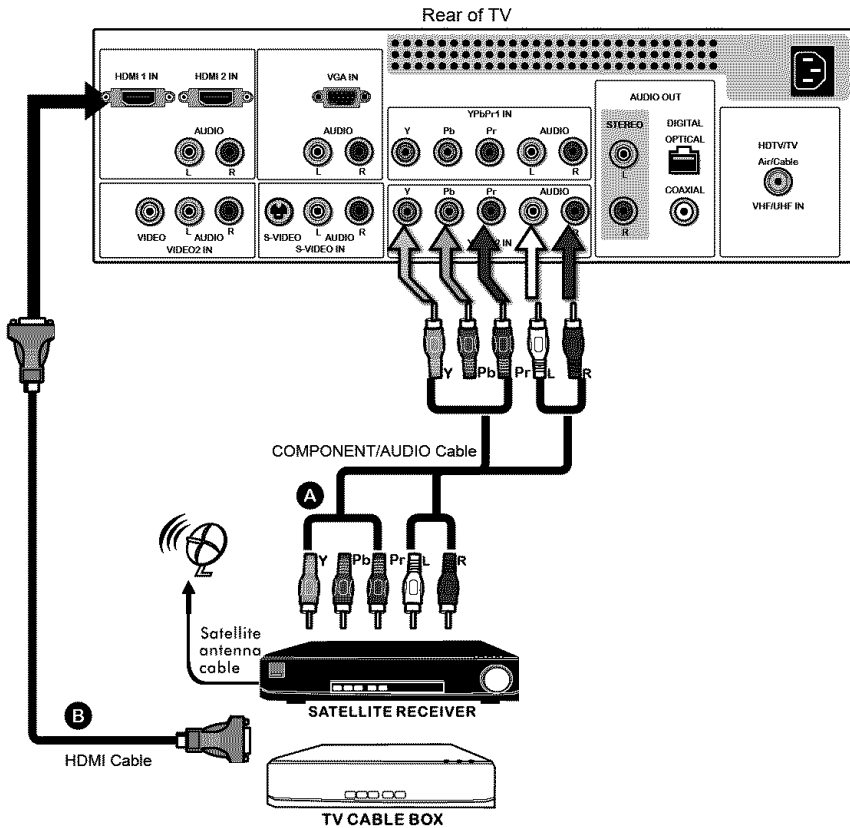

1

METHOD A:

Use a component cable to connect the satellite receiver's/TV Cable Box's component (YPbPr1) output jacks to the LCD TV's component input jacks. Use an audio cable to connect the satellite receiver's/TV Cable Box's component audio jacks to the LCD TV's audio input jacks.

METHOD B:

Use a HDMI cable to connect the satellite receiver's/TV Cable Box's HDMI output jacks to the LCD TV's HDMI 1 IN or HDMI 2 IN input jacks.

2

Connect all AC power sources, before turning on the power switch of the LCD TV or other connected equipment.

3

Press the  button on the remote to turn on the LCD TV.

4

To watch programs via satellite receiver or TV Cable Box, press the **Input** button on the remote to select **VIDEO4/VIDEO5**.

Connecting an AV Equipment with HDMI Connector

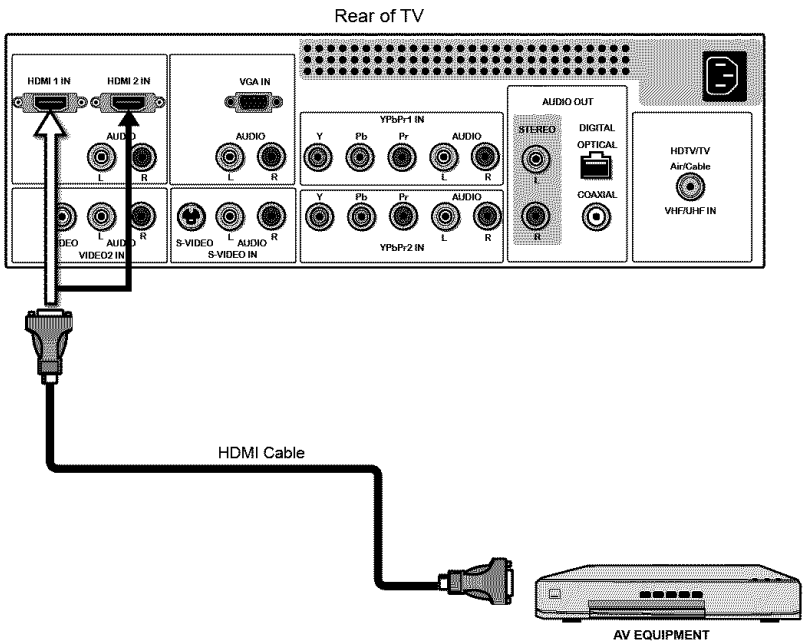



- 1 Use a HDMI cable to connect the AV equipment's HDMI output jack to the LCD TV's HDMI IN jacks.
- 2 Connect all AC power sources, before turning on the power switch of the LCD TV or other connected equipment.
- 3 Press the ^{POWER} button on the remote to turn on the LCD TV.
- 4 Press the **Input** button on the remote to select **VIDEO6**.

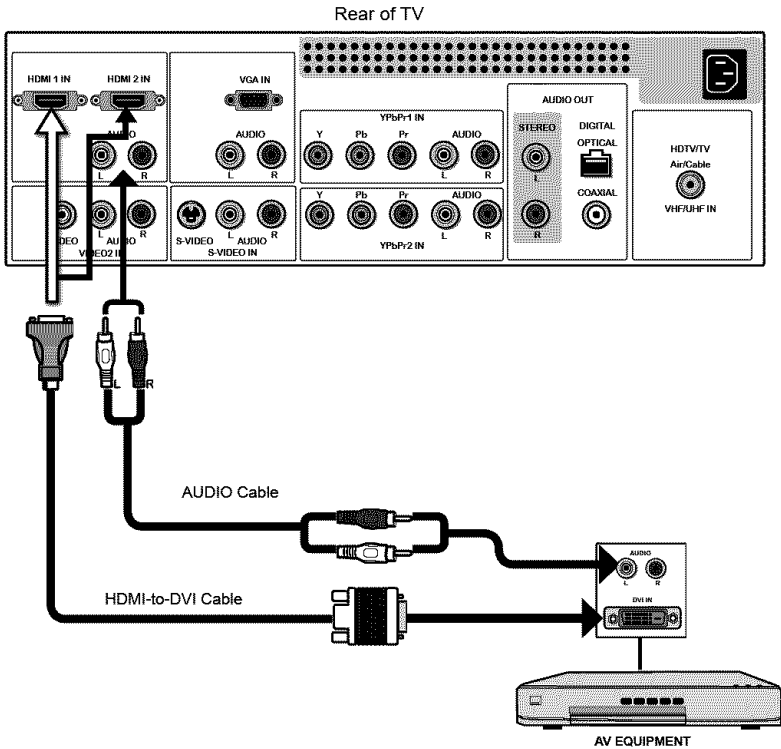

The HDMI connector provides both video and audio signals, it's not necessary to connect the audio cable.

Connecting an AV Equipment with DVI Connector



- 1 Use a HDMI-to-DVI cable to connect the AV equipment's DVI output jack to the LCD TV's HDMI IN jacks.
Use an audio cable to connect the AV equipment's audio output jacks to LCD TV's HDMI AUDIO jacks.
- 2 Connect all AC power sources, before turning on the power switch of the LCD TV or other connected equipment.
- 3 Press the  button on the remote to turn on the LCD TV.
- 4 Press the **Input** button on the remote to select **VIDEO6**.

 If the LCD TV is connected to AV equipment's DVI connector, you will need an HDMI-to-DVI cable or an HDMI adapter(not supplied) and an audio cable.

Connecting a PC

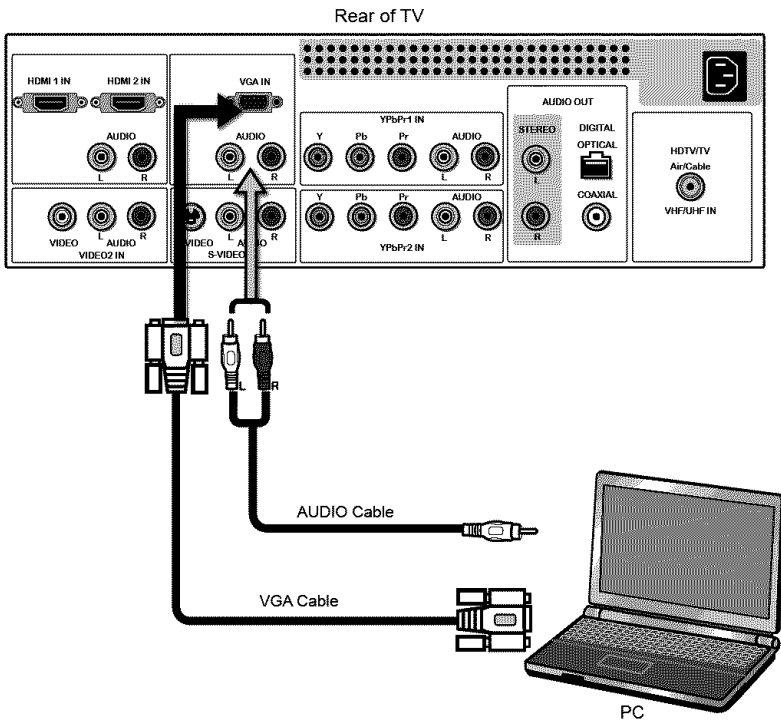

- 1 Use a D-SUB cable to connect the PC's D-SUB output jack to the LCD TV's VGA input jack. Use an audio cable to connect the PC's audio output jacks to LCD TV's.
- 2 Connect all AC power sources, before turning on the power switch of the LCD TV or other connected equipment.
- 3 Press the  button on the remote to turn on the LCD TV.
- 4 Press the **Input** button on the remote to select **COMPUTER**.

Connecting an Audio Receiver or a Dolby Digital 5.1 Sound System

For better sound quality, you may want to play the LCD TV audio through your stereo system.

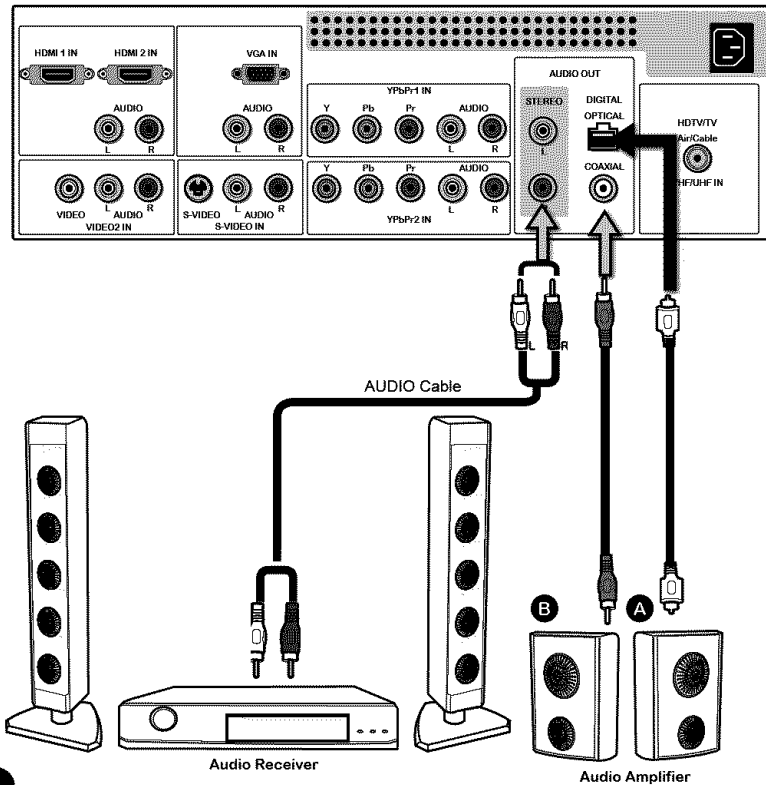

- 1** **Connecting to Audio Receiver:**
Use an audio cable to connect the audio receiver's audio LINE IN jacks to LCD TV's AUDIO OUT jacks.
- 2** **Connecting to Digital 5.1 Sound System:**
METHOD A:
Use a optical cable to connect the audio amplifier's OPTICAL IN jacks to LCD TV's OPTICAL OUT jacks.
METHOD B:
Use a coaxial cable to connect the audio amplifier's COAXIAL IN jacks to LCD TV's COAXIAL OUT jacks.
- 3** Connect all AC power sources, before turning on the power switch of the LCD TV or other connected equipment.
- 4** Press the  button on the remote to turn on the LCD TV.

Chapter 3

USING THE FEATURES

Wide Screen Viewing

Wide Screen function allows viewing of 4:3/16:9 images in wide screen mode, cycling through the following wide screen settings. Press the **P.SIZE** button repeatedly to select the screen format you want.

1

FULL

Stretches the image vertically and horizontally to keep the image size consistent in the center of the screen and stretches the sides

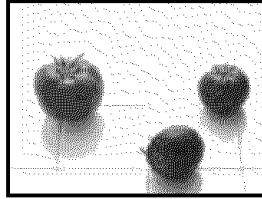

2

WIDE

Stretches the image vertically and horizontally to fill the screen at 1:1.85 aspect ratio

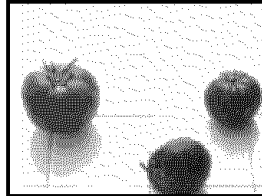

3

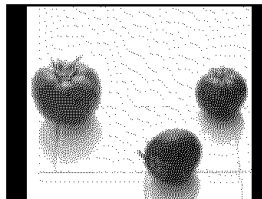

NORMAL

Displays at 4:3 aspect ratio



NORMAL is not available when you are watching 720p, 1080i, source.

Operating the Menu

- 1 Press the  button to turn the LCD TV on.
- 2 Press the **MENU** button on the remote control, the on-screen menu will appear on the screen. Use the   buttons to select your main menu option.

VIDEO MENU:

Allows you to make adjustments to your picture settings.

- If the signal source is TV/VIDEO/S/VIDEO/YPbPr/HDMI, the VIDEO MENU appears as:

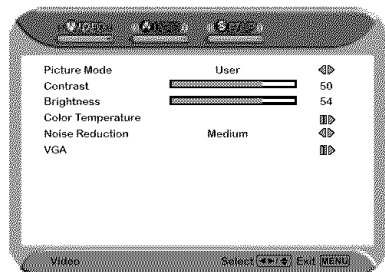
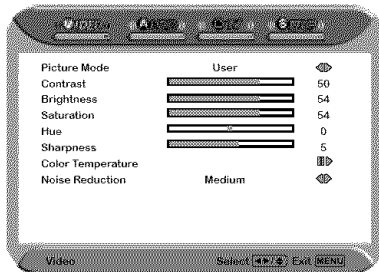

AUDIO MENU:

Allows you to customize the audio options and effects.

- If the signal source is VIDEO/S/VIDEO/YPbPr/HDMI/VGA, the AUDIO MENU appears as:

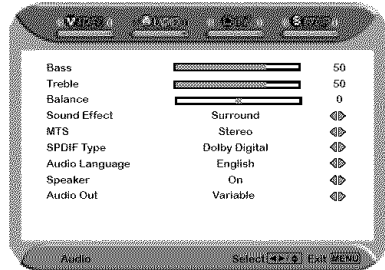
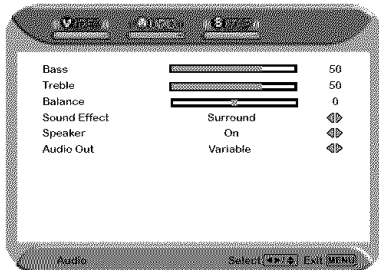

TV MENU:

Allows you to edit and label channels.

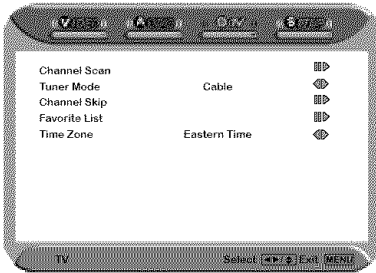
**SETUP MENU:**

Allows you to set up a variety of features: Language, Closed Caption, reset, Parental Control, time Setup.

• If the signal source is TV/VIDEO/S-VIDEO/Ypbpr,

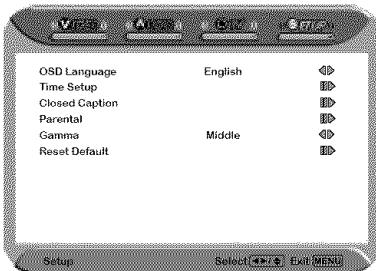

• if the signal source is HDMI/VGA, the SETUP MENU appears as:

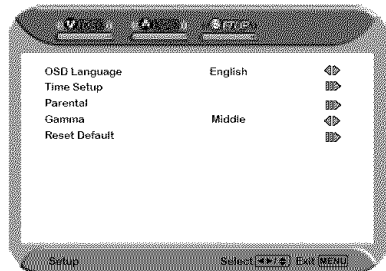

- 3** Use the ▲▼ buttons to highlight the option of the sub-menu, and press the **OK** button. While in adjustment mode, and use the ◀▶ buttons to change the value of the item.
- 4** Press the **EXIT** button to exit the menu.

Customizing the VIDEO Settings

- 1 Press the **⏻** button to turn the LCD TV on.
- 2 Press the **MENU** button on the remote control to display the Main menu, and use the **◀▶** buttons to select the **VIDEO**.
- 3 Use the **▲▼** buttons to highlight an individual VIDEO option, use the **◀▶** buttons to change the setting, and press the **MENU** to exit the menu

• If the signal source is TV/VIDEO/S-VIDEO/Ypbpr/HDMI, the VIDEO MENU appears as:

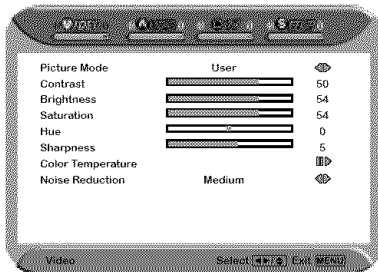

• if the signal source is VGA, the VIDEO MENU appears as:

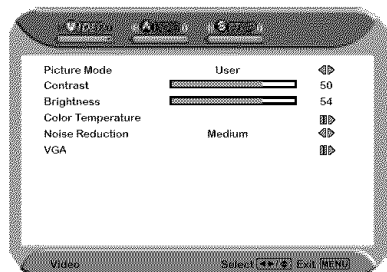

- 4 The **VIDEO** menu includes the following options:

Picture Mode	Cycles among display types: Vivid/Hi-Bright/Cinema/Sport/User
Contrast	Controls the difference between the brightest and darkest regions of the picture
Brightness	Controls the overall brightness of the picture
Saturation	Controls the color intensity
Hue	Controls the difference between the green and red regions of the picture
Sharpness	Increase this setting to see crisp edges in the picture; decrease it for soft edges

- Color temperature** Adjusts color components independently to achieve a warm or cool effect: Cool/Middle/Warm/User
- **Warm**: Increases red tint
 - **Nature**: Increases natural tint
 - **Cool**: Increases blue tint
 - **User**: Allows the user to adjust red, green and blue color component levels independently.

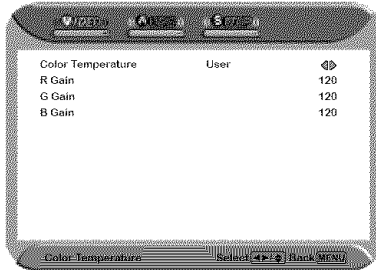

- Noise Reduction** Select to reduce the noise level of connected equipment: Off/Low/Strong /Medium.

VGA

Press the **OK** button to enter the VGA Setting:

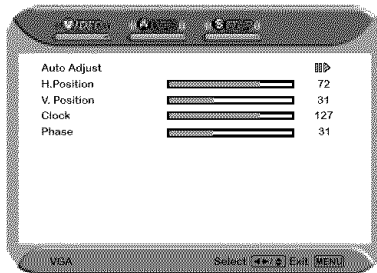

- **Auto Adjust** Press the **OK** button to automatically adjust the display setting to optimize performance based on the VGA mode
- **H. Position** Adjusts the position of the picture left and right in the window
- **V. Position** Adjusts the position of the picture up and down in the window
- **Clock** Controls the width of the picture based on the VGA mode
- **Phase** Controls the signal phase, which can improve focus clarity and image stability based on the VGA mode

Customizing the AUDIO Settings

- 1 Press the **⏻** button to turn the LCD TV on.
- 2 Press the **MENU** button on the remote control to display the Main menu, and use the **◀▶** buttons to select the **AUDIO**.
- 3 Use the **▲▼** buttons to highlight an individual AUDIO option, use the **◀▶** buttons to change the setting, and press the **MENU** to exit the menu

• If the signal source is VIDEO/S-VIDEO/Ypbpr/HDMI/VGA, the AUDIO MENU appears as:

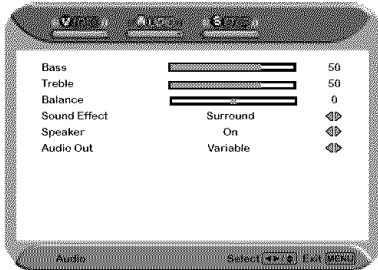

• if the signal source is TV, the AUDIO MENU appears as:

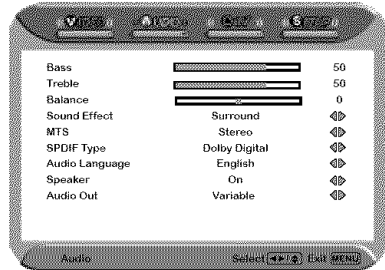

OR

- 4 The **AUDIO** menu includes the following options:

Bass	Controls the relative intensity of lower-pitched sounds
Treble	Controls the relative intensity of higher pitched sounds
Balance	Adjusts the relative volume of the speakers in a multiple speaker system
Sound Effect	Allows selection of an audio-enhancement technique from among the following options: Surround/Live/Dance/Techno/Classic/Soft/Rock/POP/Off
MTS	Allows you to listen to high-fidelity stereo sound while watching TV <ul style="list-style-type: none"> • Stereo: Use separate audio tracks for left and right speakers, if available • SAP: You can enjoy a second audio program from the speakers while watching a scene in the original program • Mono: Allows mono output (useful when stereo is noisy or inconsistent)

SPDIF Type	Allows to selection of the digital sound format: PCM/OFF/Dolby Digital <ul style="list-style-type: none">▪ PCM: The external audio system is connected to the AUDIO OUT (L/R) of the LCD TV▪ Dolby Digital: The external audio system is connected to the AUDIO OUT DIGITAL (OPTICAL or COAXIAL) of the LCD TV▪ OFF: Select OFF to turn off the external audio system
Audio Language	Allows to select the audio language:English/Spanish/French.
Speaker	Allows to select to turn on or off the TV speakers.

Customizing the TV Settings

- 1 Press the **⏻** button to turn the LCD TV on.
- 2 Press the **MENU** button on the remote control to display the Main menu, and use the **◀▶** buttons to select the **TV**.
- 3 Use the **▲▼** buttons to highlight an individual TV option, use the **◀▶** buttons changes the setting, and press the **MENU** exits the menu.

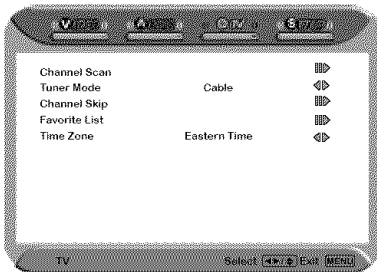

- 4 The **TV** menu includes the following options:

Channel Scan Press the **OK** button, the Channel Scanning automatically creates a list of receivable channels.

Tuner Mode Allows selection between TV cable and antenna signal sources:

- **AIR**
Choose this setting if you are receiving TV channels with an antenna (over the air)
- **Cable**
Choose this setting if you are receiving TV channels with a CATV (cable TV)

Channel Skip Allows addition/removal of channels on the channel list.

- 1 Press the **OK** button to display the Channel Skip menu:

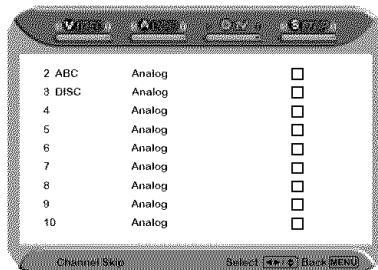

- 2 Press the ▼ button to select the desired channel, and press the OK button repeatedly to select show (☑) or hide(□)

Favorite List

- 1 Select **Favorite List** from the TV option and press the OK button. The Favorite List menu appears:

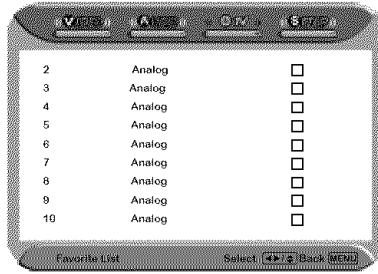







- 2 Press the ▼ button to select the desired channel, and press the OK button repeatedly to select show (☑) or hide(□)

Time Zone

Allows selection of regional TV systems of USA: Eastern Time/Indiana/Central time/Mountain Time/Arizona/Pacific Time/Alaska/Hawaii

Customizing the SETUP Settings

- 1 Press the  button to turn the LCD TV on.
- 2 Press the **MENU** button on the remote control to display the Main menu, and use the   buttons to select the **SETUP**.
- 3 Use the   buttons to highlight an individual SETUP option, use the   buttons to change the setting, and press the **MENU** to exit the menu.

• If the signal source is TV/VIDEO/S-VIDEO/Ypbpr, the SETUP MENU appears as:

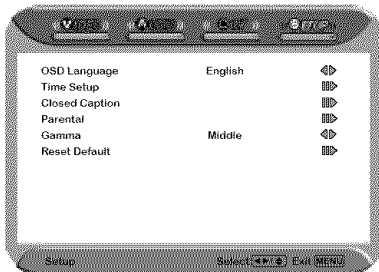



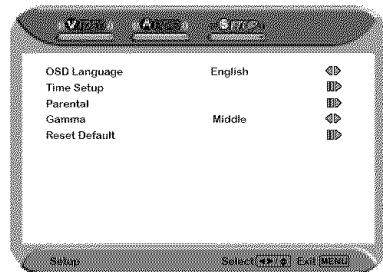

• If the signal source is HDMI/VGA, the SETUP MENU appears as:



- 4 The **SETUP** menu includes the following options:

OSD Language Selects to display all on-screen menus in your language of choice: English/French/Spanish

Time Setup Allows to set the current time.

- **ON** :Selects to display the system current time.
- **OFF** :Selects to set the current time.
 - 1 Press the   buttons to select the Date or Time.
 - 2 Press the   buttons to move each setting, and use 0-9 keys to set the current time.

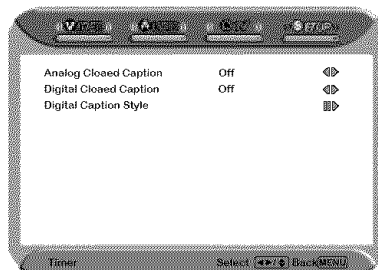

Closed Caption

Allows to select from analog or digital closed caption modes and press the **OK** button. The Closed Caption list appears:

1 Analog Closed Caption:

Press the ◀▶ buttons to select the basic analog closed caption options:

- **CC1 /CC2 /CC3 /CC4:**
Display a printed version of the dialog and sound effects of the program being viewed
- **T1/T2:**
Display station information presented using either half or the whole screen
- **T3/T4:**
Extended Data Services. For example: Network name, program name, program length, etc.

2 Digital Closed Caption:

Press the ◀▶ buttons to select the digital closed caption options: Service1/Service2/Service3/Service4/Service5/Service6/OFF

Note: The setting here will be applied to each DTV channel

3 Caption Style:

Press **OK** button to customize the settings for digital closed caption option:

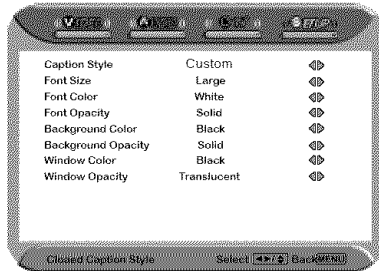

Parental

The Parental Control can be set up to the TV to block Channel, Video Source and to change password.

- ❶ Use the ▼ button to select the **Parental**, and press the **OK** to display the Parental menu
- ❷ Use the **Program Block** function, must enter a four-digit password. The factory password is 0000
- ❸ The Parental list appears:

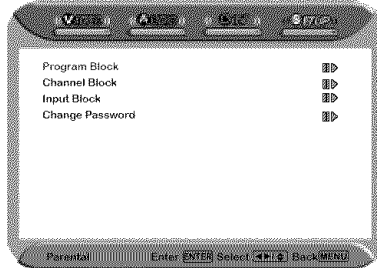

- **Program Block**

Allows to setup the TV and MPAA Rating Lock options (refer to "Using the Program Block Setting").

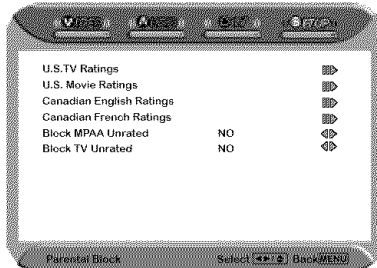

- **Channel Block** Allows to block digital channels.

- ❶ Press the ▲▼ buttons to select the channel.
- ❷ Press the **OK** button repeatedly to select **BLOCK** or **UNBLOCK** .

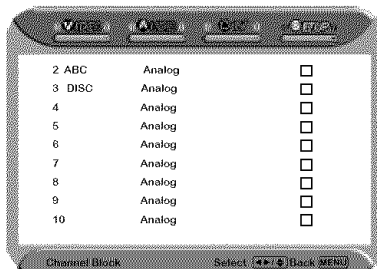

- **Input Block** Selects to block a Input source signal

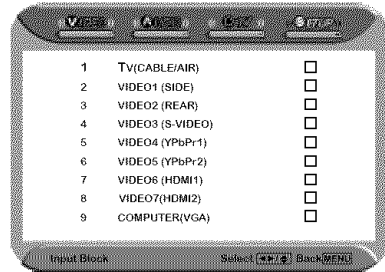

- 1 Press the ▲▼ buttons to select the input source.
 - 2 Press the OK button repeatedly to select **BLOCK** or **UNBLOCK** .
- **Open V-Chip** Selects to block program based on downloadable ratings are blocked from viewing.(this function is only available in U.S.A . where the Open V-Chip ratings exist)
 - 1 Press the OK button to display the Open V-Chip options.

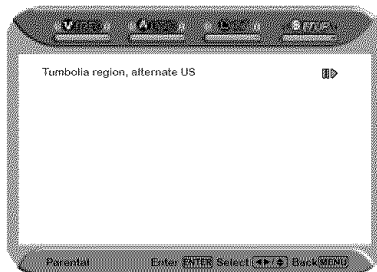

- 2 Press the ▲▼ buttons to select the downloadable rating system, and press OK button.
- 3 Press the OK button repeatedly to select **BLOCK** or **UNBLOCK**. The Open V-Chip function is automatically downloaded while watching DTV channels. It may take several seconds. The rating name(for example: humor level, intelligence level .etc) and rating level(for example:DH, MH, H..etc) may differ depending on the information from broadcasting station.

- **Change Password** Selects to change your password

Gamma Allows adjustment of the display's gamma correction, which fine tunes both brightness and red/green/blue ratios: Bright/Middle/Dark.

Reset Default Press the OK button to restore factory settings

Using the Program Block Settings

- 1 Press the **MENU** button on the remote control to display the Main menu, and use the **◀▶** buttons to select the **SETUP**.
- 2 Use the **▼** buttons to highlight **Parental**, and press the **OK** button.

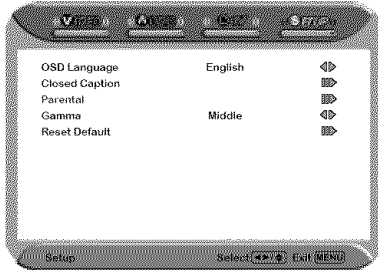

- 3 Use the **Parental** function, must enter a four-digit password. The factory password is 0000.

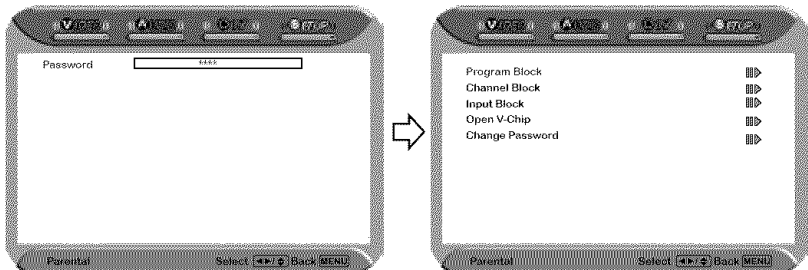

- 4 Use the **▼** button to select the **Program Block**, and press the **OK** to display the Program Block menu.

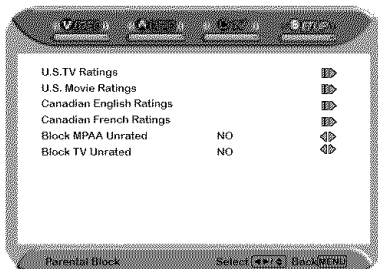

5

The **Parental block** menu includes the following options:

U.S. TV Ratings	Selects to activate the TV Rating programs.
U.S. Movie Ratings	Selects to activate the MPAA Rating programs.
Canadian English Ratings	Selects to activate the English Rating programs of Canada.
Canadian French Ratings	Selects to activate the French Rating programs of Canada.
Block MPAA Unrated	<ul style="list-style-type: none"> ▪ YES: Block all movies that are broadcast without a MPAA rating. ▪ NO: Allows all movies that are broadcast without a MPAA rating
Block TV Unrated	<ul style="list-style-type: none"> ▪ YES: Block all movies that are broadcast without a TV rating. ▪ NO: Allows all movies that are broadcast without a TV rating.

U.S. TV Ratings

The U.S.TV Rating has 2 rating methods: Content-Based Rating and Age-Based Rating. The U.S.TV Rating includes the following options:

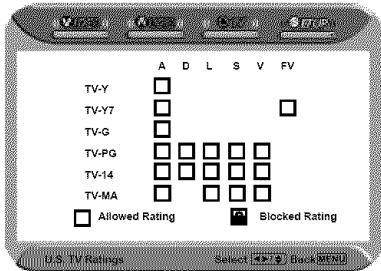

AGE-BASED

RATING	DESCRIPTION
TV-Y	All children
TV-Y7	Directed to children age 7 and older
TV-G	General Audience
TV-PG	Parental Guidance suggested
TV-14	Parents strongly cautioned
TV-MA	Mature Audience only

CONTENT-BASED

RATING	DESCRIPTION
FV	Fantasy violence
D	Suggestive dialogue
L	Strong language
S	Sexual situations
V	Violence
ALL	All contents are blocked

		CONTENT-BASED				
		FV	D	L	S	V
AGE-BASED	TV-Y					
	TV-Y7	✓				
	TV-G					
	TV-PG		✓	✓	✓	✓
	TV-14		✓	✓	✓	✓
	TV-MA			✓	✓	✓

✓ : To block programs by both content and age.



Use the ◀▶▲▼ buttons to select the rating you want and press the OK button repeatedly to select BLOCK [OK] or UNBLOCK [OK].

U.S. Movie Ratings

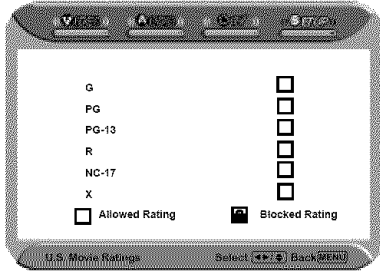
The U.S. Movie Ratings is used for original movies rated by the Motion Picture Association of America (MPAA) as broadcasted on cable TV and not edited for television. The U.S. Movie Ratings includes the following options:



RATING	DESCRIPTION
G	General Audiences. Movie is appropriate for all ages
PG	Parental Guidance Suggested. May contain material not suited for younger viewers
PG-13	Contains content that may not be appropriate for viewers under the age of 13
R	Restricted. Contains adult content, no one under 17 admitted without parent
NC-17	No one 17 and under admitted
X	No one 17 and under admitted

Use the ◀▶▲▼ buttons to select the rating you want and press the **OK** button repeatedly to select **BLOCK**  or **UNBLOCK** .



Open V-Chip Allows to setup the TV and MPAA Rating Lock options (referto "Using the V-CHIP Setting")

Canadian English Ratings

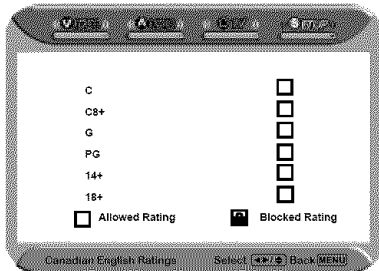
The Canadian English Ratings includes the following options:



RATING	DESCRIPTION
C	All children
C8+	Children 8 years and older
G	General programming
PG	Parental guidance
14+	Viewers 14 and older
18+	Adult programming



Use the ◀▶ ▲▼ buttons to select the rating you want and press the **OK** button repeatedly to select **BLOCK**  or **UNBLOCK** .

Canadian French Ratings

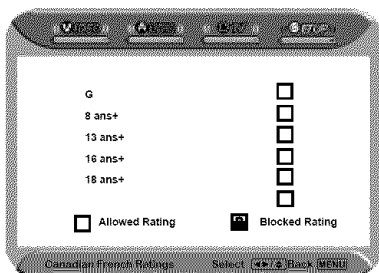
The Canadian French Ratings includes the following options:



RATING	DESCRIPTION
G	General programming
8 ans+	Not recommended for ages under 8
13 ans+	Not recommended for ages under 13
16 ans+	Not recommended for ages under 16
18 ans+	Programming restricted to adults.

Use the ◀▶ ▲▼ buttons to select the rating you want and press the **OK** button repeatedly to select **BLOCK**  or **UNBLOCK** .

Using the Program Guide

The Program Guide feature brings all sorts of information to your screen, such as program title, program duration, time remaining, rating information, closed caption, availability, etc.

- 1 With the LCD TV connected to a television programming source, press the **TV** button on the remote control.
- 2 Press the **GUIDE** button on the remote control, the Program Guide will appear on the screen:

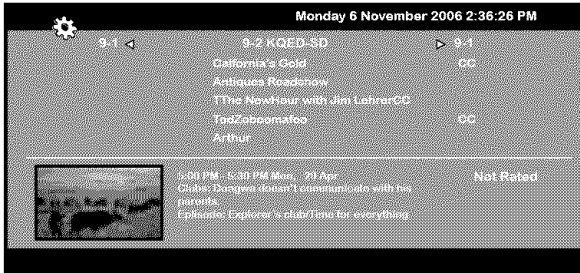

- 3 Press the ◀▶ button to select the channel.
- 4 Press the ▲▼ button to select the program from a list, the Program Guide provides introduction about the current program being shown on each channel. The Program information in the guide is provided by the broadcasters. It may sometimes include only the channel number, without a program title or description.

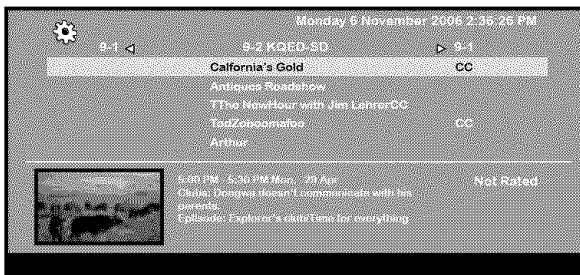

- 5 Press the **GUIDE** button again on the remote control to exit the Program Guide

TROUBLESHOOTING



Before consulting service personnel, check the following chart for a possible cause of the trouble and for a possible solution.

TV will not turn on

- 1 Make sure the power cord is plugged in, then press the  button on the remote.
- 2 The batteries in the remote control may be exhausted.
- 3 Replace the batteries.

No picture, no sound

- 1 Check the interface cable between TV and antenna/cable TV.
- 2 Press the  button on the remote.
- 3 Press the **INPUT** button on the remote repeatedly to select the connected video sources.

Poor picture, sound OK

- 1 Check the interface cable between TV and antenna/cable TV.
- 2 Try another channel, the station may have broadcast difficulties.
- 3 Adjust the Brightness/Contrast options in the **PICTURE** Menu.

Picture OK, poor sound

- 1 Sound may be muted. Press the **MUTE** button on the remote.
- 2 Press the **TV** button on the remote, then press the **VOL+** button to increase the volume.

Audio noise

- 1 Move any infrared equipment away from the TV.

SPECIFICATIONS

MODEL		MLT3221
LCD Panel	Panel Size	32 TFT LCD
Max. Resolution		1366x768
Input Connector	VIDEO/AUDIO(L/R)	2
	S-Video/AUDIO(L/R)	1
	YPbPr/AUDIO(L/R)	2
	VGA/AUDIO(L/R)	1
	HDMI/AUDIO(L/R)	2
	AUDIO OUT(L/R)	1
	OPTICAL/COAXIAL	1
	HEADPHONE	1
Power Source		100-240V~, 50/60HZ, 2.2A
Power Consumption		150 W, standby < 3 W
Dimension		805 x 246 x 634.9 mm
WEIGHT		33.2 lbs

CARE AND MAINTENANCE

To prevent fire or shock hazard, disconnect your unit from the AC power source when cleaning. The finish on the unit may be cleaned with a dust cloth and cared for as other furniture. Use caution when cleaning and wiping the plastic parts. Mild soap and a soft, damp cloth may be used.

FOR ADDITIONAL SET-UP OR OPERATING ASSISTANCE, PLEASE VISIT OUR WEBSITE AT WWW.MEMOREXELECTRONICS.COM OR CONTACT CUSTOMER SERVICE AT 1-800-919-3647

PLEASE KEEP ALL PACKAGING MATERIAL FOR AT LEAST 90 DAYS IN CASE YOU NEED TO RETURN THIS PRODUCT TO YOUR PLACE OF PURCHASE OR TO IMATION ELECTRONICS PRODUCTS.

FOR CONSUMER REPLACEABLE PART(S), SEE PART NUMBER(S) ON PAGE 6 AND THEN CONTACT FOX INTERNATIONAL AT 1-800-321-6993.

www.memorexelectronics.com

Printed in China

Imation Electronics Products

A Division of Imation Enterprises Corp., Weston, Florida

Memorex, the Memorex logo, and "Is it live or is it Memorex?"
are trademarks of the affiliates of Memorex Products, Inc.