

# *Owner's Manual*



## *Vacuum Cleaner*

**Model** 116.31189  
116.38199  
116.38413  
116.39189



**CAUTION:**

Read and follow all safety and operating instructions before first use of this product.

Sears, Roebuck and Co., Hoffman Estates, IL 60179 U.S.A.

## TABLE OF CONTENTS

<p><b>Before Using Your New Vacuum</b> . . . . . 2</p> <p><b>Kenmore Vacuum Cleaner Warranty</b> . . . . . 2</p> <p><b>Important Safety Instructions</b> . . . . . 3</p> <p><b>Parts and Features</b> . . . . . 4</p> <p><b>Assembly Instructions</b> . . . . . 5-6</p> <p><b>Operating Instructions</b> . . . . . 6</p> <p style="padding-left: 20px;">Pile Height Selection and Setting . . . . . 7</p> <p style="padding-left: 20px;">Carpet/Bare Floor Selector . . . . . 7</p> <p style="padding-left: 20px;">Releasing the Handle . . . . . 8</p> <p style="padding-left: 20px;">On/Off Switch . . . . . 8</p> <p style="padding-left: 20px;">Attachments . . . . . 8-10</p> <p style="padding-left: 20px;">Attachment Use Chart . . . . . 10</p> <p style="padding-left: 20px;">Vacuuming Tips . . . . . 11</p>	<p>Performance Features . . . . . 11</p> <p><b>Vacuum Cleaner Care</b> . . . . . 12</p> <p style="padding-left: 20px;">Vacuum Storage . . . . . 12</p> <p style="padding-left: 20px;">Cleaning Exterior and Attachments . . . . . 12</p> <p style="padding-left: 20px;">Dust Bag Changing . . . . . 13</p> <p style="padding-left: 20px;">Motor Safety Filter Cleaning . . . . . 14-15</p> <p style="padding-left: 20px;">Exhaust Filter Cleaning . . . . . 15</p> <p style="padding-left: 20px;">Belt Changing and Agitator Cleaning . . 16-18</p> <p style="padding-left: 20px;">Clog Removal . . . . . 19</p> <p style="padding-left: 20px;">Light Bulb Changing . . . . . 20</p> <p style="padding-left: 20px;">Agitator Servicing . . . . . 21</p> <p style="padding-left: 20px;">Agitator Assembly . . . . . 21</p> <p><b>Troubleshooting</b> . . . . . 22</p> <p><b>Requesting Assistance Or Service</b> . . 23</p>
--	--

## BEFORE USING YOUR NEW VACUUM

Please read this guide. It will help you assemble and operate your new Kenmore vacuum in the safest and most effective way.

For more information about the care and operation, call your nearest Sears store. You will need the complete model and serial numbers when requesting information. Your vacuum's model and serial numbers are located on the Model and Serial Number Plate.

Use the space below to record the model number and serial number of your new Kenmore vacuum.

Model No. \_\_\_\_\_

Serial No. \_\_\_\_\_

Date of Purchase \_\_\_\_\_

Keep this book and your sales check (receipt) in a safe place for future reference.

## KENMORE VACUUM CLEANER WARRANTY

### LIMITED ONE YEAR WARRANTY ON KENMORE VACUUM CLEANER

This warranty is for one year from the date of purchase, and includes only private household vacuum cleaner use. During the warranty year, when this vacuum cleaner is operated and maintained according to the owner's manual instructions, Sears will repair any defects in material or workmanship free of charge.

This warranty excludes vacuum bags, belts, light bulbs, and filters, which are expendable parts and become worn during normal use.

**For warranty service, return this vacuum cleaner to the nearest Sears Service Center in the United States.**

This warranty applies only while this product is in use in the United States. This warranty gives you specific legal rights, and you may also have other rights which vary from state to state.

**Sears, Roebuck and Co., D/817 WA, Hoffman Estates, IL 60179**

# IMPORTANT SAFETY INSTRUCTIONS



## WARNING

Your safety is important to us. To reduce the risk of fire, electrical shock, injury to persons or damage when using your vacuum cleaner, follow basic safety precautions including the following:

**Read** this manual before assembling or using your vacuum cleaner.

**Use** your cleaner only as described in this manual. Use only with Sears recommended attachments.

To reduce the risk of electrical shock – **Do not** use outdoors or on wet surfaces.

**Disconnect** electrical supply before any servicing or cleaning. Failure to do so could result in electrical shock or personal injury.

**Always** turn cleaner off before unplugging.

**Do not** unplug by pulling on cord. To unplug, grasp the plug, not the cord.

**Do not** use with damaged cord or plug. If cleaner is not working as it should, has been dropped, damaged, left outdoors, or dropped into water, return it to a Sears Service Center/Department.

**Do not** pull or carry by cord, use cord as a handle, close door on cord, or pull cord around sharp edges or corners. Do not run cleaner over cord. Keep cord away from heated surfaces.

**Do not** leave cleaner when plugged in. Unplug from outlet when not in use and before servicing.

**Do not** allow to be used as a toy. Close attention is necessary when used by or near children.

**Do not** handle plug or cleaner with wet hands.

**Do not** put any objects into openings.

**Do not** use with any opening blocked; keep free of dust, lint, hair and anything that may reduce air flow.

**Keep** hair, loose clothing, fingers, and all parts of body away from openings and moving parts.

**Do not** use cleaner without dust bag and/or filters in place.

**Always** change the dust bag after vacuuming carpet cleaners or freshener, powders and fine dust. These products clog the bag, reduce airflow and can cause the bag to burst. Failure to change bag could cause permanent damage to the cleaner.

**Do not** use the cleaner to pick up sharp hard objects, small toys, pins, paper, etc. They may damage the cleaner or dust bag.

**Do not** pick up anything that is burning or smoking, such as cigarettes, matches, or hot ashes.

**Do not** use cleaner to pick up flammable or combustible liquids (gasoline, cleaning fluids, perfumes, etc.), or use in areas where they may be present. The fumes from these substances can create a fire hazard or explosion.

**Use extra care** when cleaning on stairs. Do not put on chairs, tables, etc. Keep on floor.

**You** are responsible for making sure that your vacuum cleaner is not used by anyone unable to operate it properly.

## SAVE THESE INSTRUCTIONS

Proper assembly and safe use of your vacuum cleaner are your responsibilities. Your cleaner is intended only for household use. Read this Owner's Manual carefully for important use and safety information. This guide contains safety statements under warning and caution symbols. Please pay special attention to these boxes and follow any instructions given. **WARNING** statements alert you to such dangers as fire, electrical shock, burns and personal injury. **CAUTION** statements alert you to such dangers as personal injury and/or property damage.

# UPRIGHT VACUUM CLEANER PARTS AND FEATURES

It is important to know your vacuum cleaner parts and features to assure its proper and safe use. Review these before using your cleaner.

Item	Part No. In U.S.	Part No. In Canada
Dust Bag	20-50688	20-50680
Headlight Bulb	20-5240	20-40600
Belt	20-5275	20-40096

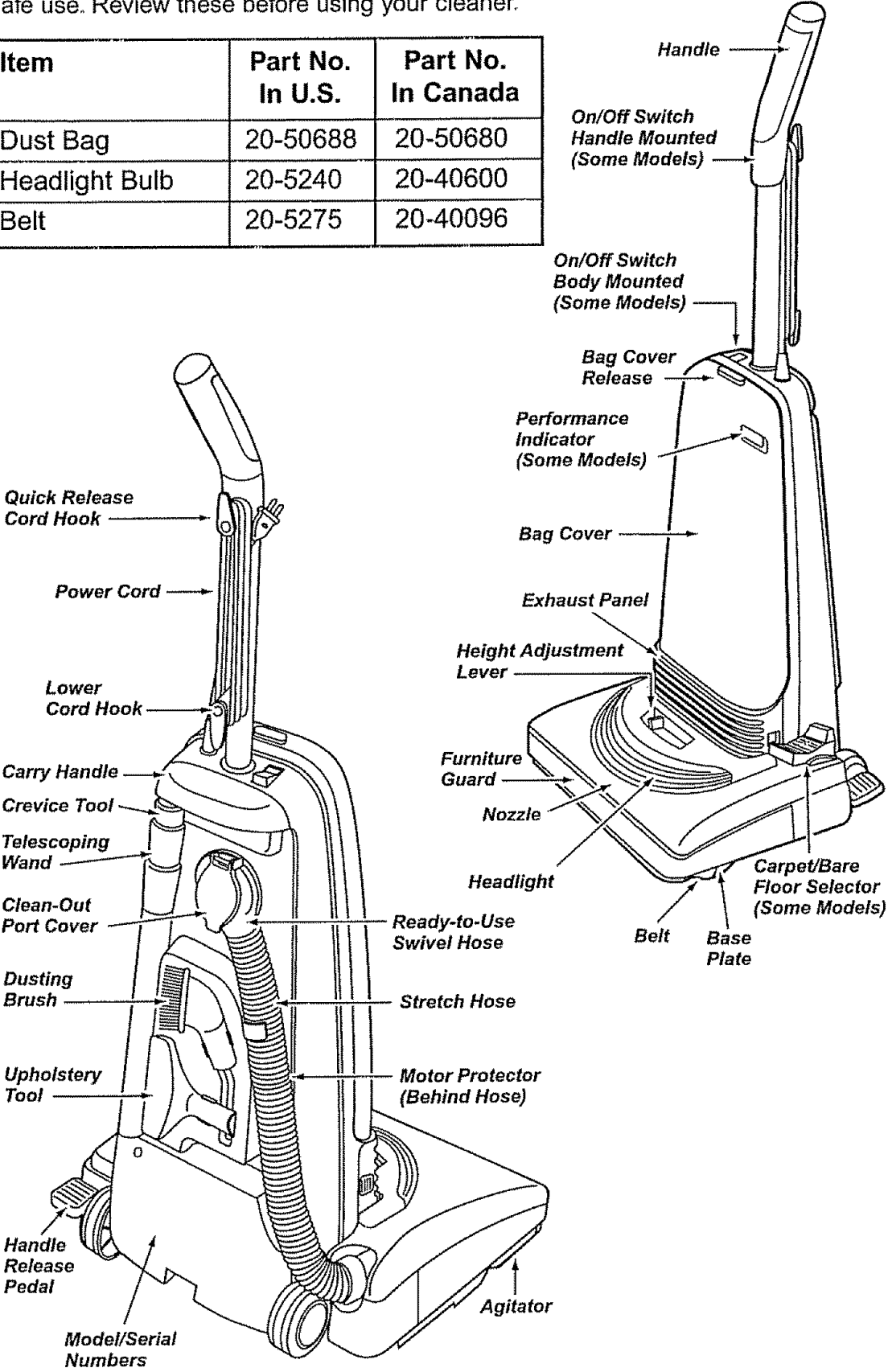

## ASSEMBLY INSTRUCTIONS

Before assembling vacuum, check the PACKING LIST on the cover of the separate Repair Parts List. Use this list to verify that you have received all the components of your new Kenmore vacuum.



### WARNING

#### Electrical Shock Hazard

Do not plug into the electrical supply until the assembly is complete. Failure to do so could result in electrical shock or injury.

### HANDLE ASSEMBLY

Before assembling your vacuum cleaner be sure you have all the parts shown.

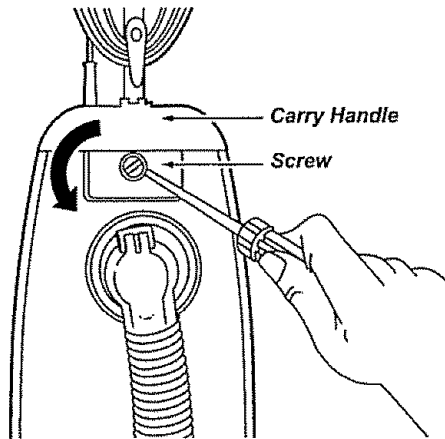
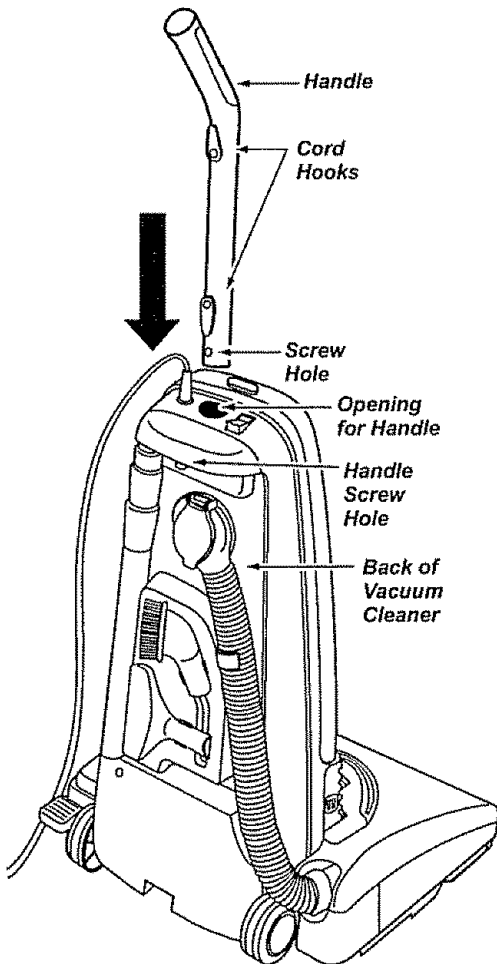

Remove the screw located just below the carry handle on the back side of the vacuum.

Position the handle so the cord hooks are toward the back of the cleaner.

Insert the handle into the opening at the top of the vacuum.

Align the screw hole in the handle with the screw hole in the vacuum.

Insert the screw so it passes through the back of the vacuum into the handle.

Begin to tighten the screw with your fingers. It may be necessary to adjust the handle slightly.

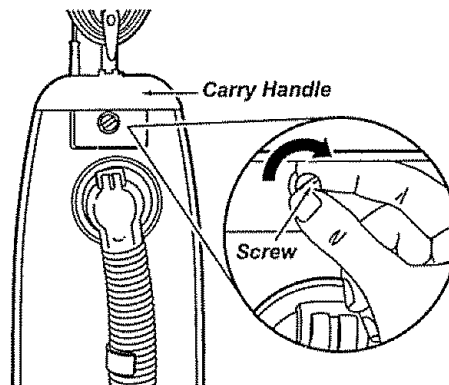
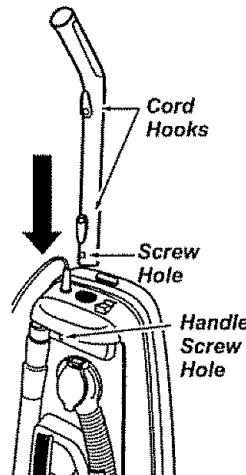

Using a screwdriver, tighten the screw.

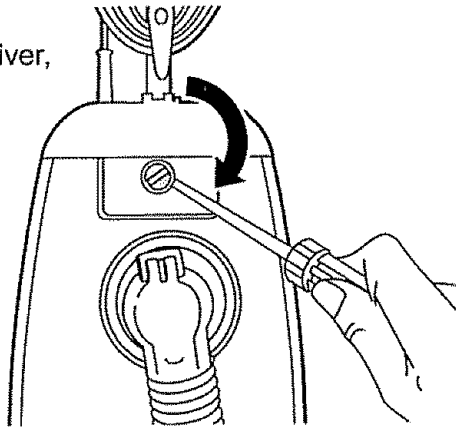

## CAUTION

Do not overtighten. Overtightening could strip the screw holes. Do not operate the cleaner without the screw in place.

## CORD ASSEMBLY

Make sure the quick release cord hook is in the upright position. Remove the wire tie from the power cord.

Lock the cord into place by forcing it into the locking notch on the body of the upper cord hook as shown. This helps keep the power cord out from under the vacuum cleaner agitator.

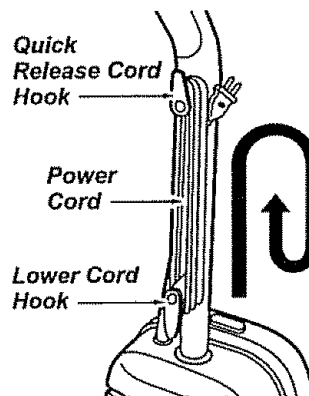
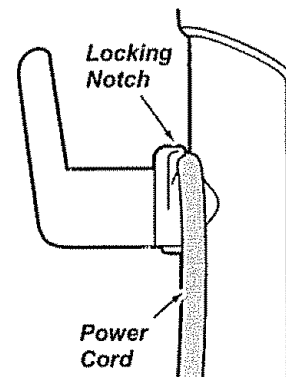

Wrap the power cord around the quick release and lower cord hooks and lock the power cord plug onto the power cord.

## OPERATING INSTRUCTIONS

### HOW TO START

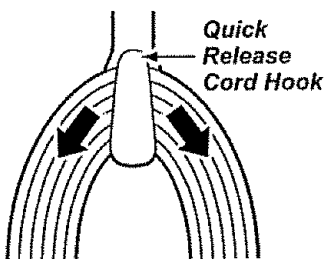

1. Turn the quick release cord hook to either side and down to release the power cord.

2. Release the power cord plug from the power cord and pull the cord off the quick release cord hook. Check to be sure the power cord is still locked into the lock in the quick release cord hook.

3. Check to see if the cleaner has bag installed. See DUST BAG CHANGING.

**NOTE:** To reduce the risk of electric shock, this vacuum cleaner has a polar-

ized plug, one blade is wider than the other. This plug will fit in a polarized outlet only one way. If the plug does not fit fully in the outlet, reverse the plug. If it still does not fit, contact a qualified technician to install the proper outlet. Do not change the plug in any way.

4. Plug the polarized power cord into a 120 Volt outlet located near the floor.



## WARNING

**Personal Injury and Product Damage Hazard**

- DO NOT plug in if switch is in the ON position. Personal injury or damage could result.
- DO NOT use outlets above counters. Damage to items in surrounding area could occur.

## PILE HEIGHT SELECTION AND SETTING

### To select a pile height setting:

Turn off cleaner. Select a pile height setting by tilting the cleaner back until front wheels are lifted slightly off the floor as illustrated.

Slide the adjustment lever to the correct setting.

### SUGGESTED PILE HEIGHT SETTINGS

You may need to raise the height to make some jobs easier, such as scatter rugs and longer pile carpets. Suggested settings are:

**HIGH:** shag carpet, long pile, plush, scatter rugs.

**MED:** medium to long pile.

**LOW:** short to medium pile.

**EX LOW:** very low pile.

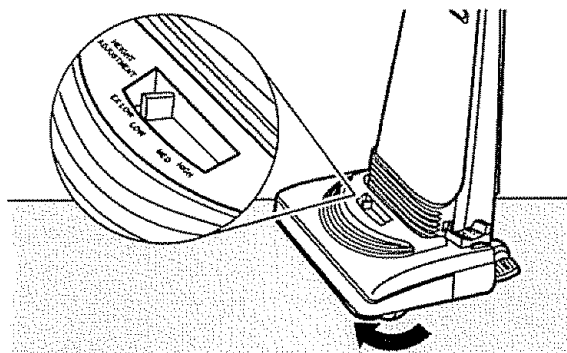

## WARNING

### Personal Injury Hazard

**DO NOT** place hands or feet underneath the unit when changing from the bare floor to the carpet pile height setting. The agitator begins to revolve rapidly when the vacuum is turned on and is in the carpet setting.

## CARPET/BARE FLOOR SELECTOR

### SOME MODELS

**Bare floor setting:** Rotate the carpet/bare floor selector all the way back and down toward the bottom of the nozzle until it locks into place.

In this position the agitator does not revolve. This setting should be used for cleaning hardwood and tile floors and **when any attachments (tools) are used.**

**Carpet setting:** Slide the selector **all the way forward** and up to the carpet position.

In this position the agitator will turn. When carpets are being cleaned the selector should be in this position.

**Note:** For longer belt life, turn vacuum off before moving selector, otherwise make sure the selector is pushed **fully and quickly as possible** to the desired position. Failure to do so can cause the belt to rub on the selector shaft and may result in the belt becoming hot and creating a burning rubber smell.

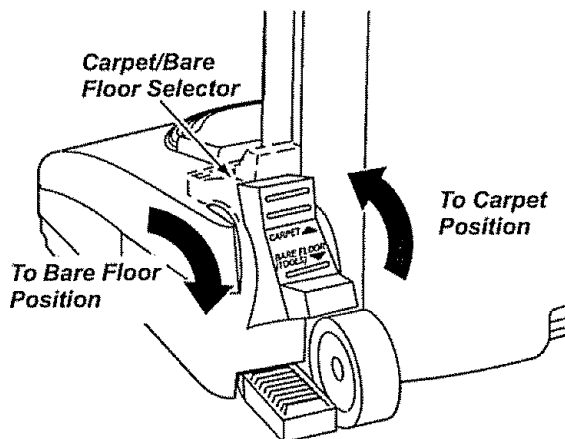

## RELEASING THE HANDLE

Release the handle by pressing down on the handle release pedal with your foot and pulling back and down on the handle with your hand.

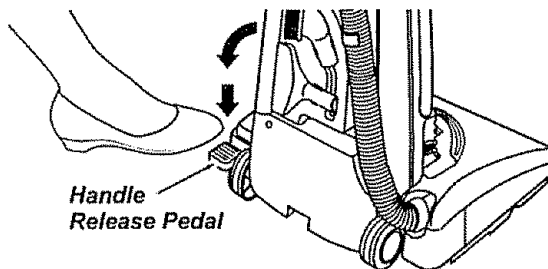

## ON/OFF SWITCH

### HANDLE MOUNTED SOME MODELS

To start the vacuum cleaner, slide the ON/OFF switch from the OFF position to the ON position. To stop the vacuum cleaner, slide the ON/OFF switch to the OFF position.

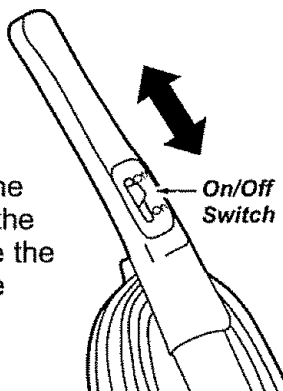

### BODY MOUNTED SOME MODELS

To start the vacuum cleaner, put the ON/OFF switch on the top of the body in the ON position. To stop the cleaner, put the ON/OFF switch in the OFF position.

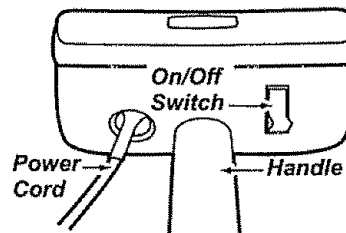

## ATTACHMENTS

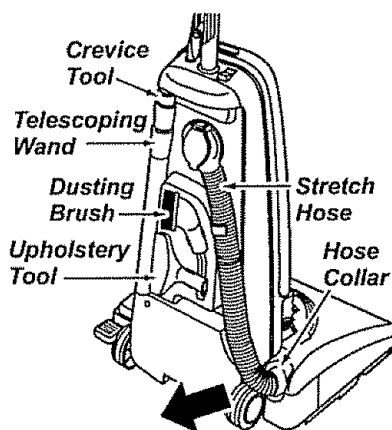

Identify each of the attachments shown above.

### TO USE ATTACHMENTS:

Place the bare floor selector in the bare floor setting by rotating the selector back and down to the bare floor setting. See CARPET/BARE FLOOR SELECTOR section.

When returning the bare floor selector to the carpet setting, use caution as the selector can move quickly to that setting due to tension created by the belt.

Remove the lower end of the stretch hose from the cleaner by grasping the hose collar, twisting and pulling straight out.

**NOTE:** The motor protector may open when using attachments or when cleaning new carpet, due to reduced airflow by the attachments themselves or by new carpet fuzz filling the bag quickly. See the TROUBLESHOOTING section.



## WARNING

**Electrical Shock And Personal Injury Hazard**

**Disconnect electrical supply before servicing or cleaning the unit. Failure to do so could result in electrical shock or personal injury from cleaner suddenly starting.**



The attached hose end swivels to make cleaning easier in every direction.

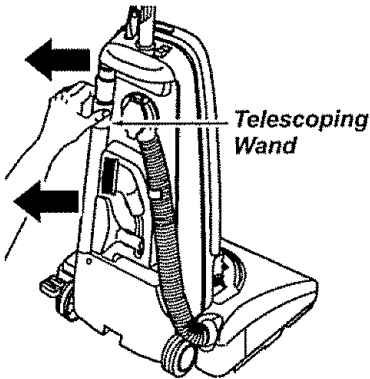
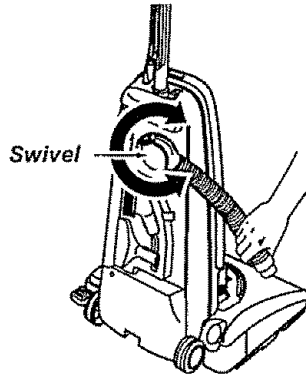

Remove the telescoping wand from its storage position.

Remove the crevice tool from its storage position in the wand. Turn the locking ring to the **UNLOCK** position. Extend the wand to its full length. Turn the locking ring to the **LOCK** position. Attach the extension wand onto the open end of the hose.

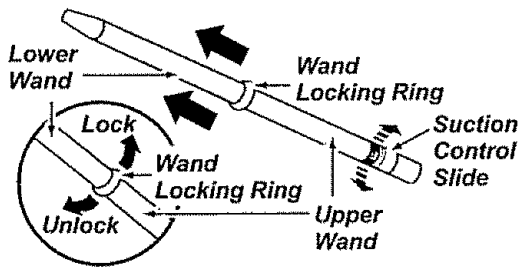

## TO OPERATE SUCTION CONTROL SLIDE

### TELESCOPING WAND

When using attachments for cleaning draperies, small rugs with low pile and other delicate items, twist the suction control slide to the open position. This slide is located on the telescoping wand, close to the hose.

This will reduce suction for ease of cleaning.

**NOTE** - Return the suction control slide to the closed position for normal cleaning.

Align the tabs on the extension wand with the "J" slots in the hose. Push the wand into the hose and twist to the right to lock.

To achieve maximum reach with the attachments, add the crevice tool to the end of the wand by inserting and twisting slightly.

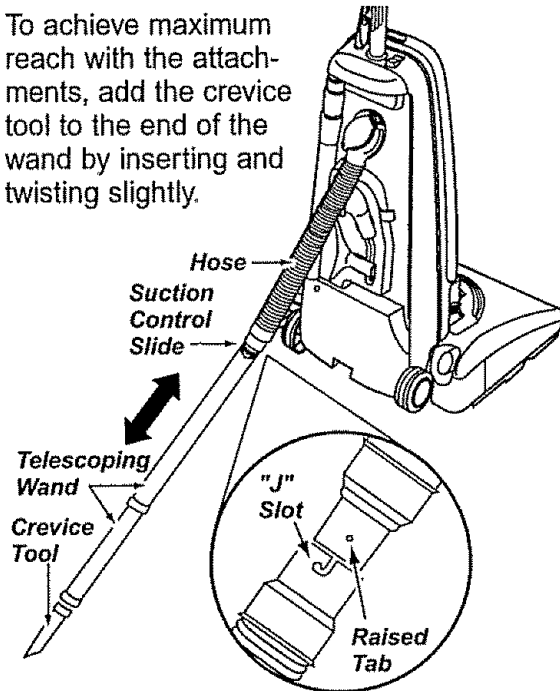

## CAUTION

When using attachments, be careful not to overextend the stretch hose when reaching. Trying to reach beyond the hose stretch capability could cause the cleaner to tip over.

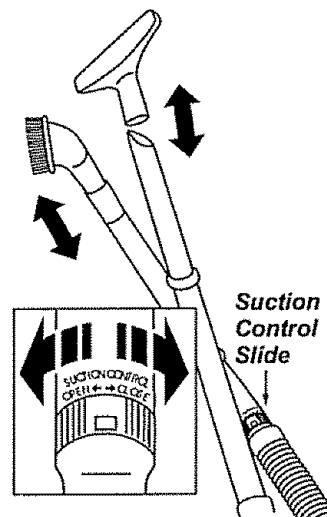

The dusting brush and the upholstery tool may be attached directly to the wand or placed on the crevice tool for additional reach.

## TO STORE ATTACHMENTS:

Remove dusting brush or upholstery tool. Snap into appropriate storage location.

Remove crevice tool from the wand by twisting. Lay aside.

Remove the extension wand from the hose. Twist the wand to the left and pull from the hose end.

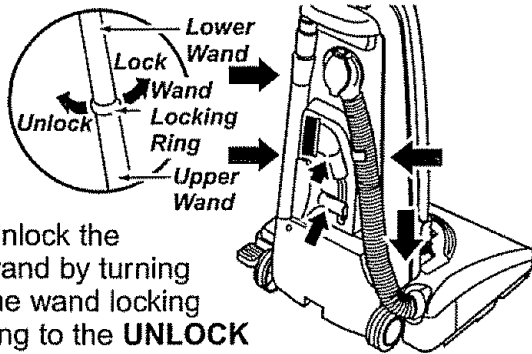

Unlock the wand by turning the wand locking ring to the **UNLOCK** position.

Slide the lower wand into the upper wand. Turn the wand locking ring to the **LOCK** position.

Place the crevice tool down into the compressed wand. Snap into the appropriate storage location.

Be sure the unit is turned off. Reinsert the hose fully into the opening on the lower body from which it was removed. Press firmly to assure connection.



## WARNING

**Personal Injury Hazard**

**DO NOT** place hands or feet underneath the unit when inserting the hose. The agitator begins to revolve rapidly when the vacuum is turned on.



## CAUTION

**DO NOT** pull the vacuum cleaner around the room by the hose. Property damage could result.

## TO USE EXTENSION HOSE: SOME MODELS

The stretch hose attached to the vacuum cleaner has two "J" shaped slots in the end where attachments fit.

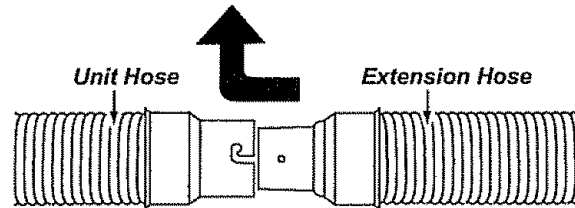

The extension hose has two tabs on the end that can be pushed into the slots and twisted to attach the two hoses together.

Attachments and the telescoping wand can be attached to the other end of the extension hose for additional reach.



If your model did not come with an extension hose, you can purchase one at any SEARS retail store with part number 20-52571. In Canada 20-40975.



## CAUTION

When using the regular hose or with the extension hose attached, the cleaner should be on a solid surface on the same level or below the level of the user's feet. **DO NOT** use the hoses when the cleaner is above the level of the user's feet.

## ATTACHMENT USE CHART

ATTACHMENT	CLEANING AREA				
	Furniture*	Between Cushions*	Drapes*	Stairs	Walls
DUSTING BRUSH 	X		X		X
CREVICE TOOL 	X	X		X	
FABRIC BRUSH 	X		X	X	

\*Always clean attachments before using on fabrics.

## VACUUMING TIPS

### Carpet edges.

Guide either side or the front of the nozzle along a baseboard. The full length brushes help remove dirt at carpet edges.

### Stairs.

Put handle in full upright position. Use the crevice tool or fabric brush.



## WARNING

### Personal Injury Hazard

Use care if vacuum cleaner is placed on stairs. If it falls, personal injury or property damage could result.

For best cleaning results, keep the airflow passage clear.

Occasionally, check each of the areas indicated for clogs.

Unplug the cleaner from the outlet before checking.

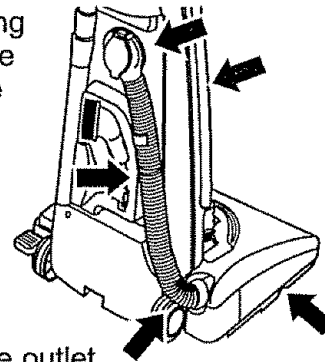

## PERFORMANCE FEATURES

### PERFORMANCE INDICATOR SOME MODELS

When the unit is running with normal air flow, the lines on the performance indicator are white. Red lines appear in the performance indicator whenever the airflow becomes blocked. If that occurs, check the disposable dust bag, motor safety filter and other possible clog locations shown in CLOG REMOVAL.

**NOTE:** Red lines may appear when using attachments, due to reduced air flow through the attachment.

**To correct problem:** See the TROUBLESHOOTING chart.

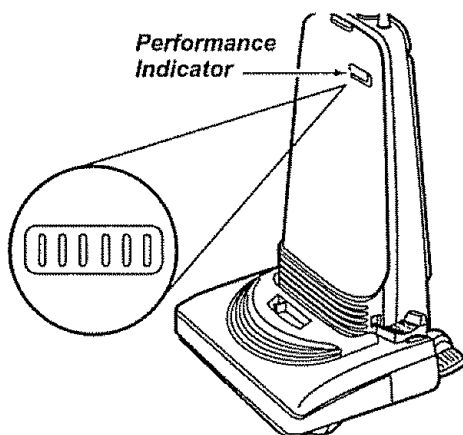

## WARNING

### Electrical Shock And Personal Injury Hazard

Disconnect electrical supply before servicing or cleaning the unit. Failure to do so could result in electrical shock or personal injury from cleaner suddenly starting.

### MOTOR PROTECTION SYSTEM

This vacuum has a motor protector by-pass valve which automatically opens to provide cooling air to the motor when a clog prevents the normal flow of air to the motor. If the by-pass valve opens to prevent motor overheating and possible damage to the vacuum, you will notice a change of sound as air rushes through the valve opening.

**To correct problem:** See the TROUBLESHOOTING chart.

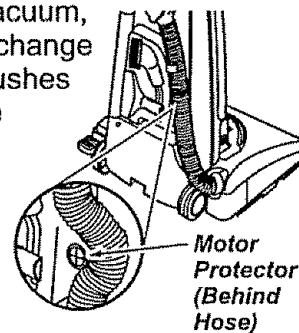

## VACUUM CLEANER CARE

Always follow all safety precautions when cleaning and servicing the vacuum cleaner.



### WARNING

**Electrical Shock And Personal Injury Hazard**

Disconnect electrical supply before servicing or cleaning the unit. Failure to do so could result in electrical shock or personal injury from cleaner suddenly starting.

## VACUUM STORAGE

Gather the cord and wrap it loosely around the quick release and lower cord hooks.

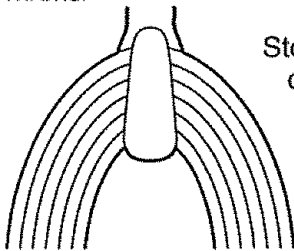

Store the cleaner in a dry, indoor area, on the floor with the handle locked in the upright position.



### WARNING

**Electrical Shock And Personal Injury Hazard**

Wrapping the cord too tightly puts stress on the cord and can cause cord damage. A damaged cord is an electrical shock hazard and could cause personal injury or damage.

## CLEANING EXTERIOR AND ATTACHMENTS

Unplug cord from wall outlet. **DO NOT** drip water on cleaner.

Clean exterior using a clean, soft cloth that has been dipped in a solution of mild liquid detergent and water, then wrung dry. Wipe dry after cleaning.

To reduce static electricity and dust build-up, wipe outer surface of cleaner and attachments.

Wash attachments in warm soapy water, rinse and air dry. **Do not clean in dishwasher.**

**DO NOT USE ATTACHMENTS IF THEY ARE WET.**



### CAUTION

Attachments used in dirty areas, such as under a refrigerator, should not be used on other surfaces until they are washed. They could leave marks.

# DUST BAG CHANGING

## TO REMOVE BAG:



### WARNING

Always unplug power cord from electrical outlet before performing any service on vacuum.

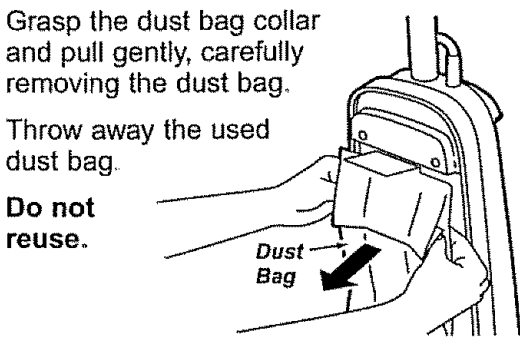
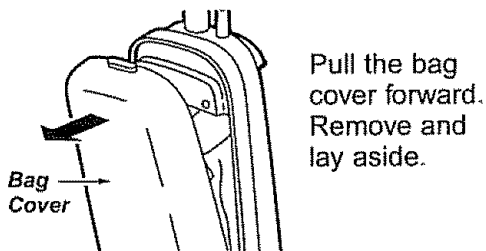
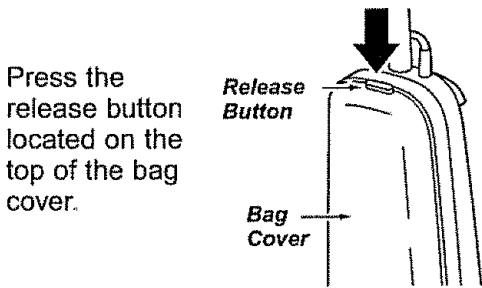



### CAUTION

**NEVER REUSE A DUST BAG.** Very fine materials, such as carpet freshener, face powder, fine dust, plaster, soot, etc. can clog the bag and cause it to burst before it is full. Change bag more often when vacuuming these materials.

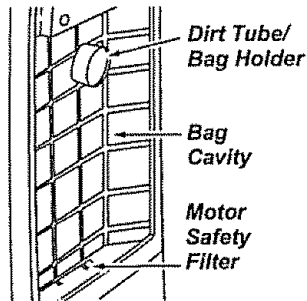

Check the dust tube and the motor safety filter.

If either is blocked, check the TROUBLE-SHOOTING chart.

## TO REPLACE BAG:

Fold the safety seal tab on the new dust bag away from the opening that fits on the dust tube.

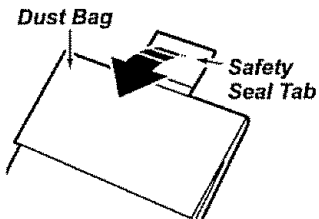

**NOTE:** See PARTS AND FEATURES for Dust Bag #.

Unfold the new dust bag.

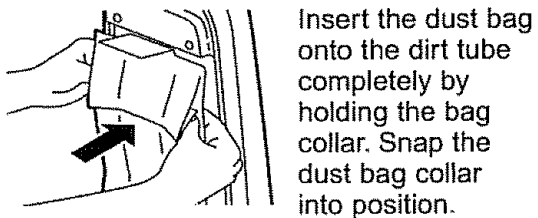

Be sure bottom of dust bag is completely within dust bag cavity prior to replacing the bag cover.

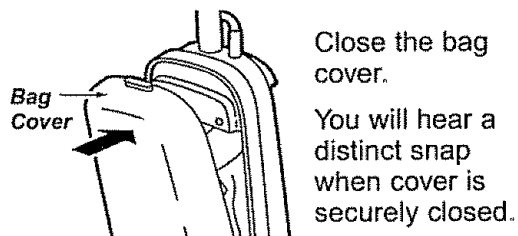
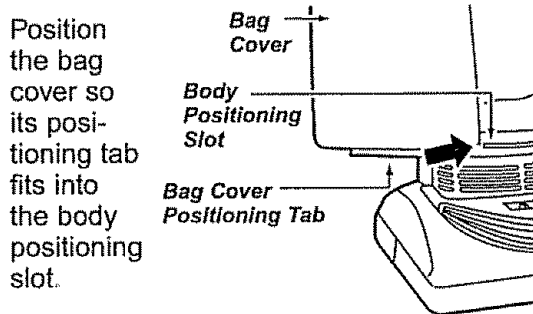

## MOTOR SAFETY FILTER CLEANING

Check motor safety filter frequently and clean when dirty.



### WARNING

#### Electrical Shock Hazard

Do not operate the cleaner without the motor safety filter. Be sure the filter is dry and properly installed to prevent motor failure and/or electrical shock.

Always unplug power cord from electrical outlet before performing any service on vacuum.

### TO REMOVE BAG:

Press the release button located on the top of the bag cover.

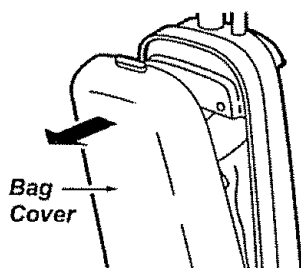
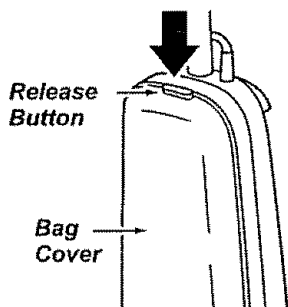

Pull the bag cover forward. Remove and lay aside.

Grasp the dust bag collar and pull gently, carefully removing the dust bag.

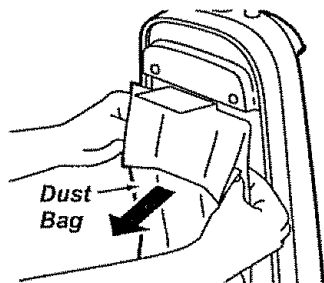

If the motor safety filter, located in the bottom of the dust bag cavity is dirty, remove it by pulling forward out from under the ribs.

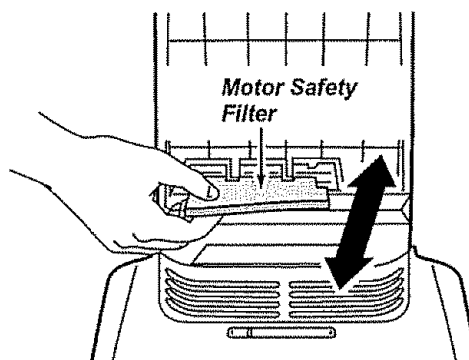

Wash the foam filter in warm soapy water, rinse and dry thoroughly by squeezing the filter in your hand and letting it air dry.

**DO NOT** wash in the dishwasher.

**DO NOT** install damp.

Replace the foam filter by sliding it back into place under the ribs in the dust bag cavity.

### TO REPLACE BAG:

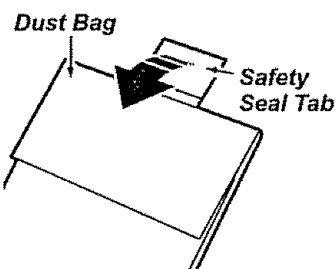

Fold the safety seal tab on the new bag away from the opening that fits on the dirt tube.



### CAUTION

**NEVER REUSE A DUST BAG.** Very fine materials, such as carpet fresheners, face powder, fine dust, plaster, soot, etc. can clog the bag and cause it to burst before it is full. Change bag more often when vacuuming these materials.

Unfold the new dust bag

Insert the dust bag completely onto the dirt tube by holding the bag collar.

Snap the dust bag collar into position.

Be sure the bottom of dust bag is completely within the dust bag cavity prior to replacing the bag cover.

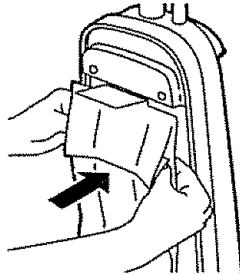

Position the bag cover so its positioning tab fits into the body positioning slot. Close the bag cover.

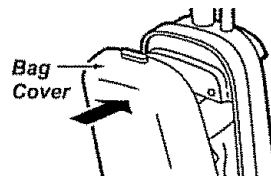
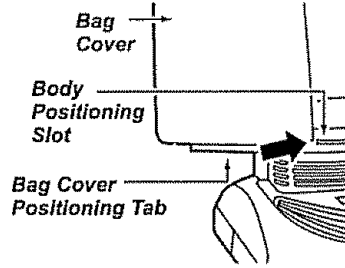

You will hear a snap when the cover is securely closed.

## EXHAUST FILTER CLEANING



### WARNING

Do not operate without exhaust filter.

Check filter frequently.

Clean when dirty.

Press the handle release pedal to let the upper portion of the cleaner lay back against the floor.

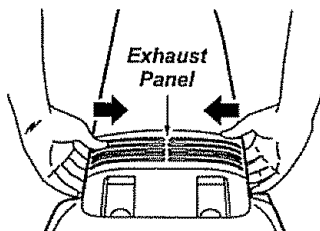
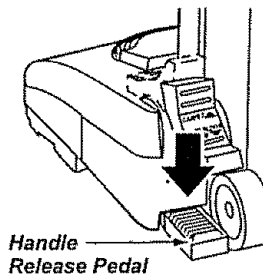

Grasp the air exhaust panel with a hand on each side, press inward and pull the panel forward.

Lift the foam filter to remove. Wash the foam filter, rinse and dry.

DO NOT clean in the dishwasher.

DO NOT install while damp.

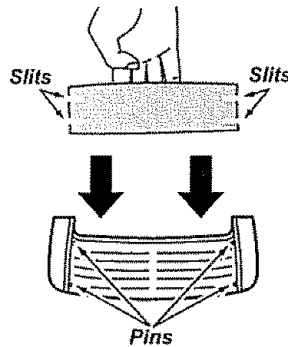
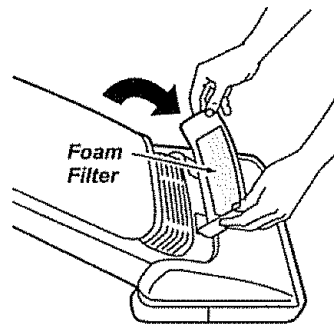

Replace the dry foam filter, carefully positioning it so the slits fit around the four raised pins.

Replace the exhaust panel.

Return the cleaner to the upright position.

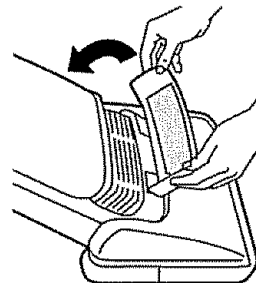

## BELT CHANGING AND AGITATOR CLEANING



### WARNING

**Electrical Shock Or Personal Injury Hazard**

**Disconnect electrical supply before servicing or cleaning the unit. Failure to do so could result in electrical shock or personal injury from cleaner suddenly starting.**

Frequently check and remove hair, string and lint build-up in the brush area. If build-up becomes excessive, follow the steps below.

### TO REMOVE BELT:

Disconnect power cord from electrical outlet, and place on paper to protect the floor surface. Place vacuum in the full upright position.

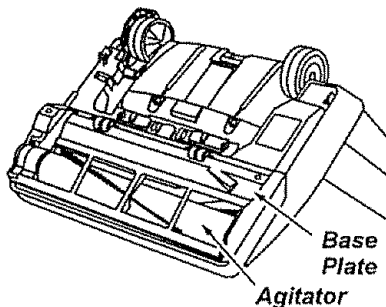

Turn the unit over so the agitator and base plate are facing upward.

Locate the two latches and the two locking tabs which secure the base plate.

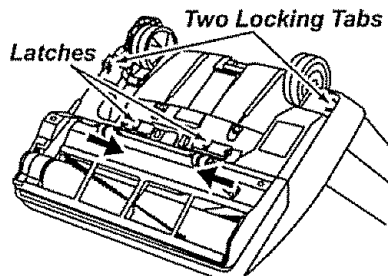

To unlock the base plate, slide the left latch to the right and the right latch to the left. Push in on the locking tabs toward the center of the vacuum.

Pull the base plate away from the nozzle housing. The sides of the base plate need to be pulled slightly outward to clear the wheels.

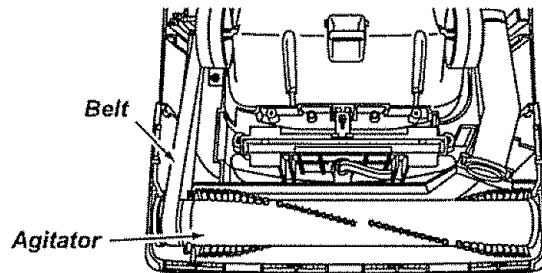

The agitator and belt are now exposed. Carefully remove any residue that may exist in the belt area.

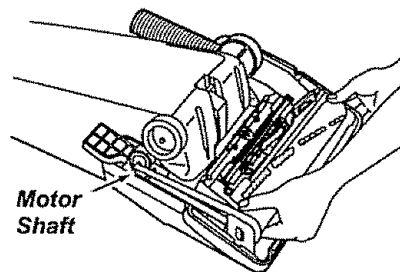

Position hands on the agitator. If the belt is still attached to the motor shaft, there will be tension on the agitator. If the belt is not broken, remove it from the motor shaft before lifting the agitator.

Carefully lift the right end of the agitator and then lift the left end.

Carefully remove the end cap and washer from each end and lay them aside. See the exploded view.



### WARNING

**Personal Injury Hazard**

**Be careful when removing the agitator as the belt tension is high. Failure to do so could result in personal injury from the agitator releasing quickly and snapping away.**





## CAUTION

When you remove the end caps, a small metal washer on each end may come off. **DO NOT** lose these two metal washers.

### TO CLEAN AGITATOR:

**NOTE:** In order to keep cleaning efficiency high and to prevent damage to your vacuum, the agitator must be cleaned every time the belt is changed.

The agitator must also be cleaned according to the following schedule:

<u>Vacuum Use</u>	<u>Clean Agitator</u>
<b>HEAVY</b> - (used daily)	every week
<b>MODERATE</b> - (used 2-3 times/week)	every month
<b>LIGHT</b> - (used 1 time/week)	every 2 months

Remove any dirt or debris in the belt path area or in the brush roller area.

### Exploded View - Agitator Assembly

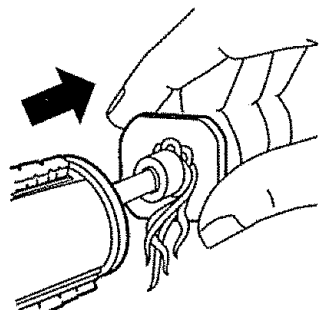
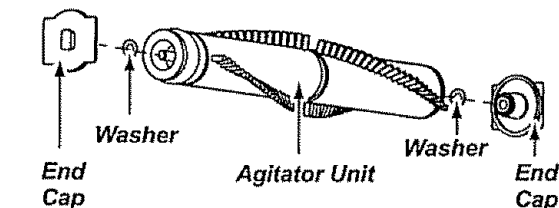

Carefully remove any string or debris located on the agitator, end caps, washers or agitator shaft.

### IMPORTANT

Replace the washers and the end caps. See the exploded view for correct assembly.

### TO REPLACE BELT:

Make sure that the carpet/bare floor selector is in the **carpet** position. Loop the new belt on the **motor shaft**.

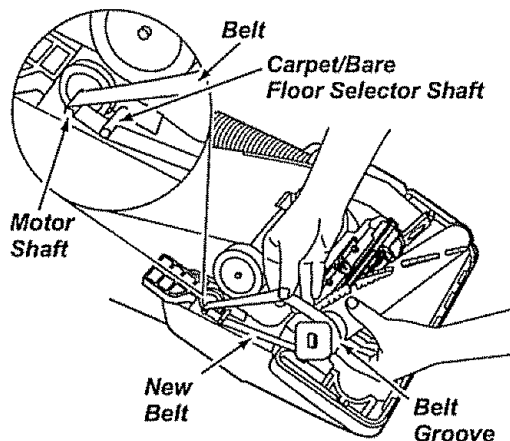

**NOTE:** See PARTS AND FEATURES for belt #.

Loop the end of the new belt on the brush assembly.

Align the square extension on each end cap with the slots in the frame of the nozzle.

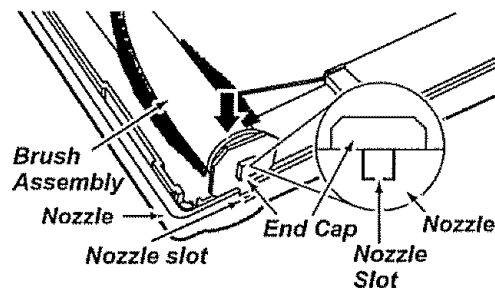

**NOTE:** Care must be taken due to the belt tension during reassembly.

## BELT ROUTING

### Correct Routing of Belt (Selector in Carpet Position)

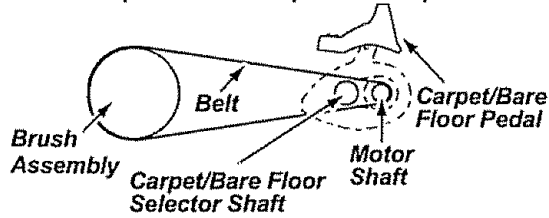

### Incorrect Routing of Belt (Belt on Selector Shaft)

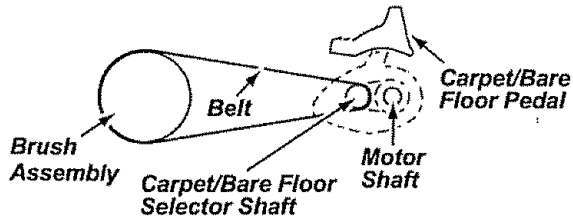

### Incorrect Routing of Belt (Selector in Bare Floor Position)

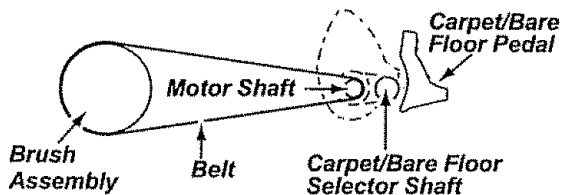

Press firmly, checking to see that each end is completely inserted.

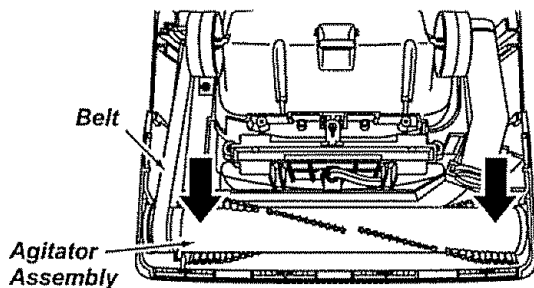

Check to see that the belt is centered in the belt groove. Turn the brush assembly with your fingers to see that it turns freely.

To re-attach the base plate, insert the tabs into the slots along the front edge of the base. Place the vacuum in full upright position. Lower the base plate to its original position.

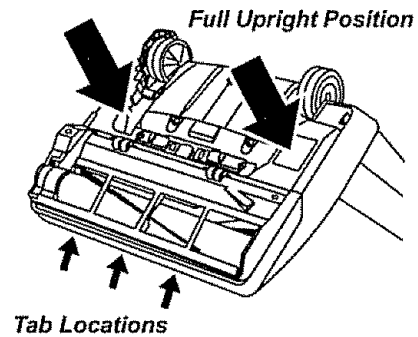

As the base is lowered the inner areas will brush against the dust compartment wheels. A gentle pull outward may assist in reassembly.

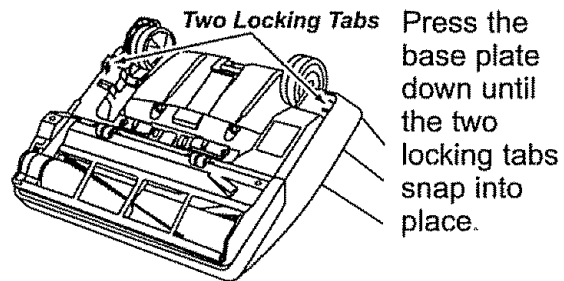

Press the base plate down until the two locking tabs snap into place.

Slide the right latch to the right and the left latch to the left to secure.

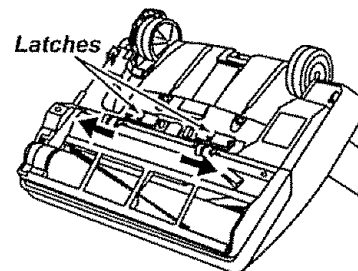

Return the cleaner to the upright position before plugging into the electrical outlet.

## CLOG REMOVAL

Always follow all safety precautions when cleaning and servicing the vacuum cleaner.



### WARNING

**Electrical Shock Or Personal Injury Hazard**

**Disconnect electrical supply before servicing or cleaning the unit. Failure to do so could result in electrical shock or personal injury from cleaner suddenly starting.**

If the cleaner does not seem to have adequate suction, first check for a full bag or filter which is clogged. See instructions in **DUST BAG CHANGING** and **MOTOR SAFETY FILTER CLEANING**.

If the bag and filter areas are free of clogs, check the hose area. Remove the lower end of the stretch hose from the cleaner by grasping the hose collar, twisting, and pulling straight out.

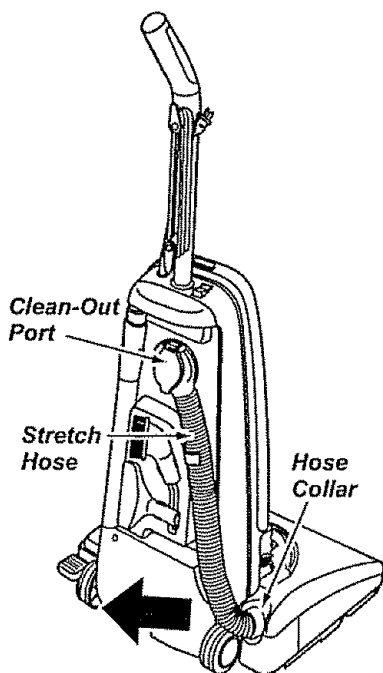

Plug in the vacuum and turn it on. Alternately open and shut the clean-out port cover. Stretch the hose to maximum length and then allow the hose to return to its storage length.

Turn the unit off and unplug the unit.

Visually inspect the clean-out port area and the base area into which the hose is inserted.

Remove any visible clogs.

Close clean-out port cover firmly to insure seal.

Re-insert the hose into the opening on the lower body from which it was removed. Press firmly to assure connection.

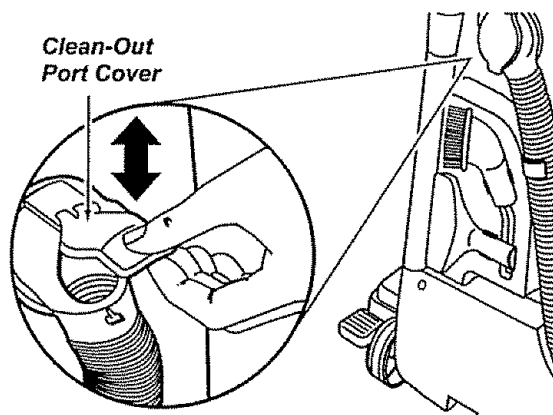

### WARNING

**Personal Injury Hazard**

**DO NOT place hands or feet underneath the unit when inserting the hose. The agitator begins to revolve rapidly when the vacuum is turned on and is in the carpet setting.**

If the bag and filter areas and the hose areas are free of clogs, check the nozzle area. To check this area, see the sections on **BELT CHANGING** AND **AGITATOR CLEANING**.

Return the cleaner to the upright position before plugging into an electrical outlet.

For best cleaning results, keep the airflow passage open. You should check your vacuum occasionally for clogs. The diagram has stars which indicate the areas that clogs are most likely to occur. Unplug the vacuum before checking.

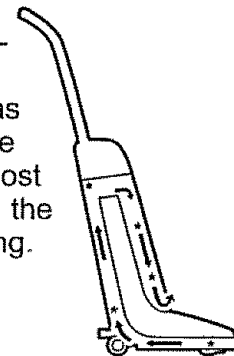

## LIGHT BULB CHANGING



### WARNING

**Electrical Shock Or Personal Injury Hazard**

Disconnect electrical supply before servicing or cleaning the unit. Failure to do so could result in electrical shock or personal injury from cleaner suddenly starting.

Disconnect the power cord from the electrical outlet.

Press the handle release pedal to let the upper portion of the cleaner lay back against the floor.

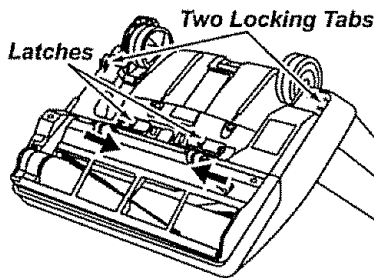

Remove the base plate as outlined in the BELT CHANGING AND AGITATOR CLEANING section.



### CAUTION

Do not use a bulb rated over 15W. During extended use, heat from the bulb could overheat surrounding plastic parts.

Grasp the bulb socket assembly and while gently rocking it from side to side, pull it up out of the nozzle housing.

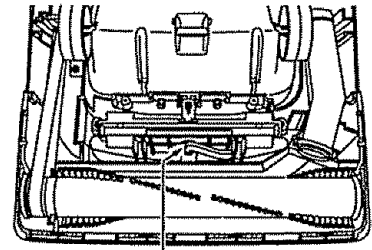

*Bulb Socket Assembly*

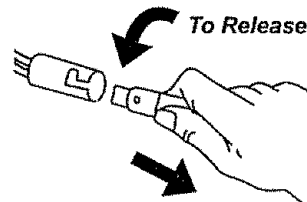

Remove the light bulb by pushing the bulb in while turning counter-clockwise to release from the slot. Then pull the light bulb straight out.

To replace the light bulb, carefully insert and turn clockwise to securely fit into slot.

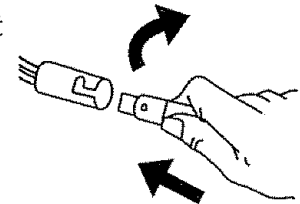

**NOTE:** See PARTS AND FEATURES for bulb #.



### CAUTION

Do not plug in or turn on until the vacuum is completely reassembled.

Replace the base plate as outlined in the BELT CHANGING AND AGITATOR CLEANING section.

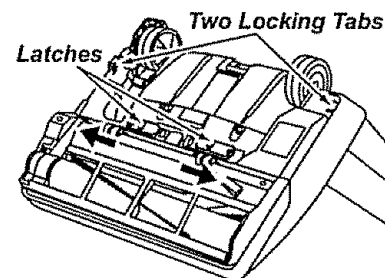

## AGITATOR SERVICING



### WARNING

Electrical Shock Or Personal Injury Hazard

Disconnect electrical supply before servicing or cleaning the unit. Failure to do so could result in electrical shock or personal injury from cleaner suddenly starting.

### TO REPLACE AGITATOR:

Remove the nozzle cover and agitator. See BELT CHANGING AND AGITATOR CLEANING.

Replace agitator with a new one.

Reassemble the belt, agitator and nozzle cover. See BELT CHANGING AND AGITATOR CLEANING.

### TO CHECK AGITATOR:

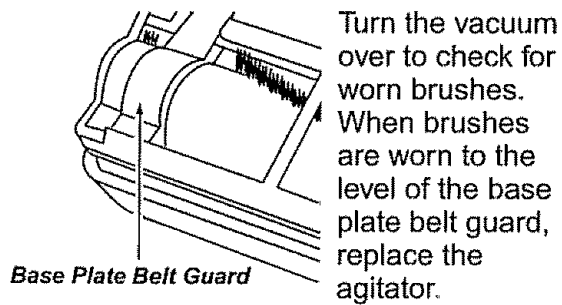

## AGITATOR ASSEMBLY

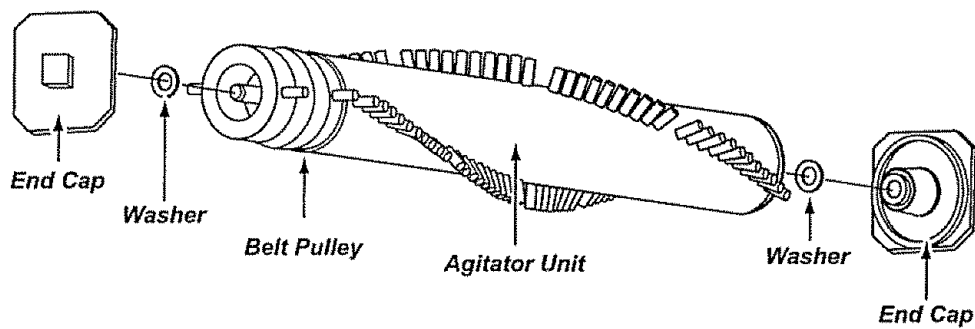

## TROUBLESHOOTING

Review this chart to find do-it-yourself solutions for minor performance problems. Any service needed, other than those described in this owner's manual, should be performed by an authorized service representative.



### **WARNING** Electrical Shock Hazard

**Disconnect electrical supply before servicing or cleaning the unit. Failure to do so could result in electrical shock or personal injury.**

PROBLEM	POSSIBLE CAUSE	POSSIBLE SOLUTION
Cleaner won't run.	<ol style="list-style-type: none"> <li>1. Unplugged at wall outlet.</li> <li>2. Tripped circuit breaker/blown fuse at household service panel</li> <li>3. ON/OFF switch not turned ON</li> </ol>	<ol style="list-style-type: none"> <li>1. Plug in firmly, push ON/OFF switch to ON.</li> <li>2. Reset circuit breaker or replace fuse.</li> <li>3. Push ON/OFF switch to ON.</li> </ol>
Poor job of dirt pick-up.	<ol style="list-style-type: none"> <li>1. Full or clogged dust bag</li> <li>2. Wrong pile height setting.</li> <li>3. Worn agitator.</li> <li>4. Clogged nozzle or dirt tube</li> <li>5. Clogged hose.</li> <li>6. Hole in hose.</li> <li>7. Broken/misplaced belt.</li> <li>8. Hose not inserted fully.</li> <li>9. Motor protection system activated.</li> <li>10. Dirty filters.</li> </ol>	<ol style="list-style-type: none"> <li>1. Change dust bag, (page 13).</li> <li>2. Adjust setting, (page 7).</li> <li>3. Replace agitator, (page 21).</li> <li>4. Clean nozzle area, (page 19).</li> <li>5. Check for clogs, (page 19).</li> <li>6. Replace hose.</li> <li>7. Replace/fix belt, (page 17).</li> <li>8. Insert hose fully, (page 10).</li> <li>9. Check for clogs, (page 19).</li> <li>10. Clean filters, (pages 14-15)</li> </ol>
Cleaner picks up moveable rugs or pushes too hard.	<ol style="list-style-type: none"> <li>1. Wrong pile height setting</li> </ol>	<ol style="list-style-type: none"> <li>1. Adjust setting, (page 7).</li> </ol>
Light won't work.	<ol style="list-style-type: none"> <li>1. Burned out light bulb.</li> </ol>	<ol style="list-style-type: none"> <li>1. Change light bulb, (page 20).</li> </ol>
Agitator does not turn.	<ol style="list-style-type: none"> <li>1. Broken belt</li> <li>2. Bare floor selector in bare floor setting.</li> <li>3. Belt installed incorrectly.</li> </ol>	<ol style="list-style-type: none"> <li>1. Replace belt, (page 16).</li> <li>2. Switch selector to the carpet setting, (page 7).</li> <li>3. Check BELT CHANGING AND AGITATOR CLEANING, (page 17).</li> </ol>
Performance indicator, some models, is red.	<ol style="list-style-type: none"> <li>1. Full or clogged dust bag.</li> <li>2. Dirty filters.</li> <li>3. Clogged airflow passage - dirt tube, nozzle, hose.</li> <li>4. Certain attachment tools.</li> </ol>	<ol style="list-style-type: none"> <li>1. Change dust bag, (page 13).</li> <li>2. Clean filters, (pages 14-15).</li> <li>3. Clear clog from airflow passage, (page 19).</li> <li>4. Should return to normal when tool is removed.</li> </ol>
Air flow restricted with attachment use. Sound changes.	<ol style="list-style-type: none"> <li>1. Attachment use restricts air flow.</li> <li>2. New carpet fuzz clogged air path.</li> </ol>	<ol style="list-style-type: none"> <li>1. Check ATTACHMENTS, (page 8).</li> <li>2. Check CLOG REMOVAL and clean hose, (page 19).</li> </ol>
Excessive noise as vacuum is shut off.	<ol style="list-style-type: none"> <li>1. Belt rubbing on carpet/bare floor selector shaft</li> </ol>	<ol style="list-style-type: none"> <li>1. Push selector all the way forward</li> </ol>