



# Side by Side Refrigerators

## *Safety Information*

Connect Electricity	3
Extension Cords	2
Proper Disposal	2
Safety Precautions	2

## *Operating Instructions*

Automatic Icemaker	7
Care and Cleaning	9, 10
Controls	4
Crispers	6
Dispenser	8
Replacing the Light Bulbs	11
Shelves and Bins	5

## *Installation Instructions*

Preparing to Install the Refrigerator	12
Water Line Installation	13-17

## *Troubleshooting Tips*

Before You Call For Service	18-20
Normal Operating Sounds	18

## *Consumer Support*

Consumer Support	24
Product Registration	21, 22
Warranty	23

**Write the model and serial numbers here:**

**Model #** \_\_\_\_\_

**Serial #** \_\_\_\_\_

Find these numbers on a label inside the refrigerator compartment at the top on the right side behind the controls.

# Owner's Manual and Installation Instructions

*www.AmericanaAppliances.com*

*Model 25*

# IMPORTANT SAFETY INFORMATION. READ ALL INSTRUCTIONS BEFORE USING.

Safety Instructions

Operating Instructions

Installation Instructions

Troubleshooting Tips

Consumer Support

## ⚠ **WARNING!**

Use this appliance only for its intended purpose as described in this Owner's Manual.



## SAFETY PRECAUTIONS

When using electrical appliances, basic safety precautions should be followed, including the following:

- This refrigerator must be properly installed and located in accordance with the Installation Instructions before it is used.
- Do not allow children to climb, stand or hang on the shelves in the refrigerator. They could damage the refrigerator and seriously injure themselves.
- Do not touch the cold surfaces in the freezer compartment when hands are damp or wet. Skin may stick to these extremely cold surfaces.
- Do not store or use gasoline or other flammable vapors and liquids in the vicinity of this or any other appliance.
- In refrigerators with automatic icemakers, avoid contact with the moving parts of the ejector mechanism, or with the heating element that releases the cubes. Do not place fingers or hands on the automatic icemaking mechanism while the refrigerator is plugged in.
- Keep fingers out of the "pinch point" areas; clearances between the doors and between the doors and cabinet are necessarily small. Be careful closing doors when children are in the area.
- Unplug the refrigerator before cleaning and making repairs.  
**NOTE:** We strongly recommend that any servicing be performed by a qualified individual.
- Do not refreeze frozen foods which have thawed completely.  
**NOTE:** Turning the refrigerator off via the controls on the touch panel does not shut off electrical power to the refrigerator.

## ⚠ **DANGER! RISK OF CHILD ENTRAPMENT**

### PROPER DISPOSAL OF THE REFRIGERATOR

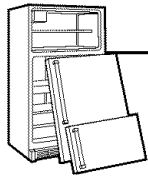

Child entrapment and suffocation are not problems of the past. Junked or abandoned refrigerators are still dangerous...even if they will sit for "just a few days." If you are getting rid of your old refrigerator, please follow the instructions below to help prevent accidents.

#### **Before You Throw Away Your Old Refrigerator or Freezer:**

- Take off the doors.
- Leave the shelves in place so that children may not easily climb inside.

#### **Refrigerants**

All refrigeration products contain refrigerants, which under federal law must be removed prior to product disposal. If you are getting rid of an old refrigeration product, check with the company handling the disposal about what to do.

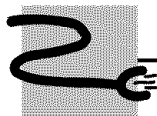

## USE OF EXTENSION CORDS

Because of potential safety hazards under certain conditions, we strongly recommend against the use of an extension cord.

However, if you must use an extension cord, it is absolutely necessary that it be a UL-listed (in the United States) or a CSA-listed (in Canada), 3-wire grounding type appliance extension cord having a grounding type plug and outlet and that the electrical rating of the cord be 15 amperes (minimum) and 120 volts.

## **⚠ WARNING!**

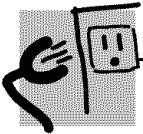

### *HOW TO CONNECT ELECTRICITY*

*Do not, under any circumstances, cut or remove the third (ground) prong from the power cord. For personal safety, this appliance must be properly grounded.*

The power cord of this appliance is equipped with a 3-prong (grounding) plug which mates with a standard 3-prong (grounding) wall outlet to minimize the possibility of electric shock hazard from this appliance.

Have the wall outlet and circuit checked by a qualified electrician to make sure the outlet is properly grounded.

If the outlet is a standard 2-prong outlet, it is your personal responsibility and obligation to have it replaced with a properly grounded 3-prong wall outlet.

The refrigerator should always be plugged into its own individual electrical outlet which has a voltage rating that matches the rating plate.

This provides the best performance and also prevents overloading house wiring circuits which could cause a fire hazard from overheated wires.

Never unplug your refrigerator by pulling on the power cord. Always grip plug firmly and pull straight out from the outlet.

Repair or replace immediately all power cords that have become frayed or otherwise damaged. Do not use a cord that shows cracks or abrasion damage along its length or at either end.

When moving the refrigerator away from the wall, be careful not to roll over or damage the power cord.



*READ AND FOLLOW THIS SAFETY INFORMATION CAREFULLY.*

**SAVE THESE INSTRUCTIONS**

## About the controls on the refrigerator.

### Startup Steps for Proper Temperature Control

STEP 1—Set Fresh Food Control on “5.”

STEP 2—Set Freezer Control on “5.”

STEP 3—WAIT **12 HOURS** for temperature to stabilize.

STEP 4—If a change is needed, move the control one number at a time and allow **12 hours** for temperature to stabilize.

■ On some models, setting both controls to the warmest setting until the display flashes (off) will stop cooling in both the freezer and refrigerator compartments.

■ On other models, setting either control to the warmest setting until the display flashes (off) will stop the cooling to the freezer and refrigerator.

**NOTE:** Turning the refrigerator to the **0** (off) setting via the controls does not shut off electrical power to the refrigerator.

**Control settings will vary based on personal preferences, usage and operating conditions and may require more than one adjustment.**

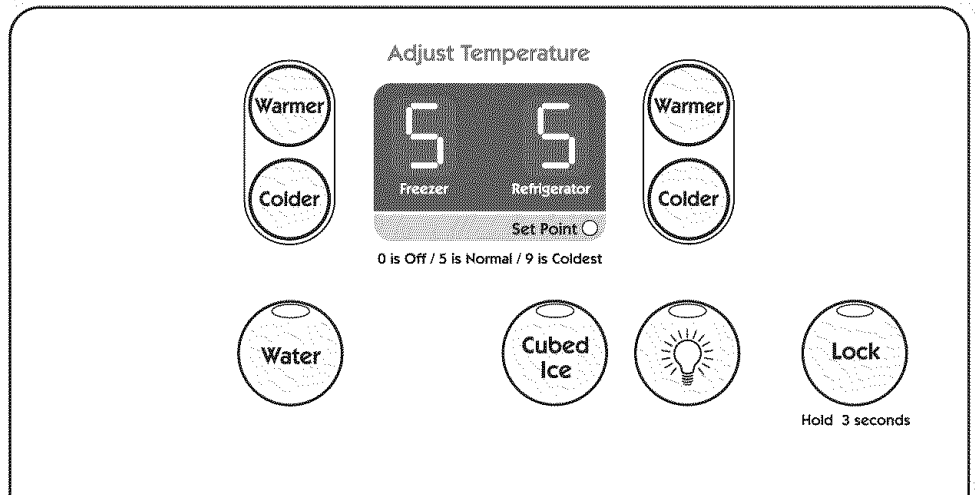
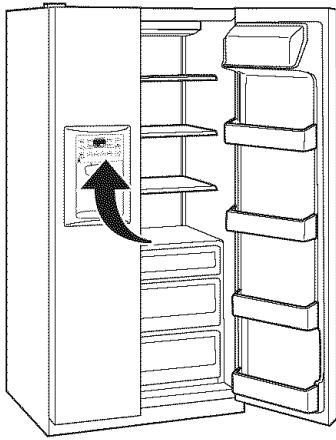

Not all features are on all models.

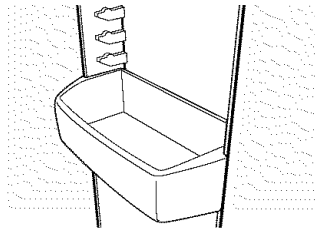

## Bins on the Fresh Food Compartment Door

Adjustable bins can easily be carried from refrigerator to work area.

**To remove:** Lift the front of the bin up, then pull out.

**To replace or relocate:** Engage the bin in the molded supports of the door, and push in. Bin will lock in place.

## Rearranging the Shelves

### Refrigerator Shelves:

To Remove

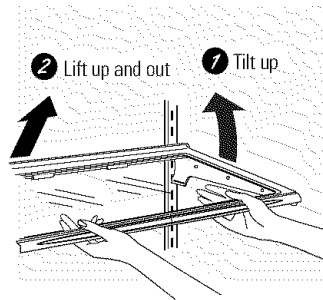

To Replace

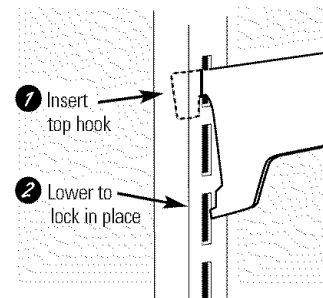

### Freezer Shelves:

To Remove

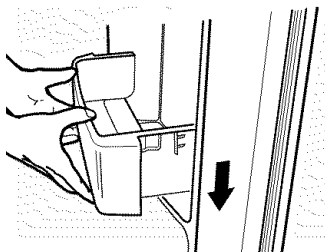
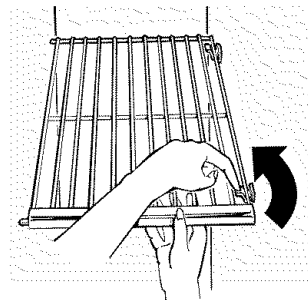

## Deep Door Shelves

Detachable shelf extenders deepen and enclose fixed door shelves, providing more storage room and greater storage flexibility.

**To remove:** Lift the shelf extender straight up, then pull out.

**To replace:** Engage the shelf extender in the molded supports on the door and push in. It will lock in place.

## About the crispers.

Not all features are on all models.

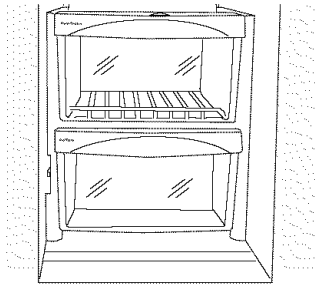

### Fruit and Vegetable Crispers

Excess water that may accumulate in the bottom of the drawers should be wiped dry.

## About the crisper removal.

Not all features are on all models.

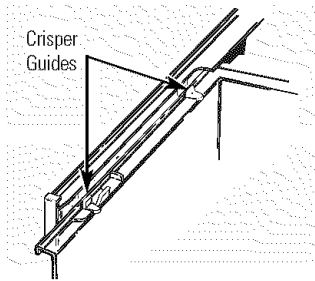

### Crisper Removal

Crispers can easily be removed by tilting up slightly and pulling past **stop** location.

If the door prevents you from taking out the crispers, the refrigerator will need to be rolled forward until the door opens enough to slide the crispers out. In some cases, when you roll the refrigerator out, you will need to move the refrigerator to the left as you roll it out.

When replacing the crispers, make sure you slide them through the crisper guides.

# About the automatic icemaker.



www.AmericanaAppliances.com

A newly-installed refrigerator may take 12–24 hours to begin making ice.

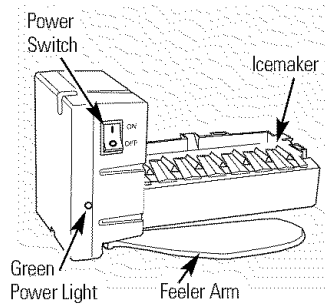

## Automatic Icemaker (on some models)

The icemaker will produce seven cubes per cycle—approximately 100–130 cubes in a 24-hour period, depending on freezer compartment temperature, room temperature, number of door openings and other use conditions.

If the refrigerator is operated before the water connection is made to the icemaker, set the power switch in the **0 (off)** position.

When the refrigerator has been connected to the water supply, set the power switch to the **1 (on)** position.

The icemaker will fill with water when it cools to 15°F. A newly-installed refrigerator may take 12–24 hours to begin making ice cubes.

Throw away the first few batches of ice to allow the water line to clear.

Be sure nothing interferes with the sweep of the feeler arm.

It is normal for several cubes to be joined together.

If ice is not used frequently, old ice cubes will become cloudy, taste stale, and shrink.

If ice cubes get stuck in the icemaker, the green power light will blink. To correct this, set the power switch to **0 (off)** and remove the cubes. Set the power switch to **1 (on)** to restart the icemaker. After the icemaker has been turned on again, there will be a delay of about 45 minutes before the icemaker resumes operation.

**NOTE:** In homes with lower-than-average water pressure, you may hear the icemaker cycle multiple times when making one batch of ice.

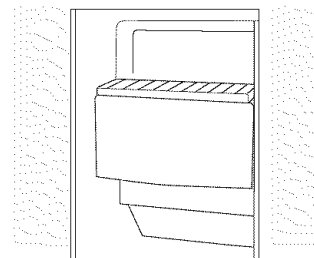

There is an upper freezer shelf above the icemaker that can be used for storage.

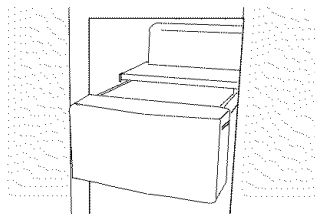

## Ice Storage Drawer

**To access ice**, pull the drawer out.

**To remove the drawer**, pull it straight out and lift it past the **stop** location.

## Icemaker Accessory Kit

If your refrigerator did not come already equipped with an automatic icemaker, an icemaker accessory kit is available at extra cost.

Check the back of the refrigerator for the specific icemaker kit needed for your model.

Safety Instructions

Operating Instructions

Installation Instructions

Troubleshooting Tips



Consumer Support

## About the dispenser.

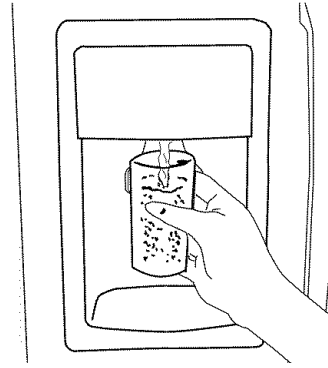
On some models



### To Use the Dispenser

Some dispenser models offer water only. On other models you can select **CUBED ICE**  or **WATER** .

Press the glass gently against the top of the dispenser cradle.

If no water is dispensed when the refrigerator is first installed, there may be air in the water line system. Press the dispenser arm for at least two minutes to remove trapped air from the water line and to fill the water system. To flush out impurities in the water line, throw away the first six glassfuls of water.

**CAUTION:** Never put fingers or any other objects into the ice crusher discharge opening.

### Locking the Dispenser (on some models)

Press the **Lock** pad for 3 seconds to lock the dispenser and control panel. To unlock, press and hold the pad again for 3 seconds.

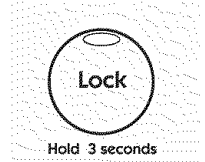

### Dispenser Light (on some models)

This pad turns the **night light** in the dispenser on and off. The light also comes on when the dispenser cradle is pressed. If this light burns out, it should be replaced with a 6 watt maximum, 12 volt DC bulb.

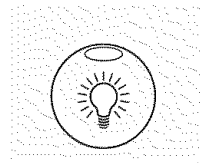

### Ice Storage Drawer on Ice Dispenser Models

#### To remove:

Set the icemaker power switch to the **0 (off)** position. Pull the drawer straight out and then lift past the **stop** position.

#### To replace:

When replacing the drawer, make sure to push it firmly into place. If it does not go all the way back, remove it and rotate the drive mechanism 1/4 turn. Then push the drawer back again.

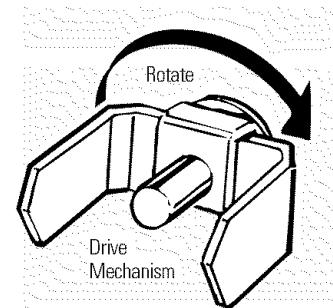
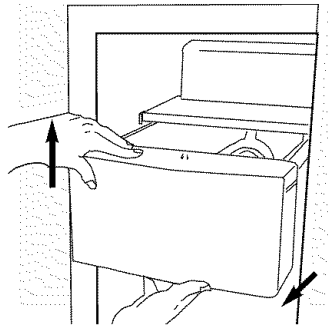

### Important Facts About Your Ice Dispenser

- Do not add ice from trays or bags to the storage bin. It may not crush or dispense well.
- Avoid overfilling glass with ice and use of narrow glasses. Backed-up ice can jam the chute or cause the door in the chute to freeze shut. If ice is blocking the chute, poke it through with a wooden spoon.
- Beverages and foods should not be quick-chilled in the ice storage bin. Cans, bottles or food packages in the storage bin may cause the icemaker or auger to jam.
- To keep dispensed ice from missing the glass, put the glass close to, but not touching, the dispenser opening.
- The first glass of water dispensed may be warmer than the following ones. This is normal.
- Dispensed water is not ice cold. For colder water, simply add ice cubes before dispensing water.



## Cleaning the Outside

**The dispenser drip area**, (on some models) beneath the grille, should be wiped dry. Water left in this area may leave deposits. Remove the deposits by adding undiluted vinegar to the well. Soak until the deposits disappear or become loose enough to rinse away.

**The dispenser cradle** (on some models). Before cleaning, lock the dispenser by pressing and holding the **Lock** pad for 3 seconds. Clean with warm water and baking soda solution—about a tablespoon (15 ml) of baking soda to a quart (1 liter) of water. Rinse thoroughly and wipe dry.

**The door handles and trim.** Clean with a cloth dampened with soapy water. Dry with a soft cloth.

**Keep the outside clean.** Wipe with a clean cloth lightly dampened with kitchen appliance wax or mild liquid dish detergent. Dry and polish with a clean, soft cloth.

*Do not wipe the refrigerator with a soiled dish cloth or wet towel. These may leave a residue that can erode the paint. Do not use scouring pads, powdered cleaners, bleach or cleaners containing bleach because these products can scratch and weaken the paint finish.*

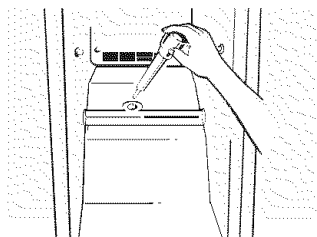

## Cleaning the Inside

**To help prevent odors**, leave an open box of baking soda in the fresh food and freezer compartments.

**Unplug the refrigerator before cleaning.** If this is not practical, wring excess moisture out of sponge or cloth when cleaning around switches, lights or controls.

Use warm water and baking soda solution—about a tablespoon (15 ml) of baking soda to a quart (1 liter) of water. This both cleans and neutralizes odors. Rinse and wipe dry.

After cleaning the door gaskets, apply a thin layer of petroleum jelly to the door gaskets at the hinge side. This helps keep the gaskets from sticking and bending out of shape.

**Drain opening in freezer compartment.** During yearly cleaning, remove bottom freezer basket and flush a solution of baking soda—1 teaspoon (5 ml) and 2 cups (500 ml) of hot (not boiling) water—through the drain line with the help of a meat baster. This will help eliminate odor and reduce the likelihood of a clogged drain line. If drain becomes clogged, use a meat baster and baking soda solution to force the clog through the drain line.

*Avoid cleaning cold glass shelves with hot water because the extreme temperature difference may cause them to break. Handle glass shelves carefully. Bumping tempered glass can cause it to shatter.*

*Do not wash any plastic refrigerator parts in the dishwasher.*

## Care and cleaning of the refrigerator.

---

### **Behind the Refrigerator**

Be careful when moving the refrigerator away from the wall. All types of floor coverings can be damaged, particularly cushioned coverings and those with embossed surfaces.

Pull the refrigerator straight out and return it to position by pushing it straight in. Moving the refrigerator in a side direction may result in damage to the floor covering or refrigerator.

*When pushing the refrigerator back, make sure you don't roll over the power cord or icemaker supply line (on some models).*

---

### **Preparing for Vacation**

For long vacations or absences, remove food and unplug the refrigerator. Clean the interior with a baking soda solution of one tablespoon (15 ml) of baking soda to one quart (1 liter) of water. Leave the doors open.

Set the icemaker power switch to the **O (off)** position and shut off the water supply to the refrigerator.

If the temperature can drop below freezing, have a qualified servicer drain the water supply system (on some models) to prevent serious property damage due to flooding.

---

### **Preparing to Move**

Secure all loose items such as grille, shelves and drawers by taping them securely in place to prevent damage.

*Be sure the refrigerator stays in an upright position during moving.*

# Replacing the light bulbs.

**NOTE:** Turning the refrigerator to the 0 (off) setting via the controls does not shut off electrical power to the refrigerator.

## Fresh Food Compartment—Upper Light

- 1 Unplug the refrigerator.
- 2 On models with pad controls—The bulb is located near the upper-left rear corner of the compartment, behind the light shield.
  - A) Remove the light shield by sliding it forward and out of the compartment.
  - B) Replace with an appliance bulb of the same or lower wattage.
  - C) Replace the light shield by holding it against the left wall and sliding up and toward the rear wall until it snaps in place.
- 3 Plug the refrigerator back in.

On models with knob controls—The bulb is located behind the controls. Replace with an appliance bulb of the same or lower wattage.

## Freezer Compartment

- 1 Unplug the refrigerator.
- 2 Remove the shelf just below light shield. (The shelf will be easier to remove if it is emptied first.)
- 3 Lift up on the light shield to remove.
- 4 After replacing with an appliance bulb of the same or lower wattage, reinstall the shield by hanging it from the three tabs.
- 5 Reinstall the shelf and plug the refrigerator back in.

## Dispenser (on some models)

- 1 Unplug the refrigerator.
- 2 The bulb is located on the dispenser under the control panel. Remove the light bulb by turning it counterclockwise.
- 3 Replace the bulb with a bulb of the same size and wattage.
- 4 Plug the refrigerator back in.

# Installation Instructions

# Refrigerator

Model 25

If you have questions, call 1.800.432.2737

## BEFORE YOU BEGIN

Read these instructions completely and carefully.

- **IMPORTANT** — Save these instructions for local inspector's use.
- **IMPORTANT** — Observe all governing codes and ordinances.
- **Note to Installer** — Be sure to leave these instructions with the Consumer.
- **Note to Consumer** — Keep these instructions for future reference.
- **Skill level** — Installation of this appliance requires basic mechanical skills.
- **Completion time** — Refrigerator Installation  
15 minutes
- Proper installation is the responsibility of the installer.
- Product failure due to improper installation is not covered under the Warranty.

## WATER SUPPLY TO THE ICEMAKER (on some models)

If the refrigerator has an icemaker, it will have to be connected to a cold water line. A GE water supply kit (containing tubing, shutoff valve, fittings and instructions) is available at extra cost from your dealer or from Parts and Accessories, 800.626.2002.

## REFRIGERATOR LOCATION

- Do not install the refrigerator where the temperature will go below 60°F (16°C) because it will not run often enough to maintain proper temperatures.
- Install it on a floor strong enough to support it fully loaded.

## CLEARANCES

Allow the following clearances for ease of installation, proper air circulation and plumbing and electrical connections.

- **Sides** 1/8" (4 mm)
- **Top** 1" (25 mm)
- **Back** 1" (25 mm)

A door clearance of 3/4" (19 mm) is needed for a 90° door opening which provides better access to the food storage area.

## ROLLERS

The rollers have 3 purposes:

- Rollers adjust so the door closes easily when opened about halfway.
- Rollers adjust so the refrigerator is firmly positioned on the floor and does not wobble.
- Rollers allow you to move the refrigerator away from the wall for cleaning.

To adjust the rollers:

Turn the roller adjusting screws **clockwise to raise** the refrigerator, **counterclockwise to lower** it. Use an adjustable wrench (3/8" hex head bolt) or pliers.

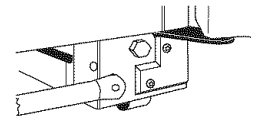

## DOOR ALIGNMENT

After leveling, make sure that the doors are even at the top.

To make the doors even, adjust the refrigerator door as follows:

- 1 Remove the Base Grille, open the doors, then pull the grille straight out.
- 2 Determine which of the two doors is higher than the other.
- 3 Lift the lower door, along with the small cam.
- 4 Place the shim between the Door Metal Hinge and the small cam as shown.
- 5 Press in the shim so that it fits in between the metal hinge and the plastic cam.
- 6 Close the doors and check if they are level at the top. If one door is still lower than the other, repeat the process and insert another shim.

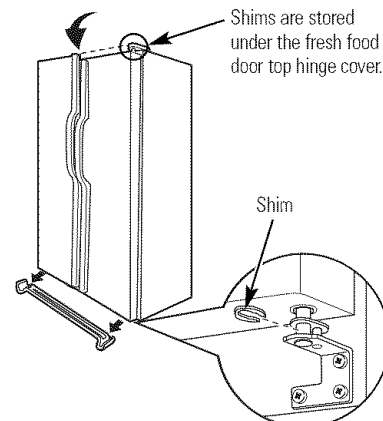

**NOTE:** If the doors are not even and the shim is already inserted, you can remove the shim to lower the door.

# Installation Instructions

## INSTALLING THE WATER LINE

### BEFORE YOU BEGIN

Recommended copper water supply kits are WX8X2, WX8X3 or WX8X4, depending on the amount of tubing you need. Approved plastic water supply lines are GE SmartConnect™ Refrigerator Tubing (WX08X10002, WX08X10006, WX08X10015 and WX08X10025).

When connecting your refrigerator to a GE Reverse Osmosis Water System, the only approved installation is with a GE RVKit. For other reverse osmosis water systems, follow the manufacturer's recommendations.

This water line installation is not warranted by the refrigerator or icemaker manufacturer. Follow these instructions carefully to minimize the risk of expensive water damage.

Water hammer (water banging in the pipes) in house plumbing can cause damage to refrigerator parts and lead to water leakage or flooding. Call a qualified plumber to correct water hammer before installing the water supply line to the refrigerator.

To prevent burns and product damage, do not hook up the water line to the hot water line.

If you use your refrigerator before connecting the water line, make sure the icemaker power switch is in the **O (off)** position.

Do not install the icemaker tubing in areas where temperatures fall below freezing.

When using any electrical device (such as a power drill) during installation, be sure the device is double insulated or grounded in a manner to prevent the hazard of electric shock, or is battery powered.

All installations must be in accordance with local plumbing code requirements.

### WHAT YOU WILL NEED

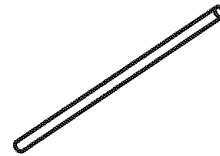

- **Copper or GE SmartConnect™ Refrigerator Tubing kit**, 1/4" outer diameter to connect the refrigerator to the water supply. If using copper, be sure both ends of the tubing are cut square.

To determine how much tubing you need: measure the distance from the water valve on the back of the refrigerator to the water supply pipe. Be sure there is sufficient extra tubing to allow the refrigerator to move out from the wall after installation.

GE SmartConnect™ Refrigerator Tubing Kits are available in the following lengths:

- 2' (.6 m) – WX08X10002
- 6' (1.8 m) – WX08X10006
- 15' (4.6 m) – WX08X10015
- 25' (7.6 m) – WX08X10025

**NOTE: The only GE approved plastic tubing is that supplied in GE SmartConnect™ Refrigerator Tubing kits. Do not use any other plastic water supply line because the line is under pressure at all times. Certain types of plastic will crack or rupture with age and cause water damage to your home.**

# Installation Instructions

## INSTALLING THE WATER LINE

### WHAT YOU WILL NEED (CONT.)

- A **GE water supply kit** (containing tubing, shutoff valve and fittings listed below) is available at extra cost from your dealer or from Parts and Accessories, 800.626.2002.
- A **cold water supply**. The water pressure must be between 20 and 120 p.s.i. (1.4–8.2 bar).

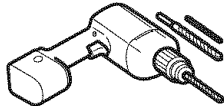

- **Power drill.**
- **1/2" or adjustable wrench.**
- **Straight and Phillips blade screwdriver.**

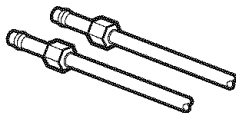

- **Two 1/4" outer diameter compression nuts and 2 ferrules (sleeves)**—to connect the copper tubing to the shutoff valve and the refrigerator water valve.

#### OR

- If you are using a GE SmartConnect™ Refrigerator Tubing kit, the necessary fittings are preassembled to the tubing.

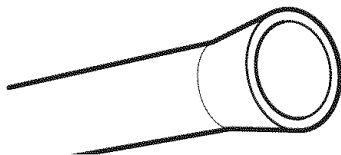

- If your existing copper water line has a flared fitting at the end, you will need an **adapter** (available at plumbing supply stores) to connect the water line to the refrigerator **OR** you can cut off the flared fitting with a **tube cutter** and then use a compression fitting. Do not cut formed end from GE SmartConnect™ Refrigerator tubing.

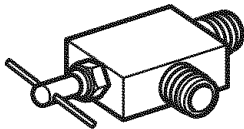

- **Shutoff valve** to connect to the cold water line. The shutoff valve should have a water inlet with a minimum inside diameter of 5/32" at the point of connection to the **COLD WATER LINE**. Saddle-type shutoff valves are included in many water supply kits. Before purchasing, make sure a saddle-type valve complies with your local plumbing codes.

Install the shutoff valve on the nearest frequently used drinking water line.

### 1 SHUT OFF THE MAIN WATER SUPPLY

Turn on the nearest faucet long enough to clear the line of water.

### 2 CHOOSE THE VALVE LOCATION

Choose a location for the valve that is easily accessible. It is best to connect into the side of a vertical water pipe. When it is necessary to connect into a horizontal water pipe, make the connection to the top or side, rather than at the bottom, to avoid drawing off any sediment from the water pipe.

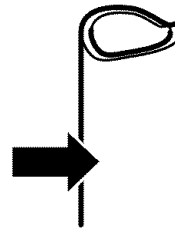

### 3 DRILL THE HOLE FOR THE VALVE

Drill a 1/4" hole in the water pipe (even if using a self-piercing valve) using a sharp bit. Remove any burrs resulting from drilling the hole in the pipe. **Take care not to allow water to drain into the drill.** Failure to drill a 1/4" hole may result in reduced ice production or smaller cubes.

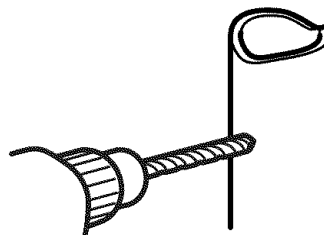

# Installation Instructions

## 4 FASTEN THE SHUTOFF VALVE

Fasten the shutoff valve to the cold water pipe with the pipe clamp.

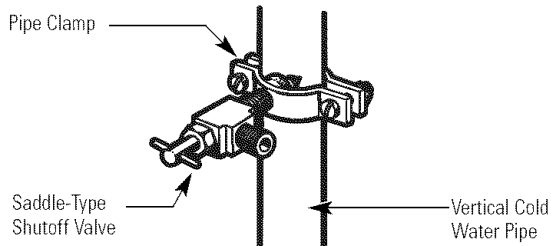

**NOTE:** Commonwealth of Massachusetts Plumbing Codes 248CMR shall be adhered to. Saddle valves are illegal and use is not permitted in Massachusetts. Consult with your licensed plumber.

## 5 TIGHTEN THE PIPE CLAMP

Tighten the clamp screws until the sealing washer begins to swell.

**NOTE:** Do not overtighten or you may crush the tubing.

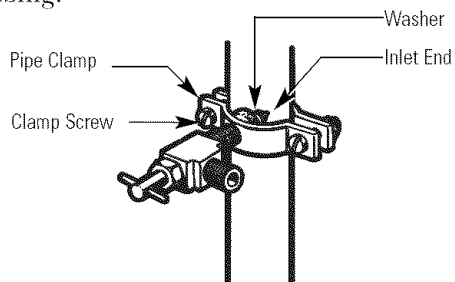

## 6 ROUTE THE TUBING

Route the tubing between the cold water line and the refrigerator.

Route the tubing through a hole drilled in the wall or floor (behind the refrigerator or adjacent base cabinet) as close to the wall as possible.

**NOTE:** Be sure there is sufficient extra tubing to allow the refrigerator to move out from the wall after installation.

## 7 CONNECT THE TUBING TO THE VALVE

Place the compression nut and ferrule (sleeve) for copper tubing onto the end of the tubing and connect it to the shutoff valve.

Make sure the tubing is fully inserted into the valve. Tighten the compression nut securely.

For plastic tubing from a GE SmartConnect™ Refrigerator Tubing kit, insert the molded end of the tubing into the shutoff valve and tighten compression nut until it is hand tight, then tighten one additional turn with a wrench. Overtightening may cause leaks.

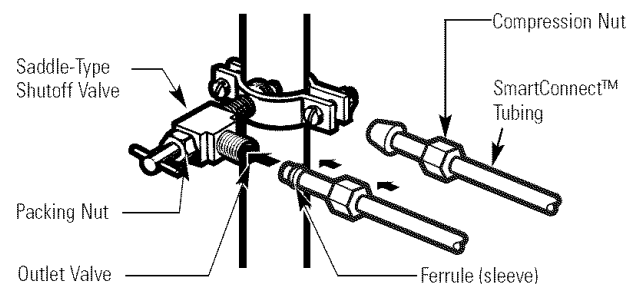

**NOTE:** Commonwealth of Massachusetts Plumbing Codes 248CMR shall be adhered to. Saddle valves are illegal and use is not permitted in Massachusetts. Consult with your licensed plumber.

## 8 FLUSH OUT THE TUBING

Turn the main water supply on and flush out the tubing until the water is clear.

Shut the water off at the water valve after about one quart (1 liter) of water has been flushed through the tubing.

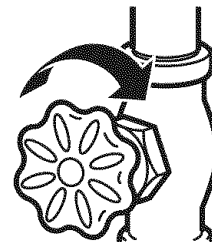

# Installation Instructions

## INSTALLING THE WATER LINE (cont.)

### 9 CONNECT THE TUBING TO THE REFRIGERATOR

#### NOTES:

- Before making the connection to the refrigerator, be sure the refrigerator power cord is not plugged into the wall outlet.
- If your refrigerator does not have a water filter, we recommend installing one if your water supply has sand or particles that could clog the screen of the refrigerator's water valve. Install it in the water line near the refrigerator. If using a GE SmartConnect™ Refrigerator Tubing kit, you will need an additional tube (WX08X10002) to connect the filter. Do not cut plastic tube to install filter.

Some models have the refrigerator connection at the end of tubing located outside the compressor compartment access cover. On other models, the compressor compartment access cover must be removed in order to access the refrigerator connection at the water valve.

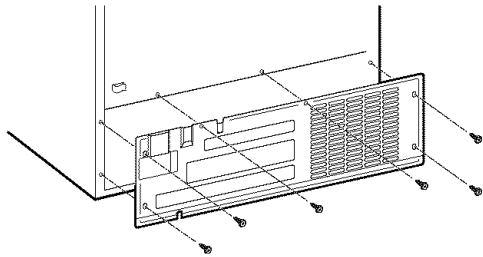

On models using the refrigeration connection at the water valve, remove the plastic flexible cap.

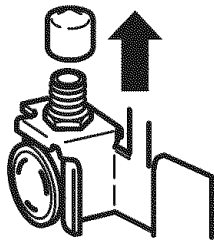

Place the compression nut and ferrule (sleeve) onto the end of the tubing as shown. On a GE SmartConnect Refrigerator Tubing kit, the nuts are already assembled to the tubing.

### 9 CONNECT THE TUBING TO THE REFRIGERATOR (CONT.)

Insert the end of the tubing into the refrigerator connection as far as possible. While holding the tubing, tighten the fitting.

For plastic tubing from a GE SmartConnect Refrigerator Tubing kit, insert the molded end of the tubing into the refrigerator connection and tighten the compression nut until it is hand tight, then tighten one additional turn with a wrench. Overtightening may cause leaks.

Fasten the tubing into the clamp provided as shown to keep it in position. You may need to pry open the clamp.

One of the illustrations below will look like the connection on your refrigerator.

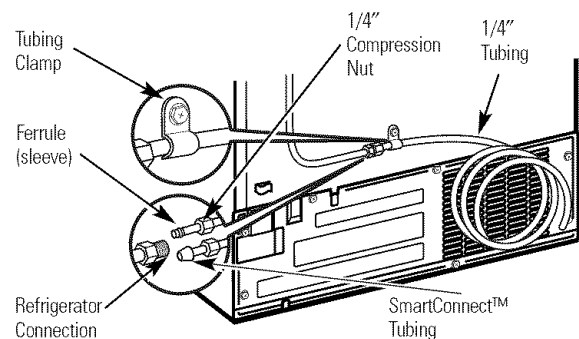
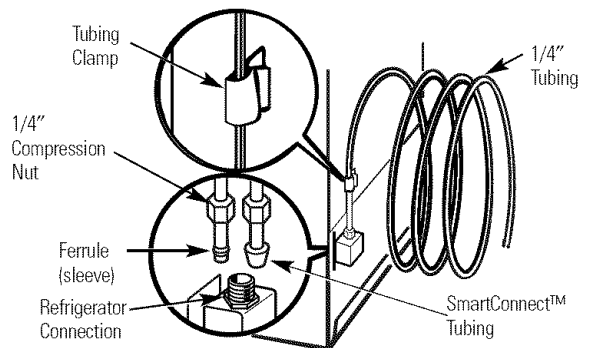

### 10 TURN THE WATER ON AT THE SHUTOFF VALVE

Tighten any connections that leak.

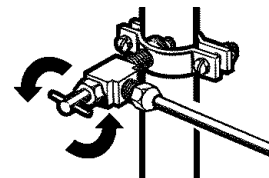

Reattach the access cover.



# Installation Instructions

## 11 PLUG IN THE REFRIGERATOR

Arrange the coil of tubing so that it does not vibrate against the back of the refrigerator or against the wall. Push the refrigerator back to the wall.

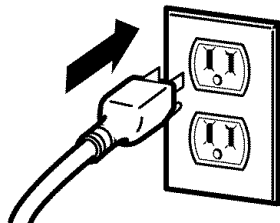

## START THE ICEMAKER

Set the icemaker power switch to the *I (on)* position. The icemaker will not begin to operate until it reaches its operating temperature of 15°F (-9°C) or below. It will then begin operation automatically if the icemaker power switch is in the *I (on)* position.

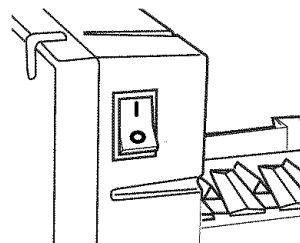

**NOTE:** In lower water pressure conditions, the water valve may turn on up to 3 times to deliver enough water to the icemaker.

## Normal operating sounds.

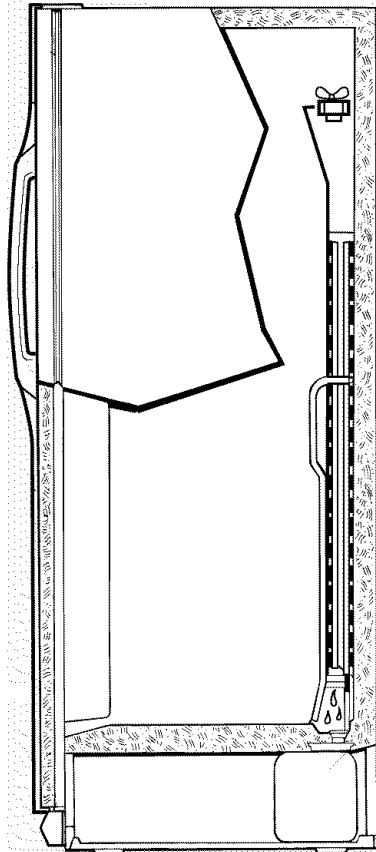

The new high efficiency compressor runs faster and will have a higher pitch hum or pulsating sound while operating.

The fan circulating air inside the freezer which keeps the temperatures throughout.

Water dropping on the defrost heater causing a sizzling, hissing or popping sound during the defrost cycle.

The flow of refrigerant through the freezer cooling coils sounds like boiling water or a gurgling noise.

Cracking or popping of cooling coils caused by expansion and contraction during defrost and refrigeration following defrost.

Water dripping as it melts from the evaporator and flows to the drain pan during the defrost cycle.

### **Icemaker** (on some models)

The icemaker water valve will buzz when the icemaker fills with water. If the power switch is in the **I (on)** position, it will buzz even if it has not yet been hooked up to water. Keeping the power switch in the **I (on)** position before it is hooked up to water can damage the icemaker. To prevent this, set the power switch to the **O (off)** position. This will stop the buzzing.

The sound of cubes dropping into the bin and water running in pipes as icemaker refills.

These sounds are normal and are due mostly to highly efficient operation.

## Before you call for service...



**Troubleshooting Tips**  
Save time and money! Review the charts on the following pages first and you may not need to call for service.

Problem	Possible Causes	What To Do
<b>Refrigerator does not operate</b>	Refrigerator in defrost cycle.	• Wait about 30 minutes for defrost cycle to end.
	Freezer control in <b>O (off)</b> position.	• Move the freezer control to a lower temperature setting.
	Refrigerator is unplugged.	• Push the plug completely into the outlet.
	The fuse is blown/circuit breaker is tripped.	• Replace fuse or reset the breaker.
<b>Vibration or rattling (slight vibration is normal)</b>	Front rollers need adjusting.	• See <i>Rollers</i> .

<b>Problem</b>	<b>Possible Causes</b>	<b>What To Do</b>
<b>Motor operates for long periods or cycles on and off frequently. (Modern refrigerators with more storage space and a larger freezer require more operating time. They start and stop often to maintain even temperatures.)</b>	Normal when refrigerator is first plugged in.	• Wait 24 hours for the refrigerator to completely cool down.
	Often occurs when large amounts of food are placed in refrigerator.	• This is normal.
	Door left open.	• Check to see if package is holding door open.
	Hot weather or frequent door openings.	• This is normal.
	Temperature controls set at the coldest setting.	• See <i>About the controls</i> .
<b>Fresh food or freezer compartment too warm</b>	Temperature control not set cold enough.	• See <i>About the controls</i> .
	Warm weather or frequent door openings.	• Set the temperature control one step colder. See <i>About the controls</i> .
	Door left open.	• Check to see if package is holding door open.
<b>Frost or ice crystals on frozen food (frost within package is normal)</b>	Door left open.	• Check to see if package is holding door open.
	Too frequent or too long door openings.	
<b>Divider between fresh food and freezer compartments feels warm</b>	Automatic energy saver system circulates warm liquid around front edge of freezer compartment.	• This helps prevent condensation on the outside.
<b>Automatic icemaker does not work (on some models)</b>	Icemaker power switch is in the <i>O (off)</i> position.	• Set the power switch to the <i>I (on)</i> position.
	Water supply turned off or not connected.	• See <i>Installing the water line</i> .
	Freezer compartment too warm.	• Wait 24 hours for the refrigerator to completely cool down.
	Piled up cubes in the storage bin cause the icemaker to shut off.	• Level cubes by hand.
	Ice cubes stuck in icemaker. (Green power light on icemaker blinking).	• Turn off the icemaker, remove cubes, and turn the icemaker back on.
<b>Ice cubes have odor/taste</b>	Ice storage bin needs cleaning.	• Empty and wash bin. Discard old cubes.
	Food transmitting odor/taste to ice cubes.	• Wrap foods well.
	Interior of refrigerator needs cleaning.	• See <i>Care and cleaning</i> .
<b>Slow ice cube freezing</b>	Door left open.	• Check to see if package is holding door open.
	Temperature control not set cold enough.	• See <i>About the controls</i> .
<b>Door not closing properly</b>	Door gasket on hinge side sticking or folding over.	• Apply petroleum jelly on face of gasket.
<b>Orange glow in the freezer</b>	Defrost heater is on.	• This is normal.

## Before you call for service...

<b>Problem</b>	<b>Possible Causes</b>	<b>What To Do</b>
<b>Cube dispenser does not work (on some models)</b>	Icemaker turned off or water supply turned off.	• Turn on icemaker or water supply.
	Ice cubes are frozen to icemaker feeler arm.	• Remove cubes.
	Irregular ice clumps in storage container.	• Break up with fingertip pressure and discard remaining clumps. • Freezer may be too warm. Adjust the freezer control to a colder setting, one position at a time, until clumps do not form.
	Dispenser is <b>LOCKED</b> .	• Press and hold the <b>Lock</b> pad for 3 seconds.
<b>Water has poor taste/odor (on some models)</b>	Water dispenser has not been used for a long time.	• Dispense water until all water in system is replenished.
<b>Water dispenser does not work (on some models)</b>	Water supply line turned off or not connected.	• See <i>Installing the water line</i> .
	Air may be trapped in the water system.	• Press the dispenser arm for at least two minutes.
	Dispenser is <b>LOCKED</b> .	• Press and hold the <b>Lock</b> pad for 3 seconds.
<b>No water or ice cube production</b>	Supply line or shutoff valve is clogged.	• Call a plumber.
	Dispenser is <b>LOCKED</b> .	• Press and hold the <b>Lock</b> pad for 3 seconds.
<b>Refrigerator has odor</b>	Foods transmitting odor to refrigerator.	• Foods with strong odors should be tightly wrapped. • Keep an open box of baking soda in the refrigerator; replace every three months.
	Interior needs cleaning.	• See <i>Care and cleaning</i> .
	Defrost water drainage system needs cleaning.	• See <i>Care and cleaning</i> .
<b>Moisture forms on outside of refrigerator</b>	Not unusual during periods of high humidity.	• Wipe surface dry.
<b>Moisture collects inside (in humid weather, air carries moisture into refrigerator when doors are opened)</b>	Too frequent or too long door openings.	
<b>Interior light does not work</b>	No power at outlet.	• Replace fuse or reset the breaker.
	Light bulb burned out.	• See <i>Replacing the light bulbs</i> .
<b>Water on kitchen floor or on bottom of freezer</b>	Drain in the bottom of the freezer clogged.	• See <i>Care and cleaning</i> .
	Cubes jammed in chute.	• Poke ice through with a wooden spoon.
<b>Hot air from bottom of refrigerator</b>	Normal air flow cooling motor. In the refrigeration process, it is normal that heat be expelled in the area under the refrigerator. Some floor coverings are sensitive and will discolor at these normal and safe temperatures.	

## GE Service Protection Plus™

GE, a name recognized worldwide for quality and dependability, offers you Service Protection Plus™—comprehensive protection on all your appliances—**No Matter What Brand!**

***We'll Cover Any Appliance.  
Anywhere. Anytime.\****

**Benefits Include:**

- Backed by GE
- All brands covered
- Unlimited service calls
- All parts and labor costs included
- No out-of-pocket expenses
- No hidden deductibles
- One 800 number to call

You will be completely satisfied with our service protection or you may request your money back on the remaining value of your contract. No questions asked. It's that simple.

Protect your refrigerator, dishwasher, washer and dryer, range, TV, VCR and much more—**any brand!** Plus there's no extra charge for emergency service and low monthly financing is available. Even icemaker coverage and food spoilage protection is offered. You can rest easy, knowing that all your valuable household products are protected against expensive repairs.

Place your confidence in GE and call us in the U.S. toll-free at **800.626.2224** for more information.

\*All brands covered, up to 20 years old, in the continental U.S.

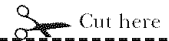

Please place in envelope and mail to:

***General Electric Company***  
**Warranty Registration Department**  
**P.O. Box 32150**  
**Louisville, KY 40232-2150**

# Consumer Product Ownership Registration

Dear Customer:

Thank you for purchasing our product. Registration for Americana™ is provided by GE.

Thank you for placing your confidence in us. We are proud to have you as a customer!

## Follow these three steps to protect your new appliance investment:

# 1

Complete and mail your Consumer Product Ownership Registration today. Have the peace of mind of knowing we can contact you in the unlikely event of a safety modification.

# 2

After mailing the registration below, store this document in a safe place. It contains information you will need should you require service. Our service number in the USA is: 800 GE CARES (800.432.2737).

# 3

Read your Owner's Manual carefully. It will help you operate your new appliance properly.

Model Number

Serial Number

**Important: If you did not get a registration card with your product, detach and return the form below to ensure that your product is registered.**

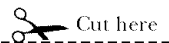

## Consumer Product Ownership Registration



Model Number

Serial Number

Mr.  Ms.  Mrs.  Miss

First Name

Last Name

Street Address

Apt. #

E-mail Address\*

City

State

Zip Code

Date Placed  
In Use  
Month

Day

Year

Phone Number --



**GE Consumer & Industrial**  
Appliances  
General Electric Company  
Louisville, KY 40225  
ge.com

\* Please provide your e-mail address to receive, via e-mail, discounts, special offers and other important communications from GE Appliances (GEA).

Check here if you do not want to receive communications from GEA's carefully selected partners.

**FAILURE TO COMPLETE AND RETURN THIS CARD DOES NOT DIMINISH YOUR WARRANTY RIGHTS.**

For information about GEA's privacy and data usage policy, go to [ge.com](http://ge.com) and click on "Privacy Policy" or call 800.626.2224.



# Refrigerator Warranty.

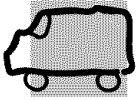

All warranty services for Americana™ are provided by GE Factory Service Centers, or an authorized Customer Care® technician. To schedule service, call 800.432.2737. Please have serial number and model number available when calling for service.

Staple your receipt here.  
Proof of the original purchase date is needed to obtain service under the warranty.

## For The Period Of: **GE Will Replace:**

### One Year

From the date of the original purchase

**Any part** of the refrigerator which fails due to a defect in materials or workmanship. During this **limited one-year warranty**, GE will also provide, **free of charge**, all labor and related service to replace the defective part.

## What GE Will Not Cover:

- Service trips to your home to teach you how to use the product.
- Improper installation, delivery or maintenance.
- Failure of the product if it is abused, misused, or used for other than the intended purpose or used commercially.
- Loss of food due to spoilage.
- Replacement of house fuses or resetting of circuit breakers.
- Damage caused after delivery.
- Replacement of the light bulbs, if included, other than as noted above.
- Damage to the product caused by accident, fire, floods or acts of God.
- Incidental or consequential damage caused by possible defects with this appliance.
- Product not accessible to provide required service.

**EXCLUSION OF IMPLIED WARRANTIES—Your sole and exclusive remedy is product repair as provided in this Limited Warranty. Any implied warranties, including the implied warranties of merchantability or fitness for a particular purpose, are limited to one year or the shortest period allowed by law.**

This warranty is extended to the original purchaser and any succeeding owner for products purchased for home use within the USA. If the product is located in an area where service by a GE Authorized Servicer is not available, you may be responsible for a trip charge or you may be required to bring the product to an Authorized GE Service location for service. In Alaska, the warranty excludes the cost of shipping or service calls to your home.

Some states do not allow the exclusion or limitation of incidental or consequential damages. This warranty gives you specific legal rights, and you may also have other rights which vary from state to state. To know what your legal rights are, consult your local or state consumer affairs office or your state's Attorney General.

**Warrantor: General Electric Company, Louisville, KY 40225**

## Consumer Support.

---

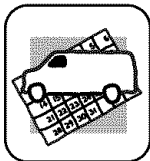

### Schedule Service

Expert GE repair service is only one step away from your door. Schedule service at your convenience by calling 800.432.2737 during normal business hours.

**In Canada, call 1.800.361.3400**



### Extended Warranties

Purchase a GE extended warranty and learn about special discounts that are available while your warranty is still in effect. You can purchase it by calling 800.626.2224 during normal business hours. GE Consumer Home Services will still be there after your warranty expires. **In Canada, call 1.888.261.2133**

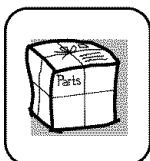

### Parts and Accessories

Individuals qualified to service their own appliances can have parts or accessories sent directly to their homes (VISA, MasterCard and Discover cards are accepted). Order by phone at 800.626.2002 during normal business hours.

**Instructions contained in this manual cover procedures to be performed by any user. Other servicing generally should be referred to qualified service personnel. Caution must be exercised, since improper servicing may cause unsafe operation.**

Customers **in Canada** should consult the yellow pages for the nearest Mabe service center, or call 1.888.261.3055.

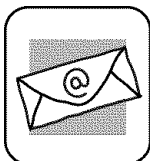

### Contact Us

**[www.AmericanaAppliances.com](http://www.AmericanaAppliances.com)**

If you are not satisfied with the service you receive from GE, send a letter to GE. Please include your phone number.

Write to: General Manager, Customer Relations  
GE Appliances, Appliance Park  
Louisville, KY 40225

**In Canada:** Write to: Director, Consumer Relations, Mabe Canada Inc.  
Suite 310, 1 Factory Lane  
Moncton, N.B. E1C 9M3