

Installation Instructions

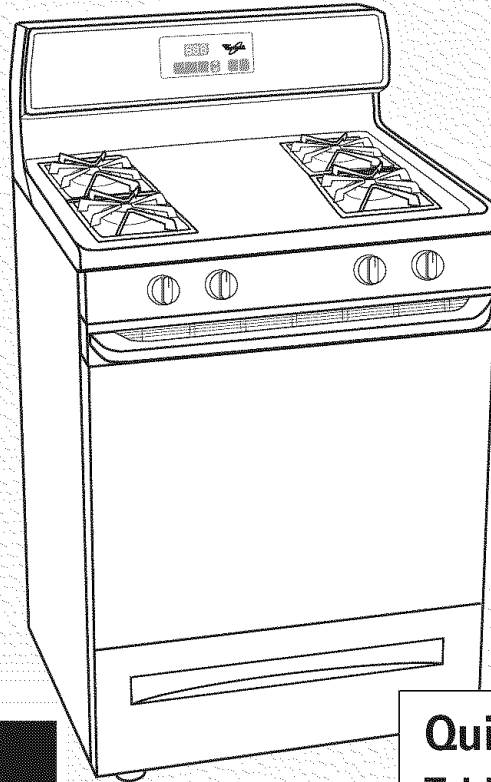

9758661

30" Freestanding Sealed Burner Gas Range with self-cleaning oven



WARNING

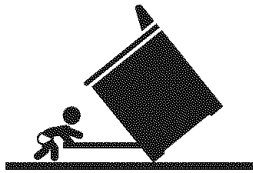

Tip Over Hazard

A child or adult can tip the range and be killed.

Connect anti-tip bracket to rear range foot.

Reconnect the anti-tip bracket, if the range is moved.

Failure to follow these instructions can result in death or serious burns to children and adults.

Quick Reference Table of Contents:

Pages

2	Before you start
3	Electrical requirements
4	Gas supply requirements
5	Product dimensions
5	Cabinet dimensions/requirements
6 - 9	Installation steps
10 - 11	Gas conversions
12	If range does not operate
12	If you need assistance/service
12	Moving the range

IMPORTANT: Read and save these instructions.

IMPORTANT:

Installer: Leave Installation Instructions with the homeowner.

Homeowner: Keep Installation Instructions for future reference.

Read and save these instructions for local electrical inspector's use.

Write down the model and serial numbers before installing range.

Both numbers are listed on the model/serial rating plate located on the oven frame behind the storage drawer panel.

Model # _____

Serial # _____



www.whirlpool.com

Part No. 9758661

Before you start...

Your safety and the safety of others are very important.

We have provided many important safety messages in this manual and on your appliance. Always read and obey all safety messages.



This is the safety alert symbol.

This symbol alerts you to potential hazards that can kill or hurt you and others.

All safety messages will follow the safety alert symbol and either the word "DANGER" or "WARNING." These words mean:

DANGER

You can be killed or seriously injured if you don't immediately follow instructions.

WARNING

You can be killed or seriously injured if you don't follow instructions.

All safety messages will tell you what the potential hazard is, tell you how to reduce the chance of injury, and tell you what can happen if the instructions are not followed.

WARNING: If the information in this manual is not followed exactly, a fire or explosion may result causing property damage, personal injury or death.

- Do not store or use gasoline or other flammable vapors and liquids in the vicinity of this or any other appliance.
- **WHAT TO DO IF YOU SMELL GAS**
 - Do not try to light any appliance.
 - Do not touch any electrical switch.
 - Do not use any phone in your building.
 - Immediately call your gas supplier from a neighbor's phone. Follow the gas supplier's instructions.
 - If you cannot reach your gas supplier, call the fire department.
- Installation and service must be performed by a qualified installer, service agency or the gas supplier.

IMPORTANT: Observe all governing codes and ordinances.

Do not obstruct flow of combustion and ventilation air.

This installation must conform with all local codes and ordinances. In the absence of local codes, installation must conform with American National Standard, National Fuel Gas Code ANSI Z223.1 — latest edition* installation codes.

It is the customer's responsibility:

- To contact a qualified electrical installer.
- To assure that the electrical installation is adequate and in conformance with National Electrical Code, ANSI/NFPA 70 — latest edition*, or CSA Standard C22.1, Canadian Electrical Code, Part 1 — latest edition**, and all local codes and ordinances.

Proper installation is your responsibility. A qualified technician must install this range. Make sure you have everything necessary for correct installation. It is the installer's responsibility to comply with installation clearances specified on the gas information label. The gas information label and model/serial rating plate are located on the frame behind the storage drawer.

Check location where range will be installed. The range should be located for convenient use in kitchen. Recessed installations must provide complete enclosure of the sides and rear of range.

All openings in the wall or floor where range is to be installed must be sealed.

To eliminate the risk of burns or fire by reaching over heated surface units, cabinet storage space located above the surface units should be avoided. If cabinet storage is to be provided, the risk can be reduced by installing a range hood that projects horizontally a minimum of 5 inches beyond the bottom of the cabinets.

Cabinet opening dimensions that are shown must be used. Given dimensions are minimum clearances.

Mobile home installation

The installation of this range must conform to the Manufactured Home Construction and Safety Standards, Title 24 CFR, Part 3280 (formerly the Federal Standard for Mobile Home construction and Safety, Title 24, HUD, Part 280); or when such standard is not applicable, the Standard for Manufactured Homes Installations (Manufactured Home Sites, Communities and Setups), ANSI A225.1/NFPA 501A**, or with local codes.

In Canada, the installation of this range must conform with the current standards CAN/CSA-Z250 — latest edition*, or with local codes.

When this range is installed in a mobile home, it must be secured to the floor during transit. Any method of securing the range is adequate as long as it conforms to the standards listed above.

Copies of the standards listed may be obtained from:

* CSA International
8501 East Pleasant Valley Rd.
Cleveland, Ohio 44131-5575

** National Fire Protection Association
One Batterymarch Park
Quincy, Massachusetts, 02269

Parts supplied:

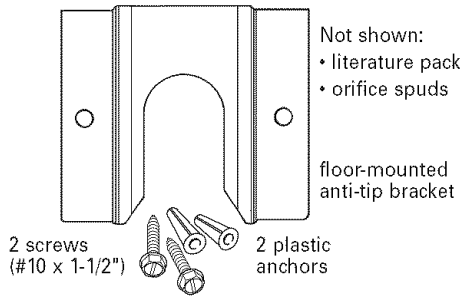

Bracket must be securely mounted to sub-floor. Thickness of flooring may require longer screws to anchor bracket to sub-floor. Longer screws are available from your local hardware store.

Tools needed:

Assemble the required tools and parts before starting installation. Read and follow the instructions provided with any tools listed here.

- level
- flat-blade screwdriver
- Phillips screwdriver
- putty knife
- pipe wrench
- 3/8" drive ratchet
- 5/16" nut driver
- 3/8", 5/16" and 1/2" combination wrenches
- hand or electric drill
- channel lock pliers
- measuring tape or ruler
- wood floors: 1/8" drill bit
- concrete/ceramic floors: 3/16" carbide-tipped masonry drill bit (Hammer may be needed for anchors.)

Materials needed:

- gas line shutoff valve
- 1/2" male pipe thread nipple for connection to pressure regulator
- L.P. gas-resistant pipe-joint compound
- AGA or CSA design-certified flexible metal appliance connector (4-5 feet) (1.2-1.5 m) or rigid gas supply line as needed
- Insulated pad or 1/4" (6 mm) plywood if range is installed over carpeting

Electrical requirements

⚠ WARNING



Electrical Shock Hazard

Plug into a grounded 3 prong outlet.

Do not remove ground prong.

Do not use an adapter.

Do not use an extension cord.

Failure to follow these instructions can result in death, fire, or electrical shock.

If codes permit and a separate ground wire is used, it is recommended that a qualified electrician determine that the ground path is adequate and that the outlet is correctly polarized.

Do not ground to a gas pipe.

Check with a qualified electrician if you are not sure range is properly grounded.

A 120-volt, 60-Hz, AC-only, 10-ampere, fused electrical supply is required. A time-delay fuse or circuit breaker is recommended. It is recommended that a separate circuit serving only this appliance be provided.

Electronic ignition systems operate within wide voltage limits, but proper grounding and polarity are necessary. In addition to checking that the outlet is correctly grounded, the outlet must be checked by a qualified electrician to see if it is wired with correct polarity.

IMPORTANT: This range is equipped with an electronic ignition system that will not operate if plugged into an outlet that is not properly polarized.

A wiring diagram is included on the back of the range.

See "Cabinet dimensions/requirements" for recommended location of electrical outlet.

Recommended ground method

For personal safety, this range is equipped with a power supply cord having a 3 prong ground plug. To minimize possible shock hazard, the cord must be plugged into a mating 3 prong, ground-type outlet, grounded in accordance with the National Electrical Code, ANSI/NFPA 70 — latest edition* or CSA Standard C22.1, Canadian Electrical Code, Part 1, — latest edition** and all local codes and ordinances.

If a mating outlet is not available, it is the personal responsibility and obligation of the customer to have a properly polarized and grounded, 3 prong outlet installed by a qualified electrician.

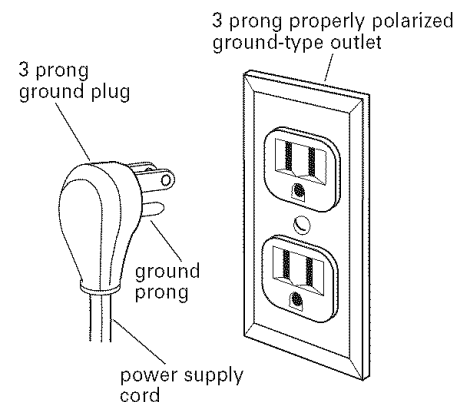

Copies of the standards listed may be obtained from:

* CSA International
8501 East Pleasant Valley Rd.
Cleveland, Ohio 44131-5575

** National Fire Protection Association
One Batterymarch Park
Quincy, Massachusetts, 02269

Gas supply requirements

⚠ WARNING



Explosion Hazard

Use a new AGA or CSA approved gas supply line.

Install a shutoff valve.

Securely tighten all gas connections.

If connected to LP, have a qualified person make sure gas pressure does not exceed 14" (35.6 cm) water column.

Examples of a qualified person include:

licensed heating personnel, authorized gas company personnel, and authorized service personnel.

Failure to do so can result in death, explosion, or fire.

In the State of Massachusetts, the following installation instructions apply:

- Installations and repairs must be performed by a qualified or licensed contractor, plumber, or gasfitter qualified or licensed by the State of Massachusetts.
- If using a ball valve, it shall be a T-handle type.
- A flexible gas connector, when used, must not exceed 3 feet.

Observe all governing codes and ordinances.

This installation must conform with local codes and ordinances. In the absence of local codes, installations must conform with American National Standard, National Fuel Gas Code ANSI Z223.1 — latest edition*, or CAN/CSA-B149 — latest edition*, institution codes.

Input ratings shown on the model/serial rating plate are for elevations up to 2,000 feet (610 m). For assistance when installing the range at higher elevations, contact your local service company.

Type of gas: This range is design-certified by CSA International for use with Natural gas or, after proper conversion, for use with L.P. gas. This range is factory set for use with Natural gas. Gas conversion instructions are provided in "Gas conversions" section. The model/serial rating plate located on the frame behind the storage drawer or broiler door has information on the type of gas that can be used. If the type of gas listed does not agree with the type of gas available, check with the local gas supplier. Conversion must be done by a qualified service technician.

Gas supply line: Provide a gas supply line of 3/4" rigid pipe to the range location. With L.P. gas, piping or tubing size can be 1/2" minimum. A smaller size pipe on longer runs may result in insufficient gas supply. Usually, L.P. gas suppliers determine the size and materials used in the system.

Pipe-joint compounds made for use with L.P. gas must be used on pipe threads only.

Flexible metal appliance connector: If local codes permit, a new AGA or CSA design-certified, 1/2" or 3/4" I.D., flexible metal appliance connector is recommended for connecting range to the gas supply line. A 1/2" male pipe thread nipple is needed for connection to pressure regulator female pipe threads. Do not kink or damage the flexible metal tubing when moving the range.

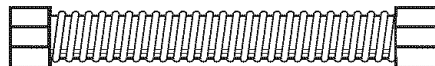

Rigid pipe connection:

Requires a combination of pipe fittings to obtain an in-line connection to the range. All strains must be removed from the supply and fuel lines so range will be level and in line.

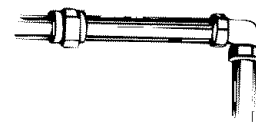

Shutoff valve: The supply line must be equipped with a manual shutoff valve. This valve should be located in the same room as the range and should be in a location that allows ease of opening and closing. The valve is for turning on or shutting off gas to the range. Do not block access to shutoff valve.

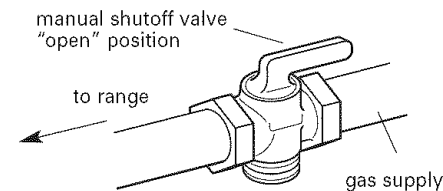

Pressure regulator: The gas pressure regulator supplied with this range must be used. The inlet pressure to the regulator should be as follows for proper operation:

NATURAL GAS:

Minimum pressure: 5 inches W.C.
Maximum pressure: 14 inches W.C.

L.P. GAS:

Minimum pressure: 11 inches W.C.
Maximum pressure: 14 inches W.C.

Contact local gas supplier if you are not sure about the inlet pressure.

Line pressure testing above 1/2 psi gauge (14" WCP) — The range and its individual manual shutoff valve must be disconnected from the gas supply piping system during any pressure testing of that system at test pressures greater than 1/2 psig (3.5 kPa).

Line pressure testing at 1/2 psi gauge (14" WCP) or lower — The range must be isolated from the gas supply piping system by closing its individual manual shutoff valve during any pressure testing of that system at test pressures equal to or less than 1/2 psig (3.5 kPa).

Copies of the standards listed may be obtained from:

* CSA International
8501 East Pleasant Valley Rd.
Cleveland, Ohio 44131-5575

Product dimensions

Grounded electrical outlet is required.
See "Electrical requirements."

Proper gas supply connection must be
available. See "Gas supply requirements."

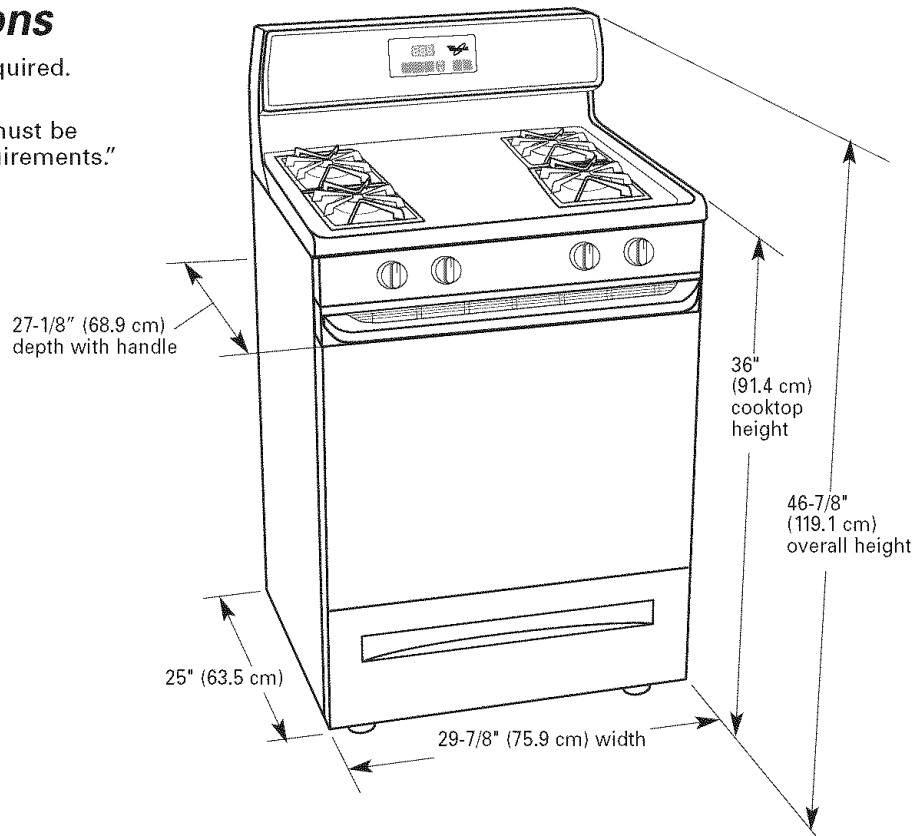

Cabinet dimensions/requirements

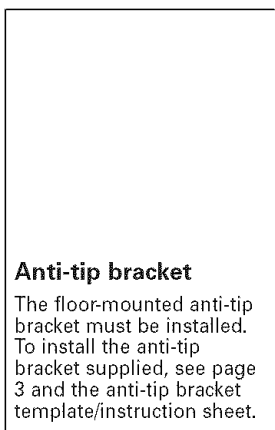

Anti-tip bracket

The floor-mounted anti-tip
bracket must be installed.
To install the anti-tip
bracket supplied, see page
3 and the anti-tip bracket
template/instruction sheet.

Now start...

⚠ WARNING

Excessive Weight Hazard

Use two or more people to move and install range.

Failure to do so can result in back or other injury.

1. Do not use oven door handle to lift or move the range.

2. Remove shipping materials, tape and protective film from range. Keep cardboard bottom and shipping base under range to prevent damage to floor covering.

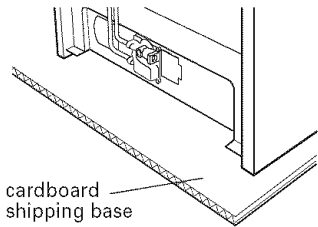

3. Remove oven racks and parts package from inside oven.

Anti-tip bracket installation

⚠ WARNING



Tip Over Hazard

A child or adult can tip the range and be killed.

Connect anti-tip bracket to rear range foot.

Reconnect the anti-tip bracket, if the range is moved.

Failure to follow these instructions can result in death or serious burns to children and adults.

Contact a qualified floor covering installer for the best procedure for drilling mounting holes through your type floor covering.

4. Use the anti-tip bracket template to install the anti-tip bracket.

Anti-tip bracket must be anchored securely to the sub-floor.

Depending on the thickness of your flooring, longer screws may be necessary to anchor the bracket to the sub-floor. Longer screws are available from your local hardware store.

Operating position

5. Remove cardboard shipping base from under range. Remove storage drawer. Use a 3/8" drive ratchet to lower rear leveling legs one-half turn. Use channel lock pliers to lower front leveling legs one-half turn.

Before moving range across floor, check that range is still on cardboard shipping base to protect floor covering.

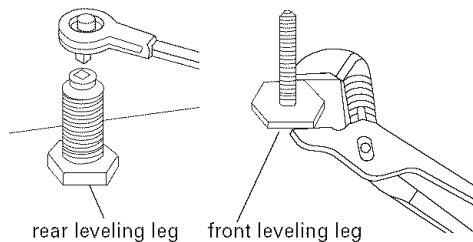

6. Make sure the anti-tip bracket is installed:

- Look for the anti-tip bracket securely attached to floor.
- Slide range back so rear range foot is under anti-tip bracket. Replace storage drawer.

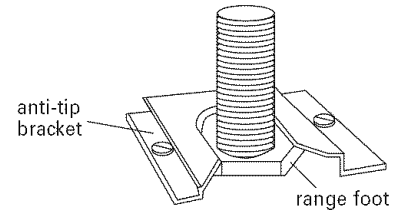

7. If installing the range in a mobile home, you must secure the range to the floor. Any method of securing the range is adequate as long as it conforms to the "Manufactured Home Construction and Safety Standards."

8. Place rack in oven. Place level on rack, first side to side; then front to back. If range is not level, pull range forward until rear leveling leg is removed from the anti-tip bracket. Use 3/8" drive ratchet and channel lock pliers to adjust leveling legs up or down until range is level. Push range back into position. Check that rear leveling leg is engaged in anti-tip bracket.

NOTE: Oven must be level for satisfactory baking conditions.

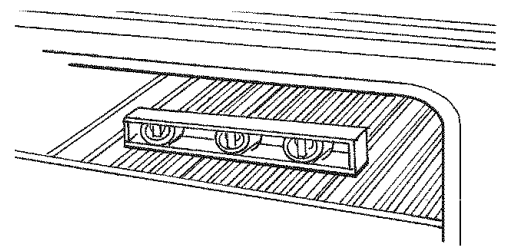

Gas and electrical connections

9. Apply pipe-joint compound made for use with L.P. gas to the smaller thread ends of the flexible connector adapters. Attach one adapter to the pressure regulator elbow and the other adapter to the gas shutoff valve. Tighten both adapters.

All connections must be wrench-tightened.

Typical rigid pipe connection

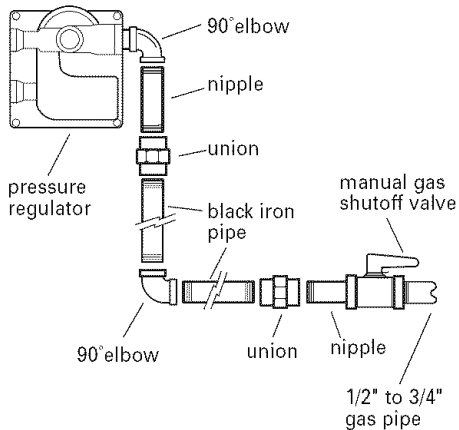

Typical flexible connection

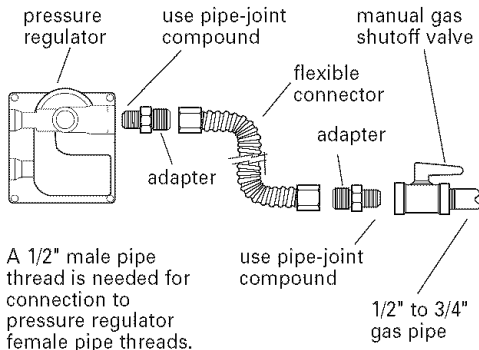

A 1/2" male pipe thread is needed for connection to pressure regulator female pipe threads.

10. Use 5/16" combination wrench and channel lock pliers to attach the flexible connector to the adapters. Check that connector is not kinked.

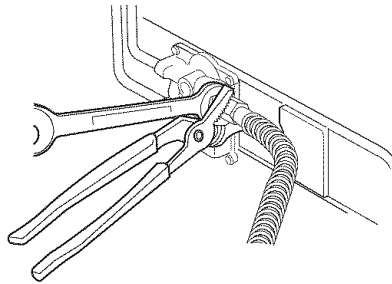

11. Check that range regulator shutoff valve is in the "on" position. Open the manual shutoff valve in the gas supply line.

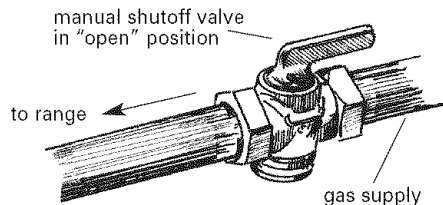
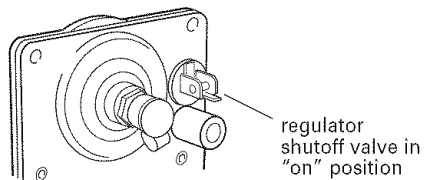

12. Test all connections by brushing on an approved non-corrosive leak-detection solution. Bubbles will show a leak. If a leak appears, shut off gas supply valve and tighten connections. Then check connections again. Clean all leak-detection solution from gas connections. Close broiler door.

13. Center the burner cap on burner base. Burner cap should be level when properly positioned. Place burner grates over burner.

14. Plug power supply cord into grounded electrical outlet.

Check operation

Electronic ignition system

Cooktop and oven burners use electronic ignitors in place of standing pilots. When a cooktop control knob is turned to the "LIGHT" position, the system creates a spark to light the burner. This sparking continues until the control knob is turned to the desired setting.

When the oven control is set to the desired setting, a series of sparks lights the oven burner. The sparking will stop when burner gas lights. Sparking will again occur to re-light the burner every time the burner cycles back on again.

Check operation of cooktop

15. After air has been purged from gas line, push in and turn each surface unit control knob to "LIGHT" position. The flame should light within 4 seconds. Turn control knob to "HIGH" position after burner lights.

Check each cooktop burner for proper flame. The small inner cone should have a very distinct blue flame 1/4" (6 mm) to 1/2" (13 mm) long. The outer cone is not as distinct as the inner cone.



16. Push in and turn each cooktop control knob from "LIGHT" to "LOW" setting quickly. The low flame should be a minimum, steady blue flame.

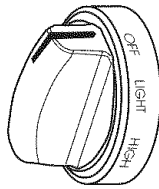

If flame needs to be adjusted, turn control knob to the "LOW" setting and remove control knob. Insert a small flat-blade screwdriver into the valve stem. Turn the valve screw to obtain the smallest flame that will not go out when the control of a cold burner is quickly turned from "HIGH" to "LOW". Repeat for other cooktop burners as needed.

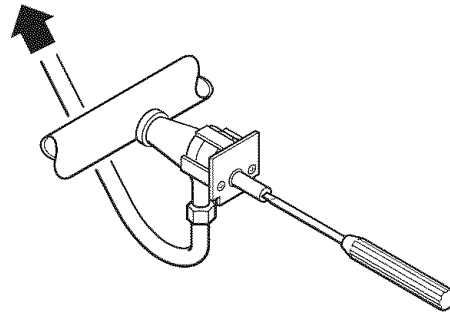

Check operation of oven burner

17. Open oven door.

Remove oven bottom: Remove two screws at the rear of the oven bottom. Lift the rear of the oven bottom up and back until the front of the panel is away from the front frame. Remove from oven.

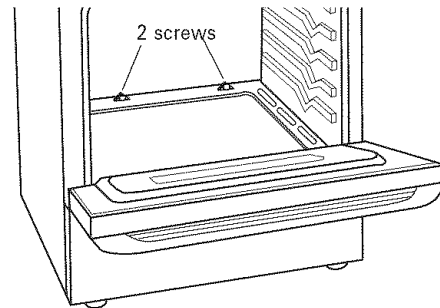

You can check the burner flame by removing the flame spreader or by using a mirror.

Remove flame spreader: Remove two screws from the front tabs of the flame spreader. Lift front of the flame spreader and pull forward to remove tabs from rear of oven.

Using a mirror: Insert mirror to one side of the burner. Look into mirror to check flame.

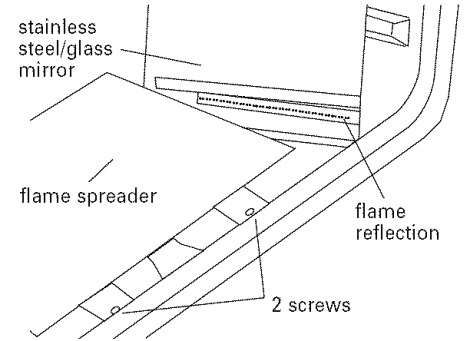

18. Follow the instructions for your type of oven controls.

NOTE: A faint ticking sound will be heard while the oven burner lights. The oven burner should light within 8 seconds.

If your range has an oven temperature control knob:

Push in and turn the oven selector control knob to "350°F". If the burner fails to light due to air remaining in the gas line, reset the oven control by turning selector knob to "OFF" and then again to "350 F".

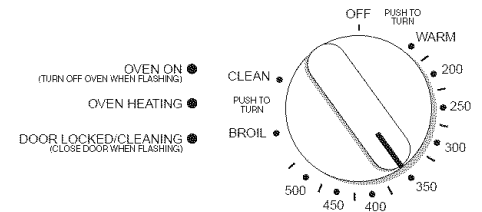

If your oven has electronic controls:

- Press the "BAKE" pad.
 - Depending on model, the "BAKE" and "TEMP" indicators will light and "350" will appear in the display or the "BAKE" indicator will light and "350" will appear in the display.
 - The "START" indicator will begin flashing after 5 seconds.
- Press the "START/ENTER" pad.
 - The "ON" indicator will light.
 - Depending on model, the "TEMP" indicator will turn off.
 - The display will show the automatic countdown time needed to preheat the oven to the selected temperature ("350") and begin counting down.

NOTE: The oven will not go through preheat if the oven temperature is above 170° F; instead, the "TEMP" indicator will light and the selected temperature will appear in the display.

- 19.** Check the oven burner for proper flame. The flame should be 1/2" (13 mm) long, with inner cone of bluish-green, and outer mantle of dark blue, and should be clean and soft in character. No yellow tips, blowing or lifting of flame should occur.
- 

NOTE: If the burner fails to light due to air remaining in the gas line, press the "OFF/CANCEL" pad then press the "BAKE" and "START/ENTER" pads to restart the bake function. Or, if the burner still does not light, check that the regulator shutoff valve is in the "on" position (see step 11).

If oven flame needs to be adjusted: Locate the air shutter next to the pressure regulator. Loosen screw and adjust the air shutter until the proper flame appears. Tighten screw.

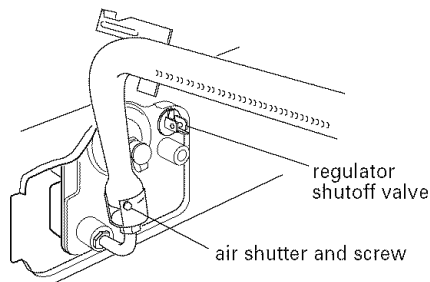

- 20.** Turn the control knob to "OFF" or press the "OFF/CANCEL" pad.

- 21.** Replace flame spreader, oven bottom and oven racks.

Check operation of oven broil burner

- 22.** Follow the instructions for your type of oven controls.

NOTE: A faint ticking sound will be heard while the oven burner lights. The oven burner should light within 8 seconds.

If your range has an oven temperature control knob:

Push in and turn the oven selector control knob to "BROIL." If the burner fails to light due to air remaining in the gas line, reset the oven control by turning selector knob to "OFF" and then again to "BROIL".

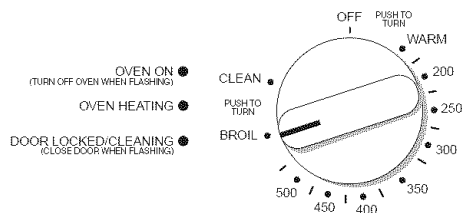

If your oven has electronic controls:

- Press the "CUSTOM BROIL" pad.
 - Depending on model, the "BROIL" and "TEMP" indicators will light and "525" will appear in the display or, the "BROIL" indicator will light and "HI" will appear in the display.
 - The "START" indicator will begin flashing after 5 seconds.
- Press the "START/ENTER" pad.
 - The "ON" indicator will light.

- 23.** Check the broil burner for proper flame. The flame should be 1/2" (13 mm) long, with inner cone of bluish-green, and outer mantle of dark blue, and should be clean and soft in character. No yellow tips, blowing or lifting of flame should occur.
- 

If flame needs to be adjusted: Loosen the lock screw on the air shutter located at the rear of the broil burner. Adjust the air shutter as needed. Tighten lock screw.

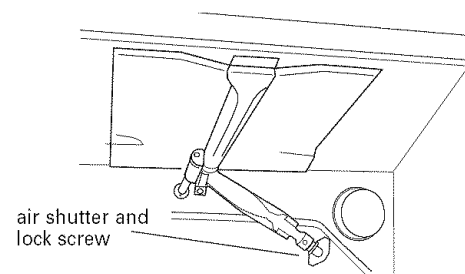

- 24.** Turn the oven control knob to "OFF" or press the "OFF/CANCEL" pad.

You have just finished installing your new range. To get the most efficient use from your range, read your Use & Care Guide. Keep Installation Instructions and Guide close to range for easy reference. The instructions will make installing the range in another home as easy as the first installation.

Gas conversions

Gas conversions (from Natural gas to L.P. gas; or from L.P. gas to Natural gas) must be done by a qualified installer.

⚠ WARNING



Fire Hazard

Shut off gas supply line valve.

Make all conversions before turning gas supply valve back on.

Failure to follow these instructions can result in explosion, fire or injury.

L.P. gas conversion

1. Complete installation steps 1 through 8 before converting cooktop to L.P. gas. Check that main gas supply line has been shut off and the power supply cord is disconnected.

2. Pressure regulator: Remove storage drawer and locate pressure regulator at back of range.

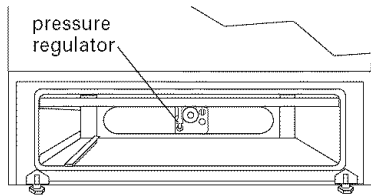

Do not remove the pressure regulator

Remove plastic cover. Turn cap marked "N" on front of pressure regulator counterclockwise with a wrench to remove. Do not disturb or remove the spring beneath the cap. Turn the cap over and reinstall cap on regulator so that the letters "L.P." are visible. Replace plastic cover over cap.

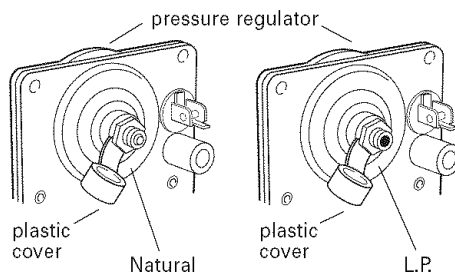
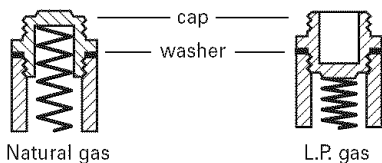

3. Surface burners: Remove burner caps. Use a Phillips or Quadrex screwdriver to remove the two screws holding the burner head down. Lift the burner head off the cooktop to uncover the orifice spud holder. The orifice spud is recessed in the holder.

NOTE: Reinstall one of the screws through the range cooktop to hold orifice spud holder in place while removing and replacing orifice spuds.

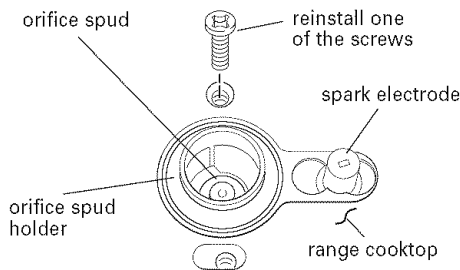

Locate the L.P. gas orifice spud on the spud card on the back of range. Orifice spuds are stamped with a number and marked with two color dots and a groove.

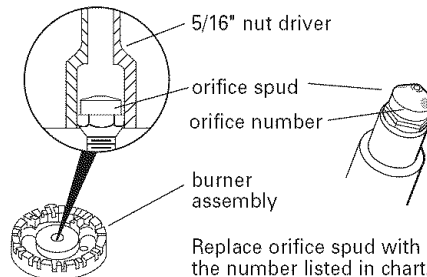
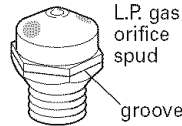

L.P. Gas			
Surface burner	Propane rate (BTU/hr)	Orifice Number	Color Marking
Left rear	8,000	L80	Green/Lt. Blue
Left front	12,000	L103	Green/Blue
Right front	8,000	L80	Green/Lt. Blue
Right rear	5,000	L65	Green/Brown

A brass orifice spud is located in the center of each burner throat about 2" (5 cm) below the cooktop. Apply masking tape to the end of a 5/16" nut driver to fit snugly over the orifice spud. Press driver down onto the spud of the left front burner and remove by turning spud counter-clockwise and lifting it out. Replace the Natural gas spud with the appropriate L.P. gas spud shown in the table.

Continue to replace the remaining orifice spuds, one at a time. Place the Natural gas spuds on the spud card on the back of the range for future use. Replace burner caps using both screws and burner grates.

4. Oven burner: Use 1/2" combination wrench to turn the orifice hood down snug onto pin (approximately 2 to 2-1/2 turns). Do not overtighten. The burner flame cannot be properly adjusted if this conversion is not made.

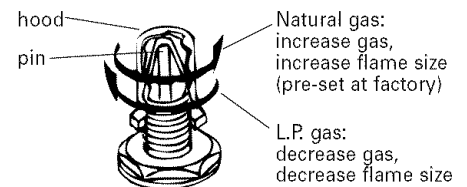
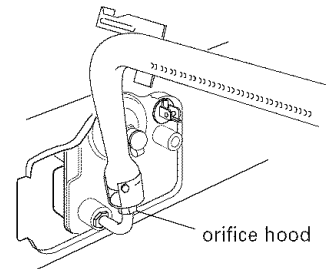

5. Broil burner: Use 1/2" combination wrench to turn the orifice hood down snug onto pin (approximately 2 to 2-1/2 turns). Do not overtighten. The burner flame cannot be properly adjusted if this conversion is not made.

6. Reinstall the storage drawer. Complete installation steps 9 through 24. Checking for proper cooktop burner and oven flame is very important.

You must adjust "LOW" setting for each cooktop burner. See Step 16.

The small inner cone should have a very distinct blue flame 1/4" (6 mm) to 1/2" (13 mm) long. The outer cone is not as distinct as the inner cone. L.P. gas flames may have a slightly yellow tip. If the flame is noisy or blowing, it is getting too much air. If the flame is soft and lazy, it is not getting enough air.

Natural gas conversion

1. Complete installation steps 1 through 8 before converting cooktop to natural gas. Check that main gas supply line has been shut off and the power supply cord is disconnected.

2. Pressure regulator: Remove storage drawer and locate pressure regulator at back of range.

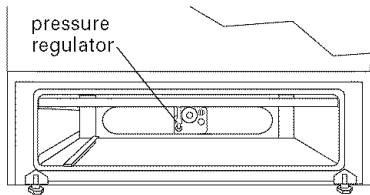

Do not remove the pressure regulator

Remove plastic cover. Turn cap marked "L.P." on front of pressure regulator counterclockwise with a wrench to remove. Do not disturb or remove the spring beneath the cap. Turn the cap over and reinstall cap on regulator so that the letter "N" is visible. Replace plastic cover over cap.

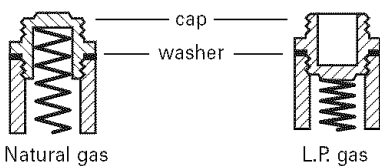
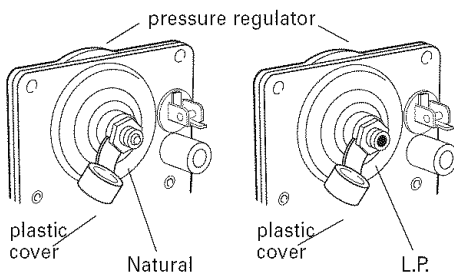

3. Surface burners: Remove burner caps. Use a Phillips or Quadrex screwdriver to remove the two screws holding the burner head down. Lift the burner head off the cooktop to uncover the orifice spud holder. The orifice spud is recessed in the holder.

NOTE: Reinstall one of the screws through the range cooktop to hold orifice spud holder in place while removing and replacing orifice spuds.

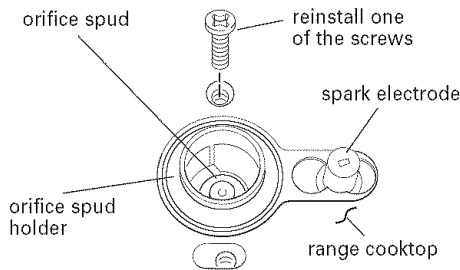

Locate the Natural gas orifice spuds on the spud card on the back of the range. Orifice spuds are stamped with a number and marked with two color dots.



Natural Gas			
Surface burner	Propane rate (BTU/hr)	Orifice Number	Color Marking
Left rear	9,500	N151	Blue/Brass
Left front	13,500	N186	Blue/Orange
Right front	9,500	N151	Blue/Brass
Right rear	5,000	N112	Blue/White

Locate the brass orifice spuds in the center of each burner throat about 2" (5 cm) below the cooktop. Apply masking tape to the end of a 5/16" nut driver to fit snugly over the orifice spud.

Press driver down onto the spud of the left front burner and remove by turning spud counter-clockwise and lifting it out. Replace the L.P. gas spud with the appropriate Natural gas spud shown in the table.

Continue to replace the remaining orifice spuds, one at a time. Place the L.P. gas spuds on the spud card on the back of the range for future use. Replace burner caps using both screws and burner grates.

4. Oven burner: Use 1/2" combination wrench to loosen the orifice hood away from pin (approximately 2 to 2-1/2 turns). The burner flame cannot be properly adjusted if this conversion is not made.

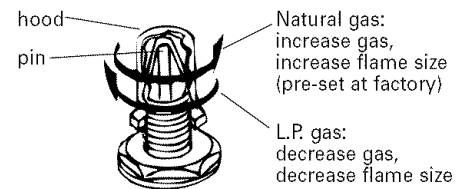
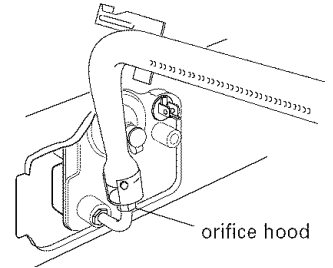

5. Broil burner: Use 1/2" combination wrench to loosen orifice hood away from pin (approximately 2 to 2-1/2 turns). The burner flame cannot be properly adjusted if this conversion is not made.

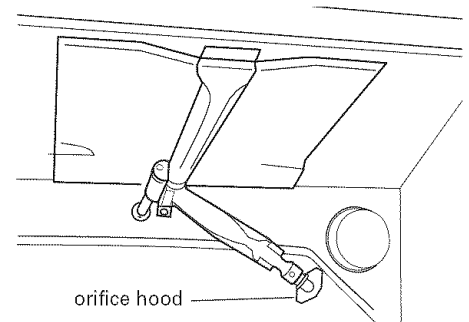

6. Reinstall the storage drawer. Complete installation steps 9 through 24. Checking for proper cooktop burner and oven flame is very important.

You must adjust "LOW" setting for each cooktop burner. See installation step 16.

NOTE: Natural gas flames do not have yellow tips.

If range does not operate:

- Check that the circuit breaker is not tripped or the house fuse blown.
- Check that the power supply cord is plugged into the outlet.
- Check that gas line is turned on.
- See Use and Care Guide for troubleshooting list.

If you need assistance:

If you have questions about operating, cleaning or maintaining your range:

- Refer to Use and Care Guide.
- Call the Customer Interaction Center. Check your Use and Care Guide for a toll-free number to call or call the dealer from whom you purchased this appliance. The dealer is listed in the Yellow Pages of your phone directory under "Appliances — Household — Major — Service and Repair."

If you need service:

Maintain the quality built into your range by calling an authorized service company.

To obtain the name and number of the authorized service company:

- Contact the dealer from whom you purchased your range; or
- Look in the Yellow Pages of your telephone directory under "Appliances — Household — Major — Service and Repair;" or
- Call the Customer Interaction Center. The toll-free number is listed in your Use and Care Guide.

When you call, you will need:

- The range model number.
- The range serial number.

Both numbers are listed on the model/serial rating plate located on the oven frame behind the storage drawer.

Moving the range

WARNING

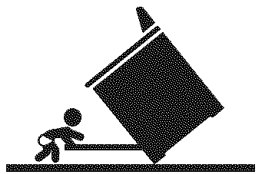

Tip Over Hazard

A child or adult can tip the range and be killed.

Connect anti-tip bracket to rear range foot.

Reconnect the anti-tip bracket, if the range is moved.

Failure to follow these instructions can result in death or serious burns to children and adults.

When moving range, slide range onto cardboard or hardboard to prevent damaging the floor covering.

If removing the range is necessary for cleaning or maintenance:

1. Remove the storage drawer.
2. Shut off gas supply to the range.
3. Disconnect gas.
4. Unplug range or disconnect power.
5. Slide range forward to complete cleaning or maintenance.

6. Make sure the anti-tip bracket is installed:
 - Look for the anti-tip bracket securely attached to floor.
 - Slide range back so rear range foot is under anti-tip bracket.

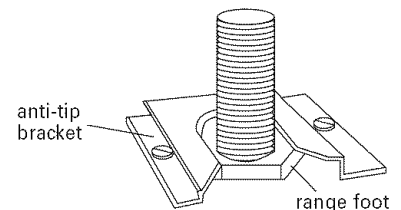

7. Check that range is level.
8. Reconnect gas line to range and check for leaks.
9. Plug in range or reconnect power.
10. Reinstall storage drawer.