

SEARS **Kenmore**

OWNER'S MANUAL

MODEL NO.

911. 47169

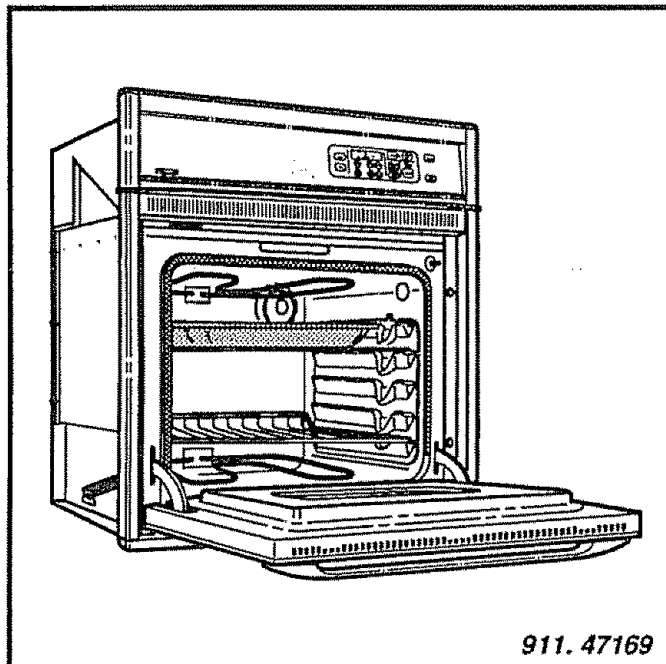

SINGLE 27" ELECTRIC NON SELF-CLEANING WALL OVEN

CAUTION:

*Read and Follow All Safety
Rules and Operating
Instructions Before First
Use of This Product*

- *Safety Instructions*
- *Features*
- *Operation*
- *Care and Cleaning*
- *Problem Solving*
- *Easy Adjustment*
- *Consumer Service*

Sears, Roebuck and Co., Hoffman Estates, IL 60179 U.S.A.

229C4020P071 (SR10296)

BUILT-IN WALL OVEN

TABLE OF CONTENTS

SAFETY INSTRUCTIONS

Range Safety 3-4

USING YOUR OVEN

Features 5

Oven Control, Clock & Timer

..... 6-9
 Traditional Oven Function 6
 Timed Oven Function 6
 Touch Pads 6
 Control Display 7
 Clock, Timer 8
 Tones 9
 F-Codes 9

Oven Cooking Tips 10-12

Strong Smell or Odor 10
 No Peeking 10
 Aluminum Foil 10
 Preheating 10
 Temperature Sensor 10
 Oven Vent 10
 Fan 11
 Moisture 11
 Low Temperature Zone 11
 Using Delay Start 11
 Bakeware 11
 Element Cycling 11
 Bakeware Placement 11
 Oven Racks 12
 Temperature Adjustment 12, 21

BAKING 13

To Set Bake 13
 To Set Time Bake 13
 To Set Delay Bake 13

Broiling 14

General Rules 14
 Preparing Meats 14
 Oven Rack Position 14
 To Set Broil 14

Special Features 15-16

12 Hour Shut-Off 15
 Centigrade Selection 15
 12 Hour Clock 15
 Cook and Hold 16
 Arrow Speed 16

CLEANING AND REMOVABLE PARTS

Control Panel 17
 Broiler Pan and Grid 17
 Oven Racks 17
 Oven Interior 17
 Glass 17
 Oven Door 17, 18
 Replacing the Light Bulb 18

SERVICE

Before Calling for Service 19, 20
 Consumer Service Numbers 22
 Warranty

For your convenience and future reference, please write down your model and serial numbers in the space provided. They are located on the front frame.

MODEL NUMBER:

SERIAL NUMBER:

IMPORTANT INSTRUCTIONS FOR YOUR SAFETY



SAVE THESE INSTRUCTIONS

Read all instructions before using this appliance. When using gas or electrical appliances, basic safety precautions should be followed, including the following:

To insure safety for yourself, family and home, please read your Owner's Manual carefully. Keep it handy for reference. Pay close attention to the Safety sections.

BE SURE your appliance is installed and grounded by a qualified technician.

TEACH CHILDREN

- Not to play with controls or any part of the appliance.
- Not to sit, climb or stand on the oven door.



NEVER WEAR loose fitting clothing when using your appliance.

NEVER USE a towel or other bulky cloth as a pot holder and make sure the pot holder is dry. Moist pot holders could cause steam burns. Keep dish towels, dish cloths, pot holders and other linens a safe distance away from your appliance.

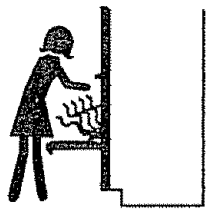

NEVER USE your appliance for warming or heating the room.

BE SURE the appliance is securely installed in a cabinet that is firmly attached to the house structure.

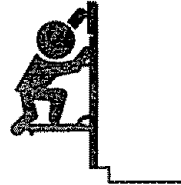

NEVER STORE items of interest to children in cabinets above the appliance.

KEEP THIS book for later use.

NEVER TRY to repair or replace any part of the appliance unless instructions are given in this manual. All other work should be done by a qualified technician.

ALWAYS KEEP the appliance area free from things that will burn. Food, wooden utensils and grease build up could catch fire. Plastic utensils could melt and canned foods could explode. Your appliance should never be used as a storage area.

ALWAYS KEEP your appliance clear of things that will burn (gasoline and other flammable vapors or liquids).

ALWAYS KEEP combustible wall coverings, curtains and other linens a safe distance from the appliance.

NEVER HEAT unopened food containers. Pressure build up can cause the container to burst and cause injury.

NEVER LEAVE jars or cans of fat or drippings in or near your appliance.

SOME CLEANERS produce noxious fumes and wet cloths or sponges could cause steam burns.



IMPORTANT SAFETY PRECAUTIONS



SOME CLEANERS produce noxious fumes, and wet cloths or sponges could cause steam burns.

OVEN SAFETY

PLACE OVEN RACKS in the desired position while the oven is cool. If racks must be moved while oven is hot, do not let pot holder contact the hot oven element.

AFTER BROILING, always take the broiler pan and grid out of the oven and clean them. Leftover grease in the broiler pan could catch fire next time you use your oven.

ALWAYS USE care when opening the oven door. Let hot air and steam escape before moving foods.



READ AND UNDERSTAND THIS INFORMATION NOW!

Should you ever need it, you will not have time for reading. Be sure everyone in your home knows what to do in case of fire. Never use water on a grease fire; it will only spread the flames.

OVEN FIRE :

Do not try to move the pan !

1. Close the oven door and turn controls off.
2. If fire continues, throw baking soda on the fire, or use a dry chemical, foam, or halon type extinguisher.



FEATURES OF YOUR 27" BUILT-IN WALL OVEN

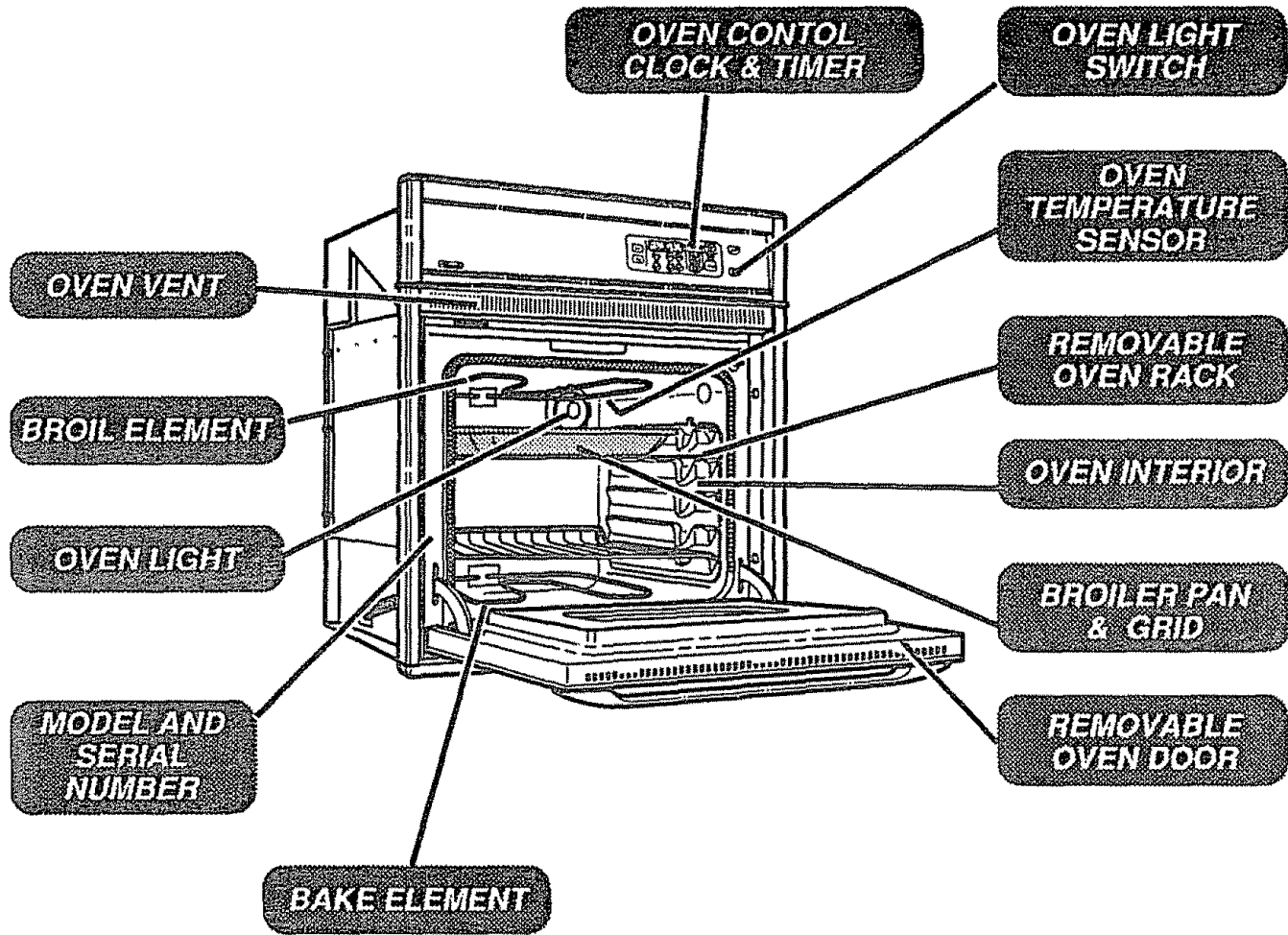

REMOVAL OF PACKAGING TAPE

To remove the adhesive left from packaging tape, use household dishwashing liquid, mineral oil or cooking oil. With a soft cloth, rub into the area and allow to soak. Rinse and dry well. Repeat procedure using an appliance polish to insure no damage is done to the range surface. **This should be done before the oven is turned on for the first time. The tape cannot be removed once the oven has heated.**

Where can you look for packaging tape?

- Door handle
- Control panel area
- Door trim
- Oven area

Your New Oven Control, Clock and Kitchen Timer

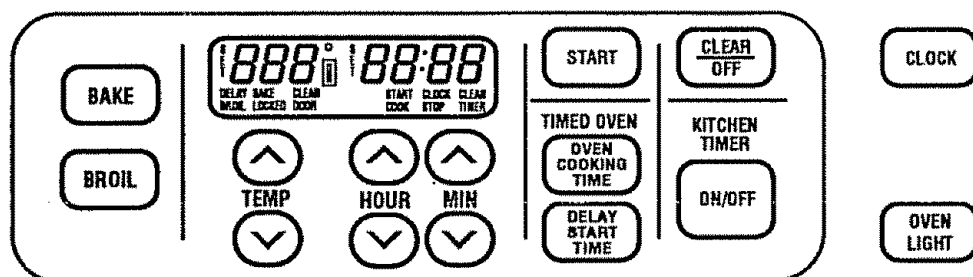

Your new touch pad control will allow you to set oven functions with ease. Below are the different types of functions and a description of each.

TRADITIONAL OVEN FUNCTIONS

BAKE — Cook foods in the traditional oven with a temperature range of 170°F to 550°F.



BROIL — Cooks meat at 550°F hi broil or 450°F low broil from the direct heat of the upper element. Broiling should be done with the door opened to the broil stop position.



TIMED OVEN FUNCTIONS

TIME BAKE — This function allows you to choose Bake, set the amount of time you prefer foods to cook, then have the oven turn off automatically.

DELAYED BAKE — This function allows you to choose Bake, set the time of day you prefer the oven to turn on, cook for a set amount of time, then have the oven turn off automatically.

TOUCH PADS



 The **HOUR** and **MIN** pads set the time of day, length of cooking time, the delayed start time and the time set on the Kitchen Timer.







 The **TEMP** pad sets the temperature used for cooking.

TEMP



 The **START** pad must be pressed to activate any oven function.

 The **OVEN COOKING TIME** pad is used when setting the length of cooking time.



 The **DELAY START TIME** pad is used to set the time of day you prefer the oven to turn on and start cooking.

 The **CLEAR/OFF** pad is used to cancel any oven function and the end of cycle tone. **It will not cancel the Clock or Kitchen Timer.**

 The **ON/OFF** pad is used to turn the Kitchen Timer on or off.

OVEN CONTROL, CLOCK and KITCHEN TIMER *continued*

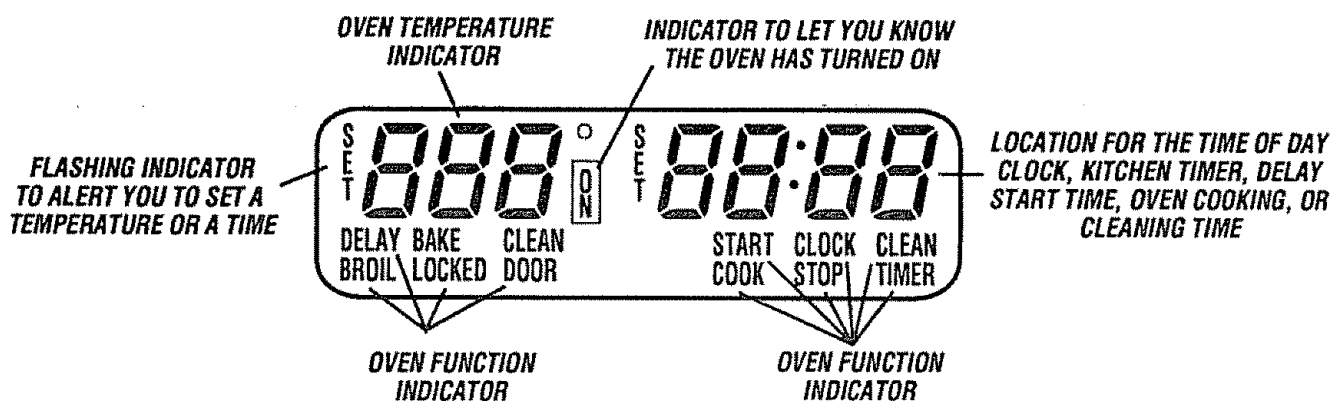
CONTROL DISPLAY



The display is an easy reference to use while using your control. Below are descriptions of how the display works.

OVEN TEMPERATURE INDICATOR — This indicator has a multiple purpose.

- **Displays the temperature**
- **Displays an error code** — “ERR” - If the oven temperature indicator flashes “ERR”, then you have set an invalid time or temperature. Press the **CLEAR/OFF** pad to clear the control and reset your oven function.
- **Displays Oven Problems** — If your control flashes “F” and a number or letter, you have experienced an oven problem. Please read the section on **F-CODES** in your manual.

ON INDICATOR — Will light when the oven turns on.

SET INDICATORS — The set indicator will flash in combination with an oven function or timed function to let you know you need to set a time or temperature. Example: “**SET BAKE**” will flash to let you know you need to set the bake temperature.

TIME INDICATOR — Displays the time of day, cooking time, delayed start time or the time set on the kitchen timer.

Displays a reminder code — “**PUSH START**” - If the time indicator flashes the words “**PUSH START**”, then you need to press the **START** pad to activate your setting.

OVEN FUNCTION INDICATORS — Displays which oven function has been set and if the function is delayed.

OVEN CONTROL, CLOCK and KITCHEN TIMER *continued*

CLOCK

The clock must be set for the correct time of day before a delayed oven function can work properly. The time of day cannot be changed during a timed oven function, but can be changed during a bake or broil function.

HOW TO SET THE CLOCK

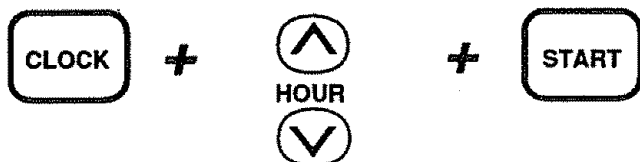

1. Press the **CLOCK** pad.
2. Press the **UP** and/or **DOWN** arrow pads to set the time.
3. Press the **START** pad.

RECALL THE CLOCK

While using your oven for cooking, press the **CLOCK** pad, if you wish to check the time of day. The current time of day will show in the display.

POWER FAILURE

If you have experienced a power failure, the time flashing in the display will be incorrect. Reset your Clock.

Any oven cooking function that was in process will need to be reset.

KITCHEN TIMER

The Kitchen Timer is used to time cooking processes or other household activities. It does not control the oven. It can be set for up to 9 hours and 59 minutes. It will countdown in minutes until the last 60 seconds is reached then the control will beep once. When the countdown reaches zero, the control will beep 3 times followed by one beep every 6 seconds until the **KITCHEN TIMER ON/OFF** pad is pressed. This 6 second tone can be canceled. See tones on the following page.

HOW TO SET THE TIMER



1. Press the **KITCHEN TIMER ON/OFF** pad.
2. Press the **HOUR** and **MIN UP** and/or **DOWN** arrow pads to set time.
3. Press the **START** pad.
4. When the countdown has reached zero, press the **KITCHEN TIMER ON/OFF** pad.

To cancel the timer during the countdown press the **TIMER ON/OFF** pad twice.

OVEN CONTROL, CLOCK and KITCHEN TIMER *continued*

TONES

Your new control has a series of tones that will sound at different times. These tones may sound while you set the control for an oven function, or at the end of the oven function. It will also alert you there may be a problem with the functions. Below are the types of tones and a brief description of each.

TONES WHILE SETTING THE CONTROL

When you press a touch pad you will hear a beep. This beep will let you know you have placed enough pressure on the pad to activate it. (The arrow pads do not beep.)

END OF TIMED CYCLE TONE

At the end of a timed cooking function, you will hear 3 short beeps followed by 1 beep every 6 seconds. This 6 second beep will continue to sound until the **CLEAR/OFF** pad is pressed or you may select the special feature to cancel this 6 second beep from sounding at the end of future cycles.

TO CANCEL THE 6 SECOND BEEP

1. Press and hold the **BAKE** and **BROIL** pads, **at the same time** for 3 seconds, until the display shows **"SF"**.
2. Press the **KITCHEN TIMER ON/OFF** pad. The display will show **"CON BEEP"** (continuous beep).
3. Press the **KITCHEN TIMER ON/OFF** pad again. The display will show **"BEEP"** (beep canceled).
4. Press the **START** pad.

If you would like to return the 6 second beep repeat steps above until the display shows your choice and press start.

ATTENTION TONE

This tone will sound if you make an error or an oversight is made while setting an oven function.

Examples would be:

- a. Setting a function and not pressing the **START** pad.
- b. Pressing an additional function pad without setting a temperature or time first.

Any of these can be quickly identified by watching the display

PREHEAT TONE

When you set an oven temperature, the oven automatically starts to heat. When the temperature inside the oven reaches the temperature you have set, a tone will sound to let you know the oven is ready for baking

F CODE

If you set an oven function and the control beeps while the display is flashing **"F"** and a number **"F-4"** or letter **"FI"** there may be a problem with the control or oven. Simply press the **CLEAR/OFF** pad and wait about an hour. Try setting the function again. If the code repeats, write down the flashing code and call for service. Tell the technician what the code was flashing.

OVEN COOKING TIPS

STRONG SMELL OR ODOR

It is normal to have some odor when using your oven for the first time. This is caused by the heating of new parts and insulation.

To help eliminate this odor, **ventilate the room by opening a window or using a vent hood.**

ALUMINUM FOIL

IMPORTANT:

Never cover the oven bottom or oven rack with aluminum foil. Improper use can cause poor heat flow, poor baking results, and may damage the oven finish.

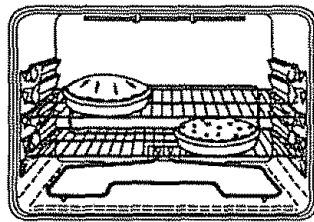

OVEN VENT

The oven vent is located above the oven door. This area could become hot during oven use. The vent is important for proper air circulation. **Never block this vent.**

PREHEATING

Let the oven preheat thoroughly when recipes call for preheating. Preheating is bringing the temperature up to the temperature you will be using during baking. When the oven has reached the preheat temperature, a tone will sound. Have foods nearby ready to place in the oven.

OVEN TEMPERATURE SENSOR

In the back of the oven you will notice a small tube. This is a heat sensor that maintains the temperature of the oven. Never move or bend this tube.

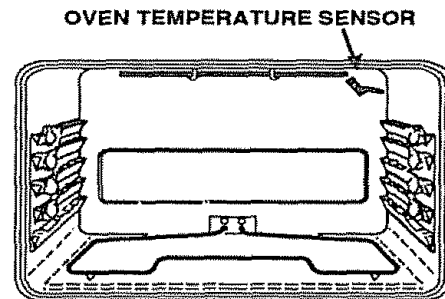

NO PEEKING

Opening the door often to check foods will cause heat loss and poor baking results.

OVEN COOKING TIPS *continued*

FAN RUNNING

During any oven operation you may hear a fan noise. This is the internal cooling fan that keeps all electrical parts from overheating. It is not uncommon for this fan to keep running even after the oven is turned off.

BAKEWARE

FLAT COOKIE SHEETS

(without sides)

Flat cookie sheets allow air to circulate all around the cookies for even browning.

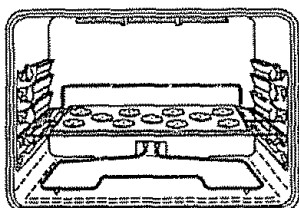

SHINY PANS

(reflect heat)

Shiny pans are perfect for cakes and quick breads that have a golden brown crust.

GLASS, DARK NON-STICK, OR DARKENED BY AGE BAKEWARE

(absorb heat)

Perfect for yeast breads, pie crust or foods that have a brown crust. The oven temperature should be reduced by 25°F.

LOW TEMPERATURE ZONE

The low temperature zone of your oven (between 170° and 200°F) is available to keep hot cooked foods warm. However, foods kept at these temperatures longer than 2 hours may spoil.

MOISTURE

As the oven heats, the change in temperature inside the oven causes water droplets to form on the oven door glass. To prevent this, open the door momentarily to allow the moist air out.

BAKEWARE PLACEMENT

If baking with more than one pan, place the pans so each has at least 1 to 1 1/2" of air space around it. Place pans so one is not directly above the other.

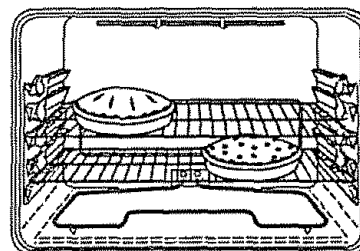

ELEMENT CYCLING

The Oven Temperature Sensor at the back of the oven continuously senses and controls the temperature inside the oven. To keep a constant set temperature, the elements will cycle or turn on and off during cooking.

USING DELAY STARTS

When using your convenient Delay Start operation, foods such as dairy products, fish, poultry, etc., should never sit more than 1 hour before cooking. Room temperatures and the heat from the oven light promote bacterial growth.

OVEN COOKING TIPS *continued*

OVEN RACKS

The oven racks are designed with stop locks, a convenience as well as a safety precaution for placing foods in or removing foods from the oven. When the racks are placed correctly in the oven, the guides have a bump to prevent the racks from tilting. Your oven has four (4) rack positions that may be used during cooking.

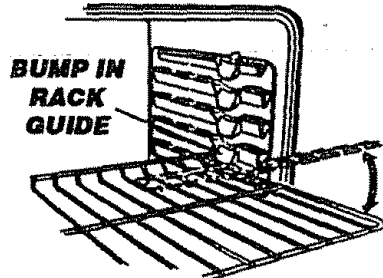

OVEN TEMPERATURE ADJUSTMENT

You may feel that your new oven cooks differently than the oven it replaced. We recommend that you use your new oven a few weeks to become more familiar with it, following the times given in your recipes as a guide. See Do It Yourself Adjustment in back of this manual to make the adjustment if you feel your oven is too hot or too cool for your cooking preference.

The top position is only a guide. It cannot be used as a rack position.

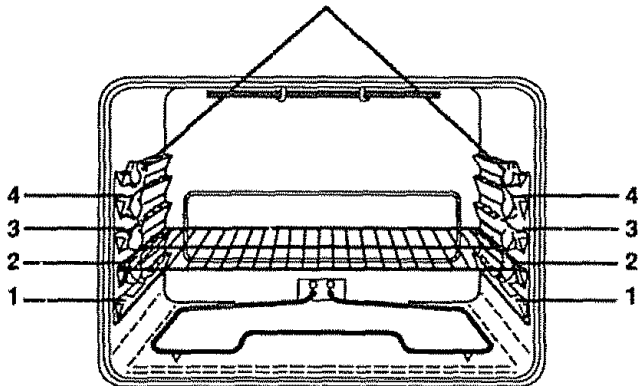

Always place oven racks in the proper position while oven is cool.

BAKING

HOW TO SET BAKE



1. Press the **BAKE** pad.



TEMP



2. Press the Temp **UP** and **DOWN** arrow pads to set the oven temperature you prefer to use.



3. Press the **START** pad.

HOW TO SET TIME BAKE

To set the oven to cook for a specific time and turn off automatically.



1. Press the **BAKE** pad.



TEMP



2. Press the Temp **UP** and/or **DOWN** arrow pad to set the oven temperature you prefer to use.



3. Press the **OVEN COOKING TIME** pad.

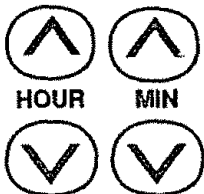

HOUR

MIN

4. Press the Hour and/or Minute **UP** and **DOWN** arrow pads to set the amount of time you prefer your foods to cook.



5. Press the **START** pad.

HOW TO SET DELAY BAKE

To set the oven to delay the start, cook for a specific time and turn off automatically.



1. Press the **BAKE** pad.



TEMP



2. Press the Temp **UP** or **DOWN** arrow pads to set the oven temperature you prefer to use.



3. Press the **OVEN COOKING TIME** pad.

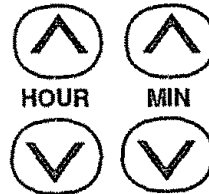

HOUR

MIN

4. Press the Hour and/or Minute **UP** and **DOWN** arrow pads to set the amount of time you prefer your foods to cook.



5. Press the **DELAY START TIME** pad.

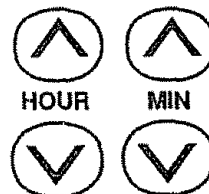

HOUR

MIN

6. Press the Hour and/or Minute **UP** and **DOWN** arrow pads to set the time of day you prefer the oven to turn on.



7. Press the **START** pad.

These oven operations may be used when roasting.

The oven will cut off at the end of the cooking time unless the cook and hold feature has been activated.

BROILING

GENERAL RULES

Broiling is cooking by direct heat from the upper element. The oven door should remain opened to the broil stop lock position during broiling.

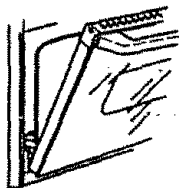

It is not necessary to preheat the oven when broiling. Use the broiler pan and grid that came with your range. Both are designed for proper drainage of fat and liquids.



Foil must be molded tightly to the grid and slits cut into the foil to match those of the grid. This allows fats and liquids to drain into the broiler pan, preventing

fire and excessive smoke. Always remove the pan and grid from the oven. Storing or forgetting a soiled broiler pan in the oven is a potential smoke or fire hazard.



PREPARING MEATS FOR BROILING

- Choose tender cuts of meat at least 3/4" thick for broiling.
- Trim the outer layer of fat, slit the edges to keep meats from curling.
- Always use tongs to turn meats. Piercing meat allows juices to escape.
- Salt the first side of meats just before turning, the second side just before serving. Brush chicken and fish with butter several times as they broil.
- Chicken and fish should be placed on the grid skin side down. For fish, lightly grease the grid to prevent sticking.

The closer you place foods to the broil element, the faster foods brown on the outside yet remain red to pink in the center.

The U.S. Department of Agriculture notes that meat cooked rare is popular, but meat cooked to only 140°F (rare) means that some poisoning organisms may survive.

Moving meats away from the element will allow the meat to cook to the center while browning on the outside. Using this positioning, cook side 1 at least 2 minutes longer than side 2. If your oven is connected to 208 volts, you may want to use a higher rack position and/or broil foods longer.

The size, weight, thickness, starting temperature and your preference of the doneness of the meat will affect broiling. This chart is based on meats at refrigerator temperature.

FOOD	RACK POSITION	TOTAL TIME (MIN.)
Steak 1" thick	3	21-23
Ground beef patties 1" thick	3	16-18
Pork Chops- 1/2" thick	3	27-29
Fish (fillets)	3	11-13
Chicken (pieces)	2	45-55

HOW TO SET BROIL

BROIL

1a. Press the **BROIL** pad. **(This will automatically set HI Broil)**

START

1b. While the indicator is flashing in the display, press the **BROIL** pad again if you prefer to use LO Broil.

CLEAR OFF

2. Press the **START** pad.
3. When broiling is finished, press the **CLEAR/OFF** pad.

SETTING SPECIAL FEATURES OF YOUR CONTROL

Your new touch pad control has additional features that you may choose to use. After making your selection, if you want to change the setting, follow the steps until the display shows your choice.

12 HOUR BAKING AND 3 HOUR BROILING SHUT-OFF

The control is automatically set to turn off the oven after 12 hours baking or 3 hours broiling should you forget and leave the oven on. If you want to remove this feature:

1. Press and hold, **at the same time**, the **BAKE** and **BROIL** pads for 3 seconds, until the display shows **SF**.
2. Press the **DELAY START TIME** pad. The display shows **12shdn** (12 hour shut-off).
Press the **DELAY START TIME** pad again. The display will show **no shdn** (no shut-off).
3. Press the **START** pad.

FAHRENHEIT OR CENTIGRADE TEMPERATURE SELECTION

Your oven control is set for the Fahrenheit temperature selection. Most recipes are given using the Fahrenheit scale. You can change this to use the Centigrade selection.

1. Press and hold, **at the same time**, the **BAKE** and **BROIL** pads for 3 seconds, until the display shows **SF**.
2. (a) Press the **BROIL** pad. The control display will show the degrees sign and **F**.
(b) Press the **BROIL** pad again. This will change **F** (Fahrenheit) to **C** (Centigrade).
3. Press the **START** pad.

12 HOUR, 24 HOUR MILITARY TIME CLOCK OR CLOCK BLACK OUT

Your control is set to use the 12 hour clock. If you prefer to use the 24 hour Military Time clock or black out the display:

1. Press and hold, **at the same time**, the **BAKE** and **BROIL** pads for 3 seconds, until the display shows **SF**.
2. (a) Press the **CLOCK** pad. The display shows **12hr**. If this is your choice press the **START** pad.
or
(b) Press the **CLOCK** pad again. The display will show **24hr**. Example: 5:00 on the 12 hour clock will show 17:00 hours on the military clock. If this is your choice press the **START** pad.
or
(c) Press the **CLOCK** pad again. The display will show **OFF**. If this is your choice press **START**. The display will not show time. **(The Delay Start Time feature will not operate.)**

SETTING SPECIAL FEATURES *continued*

COOK AND HOLD

Your new control has a cook and hold feature for timed cooking only that will keep hot cooked foods warm up to 3 hours after the timed cooking is finished. To activate this feature:

1. Press and hold, **at the same time**, the **BAKE** and **BROIL** pads for 3 seconds, until the display shows **SF**.
2. (a) Press the **OVEN COOKING TIME** pad. The display will show **HLd OFF**.
(b) Press the **OVEN COOKING TIME** pad **again** to activate the feature. The display will show **HLd ON**.
3. Press the **START** pad.

CHANGING THE SPEED OF THE UP OR DOWN ARROW PADS

This special feature will allow you to change the speed; #1 means speed of change is slow up to #5 which means speed of change is fast. To set the speed you prefer, follow these steps:

1. Press and hold, **at the same time**, the **BAKE** and **BROIL** pads for 3 seconds, until the display shows **SF**.
2. Press the **UP** arrow pad. The display will show the current set speed.
3. Press the **UP** arrow to increase the speed up to the number 5.
or
Press the **DOWN** arrow pad to decrease the speed down to the number 1.
4. Press the **START** pad.

CLEANING

CONTROL PANEL

CLEANING MATERIALS TO USE:

- Dishwashing detergent
- Warm water
- Soft cloth

Do not use abrasive cleaners, industrial cleaners, or bleach.

BROILER PAN AND GRID

CLEANING MATERIALS TO USE:

- Dishwashing detergent
- Warm water
- Soap-filled steel wool pad
- Commercial oven cleaner

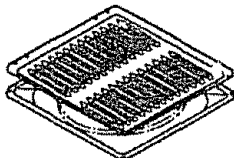

TO CLEAN:

Allow the pan to soak. Sprinkle the grid with dishwashing detergent and cover with a damp cloth or paper towel and let stand. Scour as needed. Wash, rinse, and dry well. You may also place both the pan and grid in the dishwasher.

OVEN RACKS

CLEANING MATERIALS TO USE:

- Dishwashing detergent
- Soap-filled steel wool pad
- Warm water

TO CLEAN:

Wash and rinse well.

TO REMOVE:

Pull the racks out and up to remove.

TO REPLACE:

Set the raised back of the rack on the pair of rack guides. Push until you reach the stop locks, lift the front of the rack until the back slides easily under the bump. Push rack into the oven.

OVEN DOOR

CLEANING MATERIALS TO USE:

- Dishwashing detergent
- Glass cleaner
- Paper towel
- Warm water

TO CLEAN:

Wash and clean the inside surface of the door well. Clean the outside glass with glass cleaner.

Do not attempt to clean the oven unless it is completely cool.

OVEN INTERIOR

CLEANING MATERIALS TO USE:

- Oven cleaner

TO CLEAN

Clean up after each oven use. Rinse thoroughly. Do not coat bake or broil element with oven cleaner. When using oven cleaner read directions on container carefully.

GLASS

CLEANING MATERIALS TO USE:

- Glass cleaner
- Paper towels
- Baking soda

TO CLEAN:

For everyday cleaning, use glass cleaner and a paper towel. For stubborn soil, use paste of baking soda and water. Rinse thoroughly.

REMOVABLE PARTS

REPLACING THE OVEN LIGHT BULB

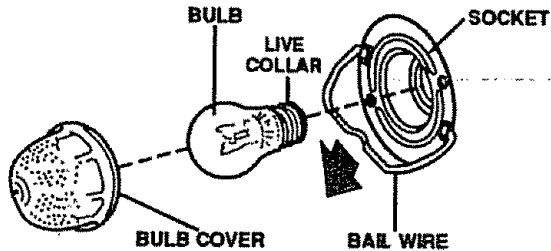

TO REMOVE THE COVER:

1. Disconnect electrical power to the oven at the main circuit breaker or fuse box.
2. Hold your hand under cover and firmly push back the bail wire, until it clears and releases the bulb cover.

REPLACE THE LIGHT BULB:

Unscrew the light bulb and replace it with a 40-watt home appliance bulb.

TO REPLACE COVER:

1. Place the bulb cover into the groove of the bulb socket.
2. Pull the bail wire forward until it snaps into the indentation on top of the bulb cover.
3. Reconnect the electrical power to the oven.



Do not touch a hot oven light bulb. Do not touch a bulb with wet hands or wet cloth. Never touch the electrically live collar on the bulb when removing or replacing the bulb. Do not remove any screws.

OVEN DOOR

TO REMOVE:

Open the door to the broil stop position. Grasp the door on each side and lift up and off the hinges. **DO NOT LIFT THE DOOR BY THE HANDLE.**

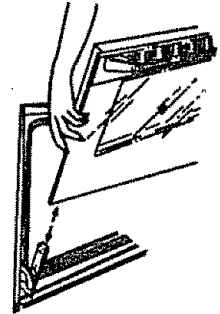

When the door is removed and the hinge arms are in the broil stop position, do not bump into the hinge arms. They could snap back and cause injury to hands and damage the porcelain finish of the front frame. Cover the hinge arms with empty paper towel rolls or towels while working in the oven area.

TO REPLACE:

Remove the paper towel rolls or towels. Make sure the hinges are still in the broil stop position. Grasp the door on each side. Lift the door over each hinge. Line the slots at the bottom of the door with the hinges. Slide the door down over the hinges as far as it will go.

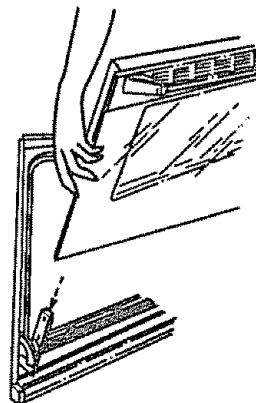

BEFORE CALLING FOR SERVICE

To save you time and money, before making a service call, check the list below for any problem you may feel you have with the performance of your range. If the problem is something you cannot repair, use the Consumer Service Numbers located at the back of this manual. **When making any calls, have the model number, repair parts list, use and care manual and the date of purchase available.**

PROBLEM	POSSIBLE CAUSE	POSSIBLE SOLUTION
The display of your control is flashing "F" followed by a number or letter.	Range malfunction.	Press the CLEAR/OFF pad. Let the range cool for 1 hour and place the range back into an oven operation. If the problem repeats, call for service.
Oven will not work; totally inoperative.	No power to range.	<ul style="list-style-type: none"> a. Check the household circuit breaker or fuse box. b. Check to make sure the range is plugged in.
Foods do not bake properly.	<ul style="list-style-type: none"> a. Oven is not preheated. b. Improper rack or pan placement. c. Oven vent blocked or covered. d. Improper use of foil. e. Improper temperature setting for utensil used. f. Recipe not followed. g. Improper oven control calibration. h. Range and oven rack not level. 	<ul style="list-style-type: none"> a. Be sure to preheat until the tone sounds. b. Maintain uniform air space around pans and utensils. See oven cooking section. c. Keep vent clear. d. Racks should not be covered during baking. e. Reduce temperature 25 degrees for glass or dull/darkened pans. f. Check recipe and measurement. g. Check the temperature adjustment following this section. h. Check the installation instructions for leveling.
Oven temperature seems inaccurate.	Oven control calibration.	See oven cooking section.
Oven light does not work.	<ul style="list-style-type: none"> a. Light switch is in off position. b. Bulb needs to be replaced. 	<ul style="list-style-type: none"> a. Check switch setting. b. Check or replace light bulb.

BEFORE CALLING FOR SERVICE *continued*

PROBLEM	POSSIBLE CAUSE	POSSIBLE SOLUTION
Foods do not Broil properly.	<ul style="list-style-type: none"> a. <i>Improper rack position.</i> b. <i>Oven preheated.</i> c. <i>Improper use of foil.</i> d. <i>Oven door closed during broiling.</i> e. <i>Low voltage (208 volts).</i> f. <i>Improper broiling time.</i> 	<ul style="list-style-type: none"> a. <i>Check broil pan placement; see broiling section.</i> b. <i>Do not preheat when broiling.</i> c. <i>Check broiling section.</i> d. <i>Open door to broil stop position.</i> e. <i>Use higher rack position and/or longer cooking time.</i> f. <i>Check broiling chart in broiling section.</i>
Oven will not unlock.	<i>Clean cycle is not finished.</i>	<i>Oven must drop below the lock temperature before the door will unlock.</i>
Oven smokes.	<ul style="list-style-type: none"> a. <i>Dirty oven.</i> b. <i>Improper use of aluminum foil.</i> c. <i>Broiler pan containing grease left in the oven.</i> 	<ul style="list-style-type: none"> a. <i>Check for heavy spillover.</i> b. <i>Use of foil not recommended.</i> c. <i>Clean pan and grid after each use.</i>
Cannot set 350° Bake	<i>Control set for degrees Centigrade Mode.</i>	<i>See setting special features section.</i>

"DO IT YOURSELF" TEMPERATURE ADJUSTMENT

You may feel that your new oven cooks differently than the oven it replaced. We recommend that you use your new oven a few weeks to become more familiar with it, following the times given in your recipes as a guide.

If you think your new oven is too hot (burning foods) or not hot enough (foods are undercooked) you can adjust the temperature yourself. The appearance and texture of foods is a better indicator of oven accuracy than an inexpensive thermometer, such as those found in grocery stores, to check the temperature setting of your new oven. These thermometers can vary by 20-40 degrees. In addition, the oven door must be opened to read these thermometers. Opening the door will change the temperature of the oven.

To decide how much to change the temperature, set the oven temperature 25 degrees higher (if foods are undercooked) or 25 degrees lower (if foods are burning) than the temperature in your recipe, then bake. The results of this "test" should give you an idea of how much the temperature should be changed.

TO MAKE THE ADJUSTMENT



+

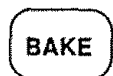

1. Press and hold down both the **BAKE** and **BROIL** pads for 3 seconds, until the display shows **SF**.

2. Press the **BAKE** pad. A factory set 2 digit number will show in the display, usually 00.

If you think the oven is not hot enough;

- 3a. Press the **UP** arrow pad to **increase (+)** the temperature up to **+35°F**.

If you think the oven is too hot;

- 3b. Press the **DOWN** arrow pad to **decrease (-)** the temperature down to **-35°F**.

4. Press the **START** pad.

This increased or decreased temperature setting will remain in memory until the above steps are repeated. A power failure will not affect this setting.

The Broil temperature will not be affected.

For the repair or replacement parts you need
delivered directly to your home

Call 7 am - 7 pm, 7 days a week

1-800-366-PART

(1-800-366-7278)

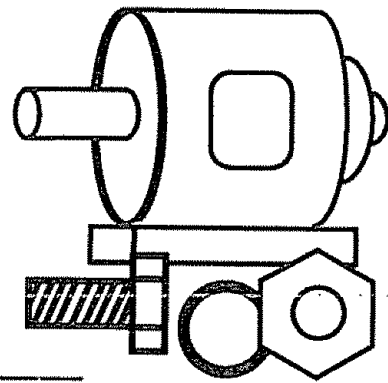

For in-home major brand repair service

Call 24 hours a day, 7 days a week

1-800-4-REPAIR

(1-800-473-7247)

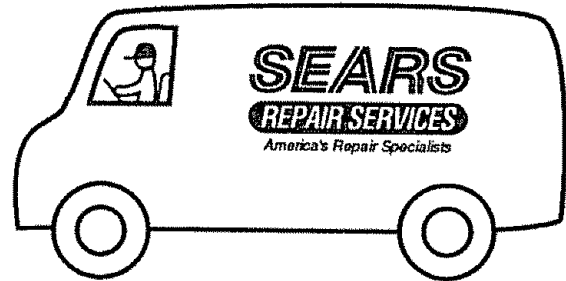

For the location of a
Sears parts and Repair Center in your area

Call 24 hours a day, 7 days a week

1-800-488-1222

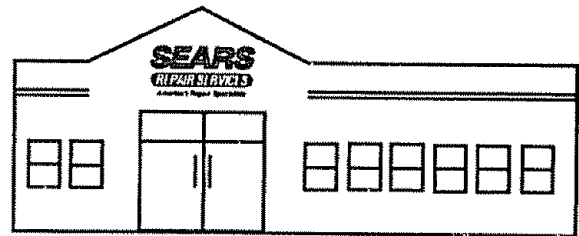

For information on purchasing a Sears
Maintenance Agreement or to inquire
about an existing Agreement

Call 9 am - 5 pm, Monday-Saturday

1-800-827-6655



SEARS
REPAIR SERVICES

America's Repair Specialists

KENMORE ELECTRIC RANGE WARRANTY

Dear Customer:

Our constant efforts are directed toward making sure your new Kenmore Range will arrive at your home in perfect condition and will give you proper performance. As part of these efforts, we feel it is our responsibility to provide you with this warranty for your range.



FULL ONE YEAR WARRANTY ON THE FUNCTIONING OF ALL PARTS EXCEPT GLASS PARTS

If, within one year from the date of installation, any part, other than a glass part, fails to function properly due to a defect in material or workmanship, Sears will repair or replace it, free of charge.

FULL 30-DAY WARRANTY ON GLASS PARTS AND FINISH OF PORCELAIN ENAMEL, PAINTED OR BRIGHT METAL FINISHED PARTS

If, within 30 days from the date of installation, any glass part or the finish on any porcelain enamel, painted or bright metal part is defective in material or workmanship, Sears will replace the part, free of charge.

FULL 90-DAY WARRANTY ON MECHANICAL ADJUSTMENTS

For 90 days from the date of installation, Sears will provide, free of charge, any mechanical adjustments necessary for proper operation of the range, except for normal maintenance.

If the range is subjected to other than private family use, the above warranty coverage is effective for only 90 days.

WARRANTY SERVICE IS AVAILABLE BY CONTACTING THE NEAREST SEARS SERVICE CENTER/DEPARTMENT IN THE UNITED STATES

This warranty applies only while this product is in use in the United States. This warranty gives you specific legal rights, and you may also have other rights which vary from state to state.

SEARS, ROEBUCK and CO.
Dept. 817 WA
Hoffman Estates, IL 60179

WE SERVICE WHAT WE SELL

"We Service What We Sell" is our assurance to you that you can depend on Sears for service because Sears service is nationwide.

Your Kenmore Range has added value when you consider that Sears has a service unit near you staffed by Sears trained technicians... professional technicians specifically trained on Sears appliances, having the parts, tools and equipment to ensure that we meet our pledge to you — "We Service What We Sell!"

TO FURTHER ADD TO THE VALUE OF YOUR RANGE, BUY A SEARS MAINTENANCE AGREEMENT.

Kenmore Ranges are designed, manufactured and tested for years of dependable operation. Yet, any modern appliance may require service from time to time. The Sears Warranty plus the Sears Maintenance Agreement provides protection from unexpected repair bills and assures you of enjoying maximum range efficiency.

Here's a comparative warranty and Maintenance Agreement chart showing you the benefits of a Sears Range Maintenance Agreement.

Years of Ownership Coverage		1st Year	2nd Year	3rd Year
1	Replacement of Defective Parts other than Porcelain or Glass	W	MA	MA
2	Mechanical Adjustment	90 DAYS W	MA	MA
3	Porcelain and Glass Parts	30 DAYS W	MA	MA
4	Annual Preventive Maintenance Check at your request	MA	MA	MA

W - Warranty MA - Maintenance Agreement

CONTACT YOUR SEARS SALESPERSON OR LOCAL SEARS SERVICE CENTER TODAY AND PURCHASE A SEARS MAINTENANCE AGREEMENT.

Kenmore®

Sold by SEARS, ROEBUCK AND CO., Hoffman Estates, IL 60179

— Printed in the United States —