

19" LCD TV

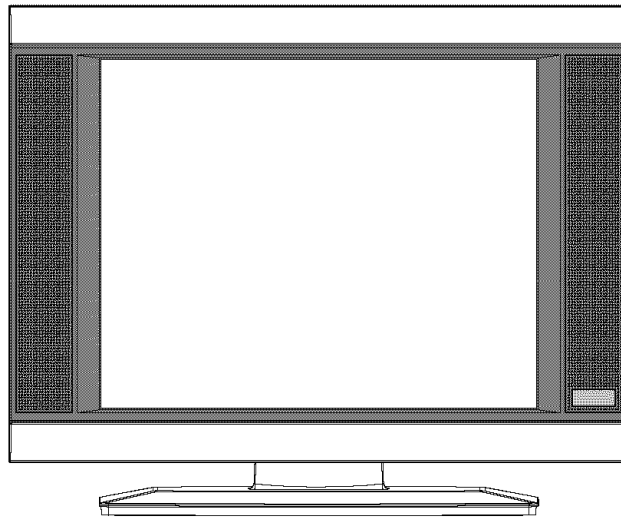

OWNER'S MANUAL



MODEL: PLV16198
SIZE: 148 x 210mm
P/N: 811-P16191W010 (ENGLISH)
11-DEC-2006

SAFETY PRECAUTIONS



* SEE REAR OF UNIT FOR GRAPHIC SYMBOLS *

WARNING: TO REDUCE THE RISK OF ELECTRIC SHOCK, DO NOT REMOVE COVER (OR BACK). NO USER-SERVICEABLE PARTS INSIDE. REFER SERVICING TO QUALIFIED PERSONNEL.

WARNING: TO PREVENT FIRE OR SHOCK HAZARD, DO NOT EXPOSE THIS UNIT TO RAIN OR MOISTURE. DO NOT PLACE OBJECTS FILLED WITH LIQUIDS ON OR NEAR THIS UNIT.



The lightning flash with an arrowhead within a triangle alerts you to uninsulated dangerous voltage within the product's enclosure that could cause an electric shock.



The exclamation point within a triangle alerts you to the presence of important operating, maintenance and servicing instructions in this user's manual.

CAUTION: DANGER OF EXPLOSION IF BATTERY IS INCORRECTLY REPLACED. REPLACE ONLY WITH THE SAME OR EQUIVALENT TYPE.



The symbol for Class II (Double Insulation)

PLACEMENT INFORMATION

- Do not use this unit in places which are extremely hot, cold, dusty, or humid.
- Do not restrict the air flow of this unit by placing it somewhere with poor air flow, by covering it with a cloth, or by placing it on bedding or carpeting.

SAFETY INFORMATION

- When connecting or disconnecting the AC cord, grip the plug and not the cord itself. Pulling the cord may damage it and create a hazard.
- When you are not going to use the unit for a long period of time, disconnect the AC cord.

CONDENSATION INFORMATION

- When left in a heated room where it is warm and damp, water droplets or condensation may form inside the unit. When there is condensation inside the unit, the unit may not function normally. Let the unit stand for 1-2 hours before turning the power on, or gradually heat the room and let the unit dry before use.

FCC INFORMATION

WARNING: Changes or modifications to this unit not expressly approved by the party responsible for compliance could void the user authority to operate the equipment.

NOTE: This equipment has been tested and found to comply with the limits for a Class B digital device, pursuant to part 15 of the FCC Rules. These limits are designed to provide reasonable protection against harmful interference in a residential installation. This equipment generates, used in accordance with the instructions, may cause harmful interference to radio communications. However, there is no guarantee that interference will not occur in a particular installation. If this equipment does cause harmful interference to radio or television reception, which can be determined by turning the equipment off and on, the user is encouraged to try to correct the interference by one or more of the following measures:

- Reorient or relocate the receiving antenna.
- Increase the separation between the equipment and receiver.
- Connect the equipment into an outlet on a circuit different from that to which the receiver is connected.
- Consult the dealer or an experienced radio/TV technician for help.

Shielded cables must be used with this unit to ensure compliance with the Class FCC limits.



WARNING: Should any problems occur, disconnect the AC cord and refer servicing to a qualified technician.

IMPORTANT SAFETY INSTRUCTIONS

1. Read these instructions.
2. Keep these instructions.
3. Heed all warnings.
4. Follow all instructions.
5. Do not use this apparatus near water.
6. Clean only with a dry cloth.
7. Do not block any ventilation openings. Install in accordance with the manufacturer's instructions.
8. Do not install near any heat sources such as radiators, heat registers, stoves, or other apparatus (including amplifiers) that produce heat.
9. Do not defeat the safety purpose of the polarized or grounding-type plug. A polarized plug has two blades with one wider than the other. A grounding type plug has two blades and a third grounding prong. The wide blade or the third prong are provided for your safety. If the provided plug does not fit into your outlet, consult an electrician for replacement of the obsolete outlet.
10. Protect the power cord from being walked on or pinched particularly at plug, convenience receptacles, and the point where they exit from the apparatus.
11. Only use attachments/accessories specified by the manufacture.
12. Use only with the cart, stand, tripod, bracket, or table specified by the manufacturer, or sold with the apparatus. When a cart is used, use caution when moving the cart/apparatus combination to avoid injury from tip-over.
13. Unplug this apparatus during lightning storms or when unused for long periods of time.
14. Refer all servicing to qualified service personnel. Servicing is required when the apparatus has been damaged in any way, such as power-supply cord or plug is damaged, liquid has been spilled or objects have fallen into the apparatus, the apparatus has been exposed to rain or moisture, does not operate normally, or has been dropped.



TABLE OF CONTENTS

SAFETY PRECAUTIONS	2
IMPORTANT SAFETY INSTRUCTIONS	3
REMOTE CONTROL	5
ACCESSORIES	5
REMOTE CONTROL REFERENCE GUIDE	6
UNIT REFERENCE GUIDE	7
CONNECTIONS	8 – 14
Connecting a TV antenna/Cable/Satellite	8
Connecting to A/V devices (VCR, Camcorder, Game System, etc.)	9 – 11
Connecting a high-definition (HD) source	12
Connecting an audio amplifier	12
Connecting a PC	13
Connecting the power cord	13
INSTALLATION	14
Removing the base stand	14
Mounting on the wall	14
USING HEADPHONE	15
TV SETUP	16 – 20
Main menu	16
Picture menu	16
Sound menu	17
Setup menu	17
Parental setting	18 – 19
TV setting	20
MTS setting	20
Restore setting	20
TROUBLE SHOOTING GUIDE	21
MAINTENANCE	22

REMOTE CONTROL

USING THE REMOTE CONTROL

- Point the remote control at the REMOTE SENSOR located on the unit.
- When using this unit in very bright light, the infrared REMOTE CONTROL SENSOR may not work properly.
- The recommended effective distance for using the remote control is about 16 feet (5 meters).

TO CHANGE THE REMOTE CONTROL BATTERY

1. Open the battery door.
2. Insert two "AAA" batteries.

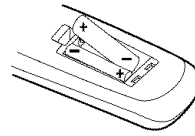
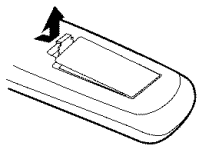

BATTERY REPLACEMENT

When the batteries become weak, the operating distance of the remote control will be greatly reduced and you will need to replace the batteries.

Note:

- If the Remote Control is not going to be used for a long time, remove the batteries to avoid damage caused by battery leakage corrosion.
- Do not mix old and new batteries. Do not mix ALKALINE, standard (CARBON-ZINC) or rechargeable (NICKEL-CADMIUM) batteries.



WARNING: Do not dispose of batteries in a fire or they may leak and/or explode.

ACCESSORIES

PLEASE LOCATE THE INCLUDED ACCESSORIES.

- To order replacement, visit <http://www.1800customersupport.com>.

Remote control (with battery) x 1

Specifications and appearance are subject to change without notice.

Need More Help?
DO NOT RETURN THIS TO THE STORE
Please visit online help at <http://www.1800customersupport.com>

REMOTE CONTROL REFERENCE GUIDE

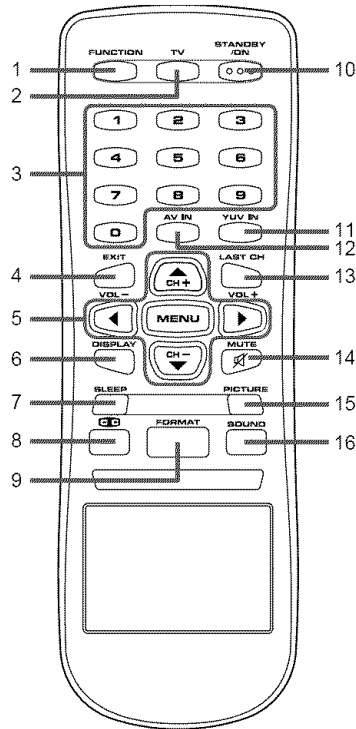

- 1) **FUNCTION button**
Toggle between AV/YUV/PC/TV.
- 2) **TV button**
Press to select TV channel mode.
- 3) **Number (0 - 9) buttons**
Use to change the TV channels.
- 4) **EXIT button**
Press to exit the menu and return directly to normal viewing.
- 5) **Cursor (▼, ▲, ◀, ▶) buttons**
Press to highlight selections on a menu screen and make adjust certain settings.
MENU button
Press to display the on-screen menu.
+ CH - button
Move CH+ or CH- through the TV channels.
+ VOLUME - button
Press to adjust the volume level.
- 6) **DISPLAY button**
Press to show which input you are watching (TV Channel/AV/YUV/PC).
- 7) **SLEEP button**
Sets the SLEEP timer. The unit will remain ON for the time that is set, and will automatically shut off afterwards.
- 8) **CC button**
Press to activate the Closed Captioning feature. This function only works on programs broadcasted with captions.
- 9) **FORMAT button**
Press to select the picture format.
- 10) **STANDBY/ON button**
Press to turn ON the unit or put it in STANDBY (OFF) mode.
- 11) **YUV IN button**
Directly select YUV IN (component video) mode.
- 12) **AV IN button**
Directly selects AV IN mode.
- 13) **LAST CH button**
Press to switch repeatedly between the last two channels displayed.
- 14) **MUTE button**
Press to turn off the sound.
- 15) **PICTURE button**
Select from preset screen display settings to match the type of show you are watching (Standard, Personal, Movie, Dynamic, & Soft).
- 16) **SOUND button**
Select from preset sound settings (Personal, Voice, Music, Theater) to match the type of show you are watching.

UNIT REFERENCE GUIDE

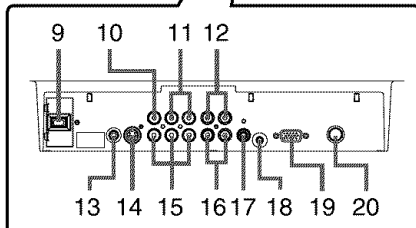
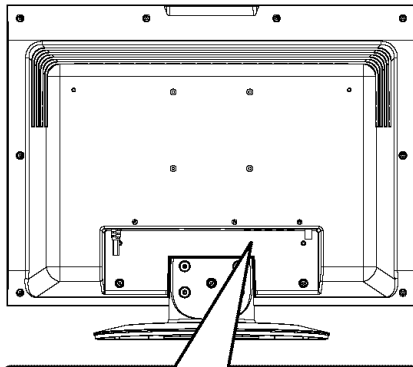
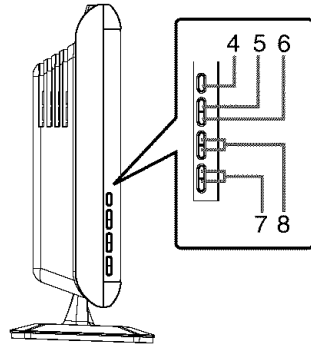
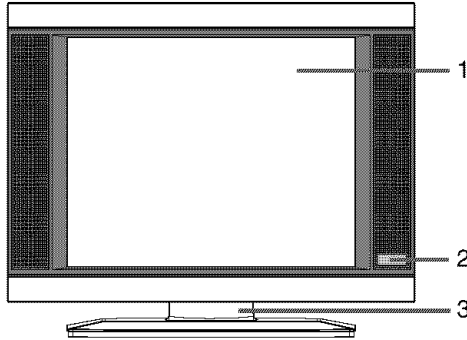

- 1) **Color LCD Screen**
- 2) **STANDBY indicator**
Indicates whether the unit is ON or in STANDBY (OFF) mode.
Light On: The unit is in STANDBY.
Light Off: The unit is turned ON.
Remote Control Sensor
Do not block this sensor or remote control will not work.
- 3) **Removeable Stand**
- 4) **STANDBY/ON button**
Turns the unit on and off.
- 5) **MENU button**
Enter the Setup menu.
- 6) **FUNCTION button**
Select AV, YUV, PC or TV.
- 7) **- VOL + controls**
Adjust the volume level and highlight selections (Left & Right) on the menu screen.
- 8) **▼/▲ buttons**
Select a TV channel and highlight selections (Up & Down) on the menu screen.
- 9) **Power Cord**
- 10) **AV IN Video Input Jack**
- 11) **AV IN Audio Input Jacks (Left/Right)**
- 12) **AV OUT Audio Output Jacks (Left/Right)**
- 13) **Headphone jack**
- 14) **AV IN S-Video Input**
- 15) **YUV IN Component Video Inputs (Y/PB/PR)**
- 16) **YUV IN Audio Input Jacks (Left/Right)**
- 17) **AV OUT Video output Jack**
- 18) **PC IN Audio Jack**
- 19) **PC IN MONITOR/VGA jack**
- 20) **TV Antenna Cable terminal - Coaxial TV antenna input**

CONNECTIONS

CONNECTING A TV ANTENNA/CABLE/SATELLITE

To view television channels correctly, a signal must be received from one of the following sources:

- An indoor or outdoor aerial antenna
- A cable system
- A satellite system

Note:

For receiving over-the-air TV broadcasts, we recommend that you use an external fixed antenna. Should you require the use of a temporary antenna, please ensure that you purchase an antenna with sufficient ability to receive in weak signal areas. Only when you are in close proximity to a transmitter will a temporary antenna reproduce a signal as strongly as a fixed antenna.

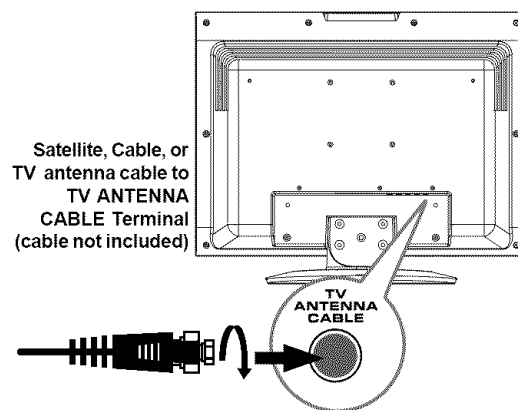

CONNECTIONS

CONNECTING TO A/V DEVICES (VCR, Camcorder, Game System, etc.)

Connecting to Devices with an S-Video Output

To connect to A/V devices such as a VCR or camcorder:

- Connect to a VCR

Connect the right (red) and left (white) audio output from the VCR to the right (red) and left (white) input on this unit (Audio cable not included).

Connect the S-VIDEO output from the VCR to the S-VIDEO input on this unit (S-VIDEO cable not included).

Make sure you connect both audio and video from the same VCR to the same input (AV IN).

Note:

Please refer to the user manual for the VCR for more information.

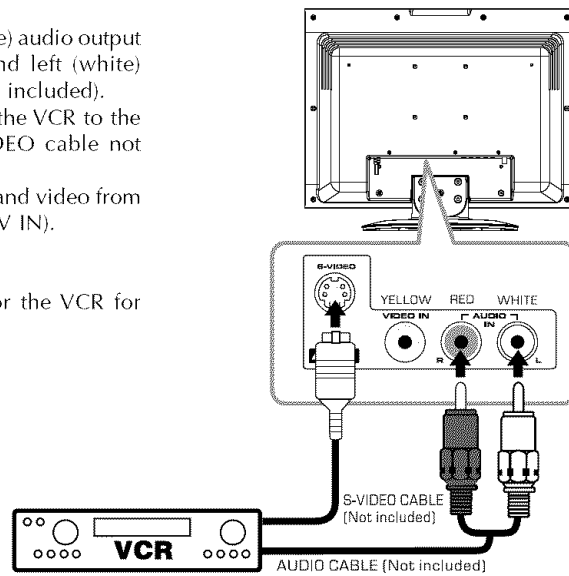

- Connect to a camcorder

Connect the right (red) and left (white) audio output from the camcorder to the right (red) and left (white) input on this unit (Audio cable not included).

Connect the S-VIDEO output from the camcorder to the S-VIDEO input on this unit (S-VIDEO cable not included).

Make sure you connect both audio and video from the same camcorder to the same input (AV IN).

Note:

Please refer to the user manual for the camcorder for more information.

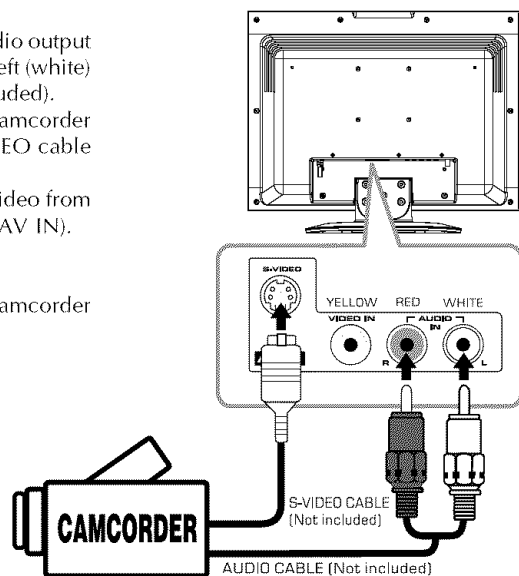

CONNECTIONS

Connecting to Devices with a Composite (yellow RCA-type) Video Output

To connect to A/V devices such as a VCR or camcorder:

- Connect to a VCR

Connect the right (red) and left (white) audio output from the VCR to the right (red) and left (white) input on this unit (Audio cable not included). Connect the video (yellow) output from the VCR to the video input on this unit (Video cable not included).

Make sure you connect both audio and video from the same VCR to the same input (AV IN).

Note:

Please refer to the user manual for the VCR for more information.

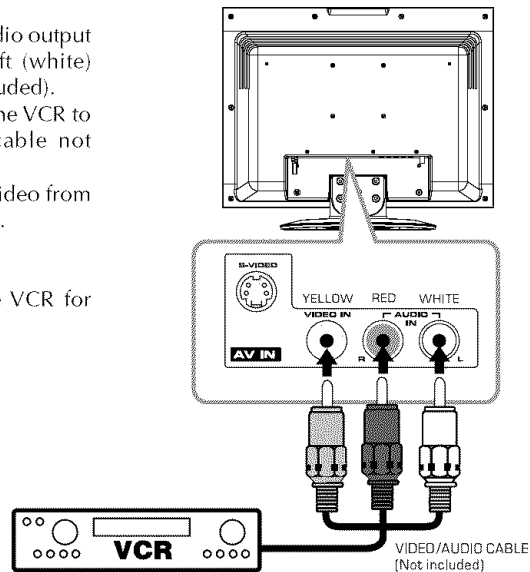

- Connect to a camcorder

Connect the right (red) and left (white) audio output from the camcorder to the right (red) and left (white) input on this unit (Audio cable not included). Connect the video (yellow) output from the camcorder to the video input on this unit (Video cable not included).

Make sure you connect both audio and video from the same camcorder to the same input (AV IN).

Note:

Please refer to the user manual for the camcorder for more information.

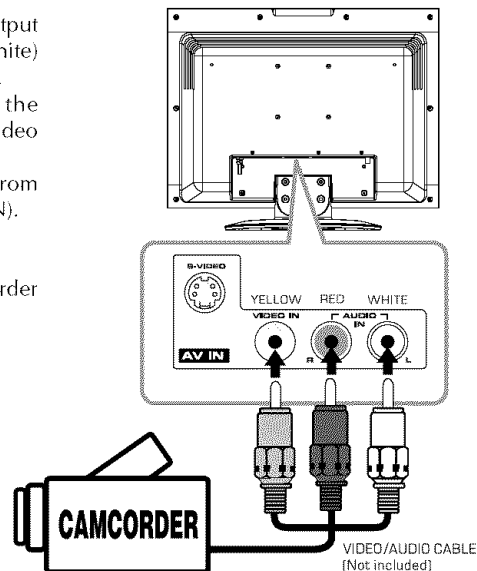

CONNECTIONS

Connecting to Devices with a Composite (yellow RCA-type) Video Input

To connect to AV devices such as a VCR, PVR or camcorder:

- Connect to a VCR/PVR

Connect the right (red) and left (white) audio input from the VCR/PVR to the right (red) and left (white) output on this unit (Audio cable not included). Connect the video (yellow) input from the VCR/PVR to the video output on this unit (Video cable not included).

Make sure you connect both audio and video from the same VCR/PVR to the same output (AV OUT).

Note:

Please refer to the user manual for the VCR/PVR for more information.

Note :

After connection, please operate in TV/AV mode.

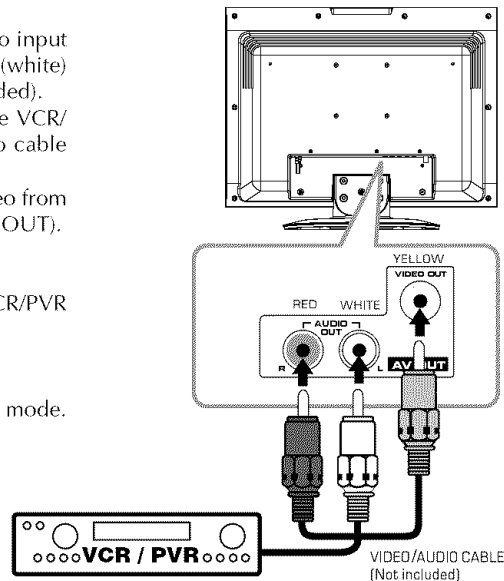

- Connect to a camcorder

Connect the right (red) and left (white) audio input from the camcorder to the right (red) and left (white) output on this unit (Audio cable not included). Connect the video (yellow) input from the camcorder to the video output on this unit (Video cable not included).

Make sure you connect both audio and video from the same camcorder to the same output (AV OUT).

Note:

Please refer to the user manual for the camcorder for more information.

Note :

After connection, please operate in TV/AV mode.

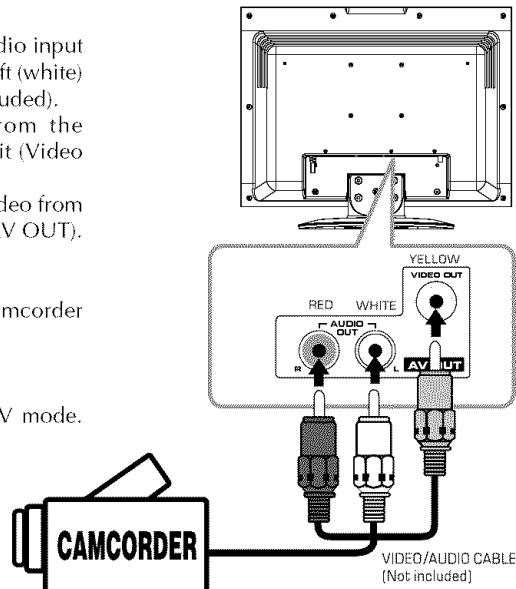

CONNECTIONS

CONNECTING A HIGH-DEFINITION (HD) SOURCE

High-Definition (HD) Devices with component video output must be connected to the YUV input: Connect the three video outputs (Y, Pb, Pr) from the source to the corresponding video inputs on this unit (Component video cable not included).

Connect the right (red) and left (white) audio output from the source to the right (red) and left (white) input on this unit (Audio cable not included).

Make sure you connect both audio and video from the same source to YUV IN.

Note: Please refer to the user manual for your High-Definition (HD) video source for more information and connection details.

Note : When connecting a DVD player to the television, the picture resolution is solely dependent upon the resolution supported by the DVD player attached. DVD Player resolutions vary from 480i to 1080i, and this television can support DVD players up to a maximum resolution of 1080i.

* May require a subscription for receiving HD channels, check with your cable/satellite service provider for details.

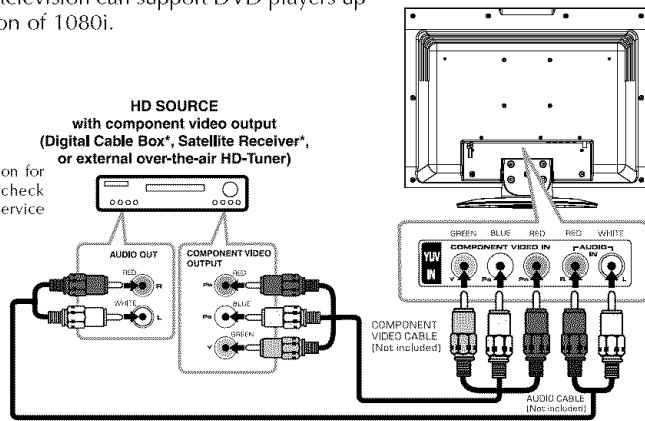

CONNECTING AN AUDIO AMPLIFIER

This connection allows you to use an audio amplifier and external speakers.

Connect the right (red) and left (white) audio OUTPUT from this unit to the right (red) and left (white) audio INPUT on your amplifier. Refer to your amplifier's user manual for more information.

Note :

To control the audio, both the TV and the amplifier must be turned on, and the volume of the amplifier must be set above 0, or you will not hear any sound.

If you want to hear the sound from the amplifier only. Press the **Volume -** button of TV to decrease the volume or press the **MUTE** button of remote control to turn off the sound.

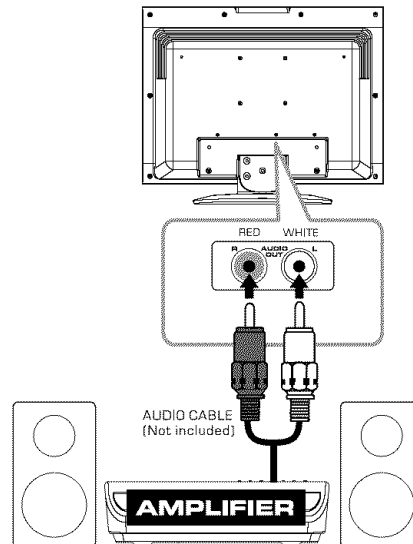

CONNECTIONS

CONNECTING A PC

Connect the 15-pin D-SUB PC/VGA connector from your computer to the 15-pin D-SUB PC/VGA input on this unit using a monitor cable (not included). Connect a stereo audio cable (not included) to the PC AUDIO IN jack on the bottom of this unit, and the other end to the AUDIO OUT jack on your computer's sound card.

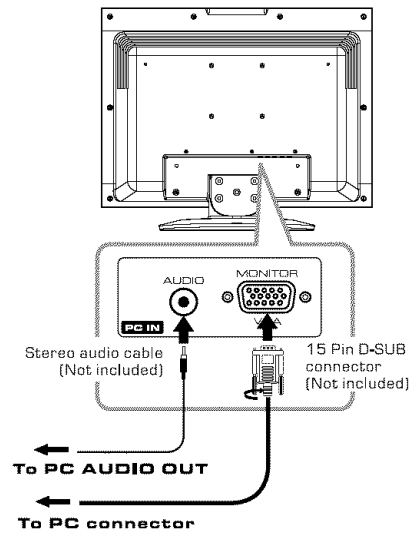

CONNECT THE POWER CORD

- Connect the AC power cord into a wall outlet.
- Press the **STANDBY/ON** button on the top of unit or remote control to turn on the unit.

Note:

- Be sure the AC power cord is disconnected and all functions are off before making connections.
- Make sure that all the components are connected correctly.
- **To prevent electrical shock, match wide blade of plug to wide slot, and fully insert.**
- When you are not going to use the unit for a long period of time, disconnect the power cord.

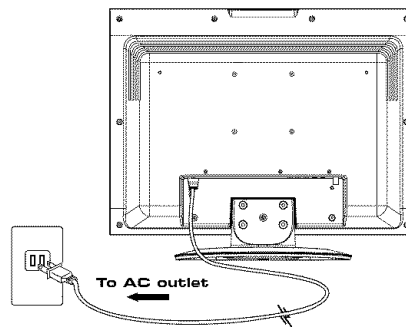

INSTALLATION

REMOVING THE BASE STAND

WARNING: The LCD Display is very fragile, and must be protected at all times when removing the base stand. Be sure that no hard or sharp, or anything that could scratch or damage the LCD display, come in contact with it. Do NOT place pressure on the rear of the unit at any time because the screen could crack.

1. Disconnect any cables or cords connected to the unit.
2. Lay the unit down on a flat surface, so the back side is facing up, making sure to place a soft cushioned material (such as a pillow or thick piece of foam) beneath the screen.
3. Remove the four screws and then remove the BASE STAND from the TV.

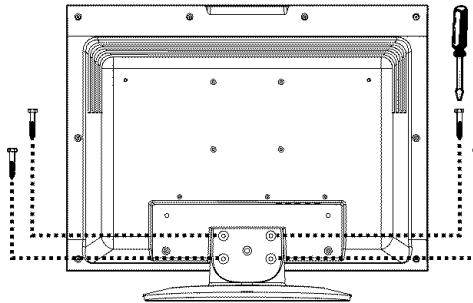

MOUNTING ON THE WALL

This unit is VESA-compliant, and is designed to be wall-mounted with a VESA-compliant 3.9" x 3.9" (100mm x 100mm) mounting kit designed for flat-panel TVs (sold separately). Mount this unit according to the directions included with the mounting kit.

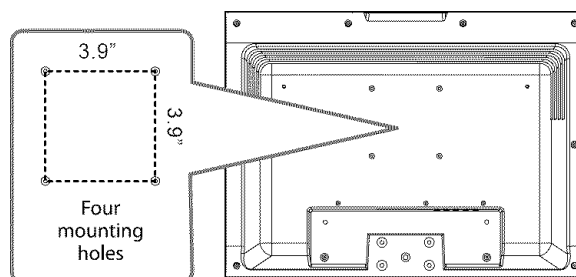

USING HEADPHONES

- Turn down the volume before connecting headphones to the unit, then adjust the volume to your desired level.
- When headphones are connected, no sound will come from the front speakers.

Note:

- Avoid listening to sound at high levels for prolonged periods of time. This may be harmful to you and may cause hearing loss.

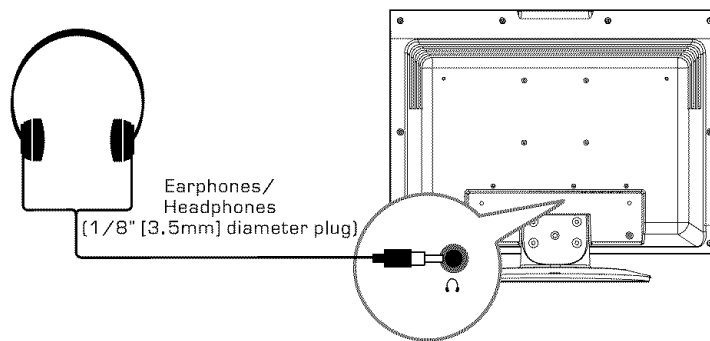

TV SETUP

MAIN MENU

1. Press the **MENU** button.
2. Use the **▲** or **▼** button to select the options (Picture / Sound / Setup / TV Setting / Restore Setting).
3. The screen will change to your selected mode immediately.
4. To exit the MAIN MENU and return to the normal screen, press the **EXIT** button on remote control.

NOTE: When you are in PC, AV IN, YUV IN mode, the TV Setting option will not be shown.

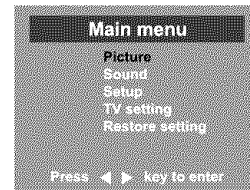

PICTURE MENU

1. Press the **MENU** button.
2. Use the **▲** or **▼** button to select the **Picture menu**, then press the **▶** button to confirm the setting.
3. Use the **▲** or **▼** button to select the options (**Brightness, Contrast, Color, Sharpness, Hue, Color Temp, Mode**) and adjust them using the **◀** or **▶** buttons. (The screen will change to your desired setting).
4. Repeat step 3 to adjust other options.
5. To exit the MAIN MENU and return to the normal screen, press the **EXIT** button on remote control.

- **Brightness** : Adjust to brighten the darkest parts of the picture.
- **Contrast** : Adjust to sharpen the picture quality. The black portions of the picture become richer in darkness and the white become brighter.
- **Color** : Adjust the color of the picture.
- **Sharpness** : Adjust the sharpness level to improve detail in the picture.
- **Hue** : Adjust the hue of the picture. (Toward purple / Toward green)
- **Color Temp** : Adjust the three color temperature of the picture. Select Normal (balanced) / Cold (blue white) / Warm (red white) mode.
- **Mode** : Select from preset screen display settings to match the type of show you are watching (Standard, Personal, Movie, Dynamic, & Soft).

TV / AV MODE

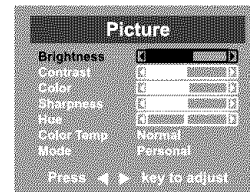

YUV MODE

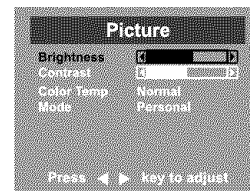

In PC mode

Use the **▲** or **▼** button to select the options (**Brightness, Contrast, Frequency, Phase, H offset, V offset, Auto config, Color Temp, Mode**) and adjust them using the **◀** or **▶** buttons. (The screen will change to your desired setting).

- Resolution : 1,280 x 1,024 max
- Refresh Frequency : 60Hz max
- **H offset** : Center the image by moving it left or right.
- **V offset** : Center the image by moving it up or down.
- **Colour Temp** : Adjust the three colour temperature of the picture. Select Normal (balanced) / Cold (blue white) / Warm (red white) mode.

PC MODE

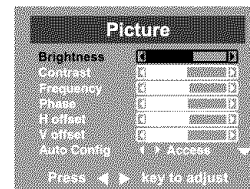

TV SETUP

SOUND MENU

1. Press the **MENU** button.
2. Use the **▲** or **▼** button to select the **Sound menu**, then press the **►** button to confirm the setting.
3. Use the **▲** or **▼** button to select the options (**Bass, Treble, Balance, Mode**) and adjust them using the **◀** or **▶** buttons.
4. Repeat step 3 to adjust other settings.
5. To exit the MAIN MENU and return to the normal screen, press the **EXIT** button on remote control.

Note:

Experiment with different sound settings until you find the settings you prefer.

- **Bass** : Adjust the bass range.
- **Treble** : Adjust the treble range.
- **Balance** : Adjust the balance level toward the left or right speakers.
- **Mode** : Select from preset sound settings (Personal, Voice, Music, Theater) to match the type of show you are watching.

TV / AV / YUV / PC MODE

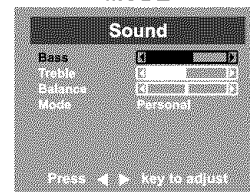

SETUP MENU

1. Press the **MENU** button.
2. Use the **▲** or **▼** button to select the **Setup menu**, then press the **►** button to confirm the setting.
3. Use the **▲** or **▼** button to select the options (**OSD Size, Language, Parental, Timers**) and adjust them using the **◀** or **▶** buttons.
4. Repeat step 3 to adjust other settings.
5. To exit the MAIN MENU and return to the normal screen, press the **EXIT** button on remote control.

Notes:

- **OSD Size** : Select the screen size you prefer.
- **Language** : Select from English / Français / Español.
- **Parental** : Sets the parental controls. Refer to the section titled "PARENTAL SETTING" for instructions.
- **Timers** : Select the Sleep timer / Reminder timer mode :
Off -> 5 - - - -> 115 -> 120.
Sleep timer : Set the LCD TV to turn itself off within a certain time.
Reminder timer : Remind the show time setting of TV.

TV / AV MODE

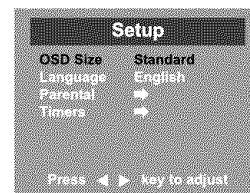

YUV / PC MODE

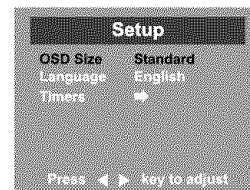

TV SETUP

PARENTAL SETTING

LOCK CODE

1. Press the **MENU** button.
2. Use the **▲** or **▼** button to select the **Setup menu**, then press the **▶** button to confirm the setting.
3. Use the **▲** or **▼** button to select the **Parental menu**, then press the **◀** or **▶** button to confirm the setting and the menu locked screen will be displayed.
4. Enter a 4-digit lock code. Once entered, the screen will enter the Parental menu. The preset lock code is "0000".
5. To exit the MAIN MENU and return to the normal screen, press the **EXIT** button on remote control.

TV / AV MODE

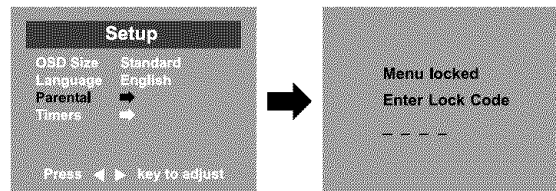

If you forget the password,
enter "8888" to unlock parental control.

TV SETUP

PARENTAL SETTING

CHILD LOCK

1. Press the **MENU** button.
2. Use the **▲** or **▼** button to select the **Setup** menu, then press the **▶** button to confirm the setting.
3. Use the **▲** or **▼** button to select the **Parental** menu, then press the **◀** or **▶** button.
4. Enter a 4-digit to select the **Lock code** and turn on/off the **Child lock** using **◀** or **▶** button.

TV / AV MODE



5. Use the **▲** or **▼** button to select **various Parental settings** and use the **◀** or **▶** button to adjust each setting.
6. Repeat steps 4-5 to adjust other options.
7. To exit the MAIN MENU and return to the normal screen, press the **EXIT** button on remote control.

MPPA Rating	<ol style="list-style-type: none"> 1. OFF 2. G : GENERAL AUDIENCES, Suitable for all ages. 3. PG : PARENTAL GUIDANCE SUGGESTED - Some material may not be suitable for children. 4. PG-13 : PARENTS STRONGLY CAUTIONED - Some material may be inappropriate for children 	<ol style="list-style-type: none"> 5. R ; RESTRICTED, Under 17 requires accompanying parent or adult guardian for viewing in movie theaters. 6. NC-17 : No one 17 or under admitted in movie theaters, 7. X : Adults Only.
PG Rating	<ol style="list-style-type: none"> 1. OFF 2. TV-Y : Recommended for all children. 3. TV-Y7 : Recommended for all children age 7 and above. 	<ol style="list-style-type: none"> 4. TV-G : General Audience. 5. TV-PG : Parental Guidance Suggested. 6. TV-14 : Parental Strongly Cautioned. 7. TV-MA : Mature Audience Only.
PG Contents	<ol style="list-style-type: none"> 1. Violence : Contains violence. 2. Sex : Contains sexual situations. 3. Language : Contains adult language. 	<ol style="list-style-type: none"> 4. Dialogue : Contains dialogue. 5. Fantasy Violence : Contains fantasy violence.
Can. Eng	<ol style="list-style-type: none"> 1. E : Exempt. 2. C : Children. 3. C8 : Recommended for children age 8. 4. G : GENERAL AUDIENCES, Suitable for all ages. 	<ol style="list-style-type: none"> 5. PG : PARENTAL GUIDANCE SUGGESTED - Some material may not be suitable for children. 6. 14+ : Viewers 14 years and older. 7. 18+ : Adult Programming.
Can. French	<ol style="list-style-type: none"> 1. E : Exempt. 2. G : GENERAL AUDIENCES, Suitable for all ages. 3. 8+ : Not recommended for young children. 	<ol style="list-style-type: none"> 4. 13+ : Not suitable for children under the age of 13. 5. 16+ : Not suitable for children under the age of 16. 6. 18+ : Adult Programming.

TV SETUP

TV SETTING

1. Press the **MENU** button.
2. Use the **▲** or **▼** button to select the **TV setting menu**, then press the **▶** button to confirm the setting.
3. Use the **▲** or **▼** button to select the **Channel no.** setting and use the **◀** or **▶** button to change the channel no.
4. Use the **▲** or **▼** button to select the **Tuning mode** and use the **◀** or **▶** button to change from AIR (over-the-air broadcasts) to CABLE (cable/satellite broadcasts).
5. Use the **▲** or **▼** button to select the **Auto tune** and press the **◀** or **▶** button to confirm the selection. The unit will immediately search through all possible TV channels and store those channels with signals in memory. After this is complete, the unit will switch to the first channel found.
6. To exit the MAIN MENU and return to the normal screen, press the **EXIT** button.

Note : This option is available in TV mode only.

Remarks:

Channel no. : 2-69 channel for Air mode, 1-125 channel for Cable mode.

Tuning mode : Air or Cable mode are available.

Auto tune : Searches for usable stations and stores them in memory.

Skip : **ON** - Skip weak channels. **OFF** - No channel skip.

Fine tune : The frequency changes to allow fine tuning.

AFC : Auto frequency control.

MTS : Select the Mono sound/Stereo sound/Secondary Audio Program (SAP). Refer to the section titled "MTS SETTING" for instructions.

TV MODE

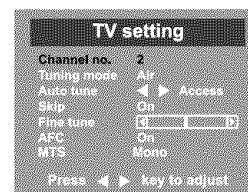

MTS (Multi-channel Television Sound) SETTING

This feature allows reception of sound other than the main audio for the program.

1. Press the **MENU** button.
2. Use the **▲** or **▼** button to select the **TV setting menu**, then press the **▶** button to confirm the setting.
3. Use the **▲** or **▼** button to select **MTS menu**, and press the **◀** or **▶** button to select the options (**Mono, Stereo, SAP**)
4. To exit the MAIN MENU and return to the normal screen, press the **EXIT** button on remote control.

Note:

- MTS only operates while in TV mode.
- The SAP (Secondary Audio Programs) feature allows a TV station to broadcast other information, which could be audio in another language.

TV MODE

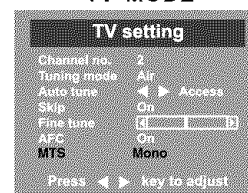

RESTORE SETTING

If you reset the TV to the factory settings, all your present settings on picture & sound will be erased and replaced by the factory's default settings. However, picture setting in PC mode and parental setting will not be erased.

TROUBLESHOOTING GUIDE

SYMPTOM

CAUSE (AND REMEDY)

No power.

- Check that the AC power cord is connected.
- Turn on the unit.

The remote does not function.

- Remove any obstacles between the remote and the unit.
- Use the remote near the unit.
- Point the remote at the remote sensor on the unit.
- Replace the battery in the remote with a new one.

Bad Picture (snow, multiple images, distortion, blurry)

- Check the location of the antenna and adjust it if necessary.
- Make sure the antenna cable is connected firmly.
- Make sure all input cables are firmly connected.

No sound.

- Increase the volume.
- Check whether the mute function has been activated on the Remote Control.

Black and white picture.

- Check the Picture setting within the Setup menu.
- Check to make sure the program you are watching is broadcast in Color and not Black & White.

No picture or sound.

- Make sure the unit is plugged in and turned on.
- Make sure that the TV mode is selected.
- Try a new channel to check for possible station trouble.
- Make sure the antenna is connected properly.
- Increase the volume.
- Make sure the antenna or audio/video source device is working properly.
- Make sure all cables are connected firmly.
- Check for local interference.

Colored patches of picture.

- Make sure there are no unshielded electrical devices nearby that are causing interference.
- Turn the TV off for 30 minutes, then try it again.

MAINTENANCE

CLEANING THE UNIT

- Be sure to turn the unit off and disconnect the AC power cord before maintaining the unit.
- Wipe the unit with a dry soft cloth. If the surfaces are extremely dirty, wipe clean with a cloth which has been dipped in a weak soap-and-water solution and wrung out thoroughly, then wipe with a dry cloth.
- Never use alcohol, benzine, thinner, cleaning fluid or other chemicals. Do NOT use compressed air to remove dust.