

Use & Care Guide

Dual Fuel Ranges



 **Electrolux**

2 Finding Information

PLEASE READ AND SAVE THIS GUIDE

Attach your sales receipt to this page for future reference.

Thank you for choosing **Electrolux**, the new premium brand in home appliances. This *Use & Care Guide* is part of our commitment to customer satisfaction and product quality throughout the service life of your new range.

We view your purchase as the beginning of a relationship. To ensure our ability to continue serving you, please use this page to record key product information.

IMPORTANT

PLEASE READ all instructions completely before attempting to install or operate the unit.

Once you have your unit installed, we suggest you keep this manual in a safe place for future reference. Should any problems occur, refer to the **Troubleshooting** section of this manual. This information will help you quickly identify a problem and get it remedied. In the event you require assistance, please contact the dealer where you purchased your unit.

MAKE A RECORD FOR QUICK REFERENCE

Whenever you call to request information or service, you will need to know your model number and serial number. You can find this information on the serial plate located behind the air intake vents. With the oven door open, the air intake vents are located just below the control panel on the front of the appliance. These numbers are also printed on the product registration card.

PRODUCT REGISTRATION CARD

The package containing this manual also includes your product registration information. Warranty coverage begins at the time your Electrolux range was purchased.

If you received a damaged product, immediately contact your dealer or builder. Do not install or use a damaged appliance.

NOTE

Registering your product with Electrolux enhances our ability to serve you. You can register online (at the Internet address below) or by dropping your Product Registration Card in the mail. Complete and mail the Product Registration Card as soon as possible to validate the registration date.

Please record the purchase date of your Electrolux unit and your dealer's name, address and telephone number.

Purchase Date

Electrolux Model Number

Electrolux Serial Number

Dealer Name

Dealer Address

Dealer Telephone

Keep this manual and the sales receipt together in a safe place for further reference.

QUESTIONS?

For toll-free telephone support in the U.S. and Canada:
1-877- 4ELECTROLUX (1-877-435-3287)

For online support and Internet product information:
www.electroluxusa.com

TABLE OF CONTENTS

Finding Information	2	Getting Started	21
Please Read And Save This Guide	2	Before Setting Oven Controls	21
Make A Record For Quick Reference	2	Companion Oven	23
Questions	3	Setting Oven Controls	24
Table Of Contents	4	Selector Knob Functions	24
Safety	5	Oven Functions	25
Important Safety Instructions	5	Cooking Instructions	26
General Precautions	6	Baking	26
Liquified Petroleum (Propane)		Baking Problems	27
Gas Conversion	9	Convection Baking	28
Feature Overview	10	Convection Roasting	29
Control Panel Layouts	10	Broiling	31
Cooktop Features	11	Care and Cleaning	33
Proper Burner Adjustments	11	Using the Self-Clean Feature	33
Burner Locations	11	Starting the Self-Clean Cycle	34
Sealed Burner Configurations	12	Cleaning Tips	35
Brass Burner Rings	12	Cleaning Stainless Steel Surfaces	37
Burner Igniters	12	Cleaning Porcelain Grates	37
Control Knobs	13	Cleaning Knobs and Bezels	38
Placement of Burner Grates	13	Cleaning Burner Bases	38
Surface Cooking	13	Cleaning Burner Rings	39
Flame Adjustment	13	Cleaning Burner Igniters	39
Utensils for Best Performance	14	General Cleaning	40
Using the Griddle	14	Oven Light	41
Using the Wok Stand	15	Solutions to Common Problems	42
Using the Simmer Plate	16	Warranty	44
Setting Surface Controls	17		
Operation	18		
Before Cooking	18		
Operating the Control Valves	18		
Setting the Burner Flame Height	20		
Energy Saving Tips	20		

IMPORTANT SAFETY INSTRUCTIONS

Safety Precautions

Do not attempt to install or operate your appliance until you have read the safety precautions in this manual. Safety items throughout this manual are labeled with a Warning or Caution based on the risk type.

Definitions

 This is the safety alert symbol. It is used to alert you to potential personal injury hazards. Obey all safety messages that follow this symbol to avoid possible injury or death.

WARNING

WARNING indicates a potentially hazardous situation which, if not avoided, could result in death or serious injury.

CAUTION

CAUTION indicates a potentially hazardous situation which, if not avoided, may result in minor or moderate injury.

CAUTION

CAUTION used without the safety alert symbol indicates a potentially hazardous situation which, if not avoided, may result in property damage.

IMPORTANT

Indicates installation, operation or maintenance information which is important but not hazard related.

6 Safety

General Precautions

IMPORTANT

- Begin by ensuring proper installation and grounding of the appliance by a qualified technician according to the accompanying Installation Instructions. Have the installer show you where the fuse or junction box is located so that you know how and where to turn off power. Also, have the installer show you the location of the gas supply. If you smell gas, do not use the range. Immediately turn off the gas supply at the shut off valve, disconnect electrical power to the unit at the fuse or junction box and contact the gas supplier or qualified appliance technician.
- Ensure that the range is used only by those individuals who are able to operate it properly.
- Use the range only for cooking tasks expected of a home appliance as outlined in this manual.
- Properly clean and maintain as recommended in this manual, cleaning only the parts listed.
- Use only dry potholders to avoid steam burns when removing hot cookware.
- In the event that a burner flame goes out and gas escapes, open a window or door. Wait at least 5 minutes before attempting to use the range.
- Select utensils of the proper size, material and construction for the particular type of cooking being done. Select utensils that are large enough to contain food without boil-overs or spillovers. Choose pans with easily grasped handles that will stay cool while cooking. Do not use utensils with loose handles. Avoid using pans that are too heavy to lift safely. Use cookware only for its intended purpose. Certain types of glass, ceramic, and earthenware utensils are suitable for use only in an oven and not in cooktop applications.
- When cooking, set the burner controls so that the flame heats only the bottom of the utensil and does not extend up the sides of the utensil.
- When deep fat frying, be certain that the pan is large enough to contain the desired volume of food without overflow caused by bubbling of the fat. Never leave a deep fat fryer unattended. Avoid deep fat frying of moist or frost-covered foods. Foods with high water content may cause spattering or spilling of the hot fat. Heat fat slowly and stir together any combinations of oils and fats prior to applying heat. Utilize a deep fat frying thermometer to avoid heating the fat to temperatures above the flash point.
- Always turn pan handles to the side or back of the cooktop. Do not turn handles towards the room where they are easily hit. Handles should not extend over adjacent burners.
- Always check the positions of the control knobs to make sure the cooktop is off when you are finished cooking.
- Before performing any service, turn off the gas supply by closing the gas shut-off valve and turning off the electrical power supply.

IMPORTANT

- Always light each burner prior to placing a utensil on the burner grate. Also, turn the control knob to the "off" position before removing a utensil from the burner grate.
- Always clean the cooktop cautiously. If using a damp sponge or cloth, wait until the cooktop has cooled sufficiently to prevent steam burns. Also, some cleaners can produce harmful or unpleasant fumes if applied to hot surfaces.
- Clean only those parts listed in this manual.
- Keep any ventilation filters clean to avoid grease fires.
- Always set utensils gently onto the grates and center them so that they are well-balanced.
- Always keep the cooktop surface clean and dry.
- This unit is designed as a cooking appliance. Never use it for warming or heating a room.
- Before performing any service, turn off the gas supply by closing the gas shut-off valve and turning off electrical power supply.
- Use this appliance only for its intended use as described in this manual. Do not use corrosive chemicals or vapors in this appliance. This type of appliance is not designed for industrial or laboratory use.
- Exercise caution when opening the oven door. Let hot air or steam escape before looking or reaching into the oven.
- Position oven racks in desired locations when the oven is cool. (If a rack must be repositioned after the oven is already hot, be certain that the potholder does not contact a hot heating element in the oven.)
- Before Self-Cleaning the oven, remove the broiler pan and insert, oven racks, rack glides, convection fan filter and any other utensils.
- In the event that a burner flame goes out and gas escapes, turn off the gas control and open a window or door. Wait at least 5 minutes before attempting to use the cooktop.

8 Safety

CAUTION

- Do not use the range for warming or heating the room.
- Do not leave children alone or unattended in the area where the range is in use. Never allow children to sit or stand on any part of the range. Do not let children play with the range.
- Do not store items of interest to children above the range. Children could be burned or injured while climbing on the appliance.
- Do not wear loose or hanging apparel while using the range.
- Do not store combustible, flammable or explosive materials in the range or in adjacent cabinets.
- Do not leave food or cooking utensils, etc., in the oven during the self-clean cycle.
- Do not attempt to repair or replace any part of the range unless specifically recommended in literature accompanying this appliance. All other service should be referred to a qualified technician.
- Do not use water on grease fires. A violent steam explosion may result. Smother any flames with a lid, cookie sheet or flat tray. Flaming grease can be extinguished with baking soda or a multipurpose chemical or foam extinguisher.
- Do not allow potholders to touch gas burners. Do not use a towel or bulky cloth as a potholder.
- Do not use commercial oven cleaners or oven liner protective coatings on any part of the oven.
- Do not clean the door gasket, because rubbing, moving or in any way damaging the gasket, may eliminate the required tight door seal.
- DO NOT TOUCH INTERIOR SURFACES OF THE OVEN. During and after use, do not touch or let clothing or other flammable materials contact heating elements or interior surfaces of the oven until they have had sufficient time to cool.
- Do not block or obstruct the holes beneath the control knobs. Blocking these holes may affect burner operation and may result in a hazard.
- When using the cooktop, do not touch the grates, burner caps, burner bases, or any other parts in proximity to the flame. These components may be hot enough to cause burns.
- If the range is near a window, do not use long curtains as a window treatment. They can blow over the cooktop and create a fire hazard.
- Do not cover the burners and grates with anything except properly selected utensils. Decorative covers should not be used.
- Do not heat unopened food containers such as baby food jars and cans. Pressure buildup may cause the container to burst and cause injury.
- Do not use abrasive or caustic cleaners or detergents on this appliance, as these may cause permanent damage. Do not use aerosol cleaners, as these may be flammable or cause corrosion of metal parts.
- Do not use or attempt to use this appliance in the event of a power failure.
- Do not slide cookware across the grates. Sliding may damage the finish of the grates. Lift utensils to reposition them.
- Do not allow acids (citrus juices, tomato sauces, etc.) to remain on the oven cell surfaces. The porcelain finish may stain.
- Do not touch the range top or backguard with your bare hands during all cooking and self cleaning modes. Venting from the oven may cause the backguard to become hot.

LIQUIFIED PETROLEUM (PROPANE) GAS CONVERSION

This appliance can be used with Natural Gas and Propane Gas. It is shipped from the factory for use with natural gas.

A kit for converting to LP gas is supplied with your range. The kit is marked "FOR LP/PROPANE GAS CONVERSION". Follow the installation instructions which are inside the envelope.

The conversion must be performed by a qualified service technician in accordance with the kit instructions and all local codes and requirements. Failure to follow instructions could result in serious injury or property damage. The qualified agency performing this work assumes responsibility for the conversion.

WARNING

Severe shock, or damage to the range may occur if the range is not installed by a qualified installer or electrician.

CAUTION

Any additions, changes or conversions required in order for this appliance to satisfactorily meet the application needs must be made by a qualified service technician in accordance with the manufacturer's instructions and all codes and requirements of the authority having jurisdiction. Failure to follow the instructions could result in serious injury or property damage. The qualified agency performing this work assumes responsibility for the conversion.

10 Feature Overview

Before using your range, become familiar with the features and control panel layout. See **Figure 1** for a detailed control panel layout for your model.

NOTE

Upon initial power being applied to the range, the function LED lights will flash while the electronic control completes its self test mode. The lights will continue flashing until the Function Knob is moved to some other position and back to "Off". At this time the range is ready for use.

NOTE

If a power outage occurs, the above noted test sequence will take place. The function LED lights will flash. The LED lights will continue to flash until the Function Knob is moved to some other position and back to "Off". At this time the range is re-set for use.

Model Features

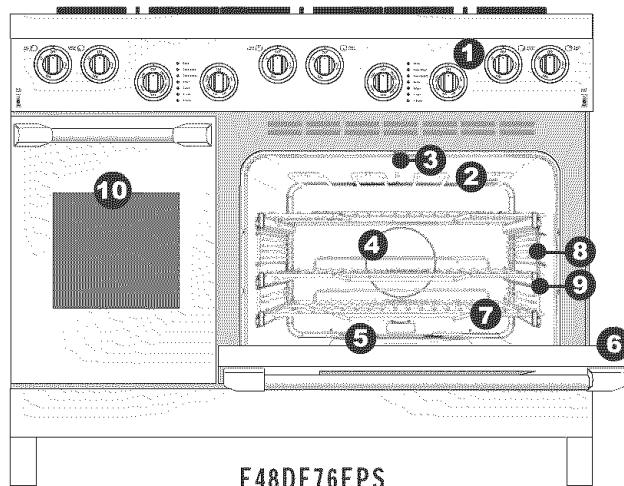
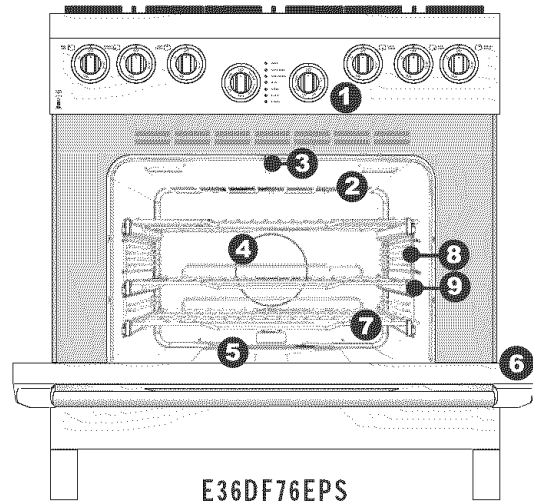
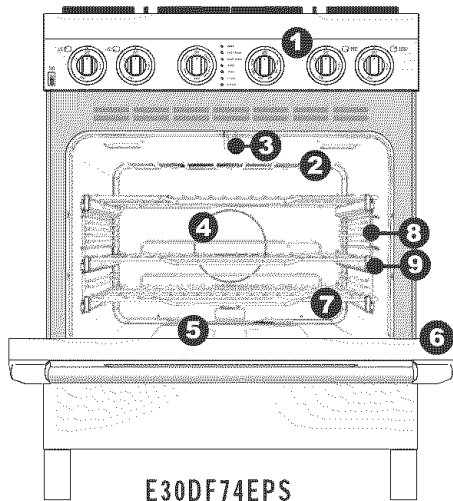

1. Control Panel
2. Broiling Element
3. Oven Door Latch
4. Convection Fan & Element
5. Bake Element
6. Oven Door
7. Oven Racks
8. Oven Rack Supports
9. Oven Rack Glides
10. Companion Oven

Figure 1

PROPER BURNER ADJUSTMENTS

The color of the flame is the key to proper burner adjustment. A good flame is clear, blue and hardly visible in a well-lighted room. Each cone of flame should be steady and sharply defined. Adjust or clean burner if flame is yellow-orange. To clean burner, see instructions under **General Care & Cleaning**.

BURNER LOCATIONS

All Electrolux Icon range cooktops are equipped with sealed burners. Burner configurations vary by the model number of your range. See **Figure 2** for a detailed burner layout for your model.

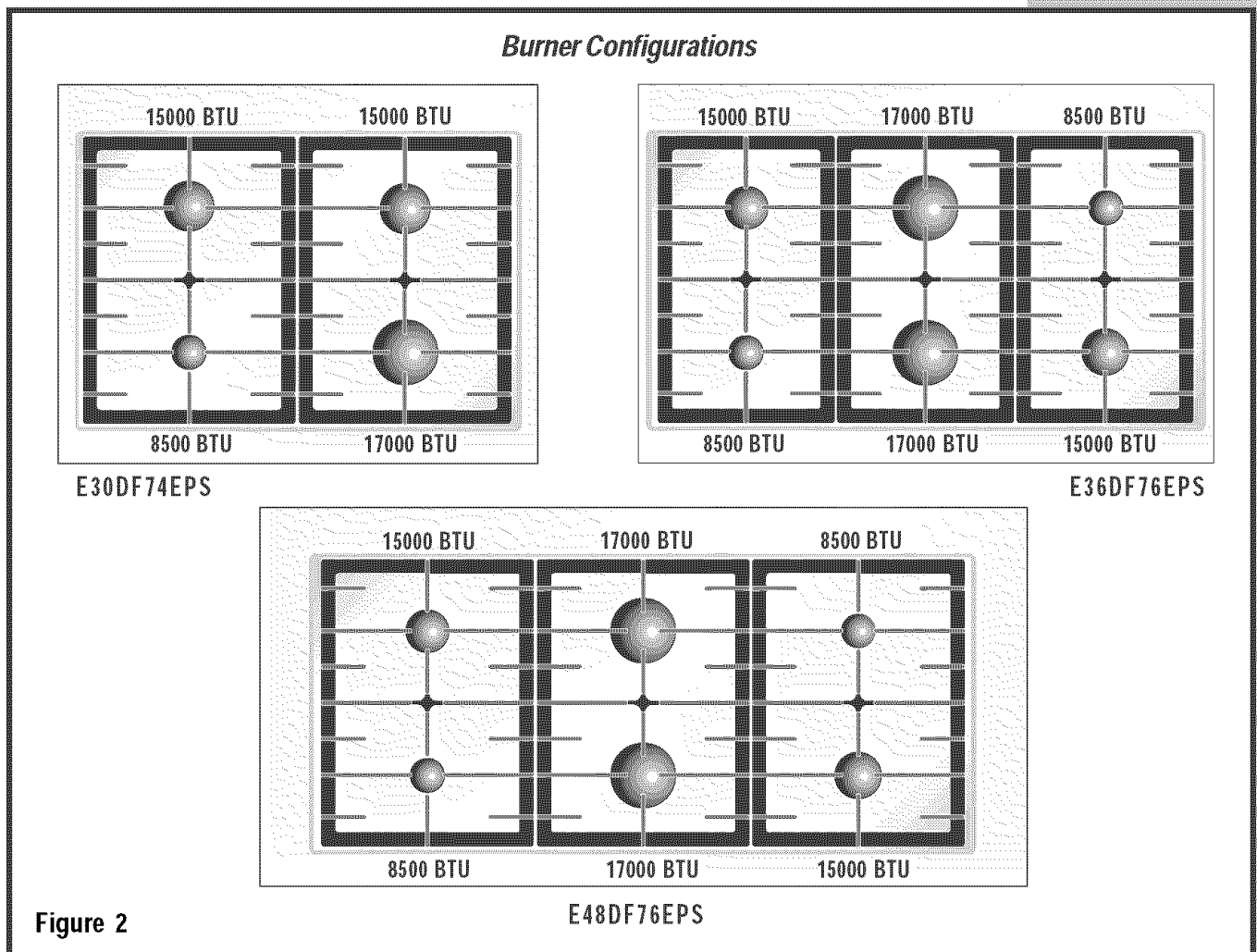

12 Cooktop Features

SEALED BURNER CONFIGURATIONS

On E30DF74EPS ranges, there are a total of four burners, including one burner rated at a maximum output of 17,000 BTU/HR, two burners rated at a maximum of 15,000 BTU/HR and one burner rated at a maximum output of 8,500 BTU/HR. The knobs are grouped in twos. The left two knobs operate the left two burners, and the right two knobs control the two right burners.

On E36DF76EPS and E48DF76EPS ranges, there are a total of six burners, including two burners rated at a maximum output of 17,000 BTU/HR, two burners rated at a maximum of 15,000 BTU/HR and two burners rated at a maximum output of 8,500 BTU/HR. The knobs are positioned to correspond with the burner layout.

BRASS BURNER RINGS

All burners are attached to the cooktop by retaining nuts. Gaskets around the undersides of the burner bases ensure that the burners are sealed, thereby preventing any liquid spills from entering the cooktop chassis. All spills remain on the surface of the cooktop.

The brass burner heads spread the flame evenly around the burner perimeters. The burner heads must seat properly in the burner bases to enable proper cooktop operation. To ensure proper seating, positioning tabs have been placed on the bottom of each burner head to slide into corresponding notches in the fixed burner base.

BURNER IGNITORS

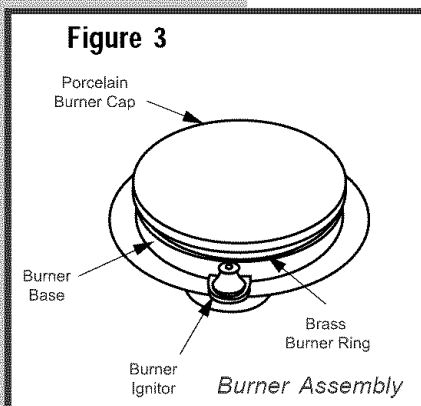

A burner igniter is located on each gas burner base. When a control knob is rotated more than 90 degrees counterclockwise, the ignitor will spark and the selected burner will ignite. Additionally, due to Vantage Flame™, the automatic reignition feature, the igniters will spark automatically if a flame should blow out or be severely distorted by a draft or by a ventilation system. Burner igniters must always be kept clean and dry to function properly. Dirty or wet igniters will result in constant sparking, even if there is a flame present. See **Figure 3**.

CONTROL KNOBS

The control knobs provided with this range are designed for ease of use and longevity. The “D” shaped design of the knob shaft ensures proper orientation when reinstalling the knob. Located beneath each knob is a bezel ring that mounts to the range.

PLACEMENT OF BURNER GRATES

Place grates on the porcelain coated spill tray. See **Figure 4**. Be sure they are located correctly inside the stainless steel frame.

IMPORTANT

Do not slide the grates on the stainless steel frame. Doing so can damage the surface.

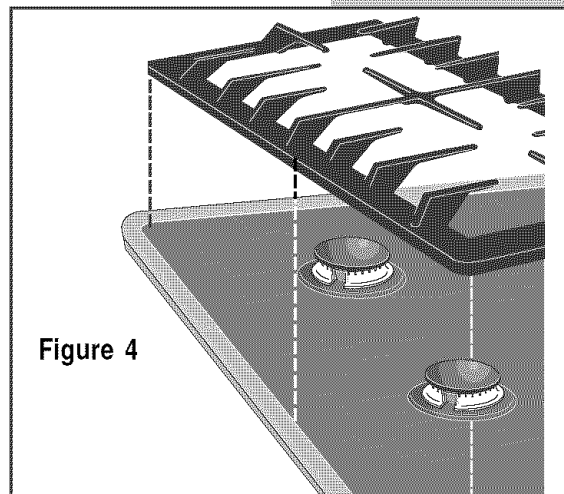

Figure 4

FLAME ADJUSTMENT

For most cooking, start on the highest control setting and then turn to a lower one to complete the process. Use the chart below as a guide for determining proper flame size for various types of cooking. The size and type of utensil used and the amount of food being cooked will influence the setting needed for cooking.

For deep fat frying, use a thermometer and adjust the surface control knob accordingly. If the fat is too cool, the food will absorb the fat and be greasy. If the fat is too hot, the food will brown so quickly that the center will be undercooked. Do not attempt to deep fat fry too much food at once as the food will neither brown nor cook properly.

*Flame Size	Type of Cooking
High Flame	Start most foods; bring water to a boil; pan broiling
Medium Flame	Maintain a slow boil; thicken sauces, gravies; steam
Low Flame	Keep foods cooking; poach; stew

***These settings are based on using medium-weight aluminum pans with lids. Settings may vary when using other types of pans.**

Never extend the flame beyond the outer edge of the utensil. A higher flame simply wastes heat and energy, and increases your risk of being burned by the flame.

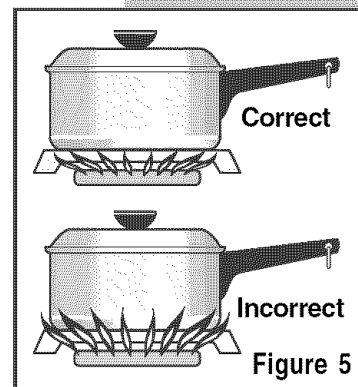
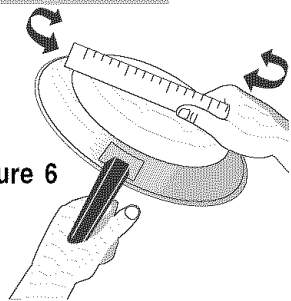

Figure 5

14 Surface Cooking

UTENSILS TO USE FOR BEST PERFORMANCE

Figure 6



Pans should have flat bottoms. Check for flatness by rotating a ruler across the bottom. There should be no gaps between the pan and ruler.

* Specialty pans such as lobster pots, griddles and pressure cookers may be used but must conform to the above recommended cookware requirements.

*GOOD

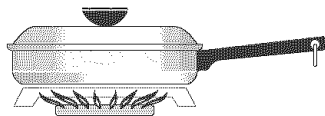

- Flat bottom and straight sides.
- Tight fitting lids.
- Weight of handle does not tilt pan. Pan is well balanced.
- Pan sizes match the amount of food to be prepared and the size of burner.
- Made of material that conducts heat well.
- Easy to clean.

POOR

- Curved and warped pan bottoms.

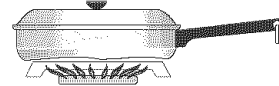

- Pan overhangs unit by more than 2.5 cm (1").

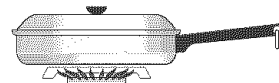

- Heavy handle tilts pan.

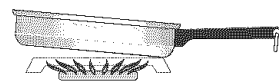

- Flame extends beyond unit.

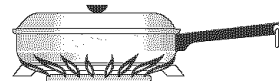

Note: Always use a utensil for its intended purpose. Follow manufacturer's instructions. Some utensils were not made to be used in the oven or on the cooktop.

USING THE GRIDDLE

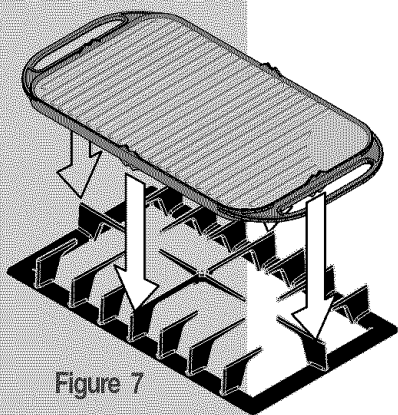

Figure 7

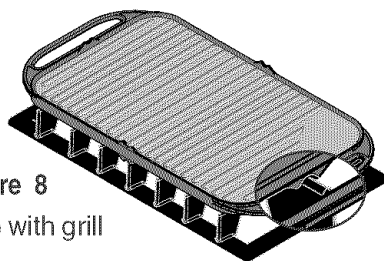

Figure 8
Side with grill

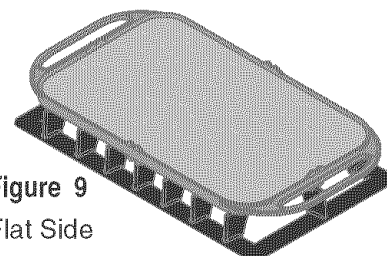

Figure 9
Flat Side

The griddle is intended for direct food cooking and can be used on both sides (Figures 8 and 9). Do not use pans or other cookware on the griddle. Doing so could damage the finish. With the grate in position over the burner, set the griddle on top of the grate positioning the notches in the griddle over the grate fingers (Figures 7 and 8).

⚠ CAUTION

Always place the griddle on the grate before to turn on the burner. Always use potholders to remove the griddle from the grate. Allow the griddle to cool before removing. Do not set hot griddle on surfaces that cannot withstand high heat; such as countertops. Be sure the griddle is positioned correctly and stable before use to prevent hot spills and possible burns.

USING THE WOK STAND

The Wok Stand provided with your cooktop is designed to allow round-bottomed woks to be used. **It is recommended that you use a 14 inch diameter (35.5 cm) or less Wok.** It is recommended that you use the right front **POWER** burner for model E30DF74EPS or center front **POWER** burner for models E36DF76EPS and E48DF76EPS with the wok stand for best performance. If properly positioned, the Wok Stand will not slide off the grate.

⚠ CAUTION

Always use potholders to remove the wok stand from the grate. Allow the wok stand to cool before removing. Do not set hot wok stand on surfaces that cannot withstand high heat; such as countertops.

Be sure the Wok Stand is positioned correctly and stable before use to prevent hot spills and possible burns.

To Properly Position the Wok Stand:

With the grate in position over the burner, set the Wok Stand on top of the grate positioning the center of the Wok Stand over the center of the cooktop grate fingers (See **Figure 10**).

NOTE

The Wok cooking performance is best on the right front or center front **POWER** burner position depending on your range model.

⚠ CAUTION

Be sure to **ALWAYS** use the Wok Stand if the stability of the wok is uncertain. If cooking large amounts of liquid food without the Wok Stand, the wok may tip and spill over causing burns.

Flat-bottom woks with large flat bottoms may also be used on your cooktop Surface Burner Grates without the Wok Stand. Insure the stability of the flat-bottom wok before cooking without the Wok Stand. If unstable, **DO NOT** use the flat-bottom wok without the Wok Stand.

Round-bottom woks (with a support ring) should **NOT** be used. The supporting ring was not designed for proper or stable use on the Surface Burner Grates.

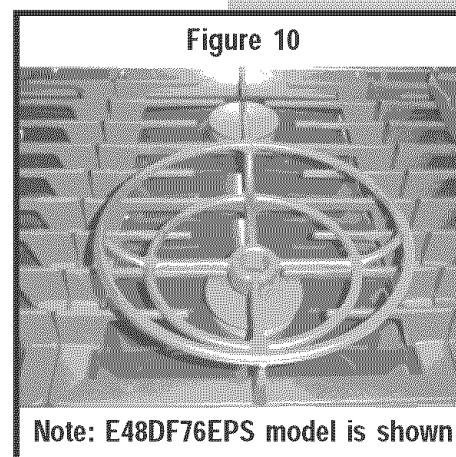

16 Surface Cooking

USING THE SIMMER PLATE

The Simmer Plate has been specifically designed for simmering and holding food at the lowest safe temperature. It can be used for cooking sauces long periods of time, or melting chocolate. With the grate in position over the burner, set the simmer plate on top of the grate, centering the plate over the grate fingers (See **Figure 11**). Then place the utensil on the simmer plate.

The Simmer Plate is to be used by setting the burner to its lowest setting. The Simmer Plate is intended to be used for simmering only. The Simmer Plate must be removed when cooking.

Figure 11

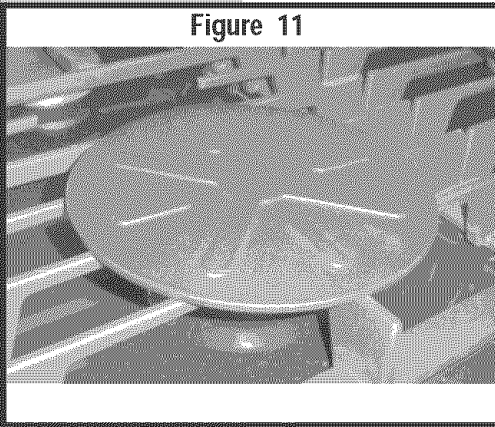

⚠ CAUTION

Always place the simmer plate on the grate before turning on the burner.

Always use potholders to remove the simmer plate from the grate. Allow the simmer plate to cool before removing. Do not set hot simmer plate on surfaces that cannot withstand high heat; such as countertops.

Be sure the simmer plate is positioned correctly and stable before use to prevent hot spills and possible burns.

SETTING SURFACE CONTROLS

Your range may be equipped with any combination of the following burners:

Simmer Burner: best used for simmering delicate sauces, etc.

Standard Burner: used for most all surface cooking needs.

Large Burner: best used when bringing large quantities of liquid to temperature and when preparing larger quantities of food.

Regardless of size, always select a utensil that is suitable for the amount and type of food being prepared. Select a burner and flame size appropriate to the pan.

Never allow flames to extend beyond the outer edge of the pan.

Your cooktop is also equipped with 300° rotation flame control valves. These valves provide enhanced control of the burner flame. Each burner lights automatically from an electric ignitor when its control knob is turned to the **LITE** position.

CAUTION

Do not place plastic items such as salt and pepper shakers, spoon holders or plastic wrappings on top of the cooktop when it is in use. These items could melt or ignite. Potholders, towels or wood spoons could catch fire if placed too close to a flame.

18 Operation

BEFORE COOKING

Ensure that the range has been installed by a qualified individual who has tested the operation of the range in accordance with the Installation Instructions. The brass burner rings, burner caps, grates, knobs and spill protectors must be in place for the cooktop to operate properly. All range components must be clean. Be certain that the gas and electrical power supplies to the range are operational. Read this **Use and Care Manual** in its entirety prior to operating the range.

OPERATING THE CONTROL VALVES

To light a particular burner, press in on the corresponding control knob, then immediately rotate the knob counterclockwise from the "OFF" position to the "LITE HI" position. **The burner igniters will spark continuously until the gas ignites on the selected burner. The igniters will stop sparking as soon as the burner ignites.**

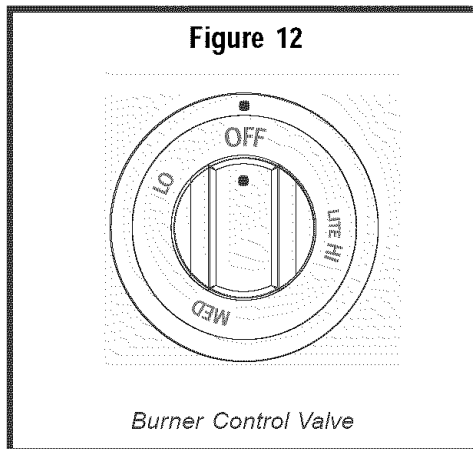

Once the burner is lit, reduce the flame height if desired by rotating the control knob further counterclockwise, then place the utensil on the grate. See **Figure 12**.

WARNING

Do not touch any burner cap, burner base, or igniter while the igniters are sparking, as an electrical shock could result.

IMPORTANT

- If the gas does not ignite within four seconds, turn off the valve. Allow at least two minutes for any gas to dissipate, then repeat the lighting procedure.
- Burner igniters must always be kept clean and dry to function properly. Due to the Vantage-Flame™ re-ignition feature, dirty or wet igniters will result in constant sparking, even if there is a flame present. Additionally, igniters will spark automatically if the flame is distorted by a draft or by a cooktop ventilation system. Eliminate the draft or reduce the ventilation blower speed in this case.
- When the cooktop is cool and/or more than two burners are in use, the igniters may continue to spark if the control knob is set to the "LOW" position. This is normal until the burner warms up. The tendency to spark under these conditions can be reduced by operating the burner at a higher flame setting for a short period of time (normally 60 seconds or less), then adjusting the control knob down to the "LOW" setting. The burner will also warm up faster if a utensil is placed on the grate.
- The flame should be steady and blue in color. Foreign material in the gas line, especially in new construction, may cause an orange flame during initial operation. This will disappear with further use.
- The flame should burn evenly around the perimeter of the burner. If the flame is uneven, ensure that the brass burner ring and porcelain burner cap are properly positioned, then check for any foreign material in the burner ring or on the burner cap. Remove any foreign material with a straightened paper clip, wire, or needle. Do not use a toothpick to remove clogs, as it could break off. Do not damage the brass or distort the shape of the burner ring ports.
- Never light the burners with a match or other open flame. If a burner does not ignite, refer to the Troubleshooting Guide.

SETTING THE BURNER FLAME HEIGHT

Setting the proper burner flame height for the desired cooking process and selected utensil will result in superior cooking performance, while also saving time and energy. Follow these recommendations for best results:

1. Use low or medium flame heights when cooking in utensils that are poor conductors of heat, such as glass, ceramic, and cast iron cooking vessels. Reduce the flame height until it covers approximately 1/3 of the utensil diameter. This will ensure even heating within the utensil and reduce the likelihood of burning or scorching of food.
2. Reduce the flame if it is extending beyond the bottom of the utensil. A flame that licks along the sides of the utensil is potentially dangerous, heats the utensil handle and kitchen instead of the food, and wastes energy.
3. Reduce the flame height to the minimum level necessary to perform the desired cooking process. Remember that food cooks just as quickly at a gentle boil as it does at a vigorous, rolling boil. Maintaining a higher boil than is necessary wastes energy, cooks away moisture, and causes a loss in food flavor and nutrient level.

ENERGY SAVING TIPS

- Always use utensils with flat, smooth bottoms and tight-fitting lids to retain heat and moisture.
 - Minimize the amount of liquid or fat to reduce cooking times.
 - Select cookware of the proper size, material and construction for the cooking process being performed.
 - Adjust the flame height to fit the utensil size.
 - After liquid reaches a boil, reduce the heat to maintain a simmer rather than a rolling boil.
 - Use a timer rather than repeatedly removing the lid to check food.
 - Thaw foods prior to cooking to reduce cooking time.
-

BEFORE SETTING OVEN CONTROLS

Installing and Removing Oven Rack Supports

ALWAYS INSTALL OVEN RACK SUPPORT BEFORE TURNING ON THE OVEN (WHEN THE OVEN IS COOL).

To install oven rack support, align and insert the 2 rear tabs of the rack supports to the rear holes in the oven side wall. Then align the 2 front tabs of the rack support to the front holes in the oven side wall. Push in on rack supports to secure in wall.

Figure 13

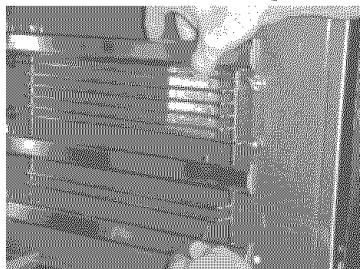

Figure 14



To remove the oven rack support for a self-clean cycle, support and lift front bottom of rack support to release front tabs. Then, rotate rack support up and out to release rear tabs. If the rack supports are not removed, the self-clean cycle won't start.

Figure 15



Removing and Replacing Oven Racks

ALWAYS ARRANGE OVEN RACKS WHEN THE OVEN IS COOL (PRIOR TO OPERATING THE OVEN).

Always use oven mitts when using the oven.

To remove an oven rack, pull the rack forward. Lift up the rack off the oven rack glides. **To install an oven rack**, locate the two pinholes in the small plates at the front corners of the rack. Position the back of the rack on the rack glides and drop the pin holes over the pins on the rack glides.

Pull oven rack forward and lift it up off the oven rack glides.

Figures 16-18

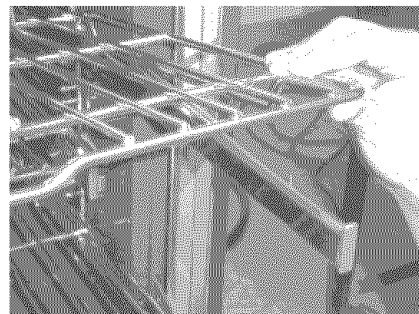
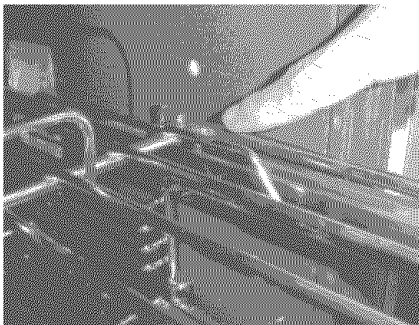
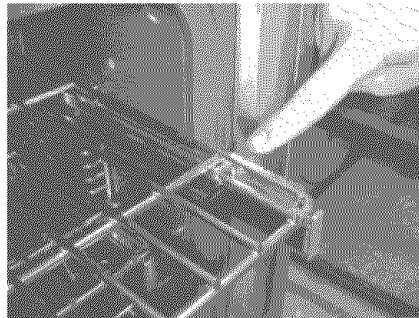

Arranging Oven Racks

ALWAYS ARRANGE OVEN RACKS WHEN THE OVEN IS COOL (PRIOR TO OPERATING THE OVEN). Three chrome-plated Smooth-Glide™ oven racks and one chrome plated conventional oven rack are provided with your range.

To bake on a single rack, place the rack in position 3. To bake on 2 racks, place the racks in position 2 and 7. To bake on 3 racks, place the racks in position 1, 3 and 7. See Figure 19.

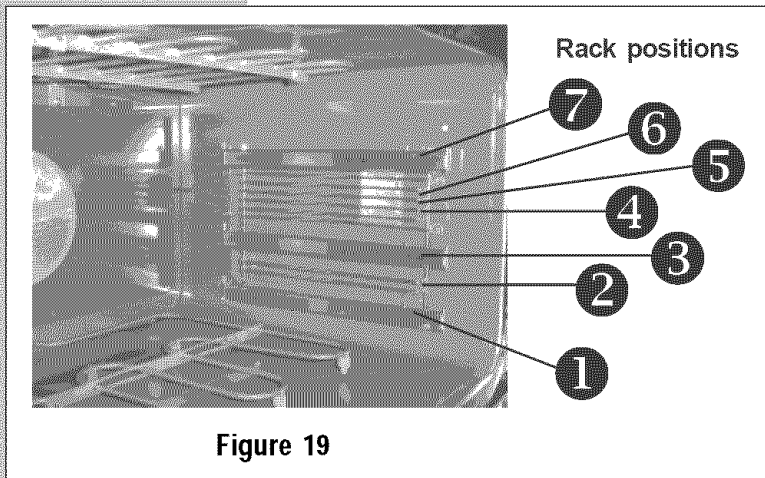

Figure 19

RECOMMENDED RACK POSITIONS FOR BROILING, BAKING & ROASTING

Food	Rack Position
Broiling meats, chicken or fish	5, 6 or 7
Cookies, cakes, pies & muffins	3 or 4
Frozen pies, angel food cake, yeast, bread, casseroles, small cuts of meat or poultry	2
Turkey, roast or ham	1

Note: Always use caution when removing food.

Baking Layer Cakes with 1 or 2 Oven Racks

For best results when baking cakes or cookies using 2 oven racks, place cookware on rack positions 2 and 7 (see figure 20). For best results when using a single oven rack, place cookware on rack position 3 (see figure 21).

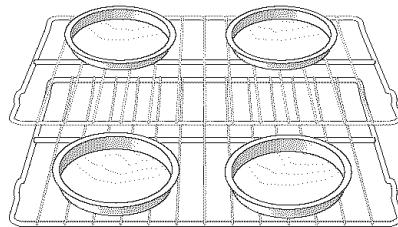

Figure 20

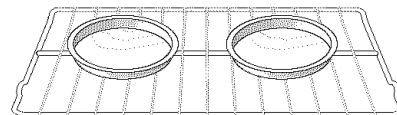

Figure 21

Air Circulation in the Oven

For best air circulation and baking results allow 2-4" (5-10 cm) around the cookware for proper air circulation and be sure pans and cookware do not touch each other, the oven door, sides or back of the oven cavity. The hot air must be able to circulate around the pans and cookware in the oven for even heat to reach around the food.

COMPANION OVEN (FOR E48DF76EPS)

The E48DF76EPS includes a companion oven, which is a fully featured, self-cleaning, convection oven. Following are a few notes about cooking in this oven:

- Since the oven's capacity is much smaller, you may find that cook times are slightly faster. Items cook faster in this oven as far as roasting and baking.
- Follow the same guidelines as the large oven on selecting baking modes for best results.
- When broiling food, position food 4-6 inches from broil element. Preheat the broil element for 5 to 10 minutes for best results.
- There are 5 heights for positioning the oven racks on the porcelain rack supports. Three chrome-plated racks are provided for this oven.
- A 9"x12" or 10"x14" cooking utensil is recommended for use in this oven. This includes baking sheets and pans for multiple rack convection baking.

NOTE: Oven racks should be removed when using the Self-Clean feature. The porcelain oven rack supports DO NOT need to be removed.

24 Setting Oven Controls

SELECTOR KNOB FUNCTIONS

Read the instructions carefully before using the oven. For satisfactory use of your oven, become familiar with the various functions of the oven as described below.

Figure 22

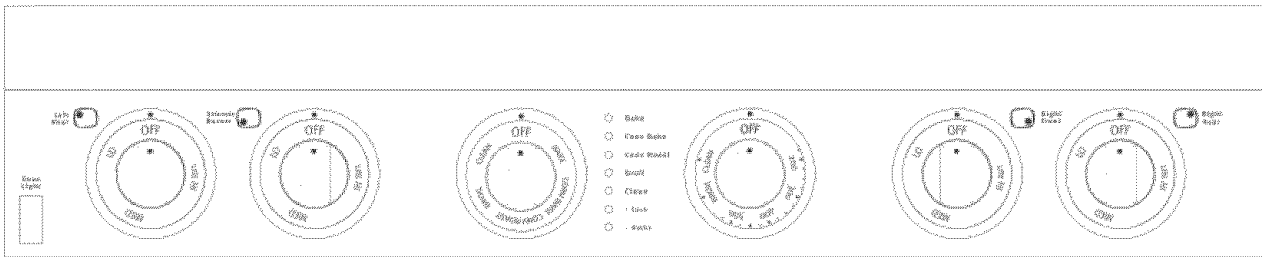

E30DF74EPS

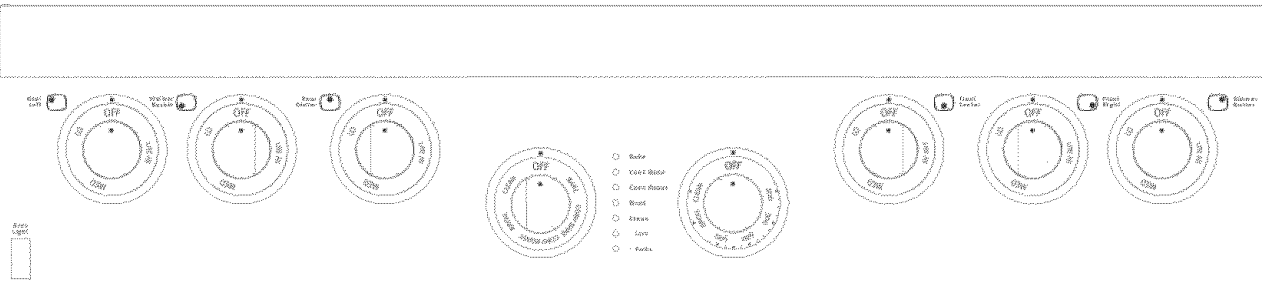

E36DF76EPS

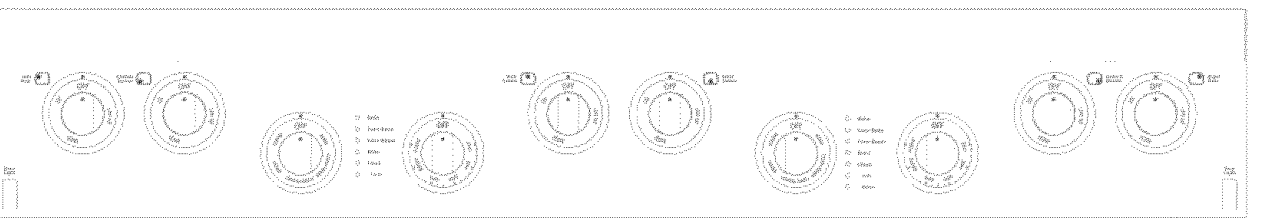

E48DF76EPS

OVEN FUNCTIONS

All oven functions are described below:

Standard Bake-With the Standard Bake function, the bottom heat element provides conventional baking heat.

Temperatures may be set from 170° F to 500° F. Use Standard Bake for single rack baking or roasting.

Convection Bake-With the Convection Bake function, a third heating element, encircling the convection fan located in the rear of the oven chamber, acts as the heat source. The convection fan draws air from the oven chamber, then forces it across the hot convection heating element. The heated air is directed back onto the oven chamber through the convection baffle. The baffle distributes the heated air evenly to ensure uniform results. Temperatures may be set from 170° F to 500° F. Use this function for single rack baking, multiple rack baking, roasting, and preparation of complete meals.

Convection Roast - In this combination convection/radiant function, the bake, broil and convection elements provide the heat. As in Convection Bake, the convection fan and baffle combine to circulate the heated air evenly throughout the oven chamber. Temperature may be set from 170° F to 500° F. Use this function for roasting.

Standard Broil - The high wattage, top heating element supplies the heat when using the broil function. **Broiling is performed with the oven door closed.**

Self Clean - With the pyrolytic Self Clean function, the oven reaches extreme high temperatures, thereby burning off oven soil automatically. The Self Clean time is 3 hours.

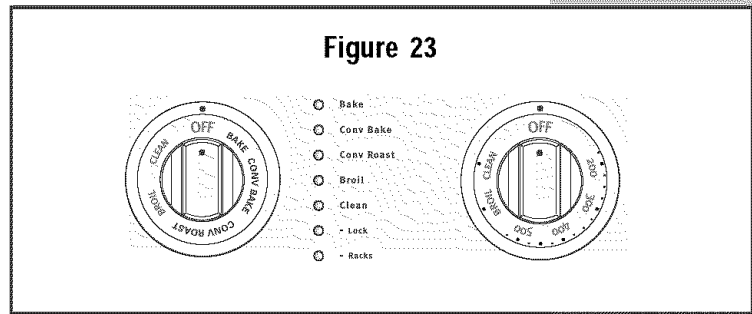

26 Cooking Instructions

BAKING

This cooking mode is for normal baking, roasting or warming. The temperature control knob can be set at any temperature from 170°F to 500°F.

To set the Bake Temperature to 350°F:

1. Arrange interior oven racks to desired positions.
2. Turn selector knob to Bake.
3. The corresponding LED light will flash.
4. Turn temperature control knob to 350°F.
5. The LED light will stop flashing and the oven will begin to preheat.

A beep will sound once the oven temperature reaches 350°F.

The LED light will remain on until the Selector knob is turned to the **off** position or the temperature control knob is turned to the **off** position.

To change the Bake temperature (example changing from 350°F to 425°F):

- 1 After the oven has already been set at 350°F, and the oven temperature needs to be changed to 425°F, turn the temperature control knob to 425°F. A beep will sound when the oven temperature reaches 425°F.

BAKING PROBLEMS

For best cooking results preheat the oven before baking cookies, breads, cakes, pies or pastries, etc... There is no need to preheat the oven for roasting meats or baking casseroles. The cooking times and temperatures needed to bake a product may vary slightly from your previous appliance.

Baking Problems and Solutions Chart		
Baking Problems	Causes	Solutions
Cookies and biscuits burn on the bottom.	<ul style="list-style-type: none"> • Cookies and biscuits put into the oven before the preheating time is completed. • Oven rack overcrowded or rack position too low. • Dark pan absorbs heat too fast. 	<ul style="list-style-type: none"> • Allow oven to preheat to the selected temperature before placing food in oven. • Choose pan sizes that will permit (2" to 4") of air space on all sides when placed in the oven. • Use a medium-weight aluminum baking sheet.
Cakes too dark on top or bottom.	<ul style="list-style-type: none"> • Cakes put into the oven before preheating time is completed. • Rack position too high or low. • Oven too hot. 	<ul style="list-style-type: none"> • Allow oven to preheat to the selected temperature before placing food in the oven. • Use proper rack position for baking needs. • Set oven temperature 25°F lower than recommended.
Cakes not done in the center.	<ul style="list-style-type: none"> • Oven too hot. • Incorrect pan size. • Pan not centered in oven. 	<ul style="list-style-type: none"> • Set oven temperature 25°F lower than recommended. • Use pan size suggested in recipe. • Use proper rack position and place pan so there is 2" to 4" of space on all sides of pan.
Cakes not level.	<ul style="list-style-type: none"> • Wall oven not level. • Pan too close to oven wall or rack overcrowded. • Pan warped. 	<ul style="list-style-type: none"> • Place a marked glass measuring cup filled with water on the center of the oven rack. If the water level is uneven, refer to the installation instructions for leveling the wall oven. • Be sure to allow 2" to 4" of clearance on all sides of each pan in the oven. • Do not use pans that are dented or warped.
Foods not done when cooking time is up.	<ul style="list-style-type: none"> • Oven too cool. • Oven overcrowded. • Oven door opened too frequently. 	<ul style="list-style-type: none"> • Set oven temperature 25°F higher than suggested and bake for the recommended time. • Be sure to remove all pans from the oven except the ones to be used for baking. • Open oven door only after shortest recommended baking time.

CONVECTION BAKING

As a general rule, convection baking will allow preparation of most foods at reduced temperatures for shorter periods of time, while producing superior results.

Typically, you can reduce standard bake temperatures by 25°F and cook for 10% to 25% less time. **When using the convection bake mode, the temperature is automatically reduced by the electronic oven control**, so the oven cooking temperature should be set to the temperature the recipe recommends.

In the convection bake mode, a third heating element, encircling the convection fan located in the rear of the chamber, acts as the heat source. The convection fan draws air from the oven chamber, and then forces it across the hot convection element. The heated air is directed back into the chamber through the convection baffle. The baffle distributes the air evenly to ensure uniform results. Temperatures may be set from 170°F to 500°F.

General Convection Bake Instructions

- 1 When using convection bake, decrease your normal cooking time by 25% to start. Time reductions will vary depending on the amount and type of food to be cooked.
- 2 Baking pans with no sides or very low sides should be used to bake on so heated air can be allowed to circulate around the food. Food baked on a darker finish will cook faster.

To set the oven for Convection Bake and temperature to 350°F:

- 1 Arrange oven racks to desired position.
- 2 Turn selector knob to Convection Bake.
- 3 The corresponding LED light will flash.
- 4 Turn temperature control knob to 350°F.
- 5 The LED light will stop flashing, and the oven will begin to preheat. A beep will sound once the oven temperature reaches 350°F. The LED light will remain on until the Selector knob is turned to the **off** position or the temperature control knob is turned to the **off** position.

To change the Convection Bake temperature (example changing from 350°F to 425°F):

- 1 After the oven has already been set at 350°F, and the oven temperature needs to be changed to 425°F, turn the temperature control knob to 425°F. A beep will sound when the oven temperature reaches 425°F.
-

CONVECTION ROASTING

All baking modes can be used to successfully roast in your oven. However, the Convection Roast mode is recommended to produce meats that are deliciously seared on the outside and succulently juicy on the inside in record time.

Foods that are exceptional, when prepared in the Convection Roast mode include: beef, pork, ham, lamb, turkey chicken and Cornish hens.

When preparing meats for convection roasting, use the broiler pan and insert along with the roasting rack. The roasting rack will allow the heat to circulate around the meat.

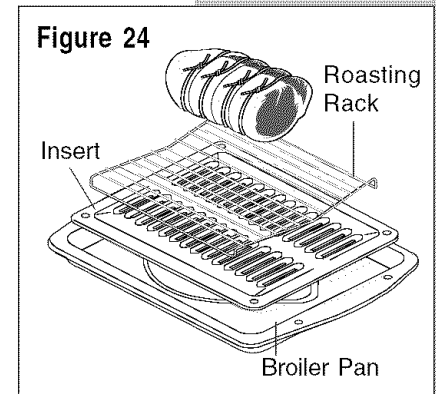

General Convection Roast Instructions

- 1 When using convection roast, decrease your normal cooking time by 25% to start. Time reductions will vary depending on the amount and type of food to be cooked.
- 2 Using a roasting rack, always roast meats fat side up in a shallow pan. Always use a pan that fits the size of the food being prepared. The broiler pan and insert can be used in most cases. No basting is required when the fat side is up. Do not add water to the pan. It will cause a steamed effect. Roasting is a dry heat process.
- 3 Poultry should be placed breast side up, on a rack in a shallow pan that fits the size of the food. Again, the broiler pan and insert accompanying the oven can be used. Poultry can be basted with butter, margarine or oil before and during roasting.
- 4 For Convection Roasting, pans with tall sides are not recommended. They interfere with the circulation of heated air over the food.
- 5 When using a meat thermometer, insert the probe half way into the center of the thickest portion of the meat. (For poultry, insert the thermometer probe between the body and leg into the thickest part of the inner thigh). To ensure an accurate reading, the tip of the probe should not touch the bone, fat or gristle. Check the meat thermometer 2/3 of the way through the recommended roasting time. After reading the meat thermometer once, insert it a 1/2 inch further, then take a second reading. If the second reading registers below the first, continue cooking the meat.
- 6 Remove meats from the oven when the thermometer registers 5°F to 10°F below the desired temperature. The meat will continue to cook after removal. Allow 15 to 20 minutes after roasting in order to make carving easier.

- 7 Convection Roast is not recommended for meats or poultry cooked with a cooking bag, foil tent or other cover. Food cooked with these methods will produce better results when using the Bake mode.
- 8 Roasting times will always vary according to the size, shape and quality of meats and poultry. Less tender cuts of meat are best prepared in the Bake mode and may require moist cooking techniques. Follow your favorite cookbook recipes.
- 9 Reduce spatter by lining the bottom of the roasting pan with lightly crushed aluminum foil.

To set the oven for Convection Roast and temperature to 350°F:

- 1 Arrange oven racks to desired position.
- 2 Turn selector knob to Convection Roast.
- 3 The corresponding LED light will flash.
- 4 Turn temperature control knob to 350°F.
- 5 The LED light will stop flashing, and the oven will begin to heat.

NOTE

THERE IS NO AUTOMATIC PREHEAT WITH THIS MODE.

The LED light will remain on until the Selector knob is turned to the **off** position or the temperature control knob is turned to the **off** position.

To change the Convection Roast temperature (example changing from 350°F to 425°F):

- 1 After the oven has already been set at 350°F, and the oven temperature needs to be changed to 425°F, turn the temperature control knob to 425°F.
-

BROILING

Broiling is a method of cooking tender cuts of meat by direct heat under the broil element of the oven. Broiling in the oven is accomplished with the oven door closed. It is normal and necessary for some smoke to be present to give the food a broiled flavor.

Preheating

Preheating is suggested when searing rare steaks. (Remove the broiler pan before preheating. Foods will stick if placed on hot metal.) To preheat, set the control to BROIL. Wait for the element to become red-hot, usually about 2 minutes. Preheating is not necessary when broiling meats well-done.

To Broil

Broil one side until the food is browned; turn and cook on the second side. Season and serve. Always pull the rack out to the "stop" position before turning or removing food.

Broiling Tips

The broiler pan and its insert allow dripping grease to drain and be kept away from the high heat of the broiler.

Broiling Times

Use the following table for approximate broiling times. Increase or decrease broiling times, or move the broiling pan to a different rack position to suit for doneness. If the food you are broiling is not listed in the table, follow the instructions provided in your cookbook and watch the item closely.

Oven Broiling Recommendations					
Food Item	Rack Position	Knob Setting	Cook Time		Doneness
			1st side	2nd side	
Steak 1" thick	6 or 7	BROIL	6:00	4:00	Rare
	6 or 7	BROIL	7:00	5:00	Medium
Pork Chops 3/4" thick	6 or 7	BROIL	8:00	6:00	Well
Chicken - Bone In	4	BROIL	20:00	10:00	Well
Chicken - Boneless	6 or 7	BROIL	8:00	6:00	Well
Fish	6 or 7	BROIL	13:00	n/a	Well
Shrimp	4	BROIL	5:00	n/a	Well
Hamburger 1" thick	6 or 7	BROIL	9:00	7:00	Medium
	4	BROIL	10:00	8:00	Well

NOTE

DO NOT use the broiler pan without its insert. **DO NOT** cover the broiler pan insert with foil. The exposed grease could ignite.

⚠ CAUTION

Should an oven fire occur, turn off the oven. If the fire continues, throw baking soda on the fire or use fire extinguisher. **DO NOT** put water or flour on the fire. Flour may be explosive.

Setting Broil

The selector knob controls the Broil feature. When broiling, heat radiates downward from the oven broiler for even coverage. The Broil feature temperature is 500°F.

The broil pan and broil pan insert used together allow dripping grease to drain and be kept away from the high heat of the oven broiler. **DO NOT** use the broil pan without the insert. **DO NOT cover the broil pan insert with foil.** The exposed grease could catch fire.

WARNING

Should an oven fire occur, leave the oven door closed and turn off the oven. If the fire continues, throw baking soda on the fire or use a fire extinguisher. DO NOT put water or flour on the fire. Flour may be explosive and water can cause a grease fire to spread and cause personal injury.

To set the oven to broil:

- 1 Place the broiler pan insert on the broiler pan. Then place the food on the broiler pan insert. **DO NOT** use the broiler pan without the insert. **DO NOT** cover the broiler insert with foil. The exposed grease could ignite.
- 2 Arrange the interior oven rack and place the broiler pan on the rack. Be sure to center the broiler pan directly under the broiler element. If preheating the broil element first, position the broiler pan with food after step 5.
- 3 Turn selector knob to Broil.
- 4 The corresponding LED light will flash.
- 5 Turn temperature knob to Broil.

The LED light will remain on until the selector knob is turned to the off position or the temperature control knob is turned to the off position.

Broiler Clean-Up Tips:

To make cleaning easier, line the bottom of the broiler pan with aluminum foil. **DO NOT** cover the broiler pan insert with foil.

To prevent grease from baking on, remove the broiler pan from the oven as soon as cooking is completed. Use hot pads because the broiler pan is extremely hot. Pour off grease. Soak the pan in **HOT**, soapy water. The broiler pan and insert can be cleaned in your dishwasher.

Clean the broiler pan as soon as possible after each use. If necessary, use soap-filled steel wool pads. Heavy scouring may scratch the broiler pan insert.

USING THE OVEN SELF-CLEAN FEATURE

Adhere to the Following Cleaning Precautions:

- Allow the oven to cool before cleaning.
- Wear rubber gloves when cleaning any exterior parts of the oven manually.

CAUTION

During the Self-Cleaning cycle, the outside of the range can become very hot to the touch. **DO NOT** leave a small children unattended near the appliance.

Before cleaning any part of the oven, be sure the oven is turned off . Wait until the oven is cool.

CAUTION

The health of some birds is extremely sensitive to the fumes given off during the Self-Clean cycle of any range. Move birds to another well ventilated room.

DO NOT use oven cleaners or oven protective coatings in or around any part of the Self-Cleaning oven. **DO NOT** clean the oven door gasket. The gasket on the oven door is essential for a good seal. Care should be taken not to rub, damage or move the gasket. **DO NOT** use any cleaning materials on the gasket. Doing so could damage it. **DO NOT** use **aluminum foil** to line the oven bottom. This may affect cooking or foil could melt and damage the oven surface.

Preparing the Oven for Self-Cleaning

1. **Remove any excess spillovers** in the oven cavity **before** starting the Self-Cleaning cycle. To clean, use hot soapy water and a cloth. Large spillovers can cause smoke or a fire when subjected to high temperatures. **DO NOT** allow food spills with a high sugar or acid content (such as tomatoes, sauerkraut, fruit juices or pie filling) to remain on the surface as they may leave a dull spot even after cleaning.
2. Clean any soil from the oven frame and the door liner. These areas heat sufficiently during a self-clean to burn soil on. Clean with hot soapy water.
3. Remove the broiler pan and insert, all utensils and any foil. These items cannot withstand high cleaning temperatures.
4. Oven racks and oven rack supports must be removed. If they are not removed, the Self-Cleaning cycle cannot start and the “- Racks” LED will begin to flash indicating that you must remove the racks and racks glides with the supports before starting the clean cycle. The convections filter also needs to be removed. When the cycle has finished and the door can be opened, replace the oven rack glides with supports, oven racks and convection filter.

NOTE: For model E48DF76ESP, the racks and convection filter need to be removed from the companion oven. Self-Clean can only be run in the large oven or the companion oven separately. The Self-Clean cycle can not be run simultaneously in both ovens.

STARTING THE OVEN SELF-CLEAN CYCLE

The selector knob controls the Self-Cleaning feature. If you are planning to use the oven immediately after a self-clean cycle remember to allow time for the oven to cool down and the oven door to unlock. This normally takes about one hour. A 3-hour self-clean cycle will actually take about 4 hours to complete.

WARNING

During the Self-Cleaning cycle, the outside of the appliance can become very hot to the touch. **DO NOT** leave small children unattended near the appliance; they may be burned if they touch the hot oven door surfaces.

WARNING

DO NOT force the oven door open. This can damage the automatic door locking system. Use care when opening the oven door after the self-cleaning cycle. Stand to the side of the oven when opening the door to allow hot air or steam to escape. The oven may still be **VERY HOT**.

To start a Self-Cleaning cycle:

1. Be sure oven is empty and the oven door is closed.
2. Turn selector knob to Self Clean.
3. The corresponding LED will flash.
4. Turn temperature knob to Clean.
5. The LED for "Lock" will flash while transitioning from unlock to lock. It will stop flashing when the door is locked.

NOTE

If the "Racks" LED is flashing when the clean mode is initiated, the oven racks and rack glides with supports have not been removed. It will discontinue flashing, once the selector knob is set back to the off position and the racks and rack glides with supports are removed from the oven (not applicable to model E48DF76EPS companion oven).

6. As soon as the controls are set to clean, the motor driven oven door lock will begin to close automatically. Once the door has been locked the indicator light will stop flashing and remain on. Allow about 30 seconds for the oven door lock to close.

CLEANING TIPS FOR RANGE COOKTOP

No maintenance, other than the **Care and Cleaning** identified in this **Use & Care Manual**, should be attempted by the owner/operator. All other maintenance and service must be performed by a qualified appliance technician.

WARNING

To avoid electrical shock or burns, turn off all controls and ensure the cooktop is cool before cleaning.

IMPORTANT

Do not use harsh or abrasive cleaning agents, waxes, polishes, or commercial cooktop cleaners to clean the cooktop.

Read and follow the **Care and Cleaning** instructions to ensure that proper cooktop operation and appearance will be maintained throughout the lifetime of the product. Several materials and finishes are used in the cooktop. Each material and finish must be properly cleaned according to the following recommendations. Failure to follow these recommendations may result in permanent damage to the cooktop.

WARNING

- Before cleaning the cooktop, ensure that all burners are turned off and that all components are cool enough to safely touch.
- After cleaning, reassemble all components before attempting to operate the cooktop.

Proper cleaning is necessary to maintain cooktop performance and appearance, while also ensuring safe operation. The cleaning effort necessary to maintain the cooktop varies according to the type and amount of cooking. For example, more frequent cleaning is required if the cooktop is used often for frying or other high temperature operations.

Clean the cooktop thoroughly prior to operating it the first time. For initial and everyday cleaning, use a soft cloth or sponge lightly dampened with a solution of warm water and hand dishwashing liquid to clean all components.

Recommendations for cleaning and care of specific cooktop components are summarized below:

IMPORTANT

The grates and burner caps, unlike other porcelain enamel appliances in your home, are exposed to extremely high temperatures in a matter of seconds. In addition to this extreme thermal shock, the grates are subjected to mechanical shock when utensils are placed on or slid across them. Finally, spillovers introduce foods with high acidity to all of the porcelain components. *Due to these severe operating conditions, all porcelain enamel components on the cooktop will undergo an inevitable change in appearance with use.* Meticulous care and cleaning will slow but not eliminate this natural and expected aging process.

Treating the porcelain components with care will slow the natural deterioration that takes place with cooktop use. Please follow these guidelines to keep the porcelain parts looking their best:

1. Do not use utensils having rough bottoms, as this can result in permanent damage to the top surfaces of the porcelainized grates.
2. Do not drop utensils onto the grates or drag heavy pots across the tops of the grates.
3. Set the grates into the locating dimples gently. Do not drop the grates into place.
4. Use caution when cooking to avoid spills as much as possible. Porcelain is acid-resistant but not acid-proof, so some foods can cause permanent damage if allowed to remain on porcelain surfaces.

Daily cleaning of the grates, burner heads, and burner caps is best accomplished with a soft cloth or sponge dampened in a solution of warm water and hand dishwashing liquid. Grates are dishwasher safe. Burner caps should not be cleaned in the dishwasher.

Stubborn stains may be removed by applying full-strength, all purpose cleaning sprays. (If you are unable to locate these cleaning compounds, please phone the Electrolux Customer Service Department for a referral.)

Mildly abrasive cleaners or applicators, such as soap-filled steel wool pads, may be used with extreme care on occasion to remove the most serious stains. **Exercise caution – extensive use of abrasives will eventually damage the porcelain enamel surface.**

CLEANING STAINLESS STEEL SURFACES

Clean these surfaces with the provided Stainless Steel Cleaner. Rinse and dry with a soft lint-free cloth.

IMPORTANT

If commercially available stainless steel cleaners are used, it is important to read the labels for chlorine compounds. Chlorine is a corrosive substance. If these compounds are present, rinse thoroughly and dry with a soft lint-free cloth.

Always wipe stainless steel surfaces with the grain.

CLEANING PORCELAIN GRATES

Clean the porcelain grates with a solution of mild detergent and hot water. Rinse with a soft cloth. Do not use abrasives or commercial oven cleaners.

Stubborn stains may be removed by washing the grates in a dishwasher, using normal dishwashing detergent.

IMPORTANT

Never use the cooktop surface as a cutting board.

Do not use abrasive cleaners or applicators on the cooktop.

Do not try to remove heavy spills with a sharp object such as a knife or metal spatula. Sharp objects may scratch the cooktop.

A small amount of baby oil may be applied to stainless steel tops to restore the lustre.

CLEANING KNOBS AND KNOB BEZELS

The control knobs provided with this cooktop are designed for ease of use and longevity. The “D” shaped design of the knob shaft ensures proper orientation when reinstalling the knob and knob bezels.

The knobs are made of a composite plastic. These components should be washed regularly in warm, soapy water. Hand dishwashing liquid is excellent for this task. Knobs should be removed by gently pulling them straight out and off of the valve shafts. Use caution to avoid introduction of moisture into the control panel behind the bezels. To replace knobs, align the “D-shaped” opening at the bottom of the knob with the “D-shaped” valve shaft, then carefully press the knob onto the valve.

CLEANING BURNER BASES

The burner base is permanently attached to the cooktop. The base should be wiped clean using a soft cloth or sponge that has been lightly dampened with warm water and hand dishwashing liquid. Thoroughly clean and dry the igniters to prevent constant sparking of the reignition system. Refer to the **Cleaning the Burner Igniters** section for cleaning tips.

IMPORTANT

- Turn the knobs to the “OFF” position prior to removing them from the valve stems.
- The cooktop should never be operated without the knobs in place.
- Do not soak the knobs in water or place them in the dishwasher.
- Do not expose the knobs to direct flame, hot utensils, or other sources of heat.
- Do not use abrasive or corrosive cleaners or applicators, as these could cause permanent damage.

CLEANING BURNER RINGS

The brass burner rings spread the flame evenly around the burner perimeters. The burner rings must seat properly in the burner bases to enable proper cooktop operation. To ensure proper seating, positioning tabs have been placed on the bottom of each burner ring to slide into corresponding notches in the fixed burner base.

To remove the burner ring, first remove the grate, then lift off the porcelain burner cap. The burner ring may then be removed from the burner base. Soak the burner ring in a warm solution of hand dishwashing liquid and water, then rinse well with clean water. Dry the burner thoroughly.

Stubborn stains may be removed by applying a metal polishing compound. (If you are unable to locate this type of polishing compound, please phone the Electrolux Customer Service Department for a referral.)

CLEANING THE BURNER IGNITERS

Under certain cooking or cleaning conditions, your cooktop igniters may become coated with or corroded by food deposits, splattered grease or cleaning agents. **This condition can cause erratic or continuous sparking.** Keeping the igniters clean and dry will help to reduce this problem. To avoid unnecessary and costly service calls, the homeowner should perform periodic cleaning of the igniters.

To clean the igniters:

1. Be sure the burners are cool to the touch. Remove the grate, burner cap and burner heads.
2. Clean completely around the igniter, including over and under the edge of the metal cap and base. Use care while cleaning here. Parts of the igniter are porcelain and can be fragile.
3. **DO NOT USE WATER** when cleaning the igniters. If a liquid must be used to clean the igniter effectively, use only a small amount of rubbing alcohol.
4. After cleaning, reinstall the burner ring, burner cap and grate. Make sure the brass burner ring is properly seated into the burner base.
5. Test the burners. If erratic clicking is still present, make sure the igniter is completely dry.

If the unit still exhibits problems after drying, please phone the Electrolux Customer Service Department for further assistance.

GENERAL CLEANING

Cleaning Various Parts of Your appliance

Before cleaning any part of the appliance, be sure all controls are turned OFF and the appliance is COOL. REMOVE SPILLOVERS AND HEAVY SOILING AS SOON AS POSSIBLE. REGULAR CLEANING WILL REDUCE THE NUMBER OF MAJOR CLEANINGS LATER

Surfaces	How to Clean
Painted and Plastic Body Parts and Decorative Trim	<p>Using a soft cloth, clean with mild dish detergent and water or a 50/50 solution of vinegar and water. Follow by rinsing the area with clean water; dry and polish with a soft cloth.</p> <p>Glass cleaners may be used if sprayed on a soft cloth first. DO NOT spray liquids directly on the control pad and display area. Do not use large amounts of water on the control panel - excess water on the control area may cause damage to the appliance.</p> <p>Do not use other liquid cleaners, abrasive cleaners, scouring pads, or some paper towels - they will damage the finish.</p>
Control Panel	<p><i>Before cleaning the control panel</i>, turn all controls to OFF. Glass cleaners may be used if sprayed on a soft cloth first. DO NOT spray liquids directly on the control pad and display area. Wipe with a soft cloth or paper towel. DO NOT use abrasive cleaners or scouring pads. These can permanently damage the control panel surface.</p>
Porcelain Enamel Broiler Pan, Broiler Pan Insert and Cooktop Spill Tray	<p>Gentle scouring with a soapy scouring pad will remove most spots. Rinse with a 1:1 solution of clear water and ammonia. <i>If necessary</i>, cover difficult spots with an ammonia-soaked paper towel for 30 to 40 minutes. Rinse with clean water and a damp cloth, and then scrub with a soap-filled scouring pad. Rinse and wipe dry with a clean cloth. Remove all cleaners or the porcelain may become damaged during future heating.</p>
Stainless Steel, Chrome Decorative Trim, Oven Racks, Oven Racks Support	<p>Clean with hot, soapy water and a dishcloth. Rinse with clean water and a cloth. Cover stubborn spots with an ammonia-soaked paper towel for 30 to 40 minutes. Rinse. Cleaners made especially for stainless steel are recommended. Be sure to rinse the cleaners as bluish stains may occur during heating and cannot be removed.</p>
Oven Racks	<p>Oven racks and oven rack supports must be removed from the oven during the self-clean cycle for cleaning. If they are not removed, the self-clean cycle will not start. Clean them as described above.</p>
Oven Door	<p>To clean oven door, wash with hot, soapy water and a clean cloth. DO NOT immerse the door in water or clean the oven door gasket. DO NOT use abrasive cleaners on the inside of the oven door glass.</p>
Oven Door Gasket	<p>The oven door gasket is located on the oven door and visible when the door is opened. This gasket is essential for a good seal. Care should be taken not to rub, damage or remove the gasket.</p>

OVEN LIGHT

Your new range has halogen oven lights to enhance the view into the oven. The light assembly consists of a removable lens cover and 20-watt 120VAC halogen bulb (OSRAM - Part Number 64428), as well as a light fixture housing. Light bulb replacement is considered to be a homeowner maintenance operation.

WARNING

To prevent electrical shock and/or personal injury:
Make certain that the oven and light bulb are cool and that power to the oven has been turned off before replacing the light bulb.
Always ensure that the lens cover is in place when using the oven. The lens cover protects the bulb from breakage caused by high oven temperatures or mechanical shock.

To replace the light bulb:

1. Turn off the power at the main power supply.
2. Remove rack supports in order to access the light housing.
3. Remove the lens cover from the housing by pulling straight out.
4. Replace halogen bulb taking care not to touch the bulb. If you touch the halogen bulb with your finger, body oils can shorten the bulb life.
5. To replace glass shield, reverse the procedure.

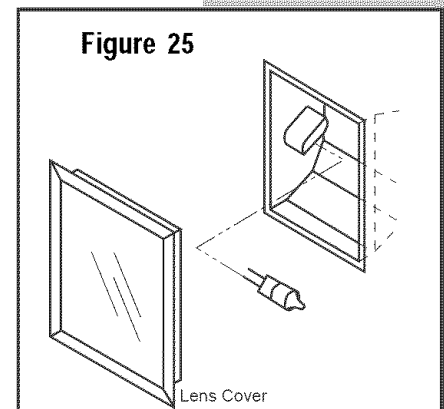

PROBLEM	POSSIBLE CAUSE	SOLUTION
Nothing works.	Oven is not connected to electrical power	Have oven connected to a properly sized electrical power supply by a qualified technician.
	Power supply is not energized.	Have an electrician check power supply, including the house circuit breaker, wiring and fuses.
Oven will not heat.	Oven settings are not correct.	Follow mode selection and temperature settings as specified in OVEN OPERATION.
Foods overcooked.	Incorrect cooking time, temperature.	Adjust time, temperature or rack position.
Oven does not Self-Clean.	Door is not closed tightly, so the automatic door latch will not lock.	Close door tightly.
	Oven control knob set incorrectly.	Follow mode selection and temperature settings specified for SELF-CLEAN.
Oven light will not work.	Light bulb is burned out.	Follow REPLACING THE OVEN LIGHT.
Door will not open.	Oven is in Self-Clean mode.	If oven is hot, door latch will release automatically when oven temperature falls below 490°F at end of cycle.
Oven will not heat after Self-Clean.	Oven settings not correct.	Follow mode selection and temperature settings as specified in OVEN OPERATION
Igniters do not spark.	Circuit breaker is tripped.	Reset circuit breaker
	House fuse is blown.	Replace house fuse.
	Power outage in local area.	Contact power company.
Sparkling but no flame ignition	Gas shut-off valve is in the "off" position.	Turn shut-off to "on" position.
	Gas supply is interrupted.	Contact gas company.
Burners ignite but flame is extremely large, distorted or yellow.	Burner ring ports are clogged.	Clean burner ring ports with straightened paper clip, needle or wire.
	Burner ports or burner caps are not positioned properly.	Remove and carefully re-install burner rings and caps.
	Cooktop is being operated on the wrong type of gas.	Ensure that the type of cooktop matches the gas supply (natural gas or L.P. gas)
	Regulator is not installed, is faulty or is set for the wrong type of gas.	Check installation, replace regulator, or set regulator for proper gas.
Burner flame goes out at low setting.	Low gas supply pressure.	Contact gas company.
Igniters spark continuously after flame ignition.	Power supply is not grounded.	Have power supply properly grounded.
	Power supply polarity is reversed.	Have polarity corrected.
	Igniters are wet or dirty.	Dry or clean igniters.

Service Failure Mode definitions are shown below:

Table 2 - Failure Mode Definition							
Front Panel LED							Failure Description
1	2	3	4	5	6	7	
x				x			Runaway Temperature
x					x		Incorrect Micro ID
x						x	Incorrect EEPROM Checksum
		x		x			Open Temperature Probe
		x			x		Shorted Temperature Probe
	x		x				Max Unlock Time Exceeded (Motor Door Latch)
	x			x			Max Unlock Attempts Exceeded (Motor Door Latch)
	x				x		Max Lock Time Exceeded (Motor Door Latch)
	x	x				x	Max Lock attempts Exceeded (Motor Door Latch)
	x	x	x				Motor Door Latch Fail During Clean Operation
			x				Inter- Processor Communications Failure (Motor Door Latch)
<u>LED Definitions</u>							
1 - Bake			5 - Clean				
2 - Convection Bake			6 - Lock				
3 - Convection Roast			7 - Remove Racks				
4 - Broil							

RANGE WARRANTY | *our range is protected by this warranty*

In the U.S.A., your appliance is warranted by Electrolux Home Products North America, a division of White Consolidated Industries, Inc. We authorize no person to change or add to any of our obligations under this warranty. Our obligations for service and parts under this warranty must be performed by us or an authorized Electrolux Home Products North America servicer. **In Canada**, your appliance is warranted by Electrolux Canada Corp.

	WARRANTY PERIOD	THROUGH OUR AUTHORIZED SERVICERS, WE WILL:	THE CONSUMER WILL BE RESPONSIBLE FOR:
FULL ONE-YEAR WARRANTY	One year from original purchase date	Pay all costs for repairing or replacing any parts of this appliance which prove to be defective in materials or workmanship.	Costs of service calls that are listed under NORMAL RESPONSIBILITIES OF THE CONSUMER. *
LIMITED WARRANTY (Applicable to the State of Alaska)	Time periods listed above.	All of the provisions of the full and limited warranties above and the exclusions listed below apply.	Costs of the technician's travel to the home and any costs for pick up and delivery of the appliance required because of service.

***NORMAL RESPONSIBILITIES OF THE CONSUMER**

This warranty applies only to products in ordinary household use, and the consumer is responsible for the items listed below:

1. Proper use of the appliance in accordance with instructions provided with the product.
2. Proper installation by an authorized servicer in accordance with instructions provided with the appliance and in accordance with all local plumbing, electrical and/or gas codes.
3. Proper connection to a grounded power supply of sufficient voltage, replacement of blown fuses, repair of loose connections or defects in house wiring.
4. Expenses for making the appliance accessible for servicing, such as removal of trim, cupboards, shelves, etc., which are not a part of the appliance when it was shipped from the factory.
5. Damages to finish after installation.
6. Replacement of light bulbs and/or fluorescent tubes (on models with these features).

EXCLUSIONS

This warranty does not cover the following:

1. CONSEQUENTIAL OR INCIDENTAL DAMAGES SUCH AS PROPERTY DAMAGE AND INCIDENTAL EXPENSES RESULTING FROM ANY BREACH OF THIS WRITTEN OR ANY IMPLIED WARRANTY.

NOTE: Some states do not allow the exclusion or limitation of incidental or consequential damages, so this limitation or exclusion may not apply to you.

2. Service calls which do not involve malfunction or defects in workmanship or material, or for appliances not in ordinary household use. The consumer shall pay for such service calls.
3. Damages caused by services performed by servicers other than Electrolux Home Products North America or its authorized servicers; use of parts other than genuine Electrolux Home Products parts; obtained from persons other than such servicers; or external causes such as abuse, misuse, inadequate power supply or acts of God.
4. Products with original serial numbers that have been removed or altered and cannot be readily determined.

IF YOU NEED SERVICE

Keep your bill of sale, delivery slip, or some other appropriate payment record. The date on the bill establishes the warranty period should service be required. If service is performed, it is in your best interest to obtain and keep all receipts. This written warranty gives you specific legal rights. You may also have other rights that vary from state to state. Service under this warranty must be obtained by contacting Electrolux Home Products:

USA**1-800-944-9044**

Electrolux Home Products
North America
P.O. Box 212378
Augusta, GA 30917

Canada**1-866-294-9911**

Electrolux Home Products
North America
802, boul. L'Ange-Gardien
L'Assomption, Québec
J5W 1T6

This warranty only applies in the 50 states of the U.S.A., Puerto Rico, and Canada. Product features or specifications as described or illustrated are subject to change without notice. All warranties are made by Electrolux Home Products North America, a division of White Consolidated Industries, Inc. **In Canada**, your appliance is warranted by Electrolux Canada Corp.