

KitchenAid®

MICROWAVE HOOD COMBINATION

Use & Care Guide

For questions about features, operation/performance, parts, accessories or service, call: **1-800-422-1230**,
or visit our website at... www.kitchenaid.com

Table of Contents..... 2



TABLE OF CONTENTS

MICROWAVE HOOD COMBINATION SAFETY	3
Electrical Requirements	4
PARTS AND FEATURES	5
Turntable	5
Cooking Rack	5
MICROWAVE OVEN CONTROL	6
Display	6
Start	6
Add a Minute	6
Off	6
Clock	6
Tones	6
Timer	7
Control Lock	7
Vent Fan	7
Cooktop Light	7
Demo Mode	7
MICROWAVE OVEN USE	7
Food Characteristics	7
Cooking Guidelines	8
Cookware and Dinnerware	8
Aluminum Foil and Metal	8
Microwave Cooking Power	9
Manual Cooking	9
Cooking in Stages (or steps)	9
Sensor Cooking	9
One Touch Cooking (Sensor)	10
Preset Cooking	10
Reheating	10
Defrosting	11
Keep Warm	12
MICROWAVE OVEN CARE	12
General Cleaning	12
Replacing Filters	13
Replacing Cooktop Light	13
Replacing Microwave Oven Light	13
TROUBLESHOOTING	14
ASSISTANCE OR SERVICE	15
Replacement Parts	15
WARRANTY	16

MICROWAVE HOOD COMBINATION SAFETY

Your safety and the safety of others are very important.

We have provided many important safety messages in this manual and on your appliance. Always read and obey all safety messages.



This is the safety alert symbol.

This symbol alerts you to potential hazards that can kill or hurt you and others.

All safety messages will follow the safety alert symbol and either the word “DANGER” or “WARNING.”

These words mean:

⚠ DANGER

You can be killed or seriously injured if you don't immediately follow instructions.

⚠ WARNING

You can be killed or seriously injured if you don't follow instructions.

All safety messages will tell you what the potential hazard is, tell you how to reduce the chance of injury, and tell you what can happen if the instructions are not followed.

IMPORTANT SAFETY INSTRUCTIONS

When using electrical appliances basic safety precautions should be followed, including the following:

WARNING: To reduce the risk of burns, electric shock, fire, injury to persons, or exposure to excessive microwave energy:

- Read all instructions before using the microwave oven.
- Read and follow the specific “PRECAUTIONS TO AVOID POSSIBLE EXPOSURE TO EXCESSIVE MICROWAVE ENERGY” found in this section.
- The microwave oven must be grounded. Connect only to properly grounded outlet. See “GROUNDING INSTRUCTIONS” found in this section and in the provided Installation Instructions.
- Install or locate the microwave oven only in accordance with the provided Installation Instructions.
- Some products such as whole eggs in the shell and sealed containers – for example, closed glass jars – are able to explode and should not be heated in the microwave oven.
- Use the microwave oven only for its intended use as described in this manual. Do not use corrosive chemicals or vapors in the microwave oven. This type of oven is specifically designed to heat, cook, or dry food. It is not designed for industrial or laboratory use.
- As with any appliance, close supervision is necessary when used by children.
- Do not operate the microwave oven if it has a damaged cord or plug, if it is not working properly, or if it has been damaged or dropped.
- The microwave oven should be serviced only by qualified service personnel. Call an authorized service company for examination, repair, or adjustment.
- See door surface cleaning instructions in the “Microwave Oven Care” section.
- To reduce the risk of fire in the oven cavity:
 - Do not overcook food. Carefully attend the microwave oven when paper, plastic, or other combustible materials are placed inside the oven to facilitate cooking.
 - Remove wire twist-ties from paper or plastic bags before placing bags in oven.
 - If materials inside the oven ignite, keep oven door closed, turn oven off, and disconnect the power cord, or shut off power at the fuse or circuit breaker panel.
 - Do not use the cavity for storage purposes. Do not leave paper products, cooking utensils, or food in the cavity when not in use.
- Liquids, such as water, coffee, or tea are able to be overheated beyond the boiling point without appearing to be boiling. Visible bubbling or boiling when the container is removed from the microwave oven is not always present. **THIS COULD RESULT IN VERY HOT LIQUIDS SUDDENLY BOILING OVER WHEN THE CONTAINER IS DISTURBED OR A SPOON OR OTHER UTENSIL IS INSERTED INTO THE LIQUID.**
 - To reduce the risk of injury to persons:
 - Do not overheat the liquid.
 - Stir the liquid both before and halfway through heating it.
 - Do not use straight-sided containers with narrow necks.
 - After heating, allow the container to stand in the microwave oven for a short time before removing the container.
 - Use extreme care when inserting a spoon or other utensil into the container.
- Oversized foods or oversized metal utensils should not be inserted in the microwave oven as they may create a fire or risk of electric shock.
- Do not clean with metal scouring pads. Pieces can burn off the pad and touch electrical parts involving a risk of electric shock.

SAVE THESE INSTRUCTIONS

IMPORTANT SAFETY INSTRUCTIONS

- Suitable for use above both gas and electric cooking equipment.
- Intended to be used above ranges with maximum width of 36" (91.44 cm).
- Clean Ventilating Hoods Frequently - Grease should not be allowed to accumulate on hood or filter.
- Do not use paper products when appliance is operated in the "PAN BROWN" mode (on models with this feature).
- Do not store any materials, other than manufacturer's recommended accessories, in this oven when not in use.
- Do not store anything directly on top of the microwave oven when the microwave oven is in operation.
- When flambeing foods under the hood, turn the fan on.
- Use care when cleaning the vent-hood filter. Corrosive cleaning agents, such as lye-based oven cleaners, may damage the filter.
- Do not cover or block any openings on the microwave oven.
- Do not store this microwave oven outdoors. Do not use the microwave oven near water - for example, near a kitchen sink, in a wet basement, or near a swimming pool, or similar locations.
- Do not immerse cord or plug in water.
- Keep cord away from heated surfaces.
- Do not let cord hang over edge of table or counter.
- Do not mount over a sink.
- Do not cover racks or any other part of the oven with metal foil. This will cause overheating of the oven.

SAVE THESE INSTRUCTIONS

PRECAUTIONS TO AVOID POSSIBLE EXPOSURE TO EXCESSIVE MICROWAVE ENERGY

- (a) Do not attempt to operate this oven with the door open since open-door operation can result in harmful exposure to microwave energy. It is important not to defeat or tamper with the safety interlocks.
- (b) Do not place any object between the oven front face and the door or allow soil or cleaner residue to accumulate on sealing surfaces.
- (c) Do not operate the oven if it is damaged. It is particularly important that the oven door close properly and that there is no damage to the:
 - (1) Door (bent),
 - (2) Hinges and latches (broken or loosened),
 - (3) Door seals and sealing surfaces.
- (d) The oven should not be adjusted or repaired by anyone except properly qualified service personnel.

Electrical Requirements

⚠ WARNING



Electrical Shock Hazard

- Plug into a grounded 3 prong outlet.
- Do not remove ground prong.
- Do not use an adapter.
- Do not use an extension cord.
- Failure to follow these instructions can result in death, fire, or electrical shock.

Observe all governing codes and ordinances.

Required:

- A 120 Volt, 60 Hz, AC only, 15- or 20-amp electrical supply with a fuse or circuit breaker.

Recommended:

- A time-delay fuse or time-delay circuit breaker.
- A separate circuit serving only this appliance.

GROUNDING INSTRUCTIONS

- **For all cord connected appliances:**
The microwave oven must be grounded. In the event of an electrical short circuit, grounding reduces the risk of electric shock by providing an escape wire for the electric current. The microwave oven is equipped with a cord having a grounding wire with a grounding plug. The plug must be plugged into an outlet that is properly installed and grounded.

WARNING: Improper use of the grounding plug can result in a risk of electric shock. Consult a qualified electrician or serviceman if the grounding instructions are not completely understood, or if doubt exists as to whether the microwave oven is properly grounded.

Do not use an extension cord. If the power supply cord is too short, have a qualified electrician or serviceman install an outlet near the microwave oven.

SAVE THESE INSTRUCTIONS

This device complies with Part 18 of the FCC Rules.

PARTS AND FEATURES

This manual may cover several different models. The model you have purchased may have some or all of the features shown here. The appearance of your particular model may differ slightly from the illustrations in this manual.

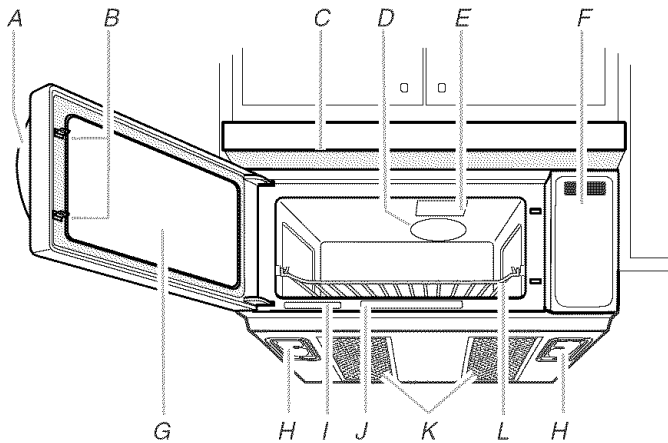

- | | |
|--------------------------|--|
| A. Door handle | H. Cooktop lights |
| B. Door lock system | I. Model and serial number plate |
| C. Vent grille | J. Cooking guide label |
| D. Microwave inlet cover | K. Charcoal and Grease filters
(shipped in microwave oven cavity) |
| E. Microwave oven light | L. Cooking rack |
| F. Control panel | |
| G. Metal shielded window | Parts and Features not shown:
Turntable |

Turntable

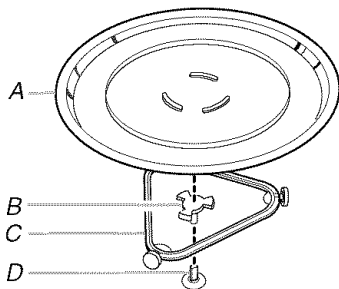

- | |
|--------------|
| A. Turntable |
| B. Hub |
| C. Support |
| D. Shaft |

The turntable can rotate in either direction to help cook food more evenly. Do not operate the microwave oven without having the turntable in place. See "Assistance or Service" to reorder any of the parts.

To Install:

1. Remove tape from the hub.
2. Place the support on the microwave oven cavity bottom.
3. Place the turntable on the support.

Fit the raised, curved lines in the center of the turntable bottom between the three spokes of the hub. The rollers on the support should fit inside the turntable bottom ridge.

Turning Off the Turntable

The turntable can be turned off (except during an auto function). This is helpful when cooking with plates that are larger than the turntable or when cooking with 2 plates that are side by side.

To Turn Off: Touch TURNTABLE ON/OFF. A "turntable off" icon will appear in the display. The turntable will turn back on automatically when cooking is over or OFF is touched.

Cooking Rack

The cooking rack is ideal for two-level cooking. It provides extra cavity space for cooking 2 or more containers at the same time. Insert the rack securely into the rack supports on the side walls of the microwave oven. See "Assistance or Service" section to reorder rack.

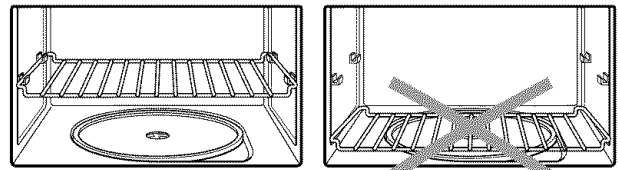

- When not using the rack for cooking, remove it from the microwave oven. Damage to the microwave oven could result if someone unintentionally turns it on.
- Rack will become hot. Always use oven mitts or pot holders when handling.
- Do not allow the rack to touch the inside cavity walls, ceiling or floor.
- Use the rack only when cooking on 2 levels.
- Do not use metal cookware, utensils, or a browning dish with the rack.
- Do not let food container on rack touch the top or sides of the microwave oven.
- Remove rack before using Popcorn function.
- Do not cook food directly on the rack. Always use a microwave-safe container.
- The rack is designed specifically for this microwave oven. Do not attempt to use any other rack in this microwave oven.
- To avoid damage to the microwave oven due to soil buildup, clean rack supports often (see "General Cleaning" section).

MICROWAVE OVEN CONTROL

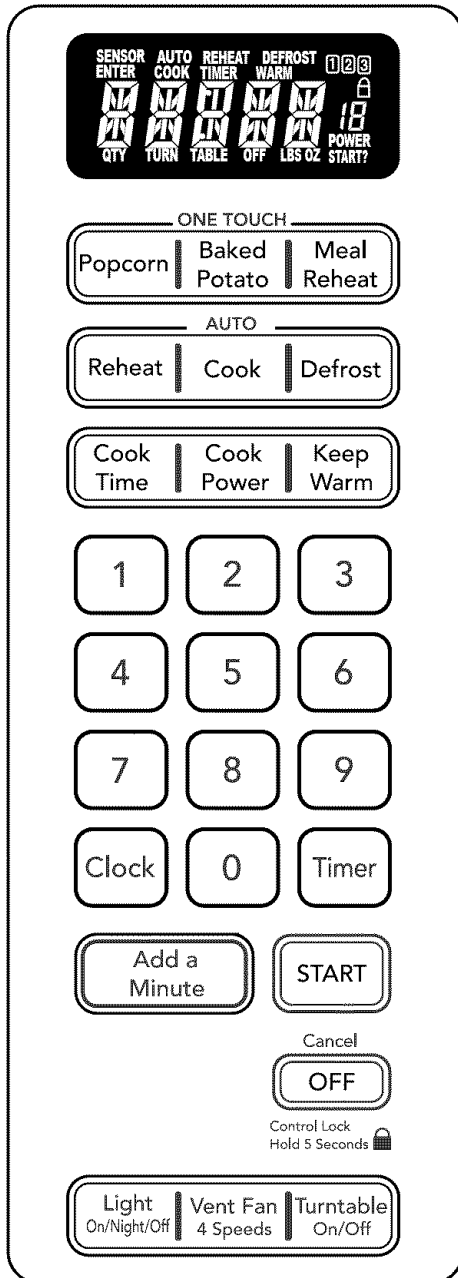

Display

When power is first supplied to the microwave oven, a “:” will blink in the display. Touch OFF (CANCEL OFF) to stop the blinking. If the “:” blinks in the display at any other time, a power failure has occurred. Touch OFF and reset the clock if needed.

If “RETRY” appears in the display for 2 seconds, an invalid value has been entered. Retry your entry.

When the microwave oven is in use, the display shows cooking power, quantities, weights and/or prompts. When the microwave oven is not in use, the display shows the time of day or Timer countdown.

Start

The START control starts any function. If non-sensor cooking is interrupted, touching START will resume the preset cycle.

If the microwave oven has not been in use and the door has not been opened in the past 5 minutes, the cooking function will not start. Open and close the door, then touch START to start or resume the cooking cycle.

Add a Minute

The ADD A MINUTE control automatically starts the microwave oven at 100% power for 1 minute, and adds 1 minute of cook time, up to 10 minutes, with each additional touch of the control. Touching ADD A MINUTE during a cook cycle will add 1 minute of cook time at the current cook power.

If the microwave oven has not been in use and the door has not been opened in the past 5 minutes, the ADD A MINUTE control will not start the cooking cycle. Open and close the door, then touch ADD A MINUTE to start the cooking cycle.

Off

The OFF control (CANCEL OFF) clears any incorrect command and cancels all functions except for the Demo Mode. It will not erase the time of day. The control panel can be locked and unlocked using the OFF control (see “Control Lock” section).

The microwave oven will also turn off when the door is opened. Close the door and touch START to resume the cycle. A sensor cooking cycle may not be resumed if interrupted by opening the door.

Clock

This is a standard 12-hour clock (12:00-11:59) and does not show a.m. or p.m.

To Set:

The microwave oven and timer must be off.

1. Touch CLOCK.
2. Touch the number pads to set the time of day.
3. Touch CLOCK or START.

To Remove:

1. Touch CLOCK.
2. Touch 0.
3. Touch CLOCK.

The time will disappear, and “:” will appear on the display.

Tones

Tones are audible signals, indicating the following:

One tone

- Valid entry (short tone)
- End of Timer countdown (long tone)

Two tones

- Reminder, repeat each minute after the end-of-cycle tones
- End of stage in multistage cooking
- Hidden feature has been entered or exited

Three tones

- Invalid entry

Four tones

- End of cycle

To Turn Off Valid Entry Tones: Touch and hold the number pad “1” for 5 seconds until 2 tones sound. Repeat to turn tones back on.

To Turn Off All Tones (except end-of-Timer and hidden feature signals): Touch and hold the number pad “2” for 5 seconds until 2 tones sound. Repeat to turn tones back on.

Timer

The Timer can be set in minutes and seconds, up to 99 minutes 99 seconds and counts down the set time.

NOTE: The Timer does not start or stop the microwave oven.

When the Timer is in use, the microwave oven can also operate. To see the countdown for 3 seconds when the microwave oven is in use, touch TIMER.

To Set:

1. Touch TIMER.

If no action is taken after 1 minute, the display will return to the time of day mode.

2. Touch the number pads to set the length of time.

3. Touch TIMER or START.

If TIMER or START is not touched within 5 seconds, “START?” will appear in the display. If TIMER or START is not touched within 1 minute, the display will return to the time of day mode and the programmed function will be canceled.

When the set time ends, “END” will appear in the display and 1 tone will sound.

Touching OFF while a cook function is active in the display will cancel the cook function, not the Timer.

To cancel the Timer, touch TIMER or OFF while the countdown is active in the display.

The length of time can be changed during the countdown by repeating the above steps.

Control Lock

The Control Lock shuts down the control panel pads to avoid unintended use of the microwave oven. When the control is locked, only the Vent Fan and Light pads will function.

To Lock/Unlock Control: The microwave oven and Timer must be off. Touch and hold OFF for 5 seconds until 2 tones sound and a lock icon appears in the display. Repeat to unlock and remove the lock icon from display.

Vent Fan

The vent fan has 4 speeds: high, medium-high, medium and low. To protect the microwave oven, if the temperature from the range or cooktop below the microwave oven gets too hot, the vent fan will automatically turn on at high speed. It may stay on for up to 1 hour to cool the microwave oven. When this occurs, the vent fan cannot be turned off.

To Turn Vent Fan On/Off: Repeatedly touch the VENT FAN 4 SPEEDS pad to cycle through the 4 speeds, and then turn the fan off.

Cooktop Light

The cooktop light has 3 settings: on, night and off.

To Turn On/Night/Off: Touch LIGHT ON/NIGHT/OFF pad repeatedly to cycle through the settings.

Demo Mode

The Demo Mode is ideal for learning how to use the microwave oven. When set, functions can be entered without actually turning on the magnetron. The microwave oven light will come on, the fan will run, and if on, the turntable will rotate.

To Turn On/Off: The microwave oven and Timer must be off. Touch and hold TIMER for 5 seconds until 2 tones sound and “d” appears in the display. Repeat to turn off and remove “d” from the display.

MICROWAVE OVEN USE

A magnetron in the oven produces microwaves which reflect off the metal floor, walls and ceiling and pass through the turntable and appropriate cookware to the food. Microwaves are attracted to and absorbed by fat, sugar and water molecules in the food, causing them to move, producing friction and heat which cooks the food.

- Do not lean on or allow children to swing on the microwave oven door.
- Do not operate microwave oven when it is empty.
- The turntable must be in place and correct side up when microwave oven is in use. Do not use if turntable is chipped or broken. See “Assistance or Service” section to reorder.
- Baby bottles and baby food jars should not be heated in microwave oven.
- Clothes, flowers, fruit, herbs, wood, gourds, paper, including brown paper bags and newspaper, should not be dried in microwave oven.
- Do not use the microwave oven for canning, sterilizing or deep frying.
- Paraffin wax will not melt in the microwave oven because it does not absorb microwaves.
- Use oven mitts or pot holders when removing containers from microwave oven.

- Do not overcook potatoes. At the end of the recommended cook time, potatoes should be slightly firm. Let potatoes stand for 5 minutes. They will finish cooking while standing.
- Do not cook or reheat whole eggs inside the shell. Steam buildup in whole eggs may cause them to burst. Cover poached eggs and allow a standing time.

Food Characteristics

When microwave cooking, the amount, size and shape, starting temperature, composition and density of the food affect cooking results.

Amount of Food

The more food heated at once, the longer the cook time needed. Check for doneness and add small increments of time if necessary.

Size and Shape

Smaller pieces of food will cook more quickly than larger pieces, and uniformly shaped foods cook more evenly than irregularly shaped food.

Starting Temperature

Room temperature foods will heat faster than refrigerated foods, and refrigerated foods will heat faster than frozen foods.

Composition and Density

Foods high in fat and sugar will reach a higher temperature, and will heat faster than other foods. Heavy, dense foods, such as meat and potatoes, require a longer cook time than the same size of a light, porous food, such as cake.

Cooking Guidelines

Covering

Covering food helps retain moisture, shorten cook time and reduce spattering. Use the lid supplied with cookware. If a lid is not available, wax paper, paper towels or plastic wrap approved for microwave ovens may be used. Plastic wrap should be turned back at one corner to provide an opening to vent steam. Condensation on the door and cavity surfaces is normal during heavy cooking.

Stirring and Turning

Stirring and turning redistribute heat evenly to avoid overcooking the outer edges of food. Stir from outside to center. If possible, turn food over from bottom to top.

Arranging

If heating irregularly shaped or different sized foods, arrange the thinner parts and smaller sized items toward the center. If cooking several items of the same size and shape, place them in a ring pattern, leaving the center of the ring empty.

Piercing

Before heating, use a fork or small knife to pierce or prick foods that have a skin or membrane, such as potatoes, egg yolks, chicken livers, hot dogs, and sausage. Prick in several places to allow steam to vent.

Shielding

Use small, flat pieces of aluminum foil to shield the thin pieces of irregularly shaped foods, bones and foods such as chicken wings, leg tips and fish tail. See "Aluminum Foil and Metal" first.

Standing Time

Food will continue to cook by the natural conduction of heat even after the microwave cooking cycle ends. The length of standing time depends on the volume and density of the food.

Cookware and Dinnerware

Cookware and dinnerware must fit on the turntable. Always use oven mitts or pot holders when handling because any dish may become hot from heat transferred from the food. Do not use cookware and dinnerware with gold or silver trim. Use the following chart as a guide, then test before using.

MATERIAL	RECOMMENDATIONS
Aluminum Foil, Metal	See "Aluminum Foil and Metal" section.
Browning Dish	Bottom must be at least 3/16" (5 mm) above the turntable. Follow manufacturer's recommendations.
Ceramic Glass, Glass	Acceptable for use.
China, Earthenware	Follow manufacturer's recommendations.

MATERIAL	RECOMMENDATIONS
Melamine	Follow manufacturer's recommendations.
Paper: Towels, Dinnerware, Napkins	Use nonrecycled and those approved by the manufacturer for microwave oven use.
Plastic: Wraps, Bags, Covers, Dinnerware, Containers	Use those approved by the manufacturer for microwave oven use.
Pottery and Clay	Follow manufacturer's recommendations.
Silicone Bakeware	Follow manufacturer's recommendations.
Straw, Wicker, Wooden Containers	Do not use in microwave oven.
Styrofoam [†]	Do not use in microwave oven.
Wax Paper	Acceptable for use.

To Test Cookware or Dinnerware for Microwave Use:

1. Place cookware or dinnerware in microwave oven with 1 cup (250 mL) of water beside it.
2. Cook at 100% cooking power for 1 minute.

Do not use cookware or dinnerware if it becomes hot and the water stays cool.

Aluminum Foil and Metal

Always use oven mitts or pot holders when removing dishes from the microwave oven.

Aluminum foil and some metal can be used in the microwave oven. If not used properly, arcing (a blue flash of light) can occur and cause damage to the microwave oven.

OK for Use

Racks and bakeware supplied with the microwave oven (on some models), aluminum foil for shielding, and approved meat thermometers may be used with the following guidelines:

- Do not allow aluminum foil or metal to touch the inside cavity walls, ceiling or floor.
- Always use the turntable.
- Do not allow contact with another metal object during microwave cooking.

Do Not Use

Metal cookware and bakeware, gold, silver, pewter, non-approved meat thermometers, skewers, twist ties, foil liners such as sandwich wrappers, staples and objects with gold or silver trim or a metallic glaze should not be used in the microwave oven.

[†]STYROFOAM is a Registered Trademark of The Dow Chemical Company.

Microwave Cooking Power

Many recipes for microwave cooking specify which cooking power to use by percent, name or number. For example, 70%=7=Medium-High.

Use the following chart as a general guide for the suggested cooking power of specific foods.

PERCENT/ NAME	NUMBER	USE
100%, High (default setting)	10	Quick heating convenience foods and foods with high water content, such as soups, beverages and most vegetables.
90%	9	Cooking small, tender pieces of meat, ground meat, poultry pieces and fish fillets. Heating cream soups.
80%	8	Heating rice, pasta or casseroles. Cooking and heating foods that need a cook power lower than high. For example, whole fish and meat loaf.
70%, Medium-High	7	Reheating a single serving of food.
60%	6	Cooking sensitive foods such as cheese and egg dishes, pudding and custards. Cooking non-stirrable casseroles, such as lasagna.
50%, Medium	5	Cooking ham, whole poultry and pot roasts. Simmering stews.
40%	4	Melting chocolate. Heating bread, rolls and pastries.
30%, Medium- Low, Defrost	3	Defrosting bread, fish, meats, poultry and precooked foods.
20%	2	Softening butter, cheese, and ice cream.
10%, Low	1	Taking chill out of fruit.

Manual Cooking

To Use:

1. Place food on the turntable and close the door.
2. Touch COOK TIME, then enter length of time to cook.
If cooking with 100% power, skip Step 3.
3. Touch COOK POWER, then enter the desired power level.
See "Microwave Cooking Power" chart.
4. Touch START.
The display will count down the cook time.
When the cycle ends, "END" will appear in the display, and the end-of-cycle tones will sound, followed by reminder tones.
5. Touch OFF or open the door to clear the display and/or stop reminder tones.

The cook time and cooking power can be changed at any time after touching START by repeating the above steps.

Cooking in Stages (or steps)

The microwave oven can be set to cook at different cooking powers for various lengths of time, up to 3 stages.

Sensor cooking cannot be done in stages.

To Cook in Stages:

1. Place food on the turntable and close the door.
2. Touch COOK TIME, then enter length of time to cook during the first stage.
If cooking with 100% power, skip Step 3.
3. Touch COOK POWER, then enter the desired power level for the first stage. See "Microwave Cooking Power" chart.
4. Repeat steps 2 and 3 for the second and third stages.
5. Touch START.
The display will count down each of the cook times. A "1," "2" and "3" will appear on the display during their respective stages.
When the cycle ends, "END" will appear in the display, and the end-of-cycle tones will sound, followed by reminder tones.
6. Touch OFF or open the door to clear the display and/or stop reminder tones.

The cook time and cooking power of the cycling stage can be changed after touching START without interrupting cooking.

To Change Cook Time: Touch COOK TIME, then enter the new cook time. Touch START.

To Change Cooking Power: Touch COOK POWER, then enter the new cooking power. See "Microwave Cooking Power" chart. Touch START. Cooking power may also be adjusted by repeatedly touching COOK POWER.

Sensor Cooking

A sensor in the microwave oven detects humidity released from the food as it heats, and adjusts the cook time accordingly.

Many sensor cycles require the covering of foods. Microwave-safe containers or steamers with loose-fitting lids are recommended. The loose-fitting lid allows enough steam to escape to be detected by the sensor. When covering foods with plastic wrap, be sure to leave a large enough vent opening to allow the steam to escape.

NOTES:

- The microwave oven should be plugged in for at least 3 minutes.
- The microwave oven cavity and the exterior of the cooking container should be dry.
- The room temperature should not exceed 95°F (35°C).
- If the door is opened during a sensor cycle, sensing will stop and the program will be canceled.

One Touch Cooking (Sensor)

Use the following chart as a guide for the ONE TOUCH pads.

FOOD	SERVING SIZE	INSTRUCTIONS
Popcorn*	3.5 oz (100 g) 3 oz (85 g) 1.75 oz (50 g)	Pop only one package at a time. For bag sizes not listed in this section, follow directions on package.
Baked Potato	1-4 medium, 10-13 oz (283-369 g) each, similar in size	Pierce each one several times with a fork. Place on turntable around edges, at least 1" (2.5 cm) apart. At the end of cooking, let stand 5 minutes.
Meal Reheat	1 dinner plate, 8-16 oz (227-454 g)	Place food on plate, cover with plastic wrap and vent.

*Do not use regular paper bags or glassware. Listen for popping to slow to 1 pop every 1 or 2 seconds, then stop the cycle. Do not try to pop unpopped kernels. Use fresh bags of popcorn for optimal results. Cooking results may vary by brand and fat content. If using a microwave popcorn popper, follow manufacturer's instructions.

To Use One Touch Cooking:

- Place food on the turntable and close the door.
- Touch one of the ONE TOUCH pads.
The microwave oven will turn on automatically.
If more or less time is required (for BAKED POTATO and MEAL REHEAT only), touch COOK POWER after the microwave oven starts to cook.
"Sense" will appear on the display, followed by the remaining time for BAKED POTATO and MEAL REHEAT only. "Sense" will remain in the display during the entire POPCORN cycle.
When the cycle ends, "END" will appear in the display, and the end-of-cycle tones will sound, followed by reminder tones.
- Touch OFF or open the door to clear the display and/or stop reminder tones.

Preset Cooking

Times and cooking power have been preset for certain microwavable foods. Use the following chart as a guide.

FOOD	PAD	QUANTITY/INSTRUCTION
Canned Vegetables	1	1-4 cups (250 mL-1 L)/ Place in microwave-safe container. Cover with plastic wrap and vent. Stir and let stand 2-3 minutes after cooking.
Fresh Vegetables*	2	1-4 cups (250 mL-1 L)/ Place in microwave-safe container. Add 2-4 tbs (30-60 mL) water. Cover with plastic wrap and vent. Stir and let stand 2-3 minutes after cooking.
Frozen Vegetables*	3	1-4 cups (250 mL-1 L)/ Remove from package. Place in microwave-safe container, and add 2-4 tbs (30-60 mL) water. Cover with plastic wrap and vent. Stir and let stand 2-3 minutes after cooking.

FOOD	PAD	QUANTITY/INSTRUCTION
Rice*	4	0.5, 1.0, 1.5 or 2.0 cups (125, 250, 375 or 500 mL) dry rice (medium or long grain)/ Follow ingredient measurements on the package. Place rice and liquid in microwave-safe container. Cover with loose-fitting lid. Let stand 5 minutes after cooking, or until liquid is absorbed. Stir.
French Toast, frozen	5	1-4 pieces/ Follow directions on the package.
Bacon**	6	1-6 slices, average thickness/ Follow directions on the package.
Frozen Entrée*	7	10-20 oz (283-565 g)/ Remove from package. Loosen cover on 3 sides. If entrée is not in microwave-safe container, place on plate, cover with plastic wrap and vent. Let stand 2-3 minutes after cooking.

*Sensor function

**Differences in the amount of fat, meat, thickness, and curing process affect results. Average is 16 slices per pound.

To Use Preset Cooking:

- Place food on the turntable and close the door.
- Touch COOK.
- Touch number pad from chart
or
Touch COOK repeatedly to scroll through foods.
- Touch number pads to enter quantity (for Canned Vegetables, French Toast and Bacon only).
The sensor will determine quantities and cook times for Fresh Vegetables, Frozen Vegetables, Rice and Frozen Entrée.
Doneness may be adjusted at this time by touching COOK POWER.
- Touch START.
The display will count down the cook time.
When the cycle ends, "END" will appear in the display, and the end-of-cycle tones will sound, followed by reminder tones.
- Touch OFF or open the door to clear the display and/or stop reminder tones.

Reheating

Times and cooking power have been preset for reheating specific foods. Use the following chart as a guide.

FOOD	PAD	QUANTITY/INSTRUCTION
Pizza Slice (refrigerated)	1	1-3 slices, 3 oz (85 g) each/ Place on paper towel or paper plate.
Casserole (refrigerated)	2	1-4 cups (250 mL-1 L)/ Place in microwave-safe container, and cover with plastic wrap. Stir and let stand 2-3 minutes after reheating.

FOOD	PAD	QUANTITY/INSTRUCTION
Soup*	3	1-4 cups (250 mL-1 L)/ Place in microwave-safe container. Cover with plastic wrap and vent. Stir and let stand 2-3 minutes after reheating.
Sauce*	4	1-4 cups (250 mL-1 L)/ Place in microwave-safe container. Cover with plastic wrap and vent. Stir and let stand 2-3 minutes after reheating.
Baked Goods (example: medium muffin or bagel)	5	1-6 pieces**, 2 oz (57 g) each/ Place on paper towel.

*Sensor function

**For smaller rolls, 2 rolls may be counted as 1 piece.

To Use Reheat:

- Place food on the turntable and close the door.
- Touch REHEAT.
- Touch number pad from chart
or
Touch REHEAT repeatedly to scroll through foods.
- Touch number pads to enter quantity for Pizza Slice, Casserole and Baked Goods only.
The sensor will determine quantities for Soup and Sauce.
Reheat time may be adjusted at this time by touching COOK POWER.
- Touch START.
The display will count down the reheat time.
When the cycle ends, "END" will appear in the display, and the end-of-cycle tones will sound, followed by reminder tones.
- Touch OFF or open the door to clear the display and/or stop reminder tones.

Two or More Plates

Two plates may be heated side by side, or 1 dish larger than the turntable, plus 2 plates on the cooking rack. For best results, halfway through heating, turn the plates (or larger dish) halfway around, and switch plates between top and bottom (if heating more than 2 plates). See "Cooking Rack" section.

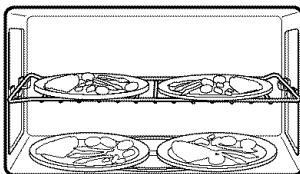

The turntable must be turned off while heating 2 bottom plates or 1 larger dish. See "Turntable" section.

To Reheat Manually: Follow instructions in "Manual Cooking" section, and use 70% cooking power. See "Microwave Cooking Power" chart.

Defrosting

The automatic Defrost control can be used or the microwave oven can be manually set to defrost.

- Food should be 0°F (-18°C) or colder at defrosting for optimal results.
- Unwrap foods and remove lids (for example, from fruit juice containers) before defrosting.
- Shallow packages will defrost more quickly than deep blocks.
- Separate food pieces as soon as possible during or at the end of cycle for more even defrosting.
- Use small pieces of aluminum foil to shield parts of food such as chicken wings, leg tips and fish tails. See "Aluminum Foil and Metal" first.

The automatic Defrost control has 3 categories: Meat, Poultry and Fish. It should not be used for food left outside the freezer more than 20 minutes and frozen ready-made food. Use the following chart as a guide.

MEAT

<i>Beef:</i> ground, steaks, roast, stew	The narrow or fatty areas of irregular shaped cuts should be shielded with foil before defrosting.
<i>Lamb:</i> stew and chops	
<i>Pork:</i> chops, ribs, roasts, sausage	Do not defrost less than 1/4 lb (113 g) or two 4 oz (113 g) patties. Place all meats in microwave-safe baking dish.

POULTRY

<i>Chicken:</i> whole and cut up	Place in microwave-safe baking dish, chicken breast side up.
<i>Cornish hens</i>	
<i>Turkey:</i> breast	

FISH

<i>Fillets, Steaks, Whole, Shellfish</i>	Place in microwave-safe baking dish.
--	--------------------------------------

To use the Defrost control:

- Place food on the turntable, uncovered, and close the door.
- Touch DEFROST.
- Touch 1 for Meat, 2 for Poultry or 3 for Fish
or
Touch DEFROST repeatedly to scroll through foods.
- Touch the number pads to enter the weight.
Meats and Poultry can be set from 0.2 to 6.6 lb (90 g to 3 kg).
Fish can be set from 0.2 to 4.4 lb (90 g to 2 kg).
Defrost time may be adjusted at this time by touching COOK POWER.
- Touch START.
The display will count down the defrost time.
When the cycle ends, "END" will appear in the display, and the end-of-cycle tones will sound, followed by reminder tones.
- Touch OFF or open the door to clear the display and/or stop reminder tones.

To Defrost Manually: Follow directions in "Manual Cooking" section, and use 30% cooking power. See "Microwave Cooking Power" chart.

Keep Warm

! WARNING

Food Poisoning Hazard

Do not let food sit in oven more than one hour before or after cooking.

Doing so can result in food poisoning or sickness.

Hot cooked food can be kept warm in the microwave oven. The Keep Warm function uses 10% cook power. Keep Warm can be used by itself, or it can be programmed to follow a cooking cycle. Opening the door during Keep Warm will cancel the function.

- Cover plates of food.
- Cover foods that were covered while being cooked.
- Do not cover baked goods such as pastries, pies, turnovers, etc.

To Use (for single cycle):

1. Place hot cooked food on the turntable and close the door.
2. Touch KEEP WARM.
3. Touch START.

“WARM” will appear in the display during the entire cycle.

When the cycle ends, “END” will appear in the display, and the end-of-cycle tones will sound, followed by reminder tones.

4. Touch OFF or open the door to clear the display and/or stop reminder tones.

To Set at end of cycle: Touch KEEP WARM while setting a cooking cycle before touching START control, or during cooking.

MICROWAVE OVEN CARE

General Cleaning

IMPORTANT: Before cleaning, make sure all controls are off and the microwave oven is cool. Always follow label instructions on cleaning products.

Soap, water and a soft cloth or sponge are suggested unless otherwise noted.

GREASE FILTERS

Do not use ammonia or corrosive cleaning agents such as lye-based oven cleaners.

- Hot water and mild detergent:
Soak filters, then scrub and swish to remove embedded dirt and grease. Rinse well and shake to dry.
- Dishwasher:
Wash separately, not with dirty dishes, because food can be trapped in the filters.

MICROWAVE OVEN CAVITY

To avoid damage to the microwave oven cavity, do not use soap-filled scouring pads, abrasive cleaners, steel-wool pads, gritty washcloths or some recycled paper towels.

The area where the microwave oven door and frame touch when closed should be kept clean.

Average soil

- Mild, nonabrasive soaps and detergents:
Rinse with clean water and dry with soft, lint-free cloth.

Heavy soil

- Mild, nonabrasive soaps and detergents:
Heat 1 cup (250 mL) of water for 2 to 5 minutes in microwave oven. Steam will soften soil. Rinse with clean water and dry with soft, lint-free cloth.

Odors

- Lemon juice or vinegar:
Heat 1 cup (250 mL) of water with 1 tbs (15 mL) of either lemon juice or vinegar for 2 to 5 minutes in microwave oven.

Microwave Inlet Cover

To avoid arcing and microwave oven damage, the microwave inlet cover (see “Parts and Features”) should be kept clean.

- Wipe with wet cloth.

MICROWAVE OVEN DOOR AND EXTERIOR

The area where the microwave oven door and frame touch when closed should be kept clean.

- Mild, nonabrasive soaps and detergents:
Rinse with clean water and dry with soft, lint-free cloth.
- Glass cleaner and paper towels or nonabrasive plastic scrubbing pad:
Apply glass cleaner to towel, not directly to surface.

Stainless Steel (on some models)

To avoid damage to the microwave oven door and exterior, do not use soap-filled scouring pads, abrasive cleaners, steel-wool pads, gritty washcloths or some paper towels. Rub in direction of grain.

- KitchenAid® Stainless Steel Cleaner and Polish (not included)
KitchenAid® Stainless Steel Wipes (not included):
See “Assistance or Service” section to order.
- Liquid detergent or all-purpose cleaner:
Rinse with clean water and dry with soft, lint-free cloth.
- Vinegar for hard water spots

CONTROL PANEL

- Sponge or soft cloth and water:
Dampen sponge with water and wipe panel. Dry with soft cloth.
- Do not use chemical or abrasive cleansers.

TURNTABLE

Replace turntable immediately after cleaning. Do not operate the microwave oven without the turntable in place.

- Mild cleanser and scouring pad
- Dishwasher

COOKING RACK

Dishwasher cleaning is not recommended. Do not use abrasive cleansers or scrubbers.

- Mild cleanser, water and washcloth

RACK SUPPORTS

To avoid soil buildup which may lead to arcing and cause damage to the microwave oven, clean rack supports often.

Do not use soap-filled scouring pads, abrasive cleaners, steel-wool pads, gritty washcloths or some recycled paper towels.

- Mild, nonabrasive soap or detergent and washcloth, toothbrush or cotton swab:
Rinse with clean water and dry with soft, lint-free cloth.

Replacing Filters

The grease filters should be removed and cleaned at least once a month. Do not operate the microwave oven without the filters in place. The charcoal filters cannot be washed and should be replaced every 6 to 12 months. See "Assistance or Service" to reorder filters. See "General Cleaning" for instructions on cleaning.

To Remove:

1. Remove each of the grease filters by pushing the back of the filter up, grasping the tab, and sliding the filter to the back. Pull tab down until the filter drops out.

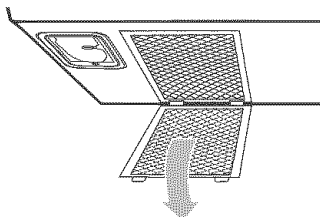

2. Remove each charcoal filter by pushing the filter toward the center of the microwave oven until it is clear of the narrow outer lip. Swing the filter down and slide it out.

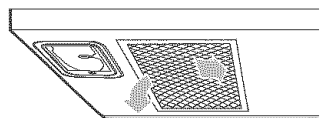

To Replace:

1. Replace each charcoal filter by positioning it above the wide lip near the center of the microwave oven. Swing the filter up into position and slide it toward the narrow lip. The filter will now be held in position between the lips.
2. Replace each grease filter by inserting the end without the tab into the frame. Swing other side up and slide into position.

Replacing Cooktop Light

The cooktop light is a 25W low-voltage halogen capsule bulb. See "Assistance or Service" section to reorder.

To Replace:

1. Unplug microwave oven or disconnect power.
2. Remove bulb cover mounting screw, and gently remove cover.

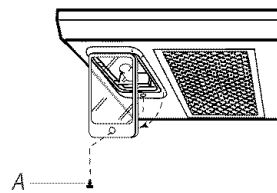

A. Mounting screw

3. Remove the burned-out bulb.
4. Replace bulb, using a tissue or wearing clean cotton gloves to handle the bulb. Do not touch bulb with bare fingers.
5. Replace bulb cover and mounting screw.
6. Plug in microwave oven or reconnect power.

Replacing Microwave Oven Light

The microwave oven light is a candelabra base bulb. It will automatically come on when the door is opened and when the microwave oven is operating. See "Assistance or Service" section to reorder.

To Replace:

1. Unplug microwave oven or disconnect power.
2. Remove the 2 vent grille mounting screws located directly behind the top louver.

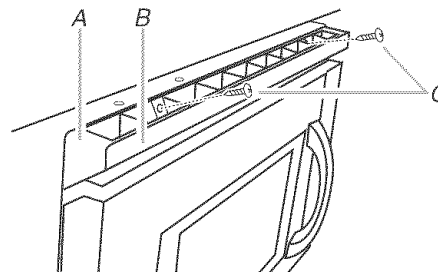

A. Vent grille
B. Top louver
C. Mounting screws

3. Tip the vent grille forward and down, then lift out to remove.

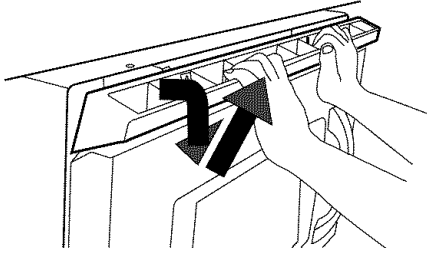

4. Lift up the bulb cover.

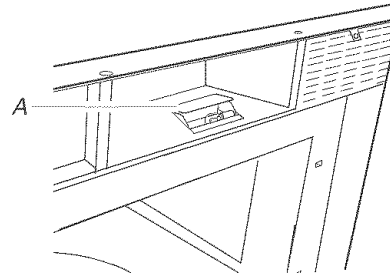

A. Bulb cover

5. Replace light. Close bulb cover.
6. Reattach vent grille. Replace the mounting screws.
7. Plug in microwave oven or reconnect power.

TROUBLESHOOTING

Try the solutions suggested here first in order to avoid the cost of an unnecessary service call.

Nothing will operate

- **Has a household fuse blown, or has a circuit breaker tripped?**
Replace the fuse or reset the circuit breaker. If the problem continues, call an electrician.
- **Is the appliance wired properly?**
See Installation Instructions provided with your microwave oven.

Microwave oven will not operate

- **Is the door completely closed?**
Firmly close door.
- **Has the microwave oven been inactive and the door closed for more than 5 minutes?**
Open and close the door. See “Start” section.
- **Is a spacer (on some models) attached to the inside of the door?**
Remove spacer, then firmly close door.
- **Is the electronic microwave oven control set correctly?**
See “Microwave Oven Control” section.
- **On some models, is the Control Lock set?**
See “Control Lock” section.
- **On some models, is the Demo Mode activated?**
See “Demo Mode” section.
- **Is the magnetron working properly?**
Try to heat 1 cup (250 mL) of cold water for 2 minutes at 100% cooking power. If water does not heat, call for service. See “Assistance or Service” section.

Microwave oven makes humming noise

- This is normal and occurs when the power supply switches the magnetron on and off.

Microwave oven door looks wavy

- This is normal and will not affect performance.

Turntable will not operate

- **Has the tape been removed from turntable hub?**
See “Turntable” section.
- **Is the turntable properly in place?**
Make sure turntable is correct side up and is sitting securely on the turntable support.
- **Is the turntable support operating properly?**
Remove turntable. Remove and clean turntable support and rollers. Replace turntable support. Replace turntable. Place 1 cup (250 mL) of water on the turntable, then restart microwave oven. If it still is not working, call for service. See “Assistance or Service” section. Do not operate the microwave oven without turntable and turntable support working properly.

Turntable alternates rotation directions

- This is normal and depends on motor rotation at the beginning of the cycle.

Display shows messages

- **Is the display showing an “Oven Status” screen, with a letter/number code and instruction to inform KitchenAid?**
The microwave oven has detected an internal problem. It has run a self-checking program and displayed the error. Call for service. See “Assistance or Service” section.

Display shows time countdown, but is not operating

- **Is the Timer in use?**
See “Timer” section.
- **On some models, is the Demo Mode in use?**
See “Demo Mode” section.

Tones are not sounding

- **Are tones turned off?**
See “Tones” section.

Steam is coming from the vent grille

- Some steam is normal.

Fan running slower than usual

- **Has the microwave oven been stored in a cold area?**
The fan will run slower until the microwave oven warms up to normal room temperature.

Cooking times seem too long

- **Is the cooking power set properly?**
See “Microwave Cooking Power” section.
- **Are large amounts of food being heated?**
Larger amounts of food need longer cooking times.
- **Is the incoming voltage less than that specified in “Microwave Hood Combination Safety?”**
Have a qualified electrician check the electrical system in the home.

Radio, TV or cordless phone interference

- **Is the microwave oven plugged into the same outlet?**
Try a different outlet.
- **Is the radio or TV receiver near the microwave oven?**
Move the receiver away from the microwave oven, or adjust the radio or TV antenna.
- **Are the microwave oven door and sealing surfaces clean?**
Make sure these areas are clean.
- **Is the cordless phone frequency 2.4 GHz?**
Some 2.4 GHz-based cordless phones and home wireless networks may experience static or noise while the microwave oven is on. Use a corded phone, a different frequency cordless phone or avoid using these items during microwave oven operation.

ASSISTANCE OR SERVICE

Before calling for assistance or service, please check “Troubleshooting.” It may save you the cost of a service call. If you still need help, follow the instructions below.

When calling, please know the purchase date and the complete model and serial number of your appliance. This information will help us to better respond to your request.

If you need replacement parts

If you need to order replacement parts, we recommend that you use only factory specified parts. These factory specified parts will fit right and work right because they are made with the same precision used to build every new KITCHENAID® appliance.

To locate factory specified parts in your area, call us or your nearest KitchenAid designated service center.

In the U.S.A.

Call the KitchenAid Customer eXperience Center toll free:
1-800-422-1230.

Our consultants provide assistance with:

- Features and specifications on our full line of appliances.
- Installation information.
- Use and maintenance procedures.
- Accessory and repair parts sales.
- Specialized customer assistance (Spanish speaking, hearing impaired, limited vision, etc.).
- Referrals to local dealers, repair parts distributors and service companies. KitchenAid designated service technicians are trained to fulfill the product warranty and provide after-warranty service, anywhere in the United States.

To locate the KitchenAid designated service company in your area, you can also look in your telephone directory Yellow Pages.

For further assistance

If you need further assistance, you can write to KitchenAid with any questions or concerns at:

KitchenAid Brand Home Appliances
Customer eXperience Center
553 Benson Road
Benton Harbor, MI 49022-2692

Please include a daytime phone number in your correspondence.

Replacement Parts

Turntable Part Number 8206226	Grease Filters Part Number W10113040
Turntable Support and Rollers Part Number 8206227	Charcoal Filters Part Number W10112514
Turntable Hub Part Number 8206228	Cooktop Light Bulb Part Number W10112515
Cooking Rack Part Number 8205549	Microwave Oven Light Bulb Part Number 8183993

Cleaning Supplies

Heavy Duty Degreaser Part Number 31552	KITCHENAID® Stainless Steel Cleaner and Polish Part Number 4396920
All-Purpose Appliance Cleaner Part Number 31662	KITCHENAID® Stainless Steel Wipes Part Number 8212510

KITCHENAID® BUILT-IN OVEN & MICROWAVE WARRANTY

ONE YEAR LIMITED WARRANTY

For one year from the date of purchase, when this major appliance is operated and maintained according to instructions attached to or furnished with the product, KitchenAid or KitchenAid Canada (hereafter "KitchenAid") will pay for factory specified parts and repair labor to correct defects in materials or workmanship. Service must be provided by a KitchenAid designated service company.

SECOND THROUGH FIFTH YEAR LIMITED WARRANTY ON CERTAIN COMPONENT PARTS

In the second through fifth years from the date of purchase, when this appliance is operated and maintained according to instructions attached to or furnished with the product, KitchenAid or KitchenAid Canada will pay for factory specified parts for the following components if defective in materials or workmanship:

- Electric element
- Solid state touch control system parts

SECOND THROUGH TENTH YEAR LIMITED WARRANTY

On microwave ovens only, in the second through tenth years from date of purchase, when this major appliance is operated and maintained according to instructions attached to or furnished with the product, KitchenAid will pay for factory specified parts for the stainless steel oven cavity/inner door if the part rusts through due to defects in materials or workmanship.

ITEMS KITCHENAID WILL NOT PAY FOR

1. Service calls to correct the installation of your major appliance, to instruct you how to use your major appliance, to replace or repair house fuses or to correct house wiring or plumbing.
2. Service calls to repair or replace appliance light bulbs, air filters or water filters. Those consumable parts are excluded from warranty coverage.
3. Repairs when your major appliance is used for other than normal, single-family household use.
4. Damage resulting from accident, alteration, misuse, abuse, fire, flood, acts of God, improper installation, installation not in accordance with electrical or plumbing codes, or use of products not approved by KitchenAid.
5. Replacement parts or repair labor costs for units operated outside the United States or Canada.
6. Pickup and delivery. This major appliance is designed to be repaired in the home.
7. Repairs to parts or systems resulting from unauthorized modifications made to the appliance.
8. Expenses for travel and transportation for product service in remote locations.
9. The removal and reinstallation of your appliance if it is installed in an inaccessible location or is not installed in accordance with published installation instructions.

DISCLAIMER OF IMPLIED WARRANTIES; LIMITATION OF REMEDIES

CUSTOMER'S SOLE AND EXCLUSIVE REMEDY UNDER THIS LIMITED WARRANTY SHALL BE PRODUCT REPAIR AS PROVIDED HEREIN. IMPLIED WARRANTIES, INCLUDING WARRANTIES OF MERCHANTABILITY OR FITNESS FOR A PARTICULAR PURPOSE, ARE LIMITED TO ONE YEAR OR THE SHORTEST PERIOD ALLOWED BY LAW. KITCHENAID SHALL NOT BE LIABLE FOR INCIDENTAL OR CONSEQUENTIAL DAMAGES. SOME STATES AND PROVINCES DO NOT ALLOW THE EXCLUSION OR LIMITATION OF INCIDENTAL OR CONSEQUENTIAL DAMAGES, OR LIMITATIONS ON THE DURATION OF IMPLIED WARRANTIES OF MERCHANTABILITY OR FITNESS, SO THESE EXCLUSIONS OR LIMITATIONS MAY NOT APPLY TO YOU. THIS WARRANTY GIVES YOU SPECIFIC LEGAL RIGHTS AND YOU MAY ALSO HAVE OTHER RIGHTS, WHICH VARY FROM STATE TO STATE OR PROVINCE TO PROVINCE.

Outside the 50 United States and Canada, this warranty does not apply. Contact your authorized KitchenAid dealer to determine if another warranty applies.

If you need service, first see the "Troubleshooting" section of the Use & Care Guide. After checking "Troubleshooting," additional help can be found by checking the "Assistance or Service" section or by calling KitchenAid. In the U.S.A., call **1-800-422-1230**. In Canada, call **1-800-807-6777**.

9/05

Keep this book and your sales slip together for future reference. You must provide proof of purchase or installation date for in-warranty service.

Write down the following information about your major appliance to better help you obtain assistance or service if you ever need it. You will need to know your complete model number and serial number. You can find this information on the model and serial number label located on the product.

Dealer name _____

Address _____

Phone number _____

Model number _____

Serial number _____

Purchase date _____