



Instruction Manual

ENG

# DVD HOME THEATER SYSTEM

HT-X70

HT-TX72

HT-TX75



If you have any questions or comments relating to Samsung products, please contact the SAMSUNG customer care center.

Samsung Electronics America, Inc.  
1-800-SAMSUNG (7267864)  
www.samsung.com

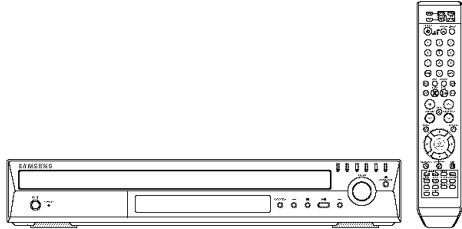

AH68-01951C  
REV: 00



# Safety Warnings

**CAUTION**  
RISK OF ELECTRIC SHOCK.  
DO NOT OPEN

TO REDUCE THE RISK OF ELECTRIC SHOCK, DO NOT REMOVE REAR COVER (or BACK). NO USER SERVICEABLE PARTS INSIDE. REFER SERVICING TO QUALIFIED SERVICE PERSONNEL.

This symbol indicates "dangerous voltage" inside the product that presents a risk of electric shock or personal injury.

This symbol indicates important instructions accompanying the product.

## CLASS 1 LASER PRODUCT

This Compact Disc player is classified as a CLASS 1 LASER product.

**CLASS 1 LASER PRODUCT  
KLASSE 1 LASER PRODUKT  
LUOKAN 1 LASER LAITE  
KLASS 1 LASER APPARAT  
PRODUCTO LASER CLASE 1**

Use of controls, adjustments or performance of procedures other than those specified herein may result in hazardous radiation exposure.

**CAUTION : INVISIBLE LASER RADIATION WHEN OPEN AND INTERLOCKS DEFEATED, AVOID EXPOSURE TO BEAM.**

## Note to CATV system installer

This reminder is provided to call the CATV system installer's attention to Section 820~40 of the NEC which provides guidelines for proper grounding and, in particular, specifies that the cable ground shall be connected to the grounding system of the building, as close to the point of cable entry as practical.

## WARNING

To reduce the risk of fire or electric shock, do not expose this appliance to rain or moisture.

## CAUTION

Apparatus shall not be exposed to dripping or splashing and no objects filled with liquids, such as vases, shall be placed on the apparatus.

## Important Safety Instructions

Read these operating instructions carefully before using the unit. Follow all the safety instructions listed below. Keep these operating instructions handy for future reference.

- 1) Read these instructions.
- 2) Keep these instructions.
- 3) Heed all warnings.
- 4) Follow all instructions.
- 5) Do not use this apparatus near water.
- 6) Clean only with dry cloth.
- 7) Do not block any ventilation openings, install in accordance with the manufacturer's instructions.
- 8) Do not install near any heat sources such as radiators, heat registers, or other apparatus (including amplifiers) that produce heat.
- 9) Do not defeat the safety purpose of the polarized or grounding-type plug. A polarized plug has two blades with one wider than the other. A grounding type plug has two blades and a third grounding prong. The wide blade or the third prong are provided for your safety. If the provided plug does not fit into your outlet, consult an electrician for replacement of the obsolete outlet.
- 10) Protect the power cord from being walked on or pinched particularly at plugs, convenience receptacles, and the point where they exit from the apparatus.
- 11) Only use attachments/accessories specified by the manufacturer.
- 12) Use only with the cart, stand, tripod, bracket, or table specified by the manufacturer, or sold with the apparatus. When a cart is used, use caution when moving the cart/apparatus combination to avoid injury from tip-over.
- 13) Unplug this apparatus during lightning storms or when unused for long periods of time.
- 14) Refer all servicing to qualified service personnel. Servicing is required when the apparatus has been damaged in any way, such as the power-supply cord or plug is damaged, liquid has been spilled or objects have fallen into the apparatus. Service is also required if the apparatus has been exposed to rain or moisture, does not operate normally, or has been dropped.

# Precautions

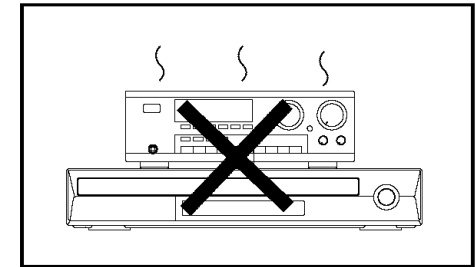
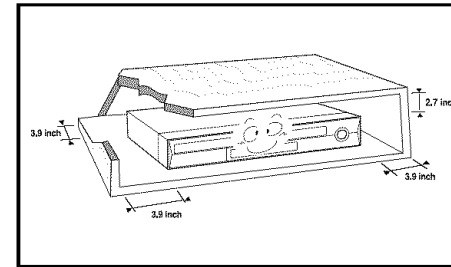

Ensure that the AC power supply in your house complies with the identification sticker located on the back of your player. Install your player horizontally, on a suitable base (furniture), with enough space around it for ventilation (3~4inches). Make sure the ventilation slots are not covered. Do not stack anything on top of the player. Do not place the player on modules or other equipment which may become hot. Before moving the player, ensure the disc tray is empty. This player is designed for continuous use. Switching off the Home Theater to the stand-by mode does not disconnect the electrical supply. In order to disconnect the player completely from the power supply, remove the main plug from the wall outlet, especially when left unused for a long period of time.

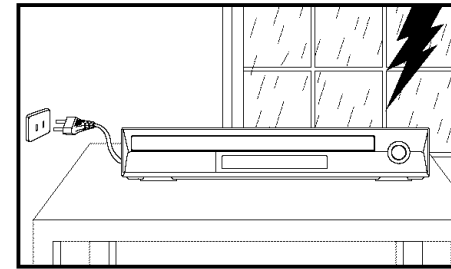

During thunderstorms, disconnect the AC main plug from the wall outlet. Voltage peaks due to lightning could damage the unit. The Mains plug is used as a disconnect device and shall stay readily operable at any time.

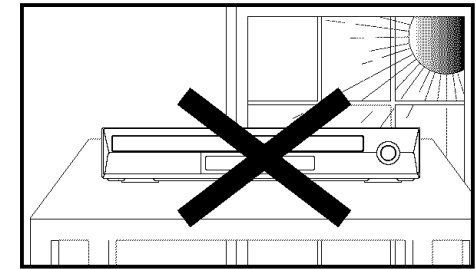

Do not expose the unit to direct sunlight or other heat sources. This could lead to overheating and malfunction of the unit.

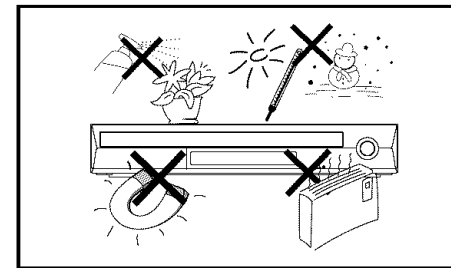

Protect the player from moisture (i.e. vases), and excess heat (e.g. fireplace) or equipment creating strong magnetic or electric fields (i.e. speakers...). Disconnect the power cable from the AC supply if the player malfunctions. Your player is not intended for industrial use. Use of this product is for personal use only. Condensation may occur if your player or disc has been stored in cold temperatures. If transporting the player during the winter, wait approximately 2 hours until the unit has reached room temperature before using.

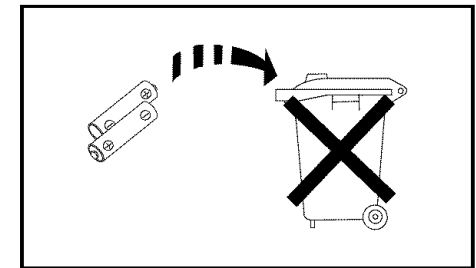

The batteries used with this product contain chemicals that are harmful to the environment. Do not dispose of batteries in the general household trash.

# Features

## Multi-Disc Playback & FM Tuner

The HT-X70/HT-TX72/HT-TX75 combines the convenience of multi-disc playback capability, including DVD-AUDIO, DVD-VIDEO, CD, MP3-CD, WMA-CD, DivX, CD-R/RW, and DVD-R/RW, with a sophisticated FM tuner, all in a single player.

## DVD-Audio compatible

Experience the super high-quality audio performance of DVD-Audio.

The on-board 24-bit/192kHz DAC enables this player to deliver exceptional sound quality in terms of dynamic range, low-level resolution and high-frequency detail.

## USB Host support

You can enjoy media files such as pictures, movies and music saved on an MP3 player, digital camera or USB memory stick by connecting the storage device to the USB port of the Home Theater.

## Dolby Pro Logic II

Dolby Pro Logic II is a form of multi-channel audio signal decoding technology that improves upon existing Dolby Pro Logic.

## DTS (Digital Theater Systems)

DTS is an audio compression format developed by Digital Theater Systems Inc. It delivers full-frequency 5.1 channel sound.

## TV Screen Saver Function

If the main unit remains in Stop mode for 3 minutes, the Samsung logo appears on the TV screen.

The HT-X70/HT-TX72/HT-TX75 will automatically switch to the Power Saving mode after 20 minutes in the Screen Saver mode.

## Power Saving Function

The HT-X70/HT-TX72/HT-TX75 will automatically shut off after 20 minutes in Stop mode.

## Customized TV Screen Display

The HT-X70/HT-TX72/HT-TX75 allows you to select your favorite image during JPEG or DVD playback and set it as your background wallpaper.

## HDMI

HDMI transmits DVD video and audio signals simultaneously, and provides a clearer picture.

## AV SYNC Function

Video may lag behind the audio if the unit is connected to a digital TV.

To compensate for this, you can adjust the audio delay time to sync up with the video.

## Anynet+ (HDMI-CEC) Function

Anynet+ is a function that can be used to operate the main unit using a Samsung TV remote control, by connecting the Home Theater to a SAMSUNG TV using an HDMI Cable. (This is only available with SAMSUNG TV's that support Anynet+.)

## Optional XM radio

Samsung's XM Ready Home Theater Systems give you the opportunity to enjoy America's leading satellite radio service in CD-quality sound.

# Contents

## PREPARATION

Safety Warnings .....	2
Precautions .....	3
Features .....	4
Notes on Discs .....	6
Description .....	8

## CONNECTIONS

Connecting the Speakers .....	12
Speaker Installation .....	15
Connecting the optional Wireless Receiving Amplifier .....	16
Connecting the Video Out to your TV .....	19
Connecting the HDMI IN/OUT .....	20
HDMI Function .....	21
Connecting Audio from External Components .....	23
Connecting the FM Antenna .....	25
Connecting an optional XM Satellite Radio Antenna .....	26

## OPERATION

Before Reading the User's Manual .....	27
Before Using Your Home Theater .....	28
Disc Playback .....	29
MP3/WMA-CD Playback .....	30
JPEG File Playback .....	31
DivX Playback .....	32
Using the Playback Function .....	34
Displaying Disc Information .....	34
Checking the Remaining Time .....	35
Fast Playback .....	35
Slow Playback .....	35
Skipping Scenes/Songs .....	36
Repeat Playback .....	37
To Select a Repeat Playback Mode in the Disc Information Screen .....	37
A-B Repeat Playback .....	38
Step Function .....	38
Angle Function .....	39
Zoom (Screen Enlarge) Function .....	39
EZ VIEW Function .....	40
Bonus Group .....	40
Navigating Pages .....	40
Audio Language Selection Function .....	41
Subtitle Language Selection Function .....	41
Moving Directly to a Scene/Song .....	42
Using the Disc Menu .....	43
Using the Title Menu .....	43
Playing Media Files using the USB Host feature .....	44

## SETUP

Settings .....	46
Setting the Language .....	46
Setting TV Screen Type .....	47
Setting Parental Controls (Rating Level) .....	48
Setting the Password .....	48
Setting the Wallpaper .....	49
To Select One of the 3 Wallpaper Settings you've made .....	49
DVD Playback Mode .....	50
DivX (R) Registration .....	50
Setting the Speaker Mode .....	50
Setting the Delay Time .....	51
Setting the Test Tone .....	52
Setting the Audio .....	53
Setting the DRC (Dynamic Range Compression) .....	54
Setting the AV SYNC .....	54
Setting the HDMI Audio .....	55
Sound Field (DSP)/EQ Function .....	56
Dolby Pro Logic II Mode .....	57
Dolby Pro Logic II Effect .....	58

## MISCELLANEOUS

Listening to Radio .....	59
XM Satellite Radio .....	61
Convenient Functions .....	65
Operating a TV with the Remote Control .....	66
Troubleshooting .....	68
Cautions on Handling and Storing Discs .....	70
Language Code List .....	71
USB Host Feature Supported Products .....	72
Specifications .....	73

# Notes on Discs

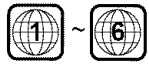

DVD players and the discs are coded by region. These regional codes must match in order for the disc to play. If the codes do not match, the disc will not play. The Region Number for this player is given on the rear panel of the player. (Your DVD player will only play DVDs that are labeled with identical region codes.)

## Playable Discs



Disc Type	Mark (Logo)	Recorded Signals	Disc Size	Max. Playing Time
DVD-AUDIO DVD-VIDEO		Audio + Video	5"	Approx. 240 min. (single-sided) Approx. 480 min. (double-sided)
			3 1/2"	Approx. 80 min. (single-sided) Approx. 160 min. (double-sided)
AUDIO-CD		Audio	5"	74 min.
			3 1/2"	20 min.
DivX		Audio + Video	5"	74 min.
			3 1/2"	20 min.

## Do not use the following types of disc!



- LD, CD-G, CD-I, CD-ROM and DVD-ROM discs cannot be played on this player. If such discs are played, a <WRONG DISC FORMAT> message appears on the TV screen.
- DVD discs purchased abroad may not play on this player. If such discs are played, a <CAN'T PLAY THIS DISC PLEASE, CHECK REGION CODE> message appears on the TV screen.

## Copy Protection

- Many DVD discs are encoded with copy protection. Because of this, you should only connect your DVD player directly to your TV, not to a VCR. Connecting to a VCR results in a distorted picture from copy-protected DVD discs.
- This product incorporates copyright protection technology that is protected by methods claims of certain U.S. patents and other intellectual property rights owned by Macrovision Corporation and other rights owners. Use of this copyright protection technology must be authorized by Macrovision Corporation, and is intended for home and other limited viewing uses only unless otherwise authorized by Macrovision Corporation. Reverse engineering or disassembly is prohibited.

### This product is covered by one or more of the following U.S. patents:

5,060,220 5,457,669 5,561,649 5,705,762 5,987,417 6,043,912 6,222,983 6,272,096 6,377,524 6,377,531  
6,385,587 6,389,570 6,408,408 6,466,532 6,473,736 6,477,501 6,480,829 6,556,520 6,556,521 6,556,522  
6,578,163 6,594,208 6,631,110 6,658,588 6,674,697 6,674,957 6,687,455 6,697,307 6,707,985 6,721,243  
6,721,493 6,728,474 6,741,535 6,744,713 6,744,972 6,765,853 6,765,853 6,771,890 6,771,891 6,775,465  
6,778,755 6,788,629 6,788,630 6,795,637 6,810,201 6,862,256 6,868,054 6,894,963 6,937,552

### This product is covered by the following U.S. patents:

US4,930,158 US4,930,160

## Disc Recording Format

**This product does not support Secure (DRM) Media files.**

### CD-R Discs

- Some CD-R discs may not be playable depending on the disc recording device (CD-Recorder or PC) and the condition of the disc.
- Use a 650MB/74 minute CD-R disc. Do not use CD-R discs over 700MB/80 minute as they may not be playback.
- Some CD-RW (Rewritable) media, may not be playable.
- Only CD-Rs that are properly "closed" can be fully played. If the session is closed but the disc is left open, you may not be able to fully play the disc.

### CD-R MP3 Discs

- Only CD-R discs with MP3 files in ISO 9660 or Joliet format can be played.
- MP3 file names should be 8 characters or less in length and contain no blank spaces or special characters (. / = +).
- Use discs recorded with a compression/decompression data rate greater than 128Kbps.
- Only files with the "mp3" and extensions can be played.
- Only a consecutively written multisession disc can be played. If there is a blank segment in the Multisession disc, the disc can be played only up to the blank segment.
- If the disc is not closed, it will take longer to begin playback and not all of the recorded files may be played.
- For files encoded in Variable Bit Rate (VBR) format, i.e. files encoded in both low bit rate and high bit rate (e.g., 32Kbps ~ 320Kbps), the sound may skip during playback.
- A maximum of 500 tracks can be played per CD.
- A maximum of 300 folders can be played per CD.

### CD-R JPEG Discs

- Only files with the "jpg" extensions can be played.
- If the disc is not closed, it will take longer to start playing and not all of the recorded files may be played.
- Only CD-R discs with JPEG files in ISO 9660 or Joliet format can be played.
- JPEG file names should be 8 characters or less in length and contain no blank spaces or special characters (. / = +).
- Only a consecutively written multisession disc can be played. If there is a blank segment in the multisession disc, the disc can be played only up to the blank segment.
- A maximum of 9,999 images can be stored on a single CD.
- When playing a Kodak/Fuji Picture CD, only the JPEG files in the picture folder can be played.
- Picture discs other than Kodak/Fuji Picture CDs may take longer to start playing or may not play at all.

### DVD±R/RW, CD-R/RW DivX Discs

- Since this product only provides encoding formats authorized by DivX Networks, Inc., a DivX file created by the user might not be play.
- Software update for incompatible formats is not supported. (Example : QPEL, GMC, resolution higher than 800 x 600 pixels, etc.)
- Sections with a high frame rate might not be played while playing a DivX file.
- For more information about the formats authorized by DivX Networks, Inc., please visit "www.divxnetworks.net".

## Front Panel

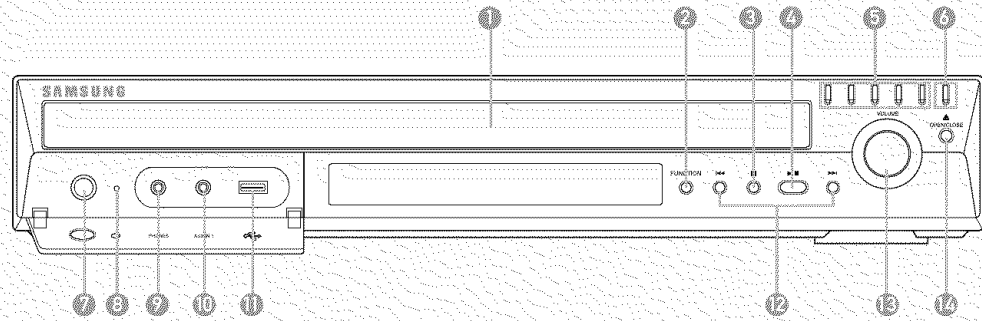

- |                            |                       |                                  |
|----------------------------|-----------------------|----------------------------------|
| 1. Disc Tray               | 6. Disc Change button | 11. USB Port                     |
| 2. Function button         | 7. Power (⏻/⏿) button | 12. Tuning Up & Skip (▶▶) button |
| 3. Stop (■) button         | 8. Standby indicator  | Tuning Down & Skip (◀◀) button   |
| 4. Play/Pause (▶  ) button | 9. Headphone Jack     | 13. Volume Control               |
| 5. Direct Play buttons     | 10. AUX IN 1 Jack     | 14. Open/Close button            |

## Display

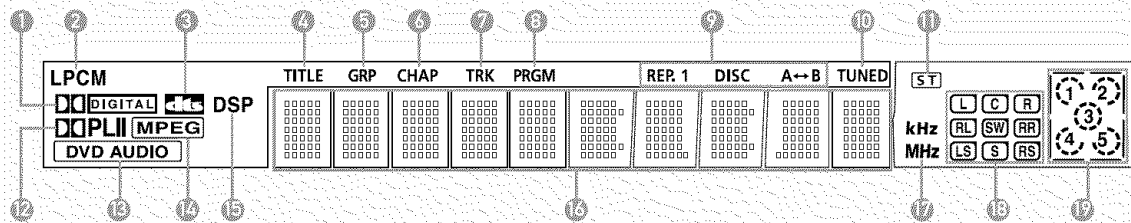

- |                            |                          |                               |
|----------------------------|--------------------------|-------------------------------|
| 1. DOLBY DIGITAL indicator | 8. PROGRAM indicator     | 15. DSP indicator             |
| 2. LINEAR PCM indicator    | 9. REPEAT indicator      | 16. System Status Display     |
| 3. DTS indicator           | 10. TUNED indicator      | 17. RADIO FREQUENCY indicator |
| 4. TITLE indicator         | 11. STEREO indicator     | 18. SPEAKER indicator         |
| 5. GROUP indicator         | 12. DOLBY PLII indicator | 19. DISC(1~5) indicator       |
| 6. CHAPTER indicator       | 13. DVD AUDIO indicator  |                               |
| 7. TRACK indicator         | 14. MPEG indicator       |                               |

## Rear Panel

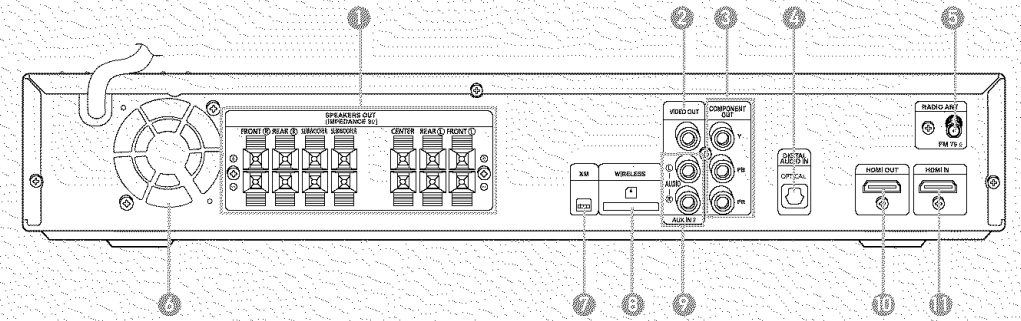

- |   |                                 |
|---|---------------------------------|
| 1. 5.1 Channel Speaker Output Connectors  | 5. FM 75Ω COAXIAL Jack          |
| 2. Video Output Jack<br>Connect your TV's Video Input jack (VIDEO IN) to the VIDEO OUT Jack on this unit.   | 6. Cooling Fan                  |
| 3. Component Video Output Jacks<br>Connect a TV with Component video inputs to these jacks.                 | 7. XM Antenna Jack              |
| 4. External Digital Optical Input Jack<br>Use this to connect external equipment capable of digital output. | 8. TX Card Connection(WIRELESS) |
|   | 9. AUX IN 2 Jacks               |
|   | 10. HDMI Output Jack            |
|   | 11. HDMI Input Jack             |

## Accessories

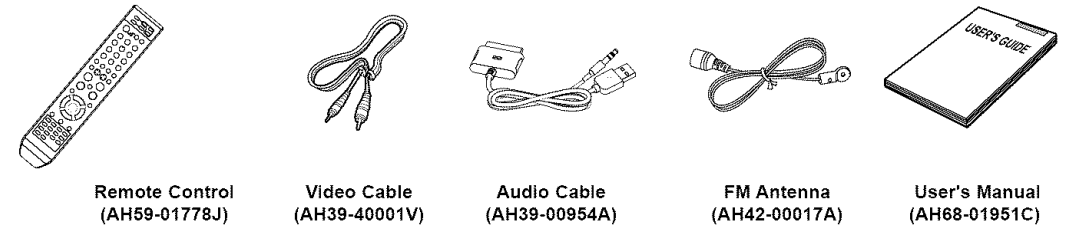

Remote Control (AH59-01778J)

Video Cable (AH39-40001V)

Audio Cable (AH39-00954A)

FM Antenna (AH42-00017A)

User's Manual (AH68-01951C)

## Remote Control

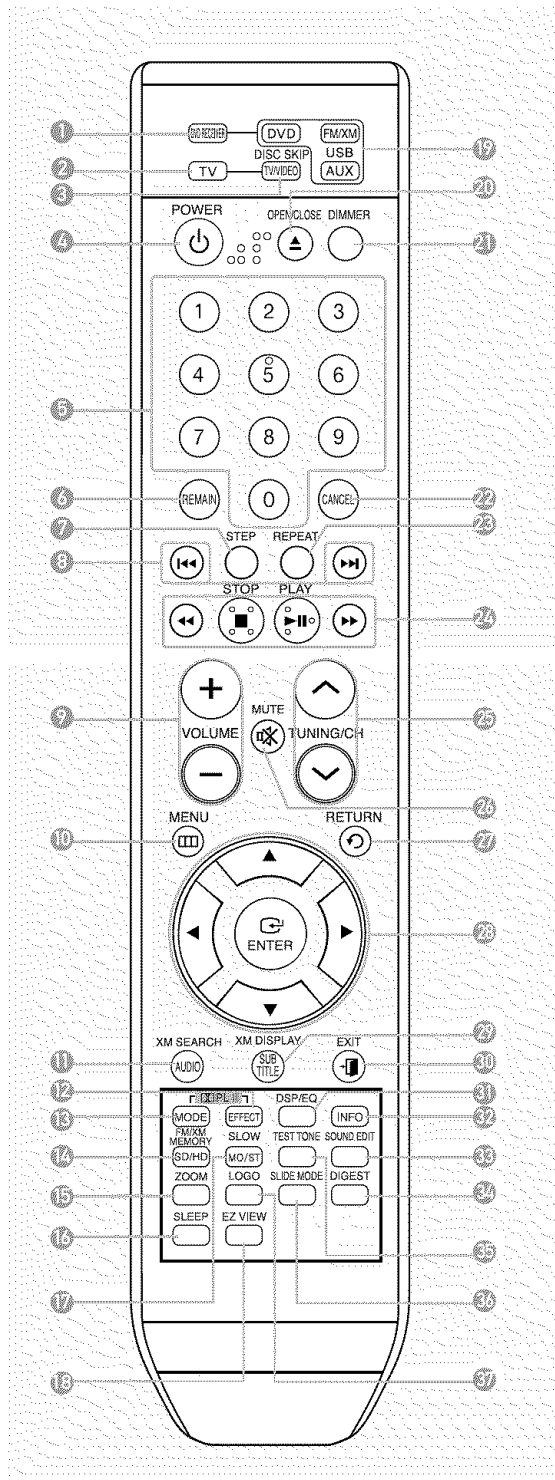

1. DVD RECEIVER button
2. TV button
3. TV/VIDEO, DISC SKIP button
4. POWER button
5. Number(0~9) buttons
6. REMAIN button
7. STEP button
8. Tuning Preset/CD Skip buttons
9. VOLUME button
10. MENU button
11. XM SEARCH, AUDIO button
12. PL II EFFECT button
13. PL II MODE button
14. FM/XM MEMORY, SD(Standard Definition)/HD(High Definition) button
15. ZOOM button
16. SLEEP button
17. SLOW, MO/ST button
18. EZ VIEW button
19. DVD button
20. FM/XM button
21. USB, AUX button
22. OPEN/CLOSE button
23. DIMMER button
24. CANCEL button
25. REPEAT button
26. PLAY/PAUSE button
27. STOP button
28. SEARCH buttons
29. TUNING/CH button
30. MUTE button
31. RETURN button
32. Cursor/ENTER button
33. XM DISPLAY, SUBTITLE button
34. EXIT button
35. DSP/EQ button
36. INFO button
37. SOUND EDIT button
38. DIGEST button
39. TEST TONE button
40. SLIDE MODE button
41. LOGO button

## Insert Remote Batteries

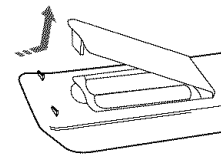

- 1 Remove the battery cover in the direction of the arrow.
- 2 Insert two 1.5V AAA batteries, paying attention to the correct polarities (+ and -).
- 3 Replace the battery cover.

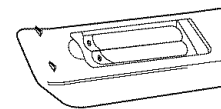

- !** Follow these precautions to avoid leaking or cracking cells:
- Place batteries in the remote control so they match the polarity : (+) to (+) and (-) to (-).
  - Use the correct type of batteries. Batteries that look similar may differ in voltage.
  - Always replace both batteries at the same time.
  - Do not expose the batteries to heat or a flame.

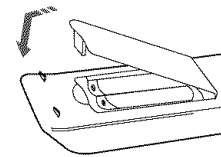

## Operation Range of the Remote Control

The remote control can be used up to approximately 23 feet (7 meters) in a straight line. It can also be operated at a horizontal angle of up to 30° from the remote control sensor.

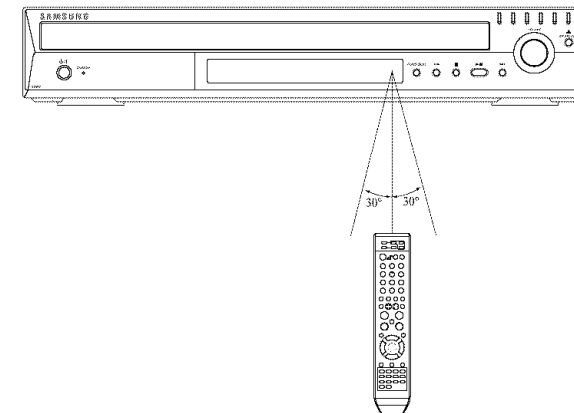

# Connecting the Speakers

Before moving or installing the product, be sure to turn off the power and disconnect the power cord.

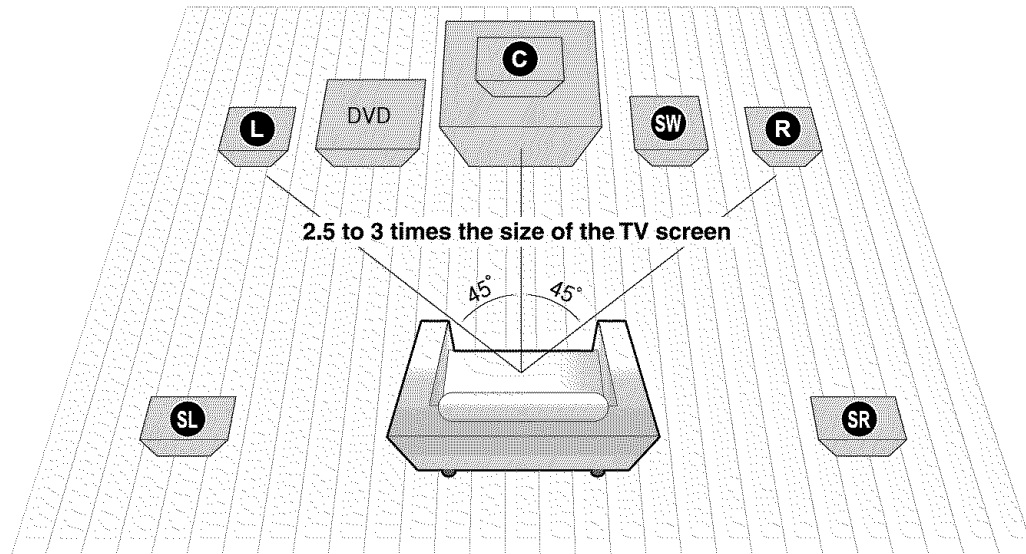

## Position of the Home Theater

- Place it on a stand, cabinet shelf, or under the TV stand.

## Front Speakers **L R**

- Place these speakers in front of your listening position, facing inwards (about 45°) toward you.
- Place the speakers so that their tweeters will be at the same height as your ear.
- Align the front face of the front speakers with the front face of the center speaker or place them slightly in front of the center speakers.

## Center Speaker **C**

- It is best to install it at the same height as the front speakers.
- You can also install it directly over or under the TV.

## Selecting the Listening Position

The listening position should be located about 2.5 to 3 times the distance of the TV's screen size away from the TV.  
 Example : For 32" TVs 2~2.4m (6~8 feet)  
 For 55" TVs 3.5~4m (11~13 feet)

## Rear Speakers **SL SR**

- Place these speakers behind your listening position.
  - If there isn't enough room, place these speakers so they face each other.
  - Place them about 60 to 90cm (2 to 3feet) above your ear, facing slightly downward.
- \* Unlike the front and center speakers, the rear speakers are used to handle mainly sound effects and sound will not come from them all the time.
- \* **Sound will be heard from the rear speakers in DVD 5.1-CH or Dolby Pro Logic II mode only.**

## Subwoofer **SW**

- The position of the subwoofer is not so critical. Place it anywhere you like.

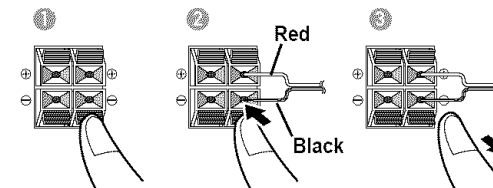
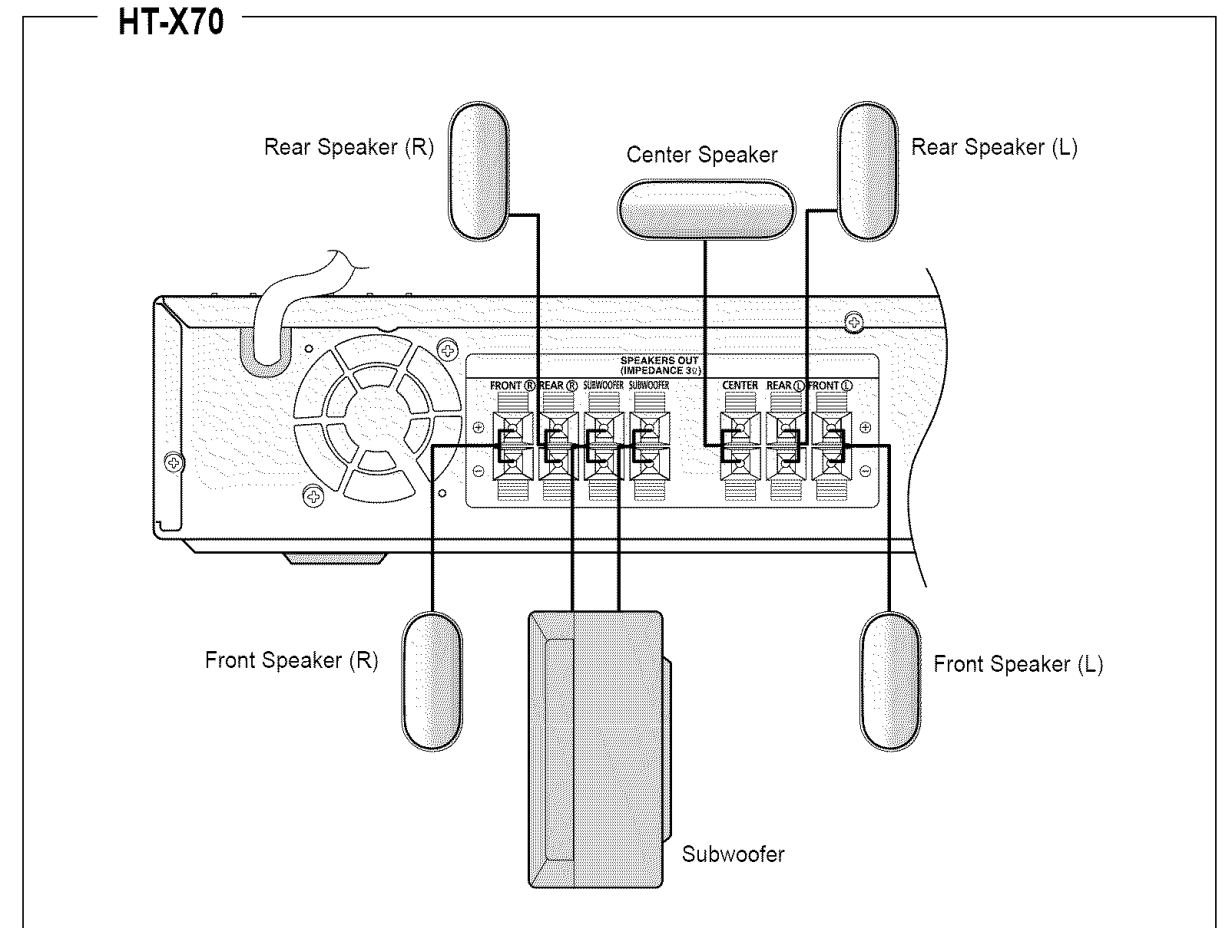

- 1 Press and hold the terminal tab.
- 2 Insert the black wire into the black terminal (-) and the red wire into the red (+) terminal.
- 3 Release your finger.

- Do not let children play with or near the speakers. They could get hurt if a speaker falls.
- When connecting the speaker wires to the speakers, make sure that the polarity (+/-) is correct.
- Keep the subwoofer speaker out of reach of children so as to prevent children from inserting their hands or alien substances into the duct (hole) of the subwoofer speaker.
- Do not hang the subwoofer on the wall through the duct (hole).

- If you place a speaker near your TV set, screen color may be distorted because of the magnetic field generated by the speaker. If this occurs, place the speaker away from your TV set.

# Connecting the Speakers (Con't)

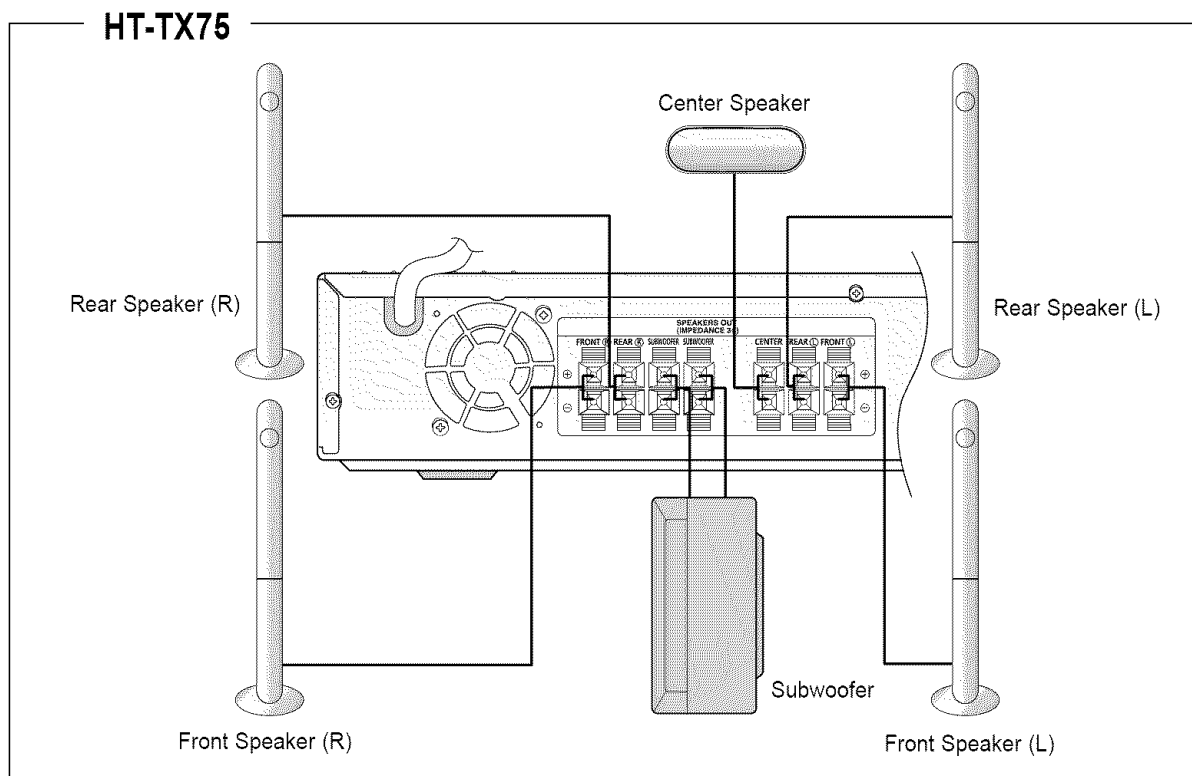
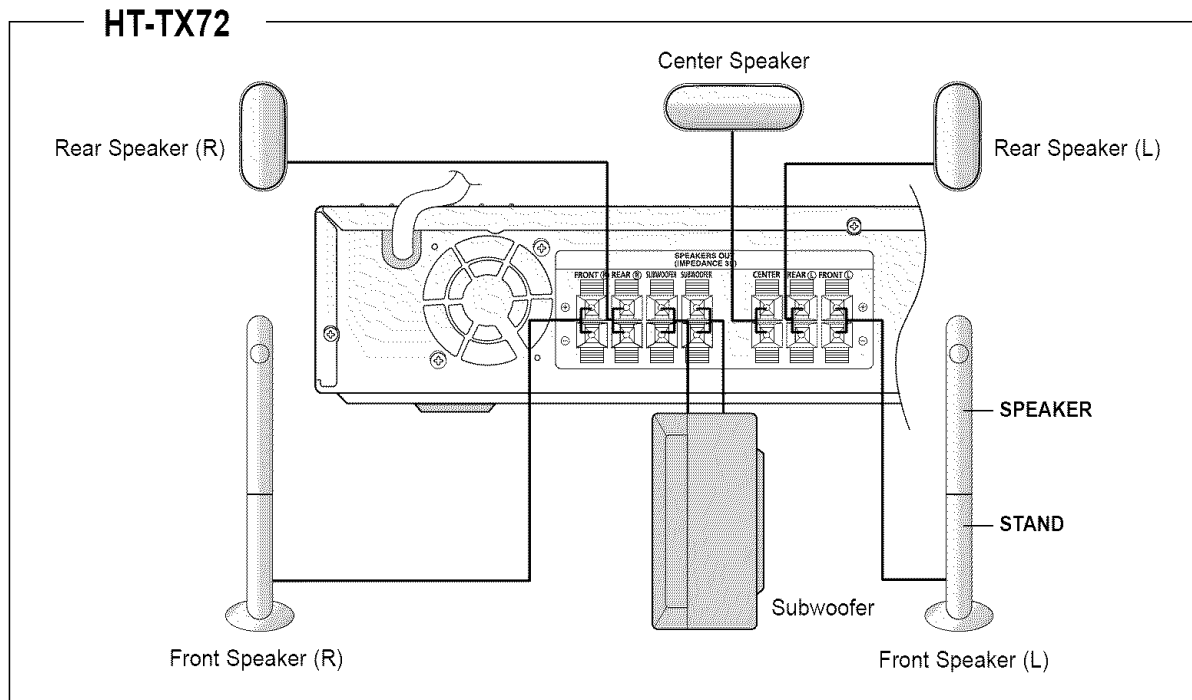

# Speaker Installation

With the HT-TX72 front speakers and HT-TX75 front/rear speakers, you have the option of installing the speakers on Stands, or directly to the Stand Base.

## Speaker Components (HT-TX72/HT-TX75 only)

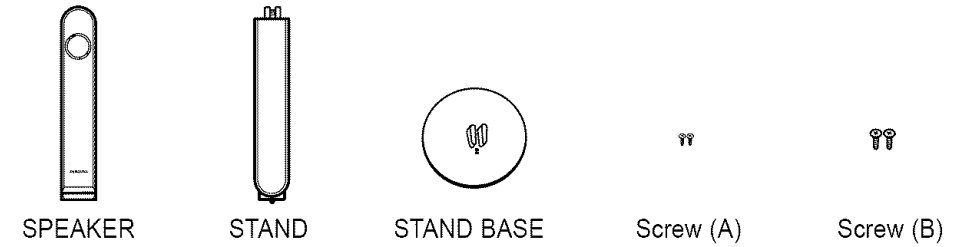

## How to Install the Speaker on the Stand

- Turn the STAND upside-down and connect it to the STAND BASE.
  - Insert two screws (A) into the two holes marked with arrows using a screwdriver as shown in the illustration.
  - Insert a screw (B), into the hole on the rear of the Speaker STAND.
  - Connect the assembled stand to the SPEAKER.
  - Insert another screw (B) into the hole on the rear of the speaker using a screwdriver as shown in the illustration.
  - This is the SPEAKER successfully assembled with the Stand.
- !** • Make sure that the speaker is installed on a flat and stable area. Otherwise it may be easily knocked over.

## How to Install the Speaker on the Stand Base

- Connect the SPEAKER with the STAND BASE.
- Insert the screw (B) into the hole on the rear of the speaker using a screwdriver as shown in the illustration.
- This is the SPEAKER successfully assembled with the Stand Base.



# Connecting the Optional Wireless Receiving Amplifier

To connect the rear speakers wirelessly, you have to purchase the wireless receiving module and TX card from your Samsung retailer.

## When you have Purchased the Wireless Receiving Module (SWA-3000)

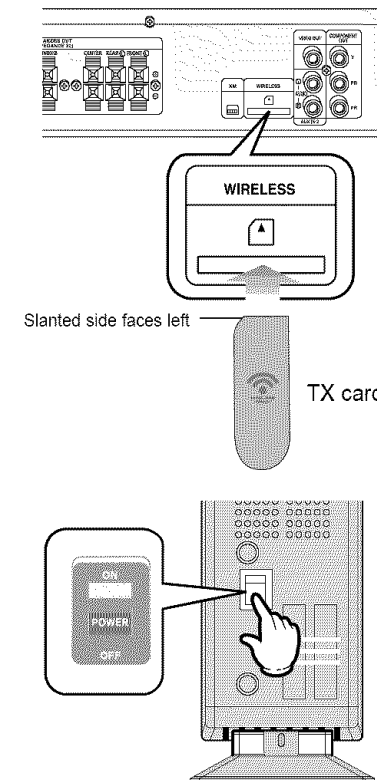
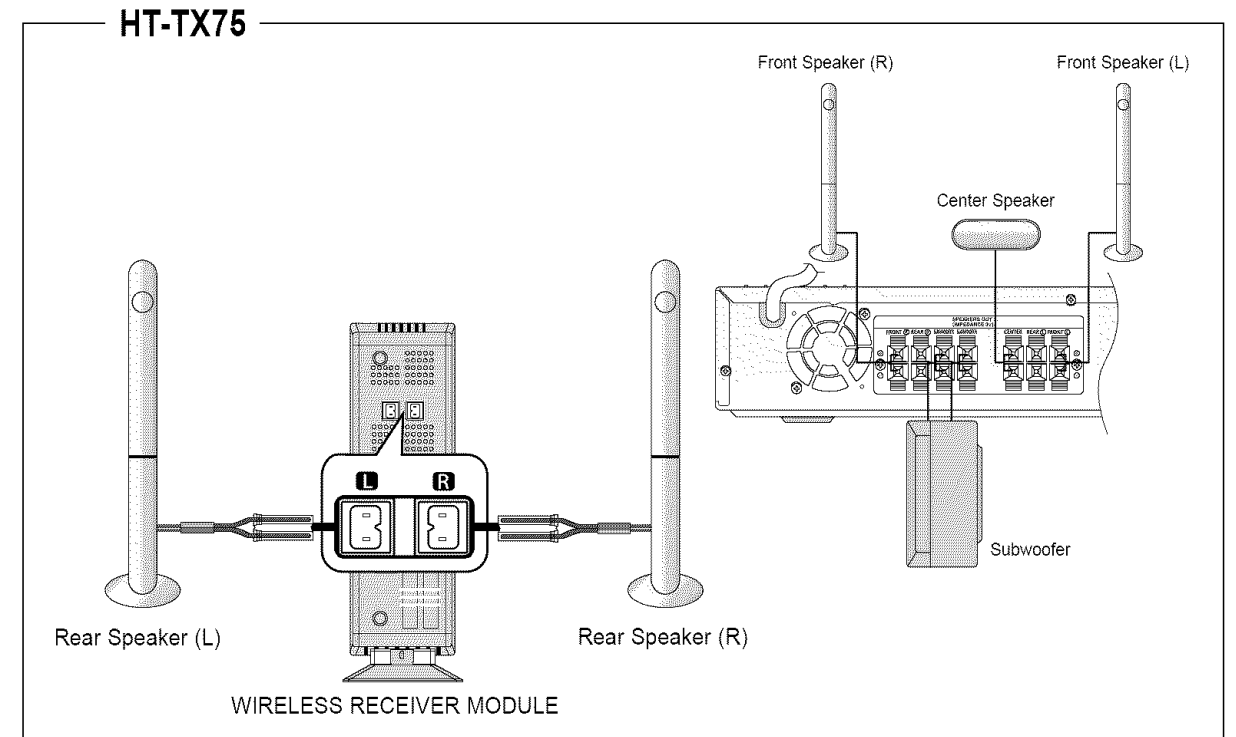
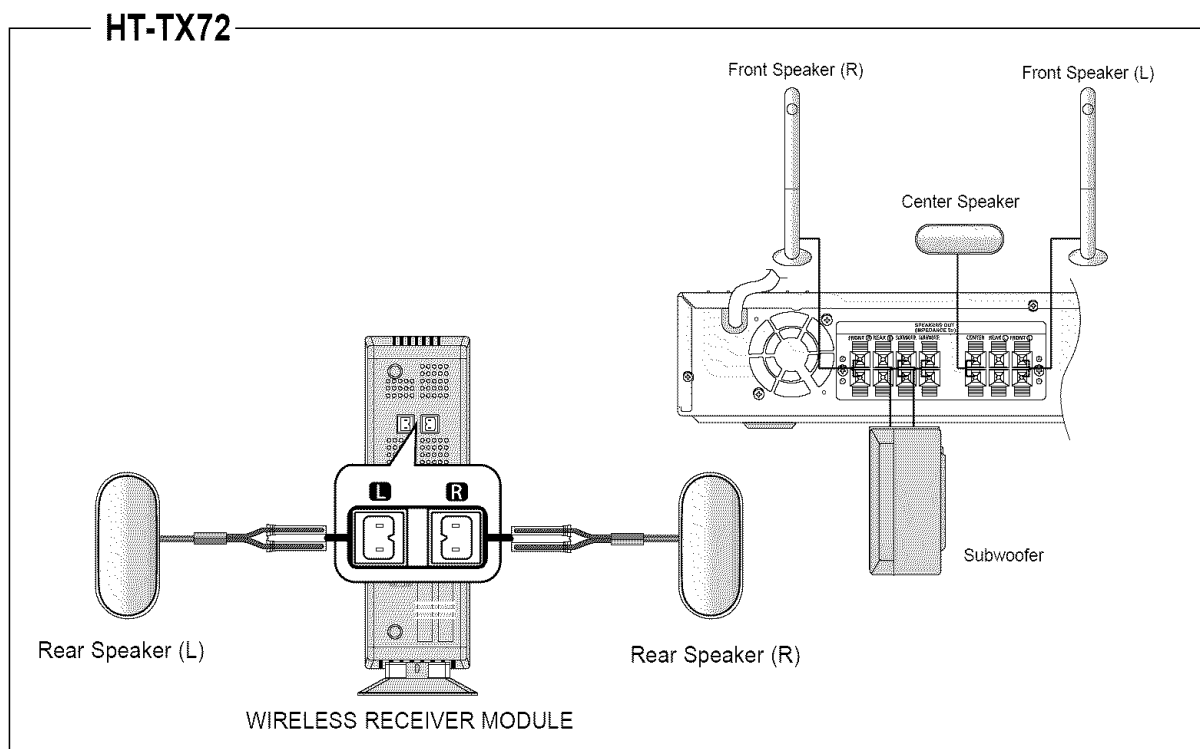
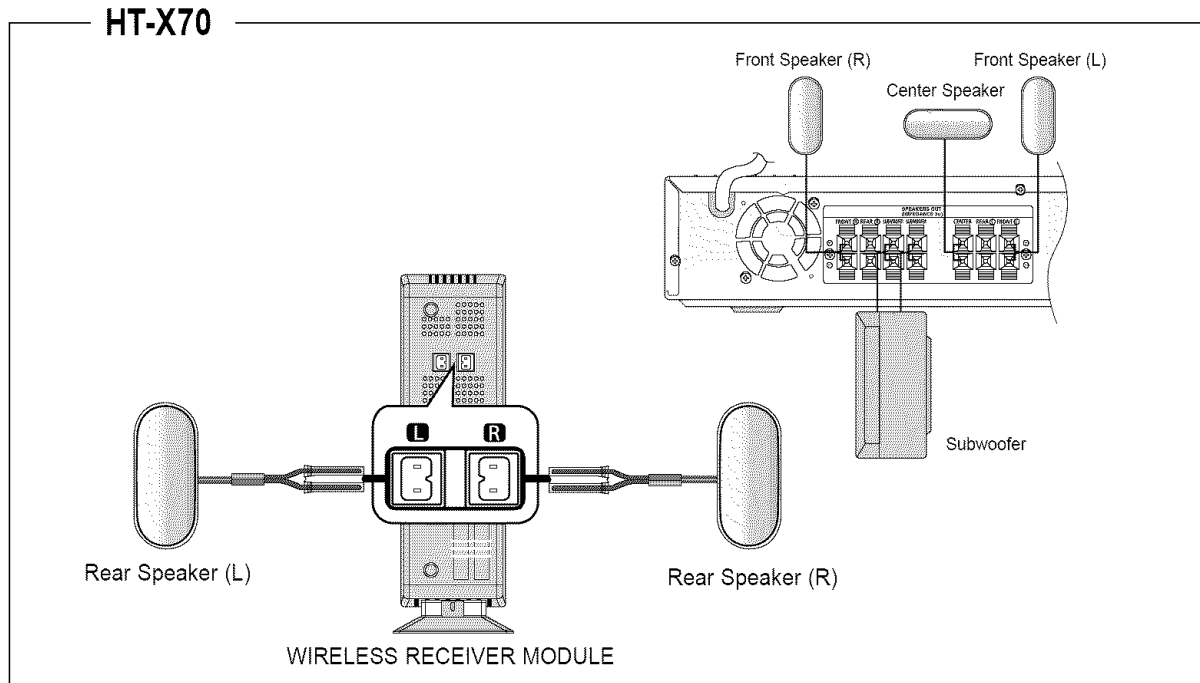

- 1 Connect the Front, Center and Subwoofer speakers to the DVD Player, referring to pages 13~15.
- 2 With the DVD Player turned off, insert the TX card into the TX Card Connection(WIRELESS) on the back of the main unit.
  - Hold the TX card so that the slanted side faces leftward and insert the card into the port.
  - The TX card enables communication between the main unit and the wireless receiver.
- 3 Connect the left and right rear speakers to the wireless receiving module.
- 4 Plug the power cord of the wireless receiving module in the wall outlet and switch the power switch <ON>.

- ! Do not insert a card other than the TX card dedicated for the product. The product might be damaged or the card may not be removed easily.
- Do not insert the TX card upside down or in the reverse direction.
- Insert the TX card when the DVD Player is turned off. Inserting the card when it is turned on may cause a problem.
- If the TX Card is inserted, sound is not output from the Rear Speaker connectors on the main unit.

# Connecting the Optional Wireless Receiving Amplifier (Con't)

## Resetting the Wireless Receiving Module

Reset the system if a communication failure occurs, or if the Link indicator (blue LED) on the wireless receiver does not light up and the "REAR CHECK" message blinks on the main unit's display.  
Reset the system while the main unit and the wireless receiver module (SWA-3000) are in Power Standby mode.

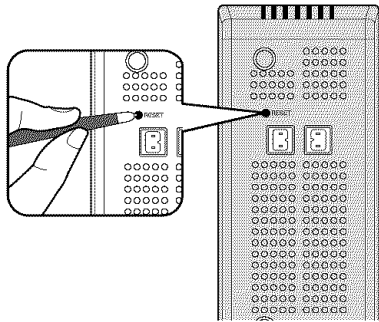

- 1 With the main unit turned off, press and hold the remote control's REMAIN button for 5 seconds.
  - The STANDBY LED on the front panel of the wireless receiver module blinks.
- 2 With the wireless receiver module turned on, use a ball point pen or a toothpick to press the **RESET** button on the back of the unit.
  - The STANDBY LED on the front panel of the wireless receiver module blinks 2 Times.
- 3 Turn on the main unit.
  - The LINK LED of the wireless receiver module is lit and the Reset is completed.
  - If Power Standby mode continues, repeat Steps 1 to 3 above.

- ! When the wireless receiving module setting is complete, no sound is output from the Rear Speaker Output Connectors on the back of the main unit.
- The wireless receiving antenna is built into the wireless receiver module. Keep the unit away from water and moisture.
- For optimal listening performance, make sure that the area around the wireless receiver module location is clear of any obstructions.
- Sound will be heard from the wireless rear speakers in DVD 5.1-CH or Dolby Pro Logic II mode only.**
- In 2-CH mode, no sound will be heard from the wireless rear speakers.

- Place the wireless receiver module at the rear of the listening position. If the wireless receiver module is too close to the main unit, some sound interruption may be heard due to interference.
- If you use a device such as a microwave oven, wireless LAN Card, Bluetooth equipment, or any other device that uses the same frequency (2.4GHz) near the system, some sound interruption may be heard due to interference.
- The transmission distance of a radio wave is about 33 feet, but may vary depending on your operating environment. If a steel-concrete wall or metallic wall is between the main unit and the wireless receiver module, the system may not operate at all, because the radio wave cannot penetrate metal.

# Connecting the Video Out to your TV

Choose one of the three methods for connecting to a TV.

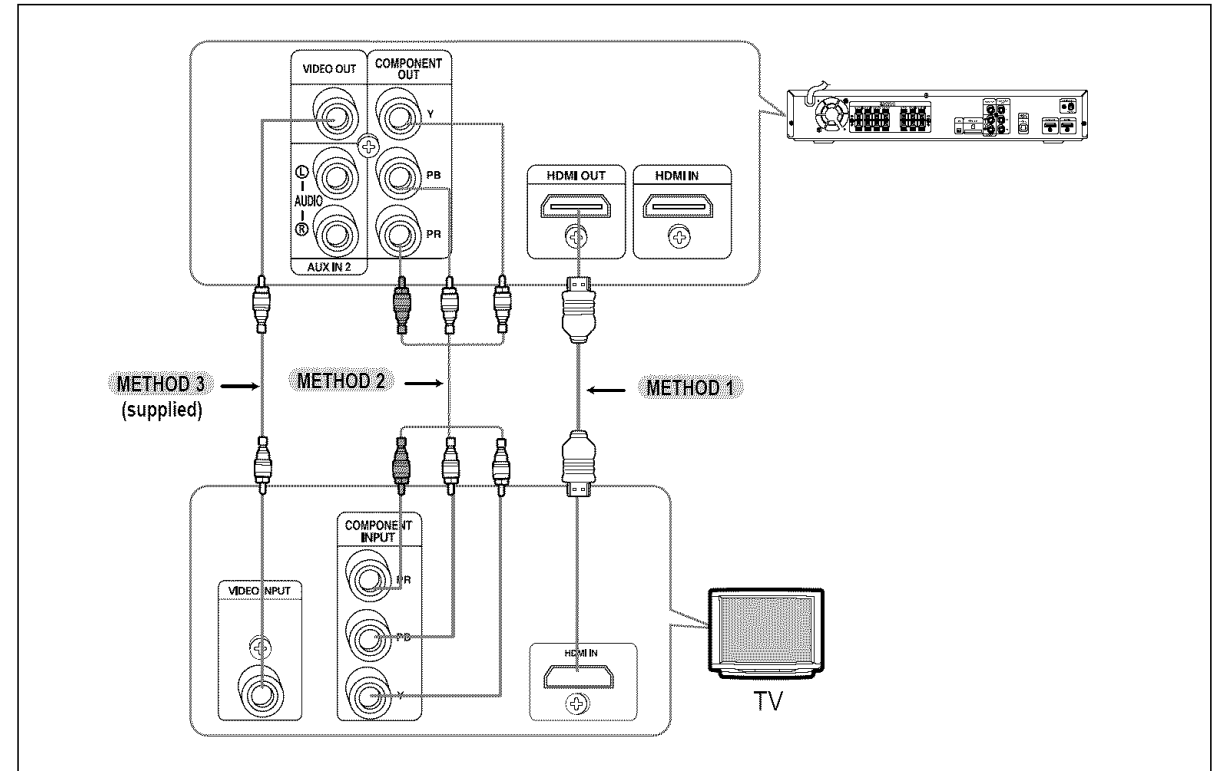

### METHOD 1 : HDMI ..... (Best Quality)

Connect the HDMI cable (not supplied) from the HDMI OUT jack on the back of the DVD Player to the HDMI IN jack on your TV.

### METHOD 2 : Component Video ..... (Better Quality)

If your television is equipped with Component Video inputs, connect a Component video cable(not supplied) from the Component Video Output (Pr, Pb and Y) jacks on the back of the DVD Player to the Component Video Input jacks on your TV.

### METHOD 3 : Composite Video ..... (Good Quality)

Connect the supplied Video cable from the VIDEO OUT jack on the back of the DVD Player to the VIDEO IN jack on your TV.

- This product operates in Interlace scan mode(480i Only ) for Component Output.
- After making the video connection, set the Video input source on your TV to match the corresponding Video output (HDMI, Component or Composite) on your Home theater. See your TV owner's manual for more information on how to select the TV's Video Input source.
- If you use an HDMI cable to connect a Samsung TV to the DVD Player, you can operate the Home Theater using the TV's remote control. This is only available with SAMSUNG TVs that support Anynet+(HDMI-CEC).
- Please check the **Anynet+** logo. If your TV has an **Anynet+** logo, then it supports the Anynet+ function.

# Connecting the HDMI IN/OUT

HDMI (High-Definition Multimedia Interface) is an interface that enables the digital transmission of video and audio data with just a single cable. In addition, it enables you to enjoy multi-channel digital audio.

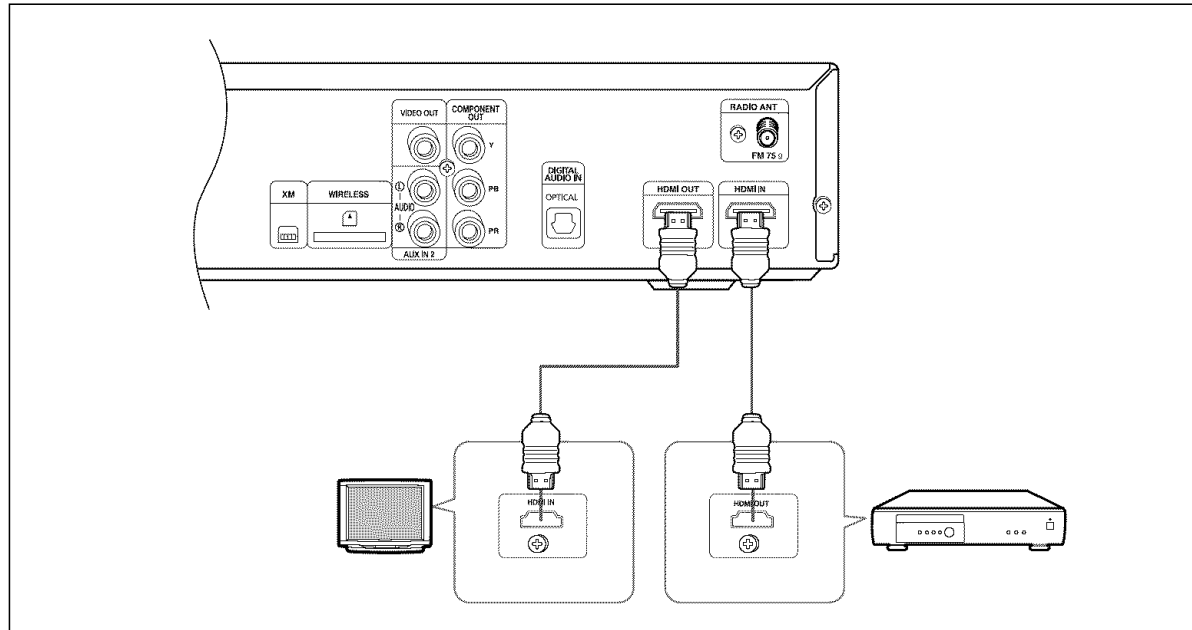

- 1 Connect the HDMI IN jack of this unit and the HDMI OUT jack of a Cable Box/Satellite receiver (Set-Top Box).
- 2 Connect the HDMI OUT jack of this unit and the HDMI IN jack of your TV.
- 3 Press the **AUX** button on the remote control to select <HDMI IN>.
  - You can also use the **FUNCTION** button on the main unit.  
The mode switches as follows: DVD/CD → DIGITAL IN → AUX 1 → AUX 2 → HDMI IN → USB → FM → XM.

- When this unit is turned off, no HDMI video or audio signal is output from this unit.
- When a CableBox/Satellite Receiver is connected to HDMI IN, the SD/HD(Standard Definition/HighDefinition) button on the Remote control does not work.
- When an external device is connected to this unit via DVI, no audio will be output. In this case, you can listen to the digital audio by connecting the Optical OUT of the external device to the Optical IN of this unit.

# HDMI Function

## Resolution Selection

This function allows the user to select the screen resolution for HDMI output.

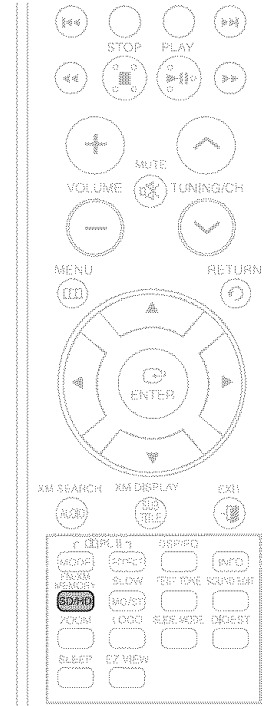

In Stop mode, press and hold the **SD/HD** (Standard Definition/High Definition)button on the remote control.

- Resolutions available for the HDMI output are 480p, 720P and 1080i.
- SD(Standard Definition) resolution is 480p and HD(High Definition) resolution is 720p/1080i.

- If the TV does not support the configured resolution, you will not be able to see the picture properly.
- When a HDMI TV is connected, composite and component video signals are not output.
- See your TV owner's manual for more information on how to select the TV's Video Input source.

### Why use HDMI (High Definition Multimedia Interface)?

This device transmits a DVD video signal digitally without the process of converting to analog. You will get sharper digital pictures when using an HDMI connection.

## Using Anynet+(HDMI-CEC)

Anynet+ is a function that enables you to control other Samsung Devices with your Samsung TV's remote control. Anynet+ can be used by connecting this Home Theater to a SAMSUNG TV using an HDMI Cable. This is only available with SAMSUNG TVs that support Anynet+.

- 1 Connect the main unit of the Home Theater to a Samsung TV with an HDMI cable. (See page 19)
- 2 Set the Anynet+ function on your TV. (See the TV instruction manual for more information.)
  - You can operate the Home Theater by using the TV remote control. (Available TV buttons : ◀, ▶, ⏪, ⏩, ▲, ▼ and ◀, ▶ buttons, ① ~ ⑨ button)

### If you select TV

Set the Anynet+(HDMI-CEC) function to <On> on your TV.

- <Receiver : On> : You can listen to audio through the Home Theater.
- <Receiver : Off> : You can listen to audio through the TV.

### If you select the THEATER

Select <THEATER to connector> and set the option of each items below.

- <View TV> : If Anynet+(HDMI-CEC) set to on and you select View TV, the Home Theater will automatically switch to DIGITAL IN.
- <THEATER Menu> : You can access the Home Theater menu.
- <THEATER Operation> : The Home Theater disc playback information will be displayed.
- <Receiver : On> : You can listen to audio through the Home Theater.
- <Receiver : Off> : You can listen to audio through the TV.

- When selecting View TV, you must have a digital optical cable connected from the TV to the Home Theater to listen to the TV sound through the Home Theater.
- If Anynet+ (HDMI-CEC) is on and you turn off the main unit, your TV will also turn off.
- Anynet+ (HDMI-CEC) will only work while in the DVDmode.

#### With Anynet+

You can operate this unit, power on your TV, or watch a movie by pressing the Play button on your Samsung TV's remote control.

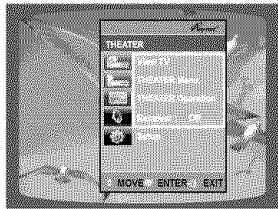
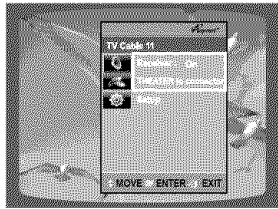

## AUX1 : Front Panel (iPod only)

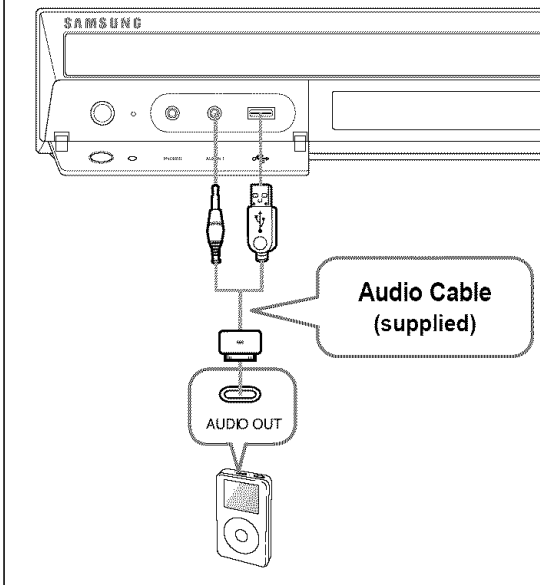

## AUX1 : Front Panel (MP3 player)

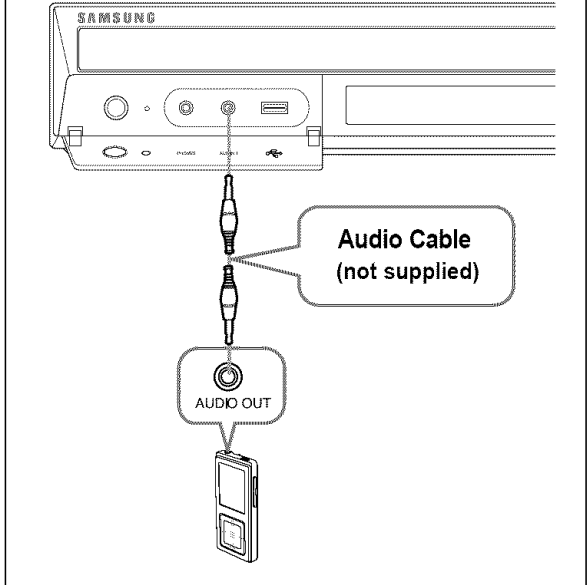

## AUX1 : Connecting an MP3 player or iPod

You can listen to the audio from an MP3 player/iPod through the main unit.

- 1 Connect AUX IN 1 (Audio) on the Home Theater to the Audio Out of an MP3 player or iPod.
- 2 Press the **AUX** button on the remote control to select <AUX1> input.
  - You can also use the **FUNCTION** button on the main unit. The mode switches as follows : DVD/CD → DIGITAL IN → AUX 1 → AUX 2 → HDMI IN → USB → FM → XM.

- When the unit is powered on and you connect an iPod MP3 player, the unit will charge your iPod's battery.

"iPod is registered trade mark of Apple Computer, Inc"

## Connecting Audio from External Components (Con't)

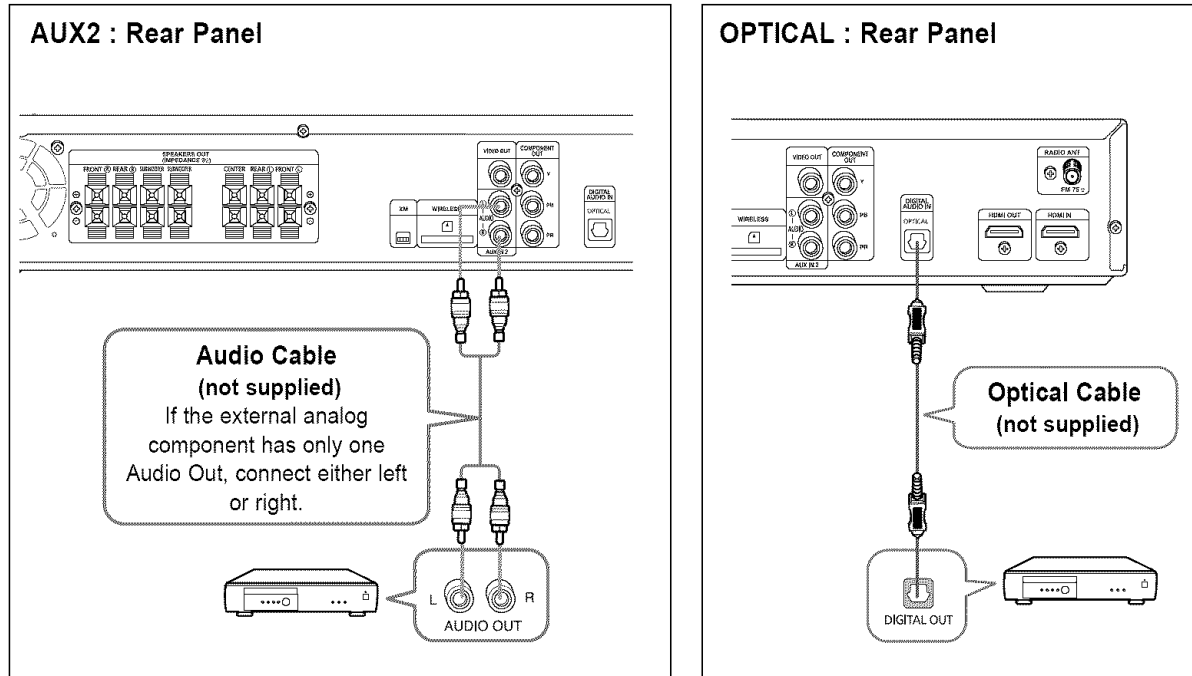

### AUX2 : Connecting an External Analog Component

Analog signal components such as a VCR.

- 1 Connect the AUX IN 2 (Audio) on the Home Theater to the Audio Out of the external analog component.
  - Be sure to match connector colors.
- 2 Press the **AUX** button on the remote control to select <AUX2> input.
  - You can also use the **FUNCTION** button on the main unit.
  - The mode switches as follows : DVD/CD → DIGITAL IN → AUX 1 → AUX 2 → HDMI IN → USB → FM → XM.

• You can connect the Video Output jack of your VCR to the TV, and connect the Audio Output jacks of the VCR to this product.

### OPTICAL : Connecting an External Digital Component

Digital signal components such as a Set-Top Box.

- 1 Connect the Digital Input (OPTICAL) on the Home Theater to the Digital Output of the external digital component.
- 2 Press the **AUX** button on the remote control to select <DIGITAL IN>.
  - You can also use the **FUNCTION** button on the main unit.
  - The mode switches as follows : DVD/CD → DIGITAL IN → AUX 1 → AUX 2 → HDMI IN → USB → FM → XM.

## Connecting the FM Antenna

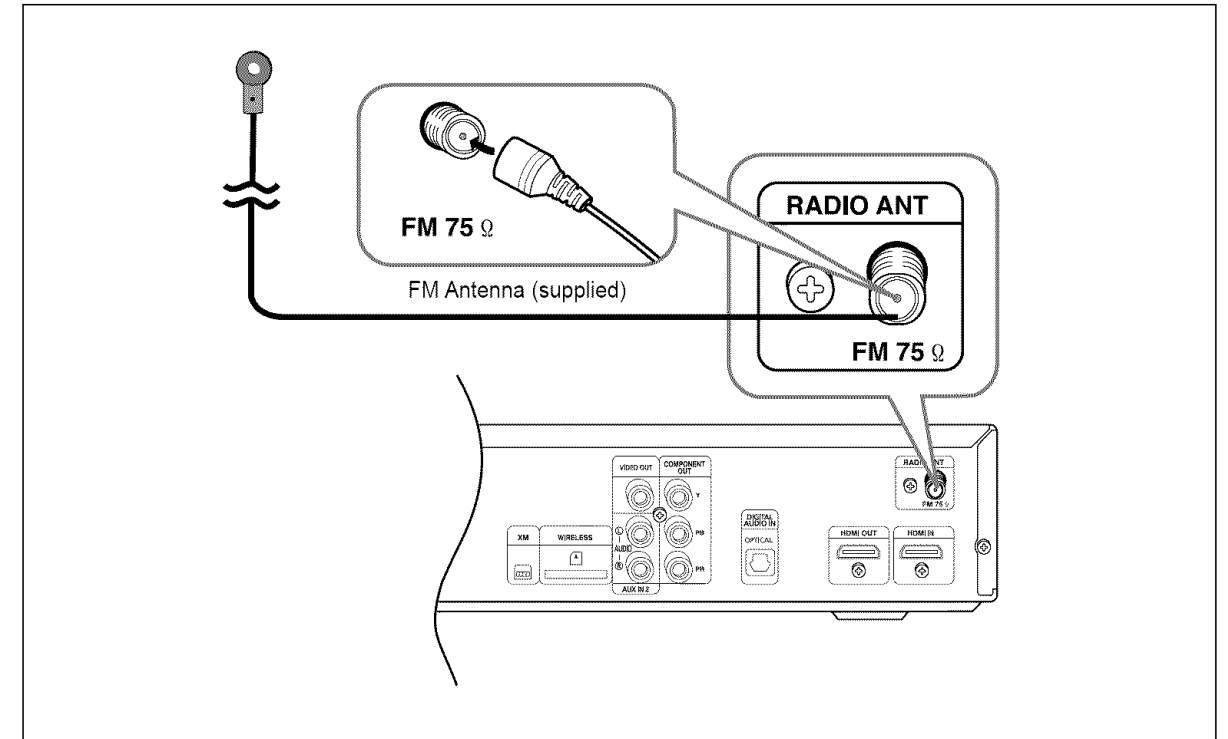

- 1 Connect the FM antenna supplied to the FM 75Ω COAXIAL Jack.
- 2 Slowly move the antenna wire around until you find a location where reception is good, then fasten it to a wall or other rigid surface.

• This unit does not receive AM broadcasts.

### Cooling Fan

The cooling fan supplies cool air to the unit to prevent overheating.

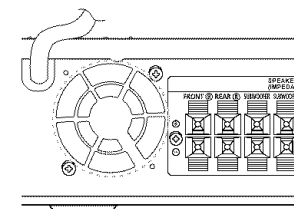

Please observe the following cautions for your safety.

- Make sure the unit is well-ventilated. If the unit has poor ventilation, the temperature inside the unit may rise and may damage it.
- Do not obstruct the cooling fan or ventilation holes. If the cooling fan or ventilation holes are covered with a newspaper or cloth, heat may build up inside the unit and fire may result.

## Connecting the Optional XM Satellite Radio Antenna

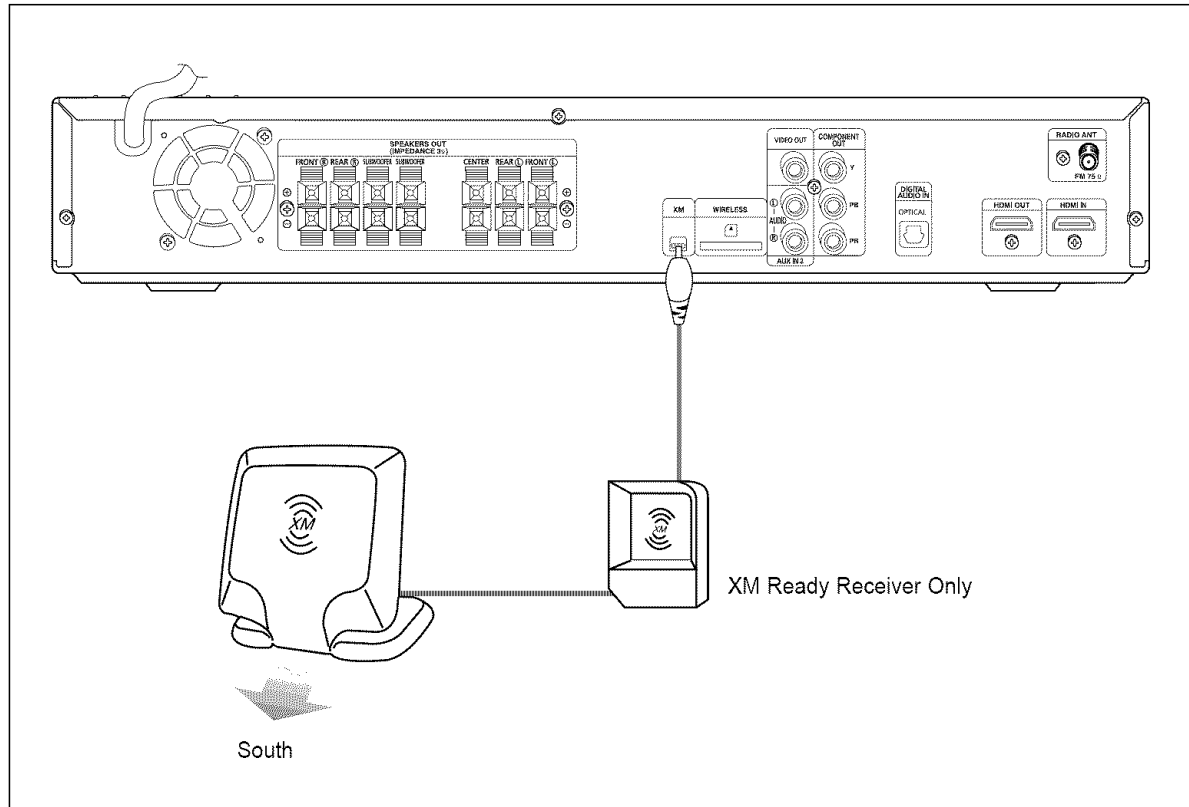

Connect an XM Antenna (not supplied) to the XM Antenna Jack on the rear of this unit.

- To ensure optimal reception of XM's satellite signal, the XM Antenna should be placed at or near a southerly facing window with nothing obstructing its path to the sky. You can mount it indoors or outdoors.
- When making connections, also refer to the operation instructions of the XM Antenna.
- Depending on your location, the radio signal may be weak or cannot be tuned .

## Before Reading the User's Manual

Make sure to check the following terms before reading the user manual.

### Icons that will be used in manual

Icon	Term	Definition
	DVD	This involves a function available with DVD or DVD-R/DVD-RW discs that have been recorded and finalized in Video Mode.
	CD	This involves a function available with a data CD (CD-R or CD-RW).
	MP3	This involves a function available with CD-R/-RW discs.
	JPEG	This involves a function available with CD-R/-RW discs.
	DivX	This involves a function available with MPEG4 discs. (DVD±R/RW, CD-R or CD-RW)
	CAUTION	This involves a case where a function does not operate or settings may be cancelled.
	NOTE	This involves tips or instructions on the page that help each function operate.

- In this manual, the instructions marked with "DVD ( )" are applicable to DVD-VIDEO, DVD-AUDIO and DVD-R/-RW discs that have been recorded in Video Mode and then finalized. Where a particular DVD type is mentioned, it is indicated separately.
- If a DVD-R/-RW disc has not been recorded properly in DVD Video format, it will not be playable.

# Before Using Your Home Theater

## To Operate your Samsung TV and the Home Theater with the HT-X70/HT-TX72/HT-TX75's Remote Control

The DVD Home Theater's remote can be used to control Samsung TVs.

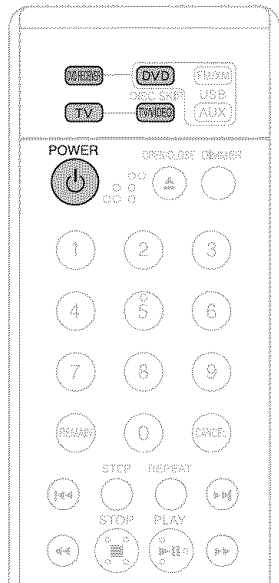

1 Plug the main unit's power cord into the AC power supply.

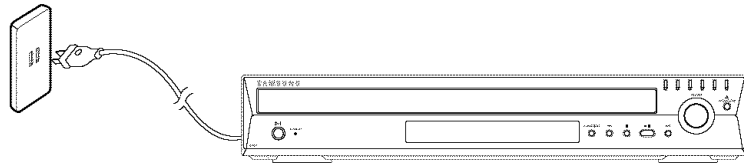

2 Press the **TV** button to set the remote to TV mode.

3 Press the **POWER** button to turn on your Samsung TV with this remote.

4 Press the **TV/VIDEO** button to select VIDEO mode on your TV.

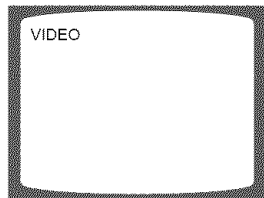

5 Press the **DVD RECEIVER** button to switch to DVD RECEIVER mode to operate the DVD Home Theater

6 Press the **FUNCTION** button on the main unit or **DVD** button on the remote to enable DVD/CD playback.

# Disc Playback

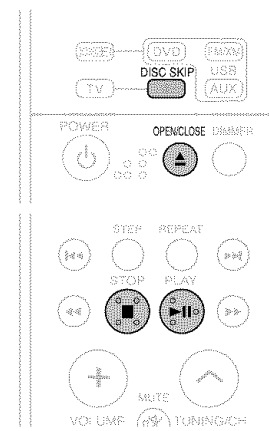

1 Press the **OPEN/CLOSE** button to open the disc tray.

2 Load a disc.  
 ■ Place a disc gently into the tray with the disc's label facing up.

3 Press the **DISC SKIP** button.  
 ■ Rotate the carousel tray so you can load the third, fourth, and fifth discs.

4 Close the compartment by pressing the **OPEN/CLOSE** button again.  
 ■ Playback starts automatically.

➤ To stop playback, press the **STOP** button during playback.

■ If pressed once, <PRESS PLAY> is displayed and the stop position will be stored in memory.

If the **PLAY/PAUSE** (▶||) button or **ENTER** button is pressed, playback resumes from the stop position. (This function works only with DVDs.)

■ If pressed twice, <STOP> is displayed, and if the **PLAY/PAUSE** (▶||) button is pressed, playback starts from the beginning.

➤ To temporarily pause playback, press the **PLAY/PAUSE** (▶||) button during playback.

■ To resume playback, press the **PLAY/PAUSE** (▶||) button again.



- Depending on the content of the disc, the initial screen may appear different.
- Pirated discs will not run in this player because it violates the CSS (Content Scrambling System : a copy protection system) recommendations.

## Selecting a Disc in the Disc changer

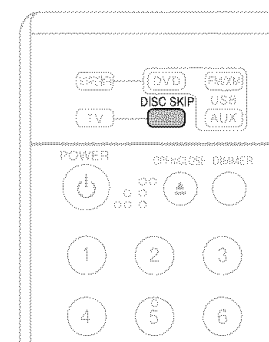

To select a specific disc, press the corresponding the **DIRECT PLAY (1, 2, 3, 4, 5)** buttons on the front panel or the **DISC SKIP** button on the remote control, until the required disc indicator flashes.

■ If the disc selected is not loaded, the next disc is played automatically.



# MP3/WMA-CD Playback



Data CDs (CD-R, CD-RW) encoded in MP3/WMA format can be played.

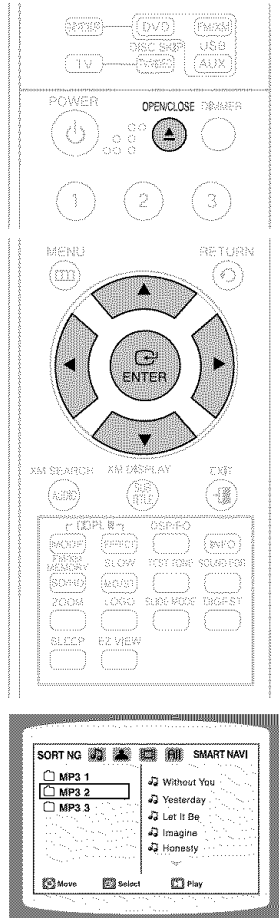

- 1 Place the MP3/WMA disc on the disc tray.
  - The MP3/WMA menu screen will appear and playback will start.
  - The appearance of the menu depends on the MP3/WMA disc.
  - WMA-DRM files cannot be played.
- 2 In Stop mode, use the Cursor **▲**, **▼**, **◀**, **▶** button to select the album, and then press the **ENTER** button.
  - Use the Cursor **▲**, **▼** button to select the track.
- 3 To change the album, use the Cursor **▲**, **▼**, **◀**, **▶** button to select another album in Stop mode, and then press the **ENTER** button.
  - To select another album and track, repeat Steps 2 and 3 above.
- 4 Press the **STOP** (■) button to stop playback.

- Depending on the recording mode, some MP3/WMA-CDs may not play.
- Table of contents of a MP3-CD varies depending on the MP3/WMA track format recorded on the disc.

➤ To play a file icon in the screen,

- Press the Cursor **▲**, **▼**, **◀**, **▶** button when it is in Stop mode and select a desired icon from the top part of the menu.

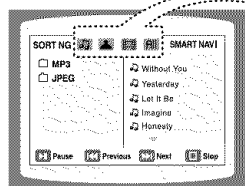

- Music File Icon : To play music files only, select the icon.
- Image File Icon : To view image files only, select the icon.
- Movie File Icon : To view movie files only, select the icon.
- All File Icon : To view movie files only, select the icon.

# JPEG File Playback



Images captured with a digital camera or camcorder, or JPEG files on a PC can be stored on a CD and then played back with this Home Theater.

## Slide Mode

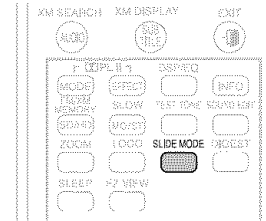

- 1 Place the JPEG disc on the disc tray.
    - Playback starts automatically. Each image is displayed for 5 seconds and then the next image is displayed.
  - 2 Press the **SLIDE MODE** button.
    - Each time the button is pressed, the image makes the transition as follows :  
SLIDE SHOW MODE : 1~5 → SLIDE SHOW MODE : RANDOM →  
SLIDE SHOW MODE : NONE
- Press the **◀▶▶▶** button to skip to the next slide.
- Each time the button is pressed, the slide moves backward or forward.

## Digest Function

You can view 9 JPEG images on the TV screen at once.

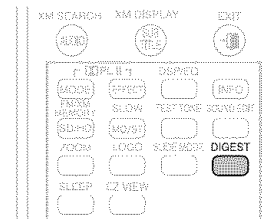

- 1 Press the **DIGEST** button during playback.
    - JPEG files will be shown in 9 windows.
  - 2 Press the Cursor **▲**, **▼**, **◀**, **▶** button to select the desired image and then press the **ENTER** button.
    - The selected image is played for 5 seconds before moving to the next image.
- To view the previous or next 9 images, press the **◀▶▶▶** button.

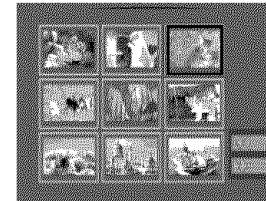

## Rotate/Flip Function

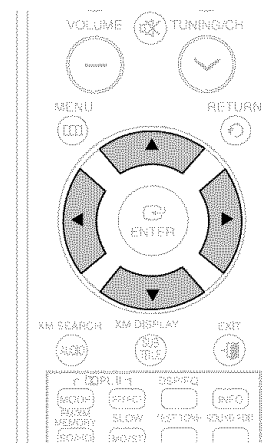

Press the Cursor **▲**, **▼**, **◀**, **▶** button during playback.

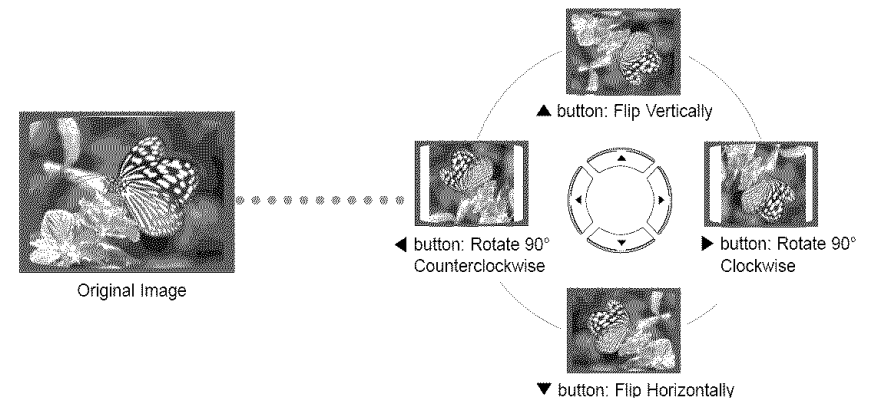

- The maximum resolutions supported by this product are 5120 x 3480 (or 19.0 MPixel) for standard JPEG files and 2048 x 1536 (or 3.0 MPixel) for progressive image files.
- If a JPEG file is played when the HDMI output resolution is 720p/1080i, the mode is automatically converted to 480p mode.





The functions on this page apply to DivX disc playback.

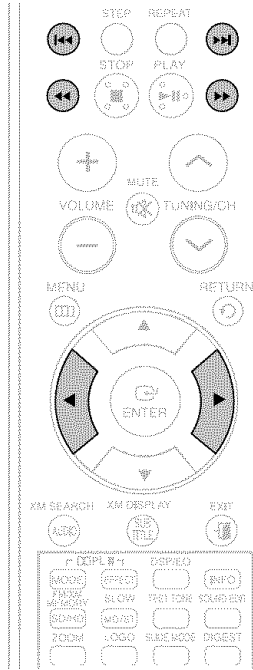

## Skip Forward/Back

During playback, press the **◀▶** button.

- Goes to the next file whenever you press the **▶▶** button, if there are over 2 files in the disc.
- Goes to the previous file whenever you press the **◀◀** button, if there are over 2 files in the disc.

## Fast playback

To play back the disc at a faster speed, press the **◀◀** or **▶▶** button during playback.

- Each time you press either button, the playback speed will change as follows:  
2x → 4x → 8x → 32x → Normal.

## 5 Minute Skip function

During playback, press the **◀**, **▶** button.

- Playback skips 5 minutes forward whenever you press the Cursor **▶** button.
- Playback skips 5 minutes back whenever you press the Cursor **◀** button.

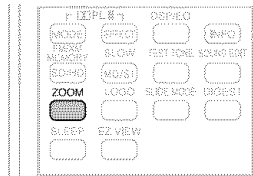

## Zoom Function

1 Press the **ZOOM** button.

- Each time you press the button, your selection will toggle between <ZOOM X2> and <ZOOM OFF>.

2 Press the Cursor **▲**, **▼**, **◀**, **▶** button to move to the area you want to enlarge.

- A DivX file can be zoomed only in ZOOM X2 mode.
- DivX files have .Avi file extensions, however, not all .Avi files are DivX and may not be playable in this unit.

## Audio Display

Press the **AUDIO** button.

- If there are multiple audio tracks on a disc, you can toggle between them.
- Each time you press the button, your selection will toggle between <AUDIO (1/N, 2/N ...)> and

- is displayed when there is one supported language in the disc.

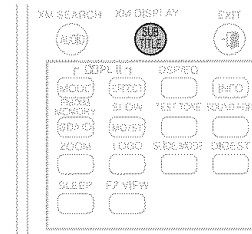

## Subtitle Display

Press the **SUBTITLE** button.

- Each time you press the button, your selection will toggle between <SUBTITLE (1/N, 2/N ...)> and <SUBTITLE OFF>.
- If the disc has only one subtitle file, it will be played automatically.
- See number 2 (Caption Function) below for more details concerning Subtitle usage with DivX discs.

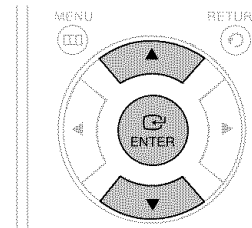

## If the Disc has more than One Subtitle File

If the disc has more than one subtitle file, the default subtitle may not match the movie and you will have to select your subtitle language as follows:

- 1 In Stop mode, press the Cursor **▲**, **▼** button, select the desired subtitle () from the TV screen, and then press the **ENTER** button.
- 2 When you select the desired DivX file from the TV screen, the movie will be played normally.

## DivX(Digital internet video eXpress)

DivX is a video file format developed by Microsoft and is based on MPEG4 compression technology to provide audio and video data over the Internet in real-time.

MPEG4 is used for video encoding and MP3 for audio encoding so that the users can watch a movie at near DVD-quality video and audio.

### 1. Supported Formats

This product only supports the following media formats. If both video and audio formats are not supported, the user may experience problems such as broken images or no sound.

#### Supported Video Formats

Format	AVI	WMV
Supported Versions	DivX3.11~DivX5.1, XviD	V1/V2/V3/V7

#### Supported Audio Formats

Format	MP3	WMA	AC3	DTS
Bit Rate	80~384kbps	56~128kbps	128~384kbps	1.5Mbps
Sampling Frequency	44.1khz		44.1/48khz	44.1khz

- DivX files, including audio and video files, created in the DTS format can only support up to 6Mbps.
- Aspect Ratio : Although the default DivX resolution is 640x480 pixels (4:3), this product supports up to 800x600 pixels (16:9). TV screen resolutions higher than 800 will not be supported.
- When you play a disc whose sampling frequency is higher than 48khz or 320kbps, you may experience shaking on the screen during playback.

### 2. Caption Function

- You must have some experience with video extraction and editing in order to use this feature properly.
- To use the caption function, save the caption file (\*.smi) in the same file name as that of the DivX media file (\*.avi) within the same folder.  
Example. Root Samsung\_007CD1.avi  
Samsung\_007CD1.smi
- Up to 60 alphanumeric characters or 30 East Asian characters (2 byte characters such as Korean and Chinese) for the file name.

# Using the Playback Function

## Displaying Disc Information

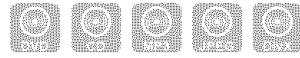

You can view disc playback information on the TV screen.

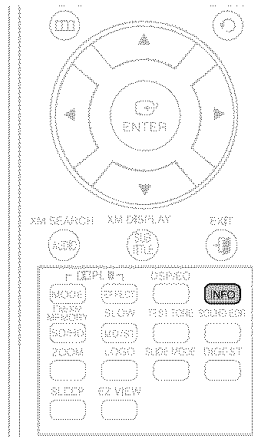

Press the **INFO** button.

- Each time the button is pressed, the display changes as follows:

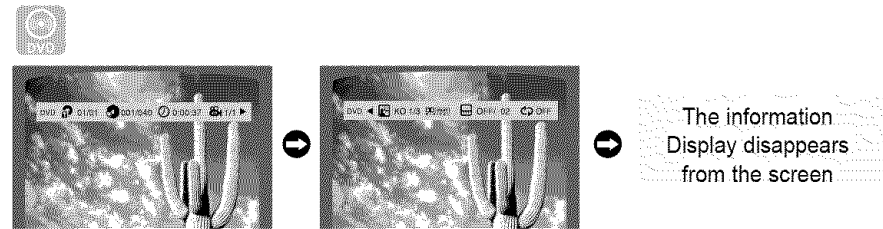

The information Display disappears from the screen

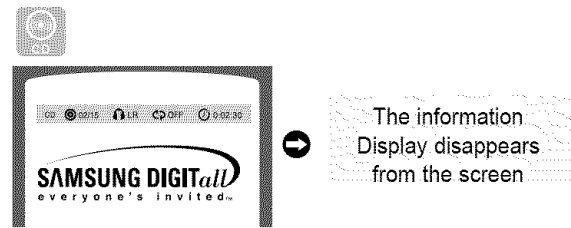

The information Display disappears from the screen

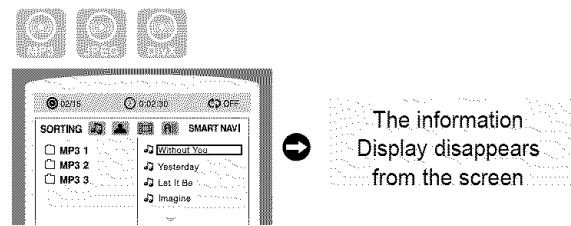

The information Display disappears from the screen

- Depending on the disc, the disc information display may appear different.
- Depending on the disc, you can also select DTS, DOLBY DIGITAL, or PRO LOGIC.

appears on the TV screen!

If this symbol appears on the TV screen when pressing a button, that operation is not possible with the disc currently being played.

### Screen Display

- |                   |                      |                         |                         |
|-------------------|----------------------|-------------------------|-------------------------|
| DVD display       | TITLE display        | ELAPSED TIME display    | LR STEREO (L/R) display |
| DVD-AUDIO display | CHAPTER display      | REPEAT PLAYBACK display | DOLBY DIGITAL display   |
| CD display        | TRACK (FILE) display | AUDIO LANGUAGE display  | ANGLE display           |
|                   | GROUP display        | SUBTITLE display        |                         |

## Checking the Remaining Time

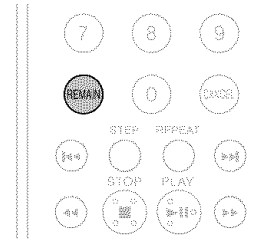

Press the **REMAIN** button.

- For checking the total and remaining time of a title or chapter being played.

Each time the Remain button is pressed

- TITLE ELAPSED → TITLE REMAIN → CHAPTER ELAPSED → CHAPTER REMAIN
- GROUP ELAPSED → GROUP REMAIN → TRACK ELAPSED → TRACK REMAIN
- TRACK ELAPSED → TRACK REMAIN → TOTAL ELAPSED → TOTAL REMAIN
- TRACK REMAIN → TRACK ELAPSED

## Fast Playback

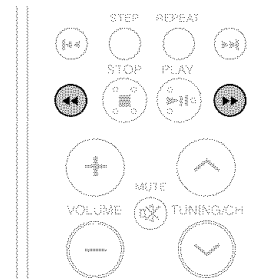

Press the **2x, 4x, 8x, 32x** button.

- Each time the button is pressed during playback, the playback speed changes as follows:

- 2X → 4X → 8X → 32X → PLAY.
- 4X → 8X → 32X → PLAY.

- During fast playback of a CD or MP3-CD, sound is heard only at 2x speed, and not at 4x, 8x, and 32x speeds.

## Slow Playback

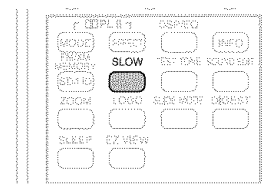

Press the **SLOW** button.

- Each time the button is pressed during playback, the playback speed changes as follows:

- 1/2 → 1/4 → 1/8 → 1/2 → 1/4 → 1/8 → PLAY
- 1/2 → 1/4 → 1/8 → PLAY

- No sound is heard during slow playback.
- Reverse slow playback does not work with DivX.

## Skipping Scenes/Songs

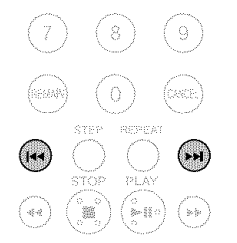

Press the **◀▶** button.

- Each time the button is pressed during playback, the previous or next chapter, track or directory (file) will be played.
- You cannot skip chapters consecutively.

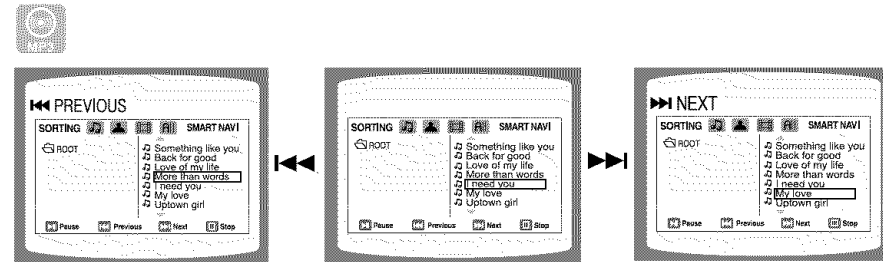
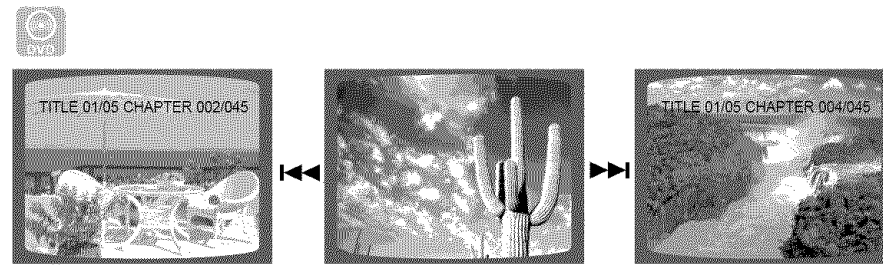



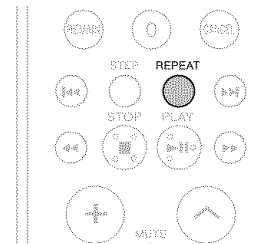

## Repeat Playback

Repeat playback allows you to repeatedly play a chapter, title, track (song), or directory (MP3 file).



Press the **REPEAT** button.

- Each time the button is pressed during playback, the repeat playback mode changes as follows:

-  REPEAT : CHAPTER → REPEAT : TITLE → REPEAT : OFF
-  REPEAT : TRACK → REPEAT : GROUP → REPEAT : OFF
-  REPEAT : TRACK → REPEAT : DISC → REPEAT : OFF
-  REPEAT : RANDOM → REPEAT : TRACK → REPEAT : DIR → REPEAT : DISC → REPEAT : OFF

### Repeat Playback Options

- CHAPTER** : Repeatedly plays the selected chapter.
- TITLE** : Repeatedly plays the selected title.
- GROUP** : Repeatedly plays the selected group.
- RANDOM** : Plays tracks in random order.  
(A track that has already been played may be played again.)
- TRACK** : Repeatedly plays the selected track.
- DIR** : Repeatedly plays all tracks in the selected folder.
- DISC** : Repeatedly plays the entire disc.
- OFF** : Cancels Repeat Playback.

## To Select a Repeat Playback Mode in the Disc Information Screen

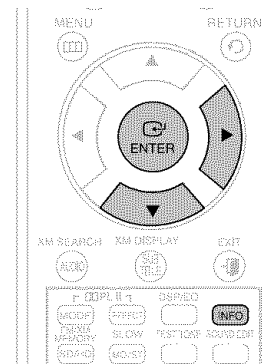

- Press the **INFO** button twice.
- Press the Cursor **▶** button to move to REPEAT PLAYBACK (⌂) display.
- Press the Cursor **▼** button to select the desired Repeat Playback mode.
  - To select another album and track, repeat Steps 2 and 3 above.
- Press the **ENTER** button.

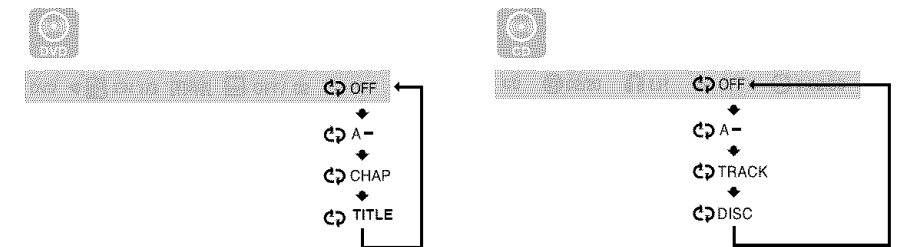

**!** For DivX, MP3 and JPEG discs, you cannot select Repeat Play from the information display screen.

# Using the Playback Function (Con't)

## A-B Repeat Playback



You can repeatedly play back a designated section of a DVD.

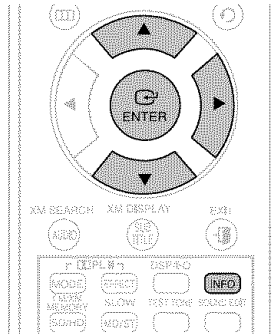

- 1 Press the **INFO** button twice.
- 2 Press the Cursor **▶** button to move to the REPEAT PLAYBACK (⏮) display.
- 3 Press the Cursor **▲, ▼** button to select <A-> and then press the **ENTER** button at the beginning of the desired segment.
  - When the **ENTER** button is pressed, the selected position will be stored in memory.
- 4 Press the **ENTER** button at the end of the desired segment.
  - The specified segment will be played repeatedly.



- To return to normal playback, press the Cursor **▲, ▼** button to select **OFF**.

• The A-B Repeat function does not operate with DivX, MP3 or JPEG discs.

## Angle Function



This function allows you to view the same scene in different angles.

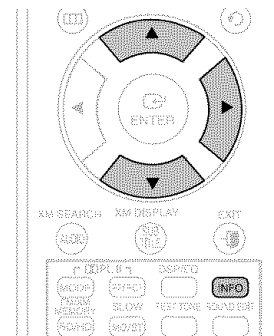

- 1 Press the **INFO** button.
- 2 Press the Cursor **▶** button to move to ANGLE (⊞) display.
- 3 Press the Cursor **▲, ▼** button or numeric buttons to select the desired angle.
  - Each time the button is pressed, the angle changes as follows:

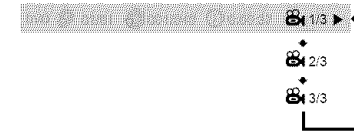

• The Angle function works only with discs on which multiple angles have been recorded.

## Step Function

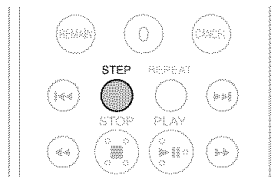

- Press the **STEP** button.
- The picture moves forward one frame each time the button is pressed during playback.

• No sound is heard during step motion playback.

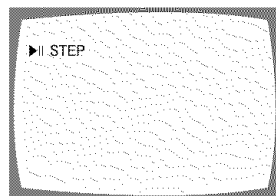

## Zoom (Screen Enlarge) Function



This function allows you to enlarge a particular area of the displayed image.

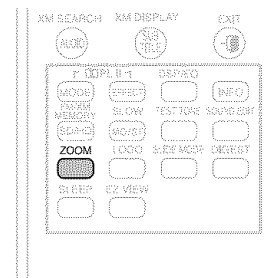

- 1 Press the **ZOOM** button.
- 2 Press the Cursor **▲, ▼, ◀, ▶** button to move to the area you want to enlarge.
- 3 Press the **ENTER** button.
  - Each time the button is pressed, the zoom level changes as follows:

ZOOM X 1.5 → ZOOM X 2 → ZOOM X 3 → ZOOM OFF

• When a DivX disc is being played, the screen is enlarged up to twice the normal size.

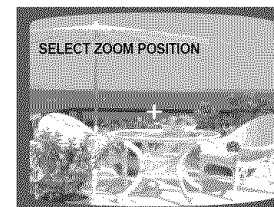

# Using the Playback Function (Con't)

## EZ VIEW Function

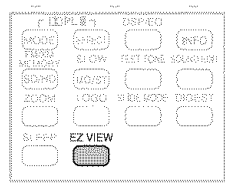

Press the **EZ VIEW** button.

- Each time the button is pressed, the zoom function will switch between On and Off.
- When a movie is played in Widescreen format, black bars at the top and bottom of the TV screen can be removed by pressing the EZ VIEW button.

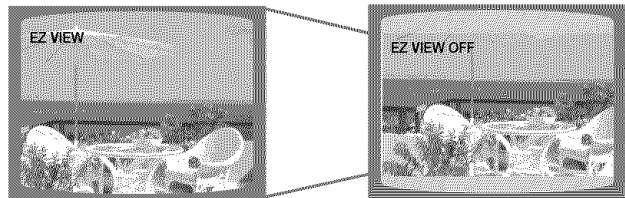

- This function will not work if the DVD is recorded with multi-camera angle format.
- Black bars may not disappear because some DVD discs have a built-in horizontal to vertical ratio.
- This feature is not supported for DivX discs.
- During the EZ View operation, some of the left and right sides may be cut slightly.

## Bonus Group



Some DVD-Audio discs have an extra 'bonus' group that requires a 4-digit key number to access. See the disc packaging for details and the key number.

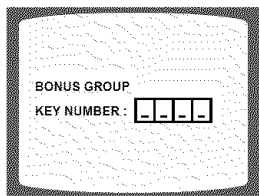

When you play a DVD-Audio disc that has a bonus group, the key number input screen appears automatically.

- If you eject the disc, switch the power off, or unplug the player, you will need to re-enter the key number.

## Navigating Pages

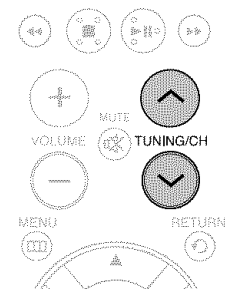

During playback, press the **↕**, **↗** button on the remote control.

- You can select the desired image from a DVD-Audio disc containing still images.
- With some discs, you may not be able to select images.

## Audio Language Selection Function

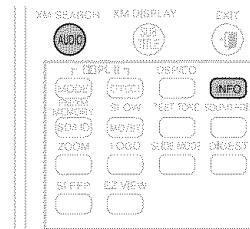

- Press the **INFO** button twice.
- Press the Cursor **▲**, **▼** button or numeric buttons to select the desired audio language.
  - Depending on the number of languages on a DVD disc, a different audio language (ENGLISH, SPANISH, FRENCH, etc.) is selected each time the button is pressed.

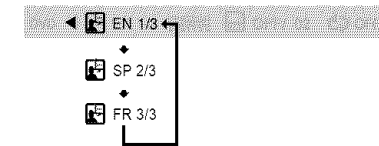

## Subtitle Language Selection Function

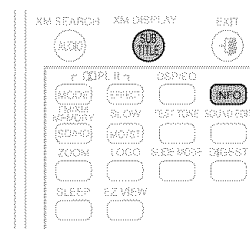

- Press the **INFO** button twice.
- Press the Cursor **▶** button to move to **SUBTITLE** ( ) display.
- Press the Cursor **▼** button or numeric buttons to select the desired subtitle.

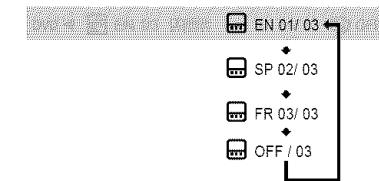

- To operate this function, you can also press the **AUDIO** or **SUBTITLE** buttons on the remote control.
- Depending on the disc, the Subtitle and Audio Language functions may not be available.

# Using the Playback Function (Con't)

## Moving Directly to a Scene/Song

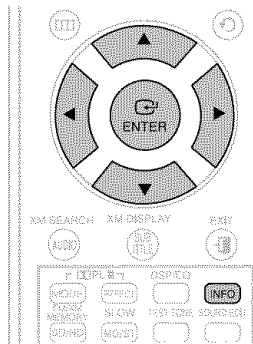

- 1 Press the **INFO** button.
- 2 Press the Cursor **▲**, **▼** button or numeric buttons to select the desired title/track ( ) and then press the **ENTER** button.
- 3 Press the Cursor **◀**, **▶** button to move to the Chapter ( ) display.
- 4 Press the Cursor **▲**, **▼** button or numeric buttons to select the desired chapter and then press the **ENTER** button.
- 5 Press the Cursor **◀**, **▶** button to move to time ( ) display.
- 6 Press the numeric buttons to select the desired time and then press the **ENTER** button.



Press the **numeric** buttons.

- The selected file will be played.
- When playing an MP3 or JPEG disc, you cannot use the Cursor **▲**, **▼** button to move to a folder. To move a folder, press the Stop ( ) and then press the Cursor **▲**, **▼** button.

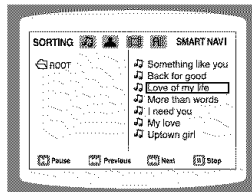

- You can press the **◀◀▶▶** button on the remote control to move directly to the desired title, chapter, or track.
- Depending on the disc, you may not be able to move to the selected title or time.

## Using the Disc Menu



You can use the menus for the audio language, subtitle language, profile, etc. DVD menu contents differ from disc to disc.

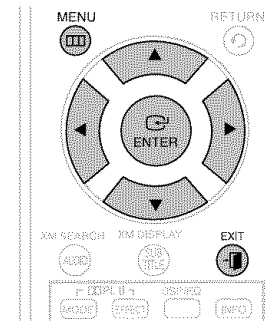

- 1 In Stop mode, press the **MENU** button.
- 2 Press the Cursor **▲**, **▼** button to move to **<Disc Menu>** and then press the **ENTER** button.
  - When you select Disc Menu and it is not supported by the disc, the "This menu is not supported" message appears on the screen.
- 3 Press the Cursor **▲**, **▼**, **◀**, **▶** button to select the desired item.
- 4 Press the **ENTER** button.

➤ Press the **EXIT** button to exit the setup screen.



- The disc menu display may be different depending on the disc.

## Using the Title Menu



For DVDs containing multiple titles, you can view the title of each movie. Depending on the disc, the availability of this feature may vary.

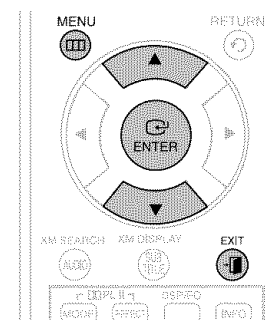

- 1 In Stop mode, press the **MENU** button.
  - 2 Press the Cursor **▲**, **▼** button to move to the **<Title Menu>**.
  - 3 Press the **ENTER** button.
    - The title menu appears.
- Press the **EXIT** button to exit the setup screen.

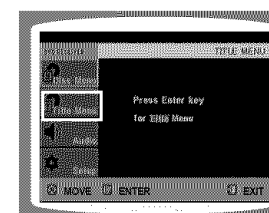

- The Title menu display may be different depending on the disc.

# Playing Media Files using the USB Host Feature

You can enjoy media files such as pictures, movies and music saved on an MP3 player, USB memory stick or digital camera in high quality video with 5.1 channel Home Theater sound by connecting the storage device to the USB port of the Home Theater.

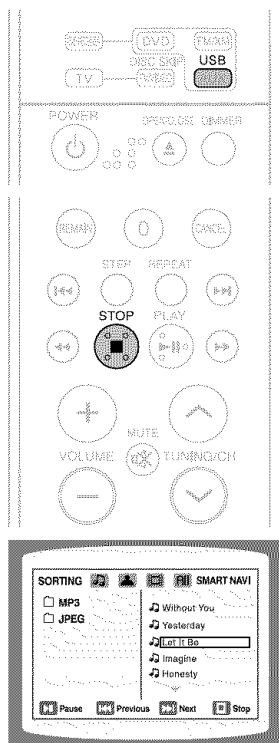

1 Connect the USB device to the USB port on the front of the unit.

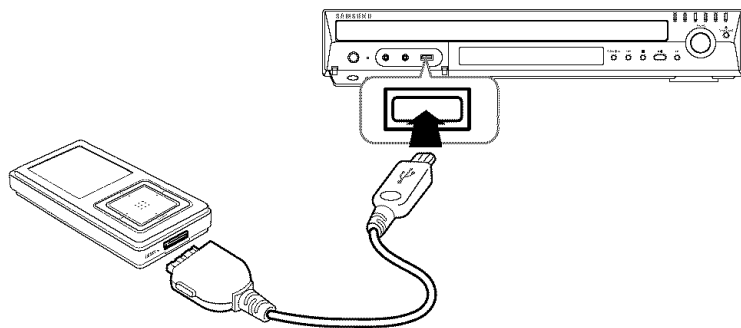

2 Press the **FUNCTION** button on the DVD Player or the **USB** button on the remote control to select the USB mode.

- <USB> appears on the display screen and then disappears.
- The USB MENU screen appears on the TV screen and the saved file is played.

3 To stop playback, press the **STOP** (■) button.

➤ **Safe USB Removal**

To prevent damage to the memory stored in the USB device, perform safe removal before disconnecting the USB cable.

- (1) Press the **STOP** (■) button twice in a row.  
The display will show **REMOVE USB**.
- (2) Remove the USB cable.

• To listen to your music files with 5.1 channel home theater sound, you must set the Dolby Pro Logic II mode to Matrix. (See page 57)

## Compatible Devices

1. USB devices that support USB Mass Storage v1.0. (USB devices that operate as a removable disc in Windows (2000 or later) without additional driver installation.)
2. MP3 Player: HDD and flash type MP3 players.
3. Digital camera: Cameras that support USB Mass Storage v1.0.
  - Cameras that operate as a removable disc in Windows (2000 or later) without additional driver installation.
4. USB HDD and USB Flash Drive: Devices that support USB2.0 or USB1.1.
  - You may experience a difference in playback quality when you connect a USB1.1 device.
  - For a USB HDD, make sure to connect an auxiliary power cord to the USB HDD for proper operation.
5. USB card Reader: One slot USB card reader and Multi slot USB card reader.
  - Depending on the manufacturer, the USB card reader may not be supported.
  - If you install multiple memory devices into a multi card reader, you may experience problems.
6. If you use a USB extension cable, the USB device might not be recognized.

## Supported Formats

	File name	File extension	Bit rate	Version	Pixel	Sampling Frequency
Still Picture	JPG	JPG .JPEG	-	-	640x480	-
Music	MP3	.MP3	80~384kbps	-	-	44.1kHz
	WMA	.WMA	56~128kbps	V8	-	44.1kHz
Movie	WMV	.WMV	4Mbps	V1,V2,V3,V7	720x480	44.1KHz~48KHz
	DivX	.AVI,.ASF	4Mbps	DivX3.11~DivX5.1,XviD	800x600	44.1KHz~48KHz

- CBI (Control/Bulk/Interrupt) is not supported.
- Digital Cameras that use PTP protocol or require additional program installation when connected to a PC are not supported.
- A device using NTFS file system is not supported. (Only FAT 16/32 (File Allocation Table 16/32) file system is supported.)
- Some MP3 players, when connected to this product, may not operate depending on the sector size of their file system.
- The USB host function is not supported if a product that transfers media files by its manufacturer-specific program is connected.
- Does not operate with Janus enabled MTP(Media Transfer Protocol) devices.
- **The USB host function of this product does not support all USB devices. For information on the supported devices, see page 72.**

## Skip Forward/Back

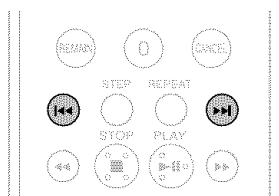

During playback, press the **⏮▶▶** button.

- When there is more than one file and you press the **▶▶** button, the next file is selected.
- When there is more than one file and you press the **⏮** button, the previous file is selected.

## Fast playback

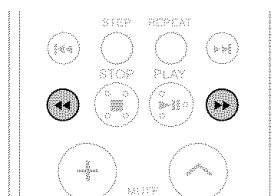

To play back the disc at a faster speed, press the **⏮▶▶** button during playback.

- Each time you press the either button, the playback speed will change as follows:  
2x → 4x → 8x → 32x → Normal.



## Setting the Language

OSD (On-Screen Display) language is set to English by default.

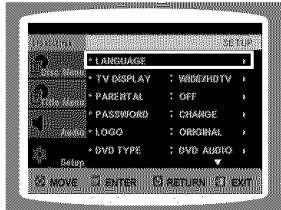

- 1 In Stop mode, press the **MENU** button.
  - 2 Press the Cursor **▼** button to move to **<Setup>** and then press the **ENTER** button.
  - 3 Select **<LANGUAGE>** and then press the **ENTER** button.
  - 4 Press the Cursor **▲, ▼** button to select **<OSD LANGUAGE>** and then press the **ENTER** button.
  - 5 Press the Cursor **▲, ▼** button to select the desired language and then press the **ENTER** button.
    - Once the setup is complete, the OSD will be English if English has been selected as language.
- Press the **RETURN** button to return to the previous level.  
➤ Press the **EXIT** button to exit the setup screen.

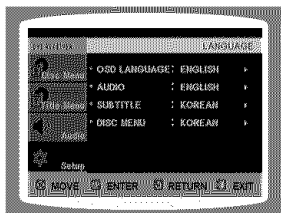
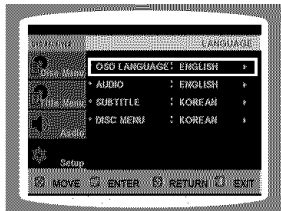

- **OSD LANGUAGE** : Selecting the OSD Language
- **AUDIO** : Selecting the Audio Language (recorded on the disc)
- **SUBTITLE** : Selecting the Subtitle Language (recorded on the disc)
- **DISC MENU** : Selecting the Disc Menu Language (recorded on the disc)
  - ※ If the language you selected is not recorded on the disc, the menu language will not change even if you set it to your desired language.

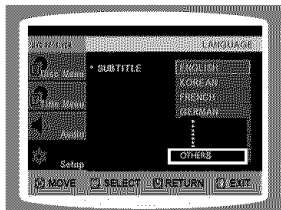

- **OTHERS** : To select another language, select **<OTHERS>** and enter the language code of your country. (See page 71 for language codes) **AUDIO**, **SUBTITLE** and **DISC MENU** language can be selected.

## Setting TV Screen Type

Depending on your TV type (Wide Screen or conventional 4:3), you can select the TV's aspect ratio.

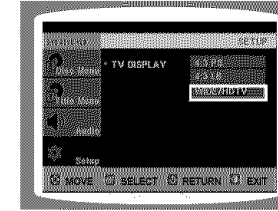
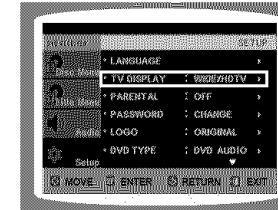

- 1 In Stop mode, press the **MENU** button.
  - 2 Press the Cursor **▼** button to move to **<Setup>** and then press the **ENTER** button.
  - 3 Press the Cursor **▼** button to move to **<TV DISPLAY>** and then press the **ENTER** button.
  - 4 Press the Cursor **▲, ▼** button to select the desired item and then press the **ENTER** button.
    - Once the setup is complete, you will be taken to the previous screen.
- Press the **RETURN** button to return to the previous level.  
➤ Press the **EXIT** button to exit the setup screen.

### Adjusting the TV Aspect Ratio (Screen Size)

The horizontal to vertical screen size ratio of conventional TVs is 4:3, while that of widescreen and high definition TVs is 16:9. This ratio is called the aspect ratio. When playing DVDs recorded in different screen sizes, you should adjust the aspect ratio to fit your TV or monitor.

For a standard TV, select either **<4:3PS>** or **<4:3LB>** option according to personal preference. Select **<WIDE/HDTV>** if you have a widescreen TV.



#### 4:3PS (4:3 Pan&Scan)

- Select this to play a 16:9 picture in the pan & scan mode on a conventional TV.
- You can see the central portion of the screen only (with the sides of the 16:9 picture cut off).



#### 4:3LB (4:3 Letterbox)

- Select this to play a 16:9 picture in the letter box mode on a conventional TV.
- Black bars will appear at the top and bottom of the screen.



#### WIDE/HDTV

- Select this to view a 16:9 picture in the full-screen mode on your widescreen TV.
- You can enjoy the widescreen aspect.



- If a DVD is in the 4:3 ratio, you cannot view it in widescreen.
- Since DVD discs are recorded in various image formats, they will look different depending on the software, the type of TV, and the TV aspect ratio setting.
- In HDMI operation, the screen is automatically converted to Wide mode.



## Setting Parental Controls (Rating Level)

Use this to restrict playback of adult or violent DVDs you do not want children to view.

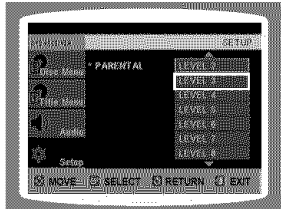
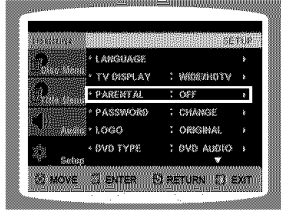

- 1 In Stop mode, press the **MENU** button.
  - 2 Press the Cursor **▼** button to move to **<Setup>** and then press the **ENTER** button.
  - 3 Press the Cursor **▼** button to move to **<PARENTAL>** and then press the **ENTER** button.
  - 4 Press the Cursor **▲, ▼** button to select the desired rating level and then press the **ENTER** button.
    - If you have selected Level 6, you cannot view DVDs with Level 7 or higher.
    - The higher the level, the closer the content is to violent or adult material.
  - 5 Enter the password and then press the **ENTER** button.
    - The password is set to "7890" by default.
    - Once the setup is complete, you will be taken to the previous screen.
- Press the **RETURN** button to return to the previous level.  
➤ Press the **EXIT** button to exit the setup screen.

• This function works only if a DVD disc contains the rating level information.

## Setting the Password

You can set the password for the Parental (rating level) setting.

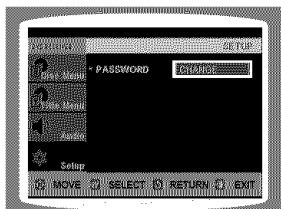
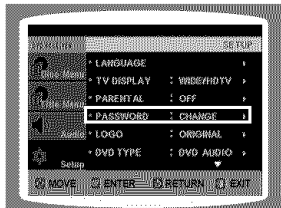

- 1 In Stop mode, press the **MENU** button.
- 2 Press the Cursor **▼** button to move to **<Setup>** and then press the **ENTER** button.
- 3 Press the Cursor **▼** button to move to **<PASSWORD>** and then press the **ENTER** button.
- 4 Press the **ENTER** button.
- 5 Enter the password and then press the **ENTER** button.
  - Enter the old password, a new password, and confirm new password.
  - The setting is complete.

• The password is set to "7890" by default.

### If you have forgotten the rating level password, do the following

- While the player is in No Disc mode, hold the DVD Player's **STOP** (■) button for longer than 5 seconds. **<INITIAL>** appears on the display and all settings will return to the default values.
- Press the **POWER** button.

Using the **RESET** function will erase all stored settings.  
Do not use this unless necessary.

## Setting the Wallpaper



While watching a DVD or JPEG CD, you can set the image you like as background wallpaper.

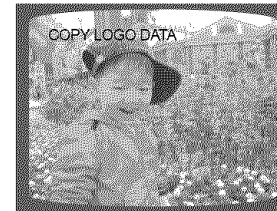
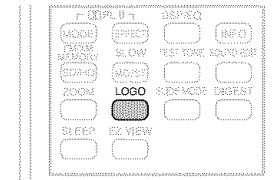

- 1 During playback, press the **PLAY/PAUSE** button when an image you like appears.
- 2 Press the **LOGO** button.
  - **<COPY LOGO DATA>** will be displayed on the TV screen.
- 3 The power will turn off and then back on.
  - The selected wallpaper will be displayed.
  - You can select up to 3 wallpaper settings.

• This function will not work when the HDMI output is 720p or 1080i.

## To Select One of the 3 Wallpaper Settings you've made

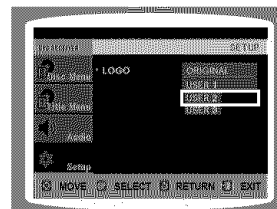
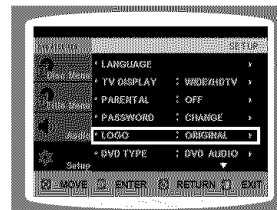

- 1 In Stop mode, press the **MENU** button.
- 2 Press the Cursor **▼** button to move to **<Setup>** and then press the **ENTER** button.
- 3 Press the Cursor **▼** button to move to **<LOGO>** and then press the **ENTER** button.
- 4 Press the Cursor **▲, ▼** button to select the desired **<USER>**, and then press the **ENTER** button.
  - This selects one of the 3 wallpaper screens
- 5 Press the **EXIT** button to exit the setup screen.

- **ORIGINAL** : Select this to set the Samsung Logo image as your wallpaper.
- **USER** : Select this to set the desired image as your wallpaper.

- Press the **RETURN** button to return to the previous level.  
➤ Press the **EXIT** button to exit the setup screen.

## DVD Playback Mode

Some DVD-Audio discs contain DVD-Video as well as DVD-Audio.  
To play back the DVD-Video portion of the DVD-Audio disc, set the unit to DVD-Video mode.

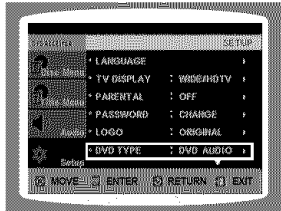

- 1 Press the **MENU** button while the disc tray is open.
- 2 Press the Cursor **▼** button to move to **<Setup>** and then press the **ENTER** button.
- 3 Press the Cursor **▼** button to move to **<DVD TYPE>** and then press the **ENTER** button.
- 4 Press the Cursor **▲, ▼** button to move to **<DVD VIDEO>** and then press the **ENTER** button.
  - Set steps 1 ~ 4 again if you want to switch to DVD AUDIO Play mode.

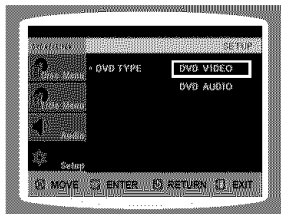

- DVD VIDEO : set to play the DVD video contents contained on a DVD audio disc.
- DVD AUDIO : set to play the default DVD audio.

- DVD Play mode is set to DVD Audio as factory default setting.
- Powering off the main unit will automatically switch to the DVD Audio mode.

## DivX (R) Registration

Please use the Registration code to register this player with the DivX (R) video on demand format.  
To learn more, go to [www.divx.com/vod](http://www.divx.com/vod).

## Setting the Speaker Mode

Signal outputs and frequency responses from the speakers will automatically be adjusted according to your speaker configuration and whether certain speakers are used or not.

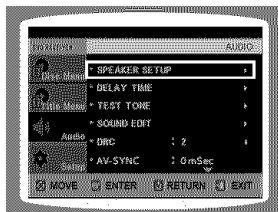

- 1 In Stop mode, press the **MENU** button.
- 2 Press the Cursor **▼** button to move to **<Audio>** and then press the **ENTER** button.
- 3 In the **<SPEAKER SETUP>**, press the **ENTER** button again.
- 4 Press the Cursor **▲, ▼, ◀, ▶** button to move to the desired speaker and then press the **ENTER** button.

- For C, SL, and SR, each time the button is pressed, the mode switches alternately as follows : SMALL → NONE.
- For L and R, the mode is set to SMALL.

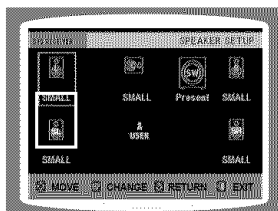

- SMALL : Select this when using the speakers.
- NONE : Select this when no speaker is connected.

- Depending on PRO LOGIC and STEREO settings, the speaker mode may vary (see page 57).

- Press the **RETURN** button to return to the previous level.
- Press the **EXIT** button to exit the setup screen.

## Setting the Delay Time

If the speakers cannot be placed at equal distances from the listening position, you can adjust the delay time of the audio signals from the center and rear speakers.

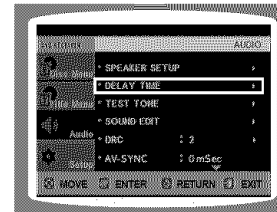

- 1 In Stop mode, press the **MENU** button.
- 2 Press the Cursor **▼** button to move to **<Audio>** and then press the **ENTER** button.
- 3 Press the Cursor **▼** button to move to **<DELAY TIME>** and then press the **ENTER** button.
- 4 Press the Cursor **▲, ▼, ◀, ▶** button to move to the desired speaker and then press the **ENTER** button.
- 5 Press the Cursor **◀, ▶** button to set the Delay time.
  - You can set the delay time for C between 00 and 05mSEC and for SL and SR between 00 and 15mSEC.

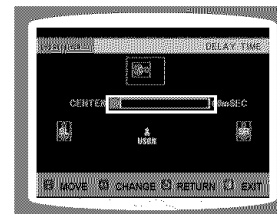

- Press the **RETURN** button to return to the previous level.
- Press the **EXIT** button to exit the setup screen.

## Setting up the Speaker Delay Time

When 5.1CH Surround Sound is played, you can enjoy the best sound if the distance between you and each speaker is the same. Since the sounds arrive at the listening position at different times depending on the placement of speakers, you can adjust this difference by adding a delay effect to the sound of the Center and Surround Speakers.

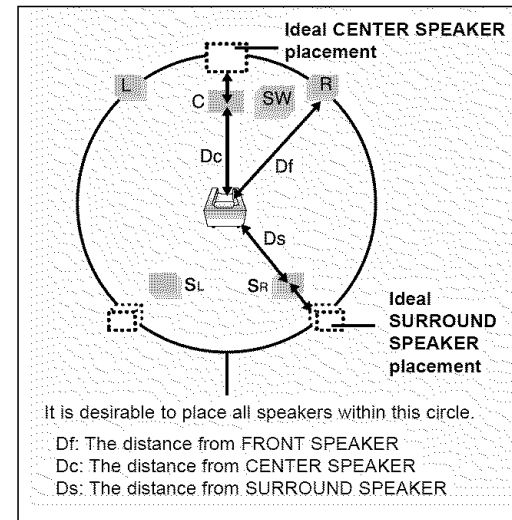

### Setting CENTER SPEAKER

If the distance of Dc is equal to or longer than the distance of Df in the figure, set the mode as 0ms. Otherwise, change the setting according to the table.

Distance between Df and Dc	0 inch	13.6 inches	27.2 inches	40.8 inches	4.5 feet	5.6 feet
Delay Time	0 ms	1 ms	2 ms	3 ms	4 ms	5 ms

### Setting REAR (SURROUND) SPEAKERS

If the distance of Df is equal to the distance of Ds in the figure, set the mode as 0ms. Otherwise, change the setting according to the table.

Distance between Df and Dc	0 inch	40.8 inches	6.7 feet	10.0 feet	13.4 feet	16.7 feet
Delay Time	0 ms	3 ms	6 ms	9 ms	12 ms	15 ms

- With **PL II** (Dolby Pro Logic II), the delay time may be different for each mode.
- With AC-3 and DTS, the delay time can be set between 00 and 15mSEC.
- The Center channel is only adjustable on 5.1 channel discs.

## Setting the Test Tone

Use the Test Tone feature to check the speaker connections.

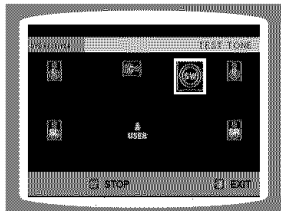
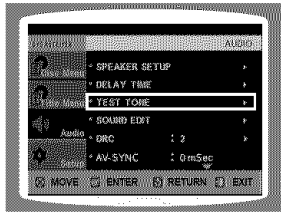

- 1 In Stop mode, press the **MENU** button.
- 2 Press the Cursor **▼** button to move to **<Audio>** and then press the **ENTER** button.
- 3 Press the Cursor **▼** button to move to **<TEST TONE>** and then press the **ENTER** button.
  - The test tone will be sent to L → C → R → SR → SL → SW in order.
  - If the ENTER button is pressed again at this time, the test tone will stop.

- Press the **RETURN** button to return to the previous level.
- Press the **EXIT** button to exit the setup screen.

Alternative method: press the **TEST TONE** button on the remote.

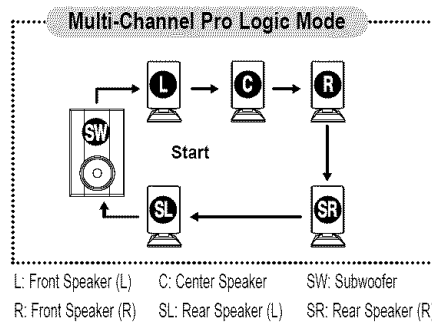

- Press the **TEST TONE** button.
- Test tone will be produced as follows:  
When playing a DVD or CD, this will work only in Stop mode.
  - Use this function to check that each speaker is correctly connected and that there is no problem.
  - When HDMI AUDIO is on (audio is produced through TV speakers), the TEST TONE function is not available.
- To end the test tone, press the **TEST TONE** button again.

## Setting the Audio

You can adjust the balance and level for each speaker.

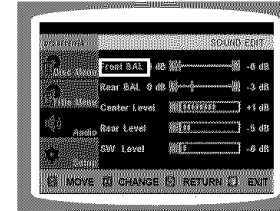
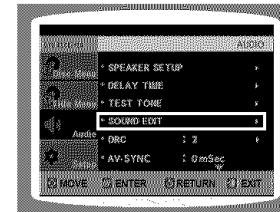

- 1 In Stop mode, press the **MENU** button.
  - 2 Press the Cursor **▼** button to move to **<Audio>** and then press the **ENTER** button.
  - 3 Press the Cursor **▼** button to move to **<SOUND EDIT>** and then press the **ENTER** button.
  - 4 Press the Cursor **▲, ▼** button to select and adjust the desired item. Press the Cursor **◀, ▶** button to adjust the settings.
- Press the **RETURN** button to return to the previous level.
  - Press the **EXIT** button to exit the setup screen.

### Manually Adjusting the Speaker Volume and Balance with the SOUND EDIT Button.

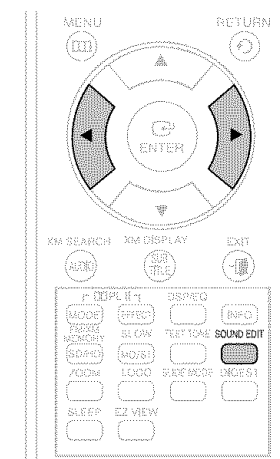

Press the **SOUND EDIT** button and then press the Cursor **◀, ▶** button.

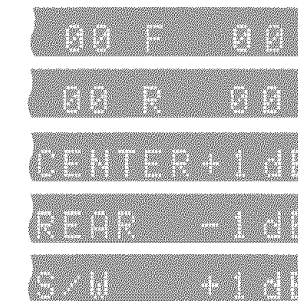

#### Adjusting Front/Rear Speaker Balance

- You can select between 00, -06, and OFF.
- The volume decreases as you move closer to -6.

#### Adjusting Center/Rear/Subwoofer Speaker Level

- The volume level can be adjusted in steps from +6dB to -6dB.
- The sound gets louder as you move closer to +6dB and quieter as you get closer to -6dB.

## Setting the DRC (Dynamic Range Compression)

This feature balances the range between the loudest and quietest sounds. You can use this function to enjoy Dolby Digital sound when watching movies at low volume at night.

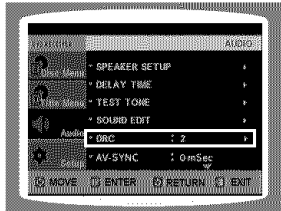

- 1 In Stop mode, press the **MENU** button.
- 2 Press the Cursor **▼** button to move to **<Audio>** and then press the **ENTER** button.
- 3 Press the Cursor **▼** button to move to **<DRC>** and then press the **ENTER** button.
- 4 Press the Cursor **▲, ▼** button to adjust the DRC.
  - When the Cursor **▲** button is pressed, the effect is greater, and when the Cursor **▼** button is pressed, the effect is smaller.

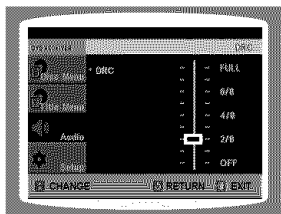

- Press the **RETURN** button to return to the previous level.
- Press the **EXIT** button to exit the setup screen.

## Setting the AV SYNC

Video may look slower than the audio if it is connected to a digital TV. If this occurs, adjust the audio delay time to match the video.

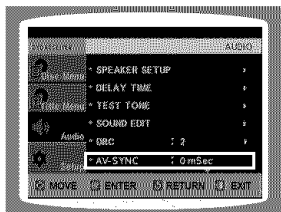

- 1 In Stop mode, press the **MENU** button.
- 2 Press the Cursor **▼** button to move to **<Audio>** and then press the **ENTER** button.
- 3 Press the Cursor **▼** button to move to **<AV-SYNC>** and then press the **ENTER** button.
- 4 Press the Cursor **▲, ▼** button to select the AV-SYNC Delay Time and then press the **ENTER** button.
  - You can set the audio delay time between 0 ms and 300 ms. Set it to the optimal status.

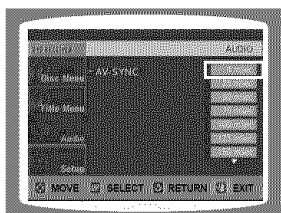

- Press the **RETURN** button to return to the previous level.
- Press the **EXIT** button to exit the setup screen.

## Setting the HDMI Audio

The audio signals transmitted over the HDMI Cable can be toggled ON/OFF.



- 1 In Stop mode, press the **MENU** button.
- 2 Press the Cursor **▼** button to move to **<Audio>** and then press the **ENTER** button.
- 3 Press the Cursor **▼** button to move to **<HDMI AUDIO>** and then press the **ENTER** button.
- 4 Press the Cursor **▲, ▼** button to select **<ON>** or **<OFF>** and then press the **ENTER** button.

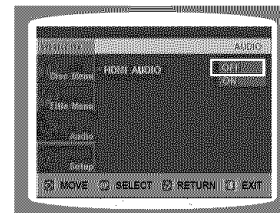

- **ON** : Both video and audio signals are transmitted over the HDMI connection cable, and audio is output through your TV speakers only.
- **OFF** : Video is transmitted over the HDMI connection cable only, and audio is output through the home theater speakers only.



- The default setting of this function is HDMI AUDIO OFF.
- HDMI AUDIO is automatically down-mixed to 2ch for TV speakers.
- The HDMI AUDIO is not available when using the HDMI IN function.

- Press the **RETURN** button to return to the previous level.
- Press the **EXIT** button to exit the setup screen.

## Sound Field (DSP)/EQ Function

DSP(Digital Signal Processor) : DSP modes have been designed to simulate different acoustic environments.  
EQ : You can select ROCK, POP, or CLASSIC to optimize the sound for the genre of music you are playing

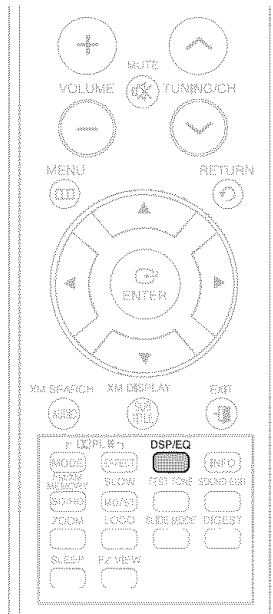

Press the **DSP/EQ** button.

- <DSP> appears on the display panel.
- Each time the button is pressed, the selection changes as follows:

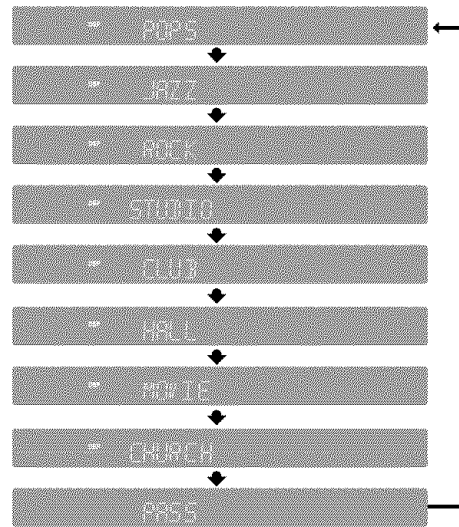

- POP, JAZZ, ROCK : Depending on the genre of music, you can select POP, JAZZ, and ROCK.
- STUDIO : Provides a sense of presence as if in a studio.
- CLUB : Simulates the sound of a dance club with a throbbing bass beat.
- HALL : Provides a clear vocal as if listening in a concert hall.
- MOVIE : Provides the feeling of a movie theater.
- CHURCH : Gives the feel of being in a grand church.
- PASS : Select this for normal listening.

- The DSP/EQ function is only available in STEREO mode. Press the **PL II MODE** button to show STEREO on the display.
- This feature works with CDs, MP3-CDs, 2 channel DVD-Audio, DivX and Dolby Digital discs.
- When playing a DVD disc encoded with two or more channels, multi-channel mode will be selected automatically and DSP/EQ function does not work.

## Dolby Pro Logic II Mode

You can select the desired Dolby Pro Logic II audio mode.

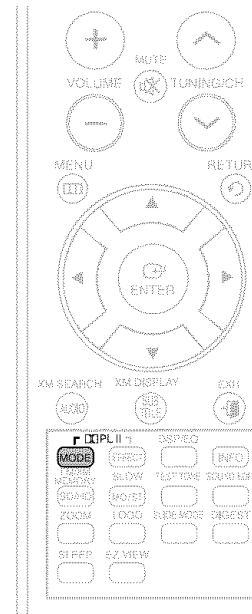

Press the **PL II MODE** button.

- Each time the button is pressed, the mode changes as follows.

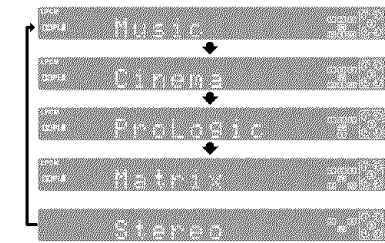

### PRO LOGIC II

- MUSIC: When listening to music, you can experience sound effects as if you are listening to the actual performance.
- CINEMA : Adds realism to the movie soundtrack.
- PRO LOGIC : You will experience a realistic multi-channel effect, as if using five speakers, while using just the front left and right speakers.
- MATRIX : You will hear 5.1 channel surround sound.

**STEREO** : Select this to listen to sound from the front left and right speakers and the subwoofer only.

- When selecting Pro Logic II mode, connect your external device to the AUDIO INPUT jacks (L and R) on the player. If you connect to only one of the inputs (L or R), you cannot listen to surround sound.

## Dolby Pro Logic II Effect

This function works only in Dolby Pro Logic MUSIC mode.

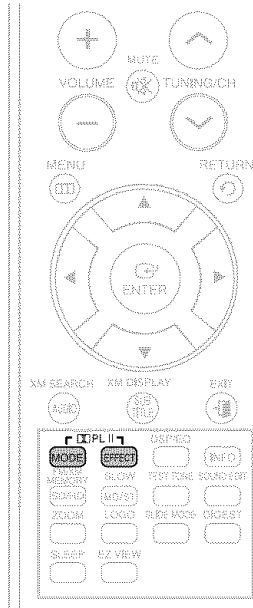

- 1 Press the **PL II MODE** button to select <MUSIC> mode.
  - You can select either 0 or 1.
  - This mode extends the front stereo image to include the surround speakers for an exciting "wraparound" effect with side wall imaging.
- 2 Press the **PL II EFFECT** button to select <PANORAMA>, then press the Cursor **◀, ▶** button to select the desired effect setting.
  - You can select between 0 and 7.
  - This sets the width of the center image. The higher the setting, the less sound comes from the center speaker.
- 3 Press the **PL II EFFECT** button to select <C-WIDTH>, then press the Cursor **◀, ▶** button to select the desired effect setting.
  - You can select between 0 and 6.
  - Incrementally adjusts the sound field (DSP) from the front or rear.
- 4 Press the **PL II EFFECT** button to select <DIMENS>, then press the Cursor **◀, ▶** button to select the desired setting
  - You can select between 0 and 6.
  - Incrementally adjusts the sound field (DSP) from the front or rear.

• When playing a DVD disc encoded with two or more channels, multi-channel mode will be selected automatically and the **PL II** (Dolby Pro Logic II) button does not work.

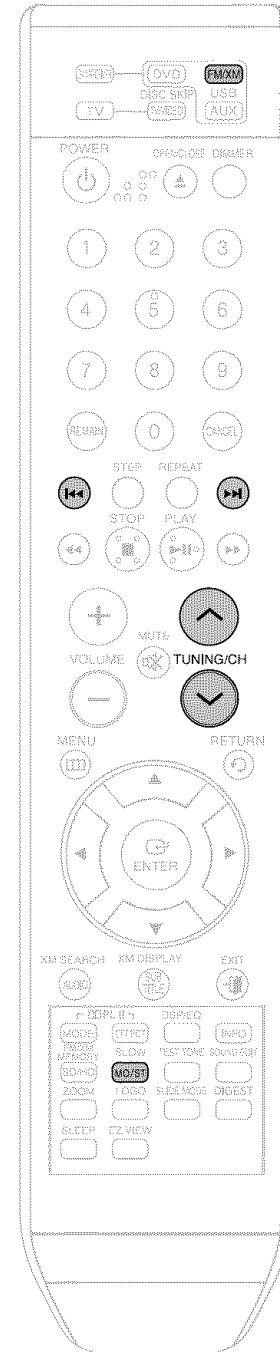

### Remote Control

- 1 Press the **FM/XM** button to select the FM band.
- 2 Tune in to the desired station.
  - Automatic Tuning 1 : When the **◀▶▶▶** button is pressed, a preset broadcast station is selected.
  - Automatic Tuning 2 : Press and hold the **▼, ▲** button to automatically search for active broadcasting stations.
  - Manual Tuning : Briefly press the **▼, ▲** button to increase or decrease the frequency incrementally.

### Main Unit

- 1 Press the **FUNCTION** button to select the FM band.
  - 2 Select a broadcast station.
    - Automatic Tuning 1 : Press the **STOP** (■) button to select <PRESET> and then press the **◀▶▶▶** button to select the preset station.
    - Automatic Tuning 2 : Press the **STOP** (■) button to select <MANUAL> and then press and hold the **◀▶▶▶** button to automatically search the band.
    - Manual Tuning : Press the **STOP** (■) button to select <MANUAL> and then briefly press the **◀▶▶▶** button to tune in to a lower or higher frequency.
- Press the **MO/ST** button to listen in Mono/Stereo.
- Each time the button is pressed, the sound switches between <STEREO> and <MONO>.
  - In a poor reception area, select MONO for a clear, interference-free broadcast.

## Presetting Stations

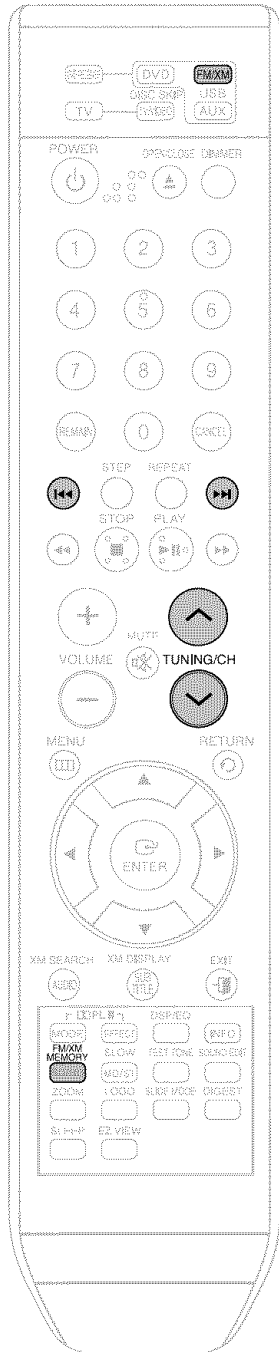

Example : Presetting FM 89.10 in the memory

- 1 Press the **FM/XM** button to select the FM band.
  - 2 Press the **▼, ▲** button to select <89.10>.
    - ▶ **FM 89.10**
  - 3 Press the **FM/XM MEMORY** button.
    - <PRGM> flashes in the display.
    - ▶ **FM 89.10**
  - 4 Press the **◀▶▶▶** button to select preset number.
    - You can select between 1 and 15 presets.
    - ▶ **FM 89.10**
  - 5 Press the **FM/XM MEMORY** button again.
    - Press the FM/XM MEMORY button before <PRGM> disappears from the display.
    - <PRGM> disappears from the display and the station is stored in memory.
  - 6 To preset another station, repeat steps 2 to 5.
- To tune in to a preset station, press the **◀▶▶▶** button on the remote control to select a channel.

✎ This unit does not receive AM broadcasts.

## Before Using XM Satellite Radio

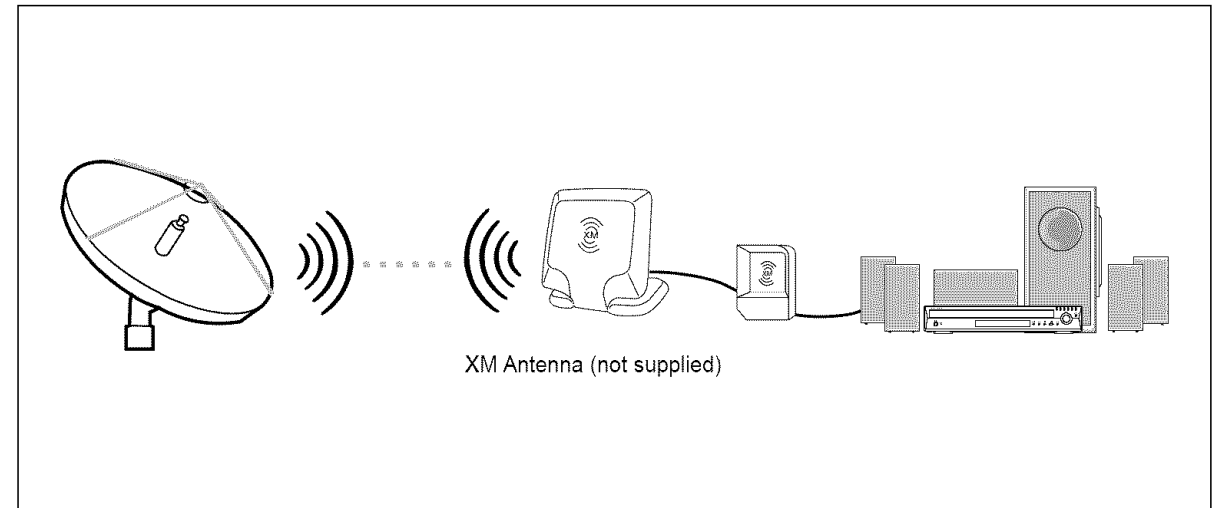

### What is XM satellite Radio?

XM Satellite Radio is the satellite radio service with millions of listeners across the U.S., broadcasting live daily. XM's channel lineup includes more than 160 digital channels of choice from coast to coast: 68 commercial-free music channels, featuring hip hop to opera, classical to country, bluegrass to blues; 33 channels of premier sports, talk, comedy, children's and entertainment programming; and more than 20 channels of the traffic and weather information for major metropolitan areas nationwide.

- ✎ The XM Satellite Radio service is only available in the 48 contiguous United States (not available in Alaska and Hawaii).
- ✎ The XM Antenna and monthly subscription are sold separately. For details, see the XM Satellite Radio website at "<http://www.xmradio.com>"
- ✎ To ensure optimal reception of XM's satellite signal, the XM Antenna should be placed at or near a southerly facing window with nothing obstructing its path to the sky. You can mount it indoors or outdoors.

## Listening to XM Satellite Radio

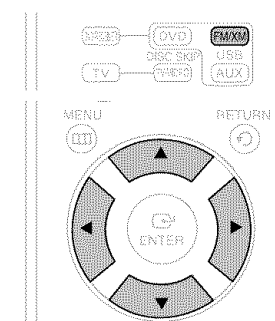

- 1 Press the **FM/XM** button (or **FUNCTION** button on the main unit) and select the XM band.
  - Each time the FM/XM button is pressed, the band switches between <FM> → <XM>
  - ▶ **102.01**
- 2 Press the Cursor **◀, ▶** button to select the channel, press the Cursor **▲, ▼** button to select the category.
  - You can select the channel directly by pressing the number buttons(1 to 255).

- ✎ If <CHECK ANTENNA> appears in the display, the XM Antenna may not be connected to the XM Antenna Jack on the rear of this unit properly.
- ✎ When the selected channel is not available, <CH---> is displayed.



## XM Display Mode

The XM features described here only operate when the optional XM antenna is connected to the main unit.

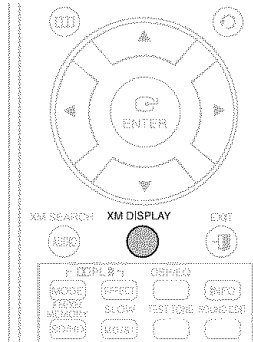

Press the **XM DISPLAY** button.

- Each time the XM DISPLAY button is pressed, the mode changes as follows:

CHANNEL NAME/NUMBER → CHANNEL CATEGORY → ARTIST NAME/SONG TITLE → SIGNAL STRENGTH

- When the Channel Name/Number is displayed :
- When the Channel Category is displayed :
- When the Artist Name/Song Title is displayed :
- When the Signal Strength is displayed :

- The front panel display can indicate up to 10 alphanumeric characters at once. If the information contains more than 10 characters, the information scrolls from right to left.
- If the information contains a character that cannot be recognized by the unit, the character will be displayed with an underbar < \* >.

## XM Search Mode

The XM features described here only operate when the optional XM antenna is connected to the main unit.

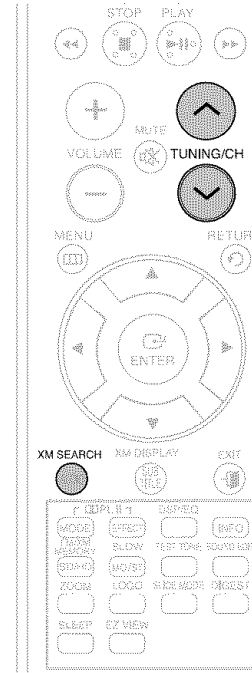

Press the **XM SEARCH** button.

- Each time the XM SEARCH button is pressed, the mode changes as follows:

CHANNEL SEARCH → CATEGORY SEARCH → PRESET SEARCH

- Channel Search Mode :**  
Press the TUNING/CH (or button on the main unit) to move to the desired channel.
- Category Search Mode :**  
Press the TUNING/CH (or button on the main unit) to select the channel within the selected category.
- Preset Search Mode :**  
Press the TUNING/CH (or button on the main unit) to select the channel within the memorized channels.

## Checking the XM Signal Strength

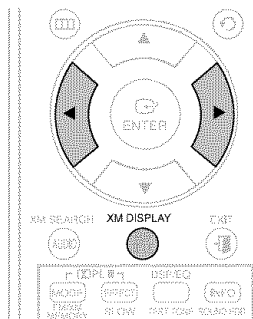

Press the **XM DISPLAY** button until <Signal> is displayed.

- The display changes as shown below according to the receiving condition.

Display	Condition
GOOD	Signal strength is good
MARGINAL	Signal strength is marginal
WEAK	Signal strength is poor
NO	Loss of signal

## Checking the Radio ID

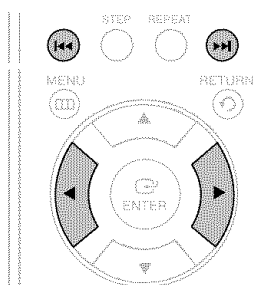

Press the Cursor button (or button on the main unit) to select channel <0>.

- The Radio ID is displayed. The ID below is just an example.

- To sign up for an account with the XM Satellite Radio service, an XM Satellite Radio ID number is required. Follow the procedure above to check your ID number, and then access the website at "http://activate.xmradio.com" or call "1-800-XM-RADIO(1-800-967-2346)" with a major credit card to sign up.



## Presetting XM Satellite Radio

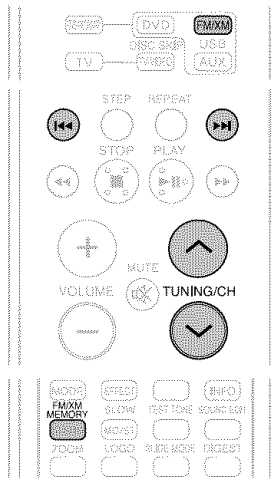

- 1 Press the **FM/XM** button (or **FUNCTION** button on the main unit) and select the XM band.
  - Each time the FM/XM button is pressed, the band switches between <FM> → <XM>.
- 2 Search the XM Satellite Radio channel you want to set as a preset channel.
  - When the channel number <20> is selected.
- 3 Press the **FM/XM MEMORY** button.
  - <PRGM> flashes in the display.
- 4 Press the **◀▶▶▶▶** button select preset number.
  - You can select between 1 and 15 presets.
- 5 Press the **FM/XM MEMORY** button again.
  - Press the **FM/XM MEMORY** button before <PRGM> disappears from the display.
  - <PRGM> disappears from the display and the station is stored in memory.
- 6 To preset another station, repeat steps 2 to 5.

• Up to 15 stations can be saved in memory. If you save more than 15 stations, the oldest station previously saved is removed and a new station is stored in its place.

- To tune in to a preset station, press the **TUNING/CH** button (or **◀▶▶▶▶** button on the main unit) to select a channel.

## Sleep Timer Function

You can set the time that the Home Theater will shut itself off.

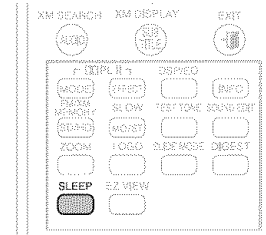

Press the **SLEEP** button.

- <SLEEP> will be displayed. Each time the button is pressed, the preset time changes as follows : 10 → 20 → 30 → 60 → 90 → 120 → 150 → OFF.
- To confirm the sleep timer setting, press the **SLEEP** button.
  - The remaining time before the Home Theater will shut itself off is displayed.
  - Pressing the button again changes the sleep time from what you have set earlier.
- To cancel the sleep timer, press the **SLEEP** button until <OFF> appears on the display.

## Adjusting Display Brightness

You can adjust the brightness of the display on the main unit so it won't interfere with your movie viewing.

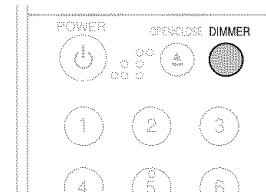

Press the **DIMMER** button.

- Each time the button is pressed, the brightness of front display will be adjusted.

## Mute Function

This is useful when answering a doorbell or telephone call.

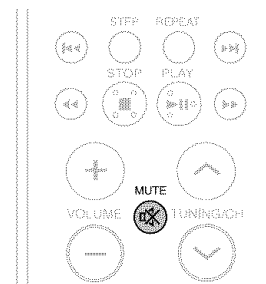

Press the **MUTE** button.

- <MUTE ON> appears in the display.
- To restore the sound, press the **MUTE** button again to select <MUTE OFF>.



## Using Headphones

Use headphones (not supplied) for private listening pleasure.

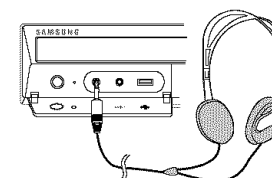

Connect the headphones to the Headphone jack for private listening.

- To prevent hearing damage, do not increase the volume excessively when using headphones.

## When Operating a TV with the Remote Control

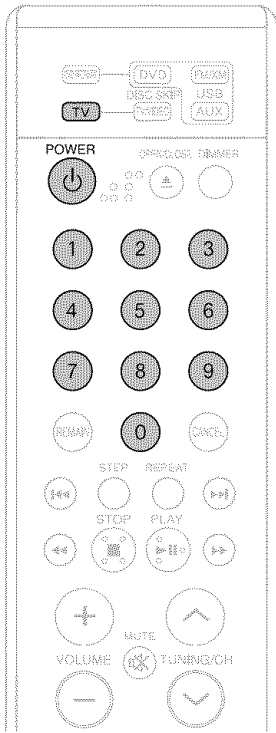

- 1 Press the **TV** button to set the remote to TV mode.
- 2 Press the **POWER** button to turn on the TV.
- 3 While holding down the **POWER** button, enter the code corresponding to your brand of TV.
  - If there is more than one code listed for your TV in the table, enter one at a time to determine which code works.
- 4 If the TV turns off, the setting is complete.
  - You can use the TV **POWER**, **VOLUME**, **CHANNEL**, and **Numeric** buttons (0-9).

### Example : For a Samsung TV

While holding down the **POWER** button, use the number buttons to enter 00, 15, 16, 17 and 40.

- The Remote control may not work on some brands of TVs. Also, some operations may not be possible depending on your brand of TV.
- If you do not set the remote control with the code for your brand of TV, the remote control will work on a Samsung TV by default.

## TV Brand Code List

No.	Brand	Code	No.	Brand	Code
1	Admiral (M.Wards)	56, 57, 58	44	MTC	18
2	A Mark	01, 15	45	NEC	18, 19, 20, 40, 59, 60
3	Anam	01, 02, 03, 04, 05, 06, 07, 08, 09, 10, 11, 12, 13, 14	46	Nikei	03
4	AOC	01, 18, 40, 48	47	Onking	03
5	Bell & Howell (M.Wards)	57, 58, 81	48	Onwa	03
6	Brocsonic	59, 60	49	Panasonic	06, 07, 08, 09, 54, 66, 67, 73, 74
7	Candle	18	50	Penney	18
8	Cetronic	03	51	Philco	03, 15, 17, 18, 48, 54, 59, 62, 69, 90
9	Citizen	03, 18, 25	52	Philips	15, 17, 18, 40, 48, 54, 62, 72
10	Cinema	97	53	Pioneer	63, 66, 80, 91
11	Classic	03	54	Portland	15, 18, 59
12	Concerto	18	55	Proton	40
13	Contec	46	56	Quasar	06, 66, 67
14	Coronado	15	57	Radio Shack	17, 48, 56, 60, 61, 75
15	Craig	03, 05, 61, 82, 83, 84	58	RCA/Proscan	18, 59, 67, 76, 77, 78, 92, 93, 94
16	Croslex	62	59	Realistic	03, 19
17	Crown	03	60	Sampo	40
18	Curtis Mates	59, 61, 63	61	Samsung	00, 15, 16, 17, 40, 43, 46, 47, 48, 49, 59, 60, 98
19	CXC	03	62	Sanyo	19, 61, 65
20	Daewoo	02, 03, 04, 15, 16, 17, 18, 19, 20, 21, 22, 23, 24, 25, 26, 27, 28, 29, 30, 32, 34, 35, 36, 48, 59, 90	63	Scott	03, 40, 60, 61
21	Daytron	40	64	Sears	15, 18, 19
22	Dynasty	03	65	Sharp	15, 57, 64
23	Emerson	03, 15, 40, 46, 59, 61, 64, 82, 83, 84, 85	66	Signature 2000 (M.Wards)	57, 58
24	Fisher	19, 65	67	Sony	50, 51, 52, 53, 55
25	Funai	03	68	Soundesign	03, 40
26	Futuretech	03	69	Spectricon	01
27	General Electric (GE)	06, 40, 56, 59, 66, 67, 68	70	SSS	18
28	Hall Mark	40	71	Sylvania	18, 40, 48, 54, 59, 60, 62
29	Hitachi	15, 18, 50, 59, 69	72	Symphonic	61, 95, 96
30	Inkel	45	73	Tatung	06
31	JC Penny	56, 59, 67, 86	74	Techwood	18
32	JVC	70	75	Teknika	03, 15, 18, 25
33	KTV	59, 61, 87, 88	76	TMK	18, 40
34	KEC	03, 15, 40	77	Toshiba	19, 57, 63, 71
35	KMC	15	78	Vidtech	18
36	LG (Goldstar)	01, 15, 16, 17, 37, 38, 39, 40, 41, 42, 43, 44	79	Videch	59, 60, 69
37	Luxman	18	80	Wards	15, 17, 18, 40, 48, 54, 60, 64
38	LXI (Sears)	19, 54, 56, 59, 60, 62, 63, 65, 71	81	Yamaha	18
39	Magnavox	15, 17, 18, 48, 54, 59, 60, 62, 72, 89	82	York	40
40	Marantz	40, 54	83	Yupiteru	03
41	Matsui	54	84	Zenith	58, 79
42	MGA	18, 40	85	Zonda	01
43	Mitsubishi/MGA	18, 40, 59, 60, 75	86	Dongyang	03, 54

# Troubleshooting

Refer to the chart below when this unit does not function properly. If the problem you are experiencing is not listed below or if the instruction below does not help, turn off the unit, disconnect the power cord, and contact the nearest authorized dealer or Samsung Electronics Service Center.

Symptom	Check/Remedy
Disc tray does not open.	<ul style="list-style-type: none"> <li>Is the power cord plugged securely into the outlet?</li> <li>Turn off the power and then turn it back on.</li> </ul>
Playback does not start.	<ul style="list-style-type: none"> <li>Check the region number of the DVD. DVD discs purchased from abroad may not be playable.</li> <li>CD-ROMs and DVD-ROMs cannot be played on this DVD player.</li> <li>Make sure that the rating level is correct.</li> </ul>
Playback does not start immediately when the Play/Pause button is pressed.	<ul style="list-style-type: none"> <li>Are you using a deformed disc or a disc with scratches on the surface?</li> <li>Wipe the disc clean.</li> </ul>
Sound is not produced.	<ul style="list-style-type: none"> <li>No sound is heard during fast playback, slow playback, and step motion playback.</li> <li>Are the speakers connected properly? Is the speaker setup correctly customized?</li> <li>Is the disc severely damaged?</li> </ul>
Sound can be heard only from a few speakers and not all six.	<ul style="list-style-type: none"> <li>When listening to a CD or radio, sound is output to the front speakers (L/R) only. Select "PRO LOGIC II" by pressing (Dolby Pro Logic II) on the remote control to use all six speakers.</li> <li>Make sure that the DVD disc is 5.1-CH compatible.</li> <li>If you set C, SL, and SR to NONE in the speaker mode in the audio setup of the setup screen, no sound is heard from the center speaker and the front left and right speakers. Set C, SL, and SR to SMALL.</li> </ul>
Dolby Digital 5.1 CH Surround Sound is not produced.	<ul style="list-style-type: none"> <li>Is there "Dolby Digital 5.1 CH" mark on the disc? Dolby Digital 5.1 CH Surround Sound is produced only if the disc is recorded with 5.1 channel sound.</li> <li>Is the audio language correctly set to DOLBY DIGITAL 5.1-CH in the information display?</li> </ul>
The remote control does not work.	<ul style="list-style-type: none"> <li>Is the remote control being operated within its operation range of angle and distance?</li> <li>Are the batteries exhausted?</li> <li>Have you selected the mode(TV/DVD) functions of the remote control (TV or DVD) correctly?</li> </ul>

Symptom	Check/Remedy
<ul style="list-style-type: none"> <li>Disc is rotating but no picture is produced.</li> <li>Picture quality is poor and picture is shaking.</li> </ul>	<ul style="list-style-type: none"> <li>Is the TV power on?</li> <li>Are the video cables connected properly?</li> <li>Is the disc dirty or damaged?</li> <li>A poorly manufactured disc may not be playable.</li> </ul>
Audio language and subtitles do not work.	<ul style="list-style-type: none"> <li>Audio language and subtitles will not work if the disc does not contain them.</li> </ul>
Menu screen does not appear even when the menu function is selected.	<ul style="list-style-type: none"> <li>Are you using a disc that does not contain menus?</li> </ul>
Aspect ratio cannot be changed.	<ul style="list-style-type: none"> <li>You can play 16:9 DVDs in 16:9 WIDE mode, 4:3 LETTER BOX mode, or 4:3 PAN SCAN mode, but 4:3 DVDs can be seen in 4:3 ratio only. Refer to the DVD disc jacket and then select the appropriate function.</li> </ul>
<ul style="list-style-type: none"> <li>The main unit is not working. (Example: The power goes out or strange noise is heard.)</li> <li>The DVD player is not working normally.</li> </ul>	<ul style="list-style-type: none"> <li>Turn off the power and hold the <b>STOP</b>( ■ ) button on the main unit for longer than 5 seconds.</li> <li><b>Using the RESET function will erase all stored settings. Do not use this unless necessary.</b></li> </ul>
The password for rating level has been forgotten.	<ul style="list-style-type: none"> <li>While "NO DISC" message appears on the display of main unit, hold the main unit's <b>STOP</b>( ■ ) button for longer than 5 seconds. &lt;INITIAL&gt; appears on the display and all settings will return to the default values.</li> <li>Press the POWER button.</li> <li><b>Using the RESET function will erase all stored settings. Do not use this unless necessary.</b></li> </ul>
Can't receive radio broadcast.	<ul style="list-style-type: none"> <li>Is the antenna connected properly?</li> <li>If the antenna's input signal is weak, install an external FM antenna in an area with good reception.</li> </ul>
<CHECK ANTENNA> is displayed.	<ul style="list-style-type: none"> <li>XM Antenna Jack and the XM Antenna is not properly connected. Check the connections.</li> </ul>
<ON SIGNAL> is displayed.	<ul style="list-style-type: none"> <li>Reposition your XM Antenna.</li> </ul>
<OFF AIR> is displayed.	<ul style="list-style-type: none"> <li>The selected channel is not currently broadcasting.</li> </ul>
Receiving only XM channel 0 and channel 1.	<ul style="list-style-type: none"> <li>XM Antenna is not activated.</li> <li>Access the website at "http://activate.xmradio.com" with a credit card to sign up.</li> </ul>

# Cautions on Handling and Storing Discs

Small scratches on the disc may reduce sound and picture quality or cause skipping. Be especially careful not to scratch discs when handling them.

## Handling discs

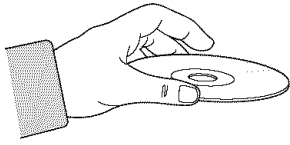

Do not touch the playback side of the disc. Hold the disc by the edges so that fingerprints will not get on the surface. Do not stick paper or tape on the disc.

## Disc Storage

Do not keep in direct sunlight

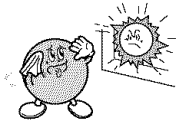

Keep in a cool ventilated area

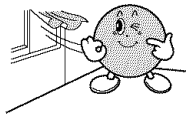

Keep in a clean Protection jacket. Store vertically.

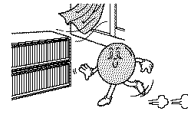

- Do not allow the discs to become contaminated with dirt.
- Do not load cracked or scratched discs.

## Handling and Storing Discs

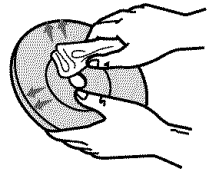

When you get fingerprints or dirt on the disc, clean it with a mild detergent diluted in water and wipe with a soft cloth.

- When cleaning, wipe gently from the inside to the outside of the disc.

- Condensation may form if warm air comes into contact with cold parts inside the player. When condensation forms inside the player, the player may not operate correctly. If this occurs, remove the disc and let the player stand for 1 or 2 hours with the power on.

# Language Code List

Enter the appropriate code number for the initial settings "Disc Audio", "Disc Subtitle" and/or "Disc Menu" (See page 46).

Code	Language	Code	Language	Code	Language	Code	Language
1027	Afar	1181	Frisian	1334	Latvian, Lettish	1506	Slovenian
1028	Abkhazian	1183	Irish	1345	Malagasy	1507	Samoa
1032	Afrikaans	1186	Scots Gaelic	1347	Maori	1508	Shona
1039	Amharic	1194	Galician	1349	Macedonian	1509	Somali
1044	Arabic	1196	Guarani	1350	Malayalam	1511	Albanian
1045	Assamese	1203	Gujarati	1352	Mongolian	1512	Serbian
1051	Aymara	1209	Hausa	1353	Moldavian	1513	Siswati
1052	Azerbaijani	1217	Hindi	1356	Marathi	1514	Sesotho
1053	Bashkir	1226	Croatian	1357	Malay	1515	Sundanese
1057	Byelorussian	1229	Hungarian	1358	Maltese	1516	Swedish
1059	Bulgarian	1233	Armenian	1363	Burmese	1517	Swahili
1060	Bihari	1235	Interlingua	1365	Nauru	1521	Tamil
1069	Bislama	1239	Interlingue	1369	Nepali	1525	Tegulu
1066	Bengali; Bangla	1245	Inupiak	1376	Dutch	1527	Tajik
1067	Tibetan	1248	Indonesian	1379	Norwegian	1528	Thai
1070	Breton	1253	Icelandic	1393	Occitan	1529	Tigrinya
1079	Catalan	1254	Italian	1403	(Afan) Oromo	1531	Turkmen
1093	Corsican	1257	Hebrew	1408	Oriya	1532	Tagalog
1097	Czech	1261	Japanese	1417	Punjabi	1534	Setswana
1103	Welsh	1269	Yiddish	1428	Polish	1535	Tonga
1105	Danish	1283	Javanese	1435	Pashto, Pushto	1538	Turkish
1109	German	1287	Georgian	1436	Portuguese	1539	Tsonga
1130	Bhutani	1297	Kazakh	1463	Quechua	1540	Tatar
1142	Greek	1298	Greenlandic	1481	Rhaeto-Romance	1543	Twi
1144	English	1299	Cambodian	1482	Kirundi	1557	Ukrainian
1145	Esperanto	1300	Kannada	1483	Romanian	1564	Urdu
1149	Spanish	1301	Korean	1489	Russian	1572	Uzbek
1150	Estonian	1305	Kashmiri	1491	Kinyarwanda	1581	Vietnamese
1151	Basque	1307	Kurdish	1495	Sanskrit	1587	Volapuk
1157	Persian	1311	Kirghiz	1498	Sindhi	1613	Wolof
1165	Finnish	1313	Latin	1501	Sangro	1632	Xhosa
1166	Fiji	1326	Lingala	1502	Serbo-Croatian	1665	Yoruba
1171	Faeroese	1327	Laothian	1503	Singhalese	1684	Chinese
1174	French	1332	Lithuanian	1505	Slovak	1697	Zulu

# USB Host Feature Supported Products

## Digital Camera

Product	Company	Type
Finepix-A340	Fuji	Digital Camera
Finepix-F810	Fuji	Digital Camera
Finepix-F610	Fuji	Digital Camera
Finepix-f450	Fuji	Digital Camera
Finepix S7000	Fuji	Digital Camera
Finepix A310	Fuji	Digital Camera
KD-310Z	Konica	Digital Camera
Finecam SL300R	Kyocera	Digital Camera
Finecam SL400R	Kyocera	Digital Camera
Finecam S5R	Kyocera	Digital Camera
Finecam Xt	Kyocera	Digital Camera
Dimage-Z1	Minolta	Digital Camera
Dimage Z1	Minolta	Digital Camera
Dimage X21	Minolta	Digital Camera
Coolpix4200	Nikon	Digital Camera
Coolpix4300	Nikon	Digital Camera
Coolpix 2200	Nikon	Digital Camera
Coolpix 3500	Nikon	Digital Camera
Coolpix 3700	Nikon	Digital Camera
Coolpix 4100	Nikon	Digital Camera
Coolpix 5200	Nikon	Digital Camera
Stylus 410 digital	Olympus	Digital Camera
300-digital	Olympus	Digital Camera
U300	Olympus	Digital Camera
X-350	Olympus	Digital Camera
C-760	Olympus	Digital Camera
C-5060	Olympus	Digital Camera
X1	Olympus	Digital Camera
U-mini	Olympus	Digital Camera
Lumix-FZ20	Panasonic	Digital Camera
DMC-FX7GD	Panasonic	Digital Camera
Lumix LC33	Panasonic	Digital Camera
LUMIX DMC-F1	Panasonic	Digital Camera
Optio-S40	Pentax	Digital Camera
Optio-S50	Pentax	Digital Camera
Optio 33LF	Pentax	Digital Camera
Optio MX	Pentax	Digital Camera
Digimax-420	Samsung	Digital Camera
Digimax-400	Samsung	Digital Camera
Sora PDR-T30	Toshiba	Digital Camera
Coolpix 5900	Nikon	Digital Camera
Coolpix S1	Nikon	Digital Camera
Coolpix 7600	Nikon	Digital Camera
DMC-FX7	Panasonic	Digital Camera
Dimage Xt	Minolta	Digital Camera
AZ-1	Olympus	Digital Camera

## USB Flash Disc

Product	Company	Type
Cruzer Micro	Sandisk	USB 2.0 USB Flash Drive 128M
Cruzer Mini	Sandisk	USB 2.0 128M
Cruzer Mini	Sandisk	USB 2.0 256M
SONY Micro Vault	Sony	USB 2.0 64MB
FLEX DRIVE	Serotech	USB 2.0 32MB
AnyDrive	A.L.tech	USB 2.0 128MB
XTICK	LG	USB 2.0 128M
Micro Mini	lomega	USB 2.0 128M
iFlash	Imation	USB 2.0 64M
LG	XTICK(M)	USB 2.0 64M
RiDATA	EZdrive	USB 2.0 64M

## MP3 Player

Product	Company	Type
Creative MuVo NX128M	Creative	128 MB MP3 Player
Iriver H320	Iriver	20G HDD MP3 Player
YH-920	Samsung	20G HDD MP3 Player
YP-T7	Samsung	MP3 Player
YP-MT6	Samsung	MP3 Player
YP-T6	Samsung	MP3 Player
YP-53	Samsung	MP3 Player
YP-ST5	Samsung	MP3 Player
YP-T5	Samsung	MP3 Player
YP-60	Samsung	MP3 Player
YP-780	Samsung	MP3 Player
YP-35	Samsung	MP3 Player
YP-55	Samsung	MP3 Player
iAUDIO U2	Cowon	MP3 Player
iAUDIO G3	Cowon	MP3 Player
iAudio M3	Cowon	HDD MP3 Player
SI-M500L	Sharp	256MB MP3 Player
H10	Iriver	MP3 Player
YP-T5 VB	Samsung	MP3 Player
YP-53	Samsung	256MB MP3 Player

## USB External HDD

Product	Company	Type
MOMOBAY UX-2	Dvico	USB 2.0

# Specifications

GENERAL	Power Requirements	AC 120V ~ 60Hz
	Power Consumption	90W
	Weight	11lbs
	Dimensions (W x H x D)	17 x 3 x 17.1 inches
	Operating Temperature Range	41°F ~ 95°F
	Operating Humidity Range	10% ~ 75%
FM TUNER	Usable Sensitivity	10dB
	S/N Ratio	60dB
	Distortion	1%
VIDEO OUTPUT	Composite Video	1.0Vp-p(75Ω load)
	Component Video	Y:1.0Vp-p(75Ω load)
		Pr:0.70Vp-p(75Ω load)
		Pb:0.70Vp-p(75Ω load)
HDMI	Impedance: 85~115Ω	
AMPLIFIER	Front speaker output	133W x 2(3Ω)
	Center speaker output	160W(3Ω)
	Rear speaker output	133W x 2(3Ω)
	Subwoofer speaker output	268W(3Ω)
	Frequency range	20Hz~20KHz
	S/N Ratio	75dB
	Channel separation	60dB
	Input sensitivity	(AUX)400mV

D  
M  
V  
D  
E

170W x 2(3Ω)  
180W(3Ω)  
170W x 2(3Ω)  
340W(3Ω)



# Specifications (Con't)

## HT-X70

S P E A K E R	Speaker system	5.1ch speaker system		
		Front/Rear	/Center speaker	Subwoofer speaker
	Impedance	3Ω x 5		3Ω
	Frequency range	150Hz~20KHz		40Hz~200Hz
	Output sound pressure level	86dB/W/M		86dB/W/M
	Rated input	170W	180W	170W x 2
	Maximum input	340W	360W	340W x 2
	Dimensions (W x H x D)	Front/Rear	3.5 in. x 11.8 in. x 4.5 in.	8.7 in. x 15.8 in. x 16.8 in.
		Center	11.8 in. x 3.5 in. x 3.9 in.	
	Weights	Front/Rear	2.1 lbs / 1.8 lbs	24 lbs
		Center	2.8 lbs	

## HT-TX72

S P E A K E R	Speaker system	5.1ch speaker system		
		Front/Rear	/Center speaker	Subwoofer speaker
	Impedance	3Ω x 5		3Ω
	Frequency range	150Hz~20KHz		40Hz~200Hz
	Output sound pressure level	86dB/W/M		86dB/W/M
	Rated input	170W	180W	170W x 2
	Maximum input	340W	360W	340W x 2
	Dimensions (W x H x D)	Front	3.5 in. x 4.5 in. x 3.7 in.	8.7 in. x 15.8 in. x 16.8 in.
		Rear	3.5 in. x 11.8 in. x 4.5 in.	
		Center	11.8 in. x 3.5 in. x 3.9 in.	
	Weights	Front	8 lbs	24 lbs
		Rear	1.8 lbs	
		Center	2.8 lbs	

## HT-TX75

S P E A K E R	Speaker system	5.1ch speaker system		
		Front/Rear	/Center speaker	Subwoofer speaker
	Impedance	3Ω x 5		3Ω
	Frequency range	150Hz~20KHz		40Hz~200Hz
	Output sound pressure level	86dB/W/M		86dB/W/M
	Rated input	170W	180W	170W x 2
	Maximum input	340W	360W	340W x 2
	Dimensions (W x H x D)	Front/Rear	3.5 in. x 4.5 in. x 3.7 in.	8.7 in. x 15.8 in. x 16.8 in.
		Center	11.8 in. x 3.5 in. x 3.9 in.	
	Weights	Front/Rear	8 lbs / 7.4 lbs	24 lbs
		Center	2.8 lbs	

# Warranty

## LIMITED WARRANTY TO ORIGINAL PURCHASER

This SAMSUNG brand product, as supplied and distributed by Samsung Electronics America, Inc. (SAMSUNG) and delivered new, in the original carton to the original consumer purchaser, is warranted by SAMSUNG against manufacturing defects in materials and workmanship for a limited warranty period of:

**One (1) Year Parts and Labor\***  
(\*90 Days Parts and Labor for Commercial Use)

This limited warranty begins on the original date of purchase, and is valid only on products purchased and used in the United States. To receive warranty service, the purchaser must contact SAMSUNG for problem determination and service procedures. Warranty service can only be performed by a SAMSUNG authorized service center. The original dated bill of sale must be presented upon request as proof of purchase to SAMSUNG or SAMSUNG's authorized service center. Transportation of the product to and from the service center is the responsibility of the purchaser.

SAMSUNG will repair or replace this product, at our option and at no charge as stipulated herein, with new or reconditioned parts or products if found to be defective during the limited warranty period specified above. All replaced parts and products become the property of SAMSUNG and must be returned to SAMSUNG. Replacement parts and products assume the remaining original warranty, or ninety (90) days, whichever is longer.

SAMSUNG's obligations with respect to software products distributed by SAMSUNG under the SAMSUNG brand name are set forth in the applicable end user license agreement. Non-SAMSUNG hardware and software products, if provided, are on an "AS IS" basis. Non-SAMSUNG manufacturers, suppliers, publishers, and service providers may provide their own warranties.

This limited warranty covers manufacturing defects in materials and workmanship encountered in normal, and except to the extent otherwise expressly provided for in this statement, noncommercial use of this product, and shall not apply to the following, including, but not limited to: damage which occurs in shipment; delivery and installation; applications and uses for which this product was not intended; altered product or serial numbers; cosmetic damage or exterior finish; accidents, abuse, neglect, fire, water, lightning or other acts of nature; use of products, equipment, systems, utilities, services, parts, supplies, accessories, applications, installations, repairs, external wiring or connectors not supplied and authorized by SAMSUNG, or which damage this product or result in service problems; incorrect electrical line voltage, fluctuations and surges; customer adjustments and failure to follow operating instructions, cleaning, maintenance and environmental instructions that are covered and prescribed in the instruction book; product removal or reinstallation; reception problems and distortion related to noise, echo, interference or other signal transmission and delivery problems. SAMSUNG does not warrant uninterrupted or error-free operation of the product.

THERE ARE NO EXPRESS WARRANTIES OTHER THAN THOSE LISTED AND DESCRIBED ABOVE, AND NO WARRANTIES WHETHER EXPRESS OR IMPLIED, INCLUDING, BUT NOT LIMITED TO, ANY IMPLIED WARRANTIES OF MERCHANTABILITY OR FITNESS FOR A PARTICULAR PURPOSE, SHALL APPLY AFTER THE EXPRESS WARRANTY PERIODS STATED ABOVE, AND NO OTHER EXPRESS WARRANTY OR GUARANTY GIVEN BY ANY PERSON, FIRM OR CORPORATION WITH RESPECT TO THIS PRODUCT SHALL BE BINDING ON SAMSUNG. SAMSUNG SHALL NOT BE LIABLE FOR LOSS OF REVENUE OR PROFITS, FAILURE TO REALIZE SAVINGS OR OTHER BENEFITS, OR ANY OTHER SPECIAL, INCIDENTAL OR CONSEQUENTIAL DAMAGES CAUSED BY THE USE, MISUSE OR INABILITY TO USE THIS PRODUCT, REGARDLESS OF THE LEGAL THEORY ON WHICH THE CLAIM IS BASED, AND EVEN IF SAMSUNG HAS BEEN ADVISED OF THE POSSIBILITY OF SUCH DAMAGES. NOR SHALL RECOVERY OF ANY KIND AGAINST SAMSUNG BE GREATER IN AMOUNT THAN THE PURCHASE PRICE OF THE PRODUCT SOLD BY SAMSUNG AND CAUSING THE ALLEGED DAMAGE. WITHOUT LIMITING THE FOREGOING, PURCHASER ASSUMES ALL RISK AND LIABILITY FOR LOSS, DAMAGE OR INJURY TO PURCHASER AND PURCHASER'S PROPERTY AND TO OTHERS AND THEIR PROPERTY ARISING OUT OF THE USE, MISUSE OR INABILITY TO USE THIS PRODUCT SOLD BY SAMSUNG NOT CAUSED DIRECTLY BY THE NEGLIGENCE OF SAMSUNG. THIS LIMITED WARRANTY SHALL NOT EXTEND TO ANYONE OTHER THAN THE ORIGINAL PURCHASER OF THIS PRODUCT, IS NONTRANSFERABLE AND STATES YOUR EXCLUSIVE REMEDY.

Some states do not allow limitations on how long an implied warranty lasts, or the exclusion or limitation of incidental or consequential damages, so the above limitations or exclusions may not apply to you. This warranty gives you specific legal rights, and you may also have other rights which vary from state to state.

To obtain warranty hardware service, please contact SAMSUNG at:

**Samsung Electronics America, Inc.**  
105 Challenger Road Ridgefield Park, NJ 07660-0511  
1-800-SAMSUNG (726-7864) and [www.samsung.com](http://www.samsung.com)

## Contact SAMSUNG WORLD WIDE

If you have any questions or comments relating to Samsung products, please contact the SAMSUNG customer care centre.

Region	Country	Customer Care Center	Web Site
North America	CANADA	1-800-SAMSUNG (7267864)	www.samsung.com/ca
	MEXICO	01-800-SAMSUNG (7267864)	www.samsung.com/mx
	U.S.A	1-800-SAMSUNG (7267864)	www.samsung.com
Latin America	ARGENTINE	0800-333-3733	www.samsung.com/ar
	BRAZIL	0800-124-421 4004-0000	www.samsung.com/br
	CHILE	800-726-7864 (SAMSUNG)	www.samsung.com/cl
	COSTA RICA	0-800-507-7267	www.samsung.com/latin
	ECUADOR	1-800-10-7267	www.samsung.com/latin
	EL SALVADOR	800-6225	www.samsung.com/latin
	GUATEMALA	1-800-299-0013	www.samsung.com/latin
	JAMAICA	1-800-234-7267	www.samsung.com/latin
	PANAMA	800-7267	www.samsung.com/latin
	PUERTO RICO	1-800-682-3180	www.samsung.com/latin
	REP. DOMINICA	1-800-751-2676	www.samsung.com/latin
	TRINIDAD & TOBAGO	1-800-7267-864	www.samsung.com/latin
	VENEZUELA	0-800-100-5303	www.samsung.com/latin
COLOMBIA	01-8000112112	www.samsung.com.co	
Europe	BELGIUM	02 201 2418	www.samsung.com/be
	CZECH REPUBLIC	844 000 844 Distributor pro Českou republiku : Samsung Zrt., česká organizační složka Vyskočilova 4, 14000 Praha 4	www.samsung.com/cz
	DENMARK	70 70 19 70	www.samsung.com/dk
	FINLAND	030-6227 515	www.samsung.com/fi
	FRANCE	3260 SAMSUNG or 08 25 08 65 65 (€ 0,15/Min)	www.samsung.com/fr
	GERMANY	01805 - 121213 (€ 0,14/Min)	www.samsung.de
	HUNGARY	06-80-SAMSUNG (7267864)	www.samsung.com/hu
	ITALIA	800-SAMSUNG (7267864)	www.samsung.com/it
	LUXEMBURG	0032 (0)2 201 24 18	www.samsung.lu
	NETHERLANDS	0900 20 200 88 (€ 0,10/Min)	www.samsung.com/nl
	NORWAY	815-56 480	www.samsung.com/no
	POLAND	0 801 801 881	www.samsung.com/pl
	PORTUGAL	80 8 200 128	www.samsung.com/pt
	SLOVAKIA	0800-SAMSUNG (726786)	www.samsung.com/sk
	SPAIN	902 10 11 30	www.samsung.com/es
	SWEDEN	0771-400 200	www.samsung.com/se
	U.K	0870 SAMSUNG (7267864)	www.samsung.com/uk
Republic of Ireland	0818 717 100	www.samsung.com/uk	
Switzerland	0800-7267864	www.samsung.com/ch	
CIS	RUSSIA	8-800-200-0400	www.samsung.ru
	KAZAHSTAN	8-800-080-1188	www.samsung.kz
	UZBEKISTAN	8-800-120-0400	www.samsung.uz
	UKRAINE	8-800-502-0000	www.samsung.com/ur
	LITHUANIA	8-800-77777	www.samsung.lt
	LATVIA	800-7267	www.samsung.com/lv/index.htm
	ESTONIA	800-7267	www.samsung.ee
Asia Pacific	AUSTRALIA	1300 362 603	www.samsung.com/au
	CHINA	800-810-5858, 010-6475 1880	www.samsung.com.cn
	HONG KONG	3698 - 4698	www.samsung.com/hk
	INDIA	3030 8282 1800 110011	www.samsung.com/in
	INDONESIA	0800-112-8888	www.samsung.com/id
	JAPAN	0120-327-527	www.samsung.com/jp
	MALAYSIA	1800-88-9999	www.samsung.com/my
	PHILIPPINES	1800-10-SAMSUNG (7267864)	www.samsung.com/ph
	SINGAPORE	1800-SAMSUNG (7267864)	www.samsung.com/sq
	THAILAND	1800-29-3232 02-689-3232	www.samsung.com/th
TAIWAN	0800-329-999	www.samsung.com/tw	
VIETNAM	1 800 588 889	www.samsung.com/vn	
Middle East & Africa	SOUTH AFRICA	0860 7267864 (SAMSUNG)	www.samsung.com/za
	U.A.E	800SAMSUNG (7267864) 8000-4726	www.samsung.com/mea