

# DVD Home Theater System

HTS8100

User Manual	6
Manuel D'utilisation	58
Manual del usuario	110



Thank you for choosing Philips.

### Need help fast?

Read your Quick Start Guide and/or User Manual first for quick tips that make using your Philips product more enjoyable.

If you have read your instructions and still need assistance, you may access our online help at [www.philips.com/usasupport](http://www.philips.com/usasupport) or call

**1-888-PHILIPS (744-5477)**  
while with your product  
(and Model / Serial number)



Philips vous remercie de votre confiance.

### Besoin d'une aide rapide?

Le Guide rapide de début et Manuel de l'utilisateur regorgent d'astuces destinées à simplifier l'utilisation de votre produit Philips.

Toutefois, si vous ne parvenez pas à résoudre votre problème, vous pouvez accéder à notre aide en ligne à l'adresse [www.philips.com/usasupport](http://www.philips.com/usasupport) ou formez le

**1-800-661-6162 (Francophone)**  
**1-888-PHILIPS (744-5477)**  
(English speaking)

Veillez à avoir votre produit à portée de main  
(et model / serial nombre)



Gracias por escoger Philips

### Necesita ayuda inmediata?

Lea primero la Guía rápida del comienzo o el Manual del usuario, en donde encontrará consejos que le ayudarán a disfrutar plenamente de su producto Philips.

Si después de leerlo aún necesita ayuda, consulte nuestro servicio de asistencia en línea en

[www.philips.com/usasupport](http://www.philips.com/usasupport)  
o llame al teléfono

**1-888-PHILIPS (744-5477)**  
y tenga a mano el producto  
(y número de model / serial)

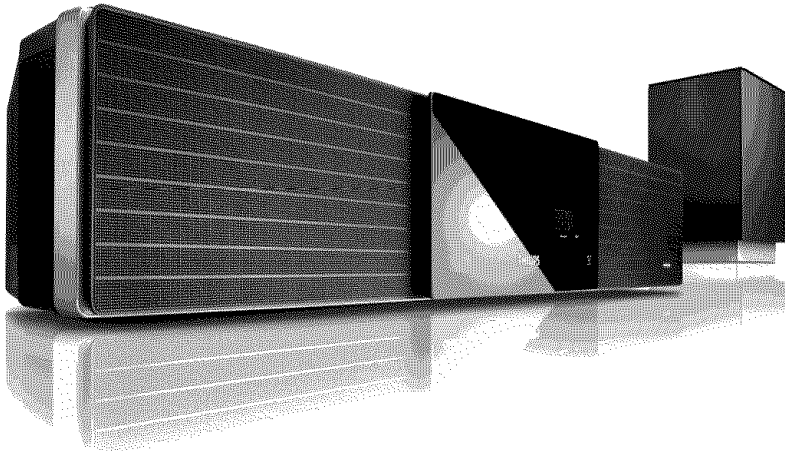

# PHILIPS

**Return your Product Registration Card or register online at  
www.philips.com/usasupport today to get the very most from your purchase.**

Registering your model with PHILIPS makes you eligible for all of the valuable benefits listed below, so don't miss out. Complete and return your Product Registration Card at once, or register online at [www.philips.com/usasupport](http://www.philips.com/usasupport) to ensure:

**\*Proof of Purchase**

Returning the enclosed card guarantees that your date of purchase will be on file, so no additional paperwork will be required from you to obtain warranty service.

**\*Product Safety Notification**

By registering your product, you'll receive notification - directly from the manufacturer - in the rare case of a product recall or safety defect.

**\*Additional Benefits**

Registering your product guarantees that you'll receive all of the privileges to which you're entitled, including special money-saving offers.

# PHILIPS

*Congratulations on your purchase, and welcome to the "family!"*

**Dear PHILIPS product owner:**

Thank you for your confidence in PHILIPS. You've selected one of the best-built, best-backed products available today. We'll do everything in our power to keep you happy with your purchase for many years to come. As a member of the PHILIPS "family," you're entitled to protection by one of the most comprehensive warranties and outstanding service networks in the industry. What's more, your purchase guarantees you'll receive all the information and special offers for which you qualify, plus easy access to accessories from our convenient home shopping network.

Most importantly, you can count on our uncompromising commitment to your total satisfaction.

All of this is our way of saying welcome - and thanks for investing in a PHILIPS product.

**P.S. To get the most from your PHILIPS purchase, be sure to complete and return your Product Registration Card at once, or register online at:**

[www.philips.com/usasupport](http://www.philips.com/usasupport)

Know these **safety symbols**



This "bolt of lightning" indicates uninsulated material within your unit may cause an electrical shock. For the safety of everyone in your household, please do not remove product covering.

The "exclamation point" calls attention to features for which you should read the enclosed literature closely to prevent operating and maintenance problems.

**WARNING:** To reduce the risk of fire or electric shock, this apparatus should not be exposed to rain or moisture and objects filled with liquids, such as vases, should not be placed on this apparatus.

**CAUTION:** To prevent electric shock, match wide blade of plug to wide slot, fully insert.

**ATTENTION:** Pour éviter les choc électriques, introduire la lame la plus large de la fiche dans la borne correspondante de la prise et pousser jusqu'au fond.

**For Customer Use**

Enter below the Serial No. which is located on the rear of the cabinet. Retain this information for future reference.

Model No. \_\_\_\_\_  
Serial No. \_\_\_\_\_

**PHILIPS** Visit our World Wide Web Site at <http://www.philips.com/usasupport>

# IMPORTANT SAFETY INSTRUCTIONS

1. Read these instructions.
2. Keep these instructions.
3. Heed all warnings.
4. Follow all instructions.
5. Do not use this apparatus near water.

6. Clean only with dry cloth.
7. Do not block any ventilation openings. Install in accordance with the manufacturer's instructions.
8. Do not install near any heat sources such as radiators, heat registers, stoves, or other apparatus (including amplifiers) that produce heat.

9. Do not defeat the safety purpose of the polarized or grounding-type plug.

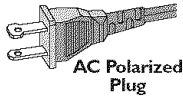

A polarized plug has two blades with one wider than the other. A grounding type plug has two blades and a third grounding prong. The wide blade or the third prong are provided for your safety. If the provided plug does not fit into your outlet, consult an electrician for replacement of the obsolete outlet.

10. Protect the power cord from being walked on or pinched, particularly at plugs, convenience receptacles, and the point where they exit from the apparatus.
11. Only use attachments/accessories specified by the manufacturer:

12.  Use only with the cart, stand, tripod, bracket, or table specified by the manufacturer or sold with the apparatus. When a cart is used, use caution when moving the cart/apparatus combination to avoid injury from tip-over.

13. Unplug this apparatus during lightning storms or when unused for long periods of time.

14. Refer all servicing to qualified service personnel. Servicing is required when the apparatus has been damaged in any way, such as power-supply cord or plug is damaged, liquid has been spilled or objects have fallen into the apparatus, the apparatus has been exposed to rain or moisture, does not operate normally, or has been dropped.

15. Battery usage **CAUTION** – To prevent battery leakage which may result in bodily injury, property damage, or damage to the unit:

- Install **all** batteries correctly, + and - as marked on the unit.
- Do not mix batteries (**old** and **new** or **carbon** and **alkaline**, etc.).
- Remove batteries when the unit is not used for a long time.

16. Apparatus shall not be exposed to dripping or splashing.

17. Do not place any sources of danger on the apparatus (e.g. liquid filled objects, lighted candles).

18. This product may contain lead and mercury. Disposal of these materials may be regulated due to environmental considerations.

**For disposal or recycling information, please contact your local authorities or the Electronic Industries Alliance : [www.eiae.org](http://www.eiae.org).**

EL 6475-E005: 04/01

## LASER

Type	Semiconductor laser GaAlAs
Wave length	650 - 660 nm (DVD) 784 - 796 nm (CD)
Output Power	7 mW (DVD) 10 mW (VCD/CD)
Beam divergence	60 degrees

## Canada

### English:

This digital apparatus does not exceed the Class B limits for radio noise emissions from digital apparatus as set out in the Radio Interference Regulations of the Canadian Department of Communications.

This Class B digital apparatus complies with Canadian ICES-003.

### Français:

Cet appareil numérique n'émet pas de bruits radioélectriques dépassant les limites applicables aux appareils numériques de Class B prescrites dans le Règlement sur le Brouillage Radioélectrique édicté par le Ministère des Communications du Canada.

Cet appareil numérique de la classe B est conforme à la norme NMB-003 du Canada.

This warning label is located on the rearside and inside this laser product.

**CAUTION:** INVISIBLE LASER RADIATION WHEN OPEN. DO NOT STARE INTO BEAM.

**DANGER:** INVISIBLE LASER RADIATION WHEN OPEN. AVOID DIRECT EXPOSURE TO BEAM.

**VARO!** AVATTAESSA JA SUOJALUKITUS OHITETTAESSA OLET ALTTIINANAKYMATTOOMAALLE LASERSATEILYLLE. ALA KATSO SATEESEEN.

**WARNING!** OSYNNIG LASERSTRÅLNING NÄR DENNA DEL ÄR ÖPPNAD. OCH SPÄRREN ÄR URKOPPLAD. BETRÄKTA EJ STRÅLEN.

or

**DANGER -** Invisible laser radiation when open. AVOID DIRECT EXPOSURE TO BEAM.

## CAUTION

Use of controls or adjustments or performance of procedures other than herein may result in hazardous radiation exposure or other unsafe operation.

## ATTENTION

L'utilisation des commandes ou réglages ou le non-respect des procédures ci-incluses peuvent se traduire par une exposition dangereuse à l'irradiation.

## ATENCIÓN

El uso de mando o ajustes o la ejecución de métodos que no sean los aquí descritos puede ocasionar peligro de exposición a radiación.

Due to the inconsistency of disc formats provided by various disc manufacturers, your DVD system/ player/recorder may require a playability enhancement or upgrade. As DVD technology advances, these enhancement will become common and will be easy to complete. Go to [www.philips.com/support](http://www.philips.com/support) for software upgrade.

\*CONSUMERS SHOULD NOTE THAT NOT ALL HIGH DEFINITION TELEVISION SETS ARE FULLY COMPATIBLE WITH THIS PRODUCT AND MAY CAUSE ARTIFACTS TO BE DISPLAYED IN THE PICTURE. IN CASE OF 525 OR 625 PROGRESSIVE SCAN PICTURE PROBLEMS, IT IS RECOMMENDED THAT THE USER SWITCH THE CONNECTION TO THE 'STANDARD DEFINITION' OUTPUT. IF THERE ARE QUESTIONS REGARDING OUR TV SET COMPATIBILITY WITH THIS MODEL 525p AND 625p DVD PLAYER, PLEASE CONTACT OUR CUSTOMER SERVICE CENTER.\*

## Declaration of Conformity

Model number: HTS8100  
Trade Name: Philips  
Responsible Party: Philips Consumer Electronics  
A Division of Philips Electronics  
North America Corp.  
P. O. Box 671539  
Marietta, GA 30006-0026  
1-800-PHILIPS (744-5477)



Manufactured under license from Dolby Laboratories, Dolby, Pro Logic and the double-D symbol are trademarks of Dolby Laboratories.



Manufactured under license from one or more of the following DTS, Inc. U.S. Pat. No's: 5,451,942; 5,956,674; 5,974,380; 5,978,762; 6,226,616; 6,487,535 and other U.S. and world-wide patents issued and pending. "DTS" and "DTS Digital Surround" are registered trademarks of DTS, Inc. Copyright 1996, 2002-2006, DTS, Inc. All Rights Reserved.



DivX Ultra Certified products: DivX, DivX Ultra Certified, and associated logos are trademarks of DivX, Inc. and are used under license.



Windows Media and the Windows logo are trademarks, or registered trademarks of Microsoft Corporation in the United States and/or other countries.

## HDMI

HDMI, and HDMI logo and High-Definition Multimedia Interface are trademarks or registered trademarks of HDMI licensing LLC.



'DCDi' is a trademark of Faroudja, a division of Genesis Microchip, Inc.



iPod is a trademark of Apple Computer, Inc., registered in the U.S. and other countries.

English ----- 6

Français ----- 58

Español ----- 110

## Environmental information

All unnecessary packaging has been omitted. We have tried to make the packaging easy to separate into three materials: cardboard (box), polystyrene foam (buffer) and polyethylene (bags, protective foam sheet.) Your system consists of materials which can be recycled and reused if disassembled by a specialized company. Please observe the local regulations regarding the disposal of packaging materials, exhausted batteries and old equipment.

**NOTE:** This equipment has been tested and found to comply with the limits for a Class B digital device, pursuant to Part 15 of the FCC Rules. These limits are designed to provide reasonable protection against harmful interference in a residential installation. This equipment generates, uses and can radiate radio frequency energy and, if not installed and used in accordance with the instructions, may cause harmful interference to radio communications. However, there is no guarantee that interference will not occur in a particular installation.

If this equipment does cause harmful interference to radio or television reception, which can be determined by turning the equipment off and on, the user is encouraged to try to correct the interference by one or more of the following measures:

- Reorient or relocate the receiving antenna.
- Increase the separation between the equipment and receiver.
- Connect the equipment into an outlet on a circuit different from that to which the receiver is connected.
- Consult the dealer or an experienced radio/TV technician for help.

English

Français

Español

# Table of contents

## General

<b>General Information .....</b>	<b>8</b>
Setup precautions.....	8
Accessories supplied .....	8
Cleaning discs .....	8
About recycling.....	8

## Product Overview

<b>Main Unit .....</b>	<b>9</b>
<b>Remote Control.....</b>	<b>10-12</b>
Using the remote control .....	12

## Connections

<b>Basic Connections .....</b>	<b>13-18</b>
Step 1 : Placement .....	13
Step 2 : Connecting to TV .....	14
Option 1: Using the Video jack .....	14
Option 2: Connecting to a HDMI-compatible TV .....	14
Option 3: Connecting to a Progressive Scan TV or component video input .....	15
Option 4: Using an accessory RF modulator .....	15
Step 3 : Connecting the FM and AM/MW antennas.....	16
Step 4 : Connecting the subwoofer to the main unit.....	16
Step 5 : Connecting the power cord .....	17
<b>Optional Connections .....</b>	<b>18-19</b>
Connecting audio from TV .....	18
Connecting to cable box/satellite receiver and recorder/VCR .....	18
Mounting the Sound Bar system on the wall .....	19

## Basic Setup

<b>Getting Started .....</b>	<b>20-25</b>
Finding the correct viewing channel .....	20
Setting the speakers .....	20~21
Setting language preferences.....	22
On-screen display (OSD) language .....	22
Audio, Subtitle and Menu language for DVD playback.....	22-23
Setting the TV Display .....	23
Setting up Progressive Scan feature.....	24
Switching to different play source .....	25
Turning off to low power standby mode.....	25

## Disc Playback

<b>Disc Operations .....</b>	<b>26-33</b>
Playable discs .....	26
Playing a disc .....	26
Basic playback controls.....	27
Selecting various repeat/shuffle functions.....	27
Programming disc tracks .....	28
Other playback features for video discs (DVD/VCD/SVCD) .....	28~30
Using the Disc Menu .....	28
Viewing playback information.....	29
Zooming in/out.....	29

# Table of contents

English

Changing subtitle language .....	29
Switching camera angles.....	29
Changing sound track language.....	30
Setting the delay times for audio playback.....	30
Playback Control (VCD only).....	30
Playing a MP3/WMA disc .....	31
Playing a JPEG image file (slide show) .....	32
Preview function.....	32
Zoom picture .....	32
Rotating/flipping the picture .....	32
Playing MP3/WMA music and JPEG pictures simultaneously .....	33
Playing a DivX disc .....	33

## Playback other supported devices

<b>Playback - iPod .....</b>	<b>34</b>
Playing music from compatible iPod devices .....	34
<b>Playback - USB device.....</b>	<b>35</b>
Playing from USB flash drive or USB memory card reader.....	35
<b>Playback - Other Audio Player .....</b>	<b>36</b>
Playing from other portable audio player.....	36

## Setup Options

<b>Setup Menu Options.....</b>	<b>37-44</b>
Accessing the setup menu.....	37
General Setup Page.....	38
Audio Setup Page.....	39
Video Setup Page.....	40-42
Preference Setup Page .....	43-44

## Radio Tuning

<b>Radio Operations.....</b>	<b>45-46</b>
Tuning to radio stations.....	45
Presetting radio stations .....	45
Using auto install .....	45-46
Using automatic preset.....	46
Using manual preset .....	46
Selecting a preset radio station.....	46
Deleting a preset radio station.....	46

## Others

<b>Sound and Volume Controls .....</b>	<b>47</b>
Volume control .....	47
Adjusting the Bass/ Treble level .....	47
Selecting surround sound.....	47
Selecting digital sound effects .....	47
<b>Other Features.....</b>	<b>48</b>
Software upgrades .....	48
<b>Troubleshooting.....</b>	<b>49-51</b>
<b>Frequently Asked Questions (USB).....</b>	<b>52</b>
<b>Specifications .....</b>	<b>53</b>
<b>Glossary.....</b>	<b>54-55</b>
<b>Limited Warranty.....</b>	<b>56</b>

## General Information

### WARNING!

This unit does not contain any user-serviceable parts. Please leave all maintenance work to qualified personnel.

### Setup precautions

#### Finding a suitable location

- Place this unit on a flat, hard and stable surface. Never place the unit on a carpet.
- Never place this unit on top of other equipment that might heat it up (e.g., receiver or amplifier.)
- Never put anything under this unit (e.g., CDs, magazines.)
- Install this unit near the AC outlet where the AC power plug can be easily reached.

#### Space for ventilation

- Place this unit in a location with adequate ventilation to prevent internal heat build up. Allow at least 10 cm (4") clearance from the rear and the top of this unit and 5cm (2") from the left and right to prevent overheating.

#### Avoid high temperature, moisture, water and dust

- This unit must not be exposed to dripping or splashing.
- Never place any object or items that can damage this unit (e.g., liquid filled objects, lighted candles.)

### Accessories supplied

- 1 subwoofer
- 1 wall mounting bracket and 2 wall mounting knobs
- 1 remote control with batteries
- 1 composite video cable (yellow)
- 1 HDMI cable
- 1 FM wire antenna
- 1 AM/MW loop antenna
- 1 MP3 LINE-IN cable (for connecting portable audio player)
- 1 HTD7001 docking station for Apple iPod with accessories
  - interconnect cable (to main unit)
  - 3.5mm video cable (to TV)
  - 8x iPod dock adaptors (white)
- 1 micro fibre cleaning cloth
- Quick Start Guide

### Cleaning discs

To clean a disc, use a micro fiber cleaning cloth and wipe the disc from the center to the edge in a straight line.

### CAUTION!

Never use solvents such as benzene, thinner, commercially available cleaners, or anti-static sprays intended for discs.

### About recycling

These operating instructions have been printed on non-polluting paper. The electronic equipment contains a large number of materials that can be recycled. If you are disposing of an old machine, please take it to a recycling center. Please observe the local regulations regarding disposal of packaging materials, exhausted batteries and old equipment.



# Main Unit

English

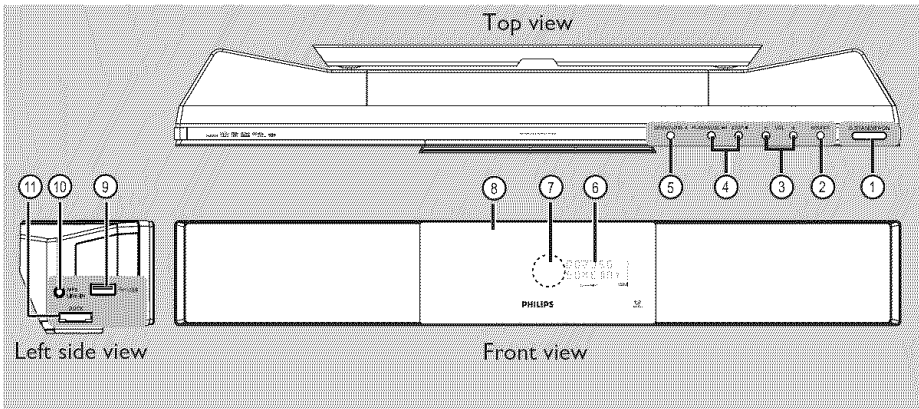

## ① **STANDBY ON**

- Turns on this unit or turns off to normal standby mode.
- Press and hold to turn off to low power standby mode.

## ② **SOURCE**

- Selects the relevant active source mode: DISC, USB, DOCK, MP3 LINE-IN, RADIO FM, RADIO AM/MW, TV, AUX1, AUX2 or DIGITAL IN.

## ③ **VOLUME** + -

- Adjusts the volume level.

## ④ **PLAY PAUSE**

- DISC: starts/pauses playback.
- RADIO: starts auto radio installation for first time setup.

## **STOP**

- Exits an operation.
- DISC: stops playback.
- RADIO: press and hold this button to erase the current preset radio station.

## ⑤ **OPEN/CLOSE**

- Opens/closes the disc compartment.

## ⑥ **Display panel**

## ⑦ **iR sensor**

- Point the remote control towards this sensor.

## ⑧ **Disc compartment**

## ⑨ **USB socket**

- Input for USB flash drive or USB memory card reader.

## ⑩ **MP3 LINE-IN jack**

- Phono input for connecting to the headphone out jack on your portable audio player.

## ⑪ **DOCK jack**

- Input for iPod docking station (model HTD7001).

# Remote Control

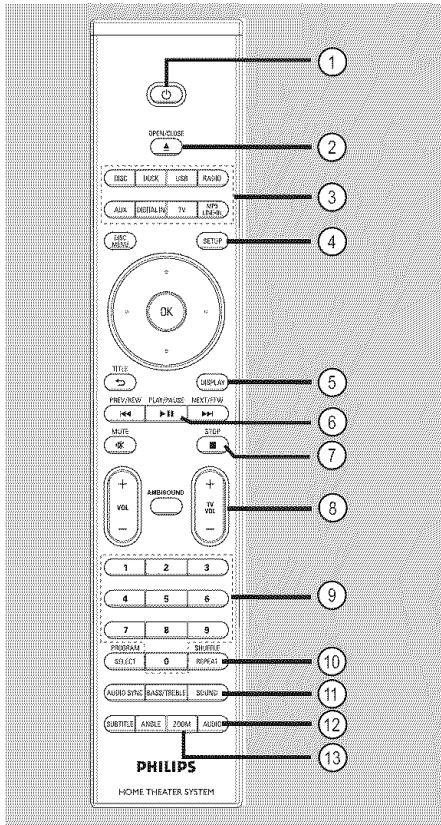

- ① **Power**
- Turns off to normal standby mode.
  - Press and hold to turn off to low power standby mode.
- ② **OPEN/CLOSE ▲**
- Opens/closes the disc compartment.
- ③ **Source buttons**
- **DISC:** switches to DISC mode.
  - **DOCK:** switches to the iPod that is connected to the docking station.
  - **USB:** switches to USB mode.
  - **RADIO:** toggles between FM and AM/MW band.
  - **AUX:** toggles between AUX1 and AUX2 external source mode.

**DIGITAL IN:** switches to the audio device that is connected to the DIGITAL IN jack.

**TV:** switches to TV mode. The sound from the TV will output through this unit's speaker system.

**MP3 LINE-IN:** switches to the audio device that is connected to the MP3 LINE-IN jack.

- ④ **SETUP**
- Enters or exits the system setup menu.
- ⑤ **DISPLAY**
- Displays the current status or disc information.
- ⑥ **PLAY/PAUSE ►||**
- **DISC:** starts/pauses playback.
  - **RADIO:** starts auto radio installation for first time setup.
- ⑦ **STOP ■**
- Exits an operation.
  - **DISC:** stops playback.
  - **RADIO:** press and hold this button to erase the current preset radio station.
- ⑧ **TV VOL + –**
- Adjusts the volume of the TV (for Philips TVs or compatible brands only.)
- ⑨ **Numeric keypad 0-9**
- Enters a track/title number of the disc.
  - Enters a number of a preset radio station.
- ⑩ **REPEAT/SHUFFLE**
- Selects various repeat or shuffle modes; turns off repeat or shuffle mode.
- ⑪ **SOUND**
- Selects a predefined sound effect.
- ⑫ **AUDIO**
- **DISC:** selects an audio language/channel.
  - **RADIO:** toggles between FM stereo and mono mode.
- ⑬ **ZOOM**
- Zoom in or out the picture on the TV.

## Remote Control (continued)

### 14 DISC MENU

- For DVD, enters or exits disc contents menu.
- For VCD/SVCD, enters digest menu while in stop mode; turns on/off PBC mode during playback.

### 15 OK

- Confirms an entry or selection.

### 16 Cursor keys

- DISC: selects movement direction in the menu.
- RADIO: press up or down to tune the radio frequency.
- RADIO: press left or right to start auto search.

### 17 TITLE ↵

- For DVD, go back to the previous menu.
- For VCD version 2.0 only; During playback, display the disc title menu or return to the main menu.

### 18 PREV / REW ◀◀, NEXT / FFW ▶▶

- DISC: skips to the previous or next title/ chapter/track.
- DISC: press and hold this button for fast forward and backward search.
- RADIO: selects a preset radio station.

### 19 MUTE

- Mutes or restores the volume.

### 20 VOL + -

- Adjusts the volume level.

### 21 AMBISOUND

- Switches the surround sound mode between Auto, Multi-Channel and Stereo mode.

### 22 SELECT/PROGRAM

- DISC: starts programming.
- RADIO: press and hold this button to start automatic/ manual preset programming.
- Make multiple selection in the menu.

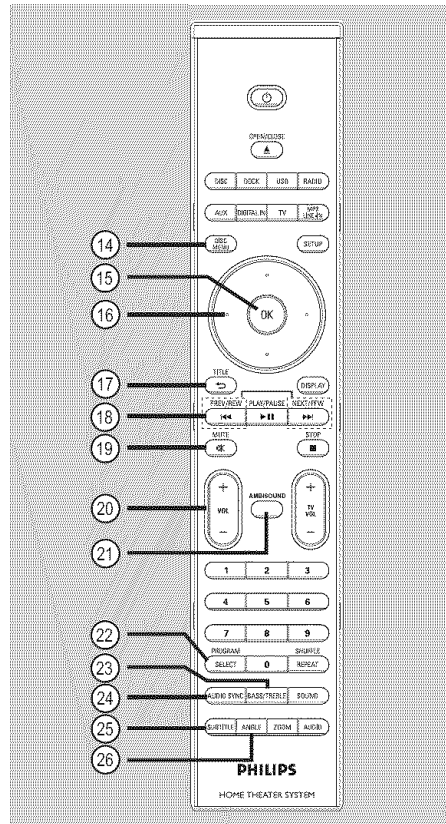

### 23 TREBLE / BASS

- Toggles between Treble and Bass mode. Immediately after toggling, adjust the volume control to change the level settings

### 24 AUDIO SYNC

- Sets the audio output delay times if the video playback is slower than the audio output.

### 25 SUBTITLE

- Selects a DVD subtitle language.

### 26 ANGLE

- Selects a different viewing angle of a DVD movie (if available.)

## Remote Control (continued)

English

### Using the remote control

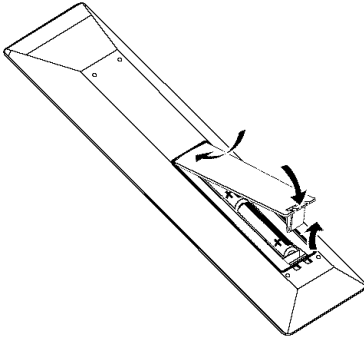

- ① Open the battery compartment.
- ② Insert two batteries type R06 or AA, following the indications (+ -) inside the compartment.
- ③ Close the cover.
- ④ Point the remote control directly at the remote sensor (iR) on the front panel.
- ⑤ Select the source you wish to control by pressing the DISC, DOCK, USB, RADIO, AUX, DIGITAL IN, TV or MP3 LINE-IN button on the remote control.
- ⑥ Then select the desired function (for example ◀◀, ▶▶.)

### CAUTION!

- Remove batteries if they are exhausted or if the remote control is not to be used for a long time.
- Never mix batteries (old and new or carbon and alkaline, etc.).
- Batteries contain chemical substances, they should be disposed of properly.

## Basic Connections

English

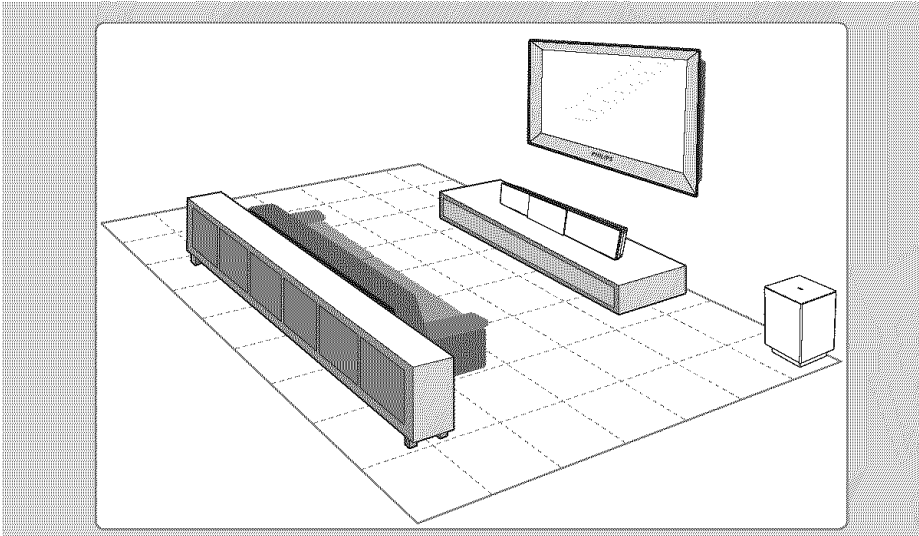

### Step 1: Placement

#### Note:

Never place the main unit in an enclosed cabinet.

#### Helpful Hints:

- For optimum performance, place the main unit on top of a table or mount it on the wall.
- For Sound Bar speaker setting, see 'Getting Started - Setting the speakers.'

- ① Place the main unit at a height that is closest to the listening ear-level.
- ② Position the main unit so that it is directly parallel to the listening area.

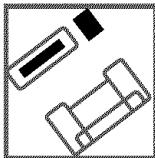
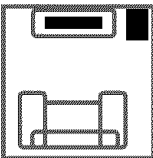

- ③ Place the subwoofer at the corner of the room or at least one meter away from the TV.

## Basic Connections (continued)

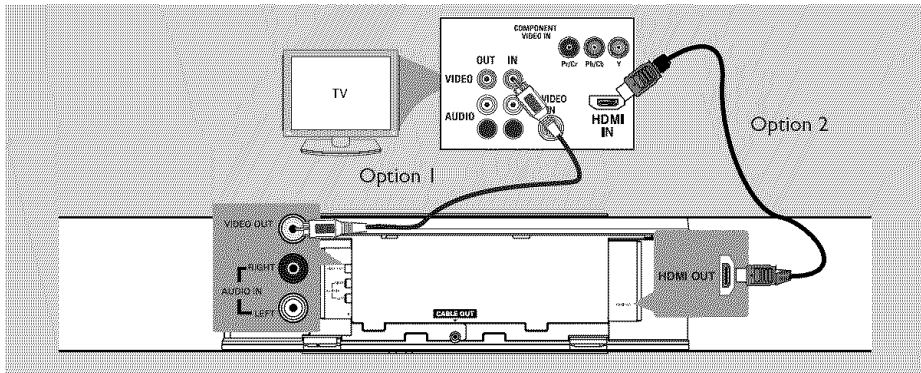

### Step 2: Connecting to TV

This connection enables you to view the video playback from this unit. You only need to choose **one** of the options below to make the video connection.

- For a standard TV, follow option 1.
- For a HDMI TV, follow option 2.
- For a progressive scan TV, follow option 3.
- For TV with only a single antenna input jack, follow option 4.

#### Before you start ...

Push up the catches to lift up the rear cover.

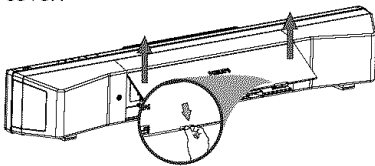

#### Helpful Hints:

- It is important to connect this unit directly to the TV in order to enjoy optimum video quality.
- To hear the TV channels through this unit, connect the AUDIO IN jacks to the corresponding AUDIO output jacks on the TV using an audio cable. Press TV on the remote control when watching the TV programs.

#### Option 1: Using the Video jack

- Use the supplied composite video cable (yellow) to connect the **VIDEO OUT** jack on the main unit to the video input jack (or labeled as A/V In, Video In, Composite or Baseband) on the TV.

#### Option 2: Connecting to a HDMI-compatible TV

HDMI (High Definition Multimedia Interface) is a digital interface that allows pure digital video transmission without the loss of image quality.

- ① Use the supplied HDMI cable to connect the **HDMI OUT** on the main unit to the HDMI IN on a HDMI-compatible device (e.g., HDMI TV, HDCP compliant DVI TV.)
- ② When you have completed the necessary connections, installation and set-up, see 'Audio Setup Page and Video Setup Page' for optimum HDMI audio and video settings.

#### Helpful Hint:

- The HDMI is backward compatible with some DVI devices using an appropriate adaptor plug.

## Basic Connections (continued)

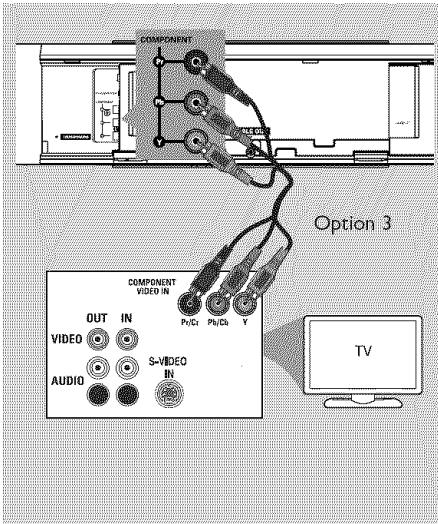

### Option 3: Connecting to a Progressive Scan TV or component video input

The progressive scan video quality is only available when using Y Pb Pr connection and a progressive scan TV is required. It provides superior picture quality when watching DVD movies.

- 1 Use the component video cables (red/blue/green - not supplied) to connect the **COMPONENT VIDEO OUT (Y Pb Pr)** jacks on the main unit to the corresponding component video input jacks (or labeled as Y Pb/Cb Pr/Cr or YUV) on the TV.
- 2 If your TV accepts progressive signals, proceed to chapter 'Getting Started - Setting up Progressive Scan feature' for detailed progressive feature setup.

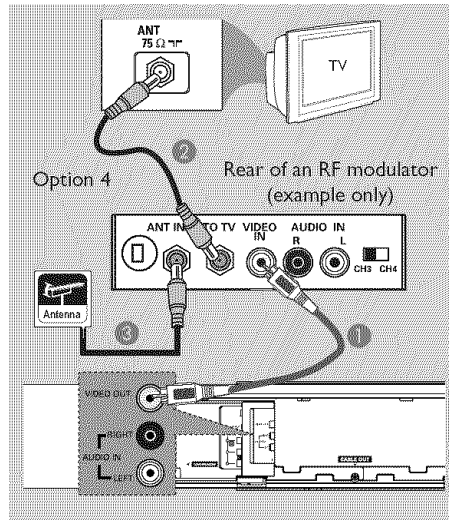

### Option 4: Using an accessory RF modulator

If your TV has only a single Antenna Input jack (labeled as 75 ohm or RF In.), you will need an RF modulator in order to view the DVD playback on the TV. See your electronics retailer or contact Philips for details about RF modulator availability and operations.

- 1 Use the supplied composite video cable (yellow) to connect the main unit's **VIDEO OUT** jack to the video input jack on the RF modulator.
- 2 Use an RF coaxial cable (not supplied) to connect ANTENNA OUT or TO TV jack on the RF modulator to the ANTENNA IN jack on the TV.
- 3 Connect the Antenna or Cable TV service signal to the ANTENNA IN or RF IN jack on the RF modulator. (It may have been connected to your TV previously. Disconnect it from the TV.)

## Basic Connections (continued)

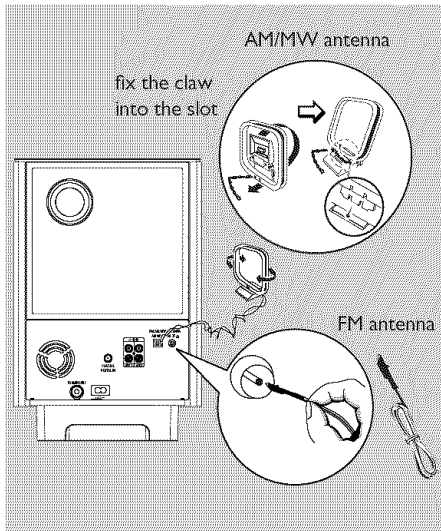

### Step 3: Connecting the FM and AM/MW antennas

#### **FM antenna**

- ① Connect the FM antenna (supplied) to the **FM 75 Ω** jack.
- ② Attach the other end of the FM antenna to a wall.

#### **AM/MW loop antenna**

- ① Stand the AM/MW loop antenna upright to fix its claw into the slot.
- ② Connect the AM/MW loop antenna to the **AM/MW** jack.
- ③ Place the AM/MW loop antenna on a shelf, or attach it to a stand or wall.

#### *Helpful Hints:*

- Adjust the position of the antennas for optimal reception.
- To avoid interference, position the antenna away from the electronic equipment.
- For better FM stereo reception, connect an external FM antenna (not supplied.)

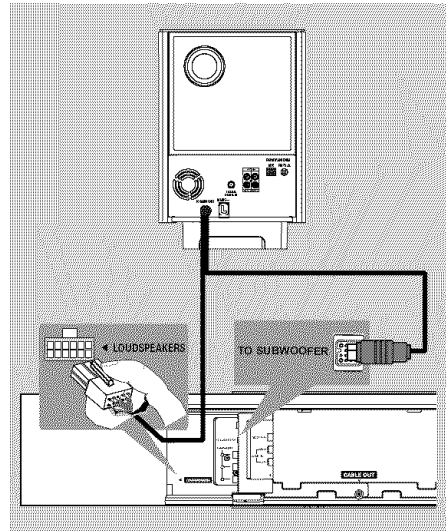

### Step 4: Connecting the subwoofer to the main unit

- ① Unwind the subwoofer's **TO MAIN UNIT** interconnect cable.
- ② Connect the white end of the interconnect cable to the **LOUDSPEAKERS** jack on the main unit.
- ③ Connect the black end of the interconnect cable to the **TO SUBWOOFER** jack on the main unit.



## Basic Connections (continued)

English

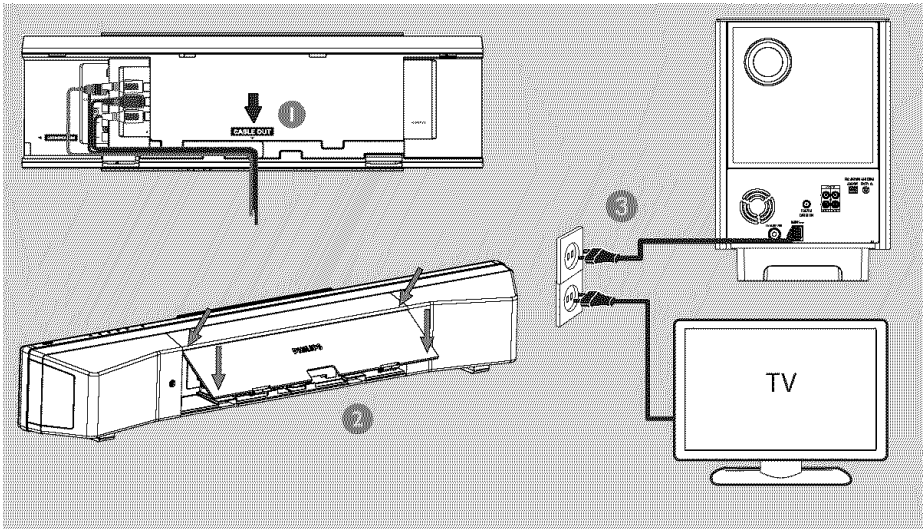

### Step 5: Connecting the power cord

#### Note:

For power supply rating, refer to the rear or bottom of the main unit.

- ① When all the connections are complete, direct all the cables to the CABLE OUT point.
- ② Close the rear cover.

#### Note:

All the cables must be placed properly inside the rear panel in order for the rear cover to close.

- ③ Connect the AC power cord from the subwoofer to the power outlet.  
→ The standby LED on the main unit lights up.

#### Helpful Hint:

– Before making or changing any connections, make sure that all the devices are disconnected from the power outlet.

## Optional Connections

English

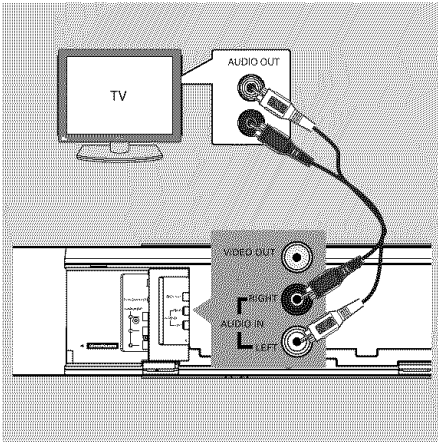

### Connecting audio from TV

When connecting the audio output from your TV to this Home Theater System, you can have the sound of the TV output on the speakers. It enables you to enjoy the multi-channel surround sound capabilities.

- Use an audio cable (red/white - not supplied) to connect the **AUDIO IN** jacks on the main unit to the **AUDIO OUT** jacks on the TV.

To listen to the sound, press **TV** on the remote control as the sound source that you want to listen to.

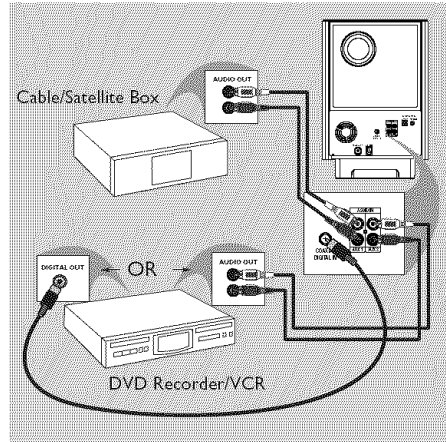

### Connecting to cable box/ satellite receiver and recorder/VCR

This unit provides analog and digital audio connection. You can connect the audio output from an audio/video device (e.g. DVD recorder, VCR, Cable/Satellite Box) to this Home Theater System in order to enjoy the multi-channel surround sound capabilities.

- Use an audio cable to connect the **AUDIO IN-AUX1** or **AUX2** jacks on the subwoofer to the **AUDIO OUT** jacks on the connected device.

To listen to the sound, press **AUX** to select 'AUX1' or 'AUX2' as the sound source that you want to listen to.

Or

- Use a coaxial cable (not supplied) to connect the **COAXIAL DIGITAL IN** jack on the subwoofer to the **DIGITAL OUT** output jack on the connected device.

To listen to the sound, press **DIGITAL IN** to select 'DIGITAL IN' as the sound source that you want to listen to.

## Optional Connections (continued)

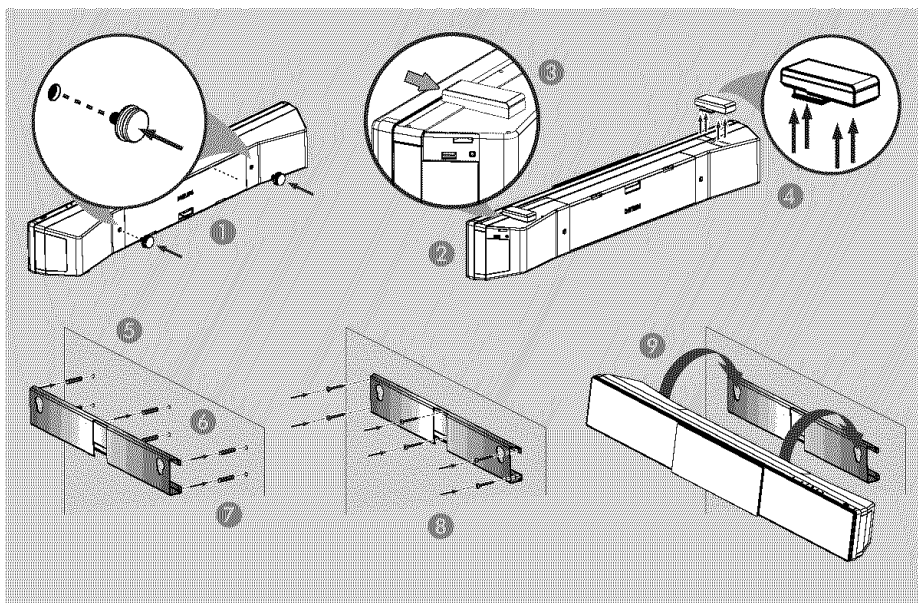

### Mounting the main unit

#### CAUTION!

**Risk of personal injury and damage to the unit. Allow only qualified persons to mount the unit.**

#### Before you start ...

Make sure that all cables have been connected to the main unit.

- ① Attach the supplied knobs to the rear of the main unit.
- ② Turn the main unit over so that the bottom of the main unit faces up.
- ③ While you hold the main unit firmly with one hand, grasp one of the rubber speaker feet and push it towards the back of the main unit.

- ④ Repeat step three to remove the other speaker foot.
- ⑤ Position and mark the supplied bracket where you intend to mount the main unit.
- ⑥ Drill the screw holes.
- ⑦ Insert the rubber wall plugs (not supplied) into the holes.
- ⑧ Secure the bracket onto the wall with the screws (not supplied.)
- ⑨ Hook the main unit firmly onto the mounted bracket. Slide the knobs through the bracket's key holes and lock into position.

#### Helpful Hint:

– To mount the main unit below your TV, leave at least 10cm (4 inches) of space between the TV and the bracket.

## Getting Started

### Finding the correct viewing channel

#### Before you start ...

Remove the door stop tag on top of the disc compartment door.

- ① Press **SOURCE** button on the main unit until 'DISC SOURCE' appears on the display panel (or **DISC** on the remote control.)
- ② Turn on the TV and switch it to the correct video-in channel.
  - You may go to the lowest channel on your TV, then press the Channel Down button on your TV's remote control until you see the Video In channel.
  - You may press  button repeatedly on your TV's remote control.
  - Usually this channel is between the lowest and highest channels and may be called FRONT, A/V IN, VIDEO, etc..
  - If you are using a RF modulator, set the TV to channel 3 or 4.
  - Refer to your TV's user manual on how to select the correct input on your TV.

#### The first screen appears on TV

When you complete the connections and turn on this unit to the 'DISC SOURCE' mode for the first time, you should see the welcome message on the TV.

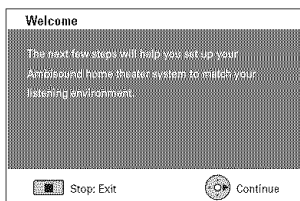

It is advisable that you make several basic settings to optimise the performance of this unit. See the following pages for more information.

### Setting the speakers

There are four parameters to adjust the speakers: room acoustics, placement, height and distance. Change the speaker settings according to your room environment and setup.

- ① Upon seeing the welcome message in 'DISC SOURCE' mode, press cursor right key on the remote control to access the speaker setup screen.
  - A message on the unit positioning appears.

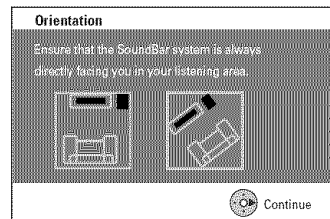

- ② Press cursor right key to continue.
  - { **Room Acoustics** } menu appears.

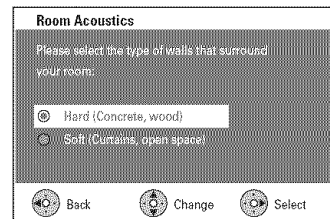

- ③ Select the condition of the room and press cursor right key to confirm.
  - { **Hard** } for concrete or wood surroundings.
  - { **Soft** } for curtains or an open space surroundings.

## Getting Started (continued)

English

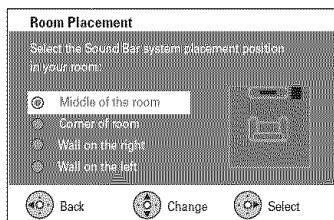

- ④ Select Sound Bar system placement position in the room and press cursor right key to confirm.

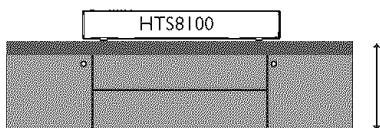
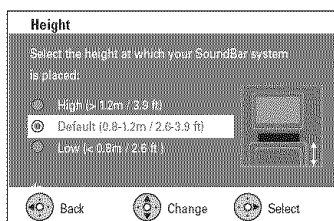

- ⑤ Select the height of which the Sound Bar system is placed and press cursor right key to confirm.
- { High } for height of less than 1.2 meters.
  - { Default } for height between 0.8 to 1.2 meters.
  - { Low } for height of more than 0.8 meters.

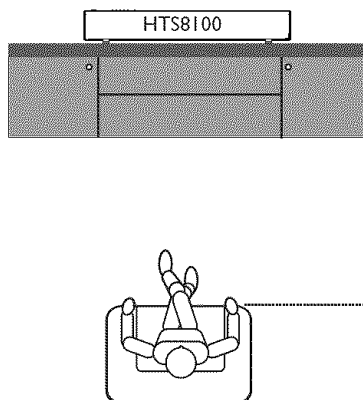
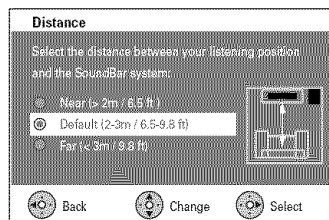

- ⑥ Select the distance between the listening position and the speakers, press cursor right key to confirm.
- { Near } for distance of less than 2.0 meters.
  - { Default } for distance between 2.0 to 3.0 meters.
  - { Far } for distance of more than 3.0 meters.
- ⑦ The speaker settings are now completed, press cursor right key to exit.

## Getting Started (continued)

### Setting language preferences

The language options are different depending on your country or region. It may not correspond to the illustrations shown in the user manual.

#### On-screen display (OSD) language

The OSD (On-Screen Display) language for this unit remains as you have set it, regardless of the changes made to the DVD disc language.

- 1 In disc mode, press **SETUP** on the remote control.  
→ { **General Setup Page** } appears.
- 2 Select { **OSD Language** } in the menu and press cursor right key.

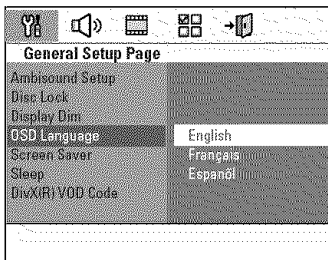

- 3 Select a language and press **OK** to confirm.

#### Audio, Subtitle and Menu language for DVD playback

You can select your preferred language settings for DVD playback. If the selected language is recorded on the DVD disc, this unit automatically plays the disc in that language. Otherwise, the disc's default language will be used instead.

- 1 Press **■** twice to stop playback (if any,) then press **SETUP**.
- 2 Press cursor right key repeatedly to select { **Preference Page** }.
- 3 Select one of the options below and press cursor right key.

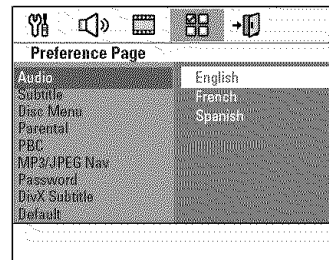

#### { Audio }

Select the preferred audio language for DVD playback.

#### { Subtitle }

Select the preferred subtitle language for DVD playback.

#### { Disc Menu }

Select the preferred disc menu language for DVD playback.

- 4 Select a language and press **OK** to confirm.

## Getting Started (continued)

If the language you want is not available in the list, select { **Others.** }

Use the numeric keypad **0-9** on the remote control to enter the 4-digit language code 'XXXX' (see last page) and press **OK** to confirm.

- ⑤ Repeat steps ③ ~ ④ for other settings.

### Helpful Hints:

– During DVD playback, you can switch the audio and subtitle languages by pressing the **AUDIO** and **SUBTITLE** buttons on the remote control. However, this does not change the default settings you have made here.

– For some DVDs, the subtitle/audio/menu language can only be changed via the DVD disc menu.

## Setting the TV Display

Set the aspect ratio of this unit according to the TV type you have connected. The format you select must be available on the disc. If it is not, the setting for TV display will not affect the picture during playback.

- ① In disc mode, press **SETUP** on the remote control.
- ② Press cursor right key repeatedly to select { **Video Setup Page.** }
- ③ Select { **TV Display** } in the menu and press cursor right key.

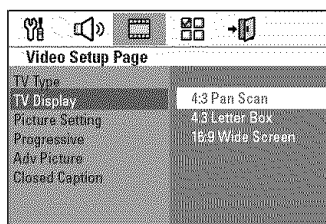

### { **4:3 Pan Scan** }

Select this if you have a conventional TV and want both sides of the picture to be trimmed or formatted to fit your TV.



### { **4:3 Letter Box** }

Select this if you have a conventional TV. In this case, a wide picture with black bands on the upper and lower portions of the TV will be displayed.



### { **16:9 Wide Screen** }

Select this if you have a wide-screen TV.



- ④ Select one of the options and press **OK** to confirm.

## Getting Started (continued)

### Setting up Progressive Scan feature

(for Progressive Scan TV only)

The progressive scan displays twice the number of frames per second than interlaced scanning (ordinary normal TV system.) With nearly double the number of lines, progressive scan offers higher picture resolution and quality.

#### Before you start...

Ensure that you have connected this unit to a progressive scan TV using the Y Pb Pr connection (see 'Option 3: Connecting to a Progressive Scan TV or component video input'.)

- ① Turn on the TV to the correct viewing channel for this unit.  
→ Make sure that the TV's progressive scan mode is turned off (or set to interlaced mode.) Refer to your TV's user manual.
- ② Turn on this unit and press **DISC** on the remote control.
- ③ Press **SETUP** on the remote control.
- ④ Press cursor right key repeatedly to select { **Video Setup Page.** }

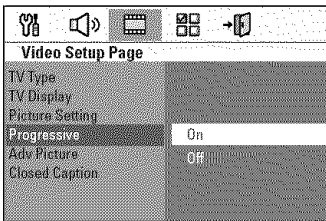

- ⑤ Move to { **Progressive** } > { **On** } in the menu and press **OK** to confirm.

- ⑥ Read the notification message on the TV and confirm your action by selecting the **OK** in the menu and press **OK**.

**There will be no picture on your TV at this state until you have turned on the progressive scan mode on your TV.**

- ⑦ Turn on your TV progressive scan mode, refer to your TV's user manual.  
→ A message appears on the TV.
- ⑧ Confirm your action by selecting the **OK** in the menu and press **OK**.  
→ The setup is now completed and you can start to enjoy the high quality picture.

#### If no picture is displayed

- ① Press **OPEN/CLOSE** **▲**.
- ② Press cursor left key on the remote control.
- ③ Press **AUDIO** on the remote control.

#### Helpful Hints:

- If a blank/distorted screen appears, wait for 15 seconds for the auto recovery.
- There are some progressive scan TVs that are not fully compatible with this unit, resulting in an unnatural picture when playing back a DVD VIDEO disc in the progressive scan mode. In such a case, turn off the progressive scan feature on this unit and your TV.



## Getting Started (continued)

### Switching to different play source

- Press the **SOURCE** button on the main unit repeatedly to select:  
DISC SOURCE → USB → DOCK  
→ MP3 LINE-IN → RADIO FM  
→ RADIO AM/MW → TV  
→ AUX1 → AUX2 → DIGITAL IN  
→ DISC SOURCE ....

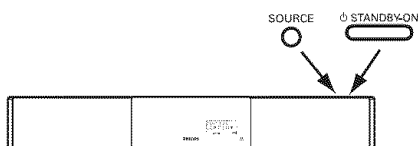

Or

- Press **DISC, DOCK, USB, RADIO, AUX, DIGITAL IN, TV, MP3 LINE-IN** on the remote control.
  - Press **DISC** for switching to disc mode.
  - Press **DOCK** for switching to the iPod player that is attached to the HTD7001 docking station.
  - Press **USB** for switching to USB device that is connected to this unit.
  - Press **RADIO** to toggle between FM and AM/MW band.
  - Press **AUX** for switching to the additional audio device that is connected to the AUDIO AUX1 or AUX2 jack on the subwoofer.
  - Press **DIGITAL IN** for switching to the additional audio device that is connected to the DIGITAL IN jack on the subwoofer.
  - If the audio input on this unit is connected to your TV, press **TV** to hear the TV's sound output through this unit.
  - Press **MP3 LINE-IN** for switching to the portable audio player that is connected to this unit.

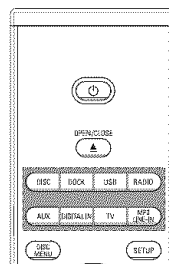

### Turning off to low power standby mode

- Press and hold **⏻**.  
→ The LEDs on the main unit turns red.

## Disc Operations

### Playable discs



### Your DVD home theater system plays:

- Digital Versatile Discs (DVDs)
- Video CDs (VCDs)
- Super Video CDs (SVCDs)
- Finalized DVD Recordable (DVD±R), DVD Rewritable (DVD±RW)
- Audio Compact Discs (CDs)
- MP3/ Windows Media™ Audio discs, picture (Kodak, JPEG) files on CD-R(W)
  - ISO 9660
  - JPEG resolution support up to 3072 x 2048
  - Supported sampling frequencies : 32 kHz, 44.1 kHz, 48 kHz
  - Supported Bit-rates : 32~256 (kbps), variable bit rates (average 128 kbps)
- DivX files on CD-R(W)/DVD±R(W):
  - DivX 3/4/5/6, DivX Ultra

### Region Codes for DVD discs

DVD discs and players are designed with regional restrictions. Before playing a disc, make sure the disc is for the same region as your player. The regional code for this unit is indicated at the rear panel.

### Notes:

- If the inhibit icon (Ø or X) appears on the TV when a button is pressed, it means the function is not available on the current disc or at the current time.
- Never put any objects other than discs on the disc tray. Doing so may cause the disc player to malfunction.

### Playing a disc

- ① Press **SOURCE** repeatedly until 'DISC SOURCE' appears on the display panel (or press **DISC** on the remote control.)
- ② Turn on the TV to the correct viewing channel for this unit.
  - ➔ The blue DVD background screen appears on the TV.
- ③ Press **OPEN/CLOSE** ▲ to open the disc compartment.
- ④ Insert a disc into the disc compartment and press **OPEN/CLOSE** ▲.
  - ➔ Make sure the disc label is facing towards you. For double-sided discs, load the side which you want to play facing up.
- ⑤ Playback starts automatically.
  - ➔ See the following pages for more playback options and features.

### Helpful Hints:

- If you are having trouble playing a certain disc, remove the disc and try a different one. Improperly formatted discs cannot be played on this unit.
- Some discs cannot be played on this player due to the configuration and characteristics of the disc, or due to the condition of recording and authoring software that was used.

## Disc Operations (continued)

### Basic playback controls

#### Pausing playback

- During playback, press **▶||**.
  - While in pause mode, you can press cursor left/right keys repeatedly to view the previous or next still picture (for video playback only.)
  - To resume playback, press **▶||** again.

#### Selecting another track/chapter

- Press **◀◀** / **▶▶** or use the **numeric keypad 0-9** to key in a track/chapter number.
  - If the repeat track mode is active, press **◀◀** again to replay the same track/chapter.

#### Searching backward/forward

- Press and hold **◀◀** / **▶▶**.
  - While searching, press **◀◀** / **▶▶** repeatedly to decrease/increase the search speed.
  - To resume normal playback, press **▶||**.

#### Stopping playback

- Press **■**.

#### Helpful Hints:

- If the message 'To playback from the beginning, press PREV key' appears on the TV while you load in a disc, you can press **◀◀** to playback from the beginning.
- This is a power-saving feature, this unit automatically switches to low power standby mode if you do not press any buttons within 30 minutes after a disc has stopped playing.

### Selecting various repeat/shuffle functions

The available of the repeat play options and shuffle play mode are vary depending on the disc type.

- While playing a disc, press **REPEAT/SHUFFLE** on the remote control repeatedly to choose a repeat/shuffle play mode.

#### DVD

- REPEAT CHAPTER
- REPEAT TITLE
- REPEAT DISC
- SHUFFLE
- SHUFFLE REPEAT
- REPEAT OFF (exit repeat mode)

#### VCD/SVCD/CD

- REPEAT TRACK
- REPEAT DISC
- SHUFFLE
- SHUFFLE REPEAT
- REPEAT OFF (exit repeat mode)

#### MP3/DivX/Windows Media™ Audio

- REPEAT TRACK
- REPEAT ALL / FOLDER
- SHUFFLE
- REPEAT OFF (exit repeat mode)

#### Helpful Hint:

- Repeat playback is not possible on VCDs when the PBC mode is turned on.

## Disc Operations (continued)

### Programming disc tracks

(not for Picture CD/MP3)

You can play the contents of the disc in the order you want by programming the playing order of the tracks.

- Press **SELECT/PROGRAM** on the remote control.  
→ The programming menu appears.

Program : Track (01 - 17)		
1	04	6
2	10	7
3	11	8
4	---	9
5	---	10
Exit Start Next		

- Use the **numeric keypad 0-9** to enter a valid track/chapter number.
- Use the cursor keys to move the cursor to the next position.
- If there are more than ten total program tracks, select { **Next** } on the screen and press **OK** (or press **▶▶** on the remote control) to access the next programming page.
- To remove the track/chapter from the programming menu, select the track/chapter and press **OK**.
- Once complete, select { **Start** } on the screen and press **OK** to start playback.  
→ Playback starts from the selected track under the programmed sequence.
- To exit the program menu, select { **Exit** } in the menu and press **OK**.

### Other playback features for video discs (DVD/VCD/SVCD)

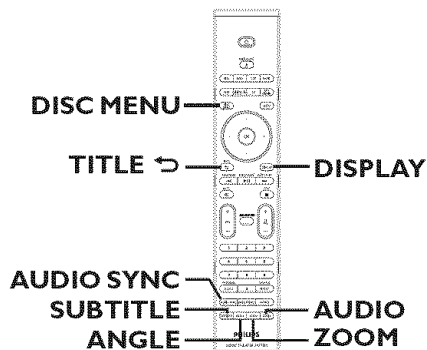

#### Note:

The operating features described here might not be possible for certain discs. Always refer to the instructions supplied with the discs.

#### Using the Disc Menu

Depending on the disc format, a menu may appear on the TV screen once you load the disc.

#### To select a playback feature or item

- Use the cursor keys or **numeric keypad 0-9** on the remote control, then press **OK** to start playback.

#### To access or remove the menu

- Press **DISC MENU** on the remote control.

## Disc Operations (continued)

### Viewing playback information

This unit can display the disc playback information (for example, title or chapter number, elapsed playing time, audio/subtitle language) and a number of operations can be done without interrupting disc playback.

- 1 During playback, press **DISPLAY**.  
→ A list of available disc information appears on the TV.

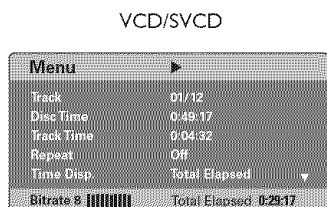
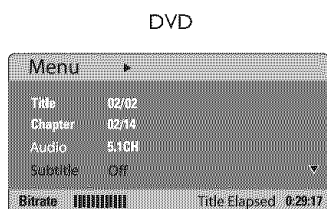

- 2 Use cursor up/down keys to view the information and press **OK** to access.
- 3 Use the **numeric keypad 0-9** to input the number/time or use cursor up/down keys to make the selection.
- 4 Press **OK** to confirm.  
→ Playback changes according to the chosen time or to the selected title/chapter/track.

### Zooming in/out

This option allows you to zoom in or out the picture on the TV and to pan through the picture.

- 1 During playback, press **ZOOM** repeatedly to select a different zoom factor.  
→ Playback continues.
- 2 Use the cursor keys to pan through the zoomed image.
- 3 Press **ZOOM** repeatedly to return to the original size.

### Changing subtitle language

This operation works only on DVDs with multiple subtitle languages. You can change the language you want while playing a DVD.

- Press **SUBTITLE** repeatedly to select different subtitle languages.

### Switching camera angles

This option is only available on DVDs that contain sequences recorded from different camera angles. This allows you to view the picture from different angles.

- If the camera icon appears on the TV, press **ANGLE** repeatedly to select the available camera angles.

## Disc Operations (continued)

### Changing sound track language

This operation works only on DVDs with multiple sound track languages, or VCDs with multiple audio channels.

- Press **AUDIO** repeatedly to select the available audio languages.

### For VCD – changing the audio channel

- Press **AUDIO** repeatedly to select the available audio channels provided by the disc (STEREO, MONO LEFT, MONO RIGHT or MIX MONO.)

### Setting the delay times for audio playback

This feature allows you to adjust the audio delay times if the video playback is slower than the audio output streams, hence resulting in 'Lip-sync.' The only way to correct 'Lip-sync' error caused by delayed video is to delay audio by an equal amount.

- ① Press **AUDIO SYNC**.
- ② Within five seconds, use the **VOL + -** to set the audio output delay times (0 ~ 150 ms).  
→ If the volume control is not used within five seconds, it resumes normal volume control function.

### Playback Control (VCD only)

Playback Control (PBC) playback allows you to play Video CDs interactively, following the menu on the display. This function can also be accessed via the 'Preference Page' menu.

### For VCDs with Playback Control (PBC) feature (version 2.0 only)

- During playback, press **TITLE** ⇨ to return to the disc title menu or main menu.
- During playback, press **DISC MENU** to turn on or off the PBC mode.

## Disc Operations (continued)

### Playing a MP3/WMA disc

This unit can playback most of the MP3 and Windows Media™ Audio files recorded on a recordable disc or commercial CD.

#### Before you start ...

Turn on your TV to the correct Video In channel. See 'Finding the correct viewing channel' for details.

- 1 Insert a MP3/WMA disc.
  - The disc reading time may exceed 30 seconds due to the complexity of the directory/file configuration.
  - The disc menu appears on the TV.

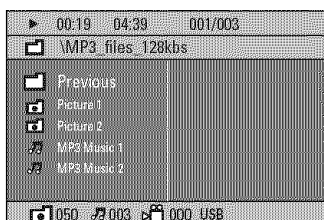

- 2 If the disc main menu contains various folders, use cursor up/down keys to select a desired folder and press **OK** to open the folder.
- 3 Use cursor up/down keys to select a track/file and press **OK** to start playback.
  - Playback starts from the selected file and continues through to the end of the folder.

During playback;

- Press **◀◀ / ▶▶** to playback another track/file in the current folder.
- Press and hold **◀◀ / ▶▶** to fast reverse/forward search for a music track.
- To select another folder from the current disc, press cursor up key to return to the root menu.
- Press **REPEAT/SHUFFLE** repeatedly to access various play modes.
- 4 To stop playback, press **■**.

Helpful Hints:

- To skip the folders menu when you load a MP3/JPEG disc, set the MP3/JPEG NAV setting in the Preference Setup Page to { Without Menu. }
- Only the first session of a multi-session CD will be played back.
- It is normal to experience an occasional "skip" while listening to your MP3/WMA disc due to poor clarity of digital contents during internet downloading.
- If any special characters are present in the MP3/WMA track name (ID3) or album name, it might not be displayed correctly on the screen because this unit does not support the characters.

## Disc Operations (continued)

### Playing a JPEG image file (slide show)

#### Before you start ...

Turn on your TV to the correct Video In channel. See 'Finding the correct viewing channel' for details.

- Insert a JPEG photo CD (Kodak Picture CD, JPEG.)
  - For a Kodak disc, the slide show begins automatically.
  - For a JPEG disc, the picture menu appears on the TV. Press **▶||** to start the slide-show playback.

#### Helpful Hint:

– It may require longer time for this unit to display the disc content on the TV due to the large number of songs/pictures compiled into one disc.

#### Supported file format:

- The file extension has to be '\*.JPG' and not '\*.JPEG'.
- This unit can only display digital camera pictures according to the JPEG-EXIF format, typically used by almost all digital cameras. It cannot display Motion JPEG, progressive JPEG and other JPEG formats, or pictures in formats other than JPEG, or sound clips associated with pictures.

#### Preview function

- ① During playback, press **■**.
  - 12 thumbnail pictures will be displayed on the TV.

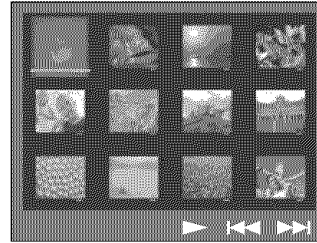

- ② Press **◀◀ / ▶▶** to display the other pictures on the previous/next page.
- ③ Use the cursor keys to select one of the pictures and press **OK** to start playback.
- ④ Press **DISC MENU** to return to Picture CD menu.

#### Zoom picture

- ① During playback, press **ZOOM** repeatedly to select a different zoom factor.
- ② Use the cursor keys to pan through the zoomed image.

#### Rotating/flipping the picture

- During playback, use the cursor keys to rotate/flip the picture on the TV.
  - cursor up: flip the picture vertically.
  - cursor down: flip the picture horizontally.
  - cursor left: rotate the picture anti-clockwise.
  - cursor right: rotate the picture clockwise.



## Disc Operations (continued)

### Playing MP3/WMA music and JPEG pictures simultaneously

You can create a musical slide show if the disc contains both the MP3/WMA music and JPEG picture files.

- ① Insert a MP3/WMA disc that contains music and picture folders.
- ② Select a track in the menu and press ►|| to start playback.
- ③ During music playback, use the cursor keys to select a picture folder from the disc menu and press ►||.
  - ➔ The picture files will be played back through to the end of the folder.
  - ➔ The music keeps playing back and will be repeated if reaches the end of the selected album, playlist or track.
- ④ To stop simultaneous playback, press **DISC MENU** followed by ■.

### Playing a DivX disc

This unit supports the playback of DivX movies which you can copy from your computer onto a recordable disc. See 'Setup Menu Options - { General Setup Page - DivX(R) VOD code }' for details.

- ① Insert a DivX disc.
- ② Use the cursor keys to navigate to the title you want to play.
- ③ Press ►|| to start playback.

During playback;

- If the DivX disc has multilingual subtitles, you can press **SUBTITLE** on the remote control to change the subtitle language.
- If the DivX title has different audio tracks, you can press **AUDIO** on the remote control to change the audio stream.
- Use the cursor left/right keys on the remote control to perform fast reverse/forward search.
- For DivX Ultra disc only, press **DISPLAY** to view the video information.

#### Helpful Hints:

- Subtitle files with the following file name extensions (.srt, .smi, .sub, .ssa, .ass) are supported but do not appear on the file navigation menu.
- The subtitle file name has to be the same as the file name of the movie.
- The subtitle can only be displayed up to an average of 45 characters.

## Playback - iPod

### Playing music from compatible iPod devices

Music on your Apple iPod can be played on this unit with the support of Philips HTD7001 docking station. It enables you to enjoy the superior sound output from the speaker system.

**Philips HTD7001 docking station supports the following iPod range:**

60/80GB (video)
40/60GB (color display)
30GB (video)
20/30GB (color display)
Nano
40GB
20GB
MINI 4GB

#### Before you start ...

Prepare the Philips HTD7001 docking station by attaching the matching dock adaptor to the correct docking cradle. Refer to the Docking Station's user manual for more information.

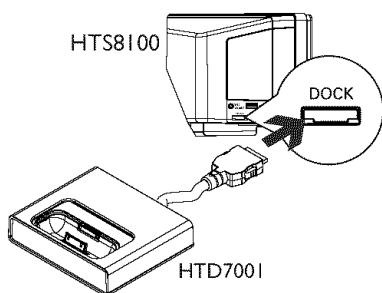

- ❶ Connect the docking station to the **DOCK** socket on this unit (as shown in the above illustration.)
- ❷ Turn on your iPod before dock it into the correct cradle.

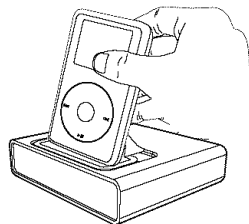

- ❸ Press **DOCK** on the remote control to switch this unit to DOCK mode.
  - ➔ The display panel shows 'IPOD DOCKED' if the device is detected and supported.
- ❹ Start playback on your iPod.
  - Controlling of playback is on the iPod device by default, it is called 'Simple Control mode.' However, you can use the remote control of this unit to control simple playback functions such as PLAY, PAUSE, OK, STOP, NEXT/FFW, and PREV/REW.
  - For iPod music playback only, press **DISPLAY** on the remote control to toggle between 'Simple Control mode' and 'Extended Control mode.'

#### 'Extended Control Mode'

*available for iPod music playback only*

- While in this mode, the control keys on the iPod have no function. You can view the music contents on the TV and use the remote control of this unit to control and navigate the music playlists/content.

#### Helpful Hints:

- The Philips HTD7001 docking station is specially designed for use with this unit. Never try it on other device.
- Photo and video playback from iPod compatible device is possible if you connect the video output from the docking station to your TV. Controlling of playback is only possible on the iPod.
- Whenever this unit is powered up and the docking station is connected to it, the battery of the docked iPod will be charged automatically.

## Playback - USB Device

### Playing from USB flash drive or USB memory card reader

You can play or view the data files (JPEG, MP3, Windows Media™ Audio or DivX) in the USB flash drive or USB memory card reader. However, editing or copying the data file is not possible.

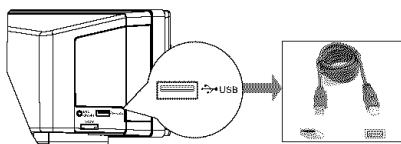

- 1 Connect the USB flash drive / USB memory card reader directly to the **USB** jack on this unit.
- 2 A message appears on the TV for 5 (five) seconds when the device is detected.



- 3 Press **USB** on the remote control to access the data in the drive.
  - ➔ When using multiple drives on a single card reader, only one of the connected cards can be accessed.
  - ➔ The device numbers may vary from different card readers.

- 4 Select the file to play and press **▶||**.
- For more playback information, see 'Playing a MP3/WMA disc,' 'Playing a JPEG image file (slideshow)' or 'Playing a DivX disc' for details.
- 5 Before removing the USB device, press **■** to stop playback or press **DISC** to switch to disc mode.

#### Helpful Hints:

- The USB jack does not support the connection of other USB devices except to a USB flash drive / USB memory card reader.
- When the USB device does not fit into the USB jack, a USB extension cable is required.
- You can only read and playback the content from the USB device.
- Copy-protected contents are not playable.

## Playback - Other Audio Player

### Playing from other portable audio player

When you connect your portable audio player to this unit to get the best immersion sound experience through the speaker system. However, controlling of playback is only possible on the portable audio player.

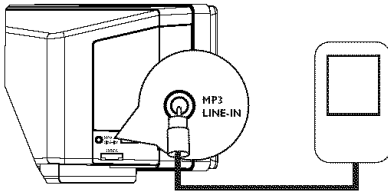

- ① Use the supplied MP3 LINE-IN cable to connect between the 'headphone' output jack on your portable audio player and the **MP3 LINE-IN** jack on this unit.
- ② Press **MP3 LINE-IN** on the remote control.
- ③ Start playback on your portable audio player.  
→ The music will be heard through the speakers.
- ④ To stop playback, press the **STOP** button on the portable audio player.

*Helpful Hint:*

– If you change the input source by pressing any of the source buttons (e.g. *DISC*, *USB*, *RADIO*), press the **STOP** button on the portable audio player to stop its playback.

# Setup Menu Options

## Accessing the setup menu

This system setup is carried out via the TV, enabling you to customize this unit to suit your particular requirements.

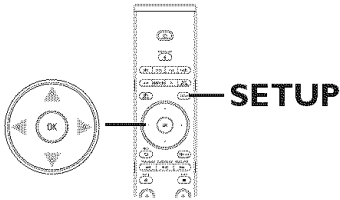

- ① In disc mode, press **SETUP** on the remote control.  
→ The setup menu appears.
- ② Use cursor left/right keys to select one of the setup menu options and press **OK**.

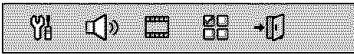

- If you are not able to access the { Preference Page, } press **SETUP** to exit the menu. Then, press **■** twice before you press the **SETUP** again.
- ③ Use cursor up/down keys to select a setup option and press cursor right key to access.
- ④ Select the setting you wish to change and press **OK** to confirm and go back to the previously selected item.  
→ Instructions and explanations of the options are provided in the following pages.  
→ If the option in the menu is grayed out, that means the setting is not available or cannot be changed in the current state.
- ⑤ To exit, press **SETUP**.

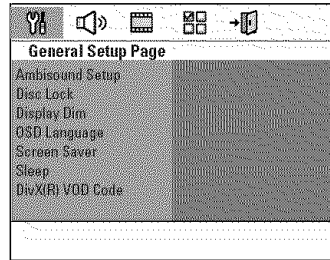

see page 38

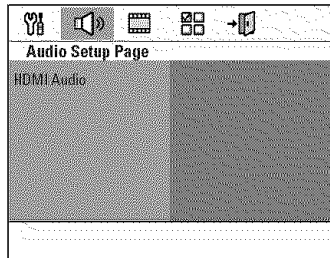

see page 39

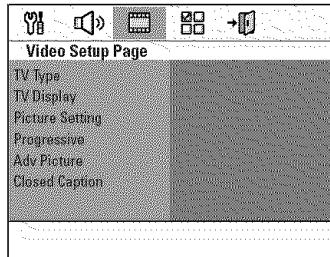

see pages 40-42

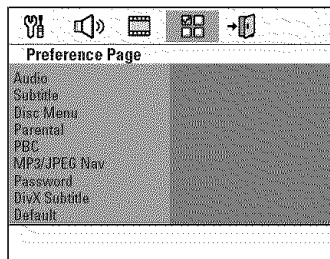

see pages 43-44

## Setup Menu Options (continued)

### General Setup Page (underlined options are the factory default settings)

#### Ambisound Setup

Access the speaker setup options.

- { **Room Acoustics** } – Select the type of walls that surround your room.
- { **Room Placement** } – Select the placement position.
- { **Height** } – Select the height where it is placed.
- { **Distance** } – Select the distance from the listening position.
- { **Setup Guide** } – Start automatic speaker setup guide. See 'Setting the speakers' for details.

#### Disc Lock

Not all discs are rated or coded by the disc maker. You can prevent play of specific discs with the disc lock function. Up to 40 discs can be locked.

- { **Lock** } – To block the playback of the current disc. Subsequent access to a locked disc requires a four-digit password. The default password is '0000' (see { Preference Setup Page - Password }.)
- { **Unlock** } – All discs can be played.

#### Display Dim

Select the brightness of this unit's display panel.

- { **100%** } – Full brightness.
- { **70%** } – Medium brightness.
- { **40%** } – Dimmest display. This switches off all LEDs and icons on the front display panel of this unit.

#### OSD Language

Select the menu language for this unit's on-screen display.

#### Screen Saver

The screen saver prevents damage to the TV screen by avoiding exposure to a static image for too long.

- { **On** } – Switch to TV screen saver mode when playback has been stopped or paused for more than 15 minutes.
- { **Off** } – Turn off the screen saver function.

#### Sleep

The sleep timer enables the unit to switch to standby mode automatically after the selected preset time.

- { **15/30/45/60 mins** } – Select the preset minutes for switching the unit to standby mode automatically.
- { **Off** } – Turn off the sleep mode function.

#### DivX(R) VOD Code

Philips provides you with the DivX® VOD (Video On Demand) registration code that allows you to rent or purchase videos from DivX® VOD service at [www.divx.com/vod](http://www.divx.com/vod). All the downloaded videos from DivX® VOD can only be played back on this unit.

Press cursor right key to see the registration code and press **OK** to exit.

## Setup Menu Options (continued)

---

---

### Audio Setup Page (underlined options are the factory default settings)

---

---

#### HDMI Audio

This setting is only required if you are using the HDMI OUT jack to connect your TV or other display device (see 'Option2: Connecting to a HDMI-compatible TV'.)

#### { Digital Audio }

##### { Off }

Turn off the HDMI audio output. You can still enjoy sound output via the speaker system.

##### { All }

The HDMI audio output will be same as the audio stream being played back. In the case when the playback audio format is not supported, the audio output will be changed to PCM automatically.

##### { PCM only }

Downmix the audio signals to linear-PCM (2-channel).

#### Notes:

- It may take a while for this unit and the input device to communicate and initialize.
- It is not possible to listen to SACDs or copy-controlled DVD-Audio CPPM (Content Protection for Playable Media) sources using the HDMI connection.

## Setup Menu Options (continued)

### Video Setup Page (underlined options are the factory default settings)

#### TV Type

Select the color system that matches the connected TV. It enables playback of a different type of disc (PAL or NTSC disc) on this unit.

- { NTSC } – For NTSC-system TV.
- { Multi } – For TV that is compatible with both PAL and NTSC.

#### TV Display

The picture shape can be adjusted to fit your TV.

{ 4:3 Pan Scan } – For a full-height picture with the sides trimmed.



{ 4:3 Letter Box } – For a 'wide-screen' display with black bars on the top and bottom.



{ 16:9 Wide Screen } – For wide-screen TV (frame ratio 16:9.)



#### Picture Setting

This unit provides three predefined sets of picture color settings and one personal setting which you can define yourself.

- { Standard } – Original color setting.
- { Bright } – Vibrant color setting.
- { Soft } – Warm color setting.
- { Personal } – Select this to personalize the picture color setting. Use the cursor left/right keys to adjust to the setting that best suits your personal preference and press **OK** to confirm. For an average setting, select { 0. }



#### Progressive

Before enabling the progressive scan feature, you must ensure that your TV can accept progressive signals (a progressive scan TV is required) and that you have connected this unit to your TV using the Y Pb Pr. See 'Getting Started - Setting up the progressive scan feature' for details.

- { On } – Turn on progressive scan mode.  
Read the instructions on the TV and confirm your action by pressing **OK** on the remote control.
- { Off } – Turn off the progressive scan mode.



## Setup Menu Options (continued)

### Video Setup Page (underlined options are the factory default settings)

#### Adv Picture

It provides the picture settings to enhance the appearance and picture quality for disc playback.

**Note:** { DCDi }, { True Life } and { P-Scan Format } settings are only applicable for Progressive Scan output.

- { **DCDi** } – Directional Correlation Deinterlacing. It is known by its smooth video content as it fills the missing lines.  
{ **On** }  
Optimise the picture quality significantly, especially during the slow motion play.  
{ **Off** }  
Turn off the DCDi function.
- { **Gamma** } – Adjust the intensity of the picture non-linearly (-7 to +7). A positive value enables you to bring out low level detail in dark scenes, while a negative value emphasizes contrast.
- { **Chroma Delay** } – Adjust the advance delay of chroma signal to produce a perfect clear picture (-3 to +3.)
- { **True Life** } – Increase the contrast and colour intensity to produce a more dynamic picture (00 to 05.)
- { **HDMI Video** } – Select a suitable video resolution depending on the capability of the connected TV/device to further enhance the HDMI video output.  
{ **480p** }  
Progressive output in 480 lines for NTSC TV.  
{ **576p** }  
Progressive output in 576 lines for PAL TV.  
{ **720p** } - (if a HDMI TV is connected)  
Progressive output upscale to 720 lines.  
{ **1080i** } - (if a HDMI TV is connected)  
Interlaced output upscale to 1080 lines.  
{ **1080p** } - (if a HDMI TV is connected)  
Progressive output upscale to 1080 lines.  
{ **Auto** }  
The video output automatically follows the display's supported resolution.
- Note:** If no display appears on the TV due to unsupported resolution, use the Composite Video cable to connect this unit and your TV. Turn on your TV to the correct video input channel and adjust the resolution setting to 480p/576p.

## Setup Menu Options (continued)

### Video Setup Page (underlined options are the factory default settings)

#### Adv Picture

continued ...

{ **P-Scan Format** } – Select a suitable TV screen display format.

**Note:** This feature is only available if you have selected the { **16:9 Wide Screen** } in { **TV Display** } setup option.

{ **Superwide** } Display the 4:3 picture disc on the wide-screen TV with non-linear stretching (center position of the screen is stretched less than the side.)

{ **4:3 Pillar Box** }

Display the 4:3 picture disc on the wide-screen TV without stretching. Black bars will be shown on the both sides of the TV screen.

{ **Off** }

No aspect ratio adjustment is made when this option is selected.

**Note:** The { **Superwide** } is only applicable for resolution: 720p, 1080i or 1080p.

#### Closed Caption

This feature is only available if the disc contains of special video signal data. It shows sound effects on the screen if your TV supports this feature, such as 'phone ringing' and 'footsteps.'

{ **On** }

– Turn on closed caption feature.

{ **Off** }

– Turn off closed caption feature.

## Setup Menu Options (continued)

### **Preference Setup Page** (underlined options are the factory default settings)

#### **Audio**

Select the preferred audio language for DVDs with multiple sound tracks or VCDs with multiple audio channels.

#### **Subtitle**

Select the preferred subtitle language for DVD playback.

#### **Disc Menu**

Select the preferred disc menu language for DVD playback.

**Note:** If the selected audio/subtitle/disc menu language is not available on the DVD, the disc's default language will be used instead.

#### **Parental**

This is to prohibit viewing of discs that had exceeded the limits you set. It works only on the DVDs with parental level assigned to the complete disc or to certain scenes on the disc.

- 1) Use cursor up/down keys to select a rating level from 1 to 8 and press **OK**.
- 2) Use the **numeric keypad 0-9** on the remote control to enter your four-digit password.

#### **Notes:**

- The ratings are country-dependent ('1' is considered material that is least offensive and '8' is most offensive.) To disable parental controls and allow all discs to play, select '8'.
- Some DVDs are not encoded with a rating though the movie rating may be printed on the disc cover. The rating level feature does not prohibit playback of such discs. VCD, SVCD and CD have no level indication, so parental control has no effect on these type of discs.
- DVDs that are rated higher than the level you selected will not be played unless you enter the same four-digit password.

#### **PBC**

Play Back Control feature is applicable for VCD/SVCD only. It allows you to play Video CDs (2.0) interactively, following the menu on the display.

- { **On** } – The index menu (if available) appears on the TV when you load a VCD/SVCD.
- { **Off** } – The VCD/SVCD skips the index menu and playback directly from the beginning.

#### **MP3/JPEG Nav**

MP3/JPEG Navigator can only be set if the disc is recorded with a menu. It allows you to select different display menus for easy navigation.

- { **Without Menu** } – Display all the files contained in the MP3/Picture disc.
- { **With Menu** } – Display the folder menu of the MP3/Picture disc.

**Note:** This unit can only display 650 files/folder in the directory.

## Setup Menu Options (continued)

### Preference Setup Page (underlined options are the factory default settings)

#### Password

The password is used for the Disc Lock and Parental. The default password is '0000.' To change the password:

1) Press **OK** to access the change password menu.

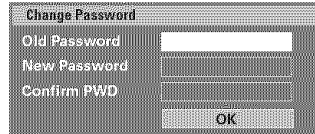

The image shows a 'Change Password' dialog box with three input fields: 'Old Password', 'New Password', and 'Confirm PWD'. Each field has a small cursor icon on the right. Below the fields is an 'OK' button.

2) Use the **numeric keypad 0-9** on the remote control to enter your existing four-digit password at { Old Password. }

**Note:** When doing this for the first time or if you forget your existing password, key in '0000.'

3) Enter the new four-digit password at { New Password. }

4) Enter the new four-digit password again at { Confirm PWD. }

5) Press **OK** to confirm and exit the menu.

#### DivX Subtitle

Select the font type that supports the recorded DivX subtitle.  
{ **Standard** } – Display a standard list of Roman subtitle fonts provided by this unit.

#### Default

This feature enables you to reset all the setup menu options and your personal settings to the factory defaults, except your password for the Disc Lock and Parental.

Press **OK** to confirm the default reset.



## Radio Operations (continued)

- ② Press **▶||**.
  - ➔ This unit starts searching from the FM band followed by the AM band.
  - ➔ All the available radio stations with strong signal will be stored automatically.
  - ➔ Once complete, the first tuned radio station will be played back.

### Using automatic preset

Use automatic presetting to store or reinstall all the preset radio stations.

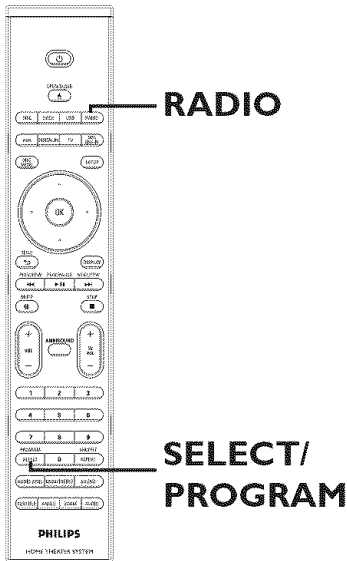

- ① Press **RADIO** to select 'FM' or 'AM' band.
- ② Press and hold **SELECT/PROGRAM** until 'INSTALLN IN PROG' appears on the display panel.
  - ➔ All previously stored radio stations will be replaced.

### Using manual preset

Use manual presetting to store your favorite radio stations.

- ① Tune to your desired radio station (see 'Tuning to radio stations'.)
- ② Press **SELECT/PROGRAM**.
- ③ Use **◀◀/ ▶▶** keys to select a preset number that you want to store the current radio station.
- ④ Press **SELECT/PROGRAM** to store.

### Selecting a preset radio station

- ① Press **RADIO** to select 'FM' or 'AM' band.
- ② Use **◀◀/ ▶▶** keys to select a preset number (or use the numeric keypad on the remote control).
  - ➔ The waveband, preset number followed by the radio frequency appear on the display panel.

### Deleting a preset radio station

- ① In radio mode, use **◀◀/ ▶▶** keys to select a preset radio station.
- ② Press and hold **■** until 'FM/AM X DELETED' appears.
  - ➔ 'X' is the preset number.
  - ➔ The radio station continues to play but has been deleted from the preset list.
  - ➔ The rest of the preset radio stations remain unchanged.

# Sound and Volume Controls

## Volume control

- Press **VOL + / -** to increase or decrease the volume level.  
→ 'VOLUME MIN' is the minimum volume level and 'VOLUME MAX' is the maximum volume level.

### To turn off the volume temporarily

- Press **MUTE**.  
→ Playback continues without sound and 'VOLUME MUTED' appears.  
→ To restore the volume, press **MUTE** again, or increase the volume level.

## Adjusting the Bass/Treble level

The BASS (low tone) and TREBLE (high tone) features enable you to define the sound processor settings.

- 1 Press **TREBLE/BASS** to toggle between Treble and Bass mode.
- 2 Within five seconds, use the **VOL + -** to adjust the Treble or Bass level (0, 1, 2 or MAX.)  
→ If the volume control is not used within five seconds, it resume normal volume control function.

## Selecting surround sound

- Press **AMBISOUND** to select between Auto, Multi-channel or Stereo sound.  
→ 'Auto' is the default surround setting (recommended). Multi-channel or Stereo will be selected based on the audio stream of the played content.  
→ The available output modes for Multi-channel include: Dolby Digital, DTS (Digital Theater Systems) Surround and Dolby Pro Logic II.

## Selecting digital sound effects

Select a preset digital sound effect that matches your disc's content or that optimizes the sound of the musical style you are playing.

- Press **SOUND** to select the available sound effect.

Movies	Music	Description
ACTION	ROCK	Enhanced low and high range for great sounding movie effects and atmosphere. Great for action movies and rock/pop music.
DRAMA	JAZZ	Clear mid and high range. Recreates the atmosphere of a live club with the artist just in front of you. Good for Jazz music and watching dramas.
GAMING	PARTY	Slightly enhanced low range and strong mid range ideal for party music and video gaming.
CONCERT	CLASSIC	Flat and pure sound mode. Ideal for listening to classical music and watching live concert DVDs.
MTV	RnB	Enhanced low and mid range for groovy and punchy sounds. Suitable for R&B, Hip Hop and MTV videos.
CARTOONS	LOUNGE	Moderate sound mode suitable for lounge music and watching cartoons.
SPORTS	SPORTS	Moderate mid range and surround effects for clear vocals and the atmosphere of a live sports venue.
NEWS	NEWS	Enhanced mid range for clear vocals/speech.

## Other Features

---

### Installing the latest software

Periodically Philips will issue software upgrades to enhance the user experience.

- ① Get the software version of this unit by pressing **OPEN/CLOSE**  to open the disc compartment
- ② Press **DISPLAY** on the remote control.  
→ Write down the information for your current software version.
- ③ Visit the Philips website 'www.philips.com/support' to check the availability of the latest software upgrade and download the software to a CD-R.
- ④ Insert the CD-R to the disc tray.  
→ The software starts to install on this unit automatically.

**Note:**

**Never unplug or turn off this unit during the upgrade.**

- ⑤ When the disc compartment opens, remove the CD-R.  
→ The software upgrading is in process. Leave the disc compartment open.
- ⑥ Wait until the disc compartment closes automatically, you can now power off and on the unit.



# Troubleshooting

## WARNING

Under no circumstances should you try to repair this unit yourself, as this will invalidate the warranty. Do not open this unit as there is a risk of electric shock.

If a fault occurs, first check the points listed below before taking this unit for repair. If you are unable to solve a problem by following these instructions, consult your dealer or Philips for help.

Problem (General)	Solution
<b>No power.</b>	<ul style="list-style-type: none"><li>– Press <b>STANDBY-ON</b> on the unit to turn on the power.</li><li>– Ensure that the interconnect cable between the subwoofer and main unit are connected.</li></ul>
<b>No picture.</b>	<ul style="list-style-type: none"><li>– Refer to your TV's manual for correct Video In channel selection. Change the TV channel until you see the DVD screen.</li><li>– Press <b>DISC</b> to select disc mode.</li><li>– If this happens when you turn on the progressive scan feature or change the HDMI video setting, wait for 15 seconds for the auto recovery or switch back to the default mode as below:<ol style="list-style-type: none"><li>1) Press <b>OPEN/CLOSE</b> to open the disc compartment.</li><li>2) Press cursor left key on the remote control.</li><li>3) Press <b>AUDIO</b> on the remote control.</li></ol></li></ul>
<b>Completely distorted picture or black/white picture.</b>	<ul style="list-style-type: none"><li>– Check the video connection.</li><li>– Sometimes a small amount of picture distortion may appear. This is not a malfunction.</li><li>– The disc is dirty. Clean the disc.</li></ul>
<b>No sound or distorted sound.</b>	<ul style="list-style-type: none"><li>– Adjust the volume.</li><li>– Check the speaker connections and settings.</li><li>– Make sure that the audio cables are connected and press <b>SOURCE</b> to select the correct input source (for example, TV or AUX) to choose the device that you want to hear through this unit.</li></ul>
<b>No surround sound effect from the speakers.</b>	<ul style="list-style-type: none"><li>– Press <b>AMBISOUND</b> to select a correct surround sound setting.</li><li>– Make sure that the source you are playing is recorded or broadcast in surround sound (DTS, Dolby Digital, etc.).</li></ul>
<b>The remote control does not function properly.</b>	<ul style="list-style-type: none"><li>– Select the source you want to play (for example, <b>DISC</b> or <b>RADIO</b>) before pressing the function button (<b>▶</b>, <b>◀◀</b> / <b>▶▶</b>).</li><li>– Reduce the distance between the remote control and this unit.</li><li>– Batteries are weak, replace the batteries.</li></ul>

## Troubleshooting (continued)

Problem (Playback)	Solution
<b>The unit does not start playback.</b>	<ul style="list-style-type: none"><li>– Insert a readable disc with the playback side facing inwards. The DVD+R/CD-R must be finalized.</li><li>– Make sure the disc is not scratched or warped.</li><li>– Press <b>SETUP</b> to turn off the system setup menu screen.</li><li>– You may need to enter the password in order to unlock the disc for playback.</li><li>– Moisture may have condensed inside this unit. Remove the disc and leave this unit turned on for about an hour.</li></ul>
<b>The aspect ratio of the screen cannot be changed even though you have set the TV display.</b>	<ul style="list-style-type: none"><li>– The aspect ratio is fixed on the DVD disc.</li><li>– Depending on the TV, it may not be possible to change the aspect ratio.</li></ul>
<b>Cannot activate some features such as Angles, Subtitles, or multi-language Audio.</b>	<ul style="list-style-type: none"><li>– The features may not be available on the DVD.</li><li>– Changing the language for the sound or subtitle is prohibited on this DVD.</li></ul>
<b>Not able to select some items in the setup/system menu.</b>	<ul style="list-style-type: none"><li>– Press <b>STOP</b> button twice before selecting the system setup menu.</li><li>– Depending on the disc availability, some menu items cannot be selected.</li></ul>
<b>Unable to play DivX movies.</b>	<ul style="list-style-type: none"><li>– Ensure that the DivX file is encoded according to the 'Home Theater Profile' with the DivX encoder.</li><li>– Check that the DivX movie downloaded is a complete file.</li></ul>
<b>Radio reception is poor.</b>	<ul style="list-style-type: none"><li>– If the signal is too weak, adjust the antenna or connect an external antenna for better reception.</li><li>– Increase the distance between this unit and your TV or VCR.</li><li>– Tune in to the correct frequency.</li><li>– Place the antenna further away from any equipment that may be causing the interference.</li></ul>
<b>The unit does not work.</b>	<ul style="list-style-type: none"><li>– Disconnect the power cord from the power outlet for a few minutes. Reconnect the power cord and try to operate again as usual.</li><li>– Ensure that the interconnect cable between the subwoofer and main unit are connected.</li></ul>

## Troubleshooting (continued)

Problem (USB/HDMI/Dock Station)	Solution
<b>The contents of the USB flash drive cannot be read.</b>	<ul style="list-style-type: none"><li>- The USB flash drive format is not compatible with this unit.</li><li>- Drive is formatted with a different file system which is not supported by this unit (e.g. NTFS.)</li></ul>
<b>Slow operation of the USB flash drive.</b>	<ul style="list-style-type: none"><li>- Large file size or high memory USB flash drive takes longer time to read and display on the TV.</li></ul>
<b>No audio output from HDMI connection.</b>	<ul style="list-style-type: none"><li>- You will not hear any sound from the HDMI output if the source device is only DVI/HDCP (High-bandwidth Digital Content Protection)-compatible.</li><li>- It is not possible to output SACD or copy-controlled DVD-Audio sources from the HDMI connection.</li><li>- Make sure that the audio output setting is not turned off. See 'Setup Menu Options - { Audio Setup Page - HDMI Audio }' for details.</li></ul>
<b>No video output from HDMI connection.</b>	<ul style="list-style-type: none"><li>- HDMI connection can only be made to HDMI-equipped devices with HDCP (High Bandwidth Digital Content Protection.) If you wish to connect to a DVI connector (equipped with HDCP,) you will need a separate adaptor (DVI to HDMI.)</li><li>- Make sure the resolution of this unit matches the device you have connected using the HDMI. See 'Setup Menu Options - { Video Setup Page - HDMI Setup - HDMI Video }' for details.</li></ul>
<b>No picture after changing the HDMI video resolution.</b>	<ul style="list-style-type: none"><li>- Your TV cannot support the current HDMI video resolution. Switch the HDMI video resolution to the next setting by holding down the SELECT/PROGRAM on the remote control for more than 3 seconds repeatedly until the picture appears on the TV again.</li></ul>
<b>No video from iPod playback.</b>	<ul style="list-style-type: none"><li>- Make sure you have connected the 3.5mm video cable from the docking station to your TV. Turn on your TV to the correct video input channel.</li><li>- Turn on the 'TV ON' setting of the iPod.</li></ul>
<b>'NONE DOCKED' appears on the display panel.</b>	<ul style="list-style-type: none"><li>- Remove the iPod from the docking cradle and reinsert again.</li><li>- If the battery level of your iPod is totally drained, you have to charge it again before use.</li></ul>

## Frequently Asked Questions (USB)

### Why does it take so long to display the contents on my USB device?

- This could be due to the large numbers of files (>500 files/folders) or size of the files (>1MB.)
- There could be other non-supported files in the device that this unit is trying to read/display.

### What if un-supported devices (e.g. USB mouse, keyboards) are plugged into this unit?

The device may cause this unit to be unstable. Remove the unsupported device and unplug the mains cord. Wait for a few minutes before reconnecting the mains cord and power on this unit again.

### What happens when I plug in a USB HDD?

HDD is not supported as the large storage capacity makes navigation very difficult. Transfer the music files (mp3) and photos (jpg) into a flash drive.

### Why does this unit fail to detect my USB portable music player?

The portable music player may require propriety software that is bundled with our system in order to access the contents (eg. playlist). MTP class not supported, only can support mass storage class devices.

### What types of file does this unit support?

We support only FAT16 and FAT32, not NTFS.

### Why does the file name appear to be different from what was displayed on my computer (e.g. from “Good Bye. jpg” to “Good\_B~1.jpg”)?

- The length of the file name is restricted by the file system of the device (FAT16), which only supports eight (8) characters.
- The computer may be able to display the full file name as the operating system can convert the file system.

### Is simultaneous USB and Disc playback possible?

This is not possible due to memory limitation. In addition, a different user interface will be needed in order to function and in order to be simple enough to use.

### Why can't I rotate the pictures in my device?

In order to rotate the pictures in the USB device, the picture must contain EXIF information, stored by most digital cameras. This EXIF information may have been removed when you edit or copy the picture from other devices using editing programs.

### Why can't this unit play some of my music files, photos or movies?

The music files may not be playable because of different formats and encoding bit-rates. Similarly, the photos may be of low resolution or too high resolution for this unit to support.

# Specifications

## AMPLIFIER

Output power: 240 W FTC\*  
Frequency Response: 20 Hz – 20 kHz / –3 dB  
Signal-to-Noise Ratio: > 65 dB (CCIR)  
Input Sensitivity  
- AUX 1&2 In: 1000 mV  
- TV In: 500 mV  
- Digital In: 500 mV  
- MP3 Line-In: 250 mV

\* (1% THD 1kHz)

## RADIO

Tuning Range: FM 87.5–108 MHz (100kHz)  
AM 530–1700 kHz (10kHz)

26 dB Quieting

Sensitivity: FM 20 dBf, AM 4 $\mu$ V/m  
Image Rejection Ratio: FM 25 dB, AM 28 dB  
IF Rejection Ratio: FM 60 dB, AM 45 dB  
Signal-to-Noise Ratio: FM 60 dB, AM 40 dB  
AM Suppression Ratio: FM 30 dB  
Harmonic Distortion: FM Mono 3%  
FM Stereo 3%  
AM 5%  
Frequency Response FM 180 Hz–10 kHz /  $\pm$ 6 dB  
Stereo Separation FM 26 dB (1 kHz)  
Stereo Threshold FM 23.5 dB

## DISC

Laser Type Semiconductor  
Disc Diameter 12cm / 8cm  
Video Decoding MPEG-1 / MPEG-2 /  
/ DivX 3/4/5/6, Ultra  
Video DAC 12 Bits  
Signal System PAL / NTSC  
Video Format 4:3 / 16:9  
Video S/N 56 dB (minimum)  
Composite Video Output: 1.0 Vp-p, 75 $\Omega$   
Component Video Output  
(Y) 1.0 Vp-p, 75 $\Omega$   
(Pb) 0.7 Vp-p, 75 $\Omega$   
(Pr) 0.7 Vp-p, 75 $\Omega$   
Audio DAC 24 Bits / 192 kHz  
Frequency Response 4 Hz–20 kHz (44.1 kHz)  
4 Hz–22 kHz (48 kHz)  
4 Hz–44 kHz (96 kHz)  
PCM IEC 60958  
Dolby Digital IEC 60958, IEC 61937  
DTS IEC 60958, IEC 61937

## MAIN UNIT

Dimensions: 935 x 146 x 136 (mm)  
(w x h x d)  
Weight: 7.2 kg  
Speaker system Closed-box system  
**Centre Speaker**  
Speaker Impedance: 4ohm  
Speaker drivers: 2 x 2.5" woofer + 2 x 25mm  
soft dome tweeter  
Frequency response: 200 Hz - 20 kHz  
**Left/Right Surround Speakers**  
Speaker Impedance: 6ohm  
Speaker drivers: 2 x 2.5" full-range speaker  
Frequency response: 200 Hz - 20 kHz

## SUBWOOFER

Power Supply Rating: 120 V; 60 Hz  
Power Consumption: 120 W  
Low Standby power: < 0.6 W  
System: Bass Reflex System  
Impedance: 4  $\Omega$   
Speaker drivers: 165 mm (6 1/2") woofer  
Frequency response: 35 Hz – 200 Hz  
Dimensions: 295 x 470 x 295 (mm)  
(w x h x d)  
Weight: 11.2 kg

Specifications subject to change without prior notice.

## Glossary

**Analog audio:** Sound that has not been turned into numbers. Analog sound is available with you use the AUDIO LEFT/RIGHT. These red and white jacks send audio through two channels, the left and right.

**Aspect ratio:** Aspect ratio refers to the length to height ratio of TV screens. The ratio of a standard TV is 4:3, while the ratio of a high-definition or wide TV is 16:9. The letter box allows you to enjoy a picture with a wider perspective on a standard 4:3 screen.

**AUDIO OUT jacks:** Red and white jacks on the back of the unit that send audio to another system (TV, Stereo, etc.).

**Bit Rate:** The amount of data used to hold a given length of music; measured in kilobits per second, or kbps. Or, the speed at which you record. Generally, the higher the bit rate, or the higher the recording speed, the better the sound quality. However, higher bit rates use more space on a disc.

**Chapter:** Sections of a picture or a music piece on a DVD that are smaller than titles. A title is composed of several chapters. Each chapter is assigned a chapter number enabling you to locate the chapter you want.

**Composite video (CVBS):** A single video signal commonly used in most consumer video products.

**Disc menu:** A screen display prepared for allowing a selection of images, sounds, subtitles, multi-angles, etc., recorded on a DVD.

**DivX:** The DivX code is a patent-pending, MPEG-4 based video compression technology, developed by DivX Networks, Inc., that can shrink digital video to sizes small enough to be transported over the internet, while maintaining high visual quality.

**Dolby Digital:** A surround sound system developed by Dolby Laboratories containing up to six channels of digital audio (front left and right, surround left and right, center and subwoofer.)

**Dolby Surround Pro Logic II:** It is an improved matrix decoding technology that provides better spatiality and directionality on Dolby Surround program material, provides a convincing three dimensional sound field on conventional stereo music recordings and is ideally suited to bring the surround experience to automotive sound. While conventional surround programming is fully compatible with Dolby Surround Pro Logic II decoders, soundtracks will be able to be encoded specifically to take full advantage of Pro Logic II playback, including separate left and right surround channels. (Such material is also compatible with conventional Pro Logic decoders.)

**DTS:** Digital Theater Systems. This is a surround sound system, but it is different from the Dolby Digital. The formats were developed by different companies.

**HDMI:** High-Definition Multimedia Interface (HDMI) is a high-speed digital interface that can transmit uncompressed high definition video and digital multichannel audio. It delivers perfect picture and sound quality, completely free from noise. HDMI is fully backward-compatible with DVI. As required by the HDMI standard, connecting to HDMI or DVI products without HDCP (High-bandwidth Digital Content Protection) will result in no Video or Audio output.

**HDCP** (High-bandwidth Digital Content Protection) is a specification that provides a secure transmission of digital contents between different devices (to prevent unauthorized copyright.)

## Glossary (continued)

**JPEG:** A very common digital still picture format. A still-picture data compression system proposed by the Joint Photographic Expert Group, which features small decrease in image quality in spite of its high compression ratio. Files are recognized by their file extension 'JPG or JPEG.'

**MP3:** A file format with a sound data compression system. 'MP3' is the abbreviation of Motion Picture Experts Group 1 (or MPEG-1) Audio Layer3. By using the MP3 format, one CD-R or CD-RW can contain about 10 times more data than a regular CD.

**MPEG:** Motion Picture Experts Group. A collection of compression systems for digital audio and video.

**Multi-channel:** DVDs are formatted to have each sound track constitute one sound field. Multi-channel refers to a structure of sound tracks having three or more channels.

**PBC:** Playback Control. A system of navigating a Video CD/Super VCD through on-screen menus recorded onto the disc. You can enjoy interactive playback and searching.

**Progressive Scan:** The progressive scan displays twice the number of frames per second than in an ordinary TV system. It offers higher picture resolution and quality.

**Region code:** A system allowing discs to be played only in the region designated. This unit will only play discs that have compatible region codes. You can find the region code of your unit by looking at the product label. Some discs are compatible with more than one region (or ALL regions.)

**Surround:** A system for creating realistic three dimensional sound fields full of realism by arranging multiple speakers around the listener.

**Title:** The longest section of a movie or music feature on DVD. Each title is assigned a title number, enabling you to locate the title you want.

**WMA:** Windows Media™ Audio. Refers to an audio compression technology developed by Microsoft Corporation. WMA data can be encoded by using Windows Media Player version 9 or Windows Media Player for Windows XP. Files are recognized by their file extension 'WMA.'

## PHILIPS LIMITED WARRANTY ONE (1) YEAR

### WARRANTY COVERAGE:

PHILIPS warranty obligation is limited to the terms set forth below.

### WHO IS COVERED:

Philips warrants the product to the original purchaser or the person receiving the product as a gift against defects in materials and workmanship as based on the date of original purchase ("Warranty Period") from an Authorized Dealer. The original sales receipt showing the product name and the purchase date from an authorized retailer is considered such proof.

### WHAT IS COVERED:

The Philips warranty covers new products if a defect arises and a valid claim is received by Philips within the Warranty Period. At its option, Philips will either (1) repair the product at no charge, using new or refurbished replacement parts, or (2) exchange the product with a product that is new or which has been manufactured from new, or serviceable used parts and is at least functionally equivalent or most comparable to the original product in Philips current inventory, or (3) refund the original purchase price of the product.

Philips warrants replacement products or parts provided under this warranty against defects in materials and workmanship from the date of the replacement or repair for ninety (90) days or for the remaining portion of the original product's warranty, whichever provides longer coverage for you. When a product or part is exchanged, any replacement item becomes your property and the replaced item becomes Philips' property. When a refund is given, your product becomes Philips' property.

**Note: Any product sold and identified as refurbished or renewed carries a ninety (90) day limited warranty.**

Replacement product can only be sent if all warranty requirements are met. Failure to follow all requirements can result in delay.

### WHAT IS NOT COVERED - EXCLUSIONS AND LIMITATIONS:

This Limited Warranty applies only to the new products manufactured by or for Philips that can be identified by the trademark, trade name, or logo affixed to it. This Limited Warranty does not apply to any non-Philips hardware product or any software, even if packaged or sold with the product. Non-Philips manufacturers, suppliers, or publishers may provide a separate warranty for their own products packaged with the bundled product.

Philips is not liable for any damage to or loss of any programs, data, or other information stored on any media contained within the product, or any non-Philips product or part not covered by this warranty. Recovery or reinstallation of programs, data or other information is not covered under this Limited Warranty.

This warranty does not apply (a) to damage caused by accident, abuse, misuse, misapplication, or non-Philips product, (b) to damage caused by service performed by anyone other than Philips or Philips Authorized Service Location, (c) to a product or a part that has been modified without the written permission of Philips, or (d) if any Philips serial number has been removed or defaced, or (e) product, accessories or consumables sold "AS IS" without warranty of any kind by including refurbished Philips product sold "AS IS" by some retailers.

### This Limited Warranty does not cover:

- Shipping charges to return defective product to Philips.
- Labor charges for installation or setup of the product, adjustment of customer controls on the product, and installation or repair of antenna systems outside of the product.
- Product repair and/or part replacement because of improper installation, connections to improper voltage supply, abuse, neglect, misuse, accident, unauthorized repair or other cause not within the control of Philips.
- Damage or claims for products not being available for use, or for lost data or lost software.
- Damage occurring to product during shipping.
- A product that requires modification or adaptation to enable it to operate in any country other than the country for which it was designed, manufactured, approved and/or authorized, or repair of products damaged by these modifications.
- A product used for commercial or institutional purposes (including but not limited to rental purposes).
- Product lost in shipment and no signature verification receipt can be provided.
- Failure to operate per Owner's Manual.

### TO OBTAIN ASSISTANCE IN THE U.S.A., PUERTO RICO, OR U.S. VIRGIN ISLANDS...

Contact Philips Customer Care Center at:  
1-888-PHILIPS (1-888-744-5477)

### TO OBTAIN ASSISTANCE IN CANADA...

1-800-661-6162 (French Speaking)  
1-888-PHILIPS (1-888-744-5477) - (English or Spanish Speaking)

REPAIR OR REPLACEMENT AS PROVIDED UNDER THIS WARRANTY IS THE EXCLUSIVE REMEDY FOR THE CONSUMER. PHILIPS SHALL NOT BE LIABLE FOR ANY INCIDENTAL OR CONSEQUENTIAL DAMAGES FOR BREACH OF ANY EXPRESS OR IMPLIED WARRANTY ON THIS PRODUCT, EXCEPT TO THE EXTENT PROHIBITED BY APPLICABLE LAW, ANY IMPLIED WARRANTY OF MERCHANTABILITY OR FITNESS FOR A PARTICULAR PURPOSE ON THIS PRODUCT IS LIMITED IN DURATION TO THE DURATION OF THIS WARRANTY.

Some states do not allow the exclusions or limitation of incidental or consequential damages, or allow limitations on how long an implied warranty lasts, so the above limitations or exclusions may not apply to you.

*This warranty gives you specific legal rights. You may have other rights which vary from state/province to state/province.*

Philips, P.O. Box 671539, Marietta, GA. 30006-0026

3121 233 48801