

SONY®

Cyber-shot

Digital Still Camera

Instruction Manual

DSC-T100

GB



For details on the advanced operations, please access "**Cyber-shot Handbook**" and "**Cyber-shot Step-up Guide**" contained on the supplied CD-ROM via a computer.

Operating Instructions

Before operating the unit, please read this manual thoroughly, and retain it for future reference.

Owner's Record

The model and serial numbers are located on the bottom. Record the serial number in the space provided below. Refer to these numbers whenever you call upon your Sony dealer regarding this product.

Model No. DSC-T100

Serial No. _____

WARNING

To reduce fire or shock hazard, do not expose the unit to rain or moisture.

For Customers in the U.S.A.

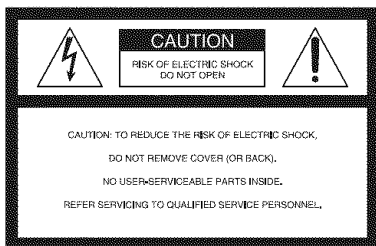

This symbol is intended to alert the user to the presence of uninsulated "dangerous voltage" within the product's enclosure that may be of sufficient magnitude to constitute a risk of electric shock to persons.



This symbol is intended to alert the user to the presence of important operating and maintenance (servicing) instructions in the literature accompanying the appliance.

IMPORTANT SAFEGUARDS

For your protection, please read these safety instructions completely before operating the appliance, and keep this manual for future reference.

Carefully observe all warnings, precautions and instructions on the appliance, or the one described in the operating instructions and adhere to them.

Use

Power Sources

This set should be operated only from the type of power source indicated on the marking label. If you are not sure of the type of electrical power supplied to your home, consult your dealer or local power company. For those sets designed to operate from battery power, or other sources, refer to the operating instructions.

Polarization

This set may be equipped with a polarized ac power cord plug (a plug having one blade wider than the other).

This plug will fit into the power outlet only one way. This is a safety feature. If you are unable to insert the plug fully into the outlet, try reversing the plug. If the plug should still fail to fit, contact your electrician to have a suitable outlet installed. Do not defeat the safety purpose of the polarized plug by forcing it in.

Overloading

Do not overload wall outlets, extension cords or convenience receptacles beyond their capacity, since this can result in fire or electric shock.

Object and Liquid Entry

Never push objects of any kind into the set through openings as they may touch dangerous voltage points or short out parts that could result in a fire or electric shock. Never spill liquid of any kind on the set.

Attachments

Do not use attachments not recommended by the manufacturer, as they may cause hazards.

■ Cleaning

Unplug the set from the wall outlet before cleaning or polishing it. Do not use liquid cleaners or aerosol cleaners. Use a cloth lightly dampened with water for cleaning the exterior of the set.

■ Installation

■ Water and Moisture

Do not use power-line operated sets near water – for example, near a bathtub, washbowl, kitchen sink, or laundry tub, in a wet basement, or near a swimming pool, etc.

■ Power-Cord Protection

Route the power cord so that it is not likely to be walked on or pinched by items placed upon or against them, paying particular attention to the plugs, receptacles, and the point where the cord exits from the appliance.

■ Accessories

Do not place the set on an unstable cart, stand, tripod, bracket, or table. The set may fall, causing serious injury to a child or an adult, and serious damage to the set. Use only a cart, stand, tripod, bracket, or table recommended by the manufacturer.

■ Ventilation

The slots and openings in the cabinet are provided for necessary ventilation. To ensure reliable operation of the set, and to protect it from overheating, these slots and openings must never be blocked or covered.

- Never cover the slots and openings with a cloth or other materials.
- Never block the slots and openings by placing the set on a bed, sofa, rug, or other similar surface.
- Never place the set in a confined space, such as a bookcase, or built-in cabinet, unless proper ventilation is provided.
- Do not place the set near or over a radiator or heat register, or where it is exposed to direct sunlight.

■ Lighting

For added protection for this set during a lightning storm, or when it is left unattended and unused for

long periods of time, unplug it from the wall outlet and disconnect the antenna or cable system. This will prevent damage to the set due to lightning and power-line surges.

■ Service

■ Damage Requiring Service

Unplug the set from the wall outlet and refer servicing to qualified service personnel under the following conditions:

- When the power cord or plug is damaged or frayed.
- If liquid has been spilled or objects have fallen into the set.
- If the set has been exposed to rain or water.
- If the set has been subject to excessive shock by being dropped, or the cabinet has been damaged.
- If the set does not operate normally when following the operating instructions. Adjust only those controls that are specified in the operating instructions. Improper adjustment of other controls may result in damage and will often require extensive work by a qualified technician to restore the set to normal operation.
- When the set exhibits a distinct change in performance – this indicates a need for service.

■ Servicing

Do not attempt to service the set yourself as opening or removing covers may expose you to dangerous voltage or other hazards.

Refer all servicing to qualified service personnel.

■ Replacement parts

When replacement parts are required, be sure the service technician has used replacement parts specified by the manufacturer that have the same characteristics as the original parts.

Unauthorized substitutions may result in fire, electric shock, or other hazards.

■ Safety Check

Upon completion of any service or repairs to the set, ask the service technician to perform routine safety checks (as specified by the manufacturer) to determine that the set is in safe operating condition.

Read this first

CAUTION

Replace the battery with the specified type only. Otherwise, fire or injury may result.

For Customers in the U.S.A. and Canada

RECYCLING LITHIUM-ION BATTERIES

Lithium-Ion batteries are recyclable.

You can help preserve our environment by returning your used rechargeable batteries to the collection and recycling location nearest you.



For more information regarding recycling of rechargeable batteries, call toll free 1-800-822-8837, or visit <http://www.rbc.org/>

Caution: Do not handle damaged or leaking Lithium-Ion batteries.

Battery charger

This power unit is intended to be correctly orientated in a vertical or floor mount position.

For Customers in the U.S.A.

If you have any questions about this product, you may call:

Sony Customer Information Center
1-800-222-SONY (7669)

The number below is for the FCC related matters only.

Regulatory Information

Declaration of Conformity

Trade Name: SONY
Model No.: DSC-T100
Responsible Party: Sony Electronics Inc.
Address: 16530 Via Esprillo,
San Diego, CA 92127 U.S.A.
Telephone No.: 858-942-2230

This device complies with Part 15 of the FCC Rules. Operation is subject to the following two conditions: (1) This device may not cause harmful interference, and (2) this device must accept any interference received, including interference that may cause undesired operation.

CAUTION

You are cautioned that any changes or modifications not expressly approved in this manual could void your authority to operate this equipment.

Note:

This equipment has been tested and found to comply with the limits for a Class B digital device, pursuant to Part 15 of the FCC Rules. These limits are designed to provide reasonable protection against harmful interference in a residential installation. This equipment generates, uses, and can radiate radio frequency energy and, if not installed and used in accordance with the instructions, may cause harmful interference to radio communications. However, there is no guarantee that interference will not occur in a particular installation. If this equipment does cause harmful interference to radio or television reception, which can be determined by turning the equipment off and on, the user is encouraged to try to correct the interference by one or more of the following measures:

- Reorient or relocate the receiving antenna.
- Increase the separation between the equipment and receiver.

- Connect the equipment into an outlet on a circuit different from that to which the receiver is connected.
- Consult the dealer or an experienced radio/TV technician for help.

The supplied interface cable must be used with the equipment in order to comply with the limits for a digital device pursuant to Subpart B of Part 15 of FCC Rules.

For the State of California, USA only

Perchlorate Material - special handling may apply. See

www.dtsc.ca.gov/hazardouswaste/perchlorate

Perchlorate Material : Lithium battery contains perchlorate.

For Customers in Europe

This product has been tested and found compliant with the limits set out in the EMC Directive for using connection cables shorter than 3 meters (9.8 feet).

Attention

The electromagnetic fields at the specific frequencies may influence the picture and sound of this unit.

Notice



If static electricity or electromagnetism causes data transfer to discontinue midway (fail), restart the application or disconnect and connect the communication cable (USB, etc.) again.

Disposal of Old Electrical & Electronic Equipment (Applicable in the European Union and other European countries with separate collection systems)



This symbol on the product or on its packaging indicates that this product shall not be treated as household waste. Instead it shall be handed over to the applicable collection point for the recycling of electrical and electronic equipment. By ensuring this product is disposed of correctly, you will help prevent potential negative consequences for the environment and human health, which could otherwise be caused by inappropriate waste handling of this product. The recycling of materials will help to conserve natural resources. For more detailed information about recycling of this product, please contact your local Civic Office, your household waste disposal service or the shop where you purchased the product.

Notice for customers in the United Kingdom

A moulded plug complying with BS 1363 is fitted to this equipment for your safety and convenience. Should the fuse in the plug supplied need to be replaced, a fuse of the same rating as the supplied one and approved by ASTA or BSI to BS 1362, (i.e., marked with an  or  mark) must be used.

If the plug supplied with this equipment has a detachable fuse cover, be sure to attach the fuse cover after you change the fuse. Never use the plug without the fuse cover. If you should lose the fuse cover, please contact your nearest Sony service station.

Notes on using your camera

Internal memory and “Memory Stick Duo” back up

Do not turn off the camera or remove the battery pack or “Memory Stick Duo” while the access lamp is lighted, as the internal memory data or “Memory Stick Duo” data may be destroyed. Always protect your data by making a back up copy.

Notes on recording/playback

- Before you record, make a trial recording to make sure that the camera is working correctly.
- This camera is neither dust-proof, nor splash-proof, nor water-proof. Read “Precautions” (page 29) before operating the camera.
- Be careful not to get the camera wet. Water entering the inside of the camera may cause malfunctions which in some cases may not be repairable.
- Do not aim the camera at the sun or other bright light. It may cause the malfunction of your camera.
- Do not use the camera near a location that generates strong radio waves or emits radiation. The camera may not be able to record or play back properly.
- Using the camera in sandy or dusty locations may cause malfunctions.
- If moisture condensation occurs, remove it before using the camera (page 29).
- Do not shake or strike the camera. In addition to malfunctions and an inability to record images, this may render the recording medium unusable, or cause image data breakdown, damage or loss.
- Clean the flash surface before use. The heat of flash emission may cause dirt on the flash surface to become discolored or to stick to the flash surface, resulting in insufficient light emission.

Notes on the LCD screen

- The LCD screen is manufactured using extremely high-precision technology so over 99.99% of the pixels are operational for effective use. However, there may be some tiny black points and/or bright points (white, red, blue or green in color) that constantly appear on the LCD screen. These points are normal in the manufacturing process and do not affect the recording in any way.

On image data compatibility

- This camera conforms with DCF (Design rule for Camera File system) universal standard established by JEITA (Japan Electronics and Information Technology Industries Association).
- Playback of images recorded with your camera on other equipment and playback of images recorded or edited with other equipment on your camera are not guaranteed.

Warning on copyright

Television programs, films, videotapes, and other materials may be copyrighted. Unauthorized recording of such materials may be contrary to the provisions of the copyright laws.

No compensation for contents of the recording

The contents of the recording cannot be compensated for if recording or playback is not possible due to a malfunction of your camera or recording media, etc.

Table of contents

IMPORTANT SAFEGUARDS	2
Read this first	4
Notes on using your camera	6
Getting started	8
Checking the accessories supplied	8
1 Preparing the battery pack	9
2 Inserting the battery pack/a "Memory Stick Duo" (not supplied)	10
3 Turning the camera on/setting the clock	12
Shooting images easily (Auto adjustment mode)	13
Zoom/Flash/Macro/Self-timer/Display	14
Viewing/deleting images	15
Learning the various functions – HOME/Menu	17
Using the HOME screen	17
HOME screen items	18
Using menu items	19
Menu items	20
Enjoying your computer	21
Supported Operating Systems for USB connection and application software (supplied)	21
Viewing "Cyber-shot Handbook" or "Cyber-shot Step-up Guide"	22
Indicators on the screen	23
Battery life and memory capacity	25
Battery life and number of images that can be recorded/viewed	25
Number of still images and recording time of movies	26
Troubleshooting	27
Battery pack and power	27
Shooting still images/movies	28
Viewing images	28
Precautions	29
Specifications	30

Getting started

Checking the accessories supplied

- Battery charger BC-CSG/BC-CSGB/BC-CSGC (1)

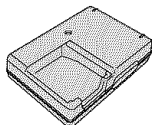

- Power cord (mains lead) (1)
(not supplied in the USA and Canada)



- Rechargeable battery pack NP-BG1 (1)/
Battery case (1)

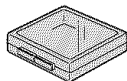
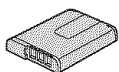

- USB, A/V cable for multi-use terminal (1)

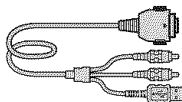

- Wrist strap (1)



- CD-ROM (Cyber-shot application software/
"Cyber-shot Handbook"/"Cyber-shot Step-up
Guide") (1)
- Instruction Manual (this manual) (1)

Attach the strap and pass your hand through it, to prevent the camera from damage by being dropped, etc.

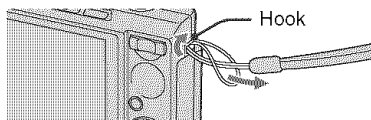

1 Preparing the battery pack

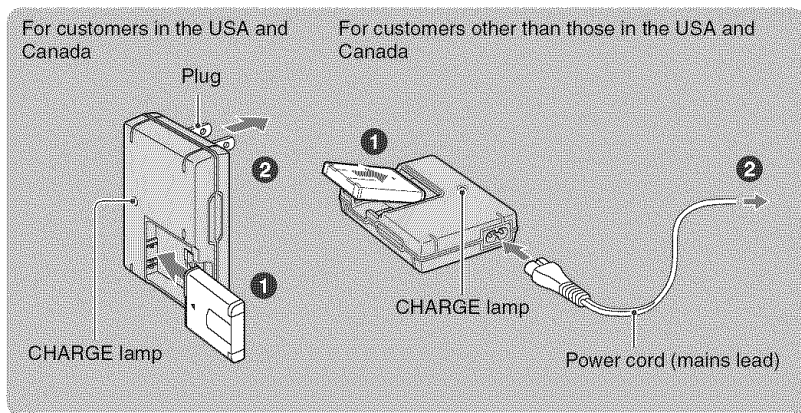

1 Insert the battery pack into the battery charger.

2 Connect the battery charger to the wall outlet (wall socket).

The CHARGE lamp lights on, and charging starts.

When the CHARGE lamp turns off, charging is finished (Practical charge).

If you continue charging the battery pack for about one more hour (until it is fully charged), the charge will last slightly longer.

Charging time

Full charge time	Practical charge time
Approx. 330 min.	Approx. 270 min.

- Time required to charge a fully depleted battery pack at a temperature of 25°C (77°F). Charging may take longer under certain circumstances or conditions.
- See page 25 for the number of images that can be recorded.
- Connect the battery charger to an easily accessible wall outlet (wall socket) close by.
- Even if the CHARGE lamp is not lit, the battery charger is not disconnected from the AC power source (mains) as long as it is connected to the wall outlet (wall socket). If some trouble occurs while using the battery charger, immediately shut off the power by disconnecting the plug from the wall outlet (wall socket).
- When charging is finished, disconnect the power cord (mains lead) from the wall outlet (wall socket), and remove the battery pack from the battery charger.
- Designed for use with compatible Sony batteries.

2 Inserting the battery pack/a “Memory Stick Duo” (not supplied)

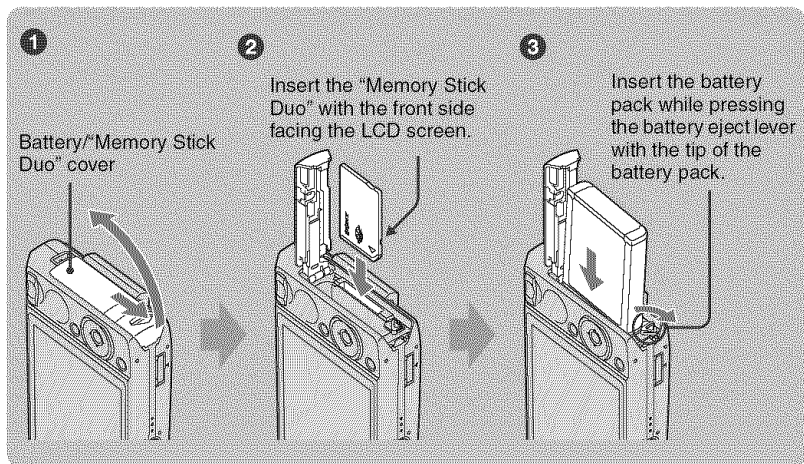





- 1 Open the battery/“Memory Stick Duo” cover.
- 2 Insert the “Memory Stick Duo” (not supplied) all the way in until it clicks.
- 3 Insert the battery pack.
- 4 Close the battery/“Memory Stick Duo” cover.

! When there is no “Memory Stick Duo” inserted

The camera records/plays back images using the internal memory (approx. 31 MB).

To check the remaining battery time

Press POWER button to turn on and check the remaining battery on the LCD screen.

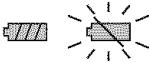
Battery remaining indicator					
Battery remaining guidelines	Sufficient power remaining	Battery almost fully charged	Battery half full	Battery low, recording/playback will stop soon.	Change the battery with fully charged one, or charge the battery. (The warning indicator flashes.)

- It takes about one minute until the correct battery remaining indicator appears.
- The displayed battery remaining indicator may not be correct under certain circumstances.
- The Clock Set screen appears when the camera is turned on for the first time (page 12).

To remove the battery pack/“Memory Stick Duo”

Open the battery/“Memory Stick Duo” cover.

“Memory Stick Duo”

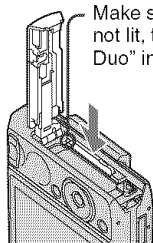

Make sure that the **access lamp** is not lit, then push the “Memory Stick Duo” in once.

Battery pack

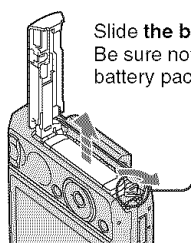

Slide the **battery eject lever**. Be sure not to drop the battery pack.

- Never remove the battery pack/“Memory Stick Duo” when the access lamp is lit. This may cause damage to data in the “Memory Stick Duo”.

3 Turning the camera on/setting the clock

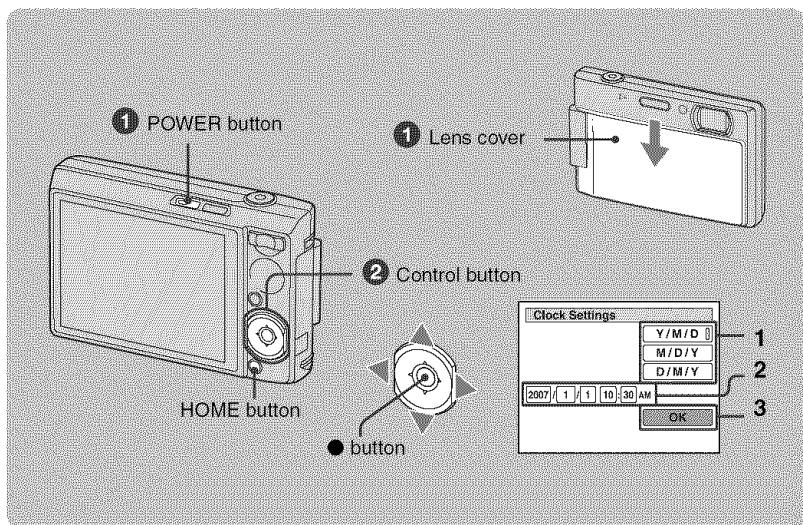

1 Press the POWER button or slide the lens cover downward.

2 Set the clock with the control button.

- 1 Select the date display format with ▲/▼, then press ●.
- 2 Select each item with ◀/▶ and set the numeric value with ▲/▼, then press ●.
- 3 Select [OK], then press ●.

|| To change the date and time

Press the HOME button, and select [⌚ Clock Settings] in [⚙ Settings] (page 17).

|| When you turn on the power

If the camera is running on battery power and you do not operate the camera for about three minutes, the camera turns off automatically to prevent wearing down the battery pack (Auto power-off function).

Shooting images easily (Auto adjustment mode)

The following procedure is for shooting a still image.

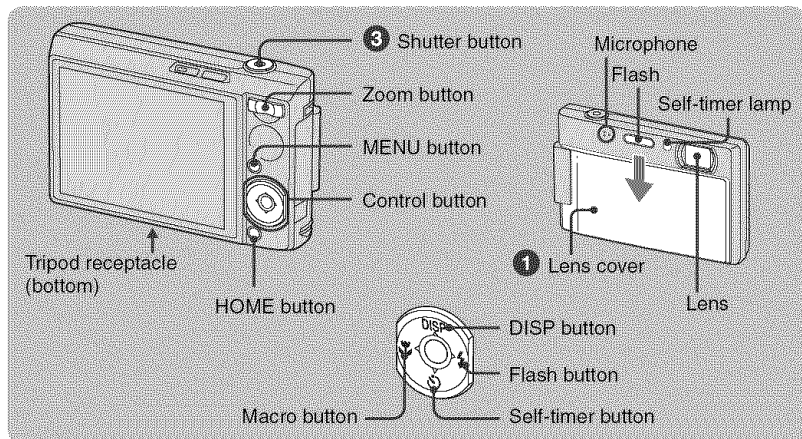

1 Slide the lens cover downward.

2 Hold the camera steady, keeping your arm at your side.

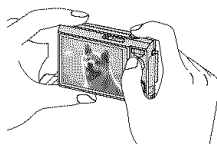

Position the subject in the center of the focus frame.

3 Shoot with the shutter button.

Still image:

1 Press and hold the shutter button halfway down to focus.

The ● (AE/AF lock) indicator (green) flashes, a beep sounds, the indicator stops flashing and remains lit.

2 Press the shutter button fully down.
The shutter sounds.



AE/AF lock indicator

Movie:

Press the HOME button, and select [Movie Mode] in [Shooting] (page 17).

Zoom/Flash/Macro/Self-timer/Display

🔍 Using the zoom

Press 🔍 to zoom, press 🔍 to undo zoom.

⚡ Flash (Selecting a flash mode for still images)

Press ▶ (⚡) on the control button repeatedly until the desired mode is selected.

🔍AUTO: Flash Auto

Strobes when there is insufficient light or backlight (default setting)

⚡: Flash forced on

🔍sl: Slow synchro (Flash forced on)

The shutter speed is slow in a dark place to clearly shoot the background that is out of flash light.

🔍: Flash forced off

🌸 Macro/Close Focus (Shooting close-up)

Press ◀ (🌸) on the control button repeatedly until the desired mode is selected.

🌸OFF: Macro off

🌸: Macro On (W side: Approx. 8 cm or farther (3 1/4 inches or farther), T side: Approx. 80 cm or farther (31 1/2 inches or farther))

🔍: Close focus enabled (Locked to the W side: Approx. 1 to 20 cm (13/32 to 7 7/8 inches))

⌚ Using the self-timer

Press ▼ (⌚) on the control button repeatedly until the desired mode is selected.

⌚OFF: Not using the self-timer

⌚₁₀: Setting the 10-second delay self-timer

⌚₂: Setting the 2-second delay self-timer

Press the shutter button, the self-timer lamp flashes, and a beep sounds until the shutter operates.

DISP Changing the screen display

Press ▲ (DISP) on the control button. Each time you press ▲ (DISP) button, the display changes as follows.

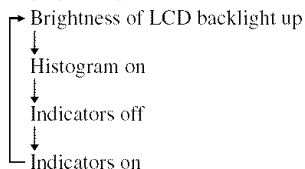

Viewing/deleting images

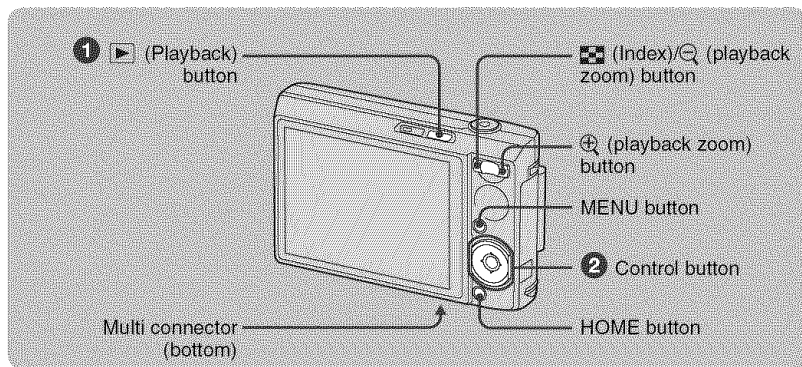

1 Press (Playback).

If you press when the camera is powered off, the camera is turned on automatically and set to playback mode. To switch to the shooting mode, press again.

2 Select an image with / on the control button.

Movie:

Press to play back a movie. (Press again to stop playback.)

Press / to rewind/fast forward. (Press to return to normal playback.)

Press to display the volume control screen, then press / to adjust the volume.

To delete images

1 Display the image you want to delete, then press MENU.

2 Select (Delete) with and select [This Image] with / , then press .

3 Select [OK] with , then press .

To view an enlarged image (playback zoom)

Press while displaying a still image.

To undo the zoom, press .

Adjust the portion: / / /

Cancel playback zoom:

▣ Viewing an index screen

Press **▣** to display the index screen while a still image is displayed.

Then, select an image with **▲/▼/◀/▶**.

To return to the single image screen, press **●**.

- You can also access the index screen by selecting [**▣** Index Display] on the HOME screen.
- Each time you press **▣**, the number of pictures on the index screen changes.

▣ To delete images in index mode

1 Press MENU while the index screen is displayed.

2 Select [Delete] with **▲** and select [Multiple Images] with **◀/▶**, then press **●**.

3 Select the image you want to delete with **▲/▼/◀/▶**, then press **●**.

The **✓** mark is checked in the checkbox of the image.

To cancel a selection, select an image you have selected for deletion, then press **●** again.

4 Press MENU and select [OK] with **▲**, then press **●**.

- To delete all the images in a folder, select [All In This Folder], then press **●** in step 2.

▣ To play back a series of images (Slide Show)

Select [**▣** Slide Show] in **▣** (View Images) on the HOME screen, and then select [OK] with **▲**, then press **●**.

▣ To view images on TV screen

Connect the camera to the TV with the cable for multi-use terminal (supplied).

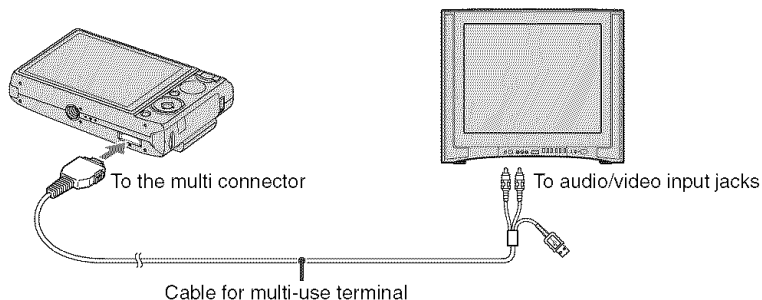

Learning the various functions – HOME/Menu

Using the HOME screen

The HOME screen is the gateway screen for all the functions of your camera. You can select the shooting mode or playback mode, or change the settings from the HOME screen.

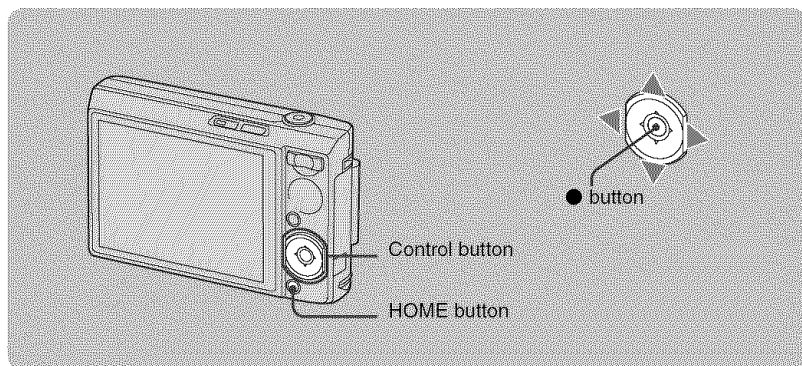

1 Press HOME to display the HOME screen.

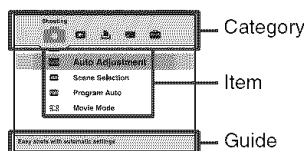

2 Select a category with ◀/▶.

3 Select an item with ▲/▼, then press ●.

When you select the (Manage Memory) or (Settings) category

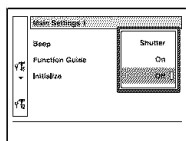
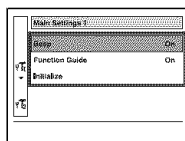
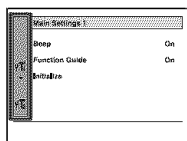

1 Select the desired item with ▲/▼.





• This procedure is needed only when you select (Settings).

2 Move the frame with ▶ and select a setting with ▲/▼, then press ●.

3 Select the desired setting with ▲/▼, then press ●.

HOME screen items

The following categories and items are displayed when you press the HOME button. A description of the selected category or item is displayed on the screen by the guide.

Category	Items
 Shooting	Auto Adjustment Scene Selection Program Auto Movie Mode
 View Images	Single Image Index Display Slide Show
 Printing, Other	Print Music Tool Download Music Format Music
 Manage Memory	Memory Tool Memory Stick Tool Format Change REC.Folder Internal Memory Tool Format Create REC.Folder Copy
 Settings	Main Settings Main Settings 1 Beep Initialize Main Settings 2 USB Connect Video Out Shooting Settings Shooting Settings 1 AF Illuminator AF Mode Shooting Settings 2 Auto Orientation Clock Settings Language Setting Function Guide COMPONENT Grid Line Digital Zoom Auto Review

Using menu items

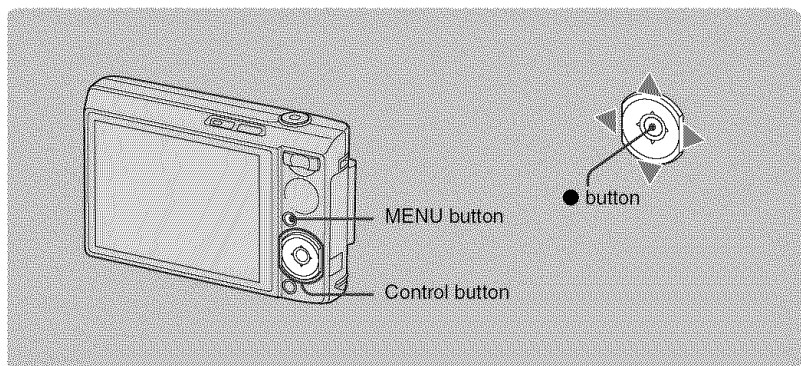

1 Press MENU to display the menu.

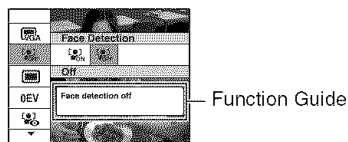

- The menu can be displayed only when the camera is in shooting mode or playback mode.
- Different items are available, depending on the selected mode.

2 Select the desired item with ▲/▼ on the control button.

If the desired item is hidden, keep pressing ▲/▼ until the item appears on the screen.

3 Select the desired setting with ◀/▶ on the control button.

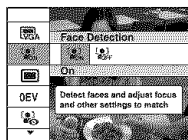

- If the desired item is hidden, keep pressing ◀/▶ until the item appears on the screen.
- Press ● after selecting an item in playback mode.

4 Press MENU to turn off the menu.

Menu items

The available menu items vary depending on the camera mode.







The shooting menu is available only in the shooting mode, and the viewing menu is available only in the playback mode.

Also, different items are available depending on the selected shooting mode (such as Auto Adjustment, Scene Selection, Program Auto, Movie Mode) on the HOME screen.

Menu for shooting

Scene Selection	Selects the preset settings according to the scene.
Image Size	Selects the still image quality.
Face Detection	Detects the faces and adjusts focus and other setting to much.
REC Mode	Selects the continuous shooting method.
Color Mode	Changes the vividness of the image or adds special effects.
ISO	Selects a luminous sensitivity.
EV	Adjusts Exposure.
Metering Mode	Selects the metering mode.
Focus	Changes the focus method.
White Bal	Adjusts the color tones.
Flash Level	Adjusts the amount of flash light.
Red Eye Reduction	Reduces the red-eye phenomenon when using flash.
SteadyShot	Selects the anti-blur mode.
SETUP	Selects shooting settings.

Menu for viewing

 (Delete)	Deletes images.
 (Slide Show)	Plays back a series of images.
 (Retouch)	Retouches images.
 (Protect)	Prevents accidental erasure.
DPOF	Adds a Print order mark.
 (Print)	Prints images using a PictBridge compliant printer.
 (Rotate)	Rotates a still image.
 (Select Folder)	Selects the folder for viewing images.

Enjoying your computer

You can display images shot with the camera on the computer. Also, you can use still images and movies from the camera more than ever by taking advantage of the software. For details, refer to “Cyber-shot Handbook.”

Supported Operating Systems for USB connection and application software (supplied)

	For Windows users	For Macintosh users
USB connection	Windows 2000 Professional, Windows XP Home Edition or Windows XP Professional	Mac OS 9.1/9.2/ Mac OS X(v10.1 to v10.4)
Application software “Picture Motion Browser”	Windows 2000 Professional, Windows XP Home Edition or Windows XP Professional	not compatible

- Must be installed with above OS at delivery.
- If your OS does not support USB connections, use a commercially available Memory Stick Reader/Writer.
- For further details on the operating environment of “Picture Motion Browser” software application for Cyber-shot, refer to “Cyber-shot Handbook.”



Viewing “Cyber-shot Handbook” or “Cyber-shot Step-up Guide”

For Windows users

- 1 Turn on your computer, and insert the CD-ROM (supplied) into the CD-ROM drive. The screen below appears.



When you click the [Cyber-shot Handbook] button, the screen for copying “Cyber-shot Handbook” appears.

- 2 Follow the on-screen instructions to copy. When you click the “Cyber-shot Handbook” button, both the “Cyber-shot Handbook” and the “Cyber-shot Step-up Guide” will be installed.
- 3 After the installation is complete, double-click the shortcut created on the desktop.

For Macintosh users

Turn on your computer and insert the CD-ROM (supplied) into the CD-ROM drive. Follow the instructions below.

To view the “Cyber-shot Handbook”

- 1 Select the [Handbook] folder and copy “Handbook.pdf” stored in the [GB] folder to your computer.
- 2 After copying is complete, double-click “Handbook.pdf”.

To view the “Cyber-shot Step-up Guide”

- 1 In the [stepupguide] folder on the CD-ROM, there is another folder called [stepupguide]. Copy this folder to your computer.
- 2 Select [stepupguide],[language], and then the [GB] folder stored on the CD-ROM. Copy all the files in the [GB] folder on the CD-ROM, then use them to overwrite the files in the [img] folder stored in the [stepupguide] folder which was copied to your computer in step 1.
- 3 After copying is complete, double-click “stepupguide.hqx” in the [stepupguide] folder to uncompress it, then double-click the generated file “stepupguide”.
 - If an uncompress tool for HQX file is not installed, install the Stuffit Expander.

Indicators on the screen

Each time you press ▲ (DISP) button, the display changes (page 14).

When shooting still images

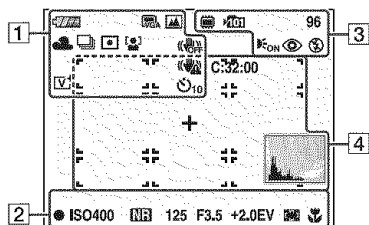

When shooting movies

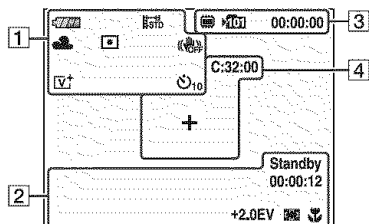



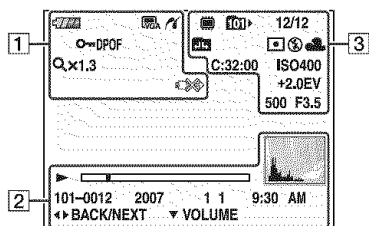



When playing back





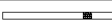
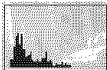







	Battery remaining
	Low battery warning
	Image size
	Shooting mode (Scene Selection)
	Shooting mode (Program)
	White balance
	Recording mode
	Metering mode
	Face Detection
	SteadyShot
	Vibration warning
	Self-timer
	Protect
	Print order (DPOF) mark
	PictBridge connecting
	Zoom scaling
	Zoom scaling
	Color mode
	Volume
	PictBridge connecting

2





1.0m	Focus preset distance
	AE/AF lock
ISO400	ISO number
	NR slow shutter
125	Shutter speed
F3.5	Aperture value
+2.0EV	Exposure Value
	AF range finder frame indicator
	Macro/Close Focus
	Playback
	Playback bar
Standby REC	Standby/Recording a movie
00:00:12	Recording time
	Histogram •  appears when histogram display is disabled.
101-0012	Folder-file number
2007 1 1 9:30 AM	Recorded date/time of the playback image
● STOP ● PLAY	Guide to play back images
◀▶ BACK/ NEXT	Select images
▼ VOLUME	Adjust volume

3

	Recording/Playback media
	Recording folder
	Playback folder
96	Remaining number of recordable images
12/12	Image number/Number of images recorded in selected folder
00:00:00	Remaining recordable time
	Change folder
	AF illuminator

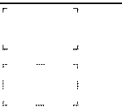
	Red-eye reduction
	Metering mode
	Flash mode
	Flash charging
	White balance
C:32:00	Self-diagnosis display
ISO400	ISO number
+2.0EV	Exposure Value
500	Shutter speed
F3.5	Aperture value

4

C:32:00	Self-diagnosis display
	AF range finder frame
	Spot metering cross hair
	Histogram •  appears when histogram display is disabled.

Battery life and memory capacity

Battery life and number of images that can be recorded/viewed

The tables show the approximate number of images that can be recorded/viewed and the battery life when you shoot images in [Normal] mode with the battery pack at full capacity and at an ambient temperature of 25°C (77°F). The numbers of images that can be recorded or viewed take into account changing the “Memory Stick Duo” as necessary.

Note that the actual numbers may be less than those indicated in the table depending on the conditions of use.

- Battery capacity decreases as you use it more, as the time passes.
- The number of images that can be recorded/viewed and the battery life are decreased under the following conditions:
 - The surrounding temperature is low.
 - The flash is used frequently.
 - The camera has been turned on and off many times.
 - The zoom is used frequently.
 - The brightness of LCD Backlight is set to up.
 - [AF Mode] is set to [Monitor].
 - [SteadyShot] is set to [Continuous].
 - The battery power is low.
 - [Face Detection] is set to [On].

When shooting still images

No. of Images	Battery life (min.)
Approx. 340	Approx. 170

- Shooting in the following situations:
 - [AF Mode] is set to [Single].
 - [SteadyShot] is set to [Shooting].
 - Shooting once every 30 seconds.
 - The zoom is switched alternately between the W and T ends.
 - The flash strobes once every two times.
 - The power turns on and off once every ten times.

- The measurement method is based on the CIPA standard.
(CIPA: Camera & Imaging Products Association)
- The number of images/battery life does not change, regardless of image size.

When viewing still images

No. of Images	Battery life (min.)
Approx. 6600	Approx. 330

- Viewing single images in order at about three second intervals

When shooting movies

Battery life (min.)
Approx. 140

- Shooting movies continuously with an image size of [320]

Number of still images and recording time of movies

The number of still images and the length of time available for recording movies may vary, depending on the shooting conditions and/or the recording media used.

- You can select the image size to be used when shooting from the menu (page 19, 20).

|| The approximate number of still images

(Units: Images)

Capacity Size	Internal memory	"Memory Stick Duo" formatted with this camera						
	Approx. 31 MB	128 MB	256 MB	512 MB	1 GB	2 GB	4 GB	8 GB
8M	10	40	72	148	302	620	1225	2457
3:2	10	40	72	148	302	620	1225	2457
5M	13	51	92	188	384	789	1559	3127
3M	21	82	148	302	617	1266	2501	5017
VGA	202	790	1428	2904	5928	12154	24014	48166
16:9	33	133	238	484	988	2025	4002	8027

- The number of images listed is for when [REC Mode] is set to [Normal].
- When the number of remaining shootable images is greater than 9,999, the ">9999" indicator appears.

|| The approximate recording time of movies

(Units: hour : minute : second)

Capacity Size	Internal memory	"Memory Stick Duo" formatted with this camera						
	Approx. 31 MB	128 MB	256 MB	512 MB	1 GB	2 GB	4 GB	8 GB
640(Fine)	—	—	0:02:50	0:06:00	0:12:20	0:25:10	0:50:00	1:40:20
640(Standard)	0:01:30	0:05:50	0:10:40	0:21:40	0:44:20	1:31:00	3:00:00	6:01:10
320	0:06:00	0:23:40	0:42:50	1:27:00	2:57:50	6:04:30	12:00:20	24:04:50

- Movies with the size set to [640(Fine)] can only be recorded on a "Memory Stick PRO Duo".
- The size of a movie file is limited to approx. 2 GB.
During recording, movie recording stops automatically when the file size of the movie reaches approx. 2 GB.
- This camera does not support HD recordings or playbacks for movies.
- When images recorded using earlier Sony models are played back on this camera, the display may differ from the actual image size.

Troubleshooting

If you experience trouble with your camera, try the following solutions.

1 Check the items below, and refer to “Cyber-shot Handbook (PDF)”.

If a code such as “C/E:□□:□□” appears on the screen, refer to “Cyber-shot Handbook”.

2 Remove the battery pack, and insert the battery pack again after about one minute, and turn on the power.

3 Initialize the settings (page 18).

4 Consult your Sony dealer or local authorized Sony service facility.

Please understand that you give your consent that the contents of the internal memory, Music files may be checked when you send your camera to be repaired.

Battery pack and power

The battery pack cannot be installed.

- Install the battery pack correctly using the tip of the battery pack to push the battery eject lever (page 10).

Cannot turn on the camera.

- After installing the battery pack into the camera, it may take a little while to get the camera powered.
- Install the battery pack correctly (page 10).
- The battery pack is discharged. Install charged battery pack (page 9).
- The battery pack is dead. Replace it with a new one.
- Use a recommended battery pack (page 8).

The power turns off suddenly.

- If you do not operate the camera for about three minutes while the power is on, the camera turns off automatically to prevent wearing down the battery pack. Turn on the camera again (page 12).
- The battery pack is dead. Replace it with a new one.

The battery remaining indicator is incorrect.

- This phenomenon occurs when you use the camera in an extremely hot or cold location.
- The displayed battery remaining differs from the current one. Fully discharge and then charge the battery pack to correct the display.
- The battery pack is discharged. Install the charged battery pack (page 9).
- The battery pack is dead. Replace it with a new one.

Cannot charge the battery pack

- You cannot charge the battery pack using the AC Adapter (not supplied).

Shooting still images/movies

Your camera cannot record images.

- Check the free capacity of the internal memory or “Memory Stick Duo” (page 26). If it is full, do one of the following:
 - Delete unnecessary images (page 15).
 - Change the “Memory Stick Duo”.
- You are using the “Memory Stick Duo” with the write-protect switch, and the switch is set to the LOCK position. Set the switch to the recording position.
- You cannot record images while charging the flash.
- Select a shooting mode other than the [Movie Mode] using the HOME screen when shooting still images.
- Select [Movie Mode] using the HOME screen when shooting movies.
- The image size is set to [640(Fine)] when recording movies. Do one of the following:
 - Set the image size to other than [640(Fine)].
 - Insert a “Memory Stick PRO Duo”.

Cannot insert dates on images.

- This camera does not have a feature for superimposing dates on images. You can print or save images with the date inserted using “Picture Motion Browser”.

Vertical streaks appear when you are shooting a very bright subject.

- The smear phenomenon is occurring and white, black, red, or purple streaks appear on the image. This phenomenon is not a malfunction.

Viewing images

Your camera cannot play back images.

- Press  (Playback) (page 15).
- The folder/file name has been changed on your computer.
- When an image file has been processed by a computer or when the image file was recorded using a model other than that of your camera, playback on your camera is not guaranteed.
- The camera is in USB mode. Delete the USB connection.

Precautions

Do not use/store the camera in the following places

- In an extremely hot, cold or humid place
In places such as in a car parked in the sun, the camera body may become deformed and this may cause a malfunction.
- Under direct sunlight or near a heater
The camera body may become discolored or deformed, and this may cause a malfunction.
- In a location subject to rocking vibration
- Near strong magnetic place
- In sandy or dusty places
Be careful not to let sand or dust get into the camera. This may cause the camera to malfunction, and in some cases this malfunction cannot be repaired.

On carrying

Do not sit down in a chair or other place with the camera in the back pocket of your trousers or skirt, as this may cause malfunction or damage the camera.

On cleaning

Cleaning the LCD screen

Wipe the screen surface with an LCD cleaning kit (not supplied) to remove fingerprints, dust, etc.

Cleaning the lens

Wipe the lens with a soft cloth to remove fingerprints, dust, etc.

Cleaning the camera surface

Clean the camera surface with a soft cloth slightly moistened with water, then wipe the surface with a dry cloth. Do not use the following as they may damage the finish or the casing.

- Chemical products such as thinner, benzene, alcohol, disposable cloths, insect repellent, sunscreen or insecticide, etc.
- Do not touch the camera with the above on your hand.
- Do not leave the camera in contact with rubber or vinyl for a long time.

On operating temperatures

Your camera is designed for use under the temperatures between 0°C and 40°C (32°F and 104°F). Shooting in extremely cold or hot places that exceed this range is not recommended.

On moisture condensation

If the camera is brought directly from a cold to a warm location, moisture may condense inside or outside the camera. This moisture condensation may cause a malfunction of the camera.

If moisture condensation occurs

Turn off the camera and wait about an hour for the moisture to evaporate. Note that if you attempt to shoot with moisture remaining inside the lens, you will be unable to record clear images.

On the internal rechargeable backup battery

This camera has an internal rechargeable battery for maintaining the date and time and other settings regardless of whether the power is on or off.

This rechargeable battery is continually charged as long as you are using the camera. However, if you use the camera for only short periods, it discharges gradually, and if you do not use the camera at all for about one month it becomes completely discharged. In this case, be sure to charge this rechargeable battery before using the camera.

However, even if this rechargeable battery is not charged, you can still use the camera as long as you do not record the date and time.

Charging method of the internal rechargeable backup battery

Insert charged battery pack in the camera, and then leave the camera for 24 hours or more with the power off.

Specifications

Camera

[System]

Image device: 7.18 mm (1/2.5 type) color CCD,
Primary color filter
Total pixel number of camera:
Approx. 8 286 000 pixels
Effective pixel number of camera:
Approx. 8 083 000 pixels
Lens: Carl Zeiss Vario-Tessar 5× zoom lens f =
5.8 – 29.0 mm (35 – 175 mm when converted
to a 35 mm still camera) F3.5 – 4.4
Exposure control: Automatic exposure, Scene
Selection (9 modes)
White balance: Automatic, Daylight, Cloudy,
Fluorescent 1, Fluorescent 2, Fluorescent 3,
Incandescent, Flash
File format (DCF compliant):
Still images: Exif Ver. 2.21 JPEG compliant,
DPOF compatible
Movies: MPEG1 compliant (Monaural)
Recording media: Internal Memory (approx.
31 MB), “Memory Stick Duo”
Flash: Flash range (ISO (Recommended Exposure
Index) set to Auto): approx. 0.1 to 3.7 m
(4 inches to 12 feet 1 3/4 inches) (W/
approx. 0.8 to 2.9 m (2 feet 7 1/2 inches to
9 feet 6 1/4 inches) (T)

[Input and Output connectors]

Multi connector:
Video output
Audio output (mono)
USB communication
USB communication:
Hi-Speed USB (USB 2.0 compliant)

[LCD screen]

LCD panel: 7.5 cm (3.0 type) TFT drive
Total number of dots: 230 400 (960×240) dots

[Power, general]

Power:
Rechargeable battery pack NP-BG1, 3.6 V
AC-LS5K AC Adaptor (not supplied), 4.2 V
Power consumption (during shooting): 1.1 W
Operating temperature: 0 to 40°C (32 to 104°F)
Storage temperature: –20 to +60°C (–4 to +140°F)
Dimensions: 91.8×59.2×22.3 mm
(3 5/8×2 3/8×29/32 inches)
(W/H/D, excluding protrusions)
Mass: Approx. 172 g (6.1 oz) (including NP-BG1
battery pack and wrist strap, etc.)
Microphone: Monaural
Speaker: Monaural
Exif Print: Compatible
PRINT Image Matching III: Compatible
PictBridge: Compatible

BC-CSG/BC-CSGB/BC-CSGC battery charger

Power requirements: AC 100 to 240 V, 50/60 Hz,
2 W (BC-CSG/BC-CSGC)/ 2.6 W (BC-
CSGB)
Output voltage: DC 4.2 V, 0.25 A
Operating temperature: 0 to 40°C (32 to 104°F)
Storage temperature: –20 to +60°C (–4 to
+140°F)
Dimensions: Approx. 62×24×91 mm (2 1/2×
31/32×3 5/8 inches) (W/H/D)
Mass: Approx. 75 g (2.7 oz)

Rechargeable battery pack NP- BG1

Used battery: Lithium-ion battery
Maximum voltage: DC 4.2 V
Nominal voltage: DC 3.6 V
Capacity: 3.4 Wh (960 mAh)

Design and specifications are subject to change
without notice.

Trademarks

- **Cyber-shot** is a trademark of Sony Corporation.
- “Memory Stick”,  “Memory Stick PRO”, **MEMORY STICK PRO**, “Memory Stick Duo”, **MEMORY STICK DUO**, “Memory Stick PRO Duo”, **MEMORY STICK PRO DUO**, “Memory Stick Micro”, “MagicGate”, and **MAGIC GATE** are trademarks of Sony Corporation.
- Microsoft, Windows and DirectX are either registered trademarks or trademarks of Microsoft Corporation in the United States and/or other countries.
- Macintosh, Mac OS, iMac, iBook, PowerBook, Power Mac and eMac are trademarks or registered trademarks of Apple Computer, Inc.
- Intel, MMX, and Pentium are trademarks or registered trademarks of Intel Corporation.
- Google is a registered trademark of Google Inc.
- In addition, system and product names used in this manual are, in general, trademarks or registered trademarks of their respective developers or manufacturers. However, the TM or © marks are not used in all cases in this manual.

Additional information on this product and answers to frequently asked questions can be found at our Customer Support Website.

<http://www.sony.net/>



Printed on 70% or more recycled paper using VOC (Volatile Organic Compound)-free vegetable oil based ink.

Printed in Japan



2319290120