

# Appendix C



## Drawer Dishwasher Use & Care Guide

Models: 465.1332\*, 465.1333\*, 465.1334\*

\* = color number

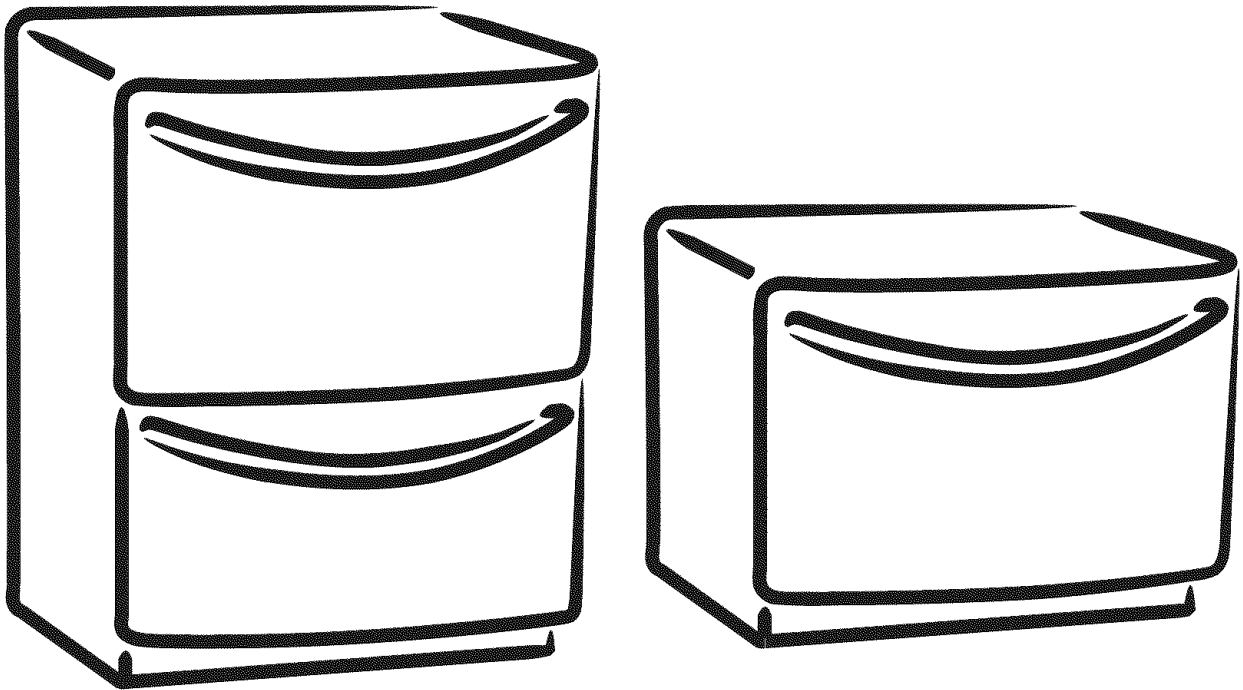

# CONTENTS

---

	Important Safety Instructions .....	2
	Warranty and Protection Agreements .....	3-4
	Parts and Features .....	5
	Start Up Guide .....	6
	Loading .....	7-8
	Dishwasher Recommendations .....	9-10
	Cycles, Options and Lights .....	11-14
	Dishwasher Safe Items .....	15
	Care and Cleaning .....	16-18
	Troubleshooting .....	19-20
	Guía de uso y cuidado .....	22
	Guide d'utilisation et d'entretien .....	43



# IMPORTANT SAFETY INSTRUCTIONS

## What You Need to Know About Safety Instructions

Danger, Warning and Important Safety Instructions appearing in this guide are not meant to cover all possible conditions and situations that may occur. Common sense, caution and care must be exercised when installing, maintaining or operating the dishwasher.

*Always* contact your manufacturer about problems or conditions you do not understand.

### Recognize Safety Symbols, Words, Labels

#### DANGER

**DANGER** – Immediate hazards which **WILL** result in severe personal injury or death.

#### WARNING

**WARNING** – Hazards or unsafe practices which **COULD** result in severe personal injury or death.

#### CAUTION

**CAUTION** – Hazards or unsafe practices which **COULD** result in minor personal injury.

## Important Safety Instructions

#### WARNING

Check with the installer to make sure the appliance has been properly grounded to avoid possible electrical shock. Be sure you read the important personal safety instructions *before* you use this dishwasher.

Products with a  label have been listed with Underwriter’s Laboratories, Inc. – those with a CSA tag have been listed with Canadian Standards Association. Nevertheless, as with any other equipment using electricity and moving parts, there is a potential hazard.

#### WARNING

**When using your dishwasher, follow basic precautions, including the following:**

1. Read all instructions *before* using the dishwasher.
2. Use the dishwasher only for its intended function.
3. Disconnect electrical power to dishwasher *before* attempting to service.
4. To avoid electrical shock hazard, the sides and back must be enclosed and the front panels must

be attached *before* electrical power is applied to the dishwasher. Refer to the installation instructions for proper grounding procedures.

5. Connect to a properly rated, protected and sized power supply circuit to avoid electrical overload.
6. Children **should never** be permitted to operate, play in, with, or around this dishwasher.
7. **Do not** operate the dishwasher unless all enclosed panels are properly in place.
8. To reduce the risk of injury when loading items to be washed, sharp or pointed items should be located with the handles up. Also, load sharp items so they are not likely to damage the drawer seal.
9. Use only detergents and rinse additives designed for a residential automatic dishwasher. **Never** use soap, laundry detergent, or hand washing detergent in your dishwasher. Keep these products out of reach of children.
10. **Do not** sit, stand on or abuse the drawer(s) or dish rack(s) of the dishwasher.
11. Under certain conditions, hydrogen gas may be produced in a hot water system that has not been used for two weeks or more. **HYDROGEN GAS IS EXPLOSIVE.** If the hot water system has not been used for such a period, turn on all hot water faucets and let the water flow from each for several minutes. This will release any accumulated hydrogen gas. As the gas is flammable, **do not** smoke or use an open flame during this process.
12. **Do not** wash plastic items unless marked “dishwasher safe” or the equivalent. For plastic items not so marked, check the manufacturer’s recommendations.
13. **Do not** tamper with controls.
14. To prevent accidental child entrapment and suffocation risks, *always* remove the drawers to the washing compartment when removing an old dishwasher from service or discarding it.
15. Use caution when unloading the dishwasher. Dishes may be hot if unloaded shortly after a cycle has completed.
16. Certified residential dishwashers are NOT intended for licensed food establishments.
17. To avoid water, mold or mildew damage to your home, inlet and drain hose connections should be checked periodically for leaks.

## Save These Instructions for Future Reference



# WARRANTY

## KENMORE ELITE® APPLIANCE WARRANTY

### ONE YEAR LIMITED WARRANTY

When installed, operated and maintained according to all instructions supplied with the product, if this appliance fails due to a defect in material or workmanship within one year from the date of purchase, call 1-800-4-MY-HOME® to arrange for free repair.

### FIVE-YEAR LIMITED WARRANTY ON DRAWER RACKS

For five years from the date of purchase, when this appliance is installed, operated and maintained according to all instructions supplied with the product, Sears will replace parts for the drawer racks if they rust due to defective materials or workmanship. After the first year, customer assumes any labor costs associated with rack replacement.

If this appliance is used for other than private family purposes, this warranty applies for only 90 days from the date of purchase.

### THIS WARRANTY COVERS ONLY DEFECTS IN MATERIAL AND WORKMANSHIP. SEARS WILL NOT PAY FOR:

1. Expendable items that can wear out from normal use, including but not limited to filters, belts, light bulbs, and bags.
2. A service technician to instruct the user in correct product installation, operation or maintenance.
3. A service technician to clean or maintain this product.
4. Damage to or failure of this product if it is not installed, operated or maintained according to all instructions supplied with the product.
5. Damage to or failure of this product resulting from accident, abuse, misuse or use for other than its intended purpose.
6. Damage to or failure of this product caused by the use of detergents, cleaners, chemicals or utensils other than those recommended in all instructions supplied with the product.
7. Damage to or failure of parts or systems resulting from unauthorized modifications made to this product.

### DISCLAIMER OF IMPLIED WARRANTIES; LIMITATION OF REMEDIES

Customer's sole and exclusive remedy under this limited warranty shall be product repair as provided herein. Implied warranties, including warranties of merchantability or fitness for a particular purpose, are limited to one year or the shortest period allowed by law. Sears shall not be liable for incidental or consequential damages. Some states and provinces do not allow the exclusion or limitation of incidental or consequential damages, or limitations on the duration of implied warranties of merchantability or fitness, so these exclusions or limitations may not apply to you.

This warranty applies only while this appliance is used in the United States and Canada. This warranty gives you specific legal rights, and you may also have other rights which vary from state to state.

**Sears, Roebuck and Co., Hoffman Estates, IL 60179**

**Sears Canada Inc., Toronto, Ontario, Canada M5B 2B8**

### PRODUCT RECORD

In the space below, record your complete model number, serial number, and purchase date. You can find this information on the model and serial number label, located as shown in the *Parts and Features* section on page 5. Have this information available to help you quickly obtain assistance or service when you contact Sears concerning your appliance.

Model number 465 \_\_\_\_\_

Serial number \_\_\_\_\_

Purchase date \_\_\_\_\_

**Save these instructions and sales receipt  
for future reference.**



# PROTECTION AGREEMENTS

## In the USA

### Master Protection Agreements

*Congratulations on making a smart purchase.* Your new Kenmore Elite® product is designed and manufactured for years of dependable operation. But like all products, it may require preventive maintenance or repair from time to time. That's when having a Master Protection Agreement can save you money and aggravation.

*Purchase a Master Protection Agreement now and protect yourself from unexpected hassle and expense.*

The Master Protection Agreement also helps extend the life of your new product. Here's what's included in the Agreement:

- ✓ **Expert service** by our 12,000 professional repair specialists
- ✓ **Unlimited service and no charge** for parts and labor on all covered repairs
- ✓ **"No-lemon" guarantee** – replacement of your covered product if four or more product failures occur within twelve months
- ✓ **Product replacement** if your covered product can't be fixed
- ✓ **Annual Preventive Maintenance Check** at your request – no extra charge
- ✓ **Fast help by phone** – phone support from a Sears representative on products requiring in-home repair, plus convenient repair scheduling
- ✓ **Power surge protection** against electrical damage due to power fluctuations
- ✓ **Rental reimbursement** if repair of your covered product takes longer than promised

Once you purchase the Agreement, a simple phone call is all that it takes for you to schedule service. You can call anytime day or night, or schedule a service appointment online.

Sears has over 12,000 professional repair specialists, who have access to over 4.5 million quality parts and accessories. That's the kind of professionalism you can count on to help prolong the life of your new purchase for years to come. Purchase your Master Protection Agreement today!

**Some limitations and exclusions apply. For prices and additional information, call 1-800-827-6655.**

### Sears Installation Service

*For Sears professional installation of home appliances, garage door openers, water heaters, and other major home items, in the USA call **1-800-4-MY-HOME**® (1-800-469-4663).*

## In Canada

### Maintenance Agreements

Your purchase has added value because you can depend on Sears HomeCentral® for service. With over 2,400 Service Technicians and more than a million parts and accessories, we have the tools, parts, knowledge and skills to back our pledge; We Service What We Sell.

Your Kenmore® product is designed, manufactured and tested to provide years of dependable operation. But like all products, it may require service from time to time. The Sears Maintenance Agreement offers you an outstanding service program, affordably priced.

#### The Sears Maintenance Agreement:

- Is your way to buy tomorrow's service at today's price
- Eliminates repair bills resulting from normal wear and tear
- Provides phone support from a Sears representative on products requiring in-home repair
- Even if you don't need repairs, this agreement provides an annual Preventive Maintenance Check, at your request, to ensure that your product is in proper running condition.

**Some limitations apply. For more information about Sears Canada Maintenance Agreements, call 1-800-361-6665.**



# PARTS AND FEATURES

This guide covers several different models. The features on your dishwasher may vary from those shown below.

- A. Left side rack
- B. Fold-down utility shelf
- C. Middle rack
- D. Right side rack
- E. Upper wash arm paddle (select models)
- F. Wash manifold
- G. Spray arm
- H. Coarse filter cup
- I. Coarse filter plate
- J. Detergent dispenser (inside front drawer)
- K. Rinse aid (inside front drawer)
- L. Utensil basket
- M. Control panel (on drawer top edge)
- N. Indicator lights (select models)
- O. Model and serial number (on side of drawer)
- P. One-piece rack
- Q. Fold-down utility shelf
- R. Plate tine insert

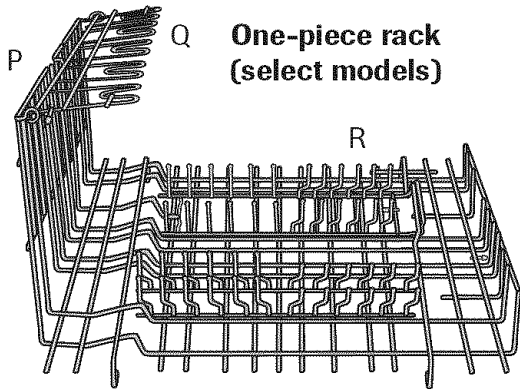
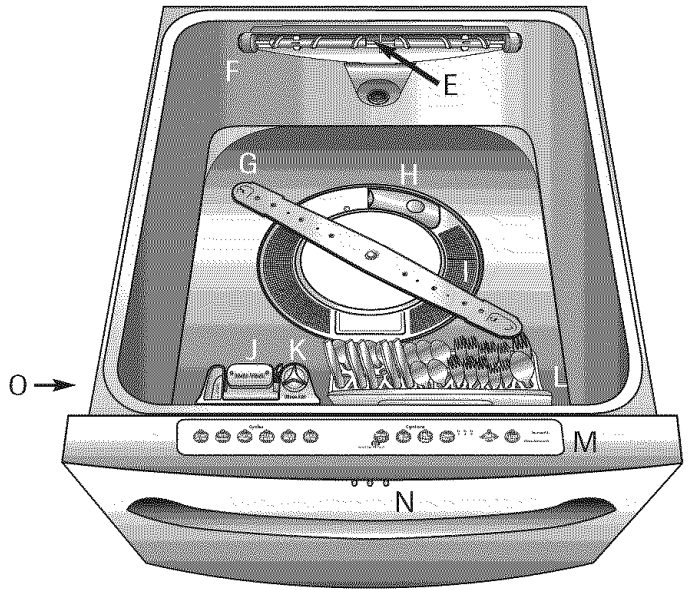
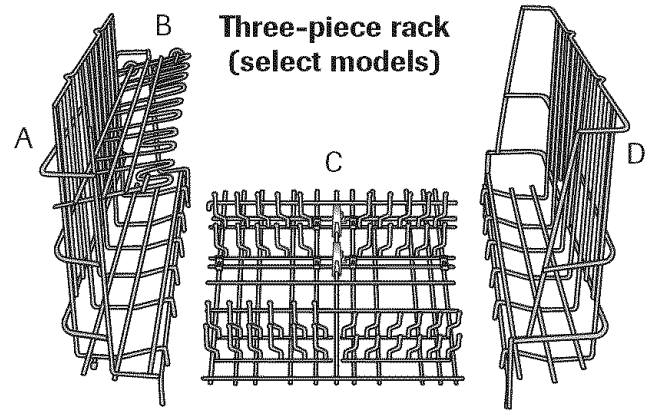

## Control Panels\*

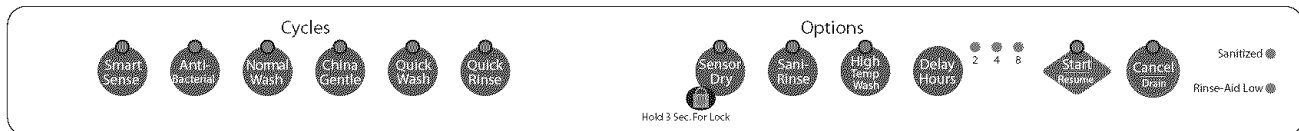

\*Styles and features may vary by model.



# START UP GUIDE

## Before You Start

- **Do not** pre-rinse. Simply scrape off any bones or large food particles.
- If you have a food waste disposer make certain that the disposer is empty *before* starting the dishwasher.
- Periodically check the coarse filter cup and empty if necessary *before* starting the dishwasher (see page 17).
- Scrape off tomato-based food soils (see page 16).
- Remove certain foods such as mustard, mayonnaise, lemon juice, vinegar, salt or dressings from stainless steel flatware as soon as possible. These foods may cause rusting and pitting if allowed to remain in contact with the surface of the flatware for an extended period of time.

## Rinse Aid

**Important: This dishwasher is designed to use a liquid rinse aid. Rinse aid greatly improves drying, reduces spotting and filming, and reduces moisture left on the dishwasher interior by creating a “sheeting” action. Water “sheets” off dishes, preventing drops of water from remaining on dishes and creating spots. Drying performance will improve after several washes using rinse aid.**

An automatic rinse aid dispenser is located next to the detergent cup.

An illuminated light on the control panel indicates when the rinse aid reservoir needs to be refilled. Check the dispenser monthly. To fill and adjust the amount of rinse aid dispensed into the dishwasher, see page 10.

## Hot Water

For optimal cleaning and drying results, hot water is necessary. The incoming water temperature should be 120° F (49° C) to properly activate the detergent and melt greasy food soils.

To check the incoming water temperature, turn on the hot water faucet nearest the dishwasher and let it run into a glass in the sink. Place a candy thermometer in the glass and check the temperature once it has stopped rising.

## Starting the Dishwasher

1. Check that the coarse filter cup is securely in place (see page 17).
2. Load the dishwasher and add detergent.
3. Select the desired cycle and options by pressing the pads on the control panel. The indicator lights for the

selected cycle and options will illuminate. To cancel a cycle or select another cycle, press the **Cancel/Drain** pad. To cancel an option, press the option pad again, or press the **Cancel/Drain** pad.

4. To start a cycle, press the **Start/Resume** pad *once*, then close the drawer. After a brief pause, the cycle will begin. To prevent unplanned cycle or option changes, these selections are “locked in” after the initial fill is complete.

### Notes:

- If Start/Resume is not pressed within 30 seconds of choosing a cycle, the dishwasher will turn off.
- Press the **Start/Resume** pad *once*, then close the drawer. Drawer must be closed within 3 seconds after pushing Start/Resume or the lights will flash and the audio alarm sound will be heard. After closing the drawer there will be a brief pause before the cycle begins.

The dishwasher remembers your last cycle so you do not have to reset the cycle each time. To start the dishwasher using the same cycle and options selected on the previous wash, just press the **Start/Resume** pad.

5. To cancel a running cycle, press the **Cancel/Drain** pad *once*. The dishwasher will drain, then shut off. To turn the dishwasher off without draining, press the **Cancel/Drain** pad *twice*.

### Notes:

- If a cycle pad is pressed after the controls have been “locked in”, the light above the current cycle will flash three times and an audible beep will be heard.
- If you have a two-drawer dishwasher model, each drawer has its own controls and can run independently of the other.

## Adding a Forgotten Item

For best cleaning, the forgotten item should be added early in the cycle.

1. Grasp drawer handle and open drawer. An audible beep will sound to indicate the drawer is open and the cycle has been suspended.
2. With the drawer open, add the item.
3. Press **Start/Resume** then close the drawer.

**Note:** Extended interruption of the wash cycle is not recommended.

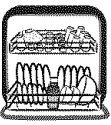

# LOADING

## General Recommendations

- Items can be centered behind a single tine or loaded at an angle to maximize space.
- Avoid blocking or preventing the spray arms from spinning freely. **Do not** allow items to extend beyond the racks.
- Face soiled surfaces toward the center of the dishwasher.
- **Do not** load anything above the inside top edge of the drawers. This rack can accommodate items up to 11" (25.4 cm) in height.

For best dishwashing results follow guidelines on the following pages to determine the best arrangement for your items.

**Important: Do not** remove the racks from the dishwasher drawer when loaded with dishes.

## Recommended Drawer Loading

If you have a two-drawer dishwasher model, each drawer has its own controls and can run independently of the other. For a 10 pc. place setting load, a two-drawer dishwasher model is required. A single drawer can hold a 5 pc. place setting load.

For a two-drawer 10 pc. place setting load, see recommended loading images below. For a single drawer appliance, either loading image may be used.

Upper Drawer

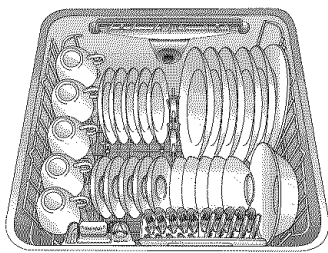

Lower Drawer

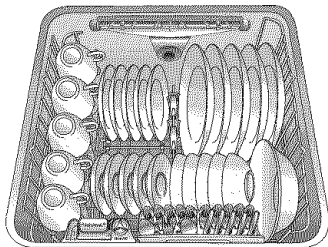

AHAM-10 pc. place setting

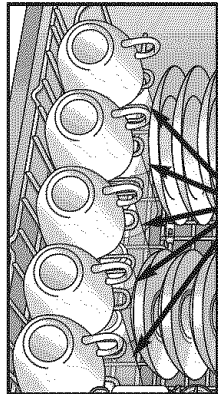

Five glasses loaded under the utility shelf.

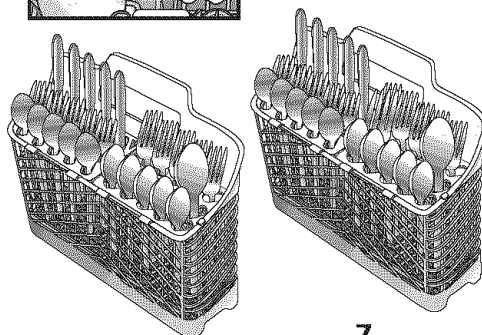

Glasses, cups, stemware, light-weight plastics, plates, bowls, pans, long-handled utensils etc. can be loaded in either rack. **Do not load glasses over the tines.**

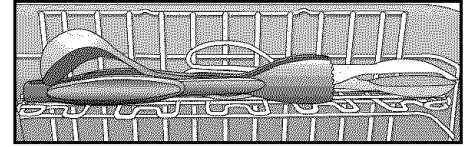

The utility shelf on the left side of the rack folds up or down for loading flexibility. Fold it *down* to hold long-handled knives, spatulas and spoons or short items like cups or juice glasses. Fold it *up* for taller items such as glasses, bowls, plates, etc. The edge of the utility shelf is designed to hold stemware in place.

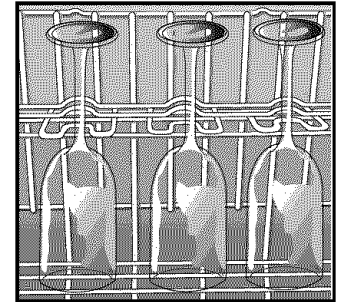
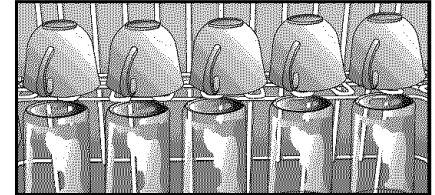

## Drawer Loading Options

A variety of items such as dinner plates, mixing bowls, pots, pans and baking dishes can be loaded in the rack.

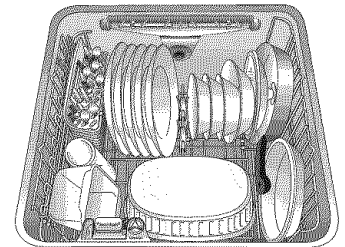
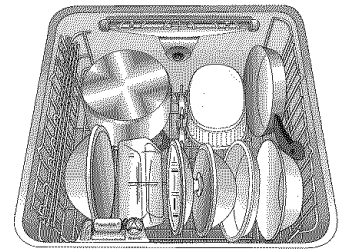



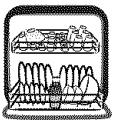

# LOADING

## Variable Tines (select models)

Variable tines, located in the back half of the drawer, provide convenient loading space for almost any sized item. Positioning the tines flat or splayed out creates adequate room for large, bulky items like pots and pans or mixing bowls. Angling tines out accommodates up to 12" plates.

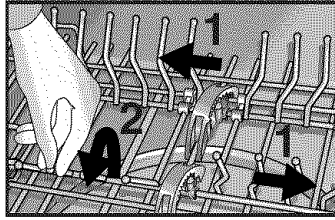

### To position tines:

1. Carefully pull back on the last tine until notches are removed from the clip.
2. Rotate tine forward into the notches that best fit the size of the dish.
3. Release tine to lock into place.

## Sliding Tines (select models)

Sliding tines, located in the front half of the drawer, can be adjusted to provide narrow spacing for loading plates or wide spacing for loading deep bowls, pots or pans. Slide one or both sets of tines toward the back or front of the drawer for narrow or wider spacing. Leave proper spacing between the items in sliding and variable tines (select models) for increased wash performance.

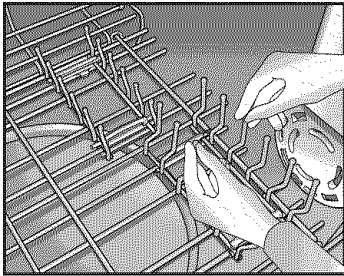

## Utensil Basket

For optimum wash performance the utensil basket should be placed along the front of the drawer with the handle against the tub. Load the basket while it is in the rack or take the basket out for loading on a counter or table.

Place small items like baby bottle caps, jar lids, corn cob holders, etc., in a covered section (select models). Close the cover to hold small items in place.

Be sure that *nothing* protrudes through the bottom of basket or rack to block the spray arm.

To avoid damaging the silver finish, **do not** mix silver and stainless.

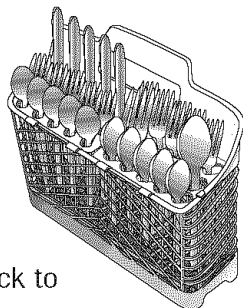

When covers (select models) are folded down flat against the basket, mix items in each section of the basket with some handles pointing up and some with handles down. Load knives, handles up and spoons and forks handles down.

### CAUTION

Load sharp items (knives, skewers, etc.) pointing down. Failure to do so may result in injury.

## Sabbath Guidelines (select models)

For those who observe Kosher dietary guidelines, Star-K has certified that the drawers in the 2-drawer model are separate and therefore one drawer can be designated to wash utensils used for dairy, while the other can be designated for washing meat utensils. **HOWEVER, NEITHER DRAWER CAN BE USED TO WASH DISHES ON THE SABBATH OR HOLIDAYS!**

### Storage of dishes

Although washing of dishes with the drawer dishwasher is not permitted on the Sabbath or on holidays, storage of dishes is possible by following the guidelines listed below.

### Deactivation of controls:

To deactivate the audible tones and lights, see page 10 and follow the instructions under *Rinse Aid/Audible Feedback Adjustment Mode*.

- To deactivate the visual indicator lights, level "0" should be selected for the Rinse Aid dispenser level.
- To deactivate the audible feedback, both Delay Hours option lights should be turned to **OFF**.
- If the Child Lock feature has been set, this will also need deactivation. See page 12 for further instructions.

### Reactivation of controls after the Sabbath:

To reactivate the controls, repeat the process from page 10 and select the desired rinse aid and audio feedback levels. For reactivation of the Child Lock feature, see page 12.

**Important:** Care should be taken when opening the drawer(s) and loading dishes while in the disabled mode as an accidental key press could activate the indicator lights.

### Notes:

- If needed, be sure to allow enough time to run a cleaning cycle prior to the start of the Sabbath.
- Clean dishes should be unloaded from the drawer dishwasher prior to setting the controls for the Sabbath to prevent activation of the indicator lights.



# DISHWASHER RECOMMENDATIONS

## Detergent

Use a detergent designed specifically for use in an automatic dishwasher. Be sure it is fresh. Store powdered detergent in a cool, dry place (not under the sink).

### Important Notes:

- For optimal wash performance, powdered detergent is recommended for use in the drawer dishwasher dispenser.
- Dishwashing detergent gel or powder packets/tablets can be used. To prevent potential residue or decreased wash performance when using these items, it is recommended that the dispenser lid not be closed to allow the detergents to dissolve properly from the beginning of the cycle.

### Filling the detergent dispensers:

1. Press the lever *down* to open the Main Wash dispenser lid if not already open.
2. Pour detergent into both the Pre-Wash and Main Wash compartments as necessary.
3. After filling the compartment(s), close the Main Wash dispenser lid until it clicks shut.

Detergent will automatically be released into the dishwasher drawer during the wash cycle. The Pre-Wash compartment will immediately begin to dispense detergent into the dishwasher drawer.

**Important: Do not use detergent with the Quick Rinse cycle. Leave the dispenser lid open when running Quick Rinse.**

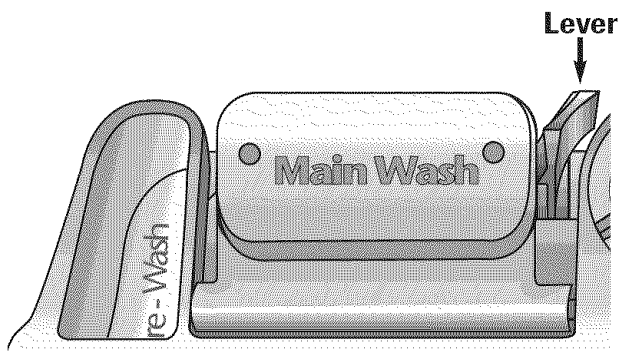

## Recommended Amount

Too little detergent results in poor cleaning, hard water filming/spotting and poor drying. Too much detergent can cause permanent etching/cloudiness.

Suds can cause the dishwasher to overflow. Measure the detergent carefully and use *only* detergents designed for use in a dishwasher. Less detergent is needed in soft water. Try another brand of detergent if sudsing continues.

The amount of detergent to use is determined by the hardness of the water and soil level of the load. Refer to the following chart for detergent usage recommendations.

WATER HARDNESS*	SOIL LEVEL	PRE-WASH DETERGENT	MAIN WASH DETERGENT
<b>Soft (0-4 gpg)</b>	Light Soil	1 tsp	2 tsp
	Normal Soil	2 tsp	2 tsp
	Heavy Soil	3 tsp	3 tsp
<b>Medium (5-9 gpg)</b>	All Levels	3 tsp	3 tsp
<b>Hard (10-12 gpg)</b>	All Levels	3 tsp	3 tsp

\*Your local Sears store, water utility or state university extension service can tell you the degree of water hardness in your area.

**In extremely hard water conditions (13 grains per gallon or more\*), it is difficult to achieve good results with any dishwasher.**

**A mechanical water softener may be necessary to improve water quality, detergent effectiveness, and protect the dishwasher parts from the damage that hard water can cause.**



# DISHWASHER RECOMMENDATIONS

## Rinse Aid

**Important:** This dishwasher is designed to use a liquid rinse aid. Rinse aid greatly improves drying, reduces spotting and filming, and reduces moisture left on the dishwasher interior by creating a “sheeting” action. Water “sheets” off dishes, preventing drops of water from remaining on dishes and creating spots. Drying performance will improve after several washes using rinse aid.

The automatic Rinse Aid dispenser is located next to the detergent cup. A pre-determined amount of rinse aid will be added during the final rinse. When the dispenser is low and needs to be refilled, an indicator light on the control panel will illuminate.

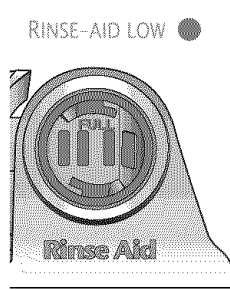

### Filling Rinse Aid dispenser:

1. Turn the plug 1/4 turn *counterclockwise* and remove.
2. Pour liquid rinse aid into the circular opening until liquid reaches the FULL level marking.
3. Wipe up any rinse aid that spills into the dishwasher with a damp cloth to prevent excess foaming.
4. Place the plug back into the Rinse Aid dispenser, turning *clockwise* until the plug is secure.

## Rinse Aid/Audible Feedback Adjustment Mode

**Important:** The rinse aid/audible feedback mode cannot be adjusted while a cycle is running, if the Delay Hours option is running or if the dishwasher is performing a Cancel/Drain.

### To enter the rinse aid/audible feedback adjustment mode:

1. Press and hold the **High Temp Wash** option pad for *three* seconds. An audible chime will sound to indicate you have entered the rinse aid/audible feedback adjustment mode.
2. The rinse aid has four levels, with “0” being the lowest (no rinse aid being dispensed) and “3” the highest. With each consecutive press of the High Temp Wash option pad, the amount of rinse aid dispensed into the dishwasher drawers will be increased.
3. Cycle and option lights will illuminate with each touch of the High Temp Wash option pad to indicate the rinse aid level.

RINSE AID DISPENSER LEVEL	OPTION LIGHTS		
	ANTI-BACTERIAL/HEAVY WASH	NORMAL WASH	CHINA GENTLE
0	OFF	OFF	OFF
1	ON	OFF	OFF
2	ON	ON	OFF
3	ON	ON	ON

**Note:** A Rinse Aid dispenser level of “0” disables the Rinse-Aid low indicator light.

4. To change the audible feedback, press the **Delay Hours** option pad.
5. The first press of the Delay Hours option pad will disable the drawer opened chime, the second press will turn off the end-of-cycle chime. Each press will toggle between the available settings. Delay Hours lights will illuminate with each touch of the Delay Hours pad to indicate the audible setting.

AUDIO FEEDBACK STATUS	OPTION LIGHTS	
	DELAY 2 HOUR	DELAY 4 HOUR
Drawer open/End-of-cycle chime disabled	OFF	OFF
Drawer open chime enabled	ON	OFF
End-of-cycle chime enabled	OFF	ON
Drawer open/End-of-cycle audio feedback enabled	ON	ON

6. Pressing any key pad other than High Temp Wash or Delay Hours will exit the rinse aid/audible mode.

The rinse aid level and audible feedback selected will be saved unless power is lost while adjusting the level. If power is lost, the rinse aid level and audible feedback will default to the last saved setting. Each time the rinse aid/audible feedback adjustment mode is entered the current setting will be recalled. The rinse aid/audible feedback chime comes preset from the manufacturer.

# CYCLES, OPTIONS AND LIGHTS

Choose the cycle that best describes your dish load by pressing the corresponding touchpad (select models) or by pressing the **Cycle select** pad (select models) until the desired cycle is lit. (See page 6, *Start Up Guide*, for how to begin the cycle).

In addition to choosing a cycle, choose as many available options as necessary for your load.

- Cycles and options cannot be changed after the cycle has started.
- **If Anti-Bacterial (select models) is selected, Sani-Rinse (select models) will automatically be selected and can not be cancelled.**

CYCLES	DESCRIPTION	TIME (APPROX. MINS.)	NUMBER OF WASHES/RINSES	USE WITH OPTIONS
<b>Smart Sense™*+</b> (select models)	An adaptive cycle that adjusts the number of fills, wash times and temperatures based on the turbidity of the water. The turbidity sensor determines the dish soil level and selects the proper wash cycle.	Min. 57 Max. 138**	1 wash/2 rinses 4 washes/2 rinses	Sensor Dry (select models) Sani-Rinse+ (select models) High Temp Wash Delay Hours
<b>Heavy Wash</b>	A long cycle that uses more time, water and applied heat than the Normal Wash cycle.	80	4 washes/2 rinses	High Temp Wash Delay Hours
<b>Anti-Bacterial+</b> (select models)	When the cycle monitor recognizes that the proper conditions have been met, the Sanitized light will activate at the end of the cycle. Sanitization may not be achieved if there is an interruption of the cycle, power failure or if the incoming water temperature is below 120° F (49° C).	80	4 washes/2 rinses	Sensor Dry Sani-Rinse+ High Temp Wash Delay Hours
<b>Normal Wash*+</b>	A medium cycle for washing loads with normal food soil levels.	Min. 57 Max. 95**	1 wash/2 rinses 4 washes/2 rinses	Sensor Dry Sani-Rinse+ High Temp Wash Delay Hours
<b>China-Gentle</b>	Use this cycle for lightly soiled china and crystal. This cycle uses a gentle wash and rinse. Towel drying may be required.	60	1 wash/2 rinses	Sensor Dry High Temp Wash Delay Hours
<b>Quick Wash</b>	Quick cycle for light food soil. Towel drying may be required	38	1 wash/2 rinses	Delay Hours
<b>Quick Rinse</b>	Use this rinse cycle when rinsing place settings you plan to wash later, or for freshening up dishes that have been stored for a period of time.	18	2 rinses	–

+ Only these cycles has been designated to meet NSF requirements (NSF/ANSI 184 Residential Dishwasher).

\* Number of fills will vary depending on the soil level of each load.

\*\*Times are based on immediate availability of 120° F hot water at the start of the cycle. This can be achieved by turning on the kitchen faucet and running water until hot prior to starting the dishwasher.

## Notes:

- All times are approximate.
- Fill length varies between different models.
- Fill time will vary depending on water pressure.
- Cycle times shown will increase or decrease based on each load's soil level, water temperature and selected options.
- Fan dry can be 30 minutes up to 4 hours depending on cycles selected. Dry time is optimized per cycle performance by selecting Sensor Dry.
- If the drawer is open for more than 30 seconds during the intermittent drying time, intermittent dry will shut off.
- Even if rinse aid is used, the first few loads may leave dishes with more water than normal. This effect will dissipate after a few loads.

# CYCLES, OPTIONS AND LIGHTS

## Sensor Dry (select models)



Sensor technology allows the dishwasher to provide optimum drying performance based on the water temperature reached during the wash cycle and use of rinse aid. Rinse Aid helps reduce drying time. Drying performance will improve after several washes using rinse aid.

At the end of the selected cycle, intermittent drying will turn the fan on every hour for five minutes for up to 10 hours or until the drawer is opened for more than 30 seconds.

### CAUTION

Hot air and water vapor will be expelled from the base of each drawer during the dry cycle (vapor may be visible). This air/vapor mixture is hot and may cause minor burns.

## Child Lock

The control touchpads can be locked to prevent small children from starting and stopping the dishwasher or from changing the cycle and option selections. If this feature is activated between cycles, the dishwasher cannot be operated until the controls are unlocked. The controls can not be locked after a cycle or delay has started.

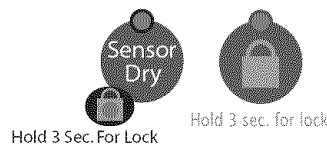

### Setting the Child Lock:

1. Press the **Sensor Dry** or **Lock** pad and hold for *three* seconds.
2. An indicator light next to the lock graphic will illuminate when the controls are locked.

### To cancel:

1. Press the **Sensor Dry** or **Lock** pad and hold for *three* seconds.
2. The indicator light will go off.

### Notes:

- If a cycle or option pad is pressed after the controls have been locked, the indicator light next to the lock graphic will flash three times and the dishwasher will beep four times.
- This option **does not** lock the drawer, only the dishwasher controls.

## Sani-Rinse (select models)



Sani-Rinse increases the water temperature in the final rinse, raising the temperature to meet sanitization requirements. The Sanitized indicator light to the far right of the control panel will not light if all requirements for sanitization have not been met. Sani-Rinse can be selected with Normal Wash and Smart Sense™ cycles.

**Important:** Sani-Rinse is mandated when using an Anti-Bacterial cycle and cannot be cancelled.

To select, press the **Sani-Rinse** pad *after* making your cycle selection. To cancel this option, press the **Cancel/Drain** pad.

## High Temp Wash



This option adjusts cycles to provide additional wash time and temperature to aid in the removal of heavy and/or baked on soils. Selecting this option will extend wash time by increasing water temperature and/or the number of fills in the wash cycle.

To select, press the **High Temp Wash** pad *after* making your cycle selection. To cancel this option, press the pad again, or press the **Cancel/Drain** pad to cancel all selected cycles and options.



# CYCLES, OPTIONS AND LIGHTS

## Delay Hours



The Delay Hours option can be used to automatically start the cycle at a more convenient time or to take advantage of reduced energy costs if available in your area. This option is also useful for conserving hot water at times of high household usage (showers, laundry).

### To set up a delay:

1. Select the desired cycle and options for the load.
2. Press the **Delay Hours** pad until the desired amount of delay time is selected. There is a 2, 4 and 8 hour delay option. Continue pressing the **Delay Hours** pad until you have made your selection.
3. As soon as the Start/Resume pad is pressed, the delay time will begin counting down. When counting down, the indicator light will change from 8Hr to 4Hr to 2Hr when the lower hour is reached.

4. The cycle will automatically start and the indicator light will go out as soon as the delay time expires.

### Notes:

- If 30 seconds elapse between setting the cycle and options and pressing the Start/Resume or Cancel/Drain pad, the dishwasher will turn off.
- Press the **Start/Resume** pad *once*, then close the drawer. Drawer must be closed within 3 seconds after pushing Start/Resume or the lights will flash and the audio alarm sound will be heard.

To cancel a delay, press the **Cancel/Drain** pad *once*. To cancel a running delay and start the cycle, press the **Delay Hours** or **Start/Resume** pad.

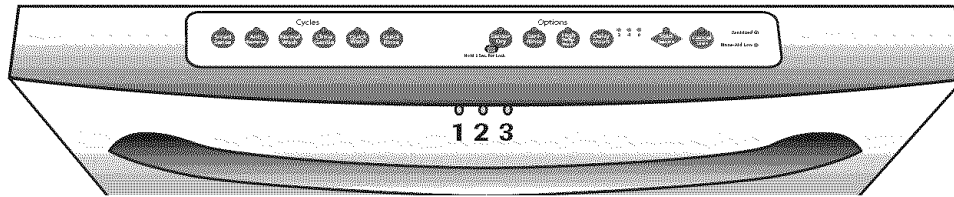

## Indicator Lights on Outside of Drawer Dishwasher (select models)

INDICATOR	DESCRIPTION
1) Washing	The Washing cycle indicator light, located on the front of the drawer, will illuminate prior to the first fill of any cycle. It will remain illuminated until the completion of the final drain. The washing indicator light will flash when the drawer is opened during the wash portion of an operating cycle. If the drawer has been opened during a wash cycle, Start/Resume will need to be pressed before the cycle will resume.
2) Drying	The Drying indicator light, located on the front of the drawer, will remain lit until the drying portion of the cycle is complete. If the drawer has been opened during a dry cycle, Start/Resume will need to be pressed before the cycle will resume.
3) Clean	The Clean indicator light, located on the front of the drawer, will illuminate when the minimum dry time has been completed except when the Quick Rinse cycle is selected. It will remain illuminated until the drawer is open for 30 seconds. If there has been a power loss, the clean indicator light will not relight until after the next cycle is run.

# CYCLES, OPTIONS AND LIGHTS

## Indicator Lights on Control Panel

See page 5 for all model indicator lights.

INDICATOR	DESCRIPTION
<b>Delay Hours</b>	Only the indicator light for the currently selected delay setting will be illuminated during a delay selection. For example, if a 4 hour delay is selected, the 2 hour and 8 hour delay indicator lights will not be illuminated (see page 13 for operation of the Delay Hours option).
<b>Start/Resume</b>	The Start/Resume indicator light, located on the top of the drawer, will be illuminated while the dishwasher is executing a cycle or delay whether or not the drawer is open. The Start/Resume indicator light will not illuminate in any other mode. If the drawer is opened during a wash cycle, the Start/Resume indicator light will flash until it is pressed to restart the cycle.
<b>Cancel/Drain</b>	The Cancel/Drain pad will illuminate to indicate that a cancel initiated drain is running.
<b>Sanitized</b> (select models)	Illuminates at the end of the cycle when conditions have been met to achieve sanitization. The light will remain lit until the drawer has been open for 30 seconds continuously.
<b>Clean</b> (select models)	The clean indicator light, located on the control panel, will illuminate as soon as any cycle except Quick Rinse is completed.
<b>Rinse-Aid Low</b>	Illuminates when the rinse aid dispenser is low or empty and the drawer is open.

### Notes:

- When the Anti-Bacterial (select models), Smart Sense™ (select models) or Normal Wash cycle with Sani-Rinse (select models) is selected, the final rinse cycle is monitored to assure sanitization. The Sanitized light will not illuminate if sanitization requirements are not met. This could happen if the cycle is interrupted, power failure occurs or incoming water temperature is below 120° F (49° F).
- The Clean and Sanitized indicator lights will not relight after a power failure until after the next cycle is run.



# DISHWASHER SAFE ITEMS

Most tableware, cookware and flatware can be safely washed in your dishwasher. Check with the manufacturer.

MATERIAL	DISHWASHER SAFE?	SPECIAL INFORMATION
Aluminum	Yes, if labeled dishwasher safe or coated with a protective finish.	High water temperature and detergents may affect finish.
Cast Iron	No	Seasoning will be removed, and iron will rust.
China/Stoneware	Yes, except antique or hand-painted.	<i>Always</i> check manufacturer's recommendation <i>before</i> washing. Antique, hand-painted or over-the-glaze patterns may fade. Gold leaf may discolor.
Crystal	Yes, except antique or delicate crystal.	<i>Always</i> check manufacturer's recommendation <i>before</i> washing. Some types of leaded crystal may etch with repeated washings.
Filters	Not recommended.	May leave a dingy deposit or stain on dishwasher interior.
Glass	Yes	A specialty glass called milk glass can yellow with repeated dishwasher washing.
Gold-Plated Flatware	No	Will discolor.
Pewter, Tin	No	
Plastics	Yes, except disposable plastic items.	<i>Always</i> check manufacturer's recommendation <i>before</i> washing. Plastics vary in their capacity to withstand high water temperatures and detergents. Disposable plastic items are not dishwasher safe for this reason.
Stainless Steel	Yes	Run a <b>Quick Rinse</b> cycle (rinse only cycle) if not washing immediately. Prolonged contact with foods containing salt, vinegar, milk products or juice could damage finish.
Sterling Silver or Silver Plate	No, if has commercial "darkening".	<i>Always</i> check manufacturer's recommendation <i>before</i> washing. Run a <b>Quick Rinse</b> cycle (rinse only cycle) if not washing immediately. Prolonged contact with food containing salt, acid or sulfide (eggs, mayonnaise and seafood) could damage finish. Commercial "darkening" may be removed by detergent.
Wooden Items	No	Wood may warp, crack or discolor.





# CARE AND CLEANING

## General Recommendations

- The dishwasher interior is normally self-cleaning. Periodically check the bottom of the dishwasher drawer to see if any large food particles remain.
- Wipe the edge of the drawer to remove any food soil splashes that occurred during loading.
- When cleaning the stainless steel exterior, *always* wipe with the grain. **Never** use products containing chlorine bleach or citric acid.

- The color from some tomato-based food soils may occasionally adhere to various components of the dishwasher interior, causing temporary discoloration.

### To minimize this:

- Remove excess tomato-based food soils from dishes *before* loading.
- Run the **Smart Sense™** (select models) or **Heavy Wash** (select models) cycle when washing loads containing tomato-based food soils.
- Be sure to use a dishwasher detergent that contains chlorine to better fight staining.

LOCATION	SOIL LEVEL	TREATMENT
<b>Standard Exterior</b>	Light to moderate	Soft, damp cloth and liquid spray cleaner. <b>Do not</b> use abrasive powders or cleaning pads.
<b>Stainless Steel Exterior</b> (select models)	Daily cleaning and light soil	Soft cloth or sponge and one of the following: <ul style="list-style-type: none"> <li>• Mild detergent and water</li> <li>• A solution of white vinegar and water</li> <li>• Glass and surface cleaner or similar multi-surface cleaner. Follow with rinse and dry.</li> <li>• <b>Do not</b> use products containing chlorine bleach or citric acid.</li> </ul>
	Moderate to heavy soil	Soft cloth or damp sponge and stainless steel cleaner. Follow with rinse and dry.
	Streaks or fingerprints/restore shine	Soft cloth and stainless steel cleaner.
	Discoloration	Soft cloth or damp sponge and stainless steel cleaner. Rinse immediately and dry.
	Light to moderate	Soft cloth or damp sponge.
<b>Interior</b>	Discoloration or tomato-based stains	Switch dishwasher detergent to chlorine-based product.
	Moderate to heavy soil	<ul style="list-style-type: none"> <li>• Make a paste with powdered dishwasher detergent on a damp sponge and clean.</li> <li>• See the vinegar rinse procedure in <i>Glasses are cloudy/spotted</i> in Troubleshooting.</li> <li>• Run a <b>Normal Wash</b> cycle with detergent after cleaning the interior.</li> </ul>

Call 1-800-4-MY-HOME® (1-800-469-4663) to order.



# CARE AND CLEANING

## Coarse Filter Cup

The coarse filter cup is located on the floor of the dishwasher drawer. It is designed to collect large food and non-food items that cannot be processed through the dishwasher disposal system, i.e. bone, broken glass, etc. Check and empty the coarse filter cup if food soil remains on the coarse filter plate. This ensures foreign objects are not recirculated through a cycle, causing possible damage to dish load.

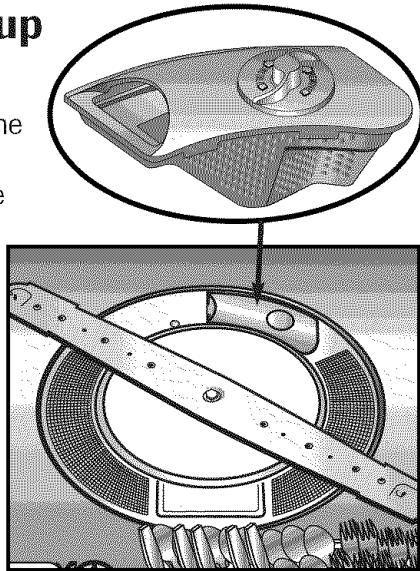

**Important: Do not** start the dishwasher until the coarse filter cup is securely in place and flush with the coarse filter plate. Doing so may damage the dishwasher motor and/or spray arm.

### Cleaning the coarse filter plate and coarse filter cup:

If coarse filter plate accumulates food soil, cleaning of the coarse filter cup is needed.

### Three-piece rack (select models)

1. Make sure that the dishwasher drawer is cool *before* you clean the coarse filter plate and coarse filter cup.
2. Pull drawer out to its full extension. Make sure the rack is empty. Fold the variable tines along the back flat on the rack. Grasp the front center of the rack and pivot upward to access the coarse filter cup.

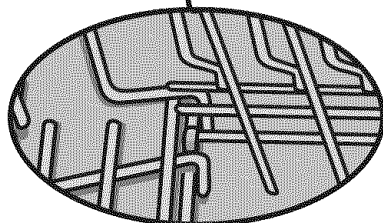
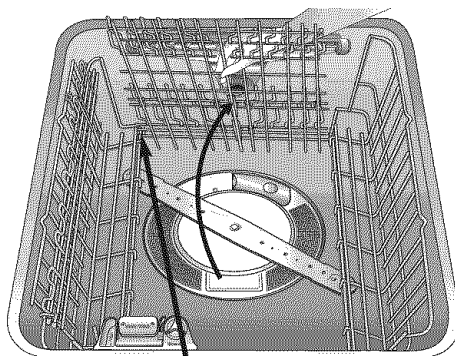

3. Wipe the coarse filter plate with a damp cloth in a *clockwise* motion.
4. To remove the coarse filter cup, unscrew the small cap turning in a *counterclockwise* motion. Lift and remove the coarse filter cup out of the drawer.
5. Empty the cup of hard objects and food soil. Rinse cup under hot water.
6. Place the coarse filter cup back into the coarse filter plate and tighten the cap, turning in a *clockwise* motion. Make sure the coarse filter cup is flush with the coarse filter plate.
7. Pivot the center rack downward to its original position.

**Notes:** Removal of the center rack is not recommended, however if it is needed:

- Pull drawer out to its full extension. Make sure the rack is empty. Fold the variable tines along the back flat on the rack. Grasp the front center of the rack and pivot *upward*.
- Pivot the rack toward the *left*.
- Pull the rack toward the front of the drawer and lift *up* to remove.

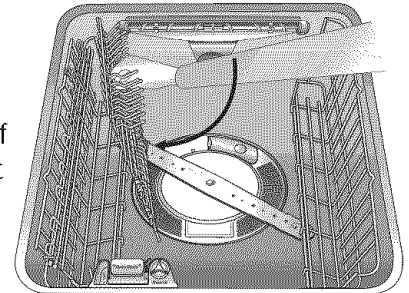

### To reinstall the rack:

- Place the hook in the loop on the back left corner of the rack.
- Pivot the rack to the *right*, then pivot downward to its original position.



# CARE AND CLEANING

---

## One-piece rack

1. Make sure that the dishwasher drawer is cool *before* you clean the coarse filter plate and coarse filter cup.
2. Pull drawer out to its full extension. Remove plate tine insert from rack and set aside.
3. Wipe the coarse filter plate with a damp cloth in a *clockwise* motion.
4. To remove the coarse filter cup, unscrew the small cap, turning in a *counterclockwise* motion. Lift and remove the coarse filter cup out of the drawer.
5. Empty the cup of hard objects and food soil. Rinse cup under hot water.
6. Place the coarse filter cup back into the coarse filter plate and tighten the cap, turning in a *clockwise* motion. Make sure the coarse filter cup is flush with the coarse filter plate.
7. Replace the plate tine insert.

## Long Term Storage/Moving

1. Fill detergent cup with a fresh-scented dishwasher detergent or baking soda, close the lid and select the **Quick Wash** cycle. Allow the dishwasher to complete the cycle.
2. Turn the water supply off and drain the dishwasher. Press **Cancel/Drain** *once* to activate the drain.
3. Operate the drain *twice* to ensure most of the water is removed.
4. Disconnect the electrical supply and prop open the drawer.
5. Be sure dishwasher is clean and dry.

**When turning the water supply to the home off, the water shut-off at the dishwasher must be turned off as well.**



# TROUBLESHOOTING

PROBLEM	SOLUTION
<b>Dishwasher will not fill</b>	<ul style="list-style-type: none"> <li>• Press the <b>Start/Resume</b> pad to start the dishwasher.</li> <li>• Drawer must be closed within 3 seconds after pressing Start/Resume.</li> <li>• Be sure drawer is closed securely.</li> <li>• Be sure the water is turned on.</li> <li>• Check that the pads are properly selected for a cycle and/or option.</li> <li>• Check your home's circuit breaker or fuse box.</li> </ul>
<b>Dishwasher will not drain/ water in tub bottom</b>	<ul style="list-style-type: none"> <li>• If hooked up to a food waste disposer, be sure the knock-out is removed from the disposer inlet.</li> <li>• Check for food or foreign object obstruction in the drain filter, coarse filter cup or disposer.</li> <li>• Check drain hose for a kink.</li> <li>• Check your home's circuit breaker or fuse box.</li> <li>• Check that the cycle is completed (see pg. 13-14).</li> </ul>
<b>Dishwasher adds water at end of cycle (select models)</b>	<ul style="list-style-type: none"> <li>• This is normal. The sensor in the pump must stay submerged so a short fill of water is added after the cycle's last drain.</li> </ul>
<b>Detergent cup is not empty</b>	<ul style="list-style-type: none"> <li>• Check that the cycle is completed (see pg. 13-14).</li> <li>• Be sure dispenser is not blocked.</li> <li>• Use fresh powdered detergent stored in a cool, dry place.</li> </ul>
<b>Dishwasher seems noisy</b>	<ul style="list-style-type: none"> <li>• A water valve hiss during fill is normal.</li> <li>• Water circulation sounds are normal.</li> <li>• A thumping sound may be a wash arm bumping an item that is extending below the rack(s). Re-adjust load to avoid obstructing wash arm.</li> <li>• Chopping or grinding sounds may be heard during the drain portion of the cycle as the internal chopper blade chops hard items like fruit seeds, nuts, etc.</li> <li>• Humming during the drain is normal.</li> <li>• A snap noise is the detergent cup lid hitting the drawer when the dispenser opens and releases detergent into the drawer during a wash cycle. This is normal.</li> <li>• Proper installation affects the noise level.</li> </ul>
<b>Cycle takes too long</b>	<ul style="list-style-type: none"> <li>• Sani-Rinse (select models), High Temp Wash or Sensor Dry (select models) has been selected and the cycle is extended to heat water.</li> <li>• Rinse aid is not being used and may lengthen dry cycle.</li> <li>• Check to see that the incoming water temperature is 120° F (49° C).</li> </ul>
<b>Dishwasher has an odor</b>	<ul style="list-style-type: none"> <li>• Run dishes being held in the dishwasher through a <b>Quick Rinse</b> cycle.</li> <li>• Many dishwashers have a "new" smell when first installed. This will dissipate with use.</li> <li>• Dishwasher may not be draining properly. (See <i>Dishwasher will not drain</i> section above.)</li> <li>• For a strong odor, place baking soda in both sides of the detergent cup. Select <b>Quick Wash</b> cycle and allow the water to circulate for about 10 minutes. Interrupt the cycle by opening the drawer and let it stand overnight. Restart the dishwasher by closing the drawer and pressing <b>Start/Resume</b>. Allow it to complete the cycle. Another alternative is to use a dishwasher cleaning product.</li> </ul>
<b>Dishwasher leaks</b>	<ul style="list-style-type: none"> <li>• Check that the dishwasher is level. (Refer to the Installation Instructions.)</li> <li>• Suds can cause the dishwasher to overflow. Measure the detergent carefully and use only detergents designed for use in a dishwasher. Less detergent is needed in soft water. Try another brand of detergent if sudsing continues.</li> <li>• To avoid rinse aid leaking from the dispenser, be sure the plug is securely attached (pg. 10).</li> <li>• Make sure that items do not extend above the inside top edge of the drawer.</li> </ul>
<b>Indicator lights flashing (select models)</b>	<ul style="list-style-type: none"> <li>• If a cycle other than the currently selected cycle pad is pressed after the cycle and options are locked, the currently running cycle light will flash three times and four audible beeps will be heard.</li> <li>• The Washing, Drying and Start/Resume indicator lights will flash if the drawer is opened mid-cycle. Start/Resume will need to be pressed before the cycle will resume.</li> <li>• Drawer must be closed within 3 seconds after pressing Start/Resume.</li> </ul>

Cont.

# TROUBLESHOOTING

PROBLEM	SOLUTION
<b>Glasses are cloudy/spotted</b>	<ul style="list-style-type: none"> <li>• Select <b>High Temp Wash</b> option.</li> <li>• Check water temperature. Incoming water should be 120° F (49° C).</li> <li>• <i>Always</i> use rinse aid. (Verify rinse aid dispenser setting, pg. 10).</li> <li>• Confirm that the cloudiness is removable by soaking the item in white vinegar for approximately 5 minutes. If removed, the problem is due to hard water. Adjust detergent amount being used to match water hardness (pg. 9). Be sure detergent is fresh, stored properly and is a high quality brand.</li> <li>• If cloudiness is not removable, it is etching. This is an erosion of the surface of the glassware and can be caused by water that is too hot, from using too much detergent or by prewashing. Detergent needs food soil to act upon. If etching has occurred, the glassware is permanently damaged. To prevent further etching, adjust the detergent amount to match the water hardness, stop prewashing and use water heating options only when incoming water temperature is below 120° F (49° C).</li> </ul>
<b>Food soil remains on dishes</b>	<ul style="list-style-type: none"> <li>• Check water temperature. Incoming water should be 120° F (49° C).</li> <li>• Run hot water at the sink <i>before</i> starting the dishwasher.</li> <li>• Check water hardness and adjust detergent amount accordingly (pg. 9).</li> <li>• Use fresh powdered detergent stored in a cool, dry place.</li> <li>• Select proper cycle for the soil level (pg. 11).</li> <li>• Select <b>Smart Sense™</b> (select models) or proper cycle for soil level, proper option, <b>Sani-Rinse</b> (select models) or <b>High Temp Wash</b>.</li> <li>• Load items so they do not block the wash arm (pgs. 7-8).</li> <li>• Load the utensil basket with knife handles up and spoon and fork handles down.</li> <li>• <b>Do not</b> place glasses over tines.</li> <li>• <i>Before</i> loading, scrape off burnt on foods and wipe the starchy film from utensils used with pasta, rice and oatmeal. These soils require more energy than the rest of the load to clean.</li> </ul>
<b>Items washed in the dishwasher or the dishwasher tub itself are stained/discolored</b>	<ul style="list-style-type: none"> <li>• Aluminum utensils or pans can leave marks when they rub against other items. Leave a slight space between items.</li> <li>• Iron deposits in the water can leave a yellow, brown or orange film on dishes or the dishwasher tub. A rust filter may be needed. Check with a water treatment company.</li> <li>• Separate silver or silver-plated silverware from stainless steel. These metals can be damaged by contact with each other during washing.</li> <li>• Color from tomato sauces may adhere to the interior parts of the dishwasher (pg. 16). If light staining has occurred, leave the drawer open to oxidize the stain away. Use a dishwasher detergent that contains chlorine to better fight staining.</li> <li>• Certain dishwasher detergents may stain silver. Try another brand of detergent.</li> </ul>
<b>Items not properly dried/moisture is present on the dishwasher interior after the dry cycle</b>	<ul style="list-style-type: none"> <li>• Be sure <b>Sensor Dry</b> (select models) is selected.</li> <li>• Water droplets may form on the inner tub as part of the drying process. This is normal.</li> <li>• Be sure the Rinse Aid dispenser is filled.</li> <li>• Use a rinse aid separate from the detergent regularly to improve drying performance. Adjust Rinse Aid setting to <b>High</b> (see pg. 10) when rinse aid is present in the dispenser.</li> <li>• Check water temperature. Incoming water should be 120° F (49° C).</li> <li>• Select <b>Hi Temp Wash</b> option.</li> <li>• Increase detergent amount to match water hardness (pg. 9).</li> <li>• Load properly. (pgs. 7-8)</li> <li>• Plastic and items with non-stick surfaces are difficult to dry because they have a porous surface which tends to collect water droplets. Towel drying may be necessary.</li> <li>• Glasses and cups with concave bottoms hold water and require towel drying. Locate these items on the more slanted side of the rack for improved results.</li> </ul>
<b>Dishware is chipped</b>	<ul style="list-style-type: none"> <li>• Load dishes according to instructions so they do not strike each other (pgs. 7-8).</li> <li>• Washing fine antique china/crystal in the dishwasher is not recommended.</li> <li>• <b>Do not</b> load glasses over the tines.</li> <li>• <b>Do not</b> overload.</li> <li>• Make sure variable tines (select models) are properly adjusted and in place <i>before</i> loading.</li> </ul>
<b>Sanitized light does not illuminate at the end of the cycle (select models)</b>	<ul style="list-style-type: none"> <li>• Sani-Rinse (select models) was not selected.</li> <li>• Sanitization can only be achieved with the Smart Sense™ (select models), Anti-Bacterial (select models) or Normal Wash cycles.</li> <li>• Sanitization may not be achieved if there is an interruption of the cycle, power failure or if incoming water temperature is below 120° F (49° C).</li> </ul>
<b>Dishwasher drawer will not close</b>	<ul style="list-style-type: none"> <li>• Be sure items do not extend above the inside top edge of the drawer.</li> </ul>

# Get it fixed, at your home or ours!

## Your Home

For repair – **in your home** – of **all** major brand appliances, lawn and garden equipment, or heating and cooling systems, **no matter who made it, no matter who sold it!**

For the replacement parts, accessories and owner's manuals that you need to do-it-yourself.

For Sears professional installation of home appliances and items like garage door openers and water heaters.

**1-800-4-MY-HOME®** (1-800-469-4663)

Call anytime, day or night (U.S.A. and Canada)

[www.sears.com](http://www.sears.com)    [www.sears.ca](http://www.sears.ca)

---

## Our Home

For repair of carry-in items like vacuums, lawn equipment, and electronics, call or go on-line for the location of your nearest

**Sears Parts & Repair Service Center**

**1-800-488-1222**

Call anytime, day or night (U.S.A. only)

[www.sears.com](http://www.sears.com)

---

To purchase a protection agreement (U.S.A.) or maintenance agreement (Canada) on a product serviced by Sears:

**1-800-827-6655** (U.S.A.)

**1-800-361-6665** (Canada)

---

Para pedir servicio de reparación a domicilio, y para ordenar piezas:

**1-888-SU-HOGAR®**

(1-888-784-6427)

Au Canada pour service en français:

**1-800-LE-FOYER<sup>MC</sup>**

(1-800-533-6937)

[www.sears.ca](http://www.sears.ca)

