

LCD TELEVISION

Operating Guide for 32HDL52A/37HDL52A

IMPORTANT SAFETY INSTRUCTIONS1- 6
ACCESSORIES.....7
HOW TO SETUP YOUR NEW HITACHI LCD TELEVISION.....8 - 27
HOW TO USE REMOTE CONTROL TO CONTROL YOUR LCD TV.....28 - 32
ON-SCREEN DISPLAY.....33 - 39
DTV USAGE.....40 - 44
USEFUL INFORMATION45 - 52

As an ENERGY STAR® Partner, Hitachi, Ltd. has determined that this product meets the ENERGY STAR® guidelines for energy efficiency.



IMPORTANT SAFETY INSTRUCTIONS







SAFETY POINTS YOU SHOULD KNOW ABOUT YOUR HITACHI LCD TELEVISION

Our reputation has been built on the quality, performance, and ease of service of HITACHI LCD Televisions. Safety is also foremost in our minds in the design of these units. To help you operate these products properly, this section illustrates safety tips which will be of benefit to you. Please read it carefully and apply the knowledge you obtain from it to the proper operation of your HITACHI LCD Television.

Please fill out your warranty card and mail it to HITACHI. This will enable HITACHI to notify you promptly in the improbable event that a safety problem should be discovered in your product model.

Follow all warnings and instructions marked on this LCD television.

  	 	<p>The lightning flash with arrowhead symbol, within an equilateral triangle, is intended to alert the user to the presence of an exposed "dangerous voltage" within the product's enclosure that may be of a sufficient magnitude to constitute a risk of electric shock to persons.</p> <p>The exclamation point within an equilateral triangle, is intended to alert the user to the presence of important operating and maintenance (servicing) instructions in the literature accompanying the appliance.</p>
<p>WARNING: TO REDUCE THE RISK OF FIRE OR ELECTRIC SHOCK, DO NOT EXPOSE THIS APPARATUS TO RAIN OR MOISTURE. CAUTION: NO USER SERVICEABLE PARTS INSIDE. REFER SERVICING TO QUALIFIED SERVICE PERSONNEL.</p>		

WARNING: • TO PREVENT FIRE OR SHOCK HAZARD, DO NOT EXPOSE THIS LCD TELEVISION TO RAIN OR MOISTURE.
• THE LCD TELEVISION SHOULD NOT BE EXPOSED TO DRIPPING OR SPLASHING AND OBJECTS FILLED WITH LIQUIDS, SUCH AS VASES, SHOULD NOT BE PLACED ON THE TELEVISION.

NOTE: Model and serial numbers are indicated on back side of the LCD Television.

CAUTION: Adjust only those controls that are covered in the instructions, as improper changes or modifications not expressly approved by HITACHI could void the user's authority to operate the LCD Television.



MODIFICATIONS: The FCC requires the user to be notified that any changes or modifications made to this device that are not expressly approved by Hitachi America, Ltd. Home Electronics Division may void the user's authority to operate the equipment.

POWER SOURCE
THIS LCD TELEVISION IS DESIGNED TO OPERATE ON 120 VOLTS 60Hz, AC CURRENT. INSERT THE LCD TELEVISION POWER CORD INTO A 120 VOLT 60Hz OUTLET.

TO PREVENT ELECTRIC SHOCK, DO NOT USE THE LCD TELEVISION'S (POLARIZED) PLUG WITH AN EXTENSION CORD, RECEPTACLE, OR OTHER OUTLET UNLESS THE BLADES AND GROUND TERMINAL CAN BE FULLY INSERTED TO PREVENT BLADE EXPOSURE.

NEVER CONNECT THE LCD TELEVISION TO 50Hz, DIRECT CURRENT, OR ANYTHING OTHER THAN THE SPECIFIED VOLTAGE.

Apparatus shall not be exposed to dripping or splashing and no objects filled with liquids, such as vases, shall be placed on the apparatus.

NOTE: This LCD Television will display television closed captioning, ( or ), in accordance with paragraph 15.119 of the FCC rules.



CAUTION: Never remove the back cover of the LCD Television as this can expose you to very high voltages and other hazards. If the television does not operate properly, unplug the LCD Television and call your authorized dealer or service center.

IMPORTANT SAFETY INSTRUCTIONS



Read before operating equipment

Follow all warnings and instructions marked on this television.

1. Read these instructions.
2. Keep these instructions.
3. Heed all warnings.
4. Follow all instructions.
5. Do not use this apparatus near water.
6. Clean only with a dry cloth.
7. Do not block any ventilation openings. Install in accordance with the manufacturer's instructions.
8. Do not install near any heat sources such as radiators, heat registers, stoves, or other apparatus (including amplifiers) that produce heat.
9. Do not defeat the safety purpose of the polarized or grounding-type plug. A polarized plug has two blades with one wider than the other. A grounding type plug has two blades and a third grounding prong. The wide blade or the third prong are provided for your safety. If the provided plug does not fit into your outlet, consult an electrician for replacement of the obsolete outlet.
10. Protect the power cord from being walked on or pinched particularly at plugs, convenience receptacles, and the point where they exit from the apparatus.
11. Only use the attachments/accessories specified by the manufacturer.

12.  Use only with the cart, stand, tripod, bracket, or table specified by the manufacturer, or sold with the apparatus. When a cart is used, use caution when moving the cart/apparatus combination to avoid injury from tip-over.

13. Unplug this apparatus during lightning storms or when unused for long periods of time.
14. Refer all servicing to qualified service personnel. Servicing is required when the apparatus has been damaged in any way, such as power-supply cord or plug is damaged, liquid has been spilled or objects have fallen into apparatus, the apparatus has been exposed to rain or moisture, does not operate normally, or has been dropped.

15. Televisions are designed to comply with the recommended safety standards for tilt and stability.

Do not apply excessive pulling force to the front, or top, of the cabinet which could cause the product to overturn resulting in product damage and/or personal injury.

16. Follow instructions for wall, shelf or ceiling mounting as recommended by the manufacturer.

17. An outdoor antenna should not be located in the vicinity of overhead power lines or other electrical circuits.

18. If an outside antenna is connected to the receiver be sure the antenna system is grounded so as to provide some protection against voltage surges and built up static charges. Section 810 of the National Electric Code, ANSI/NFPA No. 70-1984, provides information with respect to proper grounding for the mast and supporting structure, grounding of the lead-in wire to an antenna discharge unit, size of grounding connectors, location of antenna-discharge unit, connection to grounding electrodes and requirements for the grounding electrode.

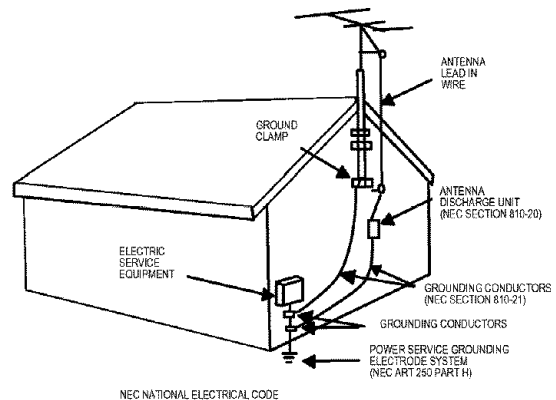

Note to the CATV system installer: This reminder is provided to call the CATV system installer's attention to Article 820-40 of the NEC that provides guidelines for proper grounding and, in particular, specifies that the cable ground shall be connected to the grounding system of the building, as close to the point of cable entry as practical.

This product contains lead. Dispose of this product in accordance with applicable environmental laws. For product recycling and disposal information, contact your local government agency or the Electronic Industries Alliance at www.eiae.org (in the US) or the Electronic Product Stewardship Canada at www.epsc.ca (in Canada). For more information, call "1-800-HITACHI."

Do not place any objects on the top of the television which may fall or cause a child to climb to retrieve the objects.

PUBLIC VIEWING OF COPYRIGHTED MATERIAL

Public viewing of programs broadcast by TV stations and cable companies, as well as programs from other sources, may require prior authorization from the broadcaster or owner of the video program material.

- This digital television is capable of receiving analog basic, digital basic and digital premium cable television programming by direct connection to a cable system providing such programming. A Cable CARD provided by your cable operator is required to view encrypted digital programming. Certain advanced and interactive digital cable services such as video-on-demand, a cable operator's enhanced program guide and data-enhanced television services may require the use of a set-top box. For more information call your local cable company.
- This product incorporates copyright protection technology that is protected by U.S. patents and other intellectual property rights. Use of this copyright protection technology must be authorized by Macrovision Corporation, and is intended for home and other limited consumer uses only unless otherwise authorized by Macrovision. Reverse engineering or disassembly is prohibited.

SAFETY INSTRUCTIONS

This LCD TV has been designed and manufactured to meet international safety standards, but like any electrical equipment, care must be taken if you are to obtain the best results and safety is to be assured.

Before using this product, please read and understand the Safety Instructions thoroughly to ensure correct usage, and follow all the instructions.

About the Symbols

Various symbols are used in this manual, the user's manual and on the product itself to ensure correct usage, to prevent danger to the user and others, and to prevent property damage. The meanings of these symbols are described below. It is important that you read these descriptions thoroughly and fully understand the contents.



This symbol indicates information that, if ignored, could possibly result in personal injury or even death due to incorrect handling.



This symbol indicates information that, if ignored, could possibly result in personal injury or physical damage due to incorrect handling.

Typical Symbols



This symbol indicates an additional warning (including cautions). An illustration is provided to clarify the contents.



This symbol indicates a prohibited action. The contents will be clearly indicated in an illustration or nearby (the symbol to the left indicates that disassembly is prohibited).



This symbol indicates a compulsory action. The contents will be clearly indicated in an illustration or nearby (the symbol to the left indicates that the power plug should be disconnected from the power outlet).



Never use the LCD Television if a problem should occur.

Abnormal operations such as smoke, strange odor, no image, no sound, excessive sound, damaged casing, elements, cables, penetration of liquids or foreign matter, etc. can cause a fire or electrical shock.

In such case, immediately turn off the power switch and then disconnect the power plug from the power outlet. After making sure that the smoke or odor has stopped, contact your dealer. Never attempt to make repairs yourself because this could be dangerous.

Do not insert liquids or foreign objects.

Penetration of liquids or foreign objects could result in fire or electrical shock. Use special caution in households where children are present. If liquids or foreign objects should enter the projector, immediately turn off the power switch, disconnect the power plug from the power outlet and contact your dealer.

- Do not place the LCD TV in a bathroom.
- Do not expose the LCD TV to rain or moisture.
- Do not place flower vases, pots, cups, cosmetics, liquids such as water, etc on or around the LCD TV.
- Do not place metals, combustibles, etc on or around the LCD TV.

Never disassemble or modify the LCD Television.

The LCD TV contains high voltage components. Modification could result in fire or electrical shock.

- Never remove any fixed cover.

Do not give the LCD Television any shock or impact.

If the LCD TV should be shocked and/or broken, it could result in an injury, and continued use could result in fire or electrical shock.

If the glass panel is broken or damaged, immediately turn off the power switch, disconnect the power plug from the power outlet and contact your dealer.

Do not place the LCD Television on an unstable surface.

If the LCD TV should be dropped and/or broken, it could result in an injury, and continued use could result in fire or electrical shock.

- Do not place the LCD TV on an unstable, slant or vibrant surface such as a wobbly or inclined stand.

Do not obstruct the ventilation of the LCD Television.

If the ventilation is obstructed during the operation of the TV or just after switching off the power, it could result in damage and shorten the lifespan of your LCD TV due to overheating. Make sure there is ample ventilation.

- Keep a space of 100mm (10cm) or more between the sides, rear and top of the LCD TV and other objects such as walls.
- Do not place anything around ventilation openings of the LCD TV.
- Never block ventilation openings.
- Do not put the LCD screen side up.
- Do not cover the LCD TV with a tablecloth, etc.
- Do not place the LCD TV on a carpet or bedding, or near a curtain.

Use only the correct power outlet.

Incorrect power supply could result in fire or electrical shock. Use only the correct power outlet depending on the indication on the LCD TV and the safety standard.

- The enclosed power cord must be used depending on the power outlet to be used.



Disconnect the plug from the power outlet.



Do not disassemble.



SAFETY INSTRUCTIONS(continued)

WARNING

Be cautious of the power cord connection.

Incorrect connection of the power cord could result in fire or electrical shock.

- Do not touch the power cord with a wet hand.
- Check that the connecting portion of the power cord is clean (with no dust), before using. Use a soft and dry cloth to clean the power plug.
- Insert the power plug into a power outlet firmly. Avoid using a loose, unsound outlet or contact failure.
- Do not cut off the fitted power plug, the removal of which could lead to impaired performance. If you wish to extend the lead, obtain an appropriate extension lead or consult your dealer.
- Should you require replacing the fuse in the molded plug with a new fuse, then please replace with new one of the same value, type and approval as the original. Ensure the fuse cover is returned to its original position.



Be sure to keep safety ground connection.

Connect the ground terminal of AC inlet of this LCD TV with the ground terminal provided at the power outlet using the enclosed power cord. If the provided plug does not fit your outlet, consult an electrician for replacement of the obsolete outlet.



Surely connect the ground wire.

Be careful in handling the power cord and external connection cables.

If you keep using a damaged the power cord or cables, it can cause a fire or electrical shock. Do not apply too much heat, pressure or tension to the power cord and cables.

If the power cord or cables are damaged (exposed or broken core wires, etc.), contact your dealer.

- Do not place the LCD TV or heavy objects on the power cord and cables. Also, do not place a spread, cover, etc, over them because this could result in the inadvertent placing of heavy objects on the concealed power cord or cables.
- Do not pull the power cord and cables. When connecting and disconnecting the power cord or cables, do it with your hand holding the plug or connector.
- Do not place the cord near the heater.
- Do not touch the power plug just after disconnecting it from the power outlet to prevent electric shock.
- Do not touch the power plug when lightening is close to you.
- Avoid coiling the power cord and bending it sharply.
- Protect the power cord from being walked on, pinched particularly at plugs, conveniences receptacles, and the point where they exit from the apparatus.
- Do not modify the power cord.



Be careful in handling the battery of the remote control.

Incorrect handling of the battery could result in fire or personal injury. The battery may explode if not handled properly.

- Keep the battery away from children and pets. If swallowed consult a physician immediately for emergency treatment.
- Do not allow the battery to be exposed to fire or water.
- Avoid fire or high-temperature environment.
- Do not hold the battery with metallic tweezers.
- Keep the battery in a dark, cool and dry place.
- Do not short circuit the battery.
- Do not recharge, disassemble or solder the battery.
- Do not physically impact the battery.
- Use only the battery specified in the manual of this TV.
- Make sure the plus and minus terminals are correctly aligned when loading the battery.
- If you observe a leakage of the battery, wipe out the liquid and then replace the battery. If the liquid adheres your body or clothes, rinse well with water.
- Obey the local laws on disposing the battery.



SAFETY INSTRUCTIONS(continued)

WARNING

Be careful in moving the LCD Television.

Neglect could result in an injury or damage.

- Do not move the LCD TV during use. Before moving, disconnect the power plug and all external connections.
- You are advised to move the LCD TV with two persons.
- Avoid any impact or shock to the LCD TV; particularly take care of glass screen.

Do not put anything on top of the LCD Television.

Placing anything on the LCD TV could result in loss of balance or falling, and cause an injury or damage. Use special caution in households where children are present.

Avoid a humid or dusty place.

Placing the LCD TV in a smoke, a highly humid, dusty place, oily soot or corrosive gas could result in fire or electrical shock.

- Do not place near the kitchen, a humidifier or other place where there is oil, smoke or humidity.

Avoid a high temperature environment.

The heat could have adverse influence on the LCD TV and other parts, and could result in transformation, melting or fire.

- Do not place the LCD TV, the remote control and other parts in direct sunlight or near a hot object such as heater, etc.
- Do not put the LCD TV in a place where the temperature is widely changing.

Remove the power cord for complete separation.

- For safety purposes, disconnect the power cord if the LCD TV is not to be used for prolonged periods of time.
- Before cleaning, turn off and unplug the LCD TV. Neglect could result in fire or electrical shock.

PRECAUTIONS

• Installation environment

Do not obstruct a ventilation hole.

Do not put the LCD TV on carpet or blanket, or near a curtain which has a possibility of obstructing a ventilation hole of the LCD TV.

Do not put the LCD TV in the following places.

- Hot places such as near heater, place exposed to the direct rays of the sun.
- A place where the temperature is widely changing.
- Places with soot, dust or high humidity.
- Poor air ventilation place.
- Place near fire.
- A wet place such as bathroom, or shower room.
- Place where you can trip over it.
- Always vibrating or strongly vibrating places.
- Distorted or unstable places.

• How to view the LCD Television.

If you use the LCD TV in too dark a room, your eyes may become tired.

Please use it in a reasonably bright room.

Avoid direct rays of the sun to the screen in order to prevent eye fatigue.

Your eyes will get fatigued after viewing the LCD TV for long period of time.

Relax your eyes by viewing away from the LCD TV from time to time.

Please watch the LCD TV in downward direction.

• Note on image retention

The LCD TV illuminates phosphor to display images. The phosphor has a finite illumination life. After extended periods of illumination, the brightness of the phosphor will be degraded to such extent that stationary images would burn-in that part of the screen as grayed-out images.

Tips to prevent such image retention are:

- Do not display images having sharp brightness differences or high-contrast images, such as monochrome characters and graphic patterns, for long.
- Do not leave stationary images appearing for long, but try to refresh them at appropriate intervals of time, or try to move them using screen saver function.
- Turn down the contrast and brightness controls.

•Dust the screen and frame with a cleaning cloth from the accessories pack.

• How to clean the LCD screen panel of the LCD Television.

Before cleaning the LCD TV, turn off the LCD TV and disconnect the power plug from the power outlet.

To prevent scratching or damaging the LCD screen face, do not knock or rub the surface with sharp or hard objects. Clean the screen with a soft cloth moistened with warm water and dry with a soft cloth. If it is not enough, then use a cloth with mild detergent. Do not use harsh or abrasive cleaners.

• How to clean the cabinet of the LCD Television.

Use a soft cloth to clean the cabinet and control panel of the LCD TV. When excessively soiled dilute a neutral detergent in water, wet and wring out the soft cloth and afterward wipe with a dry soft cloth.

Never use acid/alkaline detergent, alcoholic detergent, abrasive cleaner, powder soap, OA cleaner, car wax, glass cleaner, etc. especially because they would cause discoloration, scratches or cracks.



Disconnect the plug from the power outlet.

SAFETY INSTRUCTIONS(continued)

• Prevention of an obstacle to Radio receivers

This LCD TV has been designed pursuant to the international EMI standards. This is to prevent a problem to Radio receivers.

- Keep the LCD TV away from Radio.
- Adjust Radio antennas in order for the LCD TV not to receive interference.
- The antenna cable of Radio should be kept away from the LCD TV.
- Use a coaxial cable for antenna.

You can check if this LCD TV influences Radio receivers by turning off all other equipment other than the LCD TV.

If you find a problem receiving Radio when using the LCD TV, check the instructions mentioned above.

• Precautions for the cable connection

- Do ensure that all connections, (including the power plug, extension leads and interconnections between the pieces of equipment), are properly made and in accordance with the manufacturers instructions. Switch off and withdraw the power plug before making or changing connections.
- Confirm the connector is fixed tightly when the signal cable is connected.
Also confirm the screws on the connector are tightened.
- Plug the power cord of the LCD TV into a different socket from that for other equipment, such as Radio etc..
- Use a plug with ground terminal and make sure that it connects to the ground.

• Precaution during transportation

Please pay attention when you transport this LCD TV because it is heavy.

Furthermore, use the original carton box and its packaging materials when the LCD TV is transported.

Failure to transport the LCD TV in any carton except the original carton may result in damage to the LCD TV.

Save the original carton box and all packing material.

Do not physically impact the remote control.

A physical impact could cause damage or malfunction of the remote control.

- Take care not to drop the remote control.
- Do not place heavy objects on the remote control.

Avoid strong rays.

Any strong rays (such as direct sun rays or room lighting) onto the remote control sensors could invalidate the remote control.

Avoid radio interference.

Any interfering radiation could cause distorted images or noises.

- Avoid radio generator such as a mobile telephone, transceiver, etc. around the LCD TV.

Set the sound volume at a suitable level.

It is better to keep the volume level low and close the windows at night to protect the neighborhood environment.

• Precautions for the installation



- Do not use makeshift stands and NEVER fix legs with wood screws - to ensure complete safety, always fit the manufacturers approved stand or legs with the fixings provided according to the instructions.
- Use only with the cart, stand, tripod, bracket, or table specified by the manufacturer, or sold with the apparatus. When a cart is used, use caution when moving the cart/apparatus combination to avoid injury from tip-over.
- This product is designed to comply with the recommended safety standards for tilt and stability. Do not apply excessive pulling force to the front, or top, of the cabinet that could cause the product to overturn resulting in product damage and/or personal injury.
- Follow instructions for wall, shelf or ceiling mounting as recommended by the manufacturer.
- Only use the attachments/accessories specified by the manufacturer.
- Consult your dealer if you are in any doubt about installation, operation or safety of your equipment.

• Other precautions

- Do not leave equipment switched on when it is unattended unless it is specifically stated that it is designed for unattended operation or has a stand-by mode. Switch off using the switch on the equipment and show your family how to do this. Make special arrangements for infirm or handicapped people.
- Disposal of this product may require specific instructions pertaining to your resident region.
- Never guess or take any chances with electrical equipment of any kind - it is better to be safe than sorry!

ACCESSORIES

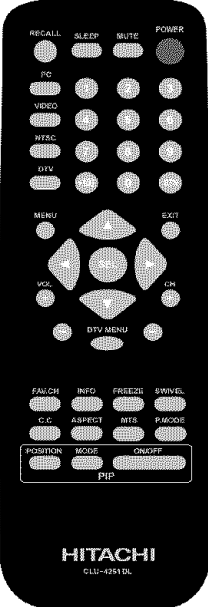
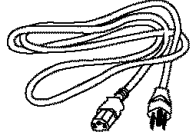
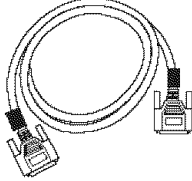
Check to make sure you have the following accessories before disposing of the packing material.

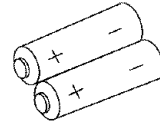
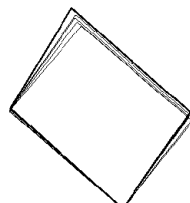
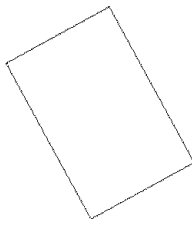
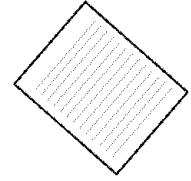
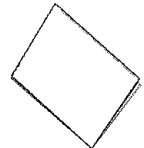
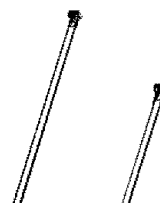
<p>REMOTE CONTROL</p>  <p>1.</p>	<p>POWER CORD</p>  <p>2.</p>	<p>D-SUB MINI 15-PIN CABLE</p>  <p>3.</p>	<p>AUDIO/VIDEO CABLE</p>  <p>4.</p>	<p>S-VIDEO CABLE</p>  <p>5.</p>	<p>BATTERIES</p>  <p>6.</p>
<p>USER'S GUIDE</p>  <p>7.</p>	<p>EASY GRAPHIC GUIDE</p>  <p>8.</p>	<p>WARRANTY CARD</p>  <p>9.</p>	<p>CLEANING CLOTH</p>  <p>10.</p>	<p>CABLE TIE</p>  <p>11.</p>	



CAUTION: Ceiling mounting is not recommended. Mounting the panel on the ceiling does not provide adequate ventilation for the electronics or proper support for the front glass panel. This LCD television product is designed for a maximum tilting angle of 45 degrees from vertical.

- | | |
|-----------------------------------|-----------------------|
| 1. Remote Control Unit | 7. User's Guide |
| 2. Power Cord | 8. Easy Graphic Guide |
| 3. D-SUB Mini 15-Pin Cable | 9. Warranty Card |
| 4. Audio/Video Cable | 10. Cleaning Cloth |
| 5. S-Video Cables | 11. Cable Tie |
| 6. Two "AAA" size, 1.5V batteries | |

REMOTE CONTROL BATTERY INSTALLATION AND REPLACEMENT

1. Open the battery cover of the remote control by pressing the notched part of the cover with your fingers and pulling the cover off.
2. Insert two new "AAA" size batteries for the remote control. When replacing old batteries, push them towards the springs and lift them out.
3. Match the batteries to the (+) and (-) marks in the battery compartment.
4. Replace the cover.

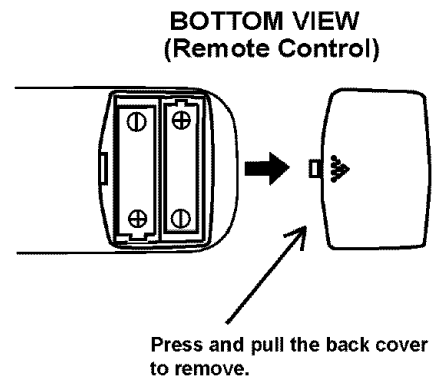

CAUTION: Danger of explosion if battery is incorrectly replaced. Replace with the same or equivalent type.

HOW TO SETUP YOUR NEW HITACHI LCD TELEVISION

To take measures to prevent the LCD Television from tipping over and prevent possible injury it is important to mount the unit in a stable place.

*Keep the LCD Television four inches away from the wall except those hung to the wall mount bracket.

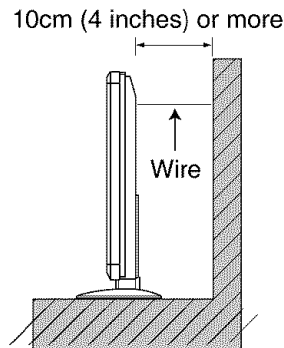

- NOTES:** 1. Do not block the ventilation holes of the LCD Television. Blocking the ventilation holes might cause fire or defect.
2. If you purchased the wall mount bracket option, please ask for professional installer. Do not install by yourself.

Caution when moving the main unit

As this product is heavy, whenever it is moved, two people are required to transport it safely. Whenever the unit is moved it should be lifted forward using the top and base on both sides for stability. When moving the LCD Television, lift the top and the bottom frame as shown below.

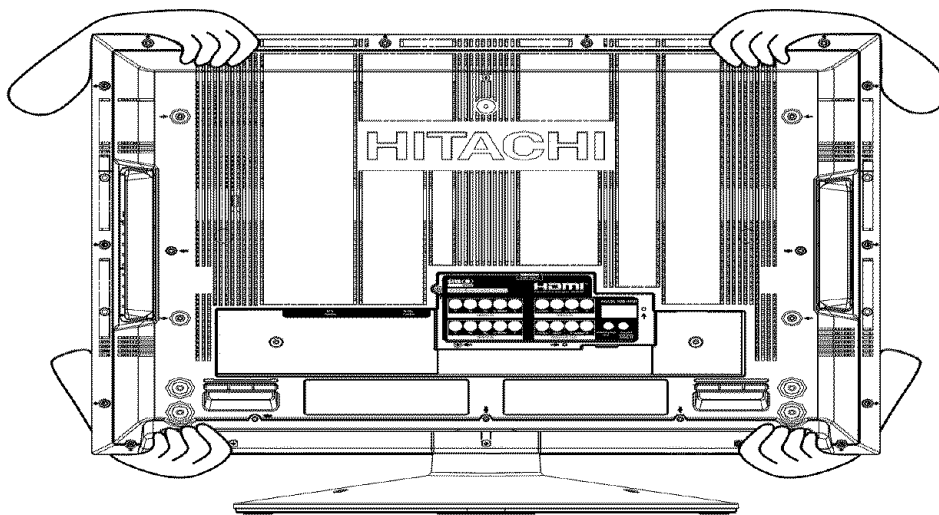

ANTENNA

Unless your LCD Television is connected to a cable TV system or to a centralized antenna system, a good outdoor color TV antenna is recommended for best performance. However, if you are located in an exceptionally good signal area that is free from interference and multiple image ghosts, an indoor antenna may be sufficient.

LOCATION

Select an area where sunlight or bright indoor illumination will not fall directly on the picture screen. Also, be sure that the location selected allows a free flow of air to and from the perforated back cover of the set.

To avoid cabinet warping, cabinet color changes, and increased chance of set failure, do not place the TV where temperatures can become excessively hot, for example, in direct sunlight or near a heating appliance, etc.

HOW TO SETUP YOUR NEW HITACHI LCD TELEVISION

VIEWING

The major benefit of the HITACHI LCD Television is its large viewing screen. To see this large screen at its best, test various locations in the room to find the optimum spot for viewing. The best picture is seen by sitting directly in front of the TV and about 5 to 11 feet from the screen.

During daylight hours, reflections from outside light may appear on the screen. If so, drapes or screens can be used to reduce the reflection or the TV can be located in a different section of the room.

If the TV's audio output will be connected to a Hi-Fi system's external speakers, the best audio performance will be obtained by placing the speakers equidistant from each side of the receiver cabinet and as close as possible to the height of the picture screen center. For best stereo separation, place the external speakers at least four feet from the side of the TV, place the surround speakers to the side or behind the viewing area. Differences in room sizes and acoustical environments will require some experimentation with speaker placement for best performance.

IMPORTANT NOTES

No.	Items	Notes
1	Arching sound from LCD television panel.	A buzzing sound might be heard when the LCD television is turned on in a very quiet room. This is due to the LCD display panel drive circuit when it is functioning. This arching sound is normal and it is not a malfunction.
2	Interference for infrared equipment.	Some infrared rays are emitted from the LCD television's panel that might affect other infrared controlling equipment.
3	Bright and dark spots	High-precision technology is used to manufacture the LCD display panel; But in some cases, there are minor defects in some parts of the screen. Points that do not light, points with brightness different from that of the periphery, points with color different from that of the periphery, etc. Some pixels will always be on or always off. Please note that this is not a malfunction.
4	Picture Image (Spectrum)	When receiving still picture signals, (e.g. channel number indication or clock indication) for a while, you can see image-like when the picture varied. This is not a defect.
5	LCD Surface	The LCD display panel is made from glass. Heavy shock on the front panel might damage it. Do not press the panel surface hardly, this would cause "Mura" effect on the screen.
6	Transportation	When the LCD television is transported horizontally, the glass panel has the possibility of being broken or increasing the picture defects. At the time of transportation, horizontal style is prohibited. More-over, please treat the LCD panel with great care because of a precision apparatus. Please instruct transporters so that it should be put into the packing box at the time of shipment. (There is a possibility that breakage of the panel or defects will increase.) Rough transportation might cause damage to the panel and pixel failure.
7	Image retention	The LCD TV illuminates phosphor to display images. The phosphor has a finite illumination life. After extended periods of illumination, the brightness of the phosphor will be degraded to such extent that stationary images would burn-in that part of the screen as grayed-out images. Tips to prevent such image retention are: - Do not display images having sharp brightness differences or hi-contrast images, such as monochrome characters and graphic patterns, for long. - Do not leave stationary images appearing for long, but try to refresh them at appropriate intervals of time, or try to move them using screen saver function. - Turn down the contrast and brightness controls.
8	Granular spots	When a screen is seen at point-blank range, a random fine grain may be visible to a dark part.
9	Disturbance to video apparatus	If an apparatus (VCR, etc.) antenna line is arranged near the LCD TV, the image may shake, or disturbance may be received.
10	Lip Sync	There is some time lag between the picture and the sound. You can see lip motion that is delayed compared to the sound.
11	About the use environment of LCD television (temperature)	Electric discharge/luminescence characteristic of the LCD display panel also changes with peripheral temperature. Moreover, since there is also high power consumption value, a specified temperature environment is required.
12	Caution on prolonged storage	Storing the LCD television for a period of more than 2 to 3 months without use might cause an unstable picture when the set is turned on.
13	Operating	Operating altitude: 800 to 1,114hPa (6,194ft to -2,484ft). Operating temperature: 41°F to 95°F.
14	Storage	Storage Altitude: 300 to 1,114hPa (31,912ft to -2,484ft). Storage temperature: 5°F to 140°F.
15	Power ON or OFF	Frequent use of the Power ON or OFF might trigger the power protection circuit. If the TV does not turn ON, please wait a little before turning ON again.

HOOKUP CABLES

Most video/audio connections between components can be made with shielded video and audio cables that have phono connectors. For best performance, video cables should use 75-Ω coaxial shielded wire. Cables can be purchased from most stores that sell audio/video products. Below are illustrations and names of common connectors. Before purchasing any cables, be sure of the output and input connector types required by the various components and the length of each cable.

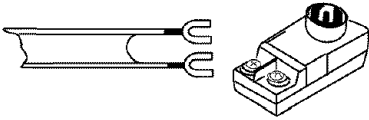

300-Ω Twin Lead Connector

This outdoor antenna cable must be connected to an antenna adapter (300-Ω to 75-Ω).

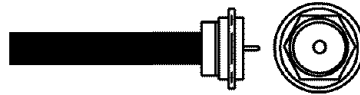

"F" Type 75-Ω Coaxial Antenna Connector

For connecting RF signals (antenna or cable TV) to the antenna jack on the television.



Phono Connector (Provided)

Used on all standard video and audio cables which connect to inputs and outputs located on the rear jack panel.



S-Video (Super Video) Connector (Provided)

This connector is used on camcorders, VCRs and laserdisc players with an S-Video feature in place of the standard video cable to produce a high quality picture.

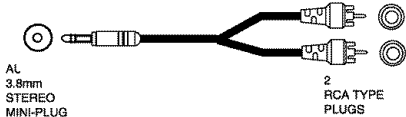

Stereo Cable

This cable is used to connect from external audio out to the audio input of the LCD TV (ex. ANALOG RGB/HDMI Audio Input).



HDMI Cable

This cable is used to connect your external devices such as Set-Top-Boxes or DVD players equipped with an HDMI output connection to the television's HDMI input.

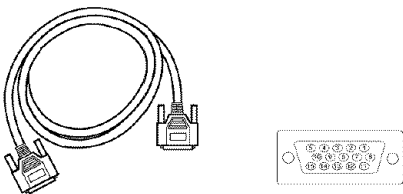

D-SUB MINI 15-Pin Cable (Provided)

This cable is used to connect a computer output to the D-SUB input located on the rear panel of the LCD TV. The resolution should be set correctly to display the signal on the LCD TV.

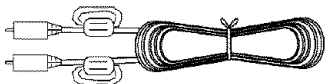

Subwoofer Cable

This cable is used to connect an external audio component input to the subwoofer output of the LCD TV.

ANTENNA CONNECTIONS TO REAR PANEL JACKS

VHF (75-Ω) antenna/CATV (Cable TV)

When using a 75-Ω coaxial cable system, connect the outdoor antenna or CATV coaxial cable to the NTSC TUNER terminal (75-Ω) and/or DTV TUNER terminal (75-Ω).

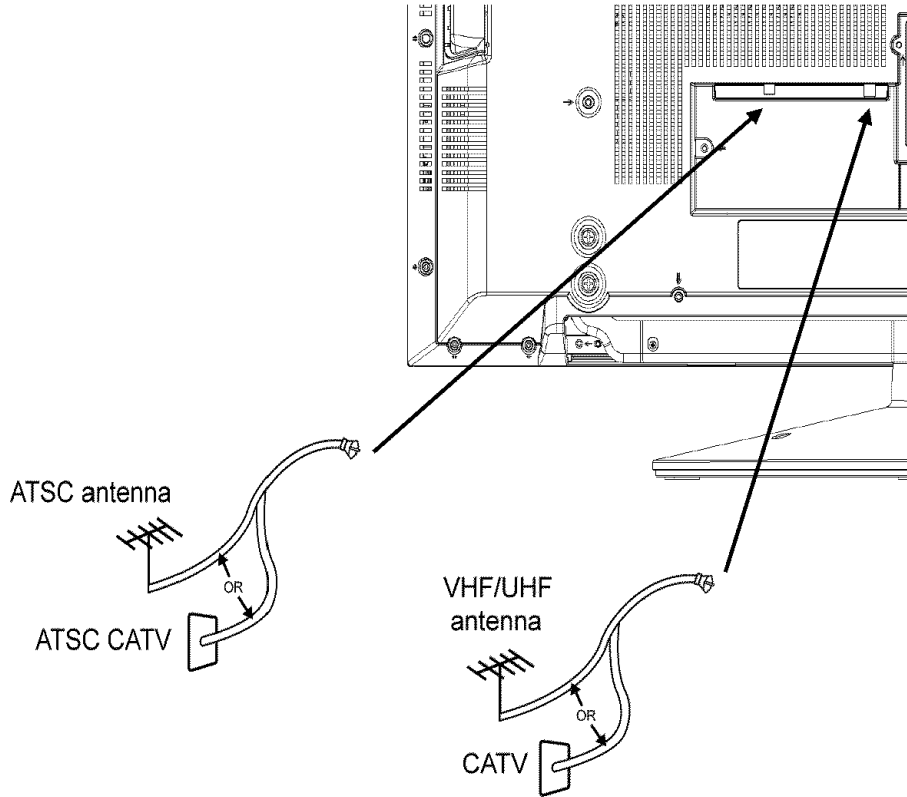

FRONT PANEL CONTROLS

FRONT VIEW

32"/37" LCD TV

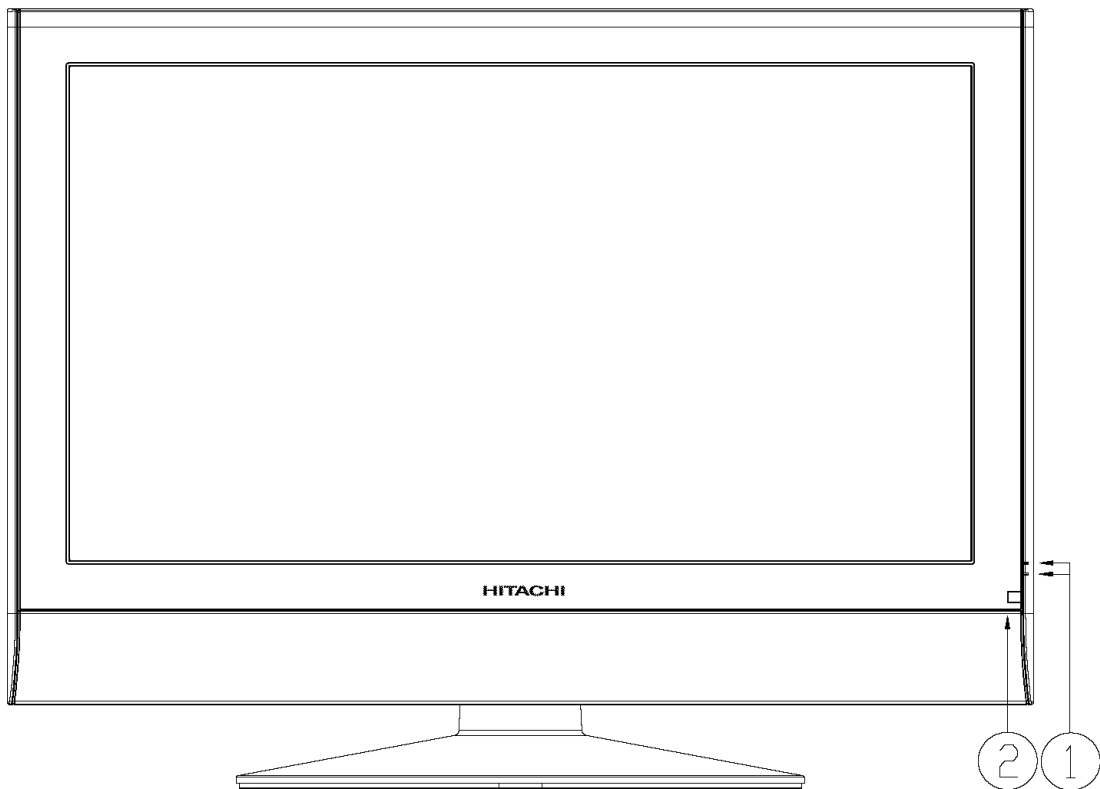

① POWER light indicator

To turn the LCD TV ON, press the main power button located on the bottom left side of the TV. A red stand-by indicator lamp located on the lower right corner of the front bezel will illuminate. The LCD TV is now ready for remote on/off operation.

Indicating Lamp	Power Status	Operating
Off	Off	When the MAIN POWER is set OFF.
Lights Red	Off (Stand-by)	When the MAIN POWER is set ON and the Front Key or Remote Control POWER is Off.
Lights Orange	Off (Power Saving)	1. When the MAIN POWER is set ON. 2. No signal input (Analog RGB).
Lights Green	On	When the POWER is ON.

② REMOTE CONTROL sensor

Point your remote control at this area when selecting channels, adjusting volume ,etc.

SIDE PANEL CONTROLS

SIDE VIEW 32"/37" LCD TV

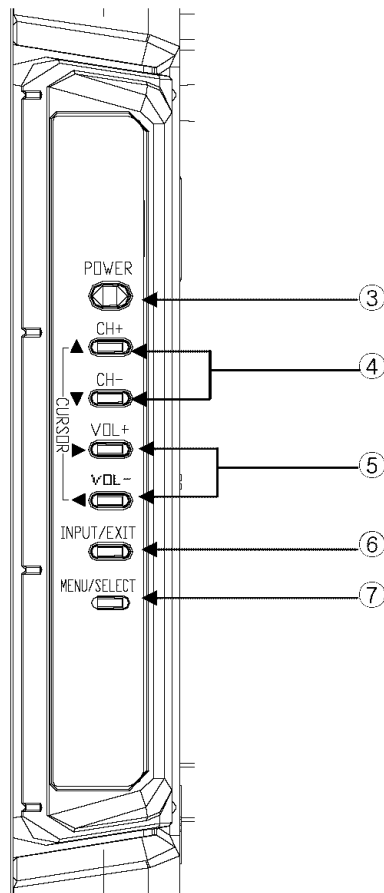

- ③ **POWER button**
This power button is for power on the LCD television or change to standby mode.
- ④ **CHANNEL selector**
Press these buttons until the desired channel appears in the top left corner of the TV screen. These buttons also serve as the cursor down (▼) and up (▲) buttons when in MENU mode.
- ⑤ **VOLUME level**
Press these buttons to adjust the sound level. The volume level will be displayed on the TV screen. These buttons also serve as the cursor left (◀) and right (▶) buttons when in MENU mode.
- ⑥ **INPUT/EXIT button**
Press this button to select the desired input: NTSC, DTV, VIDEO1~4, Analog RGB or HDMI source.
This button also serves as the EXIT button when in MENU mode.
- ⑦ **MENU/SELECT button**
This button allows you to enter the MENU, making it possible to set TV features to your preference without using the remote. This button also serves as the SELECT button when in MENU mode.

REAR PANEL MAIN POWER SWITCH & AC INPUT

32"/37" LCD TV

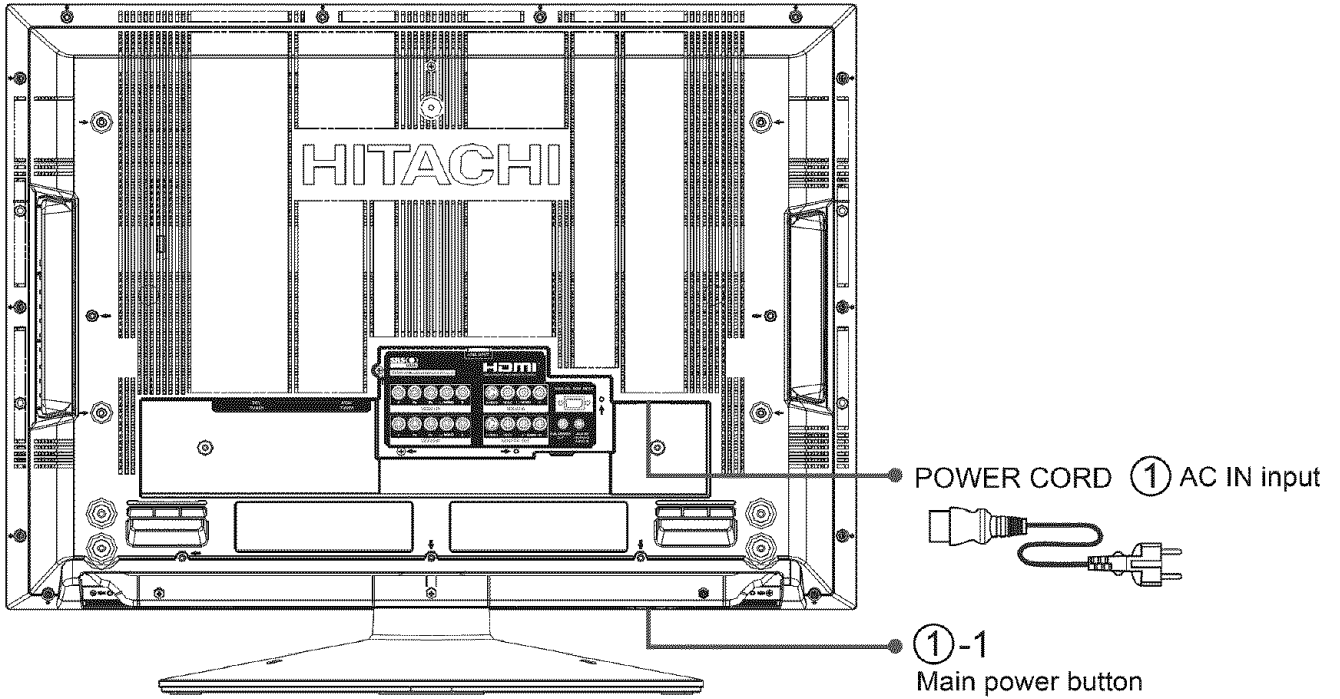

① AC IN input

This TV is designed to operate on 120VOLTS 60Hz AC current. Insert the TV power cord into a 120VOLTS 60Hz outlet.

①-1 Main power button:

This power button is for the complete system, and must be turned ON/OFF manually. It is recommended to leave the "MAIN POWER" to "ON" condition (lights red) for stand-by mode.

Note : It is required that there should be at least 5sec. between Main Power button off then on.

SIDE PANEL JACKS

32"/37" LCD TV

English

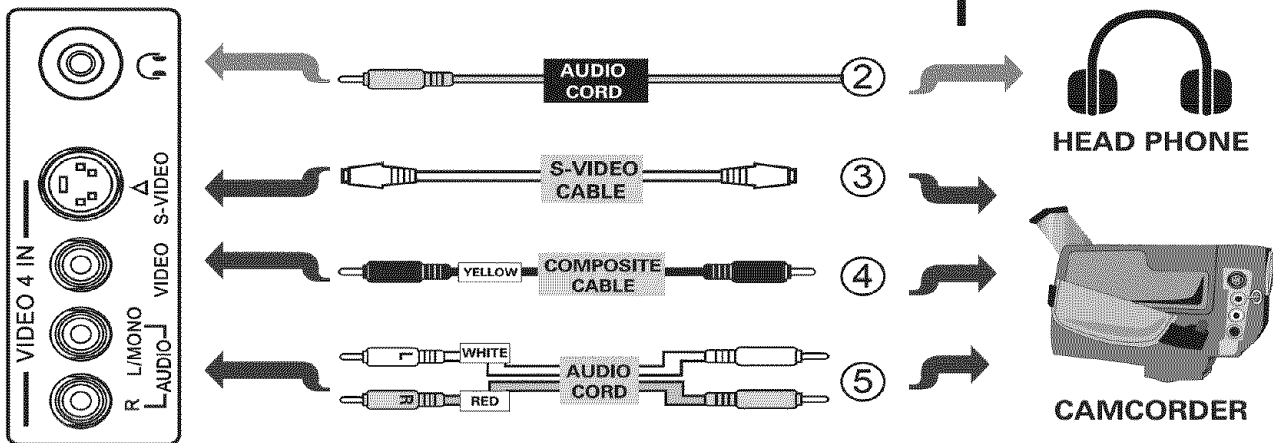
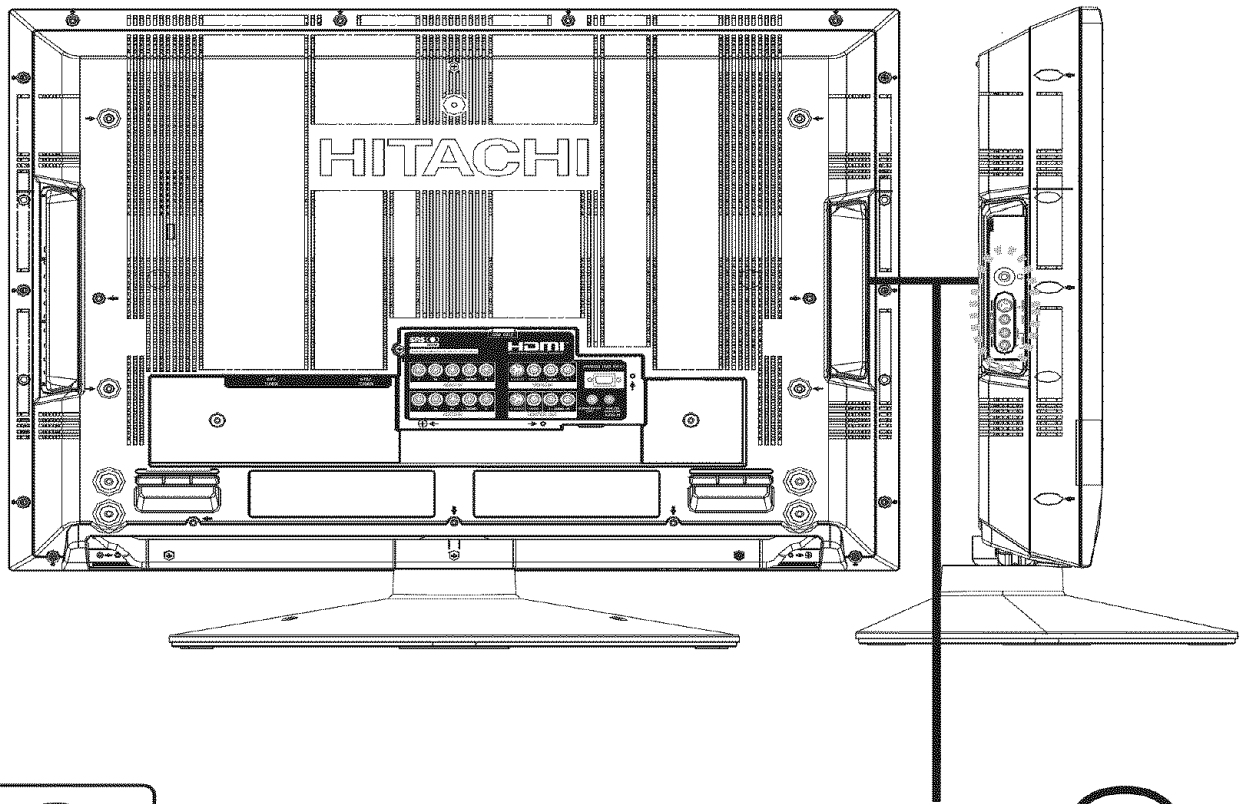

- ② **Head Phone**
Speakers is muted when insert it .To control volume: press volume button +, -.
- ③ **S-VIDEO (VIDEO 4)**
Provide S-VIDEO (Super Video) jacks for connecting equipment with S-VIDEO output capability
- ④ **VIDEO (VIDEO 4)**
By using the VIDEO button of the remote control, you can select VIDEO 4.Use the video inputs to connect external devices, such as camcorders.
- ⑤ **L / MONO / R (VIDEO 4)**
Connect audio of external devices.(if you have mono sound, insert the audio cable into the left (L) audio jack.

REAR PANEL JACKS

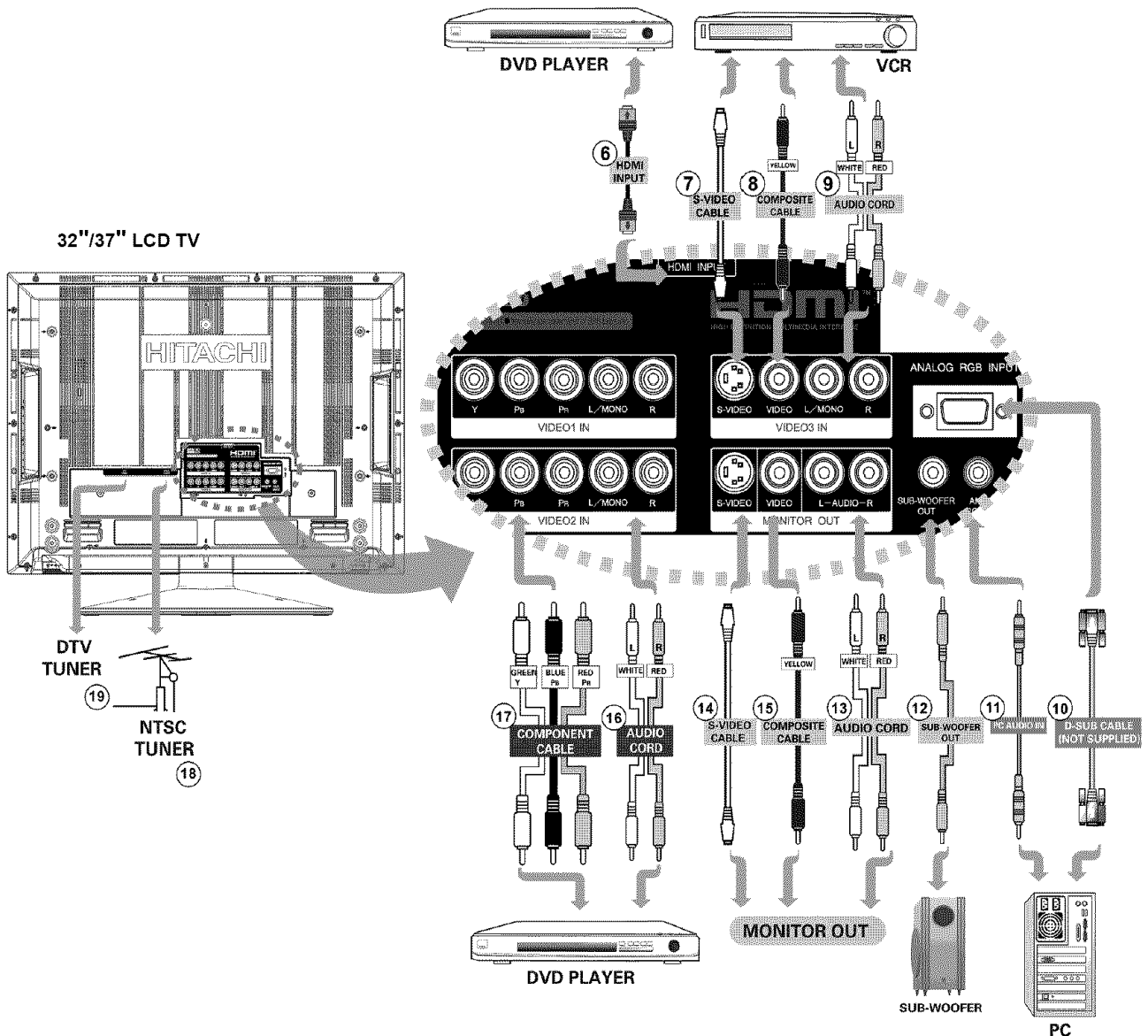

⑥ HDMI - Digital Input

About HDMI

HDMI is the next-generation all digital interface for consumer electronics. HDMI enables the secure distribution of uncompressed high-definition video and multi-channel audio in a single cable. Because digital television (DTV) signals remain in digital format, HDMI assures that pristine high-definition images retain the highest video quality from the source all the way to your LCD TV.

Use the HDMI input for your external devices such as Set-Top-Boxes or DVD players equipped with an HDMI output connection.



HDMI, the HDMI logo and High-Definition Multimedia Interface are trademarks or registered trademarks of HDMI Licensing LLC.

- NOTES: 1. The HDMI input is not intended for use with personal computers.
2. Only DTV formats such as 1080i, 720p, 480i and 480p are available for HDMI input.

⑦ S-VIDEO (VIDEO 3)

Provide S-VIDEO (Super Video) jacks for connecting equipment with S-VIDEO output capability.

⑧ VIDEO (VIDEO 3)

By using the VIDEO button of the remote control, you can select VIDEO3. Use the video inputs to connect external devices, such as VCRs, camcorders, laserdisc players, DVD players etc.

⑨ **L/ MONO / R (VIDEO 3)**

Connect audio of external devices.(if you have mono sound, insert the audio cable into the left (L) audio jack).

⑩ **ANALOG RGB INPUT**

Use this 15-pin D-Sub input for your external devices with RGB output using the D-Sub Mini 15-pin cable provided.

⑪ **ANALOG RGB / HDMI AUDIO IN**

Connect audio for ANALOG RGB and HDMI input.

NOTES: In case of using analog audio, when connecting with DVI-HDMI transformation connector, use ANALOG RGB / HDMI audio terminal for input.

⑫ **SUBWOOFER Output**

Connect this SUB WOOFER OUT output to the external audio component input.

⑬ **AUDIO Output**

These jacks provide fixed audio signal which are used for recording.

⑭ **MONITOR Output (S VIDEO)**

This jack provides S video signal which are used for recording. (Please refer to monitor output table as below)

⑮ **MONITOR Output (VIDEO)**

This jack provides video and audio signals which are used for recording. (Please refer to monitor output table as below)

Monitor output table:

(a) Normal mode:

Output Input	S-VIDEO	VIDEO	AUDIO
DTV	○	○	○
NTSC	x	○	○
VIDEO1/ VIDEO2	x	x	x
VIDEO3/ VIDEO4 (VIDEO)	x	○	○
VIDEO3/ VIDEO4 (S-VIDEO)	○	x	○
ANALOG RGB	x	x	x
HDMI	x	x	x

(b) For POP/PIP mode:

The monitor output is according to user's selected source, the speaker's position.
The output table should be the same with the above table.

⑯ **L/MONO /R (VIDEO 1 and VIDEO 2)**

Connect audio of external devices.(if you have mono sound, insert the audio cable into the left (L) audio jack).

⑰ **Y-PBPR (VIDEO 1 and VIDEO 2)**

Provide Y-PBPR jacks for connecting equipment with this capability, such as a DVD player or Set Top Box

⑱ **NTSC TUNER**

RF input that connects to the antenna, cable box, or CATV cable. Support NTSC TV system.

⑲ **DTV TUNER**

RF input that connects to the antenna, cable box, or CATV cable. Support ATSC TV system.

CONNECTING EXTERNAL SOURCES

The exact arrangement you use to connect the PC, VCR, camcorder, laserdisc player, DVD player, or HDTV Set Top Box to your LCD TV is dependent on the model and features of each component. Check the owner's manual of each component for the location of video and audio inputs and outputs.

The following connection diagrams are offered as suggestions. However, you may need to modify them to accommodate your particular assortment of components and features. For best performance, video and audio cables should be made from coaxial shielded wire.

CONNECTING A DIGITAL TV ANTENNAS

1. Attach an ATSC antenna cable to the DTV TUNER terminal.
2. Connect the outdoor antenna cable lead-in to the terminal marked DTV TUNER on the rear of the TV set.
3. Connect all power sources before activating the LCD TV.
4. Turn on the LCD TV.
5. Press DTV on the remote.

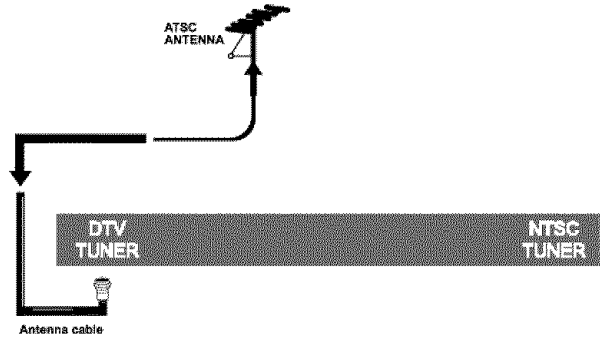

NOTES: Refer to the owner's manual of the external equipment to be connected. When connecting external equipment, do not connect the AC power cords to wall outlets until all other connections are completed.

CONNECTING ANALOG TV CABLE OR ANALOG ANTENNA WITHOUT A TV CABLE BOX

1. Use one of the following two diagrams if you connect to an outdoor antenna.
 - A: Using a VHF/UHF combination outdoor antenna.
 - B: Using separate VHF and/or UHF outdoor antennas.
2. Connect all power sources before activating the LCD TV.
3. Turn on the LCD TV.
4. To use the TV, press NTSC on the remote.

A

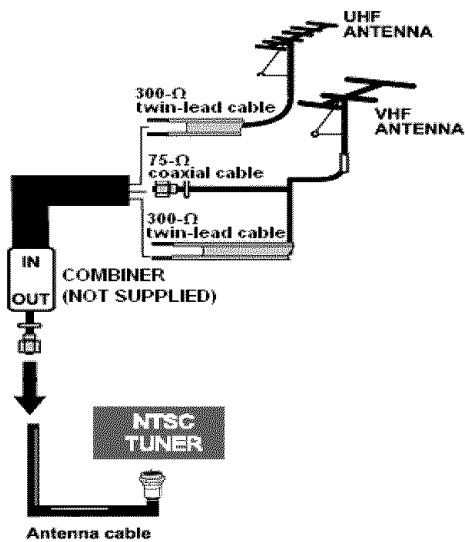

B

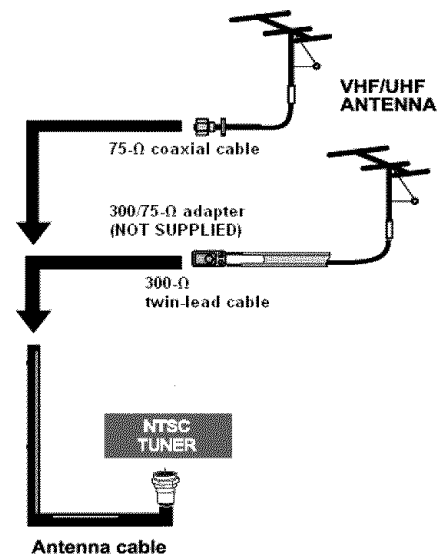

NOTES: Ensure that the power cord is inserted correctly to avoid connector damage.

CONNECTING EXTERNAL SOURCES

CONNECTING HDTV SOURCES

HDTV input sources, such as a digital cable box, digital satellite receiver, or digital terrestrial receiver box, can be connected as desired, using the appropriate cable system.

1. Connect the HDTV source device using the appropriate cable pair, in the following order of preference:

HDMI cable OR

Component cable and audio cable (Video 1 or Video 2)

2. Connect all power sources before activating the LCD TV.

3. Turn on the LCD TV.

4. Press the button corresponding to the appropriate signal source (Video 1 or Video 2)

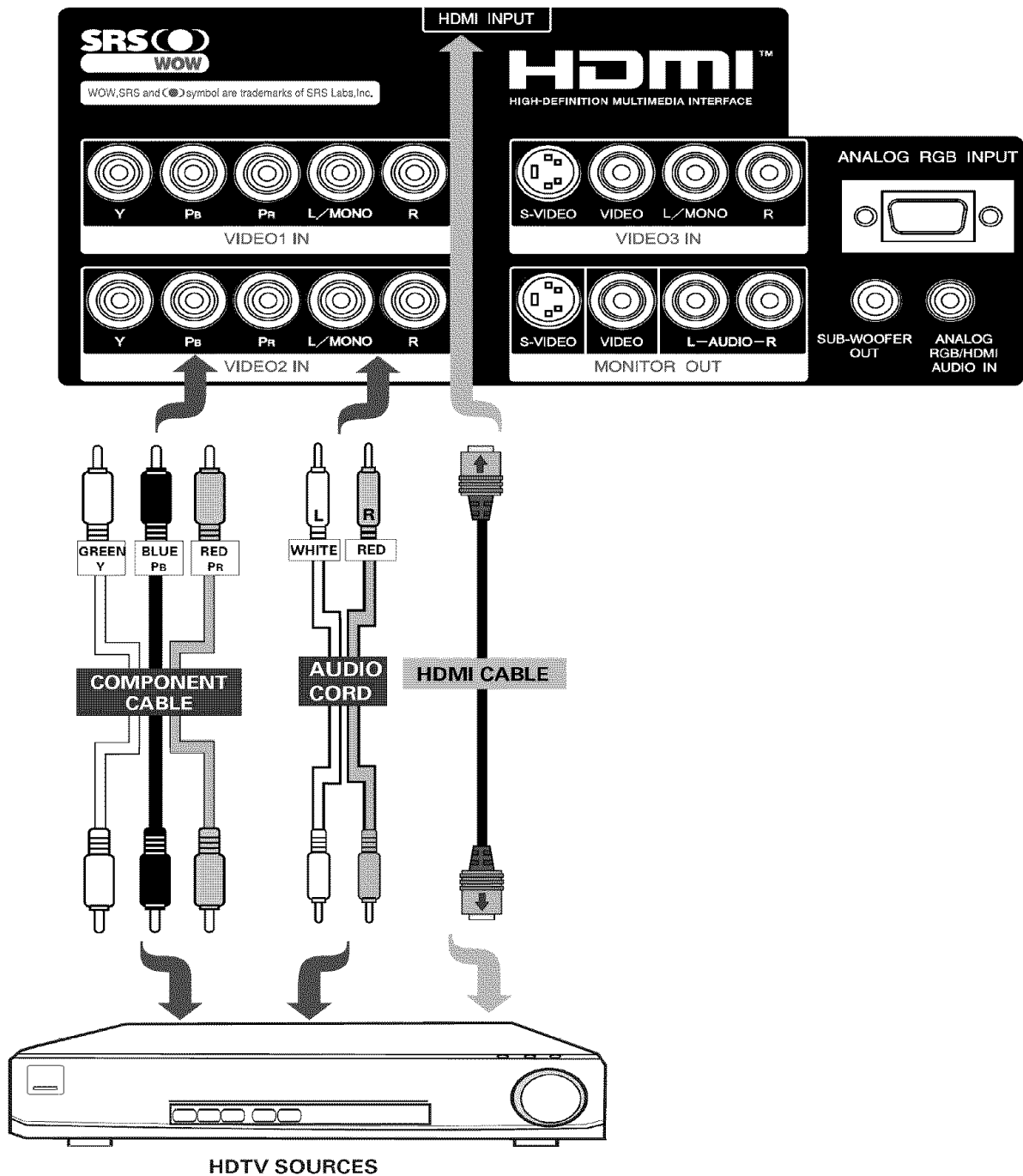

CONNECTING EXTERNAL SOURCES

CONNECTING A TV CABLE BOX OR SATELLITE RECEIVER

1. Connect the TV Cable Box or Satellite Receiver device using:
Component cable and Audio cable (Video 1 or Video 2) OR
S-Video cable and Audio cable (Video 3 or Video 4) OR
Composite Video cable and Audio cable (Video 3 or Video 4).
2. Connect all power sources before activating the LCD TV.
3. Turn on the LCD TV.
4. Press the button corresponding to the appropriate signal source.
(VIDEO1 to 4)

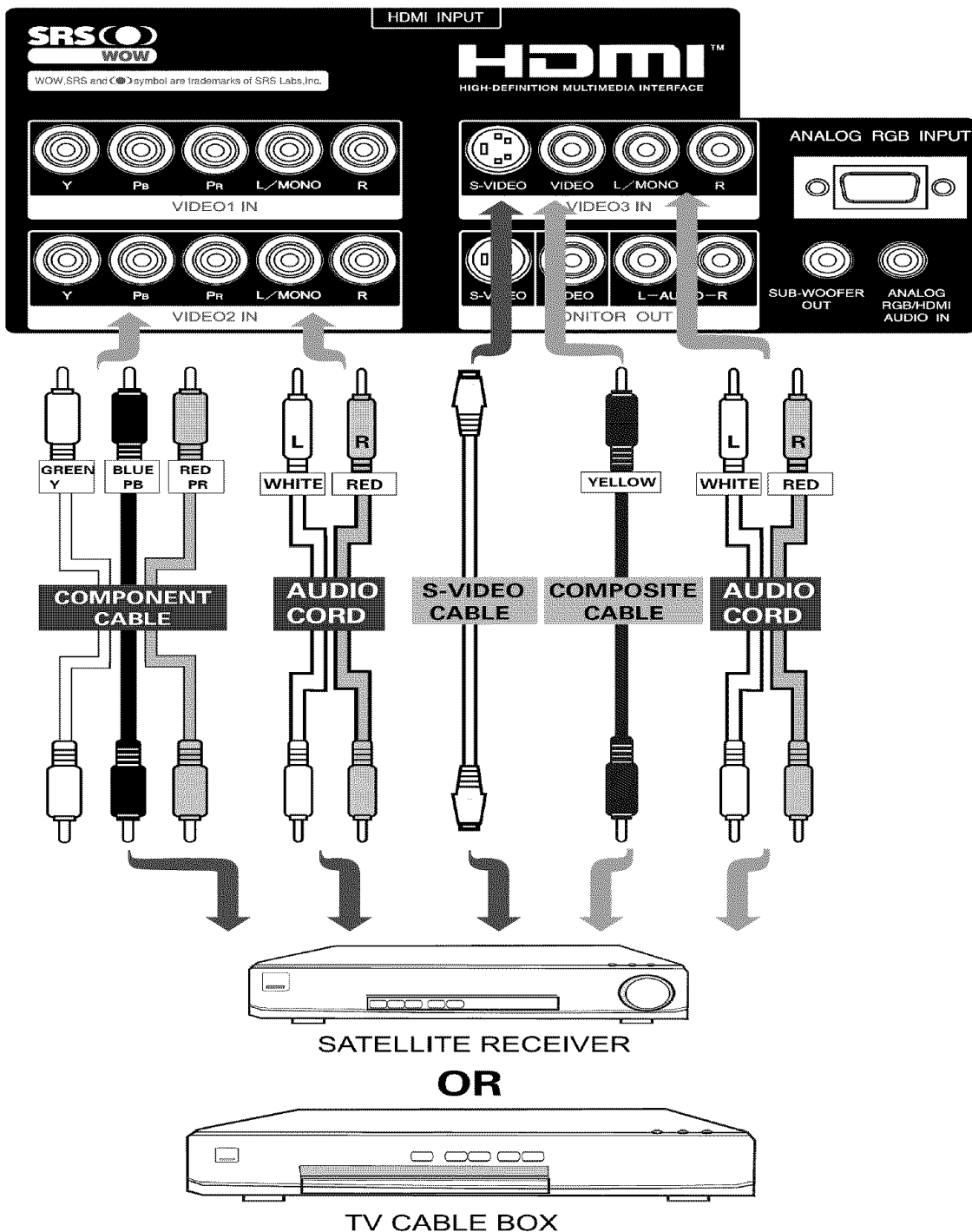

CONNECTING EXTERNAL SOURCES

CONNECTING A DVD PLAYER

1. Connect the DVD player using:

HDMI cable OR

Component cable and Audio cable (Video 1 or Video 2) OR

S-Video cable and Audio cable (Video 3 or Video 4) OR

Composite cable and Audio cable (Video 3 or Video 4).

2. Connect all power sources before activating the LCD TV.

3. Turn on the LCD TV.

4. Press the button corresponding to the appropriate signal source.

(VIDEO1 to 4)

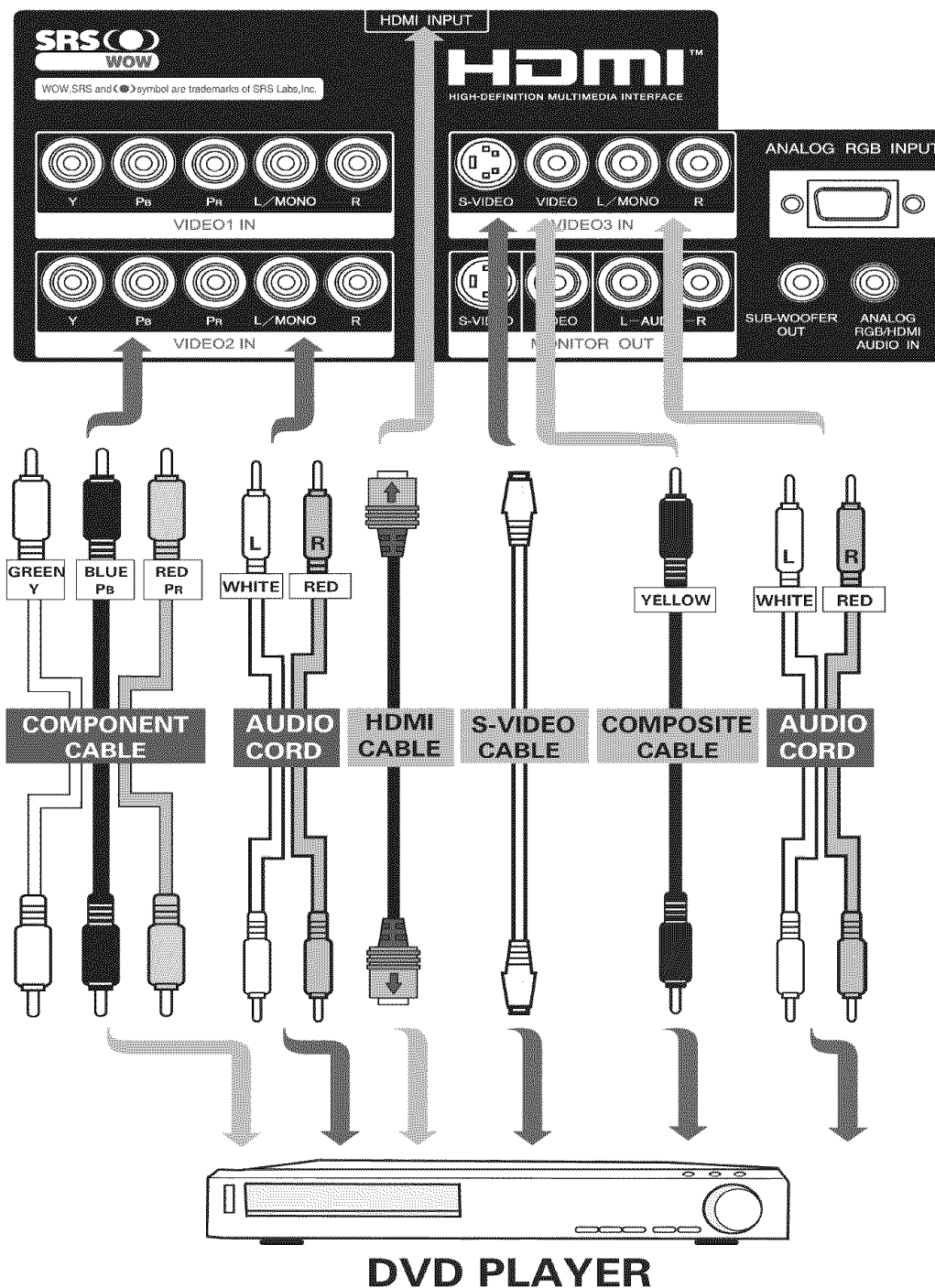

CONNECTING EXTERNAL SOURCES

CONNECTING A VCR

1. Connect the VCR player using:

S-Video cable and Audio cable (Video 3 or Video 4) OR

Composite cable and Audio cable (Video 3 or Video 4).

2. Connect all power sources before activating the LCD TV.

3. Turn on the LCD TV.

4. Press the button corresponding to the appropriate signal source (VIDEO3 or VIDEO4).

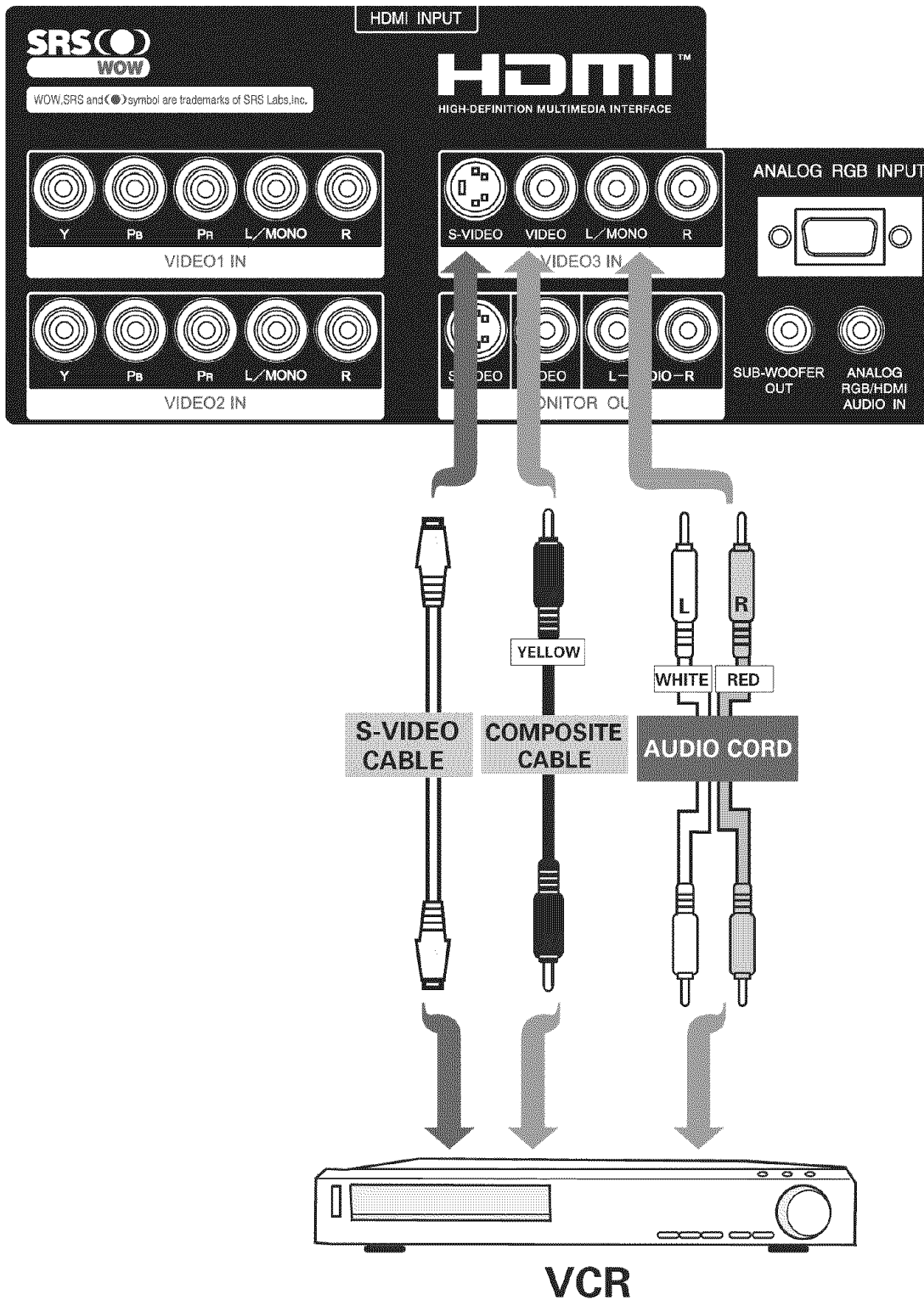

CONNECTING EXTERNAL SOURCES

CONNECTING A AUDIO RECEIVER

To improve sound quality, you may want to play the audio of the LCD through your stereo system.

1. Use an audio cable to connect the LCD's audio output jacks to the line input jacks on the A/V receiver.
2. Connect all power sources before activating the LCD TV.
3. Turn on the LCD TV.
4. Press the MENU to display the menu, then press ▲ ▼ to select Audio.
5. Press SEL, then press ▲ ▼ to select subwoofer and press ◀ ▶ to select On/Off.

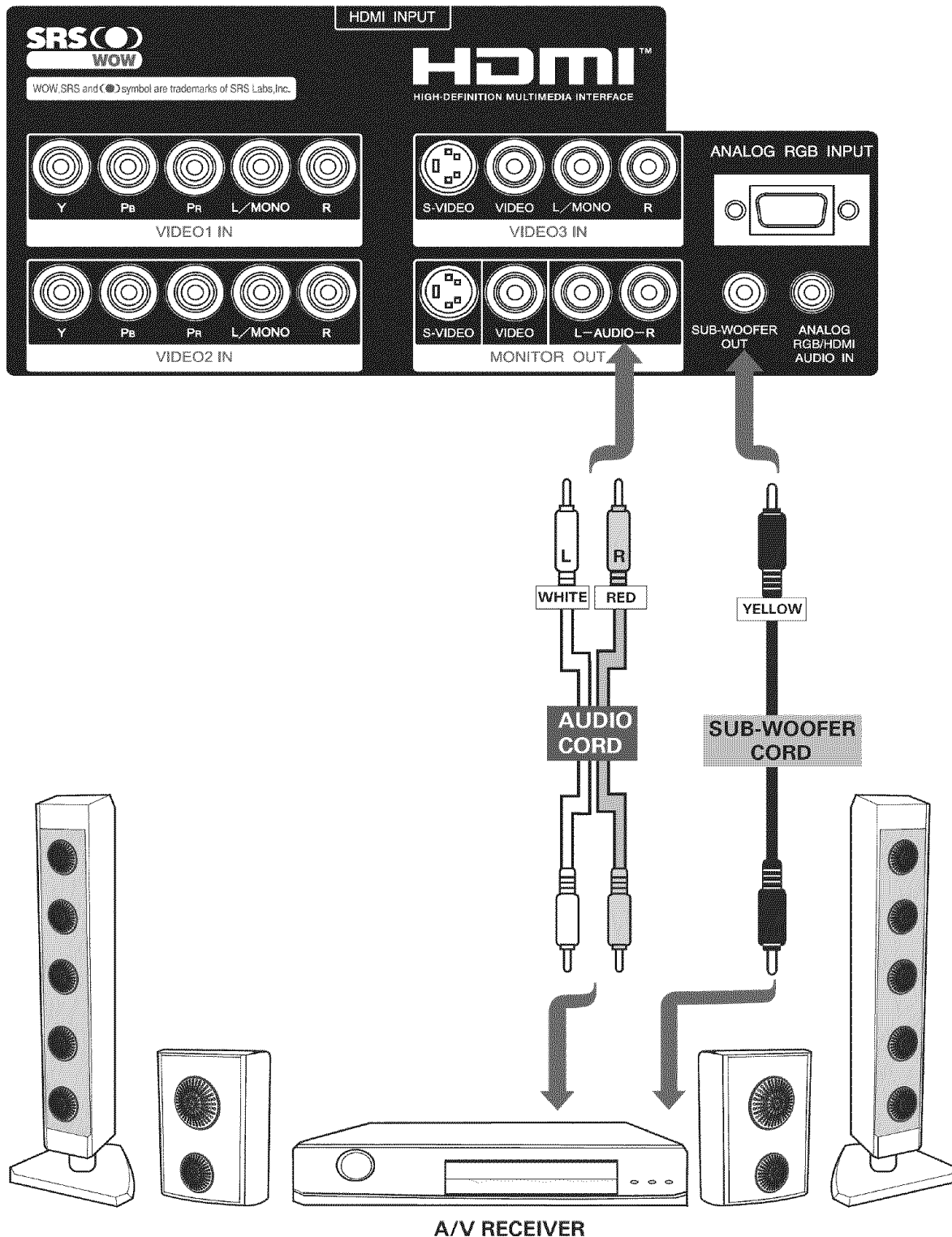

CONNECTING EXTERNAL SOURCES

CONNECTING PC

1. Connect the PC using:

D-Sub cable and 3.5mm Audio cable

2. Connect all power sources before activating the LCD TV.

3. Turn on the LCD TV.

4. Press the button corresponding to the appropriate signal source (ANALOG RGB INPUT)

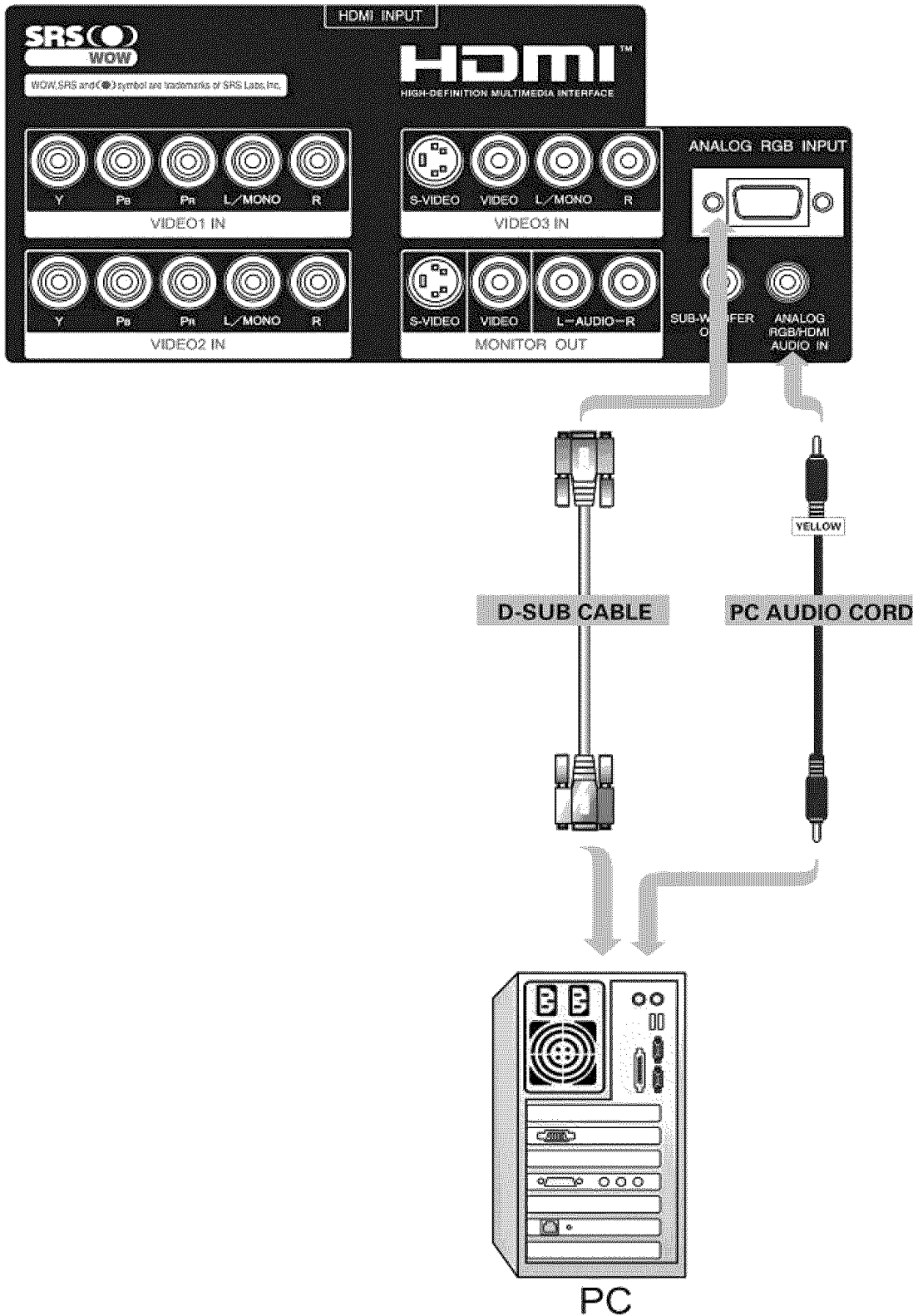

5.This LCD Television can automatically detect and display the signal format as below.

Recommended Signal List

No.	Signal Mode			
	Signal Name	Resolution	Vertical Frequency (Hz)	Horizontal Frequency (kHz)
1	VGA	640 x 480	59.94	31.47
2	VESA	800 x 600	56.25	35.16
3	VESA	800 x 600	60.32	37.88
4	VESA	1024 x 768	60.00	48.36
5	VESA	1280 x 768	60.00	47.73
6	1080i	1080	59.94	33.72
7	720p	720	59.94	44.96
8	480p	480	59.94	31.47
9	480i	480	59.94	15.75

TIPS ON REAR PANEL CONNECTIONS

- S-VIDEO (Video 3 or Video 4) , Y-P_BP_R (Video 1 or Video 2) or HDMI connections are provided for higher performance laserdisc players etc. that have this feature. Use these connections in place of the standard video connection if your device has this feature.
- If your device has only one audio output (mono sound), connect it to the left (L) audio jack on the TV.
- Refer to the operating guide of your other electronic equipment for additional information on connecting your hook-up cables.
- Connect only 1 component (VCR, DVD player, camcorder, etc.) to each input jack.
- COMPONENT: Y-P_BP_R (Video 1 or Video 2) connections are provided for higher performance devices appliance, such as DVD players and set-top-boxes. Use these connections in place of the standard video connection if your device has this feature.
- Your component outputs may be labeled Y, B-Y, and R-Y. In this case, connect the components B-Y output to the TV's P_B input and the components R-Y output to the TV's P_R input.
- It may be necessary to adjust TINT to obtain optimum picture quality when you use the Y-P_BP_R inputs (Video 1 or Video 2).
- To ensure no copyright infringement, the VIDEO OUTPUT will be abnormal, when using the Y-P_BP_R (Video 1 or Video 2), PC RGB IN and HDMI input jacks.
- When you use a HDMI-IN input from a DVD player or a Set-Top-Box, it is recommended to use a 1080i or 720p input signal.

HOW TO USE THE REMOTE CONTROL TO CONTROL YOUR LCD TV

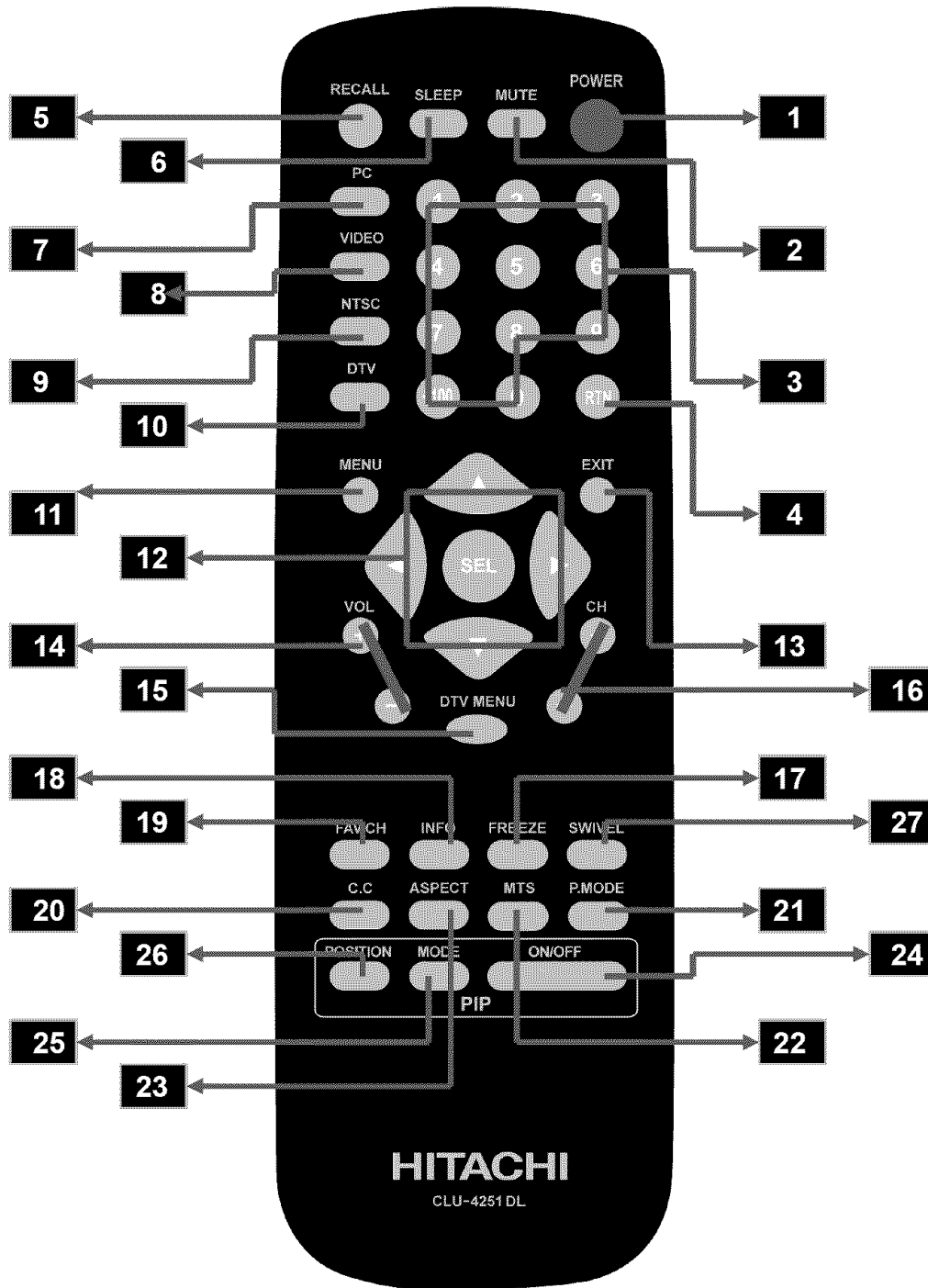

1. **Power button:** Press this button to turn the display set on or standby.
2. **Mute button:** Press to mute audio. (Press "Mute" or "VOL" button + to return to the normal mode)
3. **Channel selector buttons:** Select channel number. For example when choose channel 27, first press 2 and then press 7. When choose 101, first press +100 and 0, then press 1.
For DTV, If you like to choose channel 80-3, please first press 8 and then 0, and then press "▶" and "3".
4. **Return button:**
 - A. Press to return previous TV channel state in standard TV mode.
 - B. Press to return previous OSD menu when the OSD menu opening.

5. **RECALL button:** Press to display source input signal on the display.
6. **SLEEP button:** Press to set sleep mode timer. There are 30 minutes, 60 minutes, 90 minutes, 120 minutes and turn off to select.
7. **PC Source button:** Press to select PC mode or HDMI mode.
8. **VIDEO Source button:** Set up the input source of Video; including Video1 (Y1P_B1P_R1), Video2 (Y2P_B2P_R2), Video3(AV1 / SV1), Video4 (AV2 / SV2). If both SV and AV had signal input at the same time, the SV has higher priority output.
9. **NTSC Source button:** Set up the input source of NTSC; including CATV / AIR.
10. **DTV Source button:** Set up the input source of DTV Mode.
11. **Menu button:** Turn on OSD (On-Screen Display) menu.
12. **Direction buttons:**
 - i. (**▲/▼/◀/▶/SEL**): All the OSD features can be set or adjusted by using these buttons; it will highlight functions or adjust and set different features. Press it to toward desired direction and press the SEL button to select. (You can notice that the OSD prompt message to through these keys operation)
 - ii. (**▲/▼**): In PIP mode, Press "▲" or "▼" buttons to select which display window will be changed. Meanwhile, the speaker icon will be displayed on selected display window. User can change input video source on selected display window by pressing remote control source keys.
 - iii. (**◀/▶**): In POP mode, Press "◀" or "▶" buttons to select which display window will be changed. Meanwhile, the speaker icon will be displayed on selected display window. User can change input video source on selected display window by pressing remote control source keys.
 - iv. (**◀/▶**): Press "◀" button to turn swivel left and press "▶" button to turn swivel right while OSD indicator for swivel is displayed on TV screen.
13. **Exit button:** This button will exit all OSD.
14. **Volume (+/-) button:** Press to select the desired volume.
15. **DTV Menu:** Turn on DTV OSD (On-Screen Display) menu in DTV Mode.
16. **Channel (+/-) button:** Press to select the desired channel.
17. **Freeze button:** Pause the image in DTV Mode.
18. **INFO button:** Display information of DTV Mode: Channel Banner, time, Closed Caption status, and resolution Mode.
19. **FAV.CH:** Switch to favorite channel in DTV Mode.
20. **C.C. button:** Press to turn on/off TV Closed Caption.
21. **P. Mode button:** Select picture status, there are Dynamic, Natural, Cinema and Game.
22. **MTS button:** Press to set sound mode, there are Stereo, SAP and Mono.
23. **Aspect button:** Press repeatedly to change image to different aspects. Aspects include 4:3 STANDARD, 4:3 EXPANDED, 4:3 ZOOM1, 4:3 ZOOM2, 16:9 STANDARD, 16:9 ZOOM.

Depending on the input signal format received, the picture format ratio allows you to adjust the images through the following options.

4:3 STANDARD	Use this aspect mode to display conventional (4:3) images. Side panels (gray areas) are placed to the left and right of the image to preserve the original aspect ratio of the source. Note: Use this mode for only 15% of your total viewing time to prevent uneven aging of the phosphors. Phosphors in the lighted area of the picture will age more rapidly than the gray areas.
4:3 EXPANDED	Use this aspect mode to display conventional (4:3) sources by linearly increasing image expansion from the center towards the edges of the display area in order to fill it.
4:3 Zoom1/Zoom2	Use these aspect modes to zoom in on conventional (4:3) sources.
16:9 STANDARD	Use this aspect mode to display 16:9 sources like HDTV and DVD's preserving the original 16:9 aspect ratio.
16:9 Zoom	Use this aspect to Zoom-in once while in 16:9 aspect.

HOW TO USE THE REMOTE CONTROL TO CONTROL YOUR LCD TV

(1) NTSC/480i/480p Input

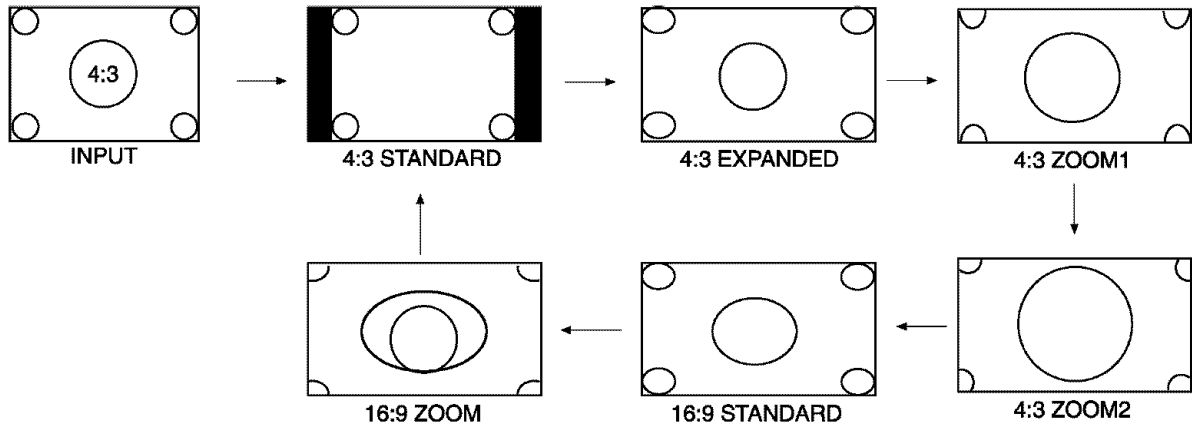

(2) 480i/480p Input

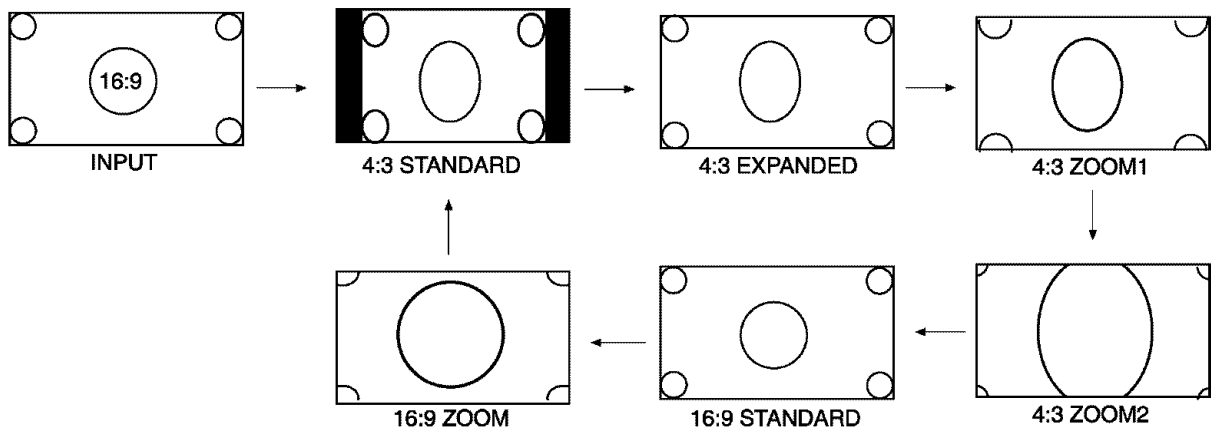

(3) 720p/1080i Input

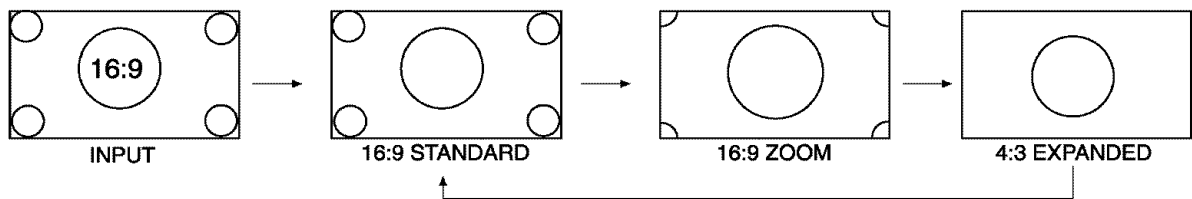

(4) RGB Input

Auto adjust to full size and aspects include 4:3 STANDARD, 16:9 STANDARD.

Multi picture function buttons:

24. **ON / OFF:** Press to turn on/off multi picture function.
25. **Mode:** Press to select POP or PIP mode.
26. **Position:** While multi picture mode set on PIP mode, press the button to change sub picture position

NOTES - For changing TV channel under PIP function

1. One TV source (NTSC or DTV) in main picture or sub picture:
Press directly channel+/-, number and return buttons on remote control to change the channel.
2. Both NTSC and DTV sources in main picture and sub picture:
Press recall button to display the audio source info. After select the audio source to the mode you desire, then press Channel +/-, number and return buttons on remote control to change the channel.

HOW TO USE THE REMOTE CONTROL TO CONTROL YOUR LCD TV

POP Mode Main-picture and Sub- picture source selection table:

Please note Main(Left)-picture and Sub(Right)- picture source can't be the same

Sub(Right) Main(Left)	NTSC TUNER	DTV TUNER	VIDEO1	VIDEO2	VIDEO3	VIDEO4	HDMI-INPUT	ANALOG RGB INPUT
NTSC Tuner		○	○	○	○	○	X	X
DTV Tuner	○		○	○	○	○	X	X
VIDEO1	○	○		○	○	○	X	X
VIDEO2	○	○	○		○	○	X	X
VIDEO3	○	○	○	○		○	X	X
VIDEO4	○	○	○	○	○		X	X
HDMI-INPUT	○	○	○	○	○	○		X
ANALOG RGB INPUT	○	○	○	○	○	○	X	

PIP Mode Main(Large)-picture and Sub(Small)- picture source selection table:

Sub(Small) Main(Large)	NTSC TUNER	DTV TUNER	VIDEO1	VIDEO2	VIDEO3	VIDEO4	HDMI-INPUT	ANALOG RGB INPUT
NTSC Tuner		X	X	X	X	X	X	X
DTV Tuner	X		X	X	X	X	X	X
VIDEO1	X	X		X	X	X	X	X
VIDEO2	X	X	X		X	X	X	X
VIDEO3	X	X	X	X		X	X	X
VIDEO4	X	X	X	X	X		X	X
HDMI-INPUT	○	○	○	○	○	○		X
ANALOG RGB INPUT	○	○	○	○	○	○	X	

LEGEND

O = Possible

X = Not Possible

27. SWIVEL FUNCTION

1. Press swivel button

After pressing swivel button on the remote, OSD indicator will display on TV screen.

The OSD indicator will disappear, if stop manipulating remote in 15 seconds.

2. Adjust swivel by pressing direction button

Press left button to turn swivel left and press right button to turn swivel right.

The rotation angle of swivel is ± 30 degree.

3. The rotation will stop if the direction button is released.

4. Swivel can not be used during Auto Scan Mode.

NOTE: A Cable tie is used to bundle all the signal cables together and makes the cable connections tidy.

In accessories pack , there are two different type of cable tie to meet user's requirement.

Put the power cord through the cable clamp which is attached to the back of the TV and then tie it with other cables by cable tie.

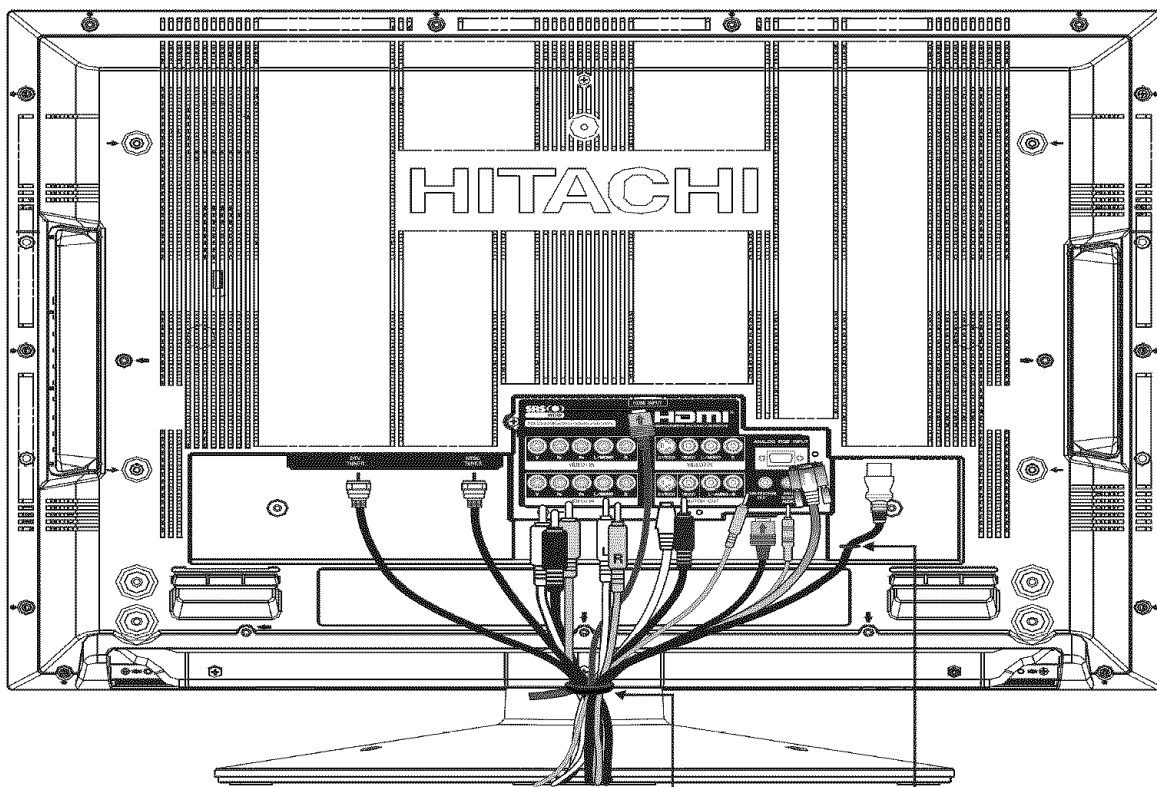

Cable Tie Cable Clamp

ATTENTION

- Do not push the panel manually while using the swivel function. It could cause damage to the stand or the panel.
- Do not get on and hang from the TV. Do not swing the TV back and forth and around either. It could cause a failure of the stand.
- Do not put hands or faces close to the TV while operating the swivel function. It could cause a physical injury. Use special caution in households where children are present.
- Do not put any object, like a vase, near the TV in swiveling area. It would cause a breakage of the object and /or a failure of the stand.
- Place the TV on the stable location, or the swivel function would not operate correctly. It would cause a malfunction.
- In the case of using the TV wall mounted, be sure to detach the connecting cable between the TV and the stand.

OSD (On-Screen Display)

USING THE ON-SCREEN DISPLAY (OSD) CONTROLS

1. Press MENU on the remote control to display the different features on your HITACHI LCD TV.
2. Use the ▲▼◀▶ to navigate to different menu item.
3. Use the ◀▶ to adjust functions.
4. Press SEL on the remote control to select functions.
5. Press EXIT on the remote control to quickly exit from a menu.

THERE ARE TWO DIFFERENT MODES FOR THE OSD AS FOLLOWS:

NTSC TV/DTV/Video/HDMI Mode: Display when the NTSC, DTV, VIDEO1 to 4 or HDMI is selected.

PC Mode: Display when the Analog RGB input is selected.

NTSC TV/DTV/Video/HDMI Mode

Video	Picture Mode
	Contrast
	Brightness
	Color
	Sharpness
	Tint
	Color Temperature
	Backlight
	Reset
	Audio
Treble	
Balance	
SRS WOW	
Subwoofer	
Initial Setup	Language
	Auto Channel Scan
	Closed Caption
	Channel List
	V-Chip
	Set Lock Code
	Manual Tuning

PC Mode

PC Picture Position	Auto Adjust
	Vertical Position
	Horizontal Position
	Horizontal Clock
	Clock Phase
	Reset
	PC Picture
Brightness	
Color Temperature	
R	
G	
B	
Audio	Reset
	Bass
	Treble
	Balance
	Subwoofer

NTSC TV/ VIDEO Mode OSD (On-Screen Display)

Video

Adjust the picture mode, contrast, brightness, color, sharpness, tint, color temperature, backlight and reset of your display.

Video	Function	Options
Picture Mode	Select a preset customized picture setting.	- Dynamic - Natural - Cinema - Game
Contrast	Adjust the color brightness of the display.	0 to 100
Brightness	Adjust the darkness and lightness of the display.	0 to 100
Color	Adjust the saturation level of color.	0 to 100
Sharpness	Adjust the clarity of images.	0 to 100
Tint	Adjust the color properties.	0 to 100
Color Temperature	Select the level of the color temperature.	- High - Low
Backlight	Adjust the backlight of the display.	0 to 63
Reset	Reset all of your display settings back to factory default.	OK

Audio

Adjust the bass, treble, balance, SRS WOW and Subwoofer of your sound.

Audio	Function	Options
Bass	Increase and decreases the level of bass.	-16 to +16
Treble	Increase and decreases the level of treble.	-16 to +16
Balance	Adjust the left and right sound level.	-16 to +16
SRS WOW	Turn SRS WOW function on and off.	On or Off
Subwoofer	Turn Subwoofer function on and off.	On or Off



SRS WOW is an audio enhancement technology from SRS Labs that provides deep, rich bass on any speaker system without the need for a subwoofer or additional extra physical components. For systems with a subwoofer, SRS WOW complements and enhances the bass performance. This feature can be set to On or Off.

NOTE: WOW, SRS and the  symbol are trademarks of SRS Labs, Inc. SRS WOW technology is incorporated under license from SRS Labs, Inc.

NTSC TV/ VIDEO Mode OSD (On-Screen Display)

Initial Setup

Adjust the language, auto channel scan, closed caption, channel list, V-chip and set lock code select function of your display.

Initial Setup	Function	Options
Language	Set the language for the OSD.	- English - Francais - Espanol
Auto Channel Scan	Choose a TV source, performs an automatic channel search, add and delete channels. (Not available for Video signal)	TV Source: Air or CATV Channel Auto Search: Scan channels 1 to 125 for a signal and Add or Erase channel. See "Setting Up The TV Channels" on page 36.
Closed Caption	Display text. (Not available for Video signal)	See "Setting up the Closed Caption" on page 36.
Channel List	Display memorize channel, add and delete channels (Not available for Video signal)	See "Setting Up The TV Channels" on page 36.
V-Chip	Require a password to be entered to view movies and TV programs with unsuitable ratings for some viewers who share the TV. (Not available for Video signal)	See "Setting up the V-chip" on page 36.
Set Lock Code	Set and enter a new password. (Not available for Video signal)	Press "menu" key to turn on OSD menu. Then, selecting "initial setup" turn on next OSD menu. And then, selecting "set lock code" menu will show a key icon. Please press "o" to pass through and turn on next OSD menu, too. Please select "set lock code" item to set a new password. Finally, please press "Finish" to well complete. NOTE: If you forget the password, please enter "1234" to erase the password.
Manual Tuning	If the channel reception is poor, fine tune the program	See "Setting up Manual Tuning" on page 37.

SETTING UP THE V-CHIP

V-Chip

The V-chip feature requires setting on/off to be entered to view movies and TV programs with unsuitable ratings for some viewers who share the TV.

Follow these steps to lock movies and TV programs:

1. Press the MENU button on the remote control to bring up the OSD menu.
2. Continue to press the ▼ button to choose " Initial setup" , press" set lock code" to bring up a lock picture. press " 0" button →set lock code →press "Finish" button →press the SEL button.
3. Use the ▲▼ buttons to highlight V-chip, and then press the SEL button.
4. Use the following table to set up your V-chip.

V-chip	Function	Options
V-Chip	Block selected V-Chip function.	On, Off
Set TV Ratings	Block selected TV-rating and all ratings be below it.	TV-Y, TV-Y7, TV-G, TV-PG, TV-14, TV-MA
Set Movie Ratings	Block selected movie rating and all ratings be above it.	NR ,G, PG, PG-13, R, NC-17, X

TV Guidelines Blocking

Ratings	Age-defined	Contents of TV Guidelines						
		Show	Block					
TV-Y	Young children	Show	Block					
TV-Y7	Children 7 and over	Show	Block	*FV				
TV-G	General audience	Show	Block					
TV-PG	Parental guidance suggested	Show	Block		*V	*S	*L	*D
TV-14	Viewers 14 and over	Show	Block		*V	*S	*L	*D
TV-MA	Mature audience only	Show	Block		*V	*S	*L	

*FV: Fantasy or cartoon violence

V: Violence

S: Sexual content

L: Offensive language

D: Dialogue (sexual innuendo)

MPAA Rating

Ratings	Age-defined
G	General audience (no restrictions)
PG	Parental guidance suggested
PG-13	Parents strongly cautioned
R	Restricted. Children under 17 should be accompanied by an adult
NC-17	No Children under 17
X	Adults only
NR	NOT RATED (NR). Contains no rating. Not Rated (NR) and Not Applicable (NA) programs.

When a viewer attempts to watch a blocked channel, this message appears:

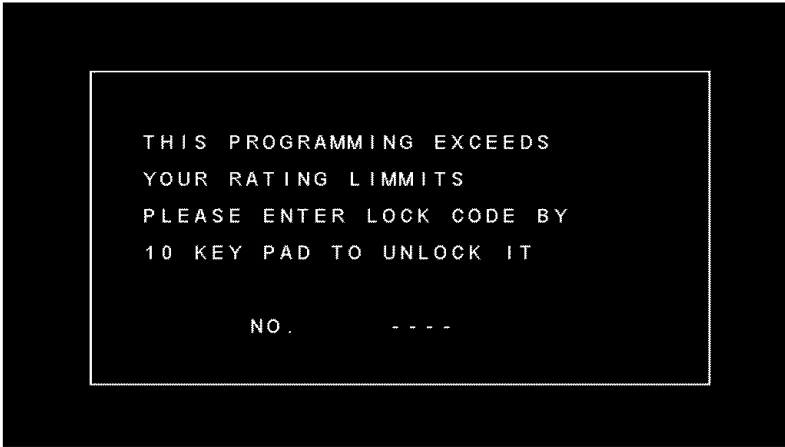

The channel will remain blocked until the correct lock code is entered.

SETTING UP THE CLOSED CAPTION

Closed Caption

For some TV programs, LCD has the de-coding and "Close Caption" functions. This caption is usually served for the deaf or the foreign language translation. All VCRs can record Close Caption signals from TV programs, so videos will also show the "Close Caption" function.

(a). OSD menu to set following these steps as below:

1. Press the MENU button on the remote control to bring up the OSD menu.
2. Use the ▲▼ buttons to highlight the Closed Caption function, and then press the SEL button to view the options.
3. Use the ▲▼ buttons to highlight Caption and Text, and then press the SEL button.
4. Use the following table to set up your Closed Caption.

Closed Caption	Function	Options
Caption	Select the Caption mode	CC1, CC2, CC3, CC4
Text	Select the Text mode	TT1, TT2, TT3, TT4

(b) Hot key on remote control:

Directly press C.C. key to set Closed Caption. The sequence is following: Caption > Text > Off .

SETTING UP THE TV CHANNELS

Initial Setup

Use the TV Channel Setup feature to set up your channels. The Channel Auto Search scans channels 1 to 125 and adds the channels that return a signal. You also can use the Channel Edit feature to add and erase channels that fit your preference.

Use the following steps to set up your TV channels:

1. Press NTSC button to select AIR or CATV
2. Press the MENU button on the remote control to bring up the OSD menu.
3. Use the ▲▼ buttons to highlight the Initial Setup function, and then press the SEL button to view the options.
4. Press the ▼ button once to highlight Auto Channel Scan, and then press the SEL button to begin the search. Channels 1 to 125 are scanned and the channels that return a signal are added to your channel list.
5. Press the EXIT button on your remote control to return to your TV display.

Auto Channel Scan	Function	Options
Tuner Mode	Select your TV input source.	Air, Cable
Start	Automatically search scan TV channel from 1 to 125	Auto

Use the following steps to add and erase channels:

1. Press the MENU button on the remote control to bring up the OSD menu.
2. Continue to press the ▼ button to initial setup function. Press SEL button to enter Initial Setup Menu.
3. Continue to press the ▼ button until the channel list and press the SEL button to bring up a lock picture.

4. Press "0" button to show channel list. Use the ▲▼ buttons to select a channel.
5. Use the ▲▼◀▶ buttons to highlight Add or Erase. Press the SEL button to add or erase the current channel.
6. Press the EXIT button on your remote control to return to your TV display.

When a viewer attempts to watch a blocked channel, this message appears:

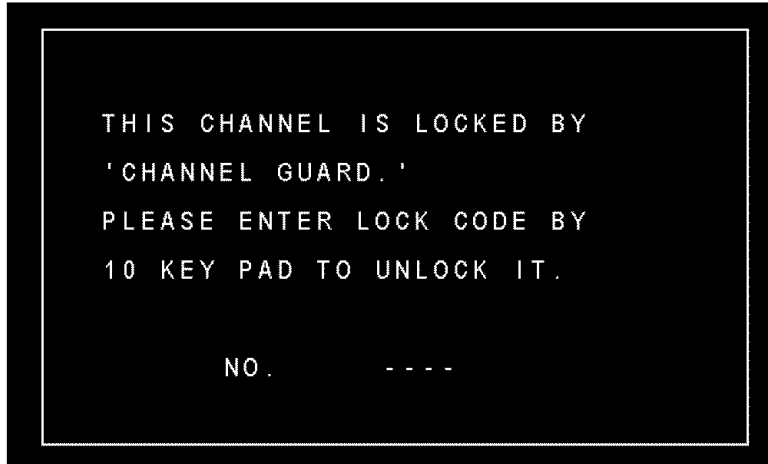

The channel will remain blocked until the correct lock code is enter

SETTING UP THE MANUAL TUNING

Manual Tuning

Due to the weak TV channel signal , some of the channels may not be tuned correctly. With the fine tune function , you can tune in each channel precisely which has poor picture.

Use the following steps to manual adjust:

1. Press channel selector button to select channel number.
2. Press the MENU button on the remote control to bring up the OSD menu.
3. Use the ▲▼ buttons to highlight the Initial Setup function, and then press the SEL button to view the options.
4. Press the ▼ button once to highlight Manual Tuning, and then press the SEL button to begin the adjustment.
5. Use the ◀▶ buttons to fine tune the program.
6. Press the EXIT button on your remote control to return to your TV display.

PC Mode OSD (On-Screen Display)

PC Picture Position

Adjust auto adjust, horizontal position, vertical position, horizontal clock, clock phase and reset.

PC Picture Position	Function	Options
Auto Adjust	Automatically detect video format.	OK
Horizontal Position	Move image to the left or right.	0 to 100
Vertical Position	Move image up or down.	0 to 100
Horizontal Clock	Move image left and right.	0 to 100
Clock Phase	Video timing adjustment.	0 to 100
Reset	Put all of your display settings back to their default.	OK

PC Picture

Adjust contrast, brightness, color temperature and reset.

PC Picture	Function	Options
Contrast	Adjust the color brightness of the display.	0 to 100
Brightness	Adjust the darkness and lightness of the display.	0 to 100
Color Temperature	Adjust the level of the color temperature.	- High - Low - Manual
R	Adjust the red color of the display only in manual mode.	0 to 100
G	Adjust the green color of the display only in manual mode.	0 to 100
B	Adjust the blue color of the display only in manual mode.	0 to 100
Reset	Put all of your display settings back to their default.	OK

Audio

Adjust treble, bass, balance, SRS WOW and Subwoofer of your sound.

Audio	Function	Options
Bass	Increase and decreases the level of bass.	-16 to +16
Treble	Increase and decreases the level of treble.	-16 to +16
Balance	Adjust the left and right sound level.	-16 to +16
SRS WOW	Turn SRS WOW function on and off.	On or Off
Subwoofer	Turn Subwoofer function on and off.	On or Off



SRS WOW is an audio enhancement technology from SRS Labs that provides deep, rich bass on any speaker system without the need for a subwoofer or additional extra physical components. For systems with a subwoofer, SRS WOW complements and enhances the bass performance. This feature can be set to On or Off.

NOTES: WOW, SRS and the  symbol are trademarks of SRS Labs, Inc. SRS WOW technology is incorporated under license from SRS Labs, Inc.

DTV USAGE

ATSC(Advanced Television System Committee) INTRODUCTION

Terrestrial broadcast is a traditional way of watching TV programs, simply by installing an outdoor YAGI antenna or an indoor rabbit ear antenna, plugging it into the TV set's tuner, tuning channel, then you can enjoy watching the programs. However, they are all so called "analog TV".

In recent years, "digital TV" arises and most countries' governments have begun to mandate a TV Transition from the old analog TV broadcast system to digital TV broadcast system. Digital TV brings viewer greater entertainment in terms of a noise free High Definition picture quality and Dolby AC-3 sound effect. 16:9 video format gives a wider view of the same program compared with traditional 4:3 format. In the near future terrestrial data broadcast will create a complete digitized world in every family. Many terrestrial TV broadcaster at this moment are delivering digital TV programs, when the time of government mandated transition deadline comes, all the analog TV transmissions have to give way to digital, which makes the ZAT series digital terrestrial HDTV receivers a wise investment now.

Digital TV programs are broadcasted on both VHF and UHF radio frequency bands. Traditional analog TV transmission uses one radio frequency channel for carrying one TV station's programs, in the digital TV transmission one radio frequency channel can carry up to four more TV station's programs. For instance, the original analog channel CBS you used to watch now may have become 2-1,2-2,2-3,2-4 when it's broadcasted in digital, here we call 2 as the major channel and -1, -2, -3 and -4 are sub-channels. These four sub-channels usually come from the same TV station and show four different programs at the same time.

Digital TV signals are transmitted in either Free-to-Air (FTA) mode or Pay-per-View (PPV) mode. FTA signals can be received free by anyone with MPEG 2-ATSC compliant digital terrestrial receiver, such as the ZAT series, whereas the PPV programs can only be received by paying an access fee to the broadcaster and using a Digital receiver incorporating compatible conditional access system. The receiver allows you to watch HDTV, EDTV and SDTV digital TV programs.

*HDTV stands for High Definition Television; its common video formats are "1920 x 1080 interlaced" or "1280 x 720 progressive".

*EDTV stands for Enhanced Definition Television; its common video format is "720 x 480 progressive".

*SDTV stands for Standard Definition Television; its common video format is "720 x 480 interlaced".

ATSC RECEIVER FUNCTIONS

The Digital Terrestrial HDTV Receiver opens up a new world of free-to-air terrestrial HDTV and SDTV programming. The receiver can receive channels from both VHF band and UHF band TV station's signals. All the major terrestrial free-to-air station numbers currently available in your area are listed in the on-screen menu. To watch the channel simply by selecting the channel number and you will be accessing a wide range of local high quality digital programming.

The receiver is fully ATSC / MPEG-2 (digital video broadcast-terrestrial) compliant, delivering High Definition crystal-sharp video and Dolby AC-3 sound. It supports a radio signal range from 50-860 MHz, so can be easily programmed for all the channels within the VHF and UHF frequency bands. It can receive major and sub-channels containing both video and audio programs.

These receivers have the capability of receiving hundreds of channels simply by selecting alternate TV channel frequencies in your area. To find out the specific digital TV services available to you, please contact your local service provider or log onto the website "<http://www.antennaweb.org>". With the wide range of features and terrestrial HDTV programming opened up to you by ZAT series digital terrestrial receivers, prepare yourself for a new era in home theater entertainment.

SETTING UP YOUR DTV

1. Make sure the physical connection is properly connected.
2. Switch on the TV.
3. Select the appropriate external video input on your TV by using the TV remote control.
4. If the LCD is moved to a different location. You should reset the receiver and do the channel scanning all over again.

USING THE DTV ON-SCREEN DISPLAY (OSD) CONTROLS

1. Press DTV MENU on the remote control to display the MENU banner.
2. Use the ▲▼◀▶ to navigate to different menu item.
3. Use the ◀▶ to adjust functions.
4. Press SEL on the remote control to select functions. Press RTN to jump back the last page of menu.
5. Press EXIT on the remote control to quickly exit from menu.

Channel	Enter Password	Edit, Auto Scan, Manual Scan
Caption	Font Size	Default, Small, Middle, Large
	Font Style	Default, Style0~7
	Font Color	Background, Foreground
	Font Opacity	Background, Foreground
	Edge Style	Default, None, Raised, Depressed, Uniform, Drop Shadow (L), Drop Shadow(R)
	Edge Color	Default, Gray, Blue, Red, Green, Cyan, Yellow, Dark
Setup	Opacity	0%~100% adjustment
	I-Plate	Display Time
	Time Zone	Time Format, Time Adjustment
	About	HW & SW version
Lock	Enter Password	Rating, Password, Reset Default

Channel

Before you can use any of the channel buttons (CH+/-, FAV. CH, Numbers), the available channels must first be scanned and memorized.

Auto Scan



Press [DTV Menu] key and then select Channel to run Auto/Manual Scan.

Initial Screen –

The first time the receiver is powered on. You will see a message block of "Press [DTV Menu] key and then select Channel to run Auto / Manual Scan".

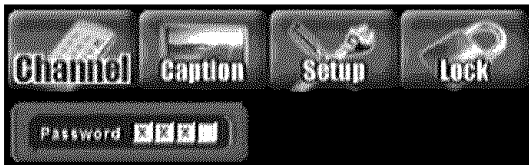

1. Press the DTV MENU button to display the MENU banner.
2. Use the arrow keys ◀ or ▶ to move highlight CHANNEL and enter default password "0000" to show three sub-menus

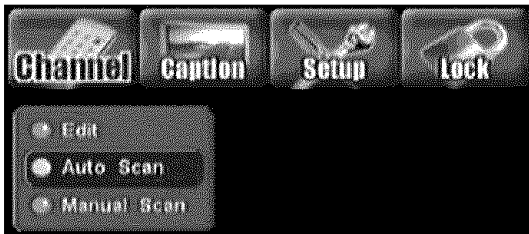

3. Press ▲ or ▼ buttons to highlight the AUTO SCAN, and then press SEL to launch the auto scan. An AUTO-SCAN window will show the SCAN status.



4. Once the digital TV signal is scanned, the channel number and program name will be shown on the "Scan List".
5. Scanning will end up on channel 69 when it is complete (even in processing) you can press EXIT key to leave this window and enjoy watching DTV programs.

SETTING UP YOUR DTV

Manual Scan



1. On the Channel menu page, select the third item MANUAL SCAN.



2. Press ◀ or ▶ to highlight the input column, then press numeric buttons to input the channel number. The channel frequency will be automatically showing on right side of the input column.

3. Press SEL button when the message "Add channel" and "press Enter to add channel" has shown.

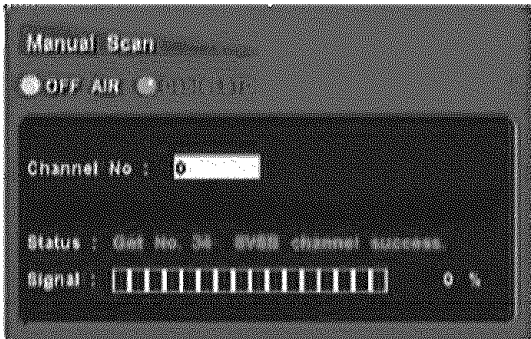

4. If the ATSC signal is found and locked, the Status will show message "Add No. XX 8VSB channel successfully". Then you can press EXIT to leave the menu page and watch the program, or go ahead scanning the other channels.

5. If the signal is not locked, the status will show "No Channel NO. ". You can scan the signal again or refer to the signal level bar "Signal" for aligning the direction of the antenna to get the signal.

6. When the signal is locked and the receiver is on the channel, you can enter into this page to check the signal level.

Note: It's suggested that you contact the antenna Installer when you have trouble of locking the signal.

Edit

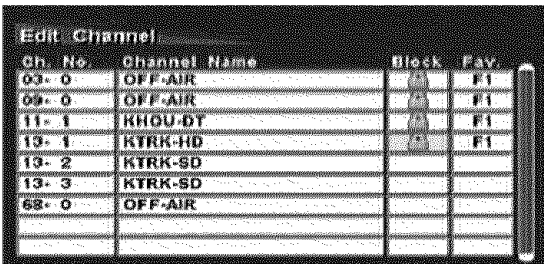

1. On the Channel menu page, select the first item EDIT.

2. Press ▲▼ and ◀▶ buttons to highlight the channel's BLOCK or FAV control column and press SEL to block channel or copy channel into the favorite channel list "F1".

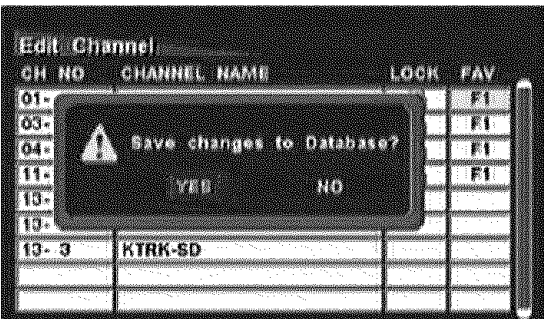

3. After the edit setting, press the RTN button, then will pop up a confirmation window: choose "NO" to cancel the edit change; choose "YES" to save the edit settings.

Note: When the blocked channel has been selected, the program can not be showed, and you will get the message:" Channel is blocked" from TV

SETTING UP YOUR DTV

Caption

Adjust the font size, style, color and opacity of Closed Caption.

Caption	Function	Options
Font Size	Adjust the font size of Closed Caption	Default, Small, Middle, Large
Font Style	Adjust the font style of Closed Caption	Default, Style0~7
Font Color	Adjust the background and foreground color of Closed Caption	Background, Foreground
Font Opacity	Adjust the background and foreground opacity of Closed Caption	Background, Foreground
Edge Style	Adjust the edge style of Closed Caption	Default, None, Raised, Depressed, Uniform, Drop Shadow(L), Drop Shadow(R)
Edge Color	Adjust the edge color of Closed Caption	Default, Gray, Blue, Red, Green, Cyan, Yellow, Dark

Setup

Select the sound, opacity, I-Plate, time zone mode and check the hardware and software version.

Setup	Function	Options
Opacity	Change the percentage of the OSD's transparency	0%~100% adjustment
I-Plate	Change the Information-Plate display time	2 Sec, 4 Sec, 6 Sec, Off
Time Zone	Change time display format and adjust the time zone	Time Format, Time Adjustment
About	Check the hardware and software version	

Lock

Require a password to be entered to view movies and TV programs with unsuitable ratings for some viewers who share the TV.

Rating



1. Press the DTV MENU button to display the MENU banner.
2. Use the arrow keys ◀ or ▶ to move highlight LOCK and enter default password "0000" to show three sub-menus



3. Press ▲▼ buttons to highlight the "Rating", and then press SEL to into the rating control menu.

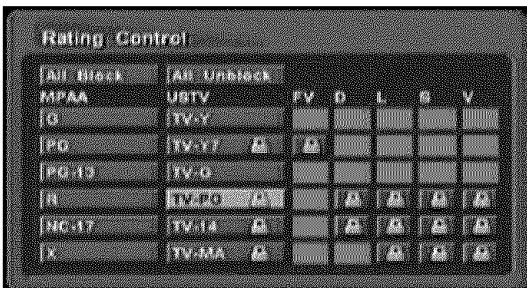

4. This menu lists both MPAA and USTV (FCC) Parental ratings. You can independently lock the MPAA and TV ratings. The locked ratings are indicated by the lock symbol.
5. Press ▲▼ and ◀▶ buttons and the SEL button to activate the appropriate restrictions for either MPAA rating system or USTV(FCC) rating system.
6. When it is complete (even in processing) you can press EXIT button to leave this window and enjoy watching DTV programs.

- NOTES:**
1. When the rating locked channel has been selected, the program cannot be showed and you will get the message "Program is rating blocked" from TV screen.
 2. Explanation of the MPAA and TV (FCC) Rating Systems, please check "TV Guidelines Blocking" and "MPAA Rating" on page 35.

SETTING UP YOUR DTV

Change Password

To change password, enter the Change Password Number option in PASSWORD function and press SEL button to change password. Enter four digital password in enter new password number. And then confirm the password by entering the same password again.

- NOTES:**
1. Before you change the password, use the default password "0000" to enter the Menu item which requires the password.
 2. If you forget the password, please use the password "1234" to enter.
 3. To enter the new password, and follow the instruction.

Reset Default

This function allows to reset receiver back to factory default status.

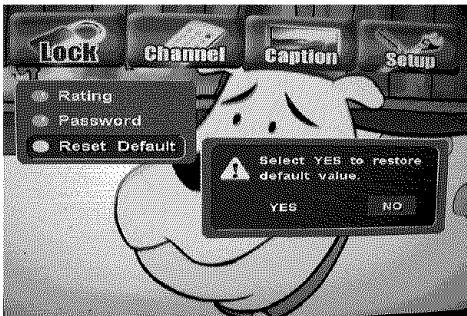

1. Press ▲▼ buttons to highlight the "Reset Default", and then press SEL to into the rating control menu.

2. There will pop up the RESET confirmation message "Press Yes to restore default value". Press SEL on "Yes" to process. Press SEL on "NO" to cancel the setting.

CLOSED CAPTION

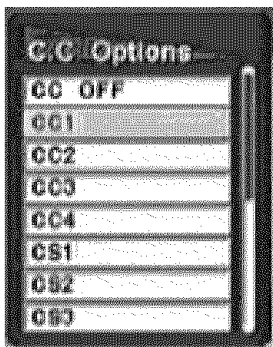

1. When you learn from the I-PLATE that there is Closed Caption data on the current channel, you can press CC button on the remote control to display C.C. Option list it on the TV screen.

2. Use ▲ and ▼ buttons to highlight the desired CC signal and press SEL button.

3. After the type of Closed Caption has been selected, press EXIT or CC buttons to cancel the CC Option list, then you can watch this Digital TV program with Closed Caption.

FAVORITE CHANNEL LIST

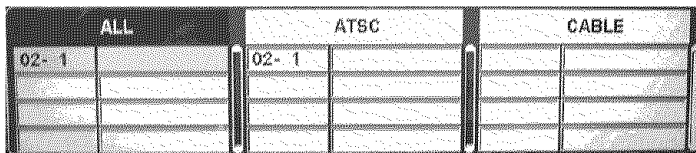

1. When you are watching terrestrial or cable TV channels, you can press "FAV" button on the remote control to call up the Favorite List.

2. Use ◀ and ▶ buttons to navigate "ALL", "ATSC", and "CABLE" program lists.

3. Use ▲ and ▼ buttons to browse through the selected program lists and highlight the program you like to watch, then press SEL button.

NOTE: Press Numeric Key to Select Digital Channel

For the digital channel number is different with the traditional NTSC channel number. Please follow below indication to select the digital channel if you prefer using numeric key doing the channel selection.

Example: digital channel number: 10 - 2

1. Press numeric key "1" and "0"
2. Press "▶" button
3. Press numeric key "2"

USEFUL INFORMATION

CARE OF YOUR HITACHI LCD TELEVISION AND YOUR REMOTE CONTROL

DO

Dust the screen and frame with a cleaning cloth from the accessories pack.

Clean the screen and frame with a soft cloth moistened in warm water and dry with a soft cloth. A mild soap may be used if the screen is extremely dirty.

Place your LCD Television far away from hot, humid, and dusty places.

Remove the plug from the wall outlet if your LCD Television will not be used for a long period of time, for instance, when you go on a vacation.

DO NOT

Do not clean your screen with strong cleaners, polishes or a chemically treated cloth.

Do not place rubber or vinyl products or cellophane tape on your LCD Television.

Avoid repeatedly touching the screen.





Do not subject the remote control to shock such as dropping it on the floor, etc. This way may cause physical damage to the precision parts.

Avoid placing the remote control in a high humidity place or getting it wet. Do not leave it on or near a heater. Excessive heat or moisture may cause the remote control unit to fail.

When the batteries run out, remote control operation will become erratic or become unresponsive. Replace the old batteries with two new "AAA" size batteries. Do not use an old battery with a new battery at the same time.

Expose the screen to direct sunlight for a long period of time or heat may cause damage to the LCD screen.

RECEPTION PROBLEMS

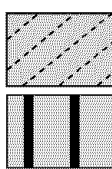
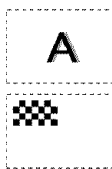
	<p>• IGNITION NOISE: Black spots or horizontal streaks may appear, picture may flutter or drift. Usually caused by interference from automobile ignition systems, neon lamps, electrical drills, and other electrical appliances.</p>
	<p>• GHOSTS: Ghosts are caused by the television signal following two paths. One is the direct path and the other is reflected from tall buildings, hills or some other objects. Changing the direction or position of the antenna may improve reception. Ghosting may also be caused by defects in the antenna system such as unshielded leads or connecting several sets to the same antenna without using multiple antenna couplers.</p>
	<p>• SNOW: If your receiver is located in the fringe area of a television station where the signal is weak, your picture may be marred by the appearance of small dots. When the signal is extremely weak, it may be necessary to install a special antenna to improve the picture.</p>
	<p>• RADIO FREQUENCY INTERFERENCE: The interference produces moving ripples or diagonal streaks, and in some cases, causes loss of contrast in the picture.</p> <p>• PREVENTION OF AN OBSTACLE TO RADIO RECEIVERS This LCD TV has been designed pursuant to the FCC class B Rules. This is to prevent a problem to Radio receivers. If this LCD TV causes a problem to Radio receivers, then take the following steps:</p> <ul style="list-style-type: none"> - Keep the LCD TV away from Radio. - Adjust Radio antennas in order for the LCD TV not to receive interference. - The antenna cable of Radio should be kept away from the LCD TV. - Use a coaxial cable for antenna. <p>You can check if this LCD TV influences Radio receivers by turning off all other equipment other than the LCD TV. If you find a problem receiving Radio when using the LCD TV, check the instructions mentioned above.</p>
<p>• The display image appears scrolling diagonal.</p> <p>• Text displayed across the screen appears vertically streaked, with the characters in vertical columns blurred.</p>	 <p>• Adjust the horizontal clock and clock phase. (Adjust the horizontal clock first, the clock phase next.) (RGB input)</p>
<p>• Text displayed across the screen appears blurred.</p> <p>• A fine pattern flickers when displayed on the screen.</p>	 <p>• Adjust the clock phase for the clearest viewing. (RGB input)</p>
<p>• Vertical stripes appear, depending on the screen contents.</p>	<p>• The LCD display panel is lighting the phosphors by the discharge of internal radiation. Depending on the screen contents, in rare cases this may cause vertical stripes to appear because of failure to light. Please note that this is not a malfunction.</p>
<p>• Coarse horizontal stripes appear in FULL display.</p>	<p>• Adjusting the clock phase will reduce the horizontal stripes. (RGB input)</p>
<p>• The display dims to make the picture invisible during special playback of a VCR (FF, REW).</p>	<p>• This condition may occur when the unit is connected to a VCR with component output, such as 480i, but it is not a failure. But when it occurs, switch to composite output.</p>

USEFUL INFORMATION

SYMPTOMS	CHECK THESE ITEMS AND TRY THESE ADJUSTMENTS											
	Be sure external connection is correct	Be sure power cord is plugged in	Be sure TV is switched "ON"	Try another channel (station trouble)	Check antenna connections (back of TV)	Check outside antenna	Check for local interference	Adjust Contrast control	Adjust Brightness control	Adjust Color control	Adjust Tint control	Adjust Volume control
No Picture, no sound	●	●	●	●	●	●	●					
Sound OK, picture poor	●			●	●	●	●	●	●			
Picture OK, sound poor	●			●	●	●	●	●				●
Picture blurred	●			●	●	●	●	●				
Lines or streaks in picture				●	●	●	●	●				
Poor reception on some channels				●	●	●	●	●				
Picture rolls vertically				●				●				
No color	●			●	●	●	●			●		
Poor color	●			●	●	●	●			●	●	

PLUG and PLAY



This LCD Television complies with VESA DDC2B specifications , Plug & Play is a system with computer, peripherals (including monitors) and operating system. It works when the LCD TV is connected to a DDC ready computer that is running an operating system software that is capable for the plug & play. When a Plug and Play PC is powered on, it sends a command to the LCD TV requesting identification. The LCD TV sends back a string of data including its characteristics.

TRADEMARK ACKNOWLEDGMENT

DDC™ is a trademark of Video Electronics Standard Association.
IBM PC/AT and VGA are registered trademarks of International Business Machines Corporation of the U.S.A.
Apple and Macintosh are registered trademarks of Apple Computer, Inc.
VESA is a trademark of a nonprofit organization, Video Electronics Standard Association.

This Class B digital apparatus meets all requirements of the Canadian Interference-Causing Equipment Regulations.
This Class B digital apparatus complies with Canadian ICES-003.
Cet appareil numérique de la classe B est conforme à la norme NMB-003 du Canada.

Cable Compatible Television Apparatus- Télévision câblocompatible, Canada.

NOTE: This LCD Television will display television closed captioning, ( or ), in accordance with paragraph 15.119 of the FCC rules.

USEFUL INFORMATION

AGENCY REGULATORY INFORMATION

Federal Communications Commission Notice

This equipment has been tested and found to comply with the limits for a Class B digital device, pursuant to Part 15 of the FCC Rules. These limits are designed to provide reasonable protection against harmful interference in a residential installation. This equipment generates, uses and can radiate radio frequency energy and if not installed and used in accordance with the instructions, may cause harmful interference to radio communications. However, there is no guarantee that interference will not occur in a particular installation. If this equipment does cause harmful interference to radio or television reception, which can be determined by turning the equipment off and on, the user is encouraged to try to correct the interference by one or more of the following measures:

- Reorient or relocate the receiving antenna.
- Increase the separation between the equipment and the receiver.
- Connect the equipment into an outlet on a circuit different from that to which the receiver is connected.
- Consult the dealer or an experienced radio/television technician for help.

Modifications

The FCC requires the user to be notified that any changes or modifications made to this device that are not expressly approved by Hitachi Home Electronics (America), Inc. may void the user's warranty.

Cables

Connections to this device must be made with shielded cables with metallic RFI/EMI connector hoods to maintain compliance with FCC Rules and Regulations.

Any cables that are supplied with the system must be replaced with identical cables in order to assure compliance with FCC rules. Order Hitachi spares as replacement cables.

Declaration of Conformity

This device complies with Part 15 of the FCC Rules. Operation is subject to the following two conditions: (1) this device may not cause harmful interference and (2) this device must accept any interference received, including interference that may cause undesired operation.

For questions regarding this declaration, contact:

Hitachi America, LTD.
Home Electronics Division
900 Hitachi Way
Chula Vista, CA 91914-3556
Tel. 1-800-448-2244 (1-800-HITACHI)
ATTN: CUSTOMER RELATIONS

USEFUL INFORMATION

Features:

- New Easy-to-Use On-Screen Menu Control (3 Language)
- Film Mode Processing with 3:2 & 2:2 pull down
- Integrated ATSC Tuner
- Adjustable Color Temperature(This is only for PC mode.)
- PIP / POP
- Picture Enhancement
- Input Signal Identification
- HDMI (High Definition Multimedia Interface)(High Bandwidth Digital Content Protection V1.1 Compatible)

Video:

- 1366 x 768 Display Resolution
- Wide Viewing Angle: More than 160°
- 2 Color Temperature Presets: High / Low
- Multiple Screen Fill Modes (4:3 Standard, 4:3 Expanded, 4:3 Zoom1, 4:3 Zoom2, 16:9 Standard, 16:9 Zoom)
- 3D Y/C Comb Filter
- Picture Modes (Natural, Cinema, Dynamic and Game)
- Computer Display: VGA, SVGA, XGA, WXGA
- HDMI Display: VGA, 480i, 480P, 720P, 1080i

Inputs:

- Antenna input impedance 75 Ω
- Channel coverage 191ch.
 - VHF-Band 2 ~ 13
 - UHF-Band 14 ~ 69
 - CATV Mid Band A-5 ~ A-1
 - A-I
 - Super Band J-W
 - Hyper Band W+1 - W+28
 - Ultra Band W+29 - W+94
- Video 1.0Vp-p, 75Ω
- S-Video
 - Luminance (Y) 1.0Vp-p, 75 Ω
 - Chrominance (C) 0.286Vp-p, 75 Ω
- Component Video
 - Luminance (Y) 1.0Vp-p, 75 Ω
 - Chrominance (P_B/P_R) 0.7Vp-p, 75 Ω
- Audio input Impedance 47k Ω
- Average input level 470mVrms
- RGB 0.7Vp-p, 75 Ω
- HDMI (19 PIN)

Outputs:

- Video 1.0Vp-p. 75 Ω
- Audio 470mVrms, 1k Ω
- Head phone

Audio:

- Mono / Stereo / SAP
- SRS WOW
- 10W+10W
- Mute

Supplied Accessories:

- Remote control
- Batteries
- Power Cable
- User's Guide
- Easy Graphic Guide

- Warranty Card
- D-Sub Cable
- S-Video Cable
- AV Cable
- Cleaning cloth
- Cable ties

Optional Accessory:

- Wall mount

INPUTS/OUTPUTS

- Component Y, P_B, P_R x 2
- RGB: Analog Input x 1
- HDMI Input x 1
- Composite Video x 2
- S-Video x 2
- Antenna (RF) Inputs x 2
 - NTSC
 - ATSC
- Audio Input x 5
- Audio Output x 1
- Video Output x 1
- S-Video Output x 1
- Subwoofer Output x 1

SPECIFICATIONS

- Multi-Scanning: 32-70kHz (h), 50-76Hz (v)
- Pixel Pitch 0.4215mm x 0.1405mm x RGB
- FCC class: B for Consumer Use
- Power Input: AC 120V, 60Hz
- Power Consumption: 32HDL52A:150W
. 37HDL52A:170W
at standby <1W
- Operating temperature: 35° C max

DIMENSIONS

32HDL52A:

- Width:812.5 mm
- Height:664 mm (with stand);583.5mm (without stand)
- Depth: 350mm (with stand);113.5 mm (without stand)
- Weight:27.8Kg (with stand);22 Kg (without stand)

37HDL52A:

- Width:940 mm
- Height:736 mm (with stand);657 mm (without stand)
- Depth:350mm (with stand);120 mm (without stand)
- Weight:32.8Kg (with stand);27 Kg (without stand)

Screen mode availability varies by input format

HDTV LCD TVs display HDTV when combined with an HDTV Tuner and Source.

All specifications, weights, and dimensions are subject to change without prior notice. Please access www.hitachi.com/tv for detailed specifications and dimensions for custom installations.

UltraVision Digital is a registered trademark of Hitachi Home Electronics (America), Inc.

WOW, SRS and the  symbol are trademarks of SRS Labs, Inc. WOW technology is incorporated under license from SRS Labs, Inc.

 **HDMI**™ HDMI, the HDMI logo and High-Definition Multimedia Interface are trademarks or registered trademarks of HDMI Licensing LLC.

USEFUL INFORMATION

HITACHI

*Service
hotline*

To locate an authorized
HITACHI service facility
in the continental U.S.A.
and Canada,

DIAL TOLL FREE

7 days a week, 24 hours a day

800 HITACHI

(1-800-448-2244)

Hitachi America, LTD. Home Electronics Division

Hitachi has made every effort to assure you hours of trouble free operation from your unit. However, should you require service, a network of Hitachi Authorized Service Facilities has been established in all 50 states and Puerto Rico. Each facility will provide you with convenient and expedient assistance. Our service hotline operator will direct you to the Hitachi Authorized Service Facility nearest you. Just present proof of purchase and/or delivery receipts to the Hitachi Authorized Service Facility, and service will be rendered in accordance with the terms of the limited warranty as stated on your warranty card or operating guide.

Should you have any questions regarding warranty, service, operation, or technical assistance, please contact:

Hitachi America, LTD.

Home Electronics Division

900 Hitachi Way

Chula Vista, CA 91914-3556

USEFUL INFORMATION

Hitachi Canada, LTD. Digital Media Division

Should you have any questions regarding warranty, service, operation, or technical assistance, please contact:

**In Canada:
1-800-HITACHI
(1-800-448-2244)**

**Monday - Friday EST 9:00am - 7:00pm
Saturday EST 9:00am - 5:00pm**

Look for your French Manual on the outside of the box.

If the manual is missing, call

**1-800-HITACHI
(1-800-448-2244)**

for a copy.

Pour de plus amples renseignements sur le service durant la période couverte par la garantie, sur le fonctionnement ou pour de l'assistance technique communiquez avec:

**Au Canada:
1-800-HITACHI
(1-800-448-2244)**

**Lundi - Vendredi L'EST 9:00am - 7:00pm
Samedi L'EST 9:00am - 5:00pm**

La version française de votre manuel se trouve à l'extérieur de la boîte.

Si le manuel est manquant, composez le

**1-800-HITACHI
(1-800-448-2244)**

pour obtenir votre copie.

**HITACHI CANADA, LTD.
2495 Meadowpine Blvd.
Mississauga, ON L5N 6C3**