

## MAC 7500 Owner's Manual

- Air Conditioner
- Dehumidifier
- Oscillating Fan

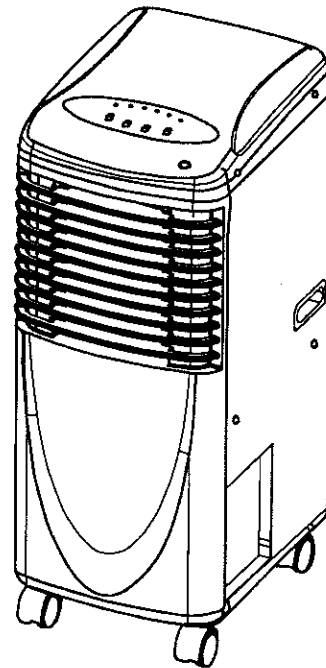

Please read this owner's manual  
carefully before operating the unit.

POWERED BY  **GREE**

## **INTRODUCTION**

Thank you for purchasing the *Soleus A<sub>2</sub>* Mac 7500 portable air-conditioner. This unit is designed for improving living and working comfort by providing cooling, dehumidifying and fan functions only with a minimum installation required. With its whisper quite operation and attractive design, you will enjoy the convenience and comfort that this unit provides for many years to come.

When operating as an air conditioner, this unit is designed for spot cooling or cooling for a room no larger than 150 square feet with the standard ceiling height 7-½ ft.

## **ALERT SYMBOLS**

The following symbols used in this manual, alert you to potentially dangerous conditions to users, service personnel or the appliance:



**WARNING**

this symbol refers to a hazard or unsafe practice, which can result in severe personal injury or death.



**CAUTION**

this symbol refers to a hazard or unsafe practice, which can result in personal injury or product or property damage.

## **IMPORTANT SAFEGUARDS**



**WARNING**

- Read these instructions carefully before using this air conditioner. If you still have any difficulties or problems, consult your dealer for help.
- Never use or store gasoline or other flammable vapor or liquid near the air conditioner.
- This air conditioner has no ventilator for taking in fresh air from out of doors. You must open doors or windows frequently when you use gas or oil heating appliances in the same room, which consume a lot of oxygen from the air. Otherwise, there is a risk of suffocation in extreme cases.

- Unplug unit from the electrical outlet when not in use and before cleaning it.
- Do not use an adapter plug extension cord.
- Do not use near gas appliances, open flames (fireplaces) or near the vicinity flammable liquids.



**CAUTION**

- Do not operate this unit if it had a damaged cord or plug or if it is not working properly, or has been dropped or damaged in any manner. Take the unit to the nearest authorized. Service Facility for examination, repair or electrical/mechanical adjustment.
- The use of accessories and attachments not recommended or sold by *Soleus Air* may cause fire, electric shock or injury.
- To protect against risk of electrical shock, do not immerse the unit, cord or plug in water or any other liquid.
- Do not cut or remove the third (ground) prong from the power cord.
- If the plug gets hot, call a qualified electrician.
- Close supervision is required when the unit is used by or near children.
- Do not stick anything into the air outlet of the air conditioner.
- Do not use in a room with poor air circulation.
- Do not expose the unit to direct sunlight.
- Do not use the unit near water.

**PACKAGE CONTAINS:**

Mobile Air Conditioner  
Air Exhaust Duct  
Exhaust Duct Window Kit Adapter  
Remote Controller

LITHIUM BATTERY 3V<sup>-</sup>  
Window Kit - 3 Sliding Panels  
Window Kit Fastener Screws (4)  
User Manual

**NAMES OF PARTS**

**FRONT**

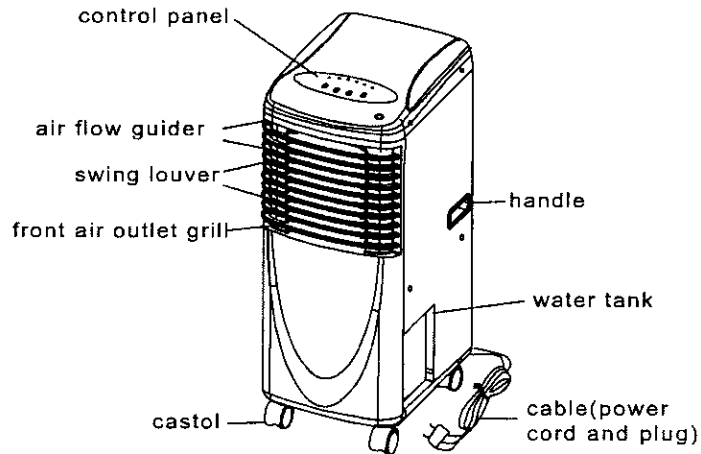

**BACK**

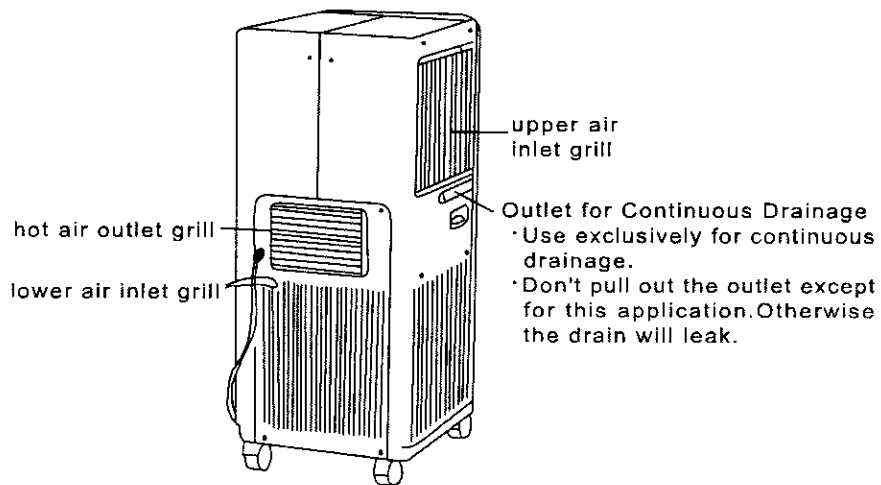

## Exhaust Duct

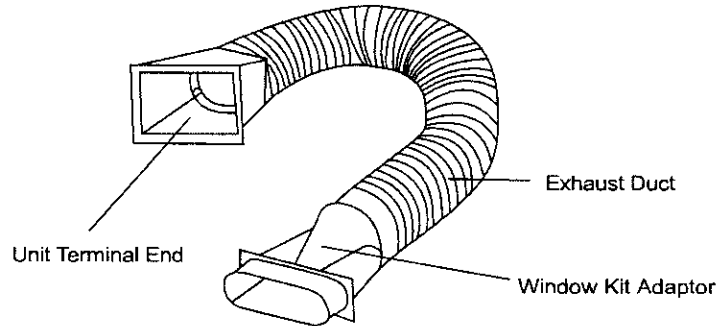

## Window Kits

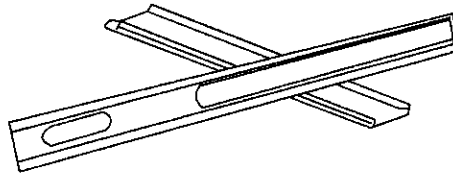

## Exhaust Duct

When you use the unit as an air conditioner, the hot exhaust air must be directed out of the room. The exhaust duct is used to allow the hot air out. **DO NOT INSTALL OR USE THE EXHAUST DUCT WHEN THE UNIT IS OPERATED AS A DEHUMIDIFIER OR FAN.**

- a) Slide exhaust connector all the way over the hot Air outlet grill.
- b) Mount the external end of the exhaust duct onto a hole of  $5 \frac{1}{4}$ " (132 mm) on the wall for optional wall hot air outlet installation.

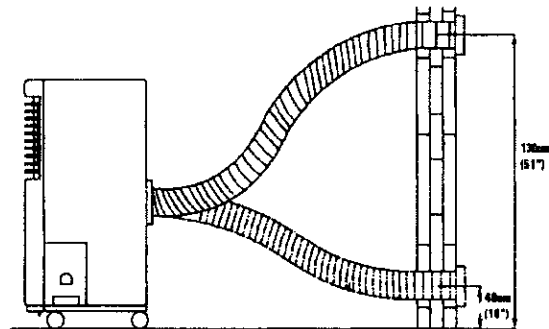

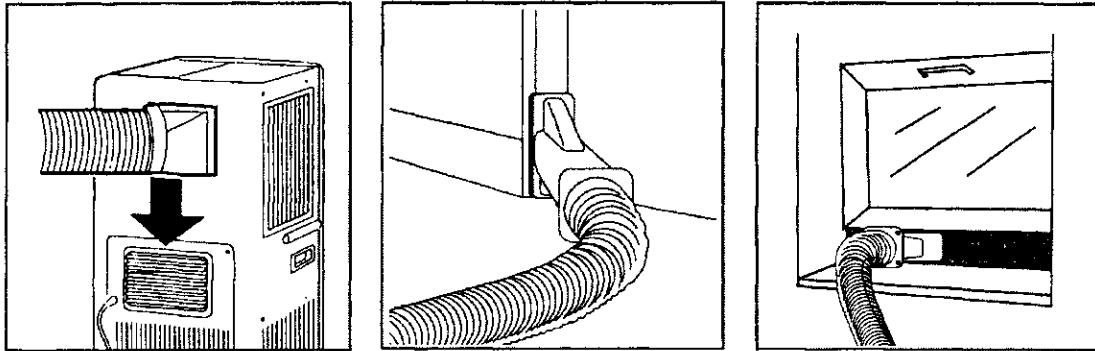

- c) Or connect the window kit adaptor to the external end of the exhaust duct for a window or sliding door hot air outlet installation.

**NOTE:** In order to increase the efficiency, the exhaust duct should be kept as short and straight as possible. The exhaust hose can be cut shorter by unthreading either end of the exhaust duct counter clockwise. It is not recommended to increase the manufacturer's length of the exhaust hose. This may impede or damage the unit.

### **Window Kit Installation**

- a) Open window or sliding door for approximately 5 inches (130 mm).
- b) Adjust the length of the window kit to the same length of the window or the sliding door. Use all three panels if necessary.
- c) Use screws to affix the window kit length.
- d) Place the window kit to the window or sliding door. Close the window or door as far as it goes.
- e) Mount the window kit extension of the exhaust host onto the window kit.
- f) Use screws on the window kit extension if necessary.

**NOTE:** When using the window kit on a window or sliding door it will cause the window or sliding door not to be properly closed and locked. Additional security measurements should be taken.

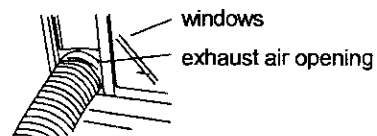

## CONTROL PANEL

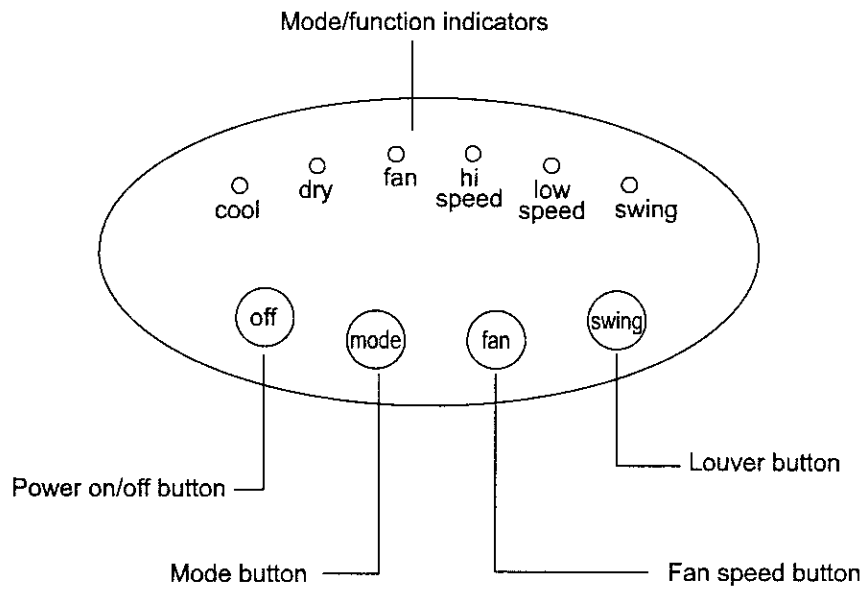

## REMOTE CONTROLLER

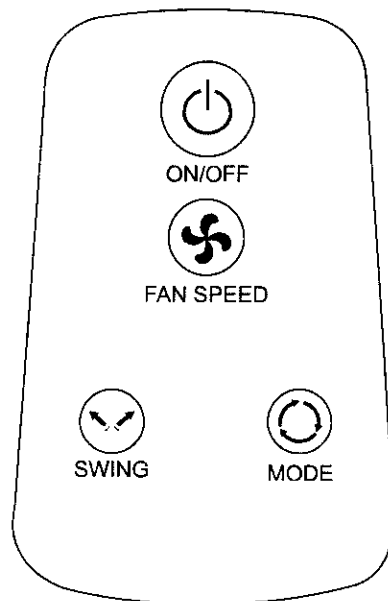

## **OPERATION USING CONTROL PANEL**

### 1) **For Manual Mode:**

Press the Mode Button

- a) Cool - Cooling function on indicator.
- b) Dry - Dehumidify function on indicator.
- c) Fan - Fan on indicator.

### 2) **For Cooling Operation:**

- a) Be sure that the drain tank is properly placed in the unit.
- b) Install the exhaust duct properly.
- c) Plug the Power Cord to the power outlet.
- d) Press the Mode Button until the cool indicator is on.

**NOTE:** During hot days, the unit will cool off the room most efficiently by setting the fan at the lowest speed. Reducing the length of the exhaust duct, insulating the exhaust duct and keeping direct sunlight to a minimum will also improve the cooling efficiency.

### 3) **Dehumidifying Operation:**

- a) Be sure that the drain tank is properly placed in the unit.
- b) Plug the Power Cord to the power outlet
- c) Turn on the unit by pressing the ON/OFF Button on the control panel.
- d) Press the Mode Button until the DRY indicator is on.

**NOTE:** Do not use the exhaust duct when the unit is running at dehumidising mode. You must remove the exhaust duct from the unit. When the unit is running at dehumidifying mode, the fan speed cannot be adjusted.

Keep the windows and the doors closed to aid the effectiyeness of the unit in removing the moisture from the room.



4) **Fan Operation:**

- a) Plug the Power Cord to the power outlet.
- b) Turn on the unit by pressing the ON/OFF Button on the control panel.
- c) Press the Mode Button until 'FAN' indicator is on.
- d) Select the fan speed by pressing the Fan Speed Button.

**NOTE:** When the unit is running on fan mode, the exhaust duct is inoperative and is not required.

## **OPERATION USING REMOTE CONTROLLER**

The remote controller provided with the unit may operate this portable air conditioner. The remote controller uses one LITHIUM BATTERY 3V<sup>-</sup>. Install the battery before using the remote controller.

1. Press the On/Off key to turn on the unit.
2. Press Mode Key to:
  - a) Cool indicator is on = Cooling Function
  - b) Dry indicator is on = Dehumidify Function
  - c) Fan indicator is on = Fan Function
3. Fan Speed:
  - a) Press the Fan Speed key to turn fan speed to high or low.
4. Swing:
  - a) Press swing key to turn on auto swing function.



**WARNING**

Do not dispose of batteries in fire, batteries may explode or leak.

## **CONDENSATE WATER DRAINAGE**

### 1) **Internal Water Tank**

When operating in cooling or dehumidifying mode, the condensate water will drain into the internal water tank. *Depending on the surrounding humidity*, the unit can continuously operate for 2 to 12 hours before the internal water tank is full. When the internal water tank gets full, a beep alarm will sound eight times for 15 seconds. The compressor stops running and the fan will continue to run in the set speed for three minutes before the entire unit automatically shuts off.

When the water tank is full, take out the entire water tank slowly and discard the water inside the tank, place it back to its original position. You will then be able to turn on the unit again.

If you want to take out the internal tank before it is full of water, please stop the unit first. Wait for 3 minutes before taking out the water tank to prevent the condensate water from discharging into the unit.

**NOTE:** Do not take out the water tank when the unit is running on either cooling or dehumidifying mode or the alarm will sound and the compressor stops. The mode will automatically change to FAN mode and the compressor will require approximately 3 minutes to restart to the cooling/dehumidifying cycle.



**CAUTION**

Do not remove the water tank when the unit is in use.  
Always turn "Off" the unit before removing water tank.  
Periodically inspect and clean the drain valve to prevent clogging.

**METHOD OF CONTINUOUS DRAINAGE:**

1. Slide out drain valve from the left side of the unit.
2. Connect a rubber pipe to the valve (not included).
3. Make sure the rubber pipe drains downward.

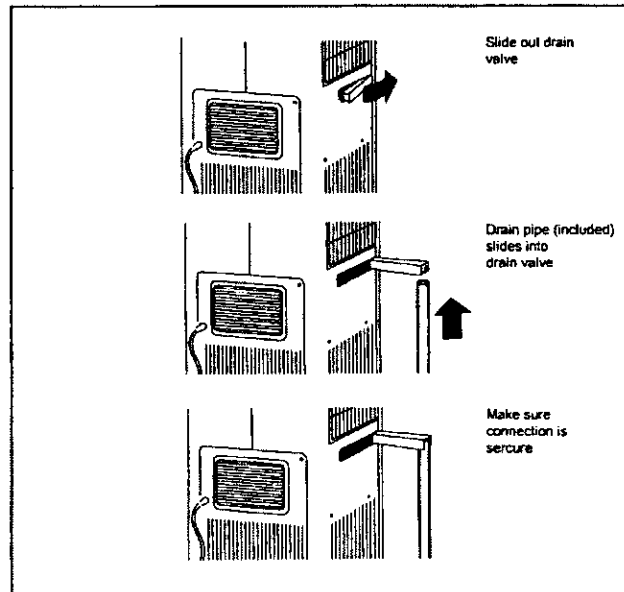

## AIR FILTER

- Soleus Air recommends cleaning your air filter at least after every two weeks of use. Keeping your air filter clean will maximize the performance and life of this product.
- Open the air filter cover on the left side of the unit (fig. a)
- Remove the filter from the cover.
- Wash the filter using warm water and a mild dishwasher detergent.
- Allow to air dry before replacing in unit.

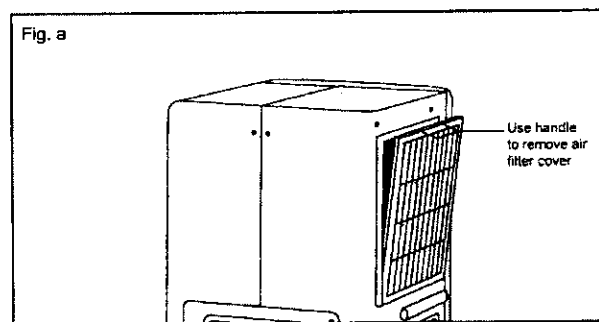

## Water Tank

- Using the handle, slowly remove water tank from unit (fig. b).
- Pour out any condensation accumulated in water tank (fig. c)
- Wash water tank using warm water and a mild dishwasher detergent.
- Allow to dry completely.
- Replace water tank in unit (fig. d).

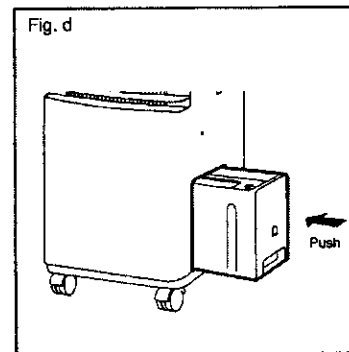
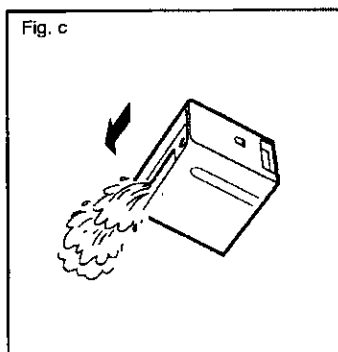
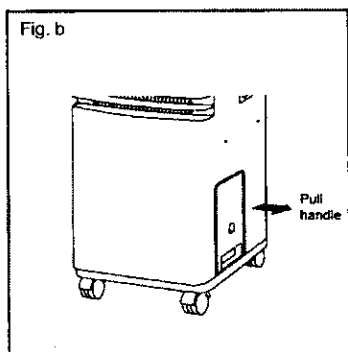

**NOTE:** Be very careful when using an external water tank. The unit will not shut off automatically when an external water tank is full. Spill water can cause substantial damages to carpet, furniture and other valuables.

Do not use lengthy drainage tubing without a condensate water pump.

## **MAINTENANCE**

**NOTE:** Make sure power is off and the plug is pulled out of the power outlet before performing any maintenance activities.

- 1) **Case**
  - a) Keep the unit from being exposed directly to the sun for possible color fading.
  - b) Clean the surface with a damp cloth and dry it with a soft towel.
  
- 2) **Storing the Unit for an Extended Period of Time**
  - a) Ensure that the water drain tank is empty.  
Remove the stopper from the water drain pipe and allow draining until empty.  
(Fig. e)
  - b) The water drain valve should be reinserted back in the unit.
  - c) The filter should be cleaned and air dried.
  - d) The power cable must be disconnected from power outlet and neatly rolled.  
(Fig. f)
  - e) The unit should be stored in a dry place.

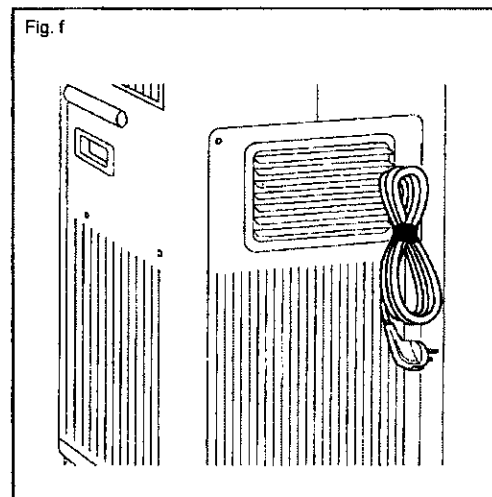
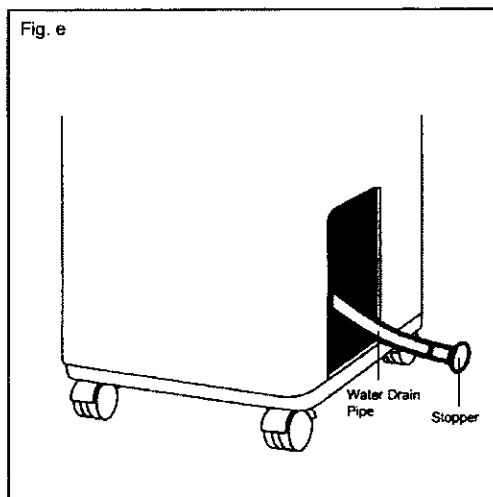

## **TROUBLE SHOOTING**

<b><i>PROBLEM</i></b>	<b><i>POSSIBLE CAUSE</i></b>	<b><i>REMEDY</i></b>
Unit does not operate	Unit is unplugged	Securely plug receptacle into the power outlet
	Drain tank is full	Empty water tank
	Water tank not installed correctly	Completely insert water tank
	Air exhaust is clogged	Clear exhaust hose
Unit does not cool room	There is a heating source in the room	Turn down or off the other heating source
	Air filter is dirty	Clean or replace the air filter
	Air exhaust is not installed correctly	Check the air exhaust duct to make sure that the hot exhaust air is let out of the room freely
	Room is too big or too much ambient sunlight is reaching in	This unit provides spot cooling or cooling for a room no larger than 150 square feet with standard ceiling height 7½"
	There is frost on the evaporator	The unit will defrost automatically and return to operation afterwards
In dehumidifying mode, no cool air coming out	There is frost on the evaporator	The unit will defrost automatically and will return to operation afterwards
Noise or vibration	Surface is not level	Place unit on a level surface and away from obstructions
	Surface is not level Drainage pipe is loose	Place unit on a level surface away from obstructions
	Unit has been moved	When moving unit, empty drain tank first and keep unit upright at all times
	Stopper on water drain pipe is loose	Make sure the stopper on the water drain pipe is securely in place
Machino stops and starts	Air exhaust is not attached properly	Check installation of air exhaust hose
	Air exhaust is curved too much	Try to keep the air exhaust horizontal

## **SPECIFICATIONS**

Model #	MAC - 7500
Power Source	115V~ / 60Hz
Cooling capacity	7500 BTU/h
Dehumidifying capacity	24.0 liters/day
Cooling input power	1000W
Rated current	8.7A
Refrigerant type	HCFC R22
Refrigerant capacity	1.15 lb
Operating Range - Cooling (indoor air temperature)	Max 95°F Dry Bulb - 71°F Wet Bulb Min 67°F Dry Bulb - 57°F Wet Bulb
Unit dimensions (H x D x W)	31" x 12.8" x 16.3"

*Specifications are subject to change without notice*

## **PRODUCT INFORMATION**

If you have problems or questions concerning your air conditioner, you will need the following information. Model and Serial numbers are on the nameplate on the back of the unit.

Model No. \_\_\_\_\_ Serial No. \_\_\_\_\_

Date of Purchase \_\_\_\_\_

Dealer's Name \_\_\_\_\_ Dealers Address \_\_\_\_\_

Purchaser's Name \_\_\_\_\_

Day Phone \_\_\_\_\_ Evening Phone \_\_\_\_\_

## **DISCLAIMER**

*ALL INFORMATION AND THE TECHNICAL SPECIFICATIONS PRESENTED IN THIS USER'S MANUAL ARE THE PRESENTATION OF THE MANUFACTURER SOLEUS INTERNATIONAL HAS NOT CONDUCTED INDEPENDENT TESTS FOR THE INFORMATION AND THE SPECIFICATIONS PRESENTED HEREWITHIN.*

## **CONTACT INFORMATION**

For Optional and Spare Parts  
Technical Support  
Warranty Claim  
Customer Service

Please Call (888) 8-Soleus  
Or Write to:

Soleus International Inc.  
9451 Telstar Ave.  
El Monte CA 91731 USA

[www.soleusair.com](http://www.soleusair.com)



## **WARRANTY**

### **ONE YEAR LIMITED WARRANTY**

Soleus International Inc. warrants the accompanying Soleus Air MAC-7500 Mobile Air Conditioner to be free of defects in material and workmanship for the applications specified in its operation instruction for a period of ONE (1) year from the date of original retail purchase in the United States or Canada.

If the air conditioner exhibits a defect in normal use, Soleus International Inc. will, at its option, either repair or replace it, free of charge within a reasonable time after the air conditioner is returned during the warranty period.

As a condition to any warranty service obligation, the consumer must present this Warranty Certificate along with a copy of the original purchase invoice.

#### **THIS WARRANTY DOES NOT COVER:**

- 1) Damage, accidental or otherwise, to the air conditioner while in the possession of a consumer not caused by a defect in material or workmanship;
- 2) Damage caused by consumer misuse, tampering, or failure to follow the care and special handling provisions in the instructions.
- 3) Damage to the finish of the case, or other appearance parts caused by wear.
- 4) Filter.
- 5) Damage caused by repairs or alterations of the air conditioner by anyone other than authorized by Soleus International Inc.
- 6) Freight and Insurance cost for the warranty service.

ALL WARRANTIES, INCLUDING ANY IMPLIED WARRANTY OF MERCHANTABILITY ARE LIMITED TO ONE-YEAR DURATION OF THIS EXPRESS LIMITED WARRANTY. SOLEUS INTERNATIONAL INC. DISCLAIMS ANY LIABILITY FOR CONSEQUENTIAL OR INCIDENTAL DAMAGES AND IN NO EVENT SHALL SOLEUS INTERNATIONAL INC'S LIABILITY EXCEED THE RETAIL, VALUE OF THE AIR CONDITIONER FOR BREACH OF ANY WRITTEN OR IMPLIED WARRANTY WITH RESPECT TO THIS AIR CONDITIONER.

66126113