

Thermador® | *An American Icon™*

VENTILATION INSTALLATION MANUAL

MODEL: VT1610D



IMPORTANT SAFETY INSTRUCTIONS

READ AND SAVE THESE INSTRUCTIONS.

This appliance conforms to the relevant safety regulations.

Repairs should only be carried out by qualified specialists.

Improperly executed repairs can give rise to significant hazards for the user.





 Your new appliance was protected on its way to you by the packaging. None of the materials cause pollution to the environment and all can be recycled for use again. Please help to protect the environment and dispose of the packaging in an environment-friendly manner.

You can obtain information about the best method disposing of old appliances and packaging from your dealer or local municipal council.

 Check whether this fan may be combined with the extractor hood.

 **SAFETY WARNING:** Before servicing or cleaning unit, switch power off at the service panel and lock service disconnecting means to prevent power from being switched on accidentally. When the service disconnecting means cannot be locked, attach a tag to the service panel to indicate power has been switched off for maintenance.

 **WARNING – TO REDUCE THE RISK OF FIRE, ELECTRIC SHOCK, OR INJURY TO PERSONS, OBSERVE THE FOLLOWING:**

- A. Installation work and electrical wiring must be done by qualified person(s) in accordance with all applicable codes and standards, including fire-related construction.
 - B. Sufficient air is needed for proper combustion and exhausting of gases through the flue (chimney) of fuel burning equipment to prevent back drafting. Follow the heating equipment manufacturers guideline and safety standards such as those published by the National Fire Protection Association (NFPA), and the American Society for Heating, Refrigeration and Air Conditioning Engineers (ASHRAE), and the local code authorities.
 - C. When cutting or drilling into wall or ceiling, do not damage electrical wiring and other hidden utilities.
 - D. To properly exhaust air, be sure to duct air out side. Do not vent exhaust air into spaces within walls, ceilings, attics, crawl spaces, or garages.
-  **WARNING:** To reduce the risk of fire, use only metal ductwork.
-  **CAUTION – For General Ventilating Use Only. Do Not Use To Exhaust Hazardous Or Explosive Materials And Vapours.**
-  This unit must be grounded.
-  **WARNING:** To reduce the risk of fire or electric shock, do not use this fan with any solid-state speed control device.

Equipment Needed

- Drill and Bit
- Screwdriver
- Rubber Mallet

Equipment Included

- Anchors (4)
- Screws (4)
- Installation Instructions
- Connector

PRIOR TO INSTALLATION

Step 1: EXHAUST-AIR MODE

✂ Exhaust air should neither be directed into a smoke or exhaust flue that is currently used for other purposes, nor into a shaft that is used for ventilating rooms in which stoves or fireplaces are also located.

Exhaust air may be discharged in accordance with official and statutory regulations only (e.g. national building regulations).

Local authority regulations must be observed when discharging air into smoke or exhaust flues that are not otherwise in use.

✂ **When the extractor hood is operated in exhaust-air mode simultaneously with a different burner which also makes use of the same chimney** (such as gas, oil or coal-fired heaters, continuous-flow heaters, hot-water boilers) care must be taken to **ensure that there is an adequate supply of fresh air** which will be needed by the burner for combustion.

Safe operation is possible provided that the underpressure in the room where the burner is installed does not exceed 4 Pa (0.04 mbar).

This can be achieved if combustion air can flow through non-lockable openings, e.g. in doors, windows and via the air-intake/exhaust-air wall box or by other technical measures, such as reciprocal interlocking, etc.

If the air intake is inadequate, there is a risk of poisoning from combustion gases which are drawn back into the room.

An air-intake/exhaust-air wall box by itself is no guarantee that the limiting value will not be exceeded.

Note: When assessing the overall requirement, the combined ventilation system for the entire household must be taken into consideration. This rule does not apply to the use of cooking appliances, such as hobs and ovens.

⚠ The fan must be attached at least 78 3/4" from the extractor hood.

⚠ Attach the inner wall fan inside the building only, but not in living rooms.

⚠ When attaching the inner wall fan, ensure that it is accessible for maintenance and repairs.

⚠ The plug-and-socket connections of the electric cables must be located inside the building, according to local code.

⚠ Do not reduce the 6" diameter of the pipes connected to the extractor hood.





Step 2: PREPARING THE WALL

- The wall must be flat and perpendicular.
- Ensure that the wall is capable of providing a firm hold for mounting screws and plugs.

Weight in kg: 8,8

We reserve the right to construction changes within the context of technical development.

INSTALLATION

1. Hold the fan on the wall.
Note the direction of the air conduction.
2. Mark the 4 mounting boreholes.
 At least one screw must be installed through a stud.
 The wall plugs must be suitable for the brickwork.
3. Drill the 4 x 1/4" Ø mounting boreholes.
Insert wall plugs and screw the fan to the wall.
4. Connect the pipe from the fan to the extractor hood and feed to the outside.
5. Connect the fan to the extractor hood with an extension cable if required.
Use the added connector.
Use the wire diagram for connecting.
 The additional cover on the plug must always be attached and closed for safety reasons.
 Not needed wires must be isolated, capped with wire nuts and stored in a safe position.

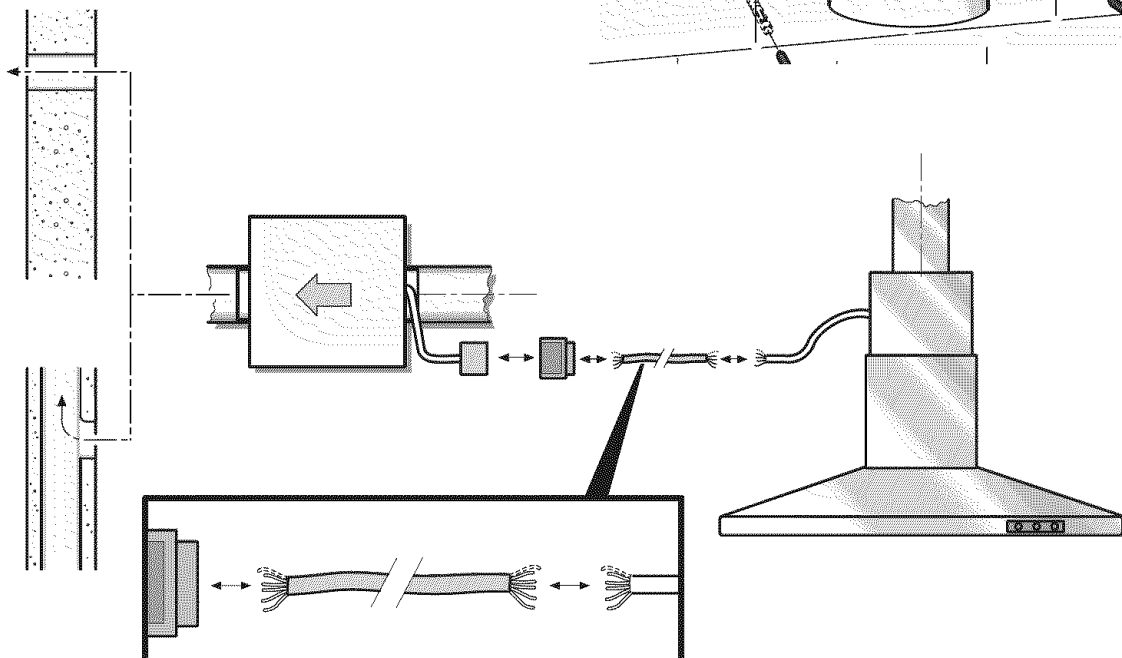
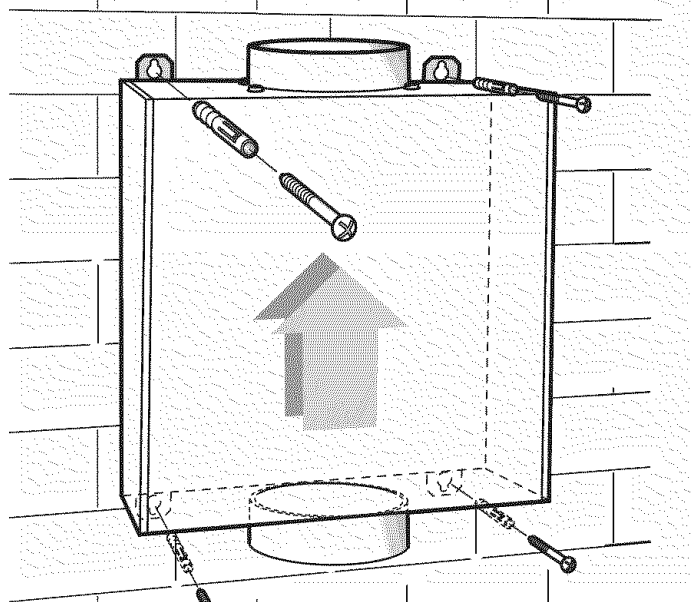
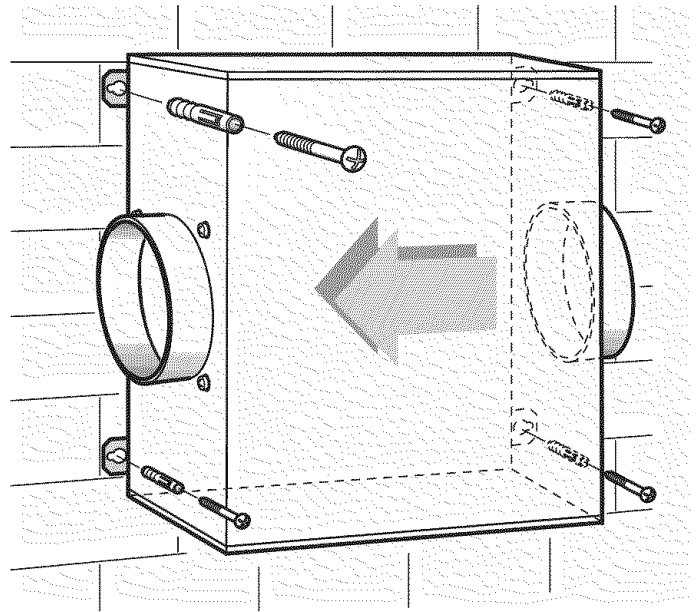

WIRE DIAGRAMM

- speed 1 (red)
- speed 2 (blue)
- speed 3 (orange)
- speed 4 (brown)
- N (white)
- PE (green/yellow)

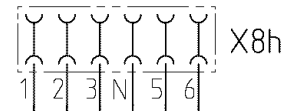
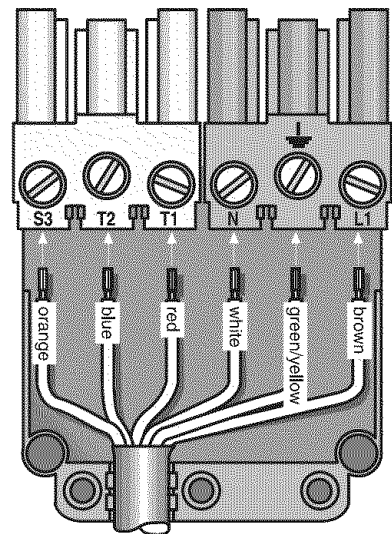

brown
green/yellow

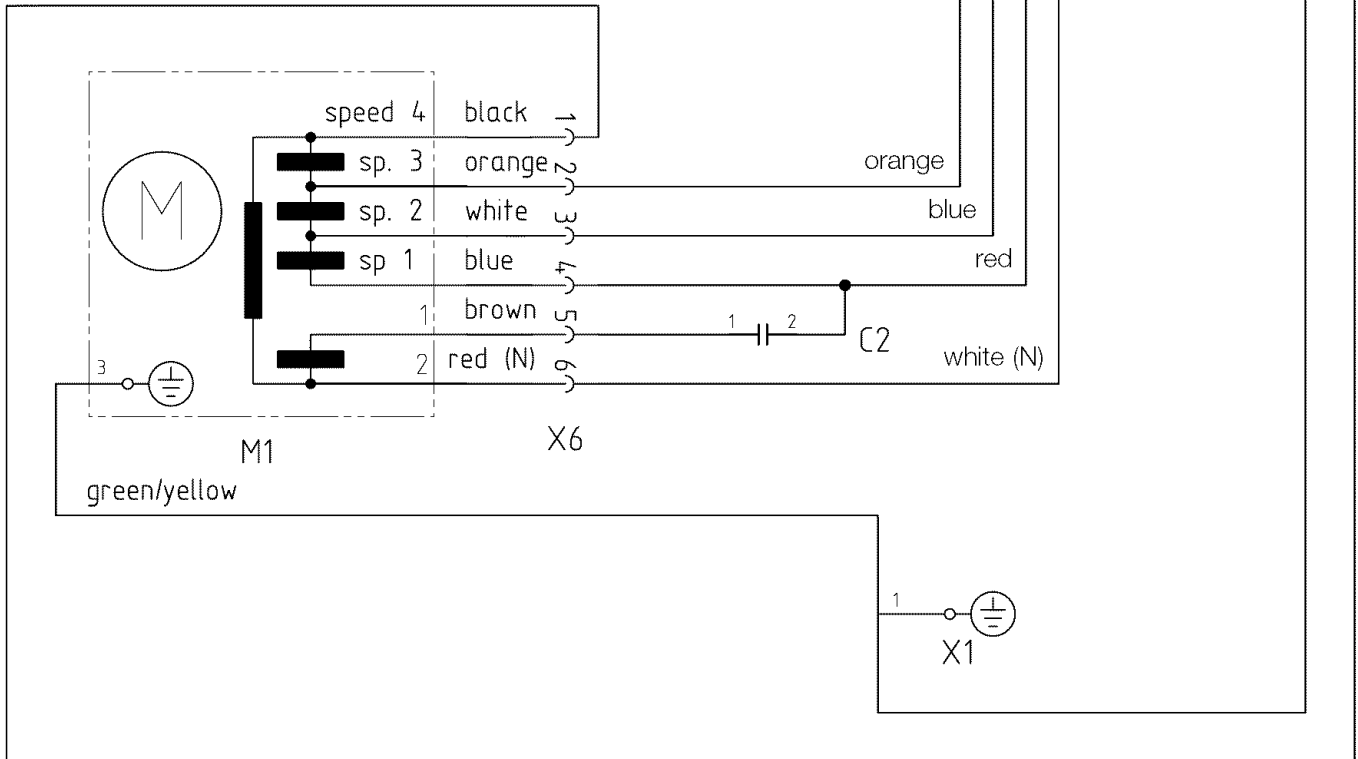

Thermador[®] | *An American Icon*[™]

5551 McFadden Avenue, Huntington Beach CA, 92649 • 800-735-4328 • www.thermador.com
9000180879 • 10013 RevB • 10/06 © BSH Home Appliances Corporation • Litho in U.S.A.