

# Panasonic®

## Operating Instructions

Digital Camera

Model No. **DMC-FX12**

**DMC-FX10**

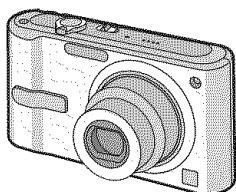

Before connecting, operating or adjusting this product, please read the instructions completely.

**LEICA**  
**DC VARIO-ELMARIT**

For USA assistance, please call: 1-800-272-7033 or send e-mail to : [digitalstillcam@us.panasonic.com](mailto:digitalstillcam@us.panasonic.com)

For Canadian assistance, please call: 1-800-99-LUMIX (1-800-995-8649) or  
send e-mail to: [lumixconcerge@ca.panasonic.com](mailto:lumixconcerge@ca.panasonic.com)



VQT1C14

## Dear Customer,

We would like to take this opportunity to thank you for purchasing this Panasonic Digital Camera. Please read these Operating Instructions carefully and keep them handy for future reference.

## Information for Your Safety

### WARNING:

**TO REDUCE THE RISK OF FIRE, ELECTRIC SHOCK OR PRODUCT DAMAGE,**

- **DO NOT EXPOSE THIS APPARATUS TO RAIN, MOISTURE, DRIPPING OR SPLASHING AND THAT NO OBJECTS FILLED WITH LIQUIDS, SUCH AS VASES, SHALL BE PLACED ON THE APPARATUS.**
- **USE ONLY THE RECOMMENDED ACCESSORIES.**
- **DO NOT REMOVE THE COVER (OR BACK); THERE ARE NO USER SERVICEABLE PARTS INSIDE. REFER SERVICING TO QUALIFIED SERVICE PERSONNEL.**

Carefully observe copyright laws. Recording of pre-recorded tapes or discs or other published or broadcast material for purposes other than your own private use may infringe copyright laws. Even for the purpose of private use, recording of certain material may be restricted.

- Please note that the actual controls and components, menu items, etc. of your Digital Camera may look somewhat different from those shown in the illustrations in these Operating Instructions.
- SDHC Logo is a trademark.
- Leica is a registered trademark of Leica Microsystems IR GmbH.
- Elmarit is a registered trademark of Leica Camera AG.
- Other names, company names, and product names printed in these instructions are trademarks or registered trademarks of the companies concerned.

THE SOCKET OUTLET SHALL BE INSTALLED NEAR THE EQUIPMENT AND SHALL BE EASILY ACCESSIBLE.

### CAUTION

Danger of explosion if battery is incorrectly replaced. Replace only with the same or equivalent type recommended by the manufacturer. Dispose of used batteries according to the manufacturer's instructions.

### Warning

Risk of fire, explosion and burns. Do not disassemble, heat above 60 °C (140 °F) or incinerate.

Marking sign is located on bottom of the unit.



A lithium ion/polymer battery that is recyclable powers the product you have purchased. Please call 1-800-8-BATTERY for information on how to recycle this battery.

## THE FOLLOWING APPLIES ONLY IN THE U.S.A.

### FCC Note:

This equipment has been tested and found to comply with the limits for a Class B digital device, pursuant to Part 15 of the FCC Rules. These limits are designed to provide reasonable protection against harmful interference in a residential installation. This equipment generates, uses, and can radiate radio frequency energy and, if not installed and used in accordance with the instructions, may cause harmful interference to radio communications. However, there is no guarantee that interference will not occur in a particular installation. If this equipment does cause harmful interference to radio or television reception, which can be determined by turning the equipment off and on, the user is encouraged to try to correct the interference by one or more of the following measures:

- Reorient or relocate the receiving antenna.
- Increase the separation between the equipment and receiver.
- Connect the equipment into an outlet on a circuit different from that to which the receiver is connected.
- Consult the dealer or an experienced radio/TV technician for help.

**FCC Caution:** To assure continued compliance, follow the attached installation instructions and use only shielded interface cables with ferrite core when connecting to computer or peripheral devices.

Any changes or modifications not expressly approved by the party responsible for compliance could void the user's authority to operate this equipment.

### Declaration of Conformity

Trade Name: Panasonic  
 Model No.: DMC-FX12  
 DMC-FX10  
 Responsible party: Panasonic Corporation of North America  
 One Panasonic Way,  
 Secaucus, NJ 07094  
 Support Contact: Panasonic Consumer Electronics Company  
 1-800-272-7033

This device complies with Part 15 of the FCC Rules. Operation is subject to the following two conditions: (1) This device may not cause harmful interference, and (2) this device must accept any interference received, including interference that may cause undesired operation.



**Panasonic**  
DMC-FX12



**Panasonic**  
DMC-FX10

## THE FOLLOWING APPLIES ONLY IN CANADA

This Class B digital apparatus complies with Canadian ICES-003

**-If you see this symbol-**

**Information on Disposal in other Countries outside the European Union**

This symbol is only valid in the European Union.

If you wish to discard this product, please contact your local authorities or dealer and ask for the correct method of disposal.

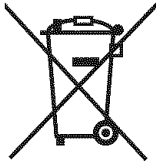

**■ About the battery pack**

**CAUTION**

Battery pack (Lithium ion battery pack)

- Use the specified unit to recharge the battery pack.
- Do not use the battery pack with equipment other than the specified unit.
- Do not get dirt, sand, liquids, or other foreign matter on the terminals.
- Do not touch the plug terminals (+ and -) with metal objects.
- Do not disassemble, remodel, heat or throw into fire.

If any electrolyte should come into contact with your hands or clothes, wash it off thoroughly with water.

If any electrolyte should come into contact with your eyes, never rub the eyes. Rinse eyes thoroughly with water, and then consult a doctor.

**■ About the battery charger**

**CAUTION!**

**DO NOT INSTALL OR PLACE THIS UNIT IN A BOOKCASE, BUILT-IN CABINET OR IN ANOTHER CONFINED SPACE. ENSURE THE UNIT IS WELL VENTILATED. TO PREVENT RISK OF ELECTRIC SHOCK OR FIRE HAZARD DUE TO OVERHEATING, ENSURE THAT CURTAINS AND ANY OTHER MATERIALS DO NOT OBSTRUCT THE VENTILATION VENTS.**

**Battery charger**

This battery charger operates on AC between 110 V and 240 V.

But

- In the U.S.A. and Canada, the battery charger must be connected to a 120 V AC power supply only.
- When connecting to an AC supply outside of the U.S.A. or Canada, use a plug adaptor to suit the AC outlet configuration.

## ■ Care of the camera

- **Do not strongly shake or bump the camera.**

This unit may malfunction, recording pictures may no longer be possible or the lens or the LCD monitor may be damaged.

- We strongly recommend you do not leave the camera in your pants pocket when you sit down or forcefully insert it into a full or tight bag etc. Damage to the LCD monitor or personal injury may result.



- **Be particularly careful in the following places as they may cause this unit to malfunction.**

- Places with a lot of sand or dust.
- Places where water can come into contact with this unit such as when using it on a rainy day or on a beach.

- **If water or seawater splashes on the camera, use a dry cloth to wipe the camera body carefully.**

## ■ About Condensation (When the lens is fogged up)

- Condensation occurs when the ambient temperature or humidity changes. Be careful of condensation since it causes lens stains, fungus and camera malfunction.
- If condensation occurs, turn the camera off and leave it for about 2 hours. The fog will disappear naturally when the temperature of the camera becomes close to the ambient temperature.

- **Read together with the “Cautions for Use”. (P90)**

## ■ About cards that can be used in this unit

You can use an SD Memory Card, an SDHC Memory Card and a MultiMediaCard.

- When the term **card** is used in these operating instructions this refers to the following types of Memory Cards.
  - SD Memory Card (8 MB to 2 GB)
  - SDHC Memory Card (4 GB)
  - MultiMediaCard

More specific information about memory cards that can be used with this unit.

- You can only use an SDHC Memory Card if using cards with 4 GB or more capacity.
- A 4 GB Memory Card without an SDHC logo is not based on the SD Standard and will not work in this product.

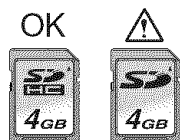

- A MultiMediaCard is compatible with still pictures only.

## ■ About illustrations in these operating instructions

The procedure is described for **DMC-FX12** as an example.

# Contents

## Before Use

Information for Your Safety.....	2
----------------------------------	---

## Preparation

Standard Accessories.....	8
Names of the Components.....	8
Quick Guide.....	10
Charging the Battery with the Charger ...	11
About the Battery (charging/number of recordable pictures).....	12
Inserting and Removing the Battery/the Card (optional).....	13
About the Built-in Memory/the Card (optional).....	14
Setting Date/Time (Clock Set).....	15
• Changing the clock setting.....	15
About the Mode Dial.....	16
Setting the Menu.....	17
About the Setup Menu.....	18
LCD Monitor Display/Switching the LCD Monitor Display.....	21

## Basic

Taking pictures.....	22
Taking Pictures in Simple Mode.....	24
Taking Pictures with the Zoom.....	26
• Using the Optical Zoom/Using the Extended Optical Zoom (EZ).....	26
• Using the Digital Zoom Further extending the zoom.....	28
Checking the Recorded Picture (Review).....	29
Playing back/Deleting Pictures.....	30

## Advanced (Recording pictures)

About the LCD Monitor.....	32
• Changing the information displayed.....	32

• Brightening the LCD Monitor (Power LCD/High angle mode).....	34
Taking Pictures using the Built-in Flash.....	35
Taking Pictures with the Self-timer.....	39
Compensating the Exposure.....	40
Optical Image Stabilizer.....	41
Changing the sensitivity according to the movement of the subject being recorded.....	42
Taking Close-up Pictures.....	43
Taking pictures that match the scene being recorded (Scene mode).....	44
– [PORTRAIT].....	45
– [SOFT SKIN].....	45
– [SELF PORTRAIT].....	46
– [SCENERY].....	46
– [SPORTS].....	46
– [NIGHT PORTRAIT].....	46
– [NIGHT SCENERY].....	47
– [FOOD].....	47
– [PARTY].....	47
– [CANDLE LIGHT].....	48
– [BABY1]/[BABY2].....	48
– [PET].....	49
– [SUNSET].....	49
– [HIGH SENS.].....	49
– [STARRY SKY].....	49
– [FIREWORKS].....	50
– [BEACH].....	50
– [SNOW].....	51
– [AERIAL PHOTO].....	51
– [UNDERWATER].....	51
Motion Picture Mode.....	52
Recording which Day of the Vacation You Take the Picture.....	54
Displaying the Time at the Travel Destination (World Time).....	56
Using the [REC] Mode Menu.....	58
• [W.BALANCE] Adjusting the hue for a more natural picture.....	59
• [SENSITIVITY] Setting the light sensitivity.....	60

- [ASPECT RATIO]  
Setting the aspect ratio of pictures... 60
- [PICT.SIZE]/[QUALITY]  
Setting a picture size and  
quality that match your use of the  
pictures..... 61
- [AF MODE]  
Setting the focus method..... 62
- [BURST]  
Taking Pictures using Burst..... 63
- [AF ASSIST LAMP]  
Focusing in low light conditions  
becomes easier ..... 63
- [COL.MODE]  
Setting a color effect and picture  
quality for the recorded picture ..... 64
- [CLOCK SET]  
Set the display order for the date  
and time..... 64

---



---

## Advanced (Playback)

---



---

- Displaying Multiple Screens  
(Multi Playback)..... 65
- Displaying Pictures by Recording Date  
(Calendar Playback)..... 66
- Using the Playback Zoom..... 67
- Playing Back Motion Pictures ..... 68
- Using the [PLAY] mode menu ..... 69
  - [SLIDE SHOW]  
Playing back pictures in order  
for a fixed duration..... 70
  - [FAVORITE]  
Setting your favorite pictures..... 70
  - [ROTATE DISP.]/[ROTATE]  
To display the picture rotated..... 71
  - [DATE STAMP]  
Stamping information such as  
the date on the recorded pictures..... 72
  - [DPOF PRINT]  
Setting the picture to print and the  
number of prints ..... 74
  - [PROTECT]  
Preventing accidental erasure of  
pictures..... 76

- [RESIZE]  
Making the picture smaller..... 77
- [TRIMMING]  
Enlarging a picture and trimming it... 78
- [COPY]  
Copying the picture data..... 79
- [FORMAT]  
Initializing the card..... 80

---



---

## Connecting to other equipment

---



---

- Connecting to a PC..... 81
- Printing the Pictures..... 83
- Playing Back Pictures on a TV Screen ...87

---



---

## Others

---



---

- Screen Display..... 88
- Cautions for Use ..... 90
- Message Display ..... 92
- Troubleshooting ..... 94
- Number of Recordable Pictures and  
Available Recording Time ..... 99
- Specifications..... 102
- Digital Camera Accessory System..... 105
- Digital Camera Accessory Order Form  
(For USA Customers)..... 106
- Request for Service Notice  
(For USA Only)..... 107
- Limited Warranty (For USA Only) ..... 108
- Customer Services Directory  
(For USA Only)..... 110
- Précautions à prendre  
(pour le Canada) ..... 111
- Index ..... 113

## Standard Accessories

Check that all the accessories are included before using the camera.

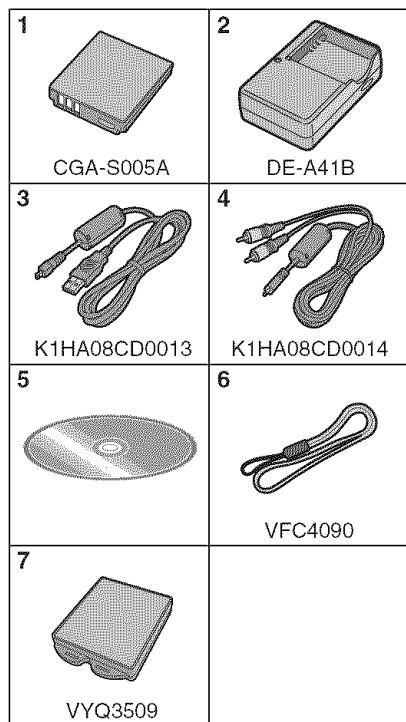

- 1 Battery Pack  
(Indicated as **battery** in the text)
  - 2 Battery Charger  
(Indicated as **charger** in the text)
  - 3 USB Connection Cable
  - 4 AV Cable
  - 5 CD-ROM
  - 6 Strap
  - 7 Battery Carrying Case
- SD Memory Card, SDHC Memory Card and MultiMediaCard are indicated as **card** in the text.
  - **The card is optional.**  
**You can record or play back pictures on the built-in memory when you are not using a card. (P14)**
  - For information about optional accessories, refer to the "Digital Camera Accessory System". (P105)
  - If any accessories are lost, customers in the USA should contact Panasonic's parts department at 1 800 833-9626 and customers in Canada should contact 1 800 99-LUMIX (1-800-995-8649) for further information about obtaining replacement parts.

## Names of the Components

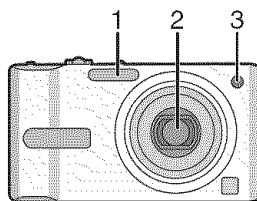

- 1 Flash (P35)
- 2 Lens (P91)
- 3 Self-timer indicator (P39)  
AF assist lamp (P63)



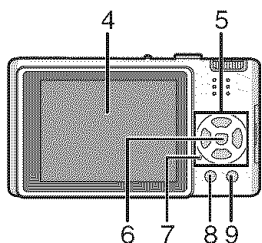

- 4 LCD monitor (P32, 88)  
 5 Cursor buttons  
 ◀/Self-timer button (P39)  
 ▼/[REV] button (P29)  
 ▶/Flash setting button (P35)  
 ▲/Exposure compensation (P40)/  
 Backlight compensation in simple mode  
 button (P26)

In these operating instructions, the operations on the cursor button are described as illustrated as shown. The illustrations in these operating instructions show DMC-FX12. e.g.: When you press the ▼ button

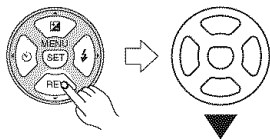

- 6 [MENU/SET] button (P15)  
 7 Status indicator (P19, 21)  
 8 [DISPLAY/LCD MODE] button (P32, 34)  
 9 [FUNC] (P58)/Delete button (P30)

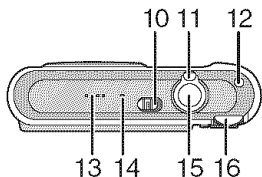

- 10 Camera ON/OFF switch (P10, 15)  
 11 Zoom lever (P26)  
 12 Optical image stabilizer button (P41)  
 13 Speaker (P68)  
 14 Microphone (P52)  
 15 Shutter button (P22, 52)  
 16 Mode dial (P16)

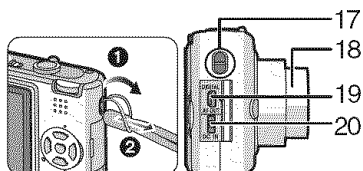

- 17 Strap eyelet  
 • When detaching the strap, untie the knot in the string with a pointed object and then detach it.  
 18 Lens barrel  
 19 [DIGITAL/AV OUT] socket (P81, 83, 87)  
 20 [DC IN] socket (P81, 83)  
 • Always use a genuine Panasonic AC adaptor (DMW-AC5PP; optional).  
 • This camera cannot charge the battery even though the AC adaptor (DMW-AC5PP; optional) is connected to it.

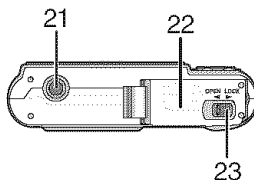

- 21 Tripod receptacle  
 • When you use a tripod, make sure the tripod is stable when the camera is attached to it.  
 22 Card/Battery door (P13)  
 23 Release lever (P13)

## Quick Guide

This is an overview of how to record and playback pictures with the camera. For each step, be sure to refer to the pages indicated in brackets.

### 1 Charge the battery. (P11)

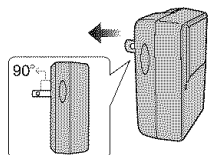

- The battery is not charged when the camera is shipped. Charge the battery before use.

### 2 Insert the battery and the card. (P13)

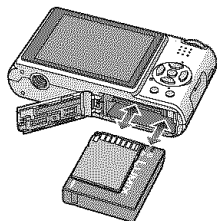

- When you do not use the card, you can record or play back pictures on the built-in memory. (P14) Refer to P14 when you use a card.

### 3 Turn the camera on to take pictures.

- Set the clock. (P15)

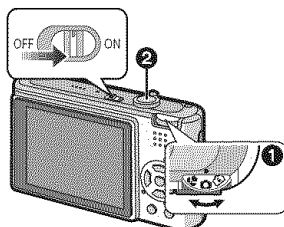

- 1 Set the mode dial to [📷].
- 2 Press the shutter button to take pictures. (P22)

### 4 Play back the pictures.

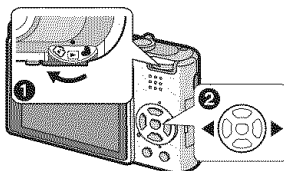

- 1 Set the mode dial to [▶].
- 2 Select the picture you want to view. (P30)

## Charging the Battery with the Charger

The battery is not charged when the camera is shipped. Charge the battery before use.

### 1 Attach the battery with attention to the direction of the battery.

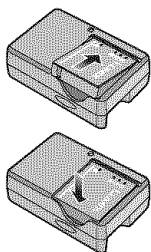

### 2 Connect the charger to the electrical outlet.

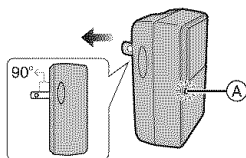

- Charging starts when the [CHARGE] indicator (A) lights green.
- Charging is complete when the [CHARGE] indicator (A) turns off (after about 130 minutes).
- When the [CHARGE] indicator flashes, read P12.

### 3 Detach the battery after charging is completed.

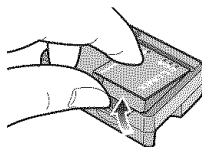

- After charging is completed, be sure to disconnect the charger from the electrical outlet.
- The battery becomes warm after using it and during and after charging. The camera also becomes warm during use. This is not a malfunction.
- The battery will be exhausted if left for a long period of time after being charged. Recharge the battery when it is exhausted.
- The battery can be charged even if it is not fully discharged.
- **Use the dedicated charger and battery.**
- **Charge the battery with the charger indoors.**
- **Do not disassemble or modify the charger.**

# About the Battery

## (charging/number of recordable pictures)

### ■ The battery life

The number of recordable pictures (By CIPA standard in normal picture mode [📷])

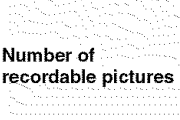
 <p><b>Number of recordable pictures</b></p>	Approx. 350 pictures (Approx. 175 min) (DMC-FX12)/
	Approx. 370 pictures (Approx. 185 min) (DMC-FX10)

### Recording conditions by CIPA standard

- Temperature: 23 °C (73.4 °F)/ Humidity: 50% when LCD monitor is on.\*
- Using a Panasonic SD Memory Card (16 MB).
- Using the supplied battery.
- Starting recording 30 seconds after the camera is turned on. (When the optical image stabilizer function is set to [MODE1].)
- **Recording once every 30 seconds** with full flash every second recording.
- Rotating the zoom lever from Tele to Wide or vice versa in every recording.
- Turning the camera off every 10 recordings and leaving it until the temperature of the battery decreases.
- \* The number of recordable pictures decreases when the power LCD function or high angle mode (P34) are used.
- CIPA is an abbreviation of [Camera & Imaging Products Association].

The number of recordable pictures varies depending on the recording interval time.

If the recording interval time becomes longer, the number of recordable pictures decreases.

[e.g. When recording once every 2 minutes, the number of recordable pictures decreases to about 86 (DMC-FX12)/92 (DMC-FX10).]

### Playback time

<b>Playback time</b>	Approx. 450 min
----------------------	-----------------

The number of recordable pictures and playback time will vary depending on the operating conditions and storing condition of the battery.

### ■ Charging

<b>Charging time</b>	Approx. 130 min
----------------------	-----------------

Charging time and number of recordable pictures with the optional battery pack (CGA-S005A) are the same as above.

- The [CHARGE] indicator lights when charging starts.

### ■ When the [CHARGE] indicator flashes

- The battery is over discharged (discharged excessively). In a while, [CHARGE] indicator will light up and normal charging will start.
- When the battery temperature is excessively high or low, [CHARGE] indicator flashes and the charging time will be longer than normal.
- The terminals of the charger or the battery are dirty. In this case, wipe them with a dry cloth.
- When the operating time of the camera becomes extremely short even after properly charging the battery, the life of the battery may have expired. Buy a new battery.

### ■ Charging conditions

- Charge the battery in a temperature between 10 °C to 35 °C (50 °F to 95 °F). (The battery temperature should also be the same.)
- The performance of the battery may temporarily deteriorate and the operating time may become shorter in low temperature conditions (e.g. skiing/snowboarding).

# Inserting and Removing the Battery/ the Card (optional)

- Check that this unit is turned off.
- Prepare a card. (optional)
- You can record or play back pictures on the built-in memory when you are not using a card. (P14)

**1** Slide the release lever in the direction of the arrow and open the card/battery door.

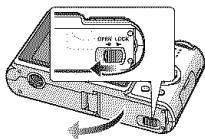

- Always use genuine Panasonic batteries (CGA-S005A).
- If you use other batteries, we cannot guarantee the quality of this product.

## 2 Battery:

Insert it fully being careful about the direction you insert it. Pull the lever (A) in the direction of the arrow to remove the battery.

Card:

Push it fully until it clicks being careful about the direction you insert it.

To remove the card, push the card until it clicks, then pull the card out upright.

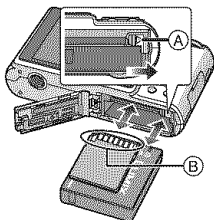

- (B): Do not touch the connection terminals of the card.
- The card may be damaged if it is not fully inserted.

**3** **1** Close the card/battery door.  
**2** Slide the release lever in the direction of the arrow.

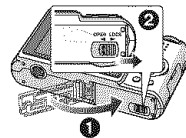

- If the card/battery door cannot be completely closed, remove the card, check its direction and then insert it again.



- Remove the battery after use. Store the removed battery in the battery carrying case (supplied).
- Do not remove the card or the battery while the card is being accessed. The data may be damaged. (P21)
- Do not remove the battery until the LCD monitor and the status indicator (green) turn off as the settings on the camera may not be stored properly.
- The supplied battery is designed only for the camera. Do not use it with any other equipment.
- Do not insert or remove the battery or the card while this unit is turned on. The data on the built-in memory or the card may be damaged. Be particularly careful while the built-in memory or the card is being accessed. (P21)
- We recommend using a Panasonic card.

## About the Built-in Memory/the Card (optional)

The built-in memory can be used as a temporary storage device when the card being used becomes full.

### ■ Built-in Memory [IN]

You can record or play back pictures with the built-in memory.

(The built-in memory cannot be used when a card is inserted.)

- The built-in memory capacity is about 27 MB.
- Picture size is fixed to QVGA (320×240 pixels) when recording motion pictures to the built-in memory. (P52)

### ■ Card [ ]

When a card is inserted, you can record or play back pictures on a card.

#### ■ Card (optional)

- The SD Memory Card, SDHC Memory Card and MultiMediaCard are small, lightweight, removable external cards. Read P5 for information about cards that can be used in this unit.
- The SDHC Memory Card is a memory card standard decided by the SD Association in 2006 for high capacity memory cards more than 2 GB.
- The reading/writing speed of an SD Memory Card and an SDHC Memory Card is fast. Both types of card are equipped with a Write-Protect switch (A) that prevents writing and formatting the card. (If the switch is slid to the [LOCK] side, it is not possible to write or delete data on the card and format it. When the switch is slid to the other side, these functions become available.)

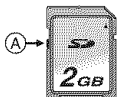

- You can use an SDHC Memory Card in equipment that is compatible with SDHC Memory Cards however you cannot use an SDHC Memory Card in equipment that is only compatible with SD Memory Cards. (Always read the operating instructions for the equipment being used. If you also order a photo studio to print pictures, ask the photo studio before printing.)

Please confirm the latest information on the following website.

<http://panasonic.co.jp/pavc/global/cs>

(This Site is English only.)

- Refer to P99 for information about the number of recordable pictures and the available recording time for each Card.
- This unit (SDHC compatible equipment) is compatible with SD Memory Cards based on SD Memory Card Specifications and formatted in FAT12 system and FAT16 system. It is also compatible with SDHC Memory Cards based on SD Memory Card Specifications and formatted in FAT32 system.
- We recommend using High Speed SD Memory Cards/SDHC Memory Cards when recording motion pictures. (P52)



- The data on the built-in memory or the card may be damaged or lost due to electromagnetic waves, static electricity or breakdown of the camera or the card. We recommend storing important data on a PC etc.
- The reading/writing speed of a MultiMediaCard is slower than an SD Memory Card or SDHC Memory Card. When a MultiMediaCard is used, the performance of certain features may be slightly slower than advertised.
- Do not format the card on your PC or other equipment. Format it on the camera only to ensure proper operation. (P80)
- Keep the Memory Card out of reach of children to prevent swallowing.

# Setting Date/Time (Clock Set)



## ■ Initial setting

The clock is not set so the following screen appears when you turn the camera on.

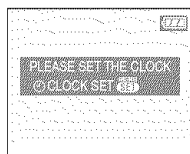
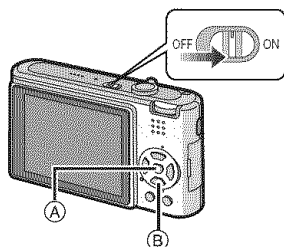

(A): [MENU/SET] button

(B): Cursor buttons

## 1 Press [MENU/SET].

## 2 Press ▲/▼/◀/▶ to select the date and time.

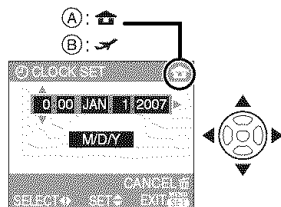

(A): Time at the home area

(B): Time at the travel destination (P56)

- ◀/▶: Select the desired item.
- ▲/▼: Set the display order for the date and time.
- : Cancel without setting the clock.

## 3 Press [MENU/SET] to set.

- Turn the camera off after setting the clock. Then set the mode dial to a recording mode to turn the camera on and check whether or not the clock setting is correct.

## ■ Changing the clock setting

- 1 Press [MENU/SET].
- 2 Press ▲/▼ to select [CLOCK SET]. (P64)
- 3 Press ▶ and then perform steps **2** and **3** to set the clock.
- 4 Press [MENU/SET] to close the menu.
  - You can also set the clock in the [SETUP] menu. (P18)



- When a fully charged battery has been inserted for more than 24 hours, the clock setting is stored (in the camera) for at least 3 months even if the battery is removed. (If you insert a battery that is not sufficiently charged, the length of time that the clock setting is stored may become less.) However, the clock setting is canceled after this length of time. In this case, set the clock again.
- You can set the year from 2000 to 2099. The 24-hour system is used.
- If the clock is not set, the correct date cannot be printed when you stamp the date on the pictures with [DATE STAMP] (P72) or order a photo studio to print the pictures. (P75)

## About the Mode Dial

If you turn on this unit and then rotate the mode dial, you can not only switch between recording and playback but also switch to macro mode to take a close-up picture of a subject or to a scene mode that matches your recording purpose.

### Switching the mode dial

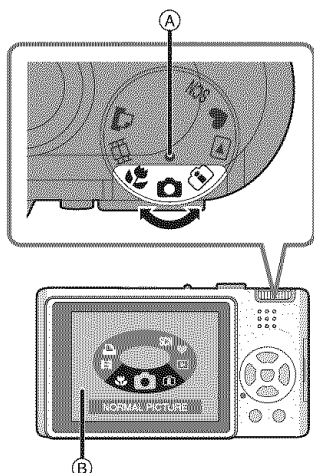

### Adjust part A to the desired mode.

Rotate the mode dial slowly and surely to adjust to each mode. (Do not adjust it to parts where there is no mode.)

- The above screen B appears on the LCD monitor if the mode dial is rotated.

### Basic

**P** : Normal picture mode (P22)  
Use this mode for normal recording.

**♥** : Simple mode (P24)  
This mode is recommended for beginners.

**▶** : Playback mode (P30)  
This mode allows you to play back recorded pictures.

### Advanced

**ISO** : Intelligent ISO sensitivity mode (P42)

This allows you to set the optimal ISO sensitivity and shutter speed according to the movement and the brightness of the subject.

**🌸** : Macro mode (P43)  
This allows you to take close-up pictures of a subject.

**SCN** : Scene mode (P44)  
This allows you to take pictures that match the scene being recorded.

**🎬** : Motion picture mode (P52)  
This mode allows you to record motion pictures.

**🖨️** : Print mode (P83)  
Use this to print pictures.



# Setting the Menu

## ■ Displaying the menu screens

Press [MENU/SET].

e.g.: The first page of the total 3 pages is displayed.

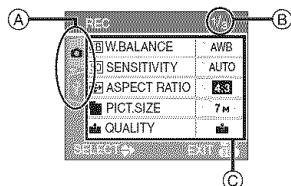

(A) Menu icons

(B) Current page

(C) Menu items and settings

- Rotate the zoom lever to switch to the next/previous page easily.
- The menu icons and the menu items that are displayed differ depending on the position of the mode dial.

## ■ About the menu icons

[REC] mode menu (P58):

This is displayed when the mode dial is set to [] [] [] [] [] [].

[PLAY] mode menu (P69):

This is displayed when the mode dial is set to [].

[SCENE MODE] menu (P44):

This is displayed when the mode dial is set to [].

[SETUP] menu (P18):

This is displayed when the mode dial is set to [] [] [] [] [] [] [].

## ■ Setting menu items

- The following example shows how to set [AF MODE] when normal picture mode [] is selected.

1 Press / to select the menu item.

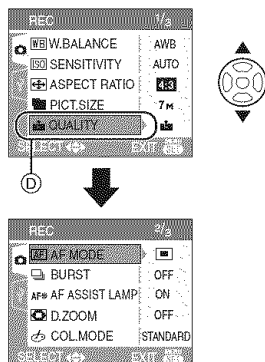

- Press at (D) to switch to the next screen.

2 Press .

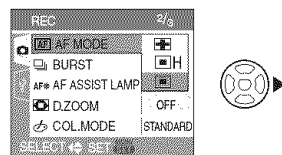

3 Press / to select the setting.

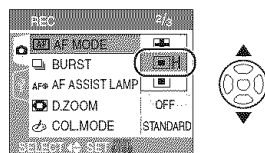

4 Press [MENU/SET] to set.

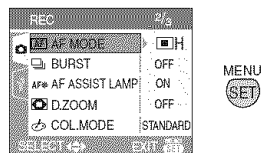



- Power save mode is not activated in the following cases.
  - When using the AC adaptor (DMW-AC5PP; optional)
  - When connecting to a PC or a printer
  - When recording or playing back motion pictures
  - During a slide show (P70)

## ECO [ECONOMY]

### (Turning off the LCD monitor automatically.)

Press [  ] to display the [SETUP] menu and select the item to set. (P17)

The brightness of the LCD monitor is reduced, and the LCD monitor is turned off automatically while the camera is not in use, to save battery life when recording.

**[LEVEL 1]:** The LCD monitor turns off if the camera is not operated for about 15 seconds in recording mode.

**[LEVEL 2]:** The LCD monitor turns off if the camera is not operated for about 15 seconds in recording mode or for about 5 seconds after taking a picture.

**[OFF]:** Economy mode cannot be activated.

- The LCD monitor is turned off while the flash is being charged.
- The status indicator lights while the LCD monitor is turned off. Press any button to turn on the LCD monitor again.
- Power save mode is fixed to [2MIN.]. [However, power save mode is not activated when using the AC adaptor (DMW-AC5PP; optional).]
- The brightness of the LCD monitor is not reduced in Power LCD mode and high angle mode.
- Economy mode is not activated in the following cases.
  - In simple mode [  ]
  - When using the AC adaptor (DMW-AC5PP; optional)
  - While a menu screen is displayed

- While the self-timer is set
- While recording motion pictures

## [WORLD TIME] (P56)

Press [  ] to display the [SETUP] menu and select the item to set. (P17)  
Set the time in your home area and travel destination.

[  ]: Your home area

[  ]: Travel destination area

## [MONITOR]

Press [  ] to display the [SETUP] menu and select the item to set. (P17)  
Adjust the brightness of the LCD monitor in 7 steps.

## [TRAVEL DATE] (P54)

Press [  ] to display the [SETUP] menu and select the item to set. (P17)  
Set the departure date and the return date of the vacation.

## [SET], [OFF]

## [BEEP]

Press [  ] to display the [SETUP] menu and select the item to set. (P17)  
This allows you to set the beep.

## [BEEP LEVEL]

[  ]: No operation sound

[  ]: Soft operation sound

[  ]: Loud operation sound

[BEEP TONE]:   

## [SHUTTER]

Press [  ] to display the [SETUP] menu and select the item to set. (P17)  
This allows you to set the shutter sound.

## [SHUTTER VOL.]

[  ]: No shutter sound

[  ]: Soft shutter sound

[  ]: Loud shutter sound

[SHUTTER TONE]:   

 **[VOLUME]**

Press [  ] to display the [SETUP] menu and select the item to set. (P17)

The volume of speakers can be adjusted in 7 steps from level 6 to 0.

- When you connect the camera to a TV, the volume of the TV speakers does not change.

 **[NO.RESET]**

Press [  ] to display the [SETUP] menu and select the item to set. (P17)

The folder number is updated and the file number starts from 0001. (P82)

- A folder number between 100 and 999 can be assigned.  
When the folder number reaches 999, the number cannot be reset. We recommend formatting the card after saving the data on a PC or elsewhere.
- To reset the folder number to 100, format (P80) the built-in memory or the card first and then use this function to reset the file number.

A reset screen for the folder number will then appear. Select [YES] to reset the folder number.

 **[RESET]**

Press [  ] to display the [SETUP] menu and select the item to set. (P17)

The [REC] or [SETUP] menu settings are reset to the initial settings.

- [FAVORITE] (P70) is fixed to [OFF] and [ROTATE DISP.] (P71) is fixed to [ON].
- If the [SETUP] menu settings are reset, the following settings are also reset.
  - The birthday settings for [BABY1]/[BABY2] (P48) and [PET] (P49) in scene mode.
  - The number of days that have passed since the departure date in [TRAVEL DATE]. (P54)
  - The [WORLD TIME] (P56) setting.
- The folder number and the clock setting are not changed.

 **[VIDEO OUT]**

(Playback mode only) (P87)

Press [  ] to display the [SETUP] menu and select the item to set. (P17)

Set to match the color television system in each country.

**[NTSC]:** Video output is set to NTSC system.

**[PAL]:** Video output is set to PAL system.

 **[TV ASPECT]**

(Playback mode only)

Press [  ] to display the [SETUP] menu and select the item to set. (P17)

Set to match the type of TV.

**[16:9]:**

When connecting to a 16:9 screen TV.

**[4:3]:**

When connecting to a 4:3 screen TV.

 **[DIAL DISPLAY]**

Press [  ] to display the [SETUP] menu and select the item to set. (P17)

Set whether or not to show the mode dial display when the mode dial is rotated.

**[ON], [OFF]**

 **[LANGUAGE]**

Press [  ] to display the [SETUP] menu and select the item to set. (P17)

Set the language displayed on the screen.

**[ENGLISH], [DEUTSCH], [FRANÇAIS], [ESPAÑOL], [ITALIANO], [中文]\*, [日本語]**

\* Not displayed on DMC-FX12P/DMC-FX10P.

- If you set a different language by mistake, select [  ] from the menu icons to set the desired language.

# LCD Monitor Display/ Switching the LCD Monitor Display

## ■ Screen display in normal picture mode [ ] (Initial settings)

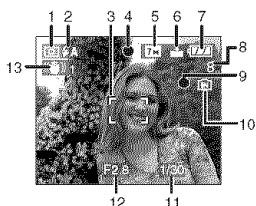

- 1 Recording mode
- 2 Flash mode (P35)
  - If you press the shutter button halfway when the flash is activated, the flash icon turns red.
- 3 AF area (P22)
  - The AF area displayed is bigger than usual when taking pictures in dark places.
- 4 Focus (P22)
- 5 Picture size (P61)
- 6 Quality (P61)
  - [ ]: Jitter alert (P24)
- 7 Battery indication
  - 
  - The indication turns red and blinks if the remaining battery power is exhausted. (The status indicator blinks when the LCD monitor turns off.) Recharge the battery or replace it with a fully charged battery.
  - It does not appear when you use the camera with the AC adaptor (DMW-AC5PP; optional) connected.
- 8 Number of recordable pictures (P99)
- 9 Recording state
- 10 Built-in memory/Card

- The access indication lights red when pictures are being recorded on the built-in memory (or the card).
  - When using the built-in memory



- When using the card



- Do not do the following when the access indication lamps lights. The card or the data on the card may be damaged and this unit may no longer operate normally.
  - Turn this unit off.
  - Remove the battery or the card (when using a card).
  - Shake or bump this unit.
  - Disconnect the AC adaptor. (DMW-AC5PP; optional) (when using the AC adaptor)
- Do not do the above when pictures are being read or deleted or the built-in memory (or the card) is being formatted (P80).
- The access time for the built-in memory may be longer than the access time for a card. (Max. about 7 sec.)

### 11 Shutter speed (P22)

### 12 Aperture value (P22)

- If the exposure is not adequate, the aperture value and the shutter speed turn red. (They do not turn red when the flash is activated.)

### 13 Optical Image Stabilizer (P41)



- Refer to P88 for information about other screen displays.

## ■ Switching the screen display

You can change the screen display by pressing [DISPLAY]. This allows you to display information while taking pictures such as the picture size or the number of recordable pictures or take pictures without displaying any information. Refer to P32 for details.

## Taking pictures



The camera automatically sets the shutter speed and the aperture value according to the brightness of the subject.

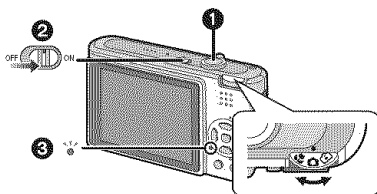

- 1**: Shutter button
- The status indicator **3** lights for about 1 second when you turn this unit on **2**.

**1** Hold this unit gently with both hands, keep your arms still at your side and stand with your feet slightly apart.

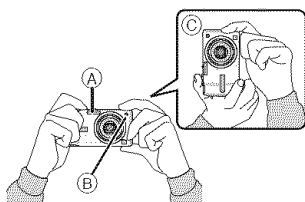

- (A): Flash  
 (B): AF assist lamp  
 (C): When holding the camera vertically

**2** Aim the AF area at the point you want to focus on.

**3** Press the shutter button halfway to focus.

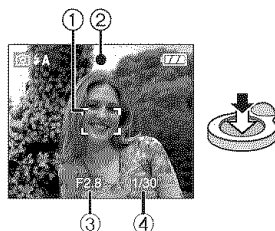

- The focus indication **2** lights green and the AF area **1** turns white to green.
- 3**: Aperture value
- 4**: Shutter speed
- The focus range is 50 cm (1.64 feet) to  $\infty$ .
- The subject is not focused in the following cases.
  - The focus indication blinks (green).
  - The AF area turns white to red or there is no AF area.
  - The focus sound beeps 4 times.
- If the distance is beyond the focus range, the picture may not be properly focused even if the focus indication lights.

**4** Press the shutter button fully to take a picture.



### ■ Using the flash

If the camera determines that the place where the picture is being taken is dark, the flash is activated when the shutter button is pressed fully. (When the flash is set to AUTO [⚡A] / AUTO / Red-eye reduction [⚡A⊙].)

- You can switch the flash setting to match the recording. (P35)



- When you press the shutter button, the LCD monitor may become bright or dark for a moment however the recorded picture will not be affected.
- Be careful not to move the camera when you press the shutter button.
- Do not cover the flash or the AF assist lamp with your fingers or other objects.
- Do not touch the front of the lens.

### ■ Exposure (P40)

- If you select normal picture mode [  ] the exposure is automatically adjusted to an appropriate exposure (AE=Auto Exposure). However, depending on recording conditions such as the backlight, the picture will become dark.

**In this case, compensate the exposure. This allows you to take bright pictures.**

### ■ Focusing (P23, 43)

If you select normal picture mode [  ], the picture is automatically focused (AF= Auto Focus). However, one of the subjects in the picture may not be properly focused. The focus range is 50 cm (1.64 feet) to  $\infty$ .

- When there are both near and distant subjects in a scene.
- When there is dirt or dust on glass between the lens and the subject.
- When there are illuminated or glittering objects around the subject.
- When taking a picture in dark places.
- When the subject is moving fast.
- When the scene has low contrast.
- When jitter occurs.
- When recording a very bright subject.
- When taking close-up pictures of a subject.

**Try the AF/AE lock technique or macro mode.**

### ■ Color (P59)

- The color of the subject will differ if the color of the light surrounding it differs, such as when the light comes from sunlight or halogen lighting. However, this unit automatically adjusts the hue to one close to real life. (auto white balance)

**Set the white balance if you want to change the hue you get with auto white balance.**

### ■ When you want to take a subject outside the AF area (AF/AE Lock)

When recording a picture of people with a composition like the following picture, you will not be able to focus the camera on the subject because the people are outside the AF area.

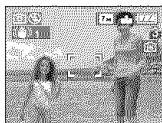

In this case,

- 1 Aim the AF area at the subject.
  - 2 **Press the shutter button halfway** to fix the focus and the exposure.
    - The focus indication lights when the subject is focused.
  - 3 **Press and hold the shutter button halfway** while moving the camera as you compose the picture.
  - 4 Press the shutter button fully.
- You can repeatedly retry AF/AE lock before pressing the shutter button fully.

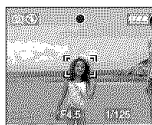

## ■ Direction detection function

Pictures recorded with the camera held vertically are played back vertically (rotated). (Only when [ROTATE DISP.] (P71) is set to [ON])

- Pictures may not be displayed vertically if they were taken with the camera aimed up or down.
- Motion pictures taken with the camera held vertically are not displayed vertically.

## ■ Preventing jitter (camera shake)

- Be careful of jittering when pressing the shutter button.
- If jitter could occur because of a slow shutter speed, the jitter alert  appears.

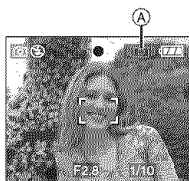

- When the jitter alert appears, we recommend using a tripod. If you cannot use a tripod, be careful how you hold the camera (P22). The use of the self-timer prevents jittering caused by pressing the shutter button when you are using a tripod (P39).
- Shutter speeds will be slower particularly in the following scene modes. Keep this unit still from the moment the shutter button is pressed until the picture appears on the screen. We recommend using a tripod.
  - [NIGHT PORTRAIT] (P46)
  - [NIGHT SCENERY] (P47)
  - [PARTY] (P47)
  - [CANDLE LIGHT] (P48)
  - [STARRY SKY] (P49)
  - [FIREWORKS] (P50)

# Taking Pictures in Simple Mode



This mode allows beginners to take pictures easily. Only the basic functions appear in the menu to make operations simple.

## ■ Basic menu settings

### 1 Press [MENU/SET].

### 2 Press / to select the desired menu item and then press .

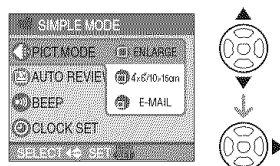

### 3 Press / to select the desired setting and then press [MENU/SET].



### 4 Press [MENU/SET] to close the menu.

- You can also press the shutter button halfway to close the menu.





## ■ Settings in Simple mode



### [PICT.MODE]

 [ENLARGE]	Suitable for enlarging the pictures to be printed to 8"×10" size, letter size etc.
 [4"×6"/10×15cm]	Suitable for regular size printing.
 [E-MAIL]	Suitable for attaching pictures to e-mails or adding pictures to websites.

### [AUTO REVIEW]



 [OFF]	The recorded picture does not automatically appear.
 [ON]	The recorded picture automatically appears on the screen for about 1 second.

### [BEEP]

 [OFF]	No operation sound
 [LOW]	Soft operation sound
 [HIGH]	Loud operation sound

















### [CLOCK SET]

Change date and time. (P15)

- If [ 4"×6"/10×15cm] or [ E-MAIL] is set in [PICT.MODE], the extended optical zoom is activated. (P26)
- The settings for [BEEP] and [CLOCK SET] in simple mode are also applied to other recording modes.
- The settings for [WORLD TIME] (P19), [MONITOR] (P19), [TRAVEL DATE] (P19), [BEEP] (P19), [SHUTTER] (P19), [NO.RESET] (P20) and [LANGUAGE] (P20) in the [SETUP] menu are applied to simple mode.

## ■ Other Settings in Simple mode

In simple mode, other settings are fixed as follows. For more information about each setting, refer to the page indicated.

- Focus range:
  - 30 cm (0.98 feet) to ∞ (Tele)
  - 5 cm (0.16 feet) to ∞ (Wide)
- [POWER SAVE] (P18): [5MIN.]
- [ECONOMY] (P19): [OFF]
- Self-timer (P39): 10 seconds
- Optical Image Stabilizer (P41): [MODE2]
- [W.BALANCE] (P59): [AWB]
- [SENSITIVITY] (P60): This setting becomes the same as when the highest ISO sensitivity is set to [ISO800] in intelligent ISO sensitivity mode []. (P42)
- [ASPECT RATIO]/[PICT.SIZE]/[QUALITY] (P60, 61):
  - [ ENLARGE]:
    -  : [ 7M] (7M) (DMC-FX12)/
    -  (6M) (DMC-FX10)/
  - [ 4"×6"/10×15cm]:
    -  : [ 2.5M] (2.5M EZ)/
  - [ E-MAIL]:
    -  : [ 0.3M] (0.3M EZ)/
- [AF MODE] (P62): [
- [AF ASSIST LAMP] (P63): [ON]

- You cannot use the following functions.
  - High angle mode
  - Exposure compensation
  - [D.ZOOM]
  - [BURST]
  - [COL.MODE]
- You cannot set the following items.
  - [TRAVEL DATE]
  - [WORLD TIME]

### ■ The Backlight Compensation

Backlight refers to when light comes from the back of a subject.

In this case, the subject, such as a person, will become dark so this function compensates the backlight by brightening the whole of the picture.

#### Press ▲.

- When the backlight compensation function is activated, [ ] (compensating backlight ON indication (A)) appears. Press ▲ again to cancel this function.

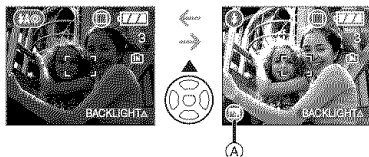

- We recommend using the flash when you use the backlight compensation function. (The flash is fixed to Forced ON [ ] .)
- The flash setting is fixed to AUTO/Red-eye reduction [ ] when the backlight compensation function is set to [OFF].

## Taking Pictures with the Zoom

### Using the Optical Zoom/Using the Extended Optical Zoom (EZ)



You can make people and objects appear closer and landscapes can be recorded in wide angle with the 3× optical zoom. (35 mm film camera equivalent 35 mm to 105 mm)

Set the picture size to something other than the highest setting for each aspect ratio [4:3 / 3:2 / 16:9] to make subjects appear additionally closer with no picture quality deterioration [Maximum of 4.5× (DMC-FX12)/4.1× (DMC-FX10)].

- To make subjects appear closer use (Tele)

Rotate the zoom lever towards Tele.



- To make subjects appear further away use (Wide)



Rotate the zoom lever towards Wide.





## Picture size and maximum zoom magnification

(○: Available, —: Not available)

### \* DMC-FX12

Aspect ratio (P60)	Picture size (P61)	Maximum zoom magnification (Tele)	Extended optical zoom
4:3	7M /  (7M)	3×	—
3:2	6M (6M)		
16:9	5.5M (5.5M)		
4:3	5M (5M EZ)	3.6×	○
4:3	3M (3M EZ)	4.5×	○
	2M (2M EZ)		
	1M (1M EZ)		
	0.3M /  (0.3M EZ)		
3:2	2.5M /  (2.5M EZ)		
16:9	2M (2M EZ)		

### \* DMC-FX10

Aspect ratio (P60)	Picture size (P61)	Maximum zoom magnification (Tele)	Extended optical zoom
4:3	6M /  (6M)	3×	—
3:2	5M (5M)		
16:9	4.5M (4.5M)		
4:3	3M (3M EZ)	4.1×	○
	2M (2M EZ)		
	1M (1M EZ)		
	0.3M /  (0.3M EZ)		
3:2	2.5M /  (2.5M EZ)		
16:9	2M (2M EZ)		

## Extended optical zoom mechanism

When you set the picture size to [**3M**] (3M EZ) (3 million pixels), the 7M (7 million pixels) (DMC-FX12)/ 6M (6 million pixels) (DMC-FX10) CCD area is cropped to the center 3M (3 million pixels) area, allowing a picture with a higher zoom effect.



- The optical zoom is set to Wide (1×) when the camera is turned on.
- If you use the zoom function after focusing on the subject, focus on the subject again.
- The lens barrel (P9) extends or retracts according to the zoom position. Take care not to interrupt the motion of the lens barrel while the zoom lever is rotated.
- In motion picture mode [**Hi**], the zoom magnification is fixed to the value set at the start of recording.
- “EZ” is an abbreviation of “Extended optical Zoom”.
- You can further enhance the zoom magnification with the extended optical zoom without worrying about further picture distortion.
- If you set a picture size that activates the extended optical zoom, the extended optical zoom icon [**EZ**] is displayed on the screen when you use the zoom function.
- The zoom will stop moving for an instant near [W] (1×) when the extended optical zoom is used. This is not a malfunction.
- The indicated zoom magnification is an approximation.
- In motion picture mode [**Hi**] and [HIGH SENS.] in scene mode, the extended optical zoom does not work.

## Using the Digital Zoom

### Further extending the zoom



A maximum of 12× zoom can be achieved with the 3× optical zoom and the 4× digital zoom when [D.ZOOM] is set to [ON] in the [REC] mode menu. However, if a picture size that can use extended optical zoom is selected, a maximum of 18× (DMC-FX12)/16.5× (DMC-FX10) zoom can be achieved with the 4.5× (DMC-FX12)/4.1× (DMC-FX10) extended optical zoom and the 4× digital zoom.

### Menu operation

#### 1 Press [MENU/SET].

- When a scene mode is selected, select the [REC] menu (📷) and then press ▶.

#### 2 Press ▲/▼ to select [D.ZOOM] and then press ▶.

#### 3 Press ▼ to select [ON] and then press [MENU/SET].

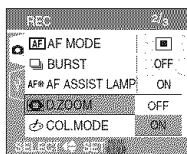

#### 4 Press [MENU/SET] to close the menu.

- You can also press the shutter button halfway to close the menu.

### Entering the digital zoom range

The on-screen zoom indication may momentarily stop moving when you rotate the zoom lever to the extreme Tele position. You can enter the digital zoom range by continuously rotating the zoom lever to Tele or releasing the zoom lever once and then rotating it to Tele again.

e.g. DMC-FX12

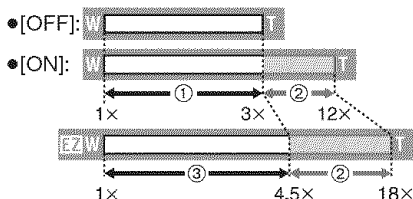

(When using the digital zoom and the extended optical zoom [3M] (3M EZ) at the same time.)

- Optical zoom
- Digital zoom
- Extended optical zoom



- A big AF area (P62) is displayed when using the digital zoom. Also, the stabilizer function may not be effective.
- In digital zoom, the larger the picture the lower the picture quality.
- When using the digital zoom, we recommend using a tripod and the self-timer (P39) for taking pictures.
- The indicated zoom magnification is an approximation.
- The digital zoom does not work in the following cases:
  - In simple mode [♥].
  - In intelligent ISO sensitivity mode [📷].
  - In [SPORTS], [BABY1]/[BABY2], [PET] and [HIGH SENS.] in scene mode.

## Checking the Recorded Picture (Review)



You can check the recorded pictures while still in [REC] mode.

### 1 Press ▼ [REV].



- The last recorded picture appears for about 10 seconds.
- Review is canceled when the shutter button is pressed halfway or the ▼ [REV] is pressed again.

### 2 Press ◀▶ to select the picture.



- ◀: Play back the previous picture
- ▶: Play back the next picture

### ■ Enlarging the picture

#### 1 Rotate the zoom lever towards [Q] (T).

- Rotate the zoom lever to [Q] [T] for a 4× magnification and then rotate it even more for a 8× magnification. When you rotate the zoom lever towards [W] after enlarging the picture, the magnification becomes lower.

#### 2 Press ▲/▼/◀/▶ to move the position.

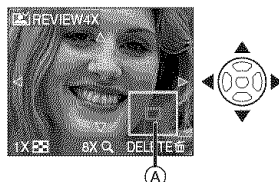

- When you change the magnification or the position to be displayed, the zoom position indication (A) appears for about 1 second.

### ■ Deleting the recorded picture during Review (Quick deletion)

A single picture, multiple pictures or all the pictures can be deleted during review. Refer to P30 to 31 for information about how to delete pictures.



- When [ROTATE DISP.] is set to [ON], pictures recorded holding the camera vertically are played back vertically (rotated).

## Playing back/Deleting Pictures



The picture data on the built-in memory is played back or deleted when a card is not inserted. The picture data on the card is played back or deleted when a card is inserted. (P14)

**Once deleted, pictures cannot be recovered. Check the pictures one by one and delete unwanted pictures.**

### ■ Playing back pictures

Press ◀/▶ to select the picture.



- ◀: Play back the previous picture
- ▶: Play back the next picture

### ■ Fast forwarding/Fast rewinding

Press and hold ◀/▶ during playback.

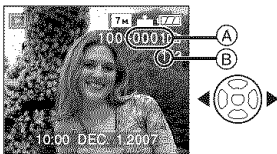

- ◀: Fast rewind
- ▶: Fast forward
- The file number (A) and the picture number (B) only change one by one. Release ◀/▶ when the number of the desired picture appears to play back the picture.
- If you keep pressing ◀/▶, the number of pictures forwarded/rewound increases.

- In review playback in recording mode and in multi playback (P65), the pictures can only be forwarded or rewound one by one.



- This camera is based on the DCF standard "Design rule for Camera File system" which was established by the "JEITA (Japan Electronics and Information Technology Industries Association)".
- The LCD monitor may not be able to display the details of the recorded pictures. You can use the playback zoom (P67) to check the details of the pictures.
- If you play back pictures that have been recorded with other equipment, the picture quality may deteriorate. (The pictures are displayed as [THUMBNAIL IS DISPLAYED] on the screen.)
- If you change a folder name or file name on your PC, the pictures may not play back on the camera.
- If you play back a non-standard file, the folder/file number is indicated by [—] and the screen may turn black.
- Depending on the subject, an interference fringe may appear on the screen. This is called moire. This is not a malfunction.

### ■ To delete a single picture

**1 Press [ ] while the picture is being played back.**

**2 Press ▲ to select [YES] and then press [MENU/SET].**

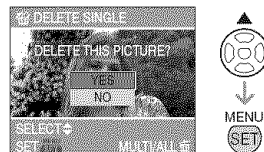

- While the picture is being deleted, [ ] appears on the screen.

## ■ To delete [MULTI DELETE]/ [ALL DELETE]

**1** Press twice.

**2** Press / to select  
[MULTI DELETE] or  
[ALL DELETE] and then press  
[MENU/SET].

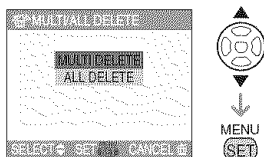

- [MULTI DELETE] → step **3**.
- [ALL DELETE] → step **5**.
- [ALL DELETE EXCEPT ★] (When [FAVORITE] (P70) is set only) → step **5**.  
(However, this cannot be selected if none of the pictures have [★] displayed.)

**3** Press / to select the picture  
and then press to set.

(Only when selecting [MULTI DELETE])

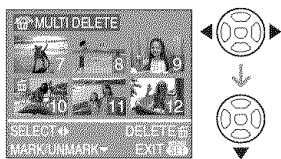

- Repeat the above procedure.
- appears on the selected pictures. If is pressed again, the setting is canceled.
- The icon blinks red if the selected picture is protected and cannot be deleted. Cancel the protect setting and then delete the picture. (P76)

**4** Press .

**5** Press to select [YES] and then  
press [MENU/SET] to set.

(Screen when selecting [MULTI DELETE])



- When you delete pictures, only pictures in either of the built-in memory or the card can be deleted. (You cannot delete pictures in both the built-in memory and the card at the same time.)
- [DELETE ALL PICTURES IN THE INTERNAL MEMORY ?] is displayed when using [ALL DELETE] and [DELETE ALL EXCEPT ★ ?] is displayed when using [ALL DELETE EXCEPT ★].
- If you press [MENU/SET] while deleting pictures using [ALL DELETE] or [ALL DELETE EXCEPT ★], the deleting will stop halfway.



- Do not turn off the camera while deleting.
- When deleting pictures, use a battery with sufficient battery power (P21) or the AC adaptor (DMW-AC5PP; optional).
- It is possible to delete up to 50 pictures at one time using [MULTI DELETE].
- The greater the number of pictures the longer it takes to delete them.
- If there are pictures that are protected [] (P76), do not conform to the DCF standard (P30) or are in a card with the Write-Protect switch slid to the [LOCK] side (P14), they are not deleted even if [ALL DELETE] or [ALL DELETE EXCEPT ★] is selected.

# About the LCD Monitor

## Changing the information displayed

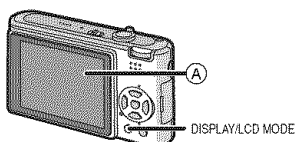

A LCD monitor (LCD)

### Press [DISPLAY] to change.

- When the menu screen appears, the [DISPLAY] button is not activated. During playback zoom (P67), while playing back motion pictures (P68) and during a slide show (P70), you can only select "Normal display (H)" or "No display (J)".

### In simple mode [♥]

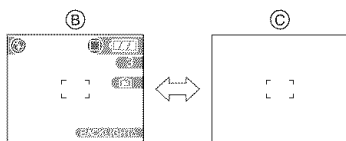

B Normal display

C No display

### In recording mode

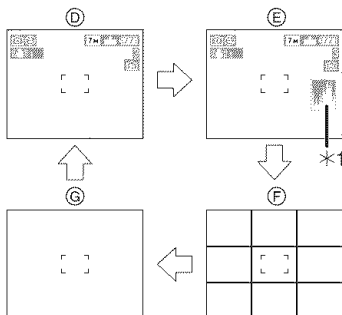

D Normal display (Recording information)

E Display with histogram

H No display (Recording guide line)

G No display

\*1 Histogram

### In playback mode

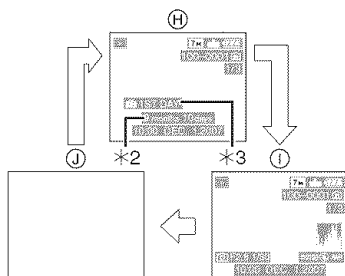

H Normal display

I Display with recording information and histogram

J No display

\*2 Displayed if [BIRTHDAY SET.] and [WITH AGE] were set in [BABY1]/[BABY2] (P48) and [PET] (P49) in scene mode before taking pictures.

\*3 The number of days that have passed since the travel date are displayed if you set [TRAVEL DATE] (P54) before taking pictures.



- In [NIGHT PORTRAIT] (P46), [NIGHT SCENERY] (P47), [STARRY SKY] (P49) and [FIREWORKS] (P50) in scene mode, the guide line is gray.



## ■ Recording guide line

When you align the subject on the horizontal and vertical guide lines or the cross point of these lines, you can take pictures with well-designed composition by viewing the size, the slope and the balance of the subject.

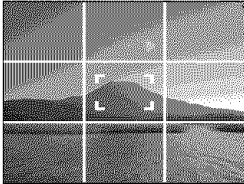

## ■ Histogram

A histogram is a graph that displays brightness along the horizontal axis (black to white) and the number of pixels at each brightness level on the vertical axis. It allows you to easily check a picture's exposure.

- It is very useful if manual adjustments of the lens aperture and shutter speed are available, especially in those situations where automatic exposure may be difficult due to uneven lighting. Using the histogram feature allows you to get the maximum performance from your camera.

- Ⓐ When the values are concentrated on the left, the picture is under exposed.
- Ⓑ When the values are distributed evenly, the exposure is proper and the brightness is well-balanced.
- Ⓒ When the values are concentrated on the right, the picture is over exposed.

## Examples of histogram

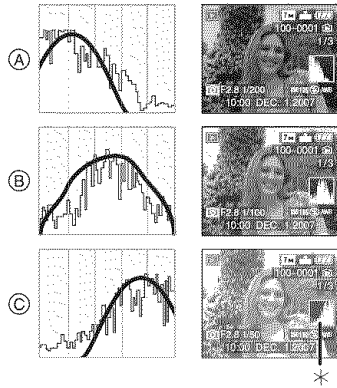

- Ⓐ Under Exposed
- Ⓑ Properly Exposed
- Ⓒ Over Exposed
- \*Histogram



- When you take pictures with the flash or in dark places, the histogram is displayed in orange because the recorded picture and the histogram do not match each other.**
- The histogram is an approximation in recording mode.
- The histogram of a picture may not match in recording mode and playback mode.
- The histogram displayed in this camera does not match histograms displayed by picture editing software used in PCs etc.
- The histogram does not appear in simple mode [♥] or motion picture mode [H] and during multi playback or calendar playback and playback zoom.

## Brightening the LCD Monitor (Power LCD/High angle mode)



- If the mode dial is set [] and [], the Power LCD function only can be used.

**1 Press [LCD MODE] for 1 second.**

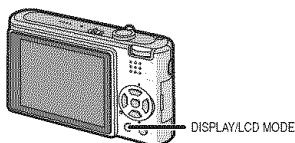

**2 Press  $\blacktriangle$ / $\blacktriangledown$  to select a mode.**

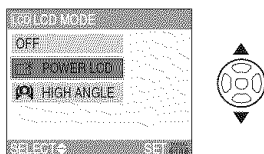

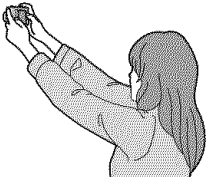
<p>[*]: [POWER LCD]</p>	<p>The LCD monitor becomes brighter and easier to see even when taking pictures outdoors.</p>
<p>[]: [HIGH ANGLE]</p>	<p>The LCD monitor is easier to see when taking pictures with the camera held high above your head. This is useful when you cannot get close to the subject because there is a person in the way. (However it becomes more difficult to see when looked at straight on.)</p> 
<p>[OFF]</p>	<p>The LCD monitor returns to the normal brightness.</p>

**3 Press [MENU/SET].**

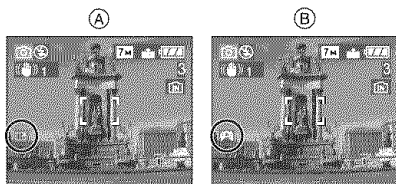

- The [POWER LCD] or [HIGH ANGLE] icon appears.

## ■ Canceling Power LCD or High angle mode

- If you press and hold [LCD MODE] again for 1 second the screen shown in step **2** is displayed. Select [OFF] to cancel Power LCD mode or High angle mode.



- High angle mode is also canceled if you turn the camera off or power save mode is activated.
- The brightness of the pictures displayed on the LCD monitor is adjusted when Power LCD mode or High angle mode is activated. Therefore, some subjects may look different on the LCD monitor. However, this does not affect the recorded pictures.
- The LCD monitor automatically returns to normal brightness after 30 seconds when recording in Power LCD mode. Press any button to make the LCD monitor bright again.
- If the screen is difficult to see because of light from the sun etc. shining on it, use your hand or another object to block the light.
- High angle mode is not activated in the following cases.
  - In simple mode [♥]
  - In playback mode
  - In print mode [📄]
  - While the menu screen is displayed
  - While the review screen is displayed

## Taking Pictures using the Built-in Flash

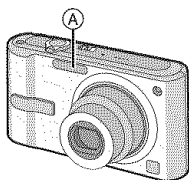

### Ⓐ: Photo flash

Do not cover it with your fingers or other objects.

## ■ Switching to the appropriate flash setting

Set the flash to match the recording.

### 1 Press ► [⚡].

### 2 Press ▲/▼ to select a mode.

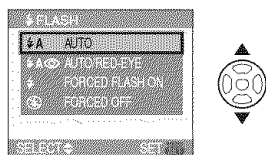

- You can also press ► [⚡] to select.
- For information about flash settings that can be selected, refer to “Available flash settings by recording mode”. (P36)

### 3 Press [MENU/SET].

- You can also press the shutter button halfway to finish.
- The menu screen disappears after about 5 seconds. At this time, the selected item is automatically set.

### ⚡A : AUTO

The flash is automatically activated when the recording conditions make it necessary.



- The flash setting is memorized even if the camera is turned off. However, the scene mode flash setting is reset to the initial setting when the scene mode is changed.

#### ■ Available flash range by ISO sensitivity

ISO sensitivity (P60)	Available flash range
[AUTO]	<b>Wide</b> 30 cm (0.98 feet) to 5 m (16.4 feet)
	<b>Tele</b> 30 cm (0.98 feet) to 2.8 m (9.19 feet)
[ISO100]	<b>Wide</b> 30 cm (0.98 feet) to 2 m (6.56 feet)
	<b>Tele</b> 30 cm (0.98 feet) to 1.1 m (3.61 feet)
[ISO200]	<b>Wide</b> 40 cm (1.31 feet) to 2.8 m (9.19 feet)
	<b>Tele</b> 30 cm (0.98 feet) to 1.5 m (4.92 feet)
[ISO400]	<b>Wide</b> 60 cm (1.97 feet) to 4 m (13.1 feet)
	<b>Tele</b> 40 cm (1.31 feet) to 2.2 m (7.22 feet)
[ISO800]	<b>Wide</b> 80 cm (2.62 feet) to 5.6 m (18.4 feet)
	<b>Tele</b> 60 cm (1.97 feet) to 3.1 m (10.2 feet)

[ISO1250]	<b>Wide</b> 1 m (3.28 feet) to 5.6 m (18.4 feet)
	<b>Tele</b> 80 cm (2.62 feet) to 3.1 m (10.2 feet)

- The available flash range is an approximation.
- The available focus range differs depending on the recording mode. (P102)
- If you use the flash when the ISO sensitivity is set to [AUTO] or when the highest ISO sensitivity is set to a setting other than [ISO400] in intelligent ISO sensitivity mode [  ] (P42), the ISO sensitivity is automatically increased to a maximum of [ISO640]. (It is a maximum of [ISO400] in [BABY1]/[BABY2] (P48) and [PET] (P49) in scene mode.)
- If you take a picture with the flash at close range when the zoom is near [W] (1×), the edges of the recorded picture may become dark. Rotate the zoom lever slightly and then take the picture.

#### ■ Available flash range in Intelligent ISO sensitivity mode

Highest ISO sensitivity (P42)	Available flash range	
	Wide	Tele
ISO400	Approx. 30 cm (0.98 feet) to approx. 4.0 m (13.1 feet)	Approx. 30 cm (0.98 feet) to approx. 2.2 m (7.22 feet)
ISO800	Approx. 30 cm (0.98 feet) to approx. 5.0 m (16.4 feet)	Approx. 30 cm (0.98 feet) to approx. 2.8 m (9.19 feet)
ISO1250		

## ■ Shutter speed for each flash setting

Flash setting	Shutter speed (Sec.)
<b>A</b> : AUTO	1/30 to 1/2000
<b>A</b> : AUTO/ Red-eye reduction	
: Forced ON : Forced ON/ Red-eye reduction	
<b>S</b> : Slow sync./ Red-eye reduction	1/4 or 1 to 1/2000*1 1/4 to 1/2000*2
<b>OFF</b> : Forced OFF	1/4 to 1/2000 1/8 or 1 to 1/2000*3 1/4 or 1 to 1/2000*4

\*1 [NIGHT PORTRAIT] (P46) and [CANDLE LIGHT] (P48) in scene mode

\*2 [PARTY] (P47)

\*3 Simple mode []

\*4 Intelligent ISO sensitivity mode [] (P42), [SPORTS] (P46), [NIGHT PORTRAIT] (P46), [CANDLE LIGHT] (P48), [BABY1]/[BABY2] (P48) and [PET] (P49) in scene mode

• \*1, \*3, \*4: The shutter speed becomes a maximum of 1 second in the following cases.

– When the optical image stabilizer is set to [OFF].

– When the camera has determined that there is little jitter in simple mode [] and when the optical image stabilizer is set to [MODE1] or [MODE2].

• There will be differences in the above shutter speeds in the following scene modes.

– [NIGHT SCENERY] (P47): 8 seconds to 1/2000th of a second

– [STARRY SKY] (P49): 15 seconds, 30 seconds, 60 seconds

– [FIREWORKS] (P50): 1/4th of a second, 2 seconds



- Do not look directly at the flash at close range when it is activated.
- If you bring the flash too close to an object, the object may be distorted or discolored by the heat or lighting from the flash.
- Do not cover the photo flash with your fingers or other objects.
- In economy mode, the LCD monitor turns off and the status indicator lights while the flash is charging. [This does not happen when using the AC adaptor (DMW-AC5PP; optional).] If the remaining battery power is low, the length of time that the LCD monitor turns off to charge may become longer.
- If you press the shutter button halfway when the flash is activated, the flash icon turns red.
- When you take a picture beyond the available flash range, the exposure may not be adjusted properly and the picture may become bright or dark.
- When the flash is being charged, the flash icon blinks red, and you cannot take a picture even when you press the shutter button fully.
- The white balance may not be properly adjusted if the flash level is insufficient for the subject. (P59)
- When the shutter speed is fast, the flash effect may not be sufficient.
- It may take time to charge the flash if you repeat taking a picture. Take a picture after the access indication disappears.
- The red-eye reduction effect differs between people. Also, if the subject was far away from the camera or was not looking at the first flash, the effect may not be evident.
- When the flash is activated, you can only take 1 picture.

# Taking Pictures with the Self-timer



**1** Press ◀ [⏻].

**2** Press ▲/▼ to select a mode.

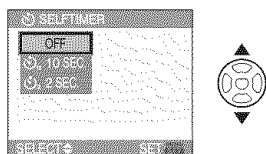

- You can also press ◀ [⏻] to select.

**3** Press [MENU/SET].

- You can also press the shutter button halfway to finish.
- The menu screen disappears after about 5 seconds. At this time, the selected item is automatically set.

**4** Press the shutter button halfway to focus and then press it fully to take the picture.

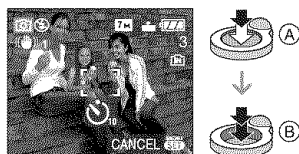

- (A): Press the shutter button halfway to focus.
- (B): Press the shutter button fully to take the picture.
- The self-timer indicator (C) blinks and the shutter is activated after 10 seconds (or 2 seconds).

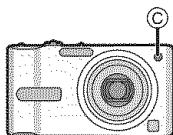

- If you press [MENU/SET] while the self-timer is set, the self-timer setting is canceled.



- When using a tripod etc., setting the self-timer to 2 seconds is a convenient way to avoid the jitter caused by pressing the shutter button.
- When you press the shutter button once fully, the subject is automatically focused just before recording. In dark places, the self-timer indicator will blink and then may turn on brightly operating as an AF assist lamp (P63) to allow the camera to focus on the subject.
- The self-timer is fixed to 10 seconds in simple mode [♥] and 2 seconds in [SELF PORTRAIT] (P46) in scene mode.
- When you set the self-timer in burst mode, the camera starts taking a picture 2 or 10 seconds after the shutter button is pressed. The number of pictures taken at one time is fixed to 3.
- We recommend using a tripod when recording with the self-timer.
- The self-timer cannot be used in [UNDERWATER] in scene mode.

# Compensating the Exposure



Use this function when you cannot achieve appropriate exposure due to the difference in brightness between the subject and the background. Look at the following examples.

## Under exposed



Compensate the exposure towards positive.



## Properly exposed



## Over exposed



Compensate the exposure towards negative.

**1** Press **▲** [] until [EXPOSURE] appears, compensate the exposure with **◀/▶**.

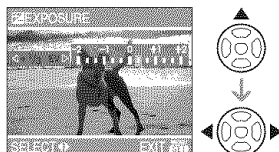

- You can compensate from [-2 EV] to [+2 EV] in steps of [1/3 EV].
- Select [0 EV] to return to the original exposure.

**2** Press [MENU/SET] to finish.

- You can also press the shutter button halfway to finish.



- EV is an abbreviation of [Exposure Value]. It refers to the amount of light given to the CCD by the aperture value and the shutter speed.
- The exposure compensation value appears on the lower left of the screen.
- The set exposure value is memorized even if the camera is turned off.
- The compensation range of the exposure will be limited depending on the brightness of the subject.
- Exposure cannot be compensated when using [STARRY SKY] in scene mode.



# Optical Image Stabilizer



This mode detects jitter and compensates for it.

**1** Press and hold the optical image stabilizer button **(A)** until **[STABILIZER]** appears.

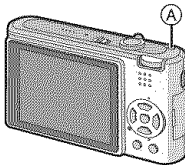

**2** Press **▲/▼** to select the stabilizer function mode and then press **[MENU/SET]**.

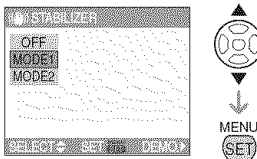

<b>[MODE1]</b> 	The stabilizer operates continuously and can assist during photo composition.
<b>[MODE2]</b> 	The jitter is compensated for when the shutter button is pressed. There is a greater stabilizing effect.
<b>[OFF]</b> 	When the stabilizer is not desired.

## ■ About the jitter/movement detection demonstration screen

Press **▶** on the screen shown in step **2** to display the jitter/movement detection demonstration screen. (You cannot take

pictures while the demonstration screen is displayed.)

Press **▶** to exit the demonstration screen.

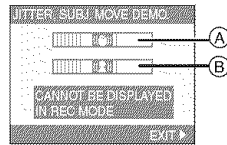

**(A)**: Jitter detection demonstration

**(B)**: Movement detection demonstration

- The jitter/movement detection demonstration screen is an approximation.
- The camera also detects the movement of the subject when automatically setting the ISO sensitivity in intelligent ISO sensitivity mode **[ ]** (P42) and **[SPORTS]** (P46), **[BABY1]/[BABY2]** (P48) and **[PET]** (P49) in simple mode only.



• The stabilizer function may not be effective in the following cases.

- When there is a lot of jitter.
- When the zoom magnification is high.
- In digital zoom range.
- When taking pictures while following a moving subject.
- When the shutter speed becomes slower to take pictures indoors or in dark places.

Be careful of camera jitter when you press the shutter button.

- The setting is fixed to **[MODE2]** in simple mode **[ ]** and **[SELF PORTRAIT]** (P46) in scene mode and fixed to **[OFF]** in **[STARRY SKY]** (P49) in scene mode.
- In motion picture mode **[ ]**, **[MODE2]** cannot be set.

## Changing the sensitivity according to the movement of the subject being recorded



The camera detects the movement of the subject near the center of the screen and then sets the optimal ISO sensitivity and shutter speed according to the movement and the brightness of the subject.

**1 Press [MENU/SET].**

**2 Press ▲/▼ to select [ISO LIMIT] and then press ►.**

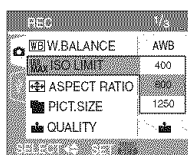

**3 Press ▲/▼ to select the item and then press [MENU/SET].**

Item	Settings
400	The ISO sensitivity automatically increases up to the set value according to the movement and brightness of the subject.
800	
1250	

- The higher the value set for the ISO sensitivity, the more effectively the jitter will be reduced. However, picture noise will increase.

- Jitter is avoided when taking pictures indoors of a moving subject by increasing the ISO sensitivity and making the shutter speed faster.

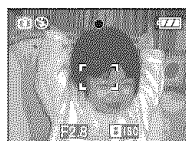

1/125 ISO800

- Noise is avoided when taking pictures indoors of a subject with no movement by decreasing the ISO sensitivity.

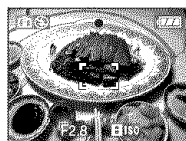

1/30 ISO200

- When you press the shutter button halfway, [ISO] (A) appears. When you press the shutter button fully, the shutter speed and the ISO sensitivity appear for a while.





- The focus range becomes the same as macro mode. [5 cm (0.16 feet) (Wide)/ 30 cm (0.98 feet) (Tele) to ∞]
- When the flash is activated, the ISO sensitivity is automatically increased to a maximum of [ISO640]. (When the highest ISO sensitivity is set to a setting other than [ISO400].)
- Refer to P37 for information about the available flash range .
- Digital zoom cannot be used.
- Depending on the brightness and how fast the subject is moving, jitter may not be avoided.
- The camera may not be able to detect the movement of the subject in the following cases.
  - When the moving subject is small
  - When the moving subject is at the edge of the screen
  - When the subject starts moving the instant the shutter button is pressed fully
- To avoid picture noise, we recommend decreasing [ISO LIMIT] or setting [COL.MODE] to [NATURAL]. (P64)

## Taking Close-up Pictures



This mode allows you to take close-up pictures of a subject, e.g. when taking pictures of flowers. You can take pictures of a subject as close as 5 cm (0.16 feet) from the lens by rotating the zoom lever upmost to Wide (1×).

### ■ Focus range

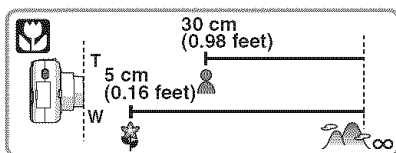

- We recommend using a tripod and the self-timer (P39) in macro mode.
- When a subject is close to the camera, the effective focus range (depth of field) is significantly narrowed. Therefore, if the distance between the camera and the subject is changed after focusing on the subject, it may become difficult to focus on it again.
- If the distance between the camera and the subject is beyond the focus range of the camera, the picture may not be properly focused even if the focus indication lights.
- Macro mode gives priority to a subject close to the camera. Therefore, if the distance between the camera and the subject is more than 50 cm (1.64 feet) it takes longer to focus on it in macro mode than normal picture mode [ ].

- The available flash range is about 30 cm (0.98 feet) to 5.0 m (16.4 feet) (Wide). (When the ISO sensitivity is set to [AUTO].)
- We recommend setting the flash to Forced OFF (🚫) when you take pictures at close range.
- When you take pictures at close range, the resolution of the periphery of the picture may decrease slightly. This is not a malfunction.





## Taking pictures that match the scene being recorded (Scene mode)





When you select a scene mode to match the subject and recording situation, the camera sets the optimal exposure and hue to obtain the desired picture.

- Refer to P45 to 51 and “About the information ” for details about each scene mode.

**1 Press  for the [SCENE MODE] menu.**

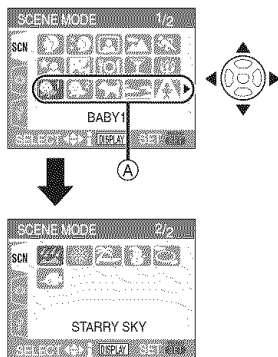
**2 Press /// to select the scene mode.**



- Press  at (A) to switch to the next menu screen.
- You can switch menu screens from any menu item by rotating the zoom lever.

**3 Press [MENU/SET] to set.**

- The menu screen is switched to the recording screen in the selected scene mode.

- Press [MENU/SET] and then perform steps **1**, **2** and **3** to change the scene mode.

### ■ About the information

- If you press [DISPLAY] when selecting a scene mode in step **2**, explanations about each scene mode are displayed. (If you press [DISPLAY] again, the screen returns to the [SCENE MODE] menu.)

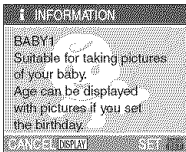

- Refer to P38 for information about the shutter speed.
- The flash setting is memorized even if the camera is turned off. However, the scene mode flash setting is reset to the initial setting when the scene mode is changed. (P36)
- If you change the scene mode, the flash setting and the white balance setting return to the settings at the time of purchase.
- When you take a picture with a scene mode that is not adequate for the purpose, the hue of the picture may differ from the actual scene.
- If you press  when selecting [PORTRAIT] or [STARRY SKY] in step **2**, the [SCENE MODE] menu [SCN] is displayed. If you then select either the [REC] menu [ ] or the [SETUP] menu [Y], you can set the desired items. (P17)
- The following items cannot be set in scene mode because the camera automatically adjusts them to the optimal setting.
  - [SENSITIVITY]
  - [COL.MODE]

### [PORTRAIT]

Press [  ] to display the [SCENE MODE] menu and select a scene mode. (P44)  
The person stands out from the background and has a healthier complexion.

#### ■ Technique for Portrait mode

To increase the effectiveness of this mode:

- 1 Rotate the zoom lever as far as possible to Tele.
- 2 Move close to the subject to make this mode more effective.



- This mode is only suitable when taking pictures outdoors in the daytime.
- ISO sensitivity is fixed to [ISO100].

### [SOFT SKIN]

Press [  ] to display the [SCENE MODE] menu and select a scene mode. (P44)  
This allows you to achieve a smoother appearance of the skin than in [PORTRAIT].

#### ■ Technique for Soft skin mode

To make this mode more effective:

- 1 Rotate the zoom lever as far as possible to Tele.
- 2 Move close to the subject to make this mode more effective.



- This mode is only suitable when taking pictures outdoors in the daytime.
- If a part of the background etc. is a color close to skin color, this part is also smoothed.
- This mode may not be effective when there is insufficient brightness.
- ISO sensitivity is fixed to [ISO100].

 [SELF PORTRAIT]

Press [MENU] to display the [SCENE MODE] menu and select a scene mode. (P44)  
Select this to take pictures of yourself.

**■ Technique for Self portrait mode**

Press the shutter button halfway to focus. The self-timer indicator lights up when you are brought into focus. Making sure you hold the camera still, press the shutter button fully to take the picture.



- The subject is not focused when the self-timer indicator is blinking. Make sure to press the shutter button halfway again to focus.
- The recorded picture automatically appears on the LCD monitor for reviewing. Refer to P29 for information about using the review function.
- If the picture is blurry due to the slow shutter speed, we recommend using the 2 seconds self-timer. (P39)



- The focus range is about 30 cm (0.98 feet) to 70 cm (2.30 feet).
- When you select [SELF PORTRAIT], the zoom magnification is automatically moved to Wide (1×).
- The self-timer can only be set to off or 2 seconds (P39). If it is set to 2 seconds, this setting will remain until the camera is turned off or the mode dial is rotated.
- The stabilizer function mode is fixed to [MODE2]. (P41)
- The AF mode is fixed to [AF-ON]. (P62)
- The setting on the AF assist lamp is disabled.

 [SCENERY]

Press [MENU] to display the [SCENE MODE] menu and select a scene mode. (P44)  
This allows you to take pictures of a wide landscape.



- The focus range is 5 m (16.4 feet) to ∞.
- The flash setting is fixed to Forced OFF [OFF].
- The setting on the AF assist lamp is disabled.
- The white balance cannot be set.

 [SPORTS]

Press [MENU] to display the [SCENE MODE] menu and select a scene mode. (P44)  
Set to this mode when you want to take pictures of sports scenes or other fast-moving events.



- This mode is suitable for taking pictures of subjects at distances of 5 m (16.4 feet) or more.
- If you take pictures of a fast-moving subject indoors, the ISO sensitivity becomes the same as when intelligent ISO sensitivity mode [ISO] is set to a highest ISO sensitivity of [ISO800]. (P42)
- Digital zoom cannot be used.

 [NIGHT PORTRAIT]

Press [MENU] to display the [SCENE MODE] menu and select a scene mode. (P44)  
This allows you to take pictures of a person and the background with near real-life brightness.

**■ Technique for Night portrait mode**

- **Use the flash.**
- Since the shutter speed becomes slower, we recommend using a tripod and the self-timer (P39) for taking pictures.

- Keep the subject still for about 1 second after taking the picture.
- We recommend rotating the zoom lever to Wide (1×) and being about 1.5 m (4.92 feet) from the subject when taking a picture.



- The focus range is 1.2 m (3.94 feet) to 5 m (16.4 feet). (Refer to P37 for the available flash range to take pictures.)
- The shutter may remain closed (max. about 1 sec.) after taking the picture because of signal processing. This is not a malfunction.
- Noise may become visible when you take pictures in dark places.
- When using the flash, Slow sync./Red-eye reduction [- The white balance cannot be set.

### [NIGHT SCENERY]

Press [] to display the [SCENE MODE] menu and select a scene mode. (P44)  
This allows you to take vivid pictures of the nightscape.

#### ■ Technique for Night scenery mode

- Since the shutter speed becomes slower (up to about 8 sec.) use a tripod. We also recommend using the self-timer (P39) for taking pictures.



- The focus range is 5 m (16.4 feet) to ∞.
- The shutter may remain closed (max. about 8 sec.) after taking the picture because of signal processing. This is not a malfunction.
- Noise may become visible when you take pictures in dark places.
- The flash setting is fixed to Forced OFF [].
- ISO sensitivity is fixed to [ISO100].
- The setting on the AF assist lamp is disabled.
- The white balance cannot be set.

### [FOOD]

Press [] to display the [SCENE MODE] menu and select a scene mode. (P44)  
This mode allows you to take pictures of food with a natural hue without being affected by the ambient light in restaurants etc.



- The focus range becomes the same as macro mode. [5 cm (0.16 feet) (Wide)/ 30 cm (0.98 feet) (Tele) to ∞]
- The white balance cannot be set.



### [PARTY]

Press [] to display the [SCENE MODE] menu and select a scene mode. (P44)  
Select this when you want to take pictures at a wedding reception, an indoor party etc. This allows you to take pictures of people and the background with near real-life brightness.

#### ■ Technique for Party mode

- **Use the flash.**
- Since the shutter speed becomes slower, we recommend using a tripod and the self-timer (P39) for taking pictures.
- We recommend rotating the zoom lever to Wide (1×) and being about 1.5 m (4.92 feet) from the subject when taking pictures.



- The flash setting can be set to Slow sync./Red-eye reduction [] or Forced ON/Red-eye reduction [].
- The white balance cannot be set.

## [CANDLE LIGHT]





Press [  ] to display the [SCENE MODE] menu and select a scene mode. (P44)

This mode allows you to take pictures with a candle-lit atmosphere.

### ■ Technique for Candle light mode

- If you make the most of the candle light, you can take successful pictures without using the flash.
- Since the shutter speed becomes slower, we recommend using a tripod and the self-timer (P39) for taking pictures.



- The focus range becomes the same as macro mode. [5 cm (0.16 feet) (Wide)/ 30 cm (0.98 feet) (Tele) to ∞]
- The flash setting can be set to Slow sync./ Red-eye reduction [  S  ] or Forced ON/ Red-eye reduction [   ].
- The white balance cannot be set.

## [BABY1/

## [BABY2]

Press [  ] to display the [SCENE MODE] menu and select a scene mode. (P44)

This takes pictures of a baby with a healthy complexion. When you use the flash, the light from it is weaker than usual.

You can set two different birthdays by using [BABY1] and [BABY2]. You can display the set age when playing back the pictures and stamp the age on the recorded pictures with [DATE STAMP] (P72).





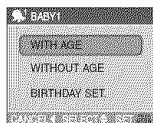

- The age can also be printed on each picture by using the software [LUMIX Simple Viewer] or [PHOTOfunSTUDIO-viewer-] in the CD-ROM (supplied). (For information about printing, refer to the separate operating instructions for PC connection.)

### ■ Age display setting

- To have the age displayed, first set the birthday and then be sure to set [WITH AGE] before taking the pictures.



### ■ Birthday setting

- 1 Press  /  to select [BIRTHDAY SET.] and then press [MENU/SET].
- 2 When a message appears, press  /  to select items (Year/Month/Day) and then press  /  to set them.
- 3 Press [MENU/SET] to finish the setting.



- The focus range becomes the same as macro mode. [5 cm (0.16 feet) (Wide)/ 30 cm (0.98 feet) (Tele) to ∞]
- The ISO sensitivity becomes the same as when intelligent ISO sensitivity mode [  ] is set to a highest ISO sensitivity of [ISO400]. (P42)
- If you turn on the camera in [BABY1/ [BABY2], the age and current date and time are displayed for about 5 seconds on the bottom of the screen.
- The age display style differs depending on the language setting in the recording mode.
- If the age is not properly displayed, check the clock and birthday settings.
- If the camera is set to [WITHOUT AGE], the age is not recorded even if the time and birthday are set. This means the age cannot be displayed even if camera is set to [WITH AGE] after taking the pictures.
- The birthday setting can be reset with [RESET]. (P20)
- Digital zoom cannot be used.



 [PET]

Press [MENU] to display the [SCENE MODE] menu and select a scene mode. (P44)  
Select this when you want to take pictures of a pet such as a dog or a cat.

This allows you to set the birthday of your pet.

You can display the set age when playing back the pictures and stamp the age on the recorded pictures with [DATE STAMP] (P72).

- The age can also be printed on each picture by using the software [LUMIX Simple Viewer] or [PHOTOfunSTUDIO-viewer-] in the CD-ROM (supplied). (For information about printing, refer to the separate operating instructions for PC connection.)
- Refer to [BABY1]/[BABY2] (P48) for information about age display setting and birthday setting.



- The initial setting for the AF assist lamp is [OFF]. (P63)
- Refer to [BABY1]/[BABY2] for other information about this mode.



## [SUNSET]

Press [MENU] to display the [SCENE MODE] menu and select a scene mode. (P44)  
Select this when you want to take pictures of sunset view. This allows you to take vivid pictures of the red color of the sun.



- The flash setting is fixed to Forced OFF [OFF].
- The setting on the AF assist lamp is disabled.
- ISO sensitivity is fixed to [ISO100].
- The white balance cannot be set.

 [HIGH SENS.]

Press [MENU] to display the [SCENE MODE] menu and select a scene mode. (P44)  
Select this mode for high-sensitivity processing. You can take pictures at ISO 3200 sensitivity.



- The resolution of the recorded picture decreases slightly because of high sensitivity processing. This is not a malfunction.
- The focus range becomes the same as macro mode. [5 cm (0.16 feet) (Wide)/ 30 cm (0.98 feet) (Tele) to ∞]
- The flash setting is fixed to Forced OFF [OFF].
- The extended optical zoom and digital zoom cannot be used.

 [STARRY SKY]

Press [MENU] to display the [SCENE MODE] menu and select a scene mode. (P44)  
This allows you to take vivid pictures of a starry sky or a dark subject.

## ■ Setting the shutter speed

- Select a shutter speed of [15 SEC.], [30 SEC.] or [60 SEC.].
- 1 Press ▲/▼ to select the number of seconds and then press [MENU/SET].

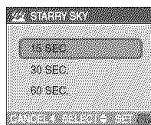

- IF you want to change the number of seconds, press [MENU/SET] and then press ► again to select [STARRY SKY].

## 2 Take pictures.

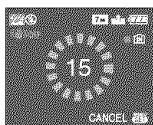

- Press the shutter button fully to display the countdown screen. Do not move the camera after this screen is displayed. When countdown finishes, [PLEASE WAIT...] is displayed for the same length of time as the set shutter speed for signal processing.
- Press [MENU/SET] to stop taking the picture while the countdown screen is displayed.

### ■ Technique for Starry sky mode

- The shutter opens for 15, 30 or 60 seconds. Be sure to use a tripod. We also recommend taking pictures with the self-timer. (P39)



- The LCD monitor automatically becomes darker.
- Histograms are always displayed in orange. (P33)
- The flash setting is fixed to Forced OFF [☺].
- ISO sensitivity is fixed to [ISO100].
- The following functions cannot be used.
  - [EXPOSURE]
  - [W.BALANCE]
  - [BURST]
  - [STABILIZER]



### [FIREWORKS]

Press [MENU] to display the [SCENE MODE] menu and select a scene mode. (P44)  
This mode allows you to take beautiful pictures of fireworks exploding in the night sky.

### ■ Technique for Fireworks mode

- Since the shutter speed becomes slower, we recommend using a tripod.



- This mode is most effective when the subject is 10 m (32.8 feet) or more away.
- The shutter speed becomes the following.
  - When the optical image stabilizer is set to [OFF]: Maximum 2 second
  - When the optical image stabilizer is set to [MODE1] or [MODE2]: Maximum 1/4th of a second or 2 second (The shutter speed becomes a maximum of 2 second only when the camera has determined that there is little jitter such as when using a tripod etc.)
- Histograms are always displayed in orange. (P33)
- The flash setting is fixed to Forced OFF [☺].
- You cannot set the AF mode.
- The AF area is not displayed.
- The setting on the AF assist lamp is disabled.
- ISO sensitivity is fixed to [ISO100].
- The white balance cannot be set.



### [BEACH]

Press [MENU] to display the [SCENE MODE] menu and select a scene mode. (P44)  
This allows you to take even more vivid pictures of the blue color of the sea, sky etc. It also prevents under exposure of people under strong sunlight.



- Do not touch the camera with wet hands.
- Sand or seawater will cause the camera to malfunction. Make sure that sand or seawater does not get into the lens or the terminals.
- Problems caused by sand or seawater are not covered by the product warranty.
- The white balance cannot be set.

## [SNOW]

Press [MENU] to display the [SCENE MODE] menu and select a scene mode. (P44)  
This allows you to take pictures that show the snow as white as possible at a ski resort or a snow-covered mountain.



- The white balance cannot be set.

## [AERIAL PHOTO]

Press [MENU] to display the [SCENE MODE] menu and select a scene mode. (P44)  
This mode allows you to take pictures through an airplane window.

### ■ Technique for Aerial photo mode

- We recommend using this technique if it is difficult to focus when taking pictures of clouds etc. Aim the camera at something with high contrast, press the shutter button halfway to fix the focus and then aim the camera at the subject and press the shutter button fully to take the picture.



- Turn the camera off when taking off or landing.
- When using the camera, follow all instructions from the cabin crew.
- Be careful about the reflection from the window.
- The flash setting is fixed to Forced OFF [OFF].
- The setting on the AF assist lamp is disabled.
- The white balance cannot be set.

## [UNDERWATER]

Press [MENU] to display the [SCENE MODE] menu and select a scene mode. (P44)  
Use the marine case (DMW-MCFX07; optional) (P105). This allows you to take pictures with a natural color.

## ■ Adjusting the white balance [WB ADJUST.]

You can adjust the hue to match the water depth and the weather.

- 1 Press [ZOOM+] twice to display [WB±] [WB ADJUST.].
- 2 Press [LEFT] to adjust the white balance.



- [LEFT] [RED]: Press when the hue is bluish.
- [RIGHT] [BLUE]: Press when the hue is reddish.
- If you adjust the white balance, [AWB] appears on the screen in red or blue.

## ■ Fixing the focus underwater (AF Lock)

You can fix the focus before taking a picture with AF lock. This is useful if you want to take pictures of a fast moving subject etc.

- 1 Aim the AF area at the subject.
- 2 Press [LEFT] to fix the focus.
  - The AF lock icon (A) appears when the subject is focused.

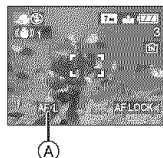

- Press [LEFT] again to cancel AF lock.
- When you rotate the zoom lever, the AF lock is canceled. In this case, focus on the subject and fix the focus again.



- The focus range becomes the same as macro mode. [5 cm (0.16 feet) (Wide)/ 30 cm (0.98 feet) (Tele) to ∞]
- The button indications on the marine case (DMW-MCFX07; optional) are slightly different from the button indications on this unit. Follow the button indications on this unit for use.
- The self-timer cannot be set.
- The white balance cannot be set.

# Motion Picture Mode



**1 Press the shutter button halfway to focus and then press it fully to start recording.**

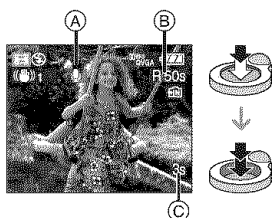

(A): Audio recording

- The available recording time (B) is displayed on the top right and the elapsed recording time (C) is displayed on the bottom right of the screen.
- When the subject is focused, the focus indication lights.
- The focus, zoom and aperture value are fixed to the setting when recording starts (the first frame).
- The available recording time and the elapsed recording time are approximations.
- The audio is also recorded simultaneously from the built-in microphone on this unit. (Motion pictures cannot be recorded without audio.)
- When using the stabilizer function, it is fixed to [MODE1].

**2 Press the shutter button fully to stop recording.**

- If the built-in memory or the card becomes full in the middle of recording, the camera stops recording automatically.

■ Changing the settings for the aspect ratio and the picture quality

**1 Press [MENU/SET].**

**2 Press ▲/▼ to select [ASPECT RATIO] and then press ►.**

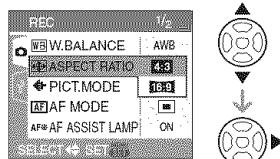

**3 Press ▲/▼ to select the item and then press [MENU/SET].**

**4 Press ▲/▼ to select [PICT.MODE] and then press ►.**

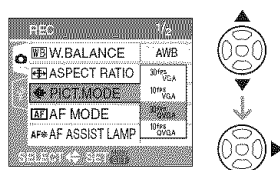

**5 Press ▲/▼ to select the item and then press [MENU/SET].**

If you selected [4:3] on the screen shown in step 2

Item	Picture size	fps
[30fpsVGA]	640×480 pixels	30
[10fpsVGA]		10
[30fpsQVGA]	320×240 pixels	30
[10fpsQVGA]		10

If you selected [16:9] on the screen shown in step 2

Item	Picture size	fps
[30fps16:9]	848×480 pixels	30
[10fps16:9]		10

- fps “frames per second”; This refers to the number of frames used in 1 second.

- You can record smoother motion pictures with “30 fps”.
- You can record longer motion pictures with “10 fps” although the picture quality is lower.
- The file size with [10fpsQVGA] is small so it is suitable for e-mails.
- **You can only record motion pictures to the built-in memory when the [ASPECT RATIO] is [4:3] and the picture size is [30fpsQVGA] or [10fpsQVGA] (320×240 pixels).**

## 6 Press [MENU/SET] to close the menu.

- **You can also press the shutter button halfway to close the menu.**



- The focus range becomes the same as macro mode. [5 cm (0.16 feet) (Wide)/ 30 cm (0.98 feet) (Tele) to ∞]
- Refer to P101 for information about the available recording time.
- The available recording time displayed on the screen may not decrease regularly.
- This unit does not support recording motion pictures on MultiMediaCards.
- When you set the picture quality to [30fpsVGA] or [30fps16:9], we recommend using a High Speed SD Memory Card with “10MB/s” or greater displayed on the package.
- Depending on the type of the card, recording may stop in the middle.
- **We recommend using Panasonic’s SD Memory Card/SDHC Memory Card.**
- Depending on the type of the card, the card access indication may appear for a while after recording motion pictures. This is not a malfunction.
- Motion pictures can be recorded continuously up to 2 GB.  
The maximum available recording time for up to 2 GB only is displayed on the screen.

- When motion pictures recorded with the camera are played back on other equipment, the quality of the picture and sound may deteriorate and it may not be possible to play them back. Also the recording information may not be displayed correctly.
- You cannot use the following functions in motion picture mode [].
  - Direction detection function
  - Review
  - [MODE2] in [STABILIZER]
- The bundled software includes QuickTime to play back motion picture files recorded with the camera on the PC.

# Recording which Day of the Vacation You Take the Picture



If you set the departure date of the vacation in advance, the number of days that have passed since the departure date (which day of the vacation it is) is recorded when you take the picture. You can display the the number of days that have passed when playing back the pictures and stamp it on the recorded pictures with [DATE STAMP] (P72).

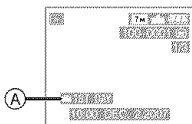

- Ⓐ: The number of days that have passed since the departure date
- The number of days that have passed since the departure date can be printed on each picture by using the software [LUMIX Simple Viewer] or [PHOTOfunSTUDIO-viewer-] in the CD-ROM (supplied). (For information about printing, refer to the separate operating instructions for PC connection.)

■ **Setting the departure/return date** (e.g.: The following are examples of the screen in normal picture mode [O].)

- 1 Press [MENU/SET] and then press **◀**.
- 2 Press **▼** to select the [SETUP] menu icon [?] and then press **▶**.
- 3 Press **▲/▼** to select [TRAVEL DATE] and then press **▶**.
- 4 Press **▼** to select [SET] and then press [MENU/SET].

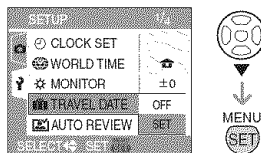

- 5 Press **▲/▼/◀/▶** to set the departure date and then press [MENU/SET].

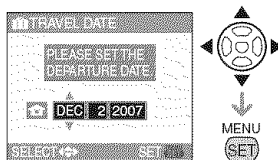

- ◀/▶: Select the desired item.  
▲/▼: Set the year, month and date.

- 6 Press **▲/▼/◀/▶** to set the return date and then press [MENU/SET].

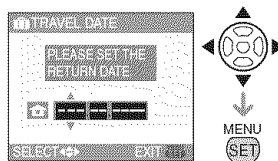

- ◀/▶: Select the desired item.
- ▲/▼: Set the year, month and date.
- The travel date is canceled if the current date is after the return date.
- If you do not want to set the return date, press [MENU/SET] while the date bar is displayed.

## 7 Press [MENU/SET] to close the menu.

## 8 Take a picture.



- (A): The number of days that have passed since the departure date
- The number of days that have passed since the departure date is displayed for about 5 seconds if this unit is turned on etc. after setting the travel date or when the travel date is set.
  - When the travel date is set,  appears on the lower right of the screen. (It is not displayed if the current date is after the return date.)

### ■ Canceling the travel date

The travel date is automatically canceled if the current date is after the return date. If you want to cancel the travel date before the end of the vacation, select [OFF] on the screen shown in step 4 and then press [MENU/SET] twice.



- The travel date is calculated using the date in the clock setting (P15) and the departure date you set. If you set [WORLD TIME] (P56) to the travel destination, the travel date is calculated

using the date in the clock setting and the travel destination setting.

- The travel date setting is memorized even if the camera is turned off.
- If you set a departure date and then take a picture on a date before this departure date, [-] (minus) is displayed in orange and the day of the vacation that you took the picture is not recorded.
- If you set a departure date and then change the clock setting to the date and time at the travel destination, [-] (minus) is displayed in white and the day of the vacation that you took the picture is recorded when the travel destination date is, for example, one day before the departure date.
- If [TRAVEL DATE] is set to [OFF], the number of days that have passed since the departure date will not be recorded even if you set the travel date or the return date. Even if [TRAVEL DATE] is set to [SET] after taking the pictures, which day of the vacation you took them is not displayed.
- Set the clock if the message [PLEASE SET THE CLOCK] appears. (P15)
- The [TRAVEL DATE] setting also affects simple mode [].

# Displaying the Time at the Travel Destination (World Time)



If you set your home area and the travel destination area when traveling abroad etc., the local time at the travel destination area can be displayed on the screen and recorded on the pictures taken.

- Select [CLOCK SET] to set the current date and time in advance. (P15)

**1** Press [MENU/SET] and then press **◀**.

**2** Press **▼** to select the [SETUP] menu icon [] and then press **▶**.

**3** Press **▲/▼** to select [WORLD TIME] and then press **▶**.

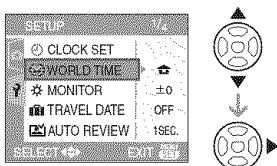

- If you are setting the world time for the first time, the message [PLEASE SET THE HOME AREA] appears. If this message appears, press [MENU/SET] and then set home area from the screen shown in step **2** in “Setting the home are [HOME]”.

## ■ Setting the home area [HOME]

(Perform steps **1**, **2** and **3**.)

- 1** Press **▼** to select [HOME] and then press [MENU/SET] to set.



- 2** Press **◀/▶** to select your home area and then press [MENU/SET] to set.

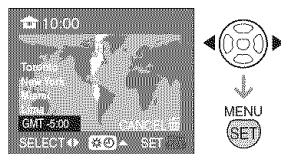

- The current time is displayed on the top left of the screen and the time difference from GMT “Greenwich Mean Time” is displayed on the bottom left of the screen.
- If daylight saving time [] is used at the home area, press **▲**. Press **▲** again to return to the original time.
- The daylight saving time setting for the home area does not advance the current time. Advance the clock setting by one hour. (P15)



## ■ Finishing setting the home area

- If you are setting the home area for the first time, the screen returns to the screen shown in step ① of "Setting the home area [HOME]" after you press [MENU/SET] to set your home area. Press ◀ to return to the screen shown in step ③ and then press [MENU/SET] to close the menu.
- If you are setting the home area for the second time etc., the screen returns to the screen shown in step ③ after you press [MENU/SET] to set your home area. Press [MENU/SET] again to close the menu.

## ■ Setting the travel destination area

(Perform steps ①, ② and ③.)

- ① Press ▲ to select [DESTINATION] and then press [MENU/SET] to set.

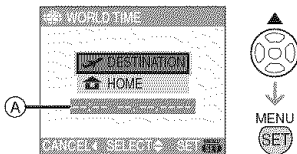

Ⓐ: Depending on the setting, the time at the travel destination area or the home area is displayed.

- If you are setting the travel destination area for the first time, the date and time are displayed as shown in the screen above.
- ② Press ◀/▶ to select the area the travel destination is in and then press [MENU/SET] to set.

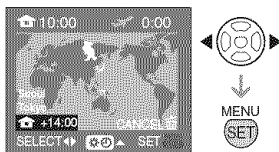

- The current time at the selected travel destination area is displayed on the top right of the screen and the time

difference from the home area is displayed at the bottom left of the screen.

- If daylight saving time [☀] is used at the travel destination, press ▲. (The time advances by one hour.) Press ▲ again to return to the original time.
- ③ Press [MENU/SET] to close the menu.

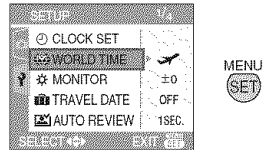

- The icon changes from [🏠] to [✈️] after setting the travel destination.



- Return the setting to [HOME] when the vacation is finished by performing steps ①, ②, ③ and then steps ① and ② of "Setting the home area [HOME]". (P56)
- If you cannot find the travel destination in the areas displayed on the screen, set by the time difference from the home area.
- The [WORLD TIME] setting also affects simple mode [♥].
- The travel destination icon [✈️] appears when playing back pictures taken at the travel destination.

# Using the [REC] Mode Menu



Increase the variety of pictures you can take by setting the white balance, color mode etc. The menu items that can be set differ depending on the recording mode.

## ■ Setting from the menu screen

Press [MENU/SET] to display the [REC] menu and then select the item to set. (P17)

### Items that can be set

(Recording in normal picture mode

[ ])

Menu screen	Item
1/3	: [W.BALANCE] (P59)
	: [SENSITIVITY] (P60)
	: [ASPECT RATIO] (P60)
	: [PICT.SIZE] (P61)
	: [QUALITY] (P61)
2/3	: [AF MODE] (P62)
	: [BURST] (P63)
	AF* : [AF ASSIST LAMP] (P63)
	: [D.ZOOM] (P28)
	: [COL.MODE] (P64)
3/3	: [CLOCK SET] (P64)

## ■ Using the quick setting

(A): Cursor buttons

(B): [MENU/SET] button

(C): [FUNC] button

• You can use [FUNC] to easily set the following items when recording.

- Burst
- White balance
- ISO sensitivity
- Number of pixels
- Quality

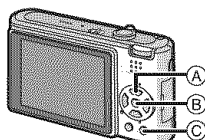

**1** Press and hold [FUNC] when recording.

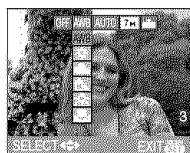

**2** Press /// to select the menu item and the setting and then press [MENU/SET] to close the menu.

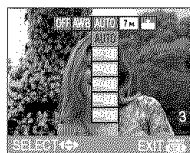

• You can also close the menu by pressing [FUNC].



• The [SET] (White Set) setting does not appear when using the quick setting.

**[W.BALANCE]**

**[WB]** Adjusting the hue for a more natural picture



Press [MENU] to display the [REC] mode menu and select the item to set. (P17)  
This function allows you to reproduce a white color close to real life in pictures recorded under sunlight, halogen lighting etc. in which the white color may appear reddish or bluish. Select a setting that matches the recording conditions.

<b>[AWB]</b> <b>(Auto white balance)</b>	for auto setting (auto white balance)
<b>(Daylight)</b>	for recording outdoors on a bright day
<b>(Cloudy)</b>	for recording outdoors on a cloudy day
<b>(Shade)</b>	for recording outdoors in the shade on a bright day
<b>(Halogen)</b>	for recording under halogen lighting
<b>(White set)</b>	for using the preset white balance
SET <b>(White set)</b>	for setting the white balance again

- 1 Auto white balance will work within this range.
- 2 Blue sky
- 3 Cloudy sky (Rain)
- 4 Shade
- 5 TV screen
- 6 Sunlight
- 7 White fluorescent light
- 8 Incandescent light bulb
- 9 Sunrise and sunset
- 10 Candlelight

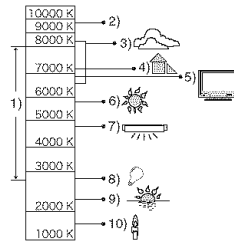

K=Kelvin Color Temperature

### ■ About auto white balance

The available white balance range is shown in the illustration above. When you take a picture beyond the available white balance range, the picture may appear reddish or bluish. Even within the confines of the range, the auto white balance may not operate properly if there are many light sources or there is no color close to white. In these cases, set the white balance to a mode other than [AWB].

### ■ Setting the white balance manually

- 1 Select [MENU/SET] and then press [MENU/SET].
- 2 Aim the camera at a sheet of white paper etc. so that the frame in the center is filled by the white object only and then press [MENU/SET].

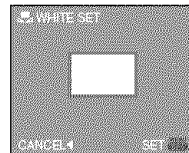

- 3 Press [MENU/SET] twice to close the menu.
  - You can also press the shutter button halfway to finish.



- When you take a picture with the flash, the white balance may not be properly adjusted if the flash level is insufficient for the subject.
- The white balance setting is memorized even if the camera is turned off. However, the white balance setting for a scene mode returns to [AWB] when the scene mode is changed.
- You can finely adjust the white balance in [UNDERWATER] in scene mode. (P51)
- The white balance cannot be set in the following cases.
  - Simple mode [♥]
  - [SCENERY], [NIGHT PORTRAIT], [NIGHT SCENERY], [FOOD], [PARTY], [CANDLE LIGHT], [SUNSET], [STARRY SKY], [FIREWORKS], [BEACH], [SNOW], [AERIAL PHOTO], [UNDERWATER] in scene mode

**[SENSITIVITY]****Setting the light sensitivity**

Press [MENU] to display the [REC] mode menu and select the item to set. (P17)  
ISO is a measure of sensitivity to light. The higher the sensitivity is set, the less light is needed to take a picture so the camera becomes more suitable for recording in dark places.

- When setting to [AUTO], the ISO sensitivity is automatically adjusted to a maximum of [ISO400] according to the brightness. (It can be adjusted to a maximum of [ISO640] when using the flash.)

<b>ISO sensitivity</b>	100 ←————→ 1250	
<b>Use in bright places (e.g. outdoors)</b>	Suitable	Not suitable
<b>Use in dark places</b>	Not suitable	Suitable
<b>Shutter speed</b>	Slow	Fast
<b>Noise</b>	Less	Increased





- ISO sensitivity is fixed to [ISO3200] in [HIGH SENS.] (P49) in scene mode.
- To avoid picture noise, we recommend decreasing the highest ISO sensitivity or setting [COL.MODE] to [NATURAL]. (P64)
- The ISO sensitivity is set to [ISO LIMIT] in intelligent ISO sensitivity mode [📷]. (P42)
- ISO sensitivity cannot be set in the following cases.
  - Simple mode [♥]
  - Motion picture mode [📹]
  - Scene mode

**[ASPECT RATIO]****Setting the aspect ratio of pictures**

Press [MENU] to display the [REC] mode menu and select the item to set. (P17)  
By changing the aspect ratio, you can select an angle of view that matches the subject.

<b>4:3</b>	<p>Select to take pictures with the same aspect ratio as a 4:3 TV or a PC monitor.</p> 
------------	--

<b>3:2</b>	<p>Select to take pictures with the same 3:2 aspect ratio as 35 mm film.</p> 
<b>16:9</b>	<p>This is suitable for landscapes etc. where a wide view is preferable. This is also suitable for playing back pictures on a wide-screen TV, high-definition TV etc.</p> 



- In motion picture mode () you can select **[3:2]**. (P52)
- The ends of the recorded pictures may be cut at printing. (P97)

**[PICT.SIZE]/[QUALITY]**  
  *Setting a picture size and quality that match your use of the pictures*



Press  to display the [REC] mode menu and select the item to set. (P17)  
 A digital picture is made of numerous dots called pixels. Although you cannot see the difference on the camera's screen, the more pixels the finer the picture will be when it is printed on a large piece of paper or displayed on a PC monitor. Picture

quality refers to the compression rate when saving digital pictures.

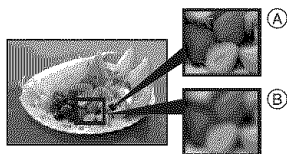

(A) Many pixels (Fine)

(B) Few pixels (Rough)

\* These pictures are examples to show the effect.

### ■ Number of pixels

You can print pictures more clearly when a large picture size [**7M**] (7M) (DMC-FX12)/ [**6M**] (6M) (DMC-FX10) is selected. When a smaller picture size [**0.3M**] (0.3M EZ) is selected, you can record more pictures and attach them to an e-mail or post them on a website because their file size is small.

### ■ When the aspect ratio is **[4:3]**.

<b>7M</b>	<b>(7M)</b> <b>(DMC-FX12)</b>	3072×2304 pixels
<b>6M</b>	<b>(6M)</b> <b>(DMC-FX10)</b>	2816×2112 pixels
<b>5M</b>	<b>(5M EZ)</b> <b>(DMC-FX12)</b>	2560×1920 pixels
<b>3M</b>	<b>(3M EZ)</b>	2048×1536 pixels
<b>2M</b>	<b>(2M EZ)</b>	1600×1200 pixels
<b>1M</b>	<b>(1M EZ)</b>	1280×960 pixels
<b>0.3M</b>	<b>(0.3M EZ)</b>	640×480 pixels



### ■ When the aspect ratio is **[3:2]**.

<b>6M</b>	<b>(6M)</b> <b>(DMC-FX12)</b>	3072×2048 pixels
<b>5M</b>	<b>(5M)</b> <b>(DMC-FX10)</b>	2816×1880 pixels
<b>2.5M</b>	<b>(2.5M EZ)</b>	2048×1360 pixels

## ■ When the aspect ratio is [16:9].

<b>55M</b> (5.5M) (DMC-FX12)	3072×1728 pixels
<b>45M</b> (4.5M) (DMC-FX10)	2816×1584 pixels
<b>2M</b> (2M EZ)	1920×1080 pixels

## ■ Quality

	Fine (Low compression): This gives priority to picture quality. Picture quality will be high.
	Standard (High compression): This gives priority to the number of recordable pictures. Standard quality pictures are recorded.





- The number of pixels that can be selected differs depending on the aspect ratio. If you change the aspect ratio, set the picture size.
- “EZ” is an abbreviation of “Extended optical Zoom”. (P26)
- The extended optical zoom does not work in [HIGH SENS.] in scene mode so the picture size for [EZ] is not displayed.
- Pictures may appear mosaic depending on the subject and the recording conditions.
- Refer to P99 for information about the number of recordable pictures.
- In simple mode [], the settings become as follows.

– [] ENLARGE]:

**4:3** : **7M** (7M) (DMC-FX12)/

**6M** (6M) (DMC-FX10)/

– [] 4"×6"/10×15cm]:

**3:2** : **25M** (2.5M EZ)/

– [] E-MAIL]:

**4:3** : **0.3M** (0.3M EZ)/

## [AF MODE]

### Setting the focus method



Press [] to display the [REC] mode menu and select the item to set. (P17)  
Select the mode that matches the recording conditions and the composition.

### 5-area-focusing:

The camera focuses on any of 5 focus areas. This is effective when the subject is not in the center of the screen.



### 1-area-focusing (High speed):

The camera quickly focuses on the subject in the AF area on the center of the screen.



### 1-area-focusing:

The camera focuses on the subject in the AF area on the center of the screen.



## ■ About [] []

- You can focus more quickly than in other AF modes.
- The picture may stop moving for a moment before being brought into focus when you press the shutter button halfway. This is not a malfunction.



- The AF area displayed is bigger than usual when taking pictures in dark places or when using the digital zoom. The AF area displayed on the center of the screen

may also be bigger than usual when taking pictures in underwater mode.

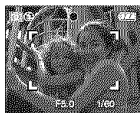

- The camera is focusing on all the AF areas when multiple AF areas (max. 5 areas) light at the same time. The focus position is not predetermined. It is set to a position automatically determined by the camera at the time of focusing. If you want to determine the focus position to take pictures, switch the AF mode to [□] or [□].
- If the AF mode is set to 5-area-focusing, the AF area is not displayed until the picture is brought into focus.
- The AF mode cannot be set in simple mode [♥], [SELF PORTRAIT] or [FIREWORKS] in scene mode.

### [BURST] Taking Pictures using Burst



Press [MENU] to display the [REC] mode menu and select the item to set. (P17)  
When burst is set to [ON], it is activated while the shutter button is pressed.



- You can only take one picture when the flash is activated.
- The burst speed becomes slower **halfway**. The exact timing of this depends on the type of card, the picture size and the quality.
- Burst cannot be set in simple mode [♥] and [STARRY SKY] in scene mode.
- You can take pictures until the capacity of the built-in memory or the card is full.

- The burst speed becomes slower if the ISO sensitivity (P42, 60) is set to [ISO400] or higher.
- The burst speed may become slower in dark places because the shutter speed becomes slower.
- The focus is fixed when the first picture is taken.
- The exposure and the white balance are adjusted for each picture.
- If you are following a moving subject while taking pictures in a place (landscape) indoors, outdoors etc. where there is a large difference between the light and shade, it may take time until the exposure is stable. If burst is used at this time, the exposure may not become optimal.
- When the self-timer is used, the number of recordable pictures in burst mode is fixed to 3.
- Burst mode is not canceled when the camera is switched off.
- When burst mode is set, the auto review function is activated regardless of the auto review setting. You cannot set the auto review function in the [SETUP] menu.

### [AF ASSIST LAMP]

**AF\*** Focusing in low light conditions becomes easier



- Press [MENU] to display the [REC] mode menu and select the item to set. (P17)  
Illuminating the subject makes it easier for the camera to focus when recording in low light conditions that make focusing difficult.
- If the AF assist lamp is set to [ON], an AF area with a size wider than usual is displayed and the AF assist lamp (A) turns on when you press the shutter button halfway in dark places etc.

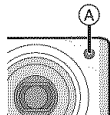

[ON]	The AF assist lamp turns on in low light conditions. At this time, the AF assist lamp icon [AF*] appears on the screen. The effective range of the AF assist lamp is 1.5 m (4.92 feet).
[OFF]	The AF assist lamp does not turn on.



- Be careful about the following when using the AF assist lamp.
  - Do not look at the AF assist lamp from close up.
  - Do not cover the AF assist lamp with your fingers or other objects.
- When you do not want to use the AF assist lamp (e.g. when taking pictures of animals in dark places), set the [AF ASSIST LAMP] to [OFF]. In this case, it will become more difficult to focus on the subject.
- The setting for [AF ASSIST LAMP] is fixed to [ON] in simple mode [♥].
- The setting for the [AF ASSIST LAMP] is fixed to [OFF] in [SELF PORTRAIT] (P46), [SCENERY] (P46), [NIGHT SCENERY] (P47), [SUNSET] (P49), [FIREWORKS] (P50), and [AERIAL PHOTO] (P51) in scene mode.
- The initial setting for [PET] (P49) in simple mode is [OFF].

### [COL.MODE]



Setting a color effect and picture quality for the recorded picture



Press [MENU] to display the [REC] mode menu and select the item to set. (P17)  
Select different items according to the recording situation and your image of the recording.

[NATURAL]	The picture becomes softer.
[VIVID]	The picture becomes sharper.
[B/W]	The picture becomes black and white.
[SEPIA]	The picture becomes sepia.



- When you take pictures in dark places, noise may become visible. To avoid noise, we recommend setting [COL.MODE] to [NATURAL].

### [CLOCK SET]



Set the display order for the date and time



Press [MENU] to display the [REC] mode menu and select the item to set. (P17)  
Change date and time. (P15)



## Displaying Multiple Screens (Multi Playback)



### 1 Rotate the zoom lever towards [W] to display multiple screens.

(Screen when 9 screens are displayed)



1 screen → 9 screens → 25 screens →  
Calendar screen display (P66)

- Rotate the zoom lever towards [Q] [T] to return to the previous screen.

### 2 Press ▲/▼/◀/▶ to select a picture.

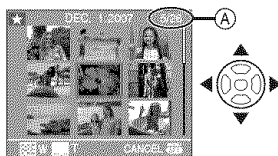

- (A): Number of the selected picture and the total number of recorded pictures
- The recording date and number of the selected picture and the total number of recorded pictures are displayed.

- Depending on the recorded picture and the setting, the following icons will appear.

- [★] (Favorites)
- [ ] (Motion picture)
- [ ] [(BABY1)][(BABY2)][(PET) in scene mode)
- [ ] (Travel date)
- [ ] (Travel destination)
- [ ] (Pictures stamped with [DATE STAMP])

### Examples of 25 screens

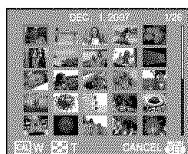

#### ■ To return to normal playback

Rotate towards [Q] [T] or press [MENU/SET].

- The picture that was selected will appear.

#### ■ To delete a picture during multi playback

- 1 Press ▲/▼/◀/▶ to select a picture and then press [ ].
- 2 Press ▲ to select [YES].
- 3 Press [MENU/SET].



- The recording information etc. on the LCD monitor cannot be deleted in multi playback even if you press [DISPLAY].
- Pictures will not be displayed in the rotated direction even if [ROTATE DISP.] is set to [ON]. (P71)

# Displaying Pictures by Recording Date

## (Calendar Playback)



You can display pictures by recording date using the calendar playback function.

### 1 Rotate the zoom lever several times towards [W] (W) to display the calendar screen.

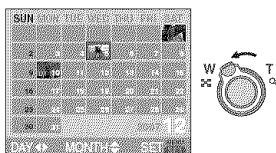

- The recording date of the picture selected in the playback screen becomes the date selected when the calendar screen is first displayed.
- If there are multiple pictures with the same recording date, the first picture recorded on that day is displayed.

### 2 Press ▲/▼/◀/▶ to select the date to be played back.

▲/▼: Select the month

◀/▶: Select the date

- If there were no pictures recorded during a month, the month is not displayed.

### 3 Press [MENU/SET] to display the pictures that were recorded on the selected date.



- Rotate the zoom lever towards [W] to return to the calendar screen.

### 4 Press ▲/▼/◀/▶ to select a picture and then press [MENU/SET].

- The picture that was selected will appear.

### ■ To return to the 1 screen playback screen

After the calendar screen is displayed, rotate the zoom lever towards [Q] [T] to display 25 screens, 9 screens and the 1 screen. (P65)



- The pictures are displayed without being rotated even if you set [ROTATE DISP.] to [ON]. (P71)
- You can display the calendar between January 2000 and December 2099.
- If the recording date of the picture selected in 25 screen multi playback is not between January 2000 and December 2099, the camera displays it in the oldest recording date in the calendar.
- Pictures edited on a PC will be displayed with dates different from the actual recording dates.
- If the date is not set in the camera (P15), the recording date is set as January 1st, 2007.
- If you take pictures after setting the travel destination in [WORLD TIME] (P56), the pictures are displayed by the dates at the travel destination in calendar playback.

# Using the Playback Zoom



## 1 Rotate the zoom lever towards [Q] [T] to enlarge the picture.

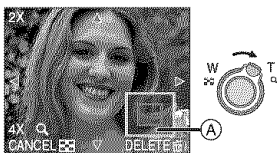

- Q : 1X → 2X → 4X → 8X → 16X
- When you rotate the zoom lever towards [W] after enlarging the picture, the magnification becomes lower. When you rotate the zoom lever towards [Q] [T], the magnification becomes higher.
- When you change the magnification, the zoom position indication (A) appears for about 1 second so that you can check the position of the enlarged section.

## 2 Press ▲/▼/◀/▶ to move the position.



- When you move the position to be displayed, the zoom position indication appears for about 1 second.

## ■ To stop using the playback zoom

Rotate the zoom lever towards [W] or press [MENU/SET].

## ■ To delete a picture during the playback zoom

- 1 Press [DEL].
- 2 Press ▲ to select [YES].
- 3 Press [MENU/SET].



- You can also delete the recording information etc. on the LCD monitor during playback zoom by pressing [DISPLAY].
- The more a picture is enlarged, the more its quality deteriorates.
- If you want to save the enlarged picture, use the trimming function. (P78)
- The playback zoom may not operate if pictures have been recorded with other equipment.

# Playing Back Motion Pictures



Press ◀/▶ to select a picture

with a motion picture icon [ 30fps VGA ] / [ 10fps VGA ] / [ 30fps QVGA ] / [ 10fps QVGA ] / [ 30fps 16.9 ] / [ 10fps 16.9 ] and then press ▼ to play back.

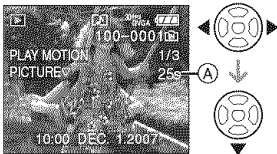

(A) The motion picture recording time  
 • After playback starts, the elapsed playback time is displayed on the bottom right of the screen.

For example, 1 hour 20 minutes and 30 seconds is displayed as [1h20m30s].

• The cursor displayed during playback is the same as ▲▼/◀▶.



## Stopping motion picture playback

Press ▼.

## Fast forwarding/Fast rewinding

Press and hold ◀/▶ during motion picture playback.

◀: Fast rewind

▶: Fast forward

• The camera returns to normal motion picture playback when ◀/▶ is released.

## To pause

Press ▲ during motion picture playback.

• Press ▲ again to cancel pause.

## Frame-by-frame forwarding/ frame-by-frame rewinding

• Press ◀/▶ while paused.



- Sound can be heard through the speaker. Refer to [VOLUME] (P20) for information about how to adjust the volume in the [SETUP] menu.
- The file format that can be played back with this camera is QuickTime Motion JPEG.
- Please note that the bundled software includes QuickTime to play back motion picture files created with the camera on the PC. (P82)
- Some QuickTime Motion JPEG files recorded by a PC or other equipment may not play back on the camera.
- If you play back motion pictures that have been recorded with other equipment, the picture quality may deteriorate or the pictures may not play back.
- When using a high capacity card, it is possible that fast rewinding may be slower than usual.
- You cannot use the following functions in motion picture mode.
  - Playback zoom
  - (during motion picture playback/pause)
  - [ROTATE DISP.]
  - [ROTATE]
  - [DATE STAMP]
  - [RESIZE]
  - [TRIMMING]

# Using the [PLAY] mode menu



You can use various functions in playback mode to rotate pictures, set protection for them etc.

## 1 Press [MENU/SET].

## 2 Press ▲/▼ to select the menu item and then press ►.

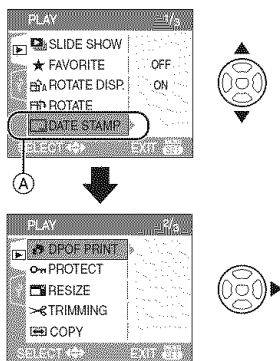

- Press ▼ at (A) to switch to the next menu screen.
- You can switch menu screens from any menu item by rotating the zoom lever.
- After performing steps 1 and 2, refer to the description of the menu item in the operating instructions and then set it.

## Items that can be set

Menu screen	Item
1/3	: [SLIDE SHOW] (P70)
	: [FAVORITE] (P70)
	: [ROTATE DISP.] (P71)
	: [ROTATE] (P71)
	: [DATE STAMP] (P72)
2/3	: [DPOF PRINT] (P74)
	: [PROTECT] (P76)
	: [RESIZE] (P77)
	: [TRIMMING] (P78)
3/3	: [COPY] (P79)
	: [FORMAT] (P80)

**[SLIDE SHOW]****▶ Playing back pictures in order for a fixed duration**

Press [MENU] to display the [PLAY] mode menu and select the item to set. (P69)  
This is recommended when playing back pictures on a TV screen. You can skip unwanted pictures if [FAVORITE] (P70) has been set.

- When [FAVORITE] is set to [ON] → step **1**.
- When [FAVORITE] is set to [OFF] → step **2**.

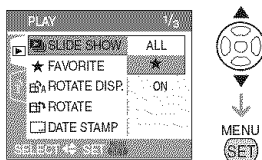
**1 Press ▲/▼ to select [ALL] or [★] and then press [MENU/SET].**

[ALL]	Displays all pictures.
[★]	Displays only those pictures that have been set as favorites (P70).

- If none of the pictures have [★] displayed, you cannot select [★] even if [FAVORITE] is set to [ON].

**2 Press ▲ to select [START] and then press [MENU/SET].**

(Screen when [ALL] is selected)

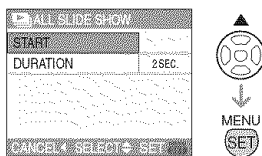

- The cursor displayed during a slide show (A) or while a slide show is paused (B) or during [MANUAL] slide show (C) is the same as ▲/▼/◀/▶.
- Press ▲ to pause the slide show. Press ▲ again to cancel pause.
- Press ◀/▶ while paused to display the previous or next picture.

**3 Press ▼ to finish.****■ Setting the duration**

Select [DURATION] on the screen shown in step **2** and set.

[DURATION]	Can be set to [1SEC.], [2SEC.], [3SEC.], [5SEC.] or [MANUAL] (manual playback).
------------	---

- You can only select [MANUAL] when [★] was selected in step **1**.
- Press ◀/▶ to display the previous or next picture when [MANUAL] is selected.



- You cannot play back motion pictures and use power save in a slide show. (However, the setting for power save mode is fixed to [10MIN.] while pausing a slide show or playing back a manual slide show.)

**[FAVORITE]**  
**Setting your favorite pictures**

Press [MENU] to display the [PLAY] mode menu and select the item to set. (P69)  
You can do the following if a mark has been added to pictures and they have been set as favorites.

- Delete all the pictures not set as favorites. ([ALL DELETE EXCEPT ★]) (P31)
- Play back the pictures set as favorites only as a slide show. (P70)

## 1 Press **▼** to select [ON] and then press [MENU/SET].

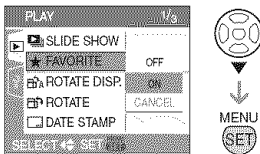

- You cannot set pictures as favorites if [FAVORITE] is set to [OFF]. Also the favorites icon [★] will not appear when [FAVORITE] is set to [OFF] even if it was previously set to [ON].
- You cannot select [CANCEL] if none of the pictures have [★] displayed.

## 2 Press [MENU/SET] to close the menu.

## 3 Press **◀/▶** to select the picture then press **▲**.



- Repeat the above procedure.
- If **▲** is pressed while the [★] favorites icon (A) is displayed, [★] is cleared, and the favorites setting is canceled.
- You can set up to 999 pictures as favorites.

### ■ Deleting all favorites

- 1 Select [CANCEL] on the screen shown in step 1 and then press [MENU/SET].
- 2 Press **▲** to select [YES] and then press [MENU/SET].
- 3 Press [MENU/SET] to close the menu.



- When printing pictures at a photo printing store, [ALL DELETE EXCEPT ★] (P31) is

useful so only the pictures you want to be printed remain on the card.

- Use [LUMIX Simple Viewer] or [PHOTOfunSTUDIO-viewer-] on the CD-ROM (supplied), to set, confirm or delete favorites. (For information about this, refer to the separate operating instructions for PC connection.)
- You may not be able to set pictures taken with other equipment as favorites.

### **[ROTATE DISP.]/[ROTATE]** To display the picture rotated

Press [MENU/SET] to display the [PLAY] mode menu and select the item to set. (P69) This mode allows you to automatically display pictures vertically if they were recorded holding the camera vertically or rotate pictures manually in 90° steps.

### ■ Rotate display

(The picture is automatically rotated and displayed.)

## 1 Press **▼** to select [ON] and then press [MENU/SET].

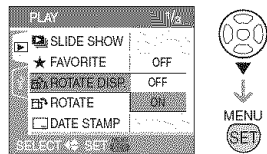

- The pictures are displayed without being rotated when you select [OFF].
- Refer to P30 for information about how to play back pictures.

## 2 Press [MENU/SET] to close the menu.

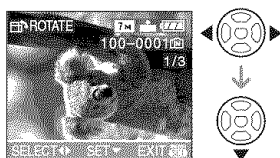
**■ Rotate****(The picture is rotated manually.)****1 Press ◀/▶ to select the picture and then press ▼.**

- The [ROTATE] function is disabled when [ROTATE DISP.] is set to [OFF].
- Motion pictures and protected pictures cannot be rotated.

**2 Press ▲/▼ to select the direction to rotate the picture and then press [MENU/SET].**

	The picture rotates clockwise in steps of 90°.
	The picture rotates counter-clockwise in steps of 90°.

**3 Press [MENU/SET] twice to close the menu.**

- If you take pictures when aiming the camera up or down, it may not be possible to display the pictures vertically. (P24)
- The picture may be slightly blurred when the camera is connected to the TV with the AV cable (supplied) and played back vertically.
- When you play back pictures on a PC, they cannot be displayed in the rotated direction unless the OS or software is compatible with Exif. Exif is a file format

for still pictures which allows recording information etc. to be added. It was established by "JEITA (Japan Electronics and Information Technology Industries Association)".

- Rotated pictures are displayed rotated when they are played back in review playback and playback zoom however are displayed without being rotated when they are played back in multi playback.
- It may not be possible to rotate pictures that have been recorded with other equipment.

**[DATE STAMP]**

**Stamping information such as the date on the recorded pictures**

Press [MENU] to display the [PLAY] mode menu and select the item to set. (P69) You can stamp the date and time of recording, the age and the travel date on the recorded pictures.

It is suitable for regular size printing. (Pictures with a picture size larger than [3M] will be resized when stamping the date etc. on them.)

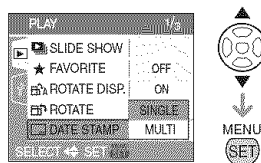
**Press ▲/▼ to select [SINGLE] or [MULTI] and then press [MENU/SET].**

- The date information cannot be stamped on the following pictures.
  - Pictures recorded without setting the clock
  - Pictures recorded with other equipment
  - Pictures that were previously stamped with [DATE STAMP]
  - Motion pictures



## ■ Single setting

**1** Press **◀▶** to select the picture and then press **▼**.

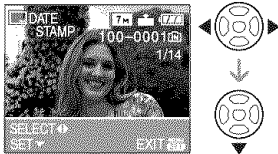

**2** Press **▲/▼/◀▶** to select [SHOOTING DATE], [AGE] or [TRAVEL DATE] and then press [MENU/SET] to set each item.

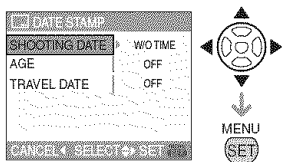

### [SHOOTING DATE]

[W/O TIME]	Stamp the year, month and date.
[WITH TIME]	Stamp the year, month, day, hour and minutes.

### [AGE] (P48)

The age is stamped when this is set to [ON].

### [TRAVEL DATE] (P54)

The travel date is stamped when this is set to [ON].

**3** Press [MENU/SET].

- If you set [DATE STAMP] for a picture with a picture size larger than [3M], the picture size will become smaller as shown below.

Aspect ratio setting	Picture size
<b>4:3</b>	6M → 3M
<b>3:2</b>	5M → 25M
<b>16:9</b>	45M → 2M

**4** Press **▲/▼** to select [YES] or [NO] and then press [MENU/SET].

(The screen shown appears when you select a picture recorded with a [6M] picture size.)

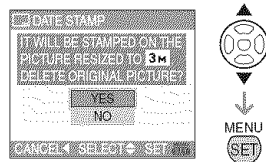

- The message [DELETE ORIGINAL PICTURE?] appears if the picture was recorded with a picture size [3M] or less.
- The picture is overwritten when you select [YES]. Pictures stamped with date stamp cannot be restored when they are overwritten.
- The picture stamped with date stamp is newly created when you select [NO].
- If the original picture is protected, you cannot overwrite it. Select [NO] and newly create the picture stamped with date stamp.

**5** Press [MENU/SET] twice to close the menu.

- The date stamp icon [  ] (A) appears on the screen if the picture has been stamped with the date stamp.
- Use the playback zoom (P67) to check the stamped date information (B).



## Multi setting

1 Press **◀/▶** to select the picture and then press **▼** to **SET/CANCEL**.

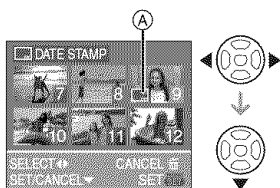

[SET]	The [DATE STAMP] icon (A) appears.
[CANCEL]	The [DATE STAMP] icon (A) disappears.

- Repeat this step.

2 Press **[MENU/SET]**.

- After performing step 2, perform step 2 onwards in “When [SINGLE] is selected”.



- We recommend setting date stamp when there is plenty of space on the built-in memory or the card.
- You can set up to 50 pictures at one time in [MULTI].
- If you select [YES] in step 4 when the pictures selected in [MULTI] include protected pictures, the message appears and the protected pictures only cannot be stamped with date stamp.
- Depending on the printer being used, some characters may be cut at printing. Check before printing.
- When you print pictures stamped with the date stamp, the date will be printed over the stamped date if you set date printing at the photo printing store or on the printer.

- You cannot use the following functions if the date information has been stamped on the picture.
  - [DATE STAMP]
  - The [PRINT WITH DATE] setting for DPOF print
  - [RESIZE]
  - [TRIMMING]

## [DPOF PRINT]

**Setting the picture to print and the number of prints**

Press **[MENU]** to display the [PLAY] mode menu and select the item to set. (P69) DPOF “Digital Print Order Format” is a system that allows the user to select which pictures to print, how many copies of each picture to print and whether or not to print the recording date on the pictures when using a DPOF compatible photo printer or photo printing store. For details, ask at your photo printing store.

When you want to use a photo printing store to print pictures recorded on the built-in memory, copy them to a card (P79) and then set the DPOF setting.

For more information visit:

[http://panasonic.jp/dc/dpof\\_110/white\\_e.htm](http://panasonic.jp/dc/dpof_110/white_e.htm)

Press **▲/▼** to select **[SINGLE]**, **[MULTI]** or **[CANCEL]** and then press **[MENU/SET]**.

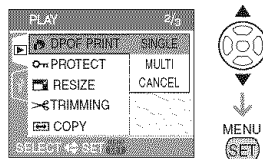

- You cannot select [CANCEL] if there are no prints that have been set in the DPOF print settings.

## ■ Single setting

1 Press **◀/▶** to select the picture to print and then press **▲/▼** to set the number of prints.

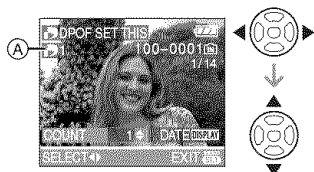



- The number of prints icon [  ] **A** appears.
- The number of prints can be set from 0 to 999. The DPOF print setting is canceled when the number of prints is set to [0].

2 Press **[MENU/SET]** twice to close the menu.

## ■ Multi setting

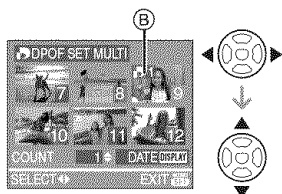
1 Press **◀/▶** to select the picture to print and then press **▲/▼** to set the number of prints.



- The number of prints icon [  ] **B** appears.
- Repeat the above procedure. (You cannot set all the pictures at one time.)
- The number of prints can be set from 0 to 999. The DPOF print setting is canceled when the number of prints is set to [0].

2 Press **[MENU/SET]** twice to close the menu.

## ■ To cancel all settings

1 Press **▲** to select **[YES]** and then press **[MENU/SET]**.

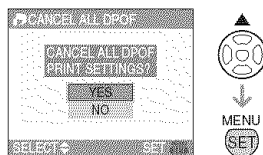

2 Press **[MENU/SET]** to close the menu.

- DPOF print settings on the built-in memory are canceled when a card is not inserted. DPOF print settings on the card are canceled when a card is inserted.

## ■ To print the date

After setting the number of prints, set/cancel printing with the recording date by pressing **[DISPLAY]**.



- The date print icon [  ] **C** appears.
- When you go to a photo printing store for digital printing, be sure to order the printing of the date additionally if required.
- Depending on the photo printing store or the printer, the date may not be printed even if you set to print the date. For further information, ask at your photo printing store or refer to the operating instructions for the printer.
- You cannot set date printing if the pictures have been stamped with the date stamp.
- If you set **[DATE STAMP]** for pictures that have been set for date printing, the date printing setting is canceled.



- DPOF is an abbreviation of “Digital Print Order Format”. This feature allows you to write print information to media and then use the information on a DPOF-compliant system.
- DPOF print setting is a convenient function when printing pictures with a printer that supports PictBridge. The date printing setting on the printer may take priority over the date printing setting on the camera. Check the date printing setting on the printer also. (P83)
- It is necessary to delete all previous DPOF print information made on other equipment when setting DPOF print on the camera.
- If the file is not based on the DCF standard (P30), the DPOF print setting cannot be set.

**[PROTECT]****Preventing accidental erasure of pictures**

Press [MENU] to display the [PLAY] mode menu and select the item to set. (P69)  
You can set protection for pictures you do not want to be deleted by mistake.

**Press ▲/▼ to select [SINGLE], [MULTI] or [CANCEL] and then press [MENU/SET].**

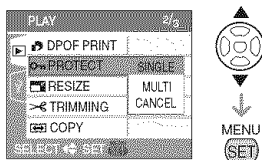
**Single setting**

**1 Press ◀/▶ to select the picture and then press ▼ to SET/CANCEL.**



[SET]	The protect icon [🔒] (A) appears.
[CANCEL]	The protect icon [🔒] (A) disappears.

**2 Press [MENU/SET] twice to close the menu.**

**Multi setting/To cancel all settings**

Perform the same operation as in “[DPOF PRINT] Setting the picture to print and the number of prints”. (P74 to 76)



- If you press [MENU/SET] while canceling protection, the canceling will stop halfway.
- The protect setting may not be effective on other equipment.
- If you want to delete protected pictures, cancel their protection.
- Even if you protect pictures in the built-in memory or a card, they will be deleted if the built-in memory or the card is formatted. (P80)
- Even if you do not protect pictures on an SD Memory Card or an SDHC Memory Card, they cannot be deleted when the card's Write-Protect switch (B) is set to [LOCK].

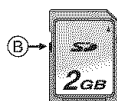

- Protected pictures cannot be rotated.

## [RESIZE] Making the picture smaller

Press [MENU] to display the [PLAY] mode menu and select the item to set. (P69)  
This function is useful if you want to reduce the file size of a picture to attach it to an e-mail or upload it to a website.

### 1 Press ◀/▶ to select the picture and then press ▼.



- The following pictures cannot be resized.

Aspect ratio setting	Picture size
4:3	0.3M
3:2	25M
16:9	2M

- Motion pictures
- Pictures stamped with [DATE STAMP]

### 2 Press ◀/▶ to select the size and then press ▼.



- Sizes smaller than the recorded picture are displayed.

Aspect ratio setting	Picture size
4:3	5M (DMC-FX12) 3M / 2M / 1M / 0.3M
3:2	25M
16:9	2M

- The message [DELETE ORIGINAL PICTURE?] appears.

### 3 Press ▲/▼ to select [YES] or [NO] and then press [MENU/SET].

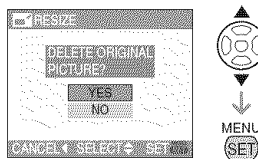

- The picture is overwritten when you select [YES]. Resized pictures cannot be restored when they are overwritten.
- A resized picture is newly created when you select [NO].
- If the original picture is protected, you cannot overwrite it. Select [NO] and newly create a resized picture.

### 4 Press [MENU/SET] twice to close the menu.



- It may not be possible to resize pictures recorded with other equipment.

## [TRIMMING] Enlarging a picture and trimming it

Press [MENU] to display the [PLAY] mode menu and select the item to set. (P69)  
You can enlarge and then clip the important part of the recorded picture.

### 1 Press ◀/▶ to select the picture and then press ▼.

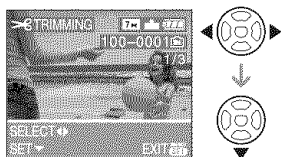

- The following pictures cannot be trimmed.
  - Motion pictures
  - Pictures stamped with [DATE STAMP]

### 2 Enlarge or decrease the parts to be trimmed with the zoom lever.

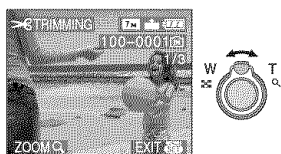

### 3 Press ▲/▼/◀/▶ to move the position of the part to be trimmed.

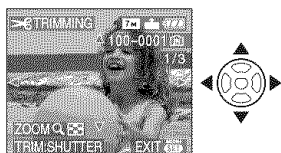

### 4 Press the shutter button.

- The message [DELETE ORIGINAL PICTURE?] appears.

### 5 Press ▲/▼ to select [YES] or [NO] and then press [MENU/SET].

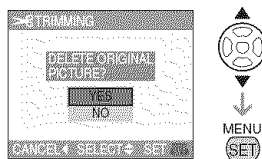

- The picture is overwritten when you select [YES]. The trimmed pictures cannot be restored when they are overwritten.
- A trimmed picture is newly created when you select [NO].
- When the original picture is protected, you cannot overwrite it. Select [NO] and newly create a trimmed picture.

### 6 Press [MENU/SET] twice to close the menu.



- Depending on the cut size, the picture size of the trimmed picture may become smaller than that of the original picture.
- The picture quality of the trimmed picture will deteriorate.
- It may not be possible to trim pictures recorded with other equipment.

**[COPY]****Copying the picture data**

Press [MENU/SET] to display the [PLAY] mode menu and select the item to set. (P69)  
You can copy recorded picture data from the built-in memory to a card or vice versa.

### 1 Press ▲/▼ to select the copy destination and then press [MENU/SET].

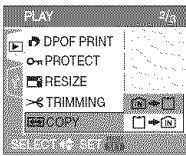

- [IN] → [ ]:

All the picture data in the built-in memory are copied onto the card at one time. → step 3.

- [ ] → [IN]:

One picture at a time is copied from the card to the built-in memory. → step 2.

### 2 Press ◀/▶ to select the picture and then press ▼.

(Only when selecting [ ] → [IN])

### 3 Press ▲ to select [YES] and then press [MENU/SET].

(The illustration shows the screen when pictures are copied from the built-in memory to a card.)

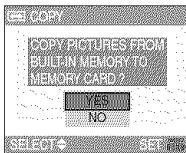

- The message [COPY THIS PICTURE TO BUILT-IN MEMORY?] appears when you copy pictures from the card to the built-in memory.

- If you press [MENU/SET] while copying pictures from the built-in memory to the card, the copying will stop halfway.
- Do not turn the camera off or perform any other operations before copying is finished. The data on the built-in memory or the card may be damaged or lost.

### 4 Press [MENU/SET] several times to close the menu.

- If you copy picture data from the built-in memory to a card, the screen automatically returns to the playback screen when all the pictures are copied.



- If you copy picture data from the built-in memory to a card which does not have sufficient free space, the picture data will only be copied halfway. We recommend using a card which has more free space than the built-in memory (about 27 MB).
- If a picture with the same name as the picture to be copied exists in the copy destination, the picture will not be copied. (P93)
- It may take time to copy the picture data.
- Only pictures recorded with a Panasonic digital camera (LUMIX) will be copied. (Even if the pictures were recorded with a Panasonic digital camera, you may not be able to copy them if they were edited with a PC.)
- DPOF settings on the original picture data will not be copied. Set the DPOF settings again after copying is finished. (P74)

## [FORMAT] Initializing the card

Press [MENU] to display the [PLAY] mode menu and select the item to set. (P69)  
Usually, it is not necessary to format the built-in memory and the card.

Format them when the message [BUILT-IN MEMORY ERROR] or [MEMORY CARD ERROR] appears.

### Press ▲ to select [YES] and then press [MENU/SET].

(The illustration shows the screen when the built-in memory is formatted.)

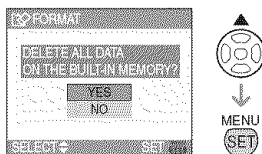

- When a card is not inserted, you can format the built-in memory. When a card is inserted, you can format the card.
- If you press [MENU/SET] while formatting the built-in memory, the formatting will stop halfway. (However, all the pictures will be deleted.)



- Formatting irretrievably deletes all the data including any protected pictures. Check the data carefully before formatting.
- If the card has been formatted on a PC or other equipment, format it on the camera again.
- Use a battery with sufficient battery power (P21) or the AC adaptor (DMW-AC5PP; optional) when formatting.
- Do not turn the camera off during formatting.
- It may take longer to format the built-in memory than the card. (Max. about 15 sec.)

- You cannot format an SD Memory Card or an SDHC Memory Card when the card's Write-Protect switch (A) is set to [LOCK].

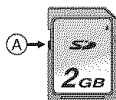

- If the built-in memory or the card cannot be formatted, consult your nearest Service Center.

For USA assistance, please call: 1-800-272-7033  
or send e-mail to: [digitalstillcam@us.panasonic.com](mailto:digitalstillcam@us.panasonic.com)

For Canadian assistance, please call:  
1-800-99-LUMIX (1-800-995-8649) or  
send e-mail to: [lumixconclerge@ca.panasonic.com](mailto:lumixconclerge@ca.panasonic.com)



# Connecting to a PC



You can acquire recorded pictures to a PC by connecting the camera and the PC. The software [LUMIX Simple Viewer] or [PHOTOfunSTUDIO-viewer-] (for Windows®) in the CD-ROM (supplied) allows you to easily acquire pictures recorded with the camera to a PC, print them and send them by e-mail.

**If you use "Windows 98/98SE", install the USB driver and then connect it to the computer.**

For information about the software in the CD-ROM (supplied) and installing this software, refer to the separate operating instructions for PC connection.

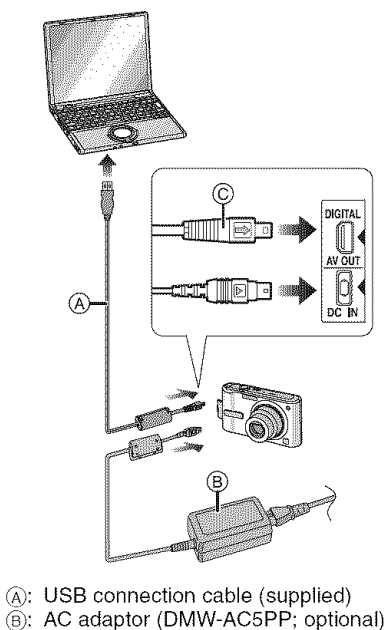

- (A): USB connection cable (supplied)  
 (B): AC adaptor (DMW-AC5PP; optional)

- Use a battery with sufficient battery power or the AC adaptor (DMW-AC5PP; optional).
- Turn the camera off before inserting or removing the cable for the AC adaptor (DMW-AC5PP; optional).
- **Set the camera to a mode other than [ ] mode.**

## 1 Turn on the camera and the PC.

## 2 Connect the camera to a PC via the USB connection cable (A) (supplied).

- Connect the USB connection cable with the [➡] mark facing the [◀] mark on the [DIGITAL] socket.
- Hold the USB connection cable at (C) and insert straight in or take straight out. (If you forcibly insert the USB connection cable at a slant or upside down you can deform the connection terminals and damage the camera or the connected equipment.)

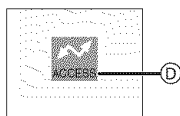

- (D): This message appears during data transfer.

### [Windows]

The drive appears in the [My Computer] folder.

- If you are connecting the camera to a PC for the first time, the required driver is installed automatically so that the camera can be recognized by "Windows Plug and Play". The drive then appears on the [My Computer] folder.

### [Macintosh]

The drive is displayed on the screen.

- The drive is displayed as [LUMIX] when you connect the camera with no card inserted.

- The drive is displayed as [NO\_NAME] or [Untitled] when you connect the camera with a card inserted.

### ■ About motion picture playback on a PC

Use the software “QuickTime” (for Windows 2000/XP) in the CD-ROM (supplied) to play back motion pictures recorded on this camera on a PC.

- If you use “Windows 98/98SE/Me”, download “QuickTime 6.5.2 for PC” from the following site, and install it.  
<http://www.apple.com/support/quicktime/>
- This software is installed as standard on a “Macintosh OS”.

### ■ Folder Composition

Folders are displayed as shown in the following illustration.

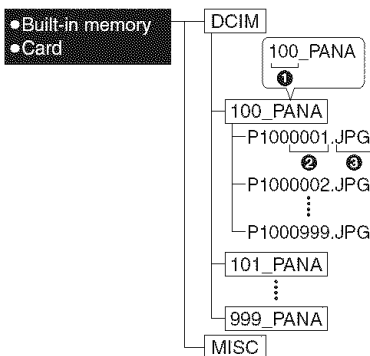

① Folder number

② File number

③ JPG: pictures

MOV: motion pictures

MISC: Folder containing files on which the DPOF print settings are recorded

- The data for up to 999 pictures recorded by the camera can be included in 1 folder. If the number of pictures exceeds 999, another folder is created.
- To reset the file number or the folder number, select [NO.RESET] in the [SETUP] menu. (P20)

### ■ Conditions under which a different folder number is used

In the following cases, the picture is not recorded in the same folder as the previously recorded picture. It is recorded in a folder with a new number.

- 1 When the folder just recorded to contains a picture file with the number 999 in it (example: P1000999.JPG).
- 2 When the card just recorded to contains, for example, a folder with the number 100 [100\_PANA] in it and that card is removed and replaced with a card that has a folder with the number 100 in it recorded by a camera from a different maker (100XXXXXX, with XXXXX being the name of the maker) and then a picture is recorded.
- 3 When recording after selecting [NO.RESET] (P20) from the [SETUP] menu. (Pictures will be recorded to a new folder with a number sequential to the folder recorded to immediately before. By using [NO.RESET] on a card that does not contain folders or pictures, such as one just formatted, the folder number can be reset to 100.)

### ■ About the PTP connection

If the OS is “Windows XP” or “Mac OS X”, you can connect in PTP mode if you set this unit to [PTP] mode and then connect to your PC.

- Pictures can only be read on the camera. They cannot be written to a card or deleted.
- When there are 1000 or more pictures on a card, the pictures may not be imported.



- Do not use any other USB connection cables except the supplied one.
- Do not disconnect the USB connection cable while [ACCESS] is displayed.
- If there are a lot of pictures on the built-in memory or a card, it may take time to transfer them.

- It may not be possible to playback the motion pictures on the built-in memory or a card normally when this unit and the PC are connected. Import the motion picture files to the PC and then play them back.
- If battery power is exhausted while the camera and the PC are communicating, the recorded data may be damaged. When you connect the camera to the PC, use a battery with sufficient battery power (P21) or the AC adaptor (DMW-AC5PP; optional).
- If the remaining battery power becomes low while the camera and the PC are communicating, the status indicator blinks and the alarm beeps. In this case, stop the communication at once on the PC.
- **When connecting the camera to a "Windows 2000" OS PC with the USB connection cable, do not replace the card while the camera and the PC are connected. The information on the card may be damaged. Use "Safely Remove Hardware" in the task tray on your PC when replacing the card.**
- Pictures edited or rotated with a PC may be displayed in black in playback mode (P30), multi playback (P65) and calendar playback (P66).
- Read the operating instructions for the PC.
- If a card is not inserted when the camera is connected to the PC, you can edit or access the pictures on the built-in memory. If a card is inserted, you can edit or access the pictures on it.
- You cannot switch between the built-in memory and the card while the camera is connected to the PC. When you want to switch between the built-in memory and the card, disconnect the USB connection cable, insert (or remove) the card and then connect the USB connection cable to the PC again.
- The message [PLEASE RE-CONNECT THE PRINTER.] appears if you change the mode dial to [ ] while the camera

and the PC are connected. If a printer is connected, change the mode to a mode other than [ ] mode and then check that no data is being transferred. ([ACCESS] appears on the LCD monitor of the camera while data is being transferred.)

## Printing the Pictures



By connecting the camera directly to a printer supporting PictBridge via the USB connection cable (supplied), you can select the pictures to print and start printing on the camera's screen.

Set print settings such as the print quality on the printer beforehand. (Read the printer operating instructions.)

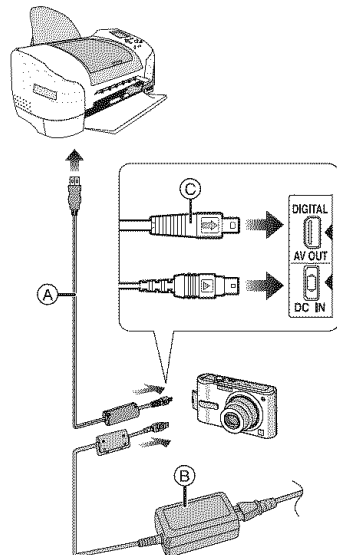

(A): USB connection cable (supplied)

(B): AC adaptor (DMW-AC5PP; optional)

- It may take time to print some pictures. Use a battery with sufficient battery power (P21) or the AC adaptor (DMW-AC5PP; optional) when you connect to a printer.
- Turn the camera off before inserting or removing the cable for the AC adaptor (DMW-AC5PP; optional).

## 1 Turn on the camera and the printer.

## 2 Set the mode dial to [📷].

## 3 Connect the camera to a printer via the USB connection cable (A) (supplied).

- Connect the USB connection cable with the [➡] mark facing the [◀] mark on the [DIGITAL] socket.
- Hold the USB connection cable at (C) and insert straight in or take straight out.



- If the mode dial is not set to [📷] when the camera is connected to the PC, disconnect the USB connection cable, set the mode dial to [📷] and then connect the USB connection cable again. (Depending on the printer, it may be necessary to turn it off and then on again.)
- Do not use any other USB connection cables except the supplied one.
- If a card is not inserted when the camera is connected to the PC, you can edit or access the picture data on the built-in memory. If a card is inserted, you can edit or access the picture data on it.
- You cannot switch between the built-in memory and the card while the camera is connected to the printer. When you want to switch between the built-in memory and the card, disconnect the USB connection cable, insert (or remove) the card and then connect the USB connection cable to the printer again.
- If you want to print the age in [BABY1]/[BABY2] (P48) or [PET] (P49) in scene

mode or the number of days that have been passed since the departure date in [TRAVEL DATE] (P54), use the software [LUMIX Simple Viewer] or [PHOTOfunSTUDIO-viewer-] in the CD-ROM (supplied) and print from the PC. For information about this, refer to the separate operating instructions for PC connection.

- To find out more about PictBridge compliant printers, contact your local dealer.

## ■ Selecting a single picture and printing it

### 1 Press ◀/▶ to select the picture and then press [MENU/SET].

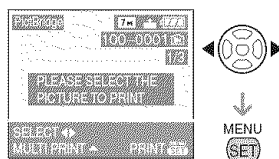

- The message disappears in about 2 seconds.

### 2 Press ▲ to select [PRINT START] and then press [MENU/SET].

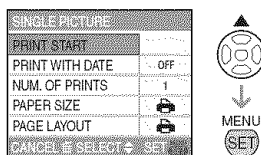

- Press [MENU/SET] to cancel printing.

### 3 Disconnect the USB connection cable after printing.

## ■ Selecting multiple pictures and printing them

1 Press **▲**.

2 Press **▲/▼** to select an item and then press **[MENU/SET]**.

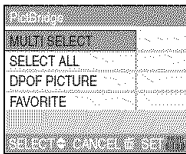

<b>[MULTI SELECT]</b>	Multiple pictures are printed at one time. <ul style="list-style-type: none"> <li>After selecting <b>[MULTI SELECT]</b>, press <b>◀/▶</b> to select the pictures to print and then press <b>▼</b>. The icon  appears on the pictures to be printed. (Press <b>▼</b> again to cancel the setting.) Press <b>[MENU/SET]</b> after finishing the setting.</li> </ul>
<b>[SELECT ALL]</b>	Prints all the stored pictures.
<b>[DPOF PICTURE]</b>	Prints the pictures set in <b>[DPOF]</b> only. (P74)
<b>[FAVORITE]*</b>	Prints the pictures set as favorites only. (P70)

\*This only appears when **[FAVORITE]** (P70) is set to **[ON]**. (However if none of the pictures have **[★]** displayed, you cannot select it even if **[FAVORITE]** is set to **[ON]**.)

3 Press **▲** to select **[PRINT START]** and then press **[MENU/SET]**.

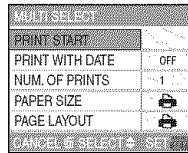

- The items **[PRINT WITH DATE]** and **[NUM. OF PRINTS]** are not displayed when **[DPOF PICTURE]** is set.
- The **DPOF** settings are displayed when **[DPOF PICTURE]** is selected. If you selected **DPOF** settings, refer to P74 and set them.
- Press **[MENU/SET]** to cancel printing.
- When you select **[MULTI SELECT]**, **[SELECT ALL]** or **[FAVORITE]**, a print confirmation screen appears. Select **[YES]** and print the pictures.
- The message **[PRINTING ## PICTURE(S) DO YOU WANT TO PROCEED ?]** appears on the print confirmation screen if the number of prints is more than 1000.

4 Disconnect the **USB** connection cable after printing.

## ■ Setting date printing, the number of prints, the paper size and the page layout

Select and set each item in step 3.

- When you want to print pictures in a paper size or a layout which is not supported by the camera, set **[PAPER SIZE]** or **[PAGE LAYOUT]** to  and then set the paper size or the layout on the printer. (For details, refer to the operating instructions of the printer.)

### • **[PRINT WITH DATE]**

<b>[OFF]</b>	Date is not printed.
<b>[ON]</b>	Date is printed.

- If the printer does not support date printing, the date cannot be printed on the picture.

### • [NUM. OF PRINTS]

Set the number of prints.

- You can set up to 999 prints.

### • [PAPER SIZE]

(Paper sizes that can be set with this unit)





The paper sizes are displayed on pages 1/2 and 2/2. Press ▼ to select.

1/2	
	Settings on the printer are prioritized.
[L/3.5"×5"]	89 mm×127 mm
[2L/5"×7"]	127 mm×178 mm
[POSTCARD]	100 mm×148 mm
[A4]	210 mm×297 mm
2/2*	
[CARD SIZE]	54 mm×85.6 mm
[10×15cm]	100 mm×150 mm
[4"×6"]	101.6 mm×152.4 mm
[8"×10"]	203.2 mm×254 mm
[LETTER]	216 mm×279.4 mm

\*These items cannot be displayed when the printer does not support the paper sizes.

### • [PAGE LAYOUT]

(Layouts for printing that can be set with this unit)

	Settings on the printer are prioritized.
	1 picture with no frame on 1 page
	1 picture with a frame on 1 page
	2 pictures on 1 page
	4 pictures on 1 page

- An item cannot be selected if the printer does not support the page layout.

### ■ Setting the date printing with the DPOF print in advance

- We recommend setting DPOF date printing with [DPOF PRINT] (P74) in advance when the printer supports it. If you select [DPOF PICTURE], printing starts and the recording date is printed.

### ■ Layout printing

#### • When printing the same picture on 1 sheet of paper

For example, if you want to print the same picture 4 times on 1 sheet of paper, set [PAGE LAYOUT] to [  ] and then set [NUM. OF PRINTS] to 4 for the picture that you want to print.

#### • When printing different pictures on 1 sheet of paper

For example, if you want to print 4 different pictures on 1 sheet of paper, set [PAGE LAYOUT] to [  ] and then set [COUNT] in [DPOF PRINT] (P74) to 1 for each of the 4 pictures.



- Do not disconnect the USB connection cable when the cable disconnection warning icon [  ] is displayed. (Depending on the printer, the icon may not be displayed.)
- If the remaining battery power becomes low while the camera and the printer are connected, the status indicator blinks and the alarm beeps. If this happens during printing, press [MENU/SET] and stop printing at once. If not printing, disconnect the USB connection cable.
- The camera is receiving an error message from the printer when the [●] indication lights orange during printing. After finishing printing, make sure there are no problems with the printer.
- If the total number of DPOF prints or the number of DPOF pictures printed is high, pictures may be printed several times. The remaining number of prints indicated may differ from the number set. This is not a malfunction.
- With date printing, the setting on the printer may take priority over the setting on the camera. Check the date print setting on the printer also.
- The message [USB MODE CHANGED. PLEASE REMOVE THE USB CABLE.]

appears if you change the mode dial to a mode other than [ ] while the camera and the printer are connected. Set the mode dial to [ ] again and then disconnect the USB connection cable. If this happens during printing, stop printing and then disconnect the USB connection cable.

## Playing Back Pictures on a TV Screen



### ■ Playing back pictures using the AV cable (supplied)

- Set the [TV ASPECT]. (P20)
- Turn this unit and the TV off.

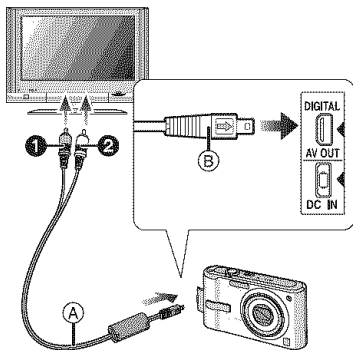

### 1 Connect the AV cable (A) (supplied) to the [AV OUT] socket on the camera.

- Connect the AV cable with the [ ] mark facing the [ ] mark on the [AV OUT] socket.
- Hold the AV cable at (B) and insert straight in or take straight out.

### 2 Connect the AV cable to the video input and the audio input sockets on the TV.

- ① Yellow: to the video input socket

- ② White: to the audio input socket

### 3 Turn the TV on and select external input.

### 4 Turn the camera on.



- Depending on the aspect setting, black bands may be displayed on the top and bottom or the left and right of the pictures.
- Do not use any other AV cables except the supplied one.
- Audio playback is monaural.
- Read the operating instructions for the TV.
- When you play back a picture vertically, it may be blurry.
- You can view pictures on TVs in other countries (regions) which use the NTSC or PAL system when you set [VIDEO OUT] in the [SETUP] menu. Even if you set [VIDEO OUT] to [PAL], the output signal will still be NTSC in the recording mode.

### ■ Playing back pictures on a TV with an SD Memory Card slot

Still pictures recorded on an SD Memory Card can be played back on a TV with an SD Memory Card slot.



- Depending on the TV model, pictures may not be displayed on the full screen.
- Motion pictures cannot be played back. To play back motion pictures, connect the camera to the TV with the AV cable (supplied).
- You may not be able to play back MultiMediaCards.

# Screen Display

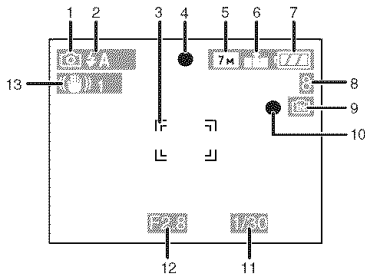

## Ⓐ In recording

### Recording in normal picture mode [ ] (Initial setting)

- 1 Recording mode
- 2 Flash mode (P35)
- 3 AF area (P22)
- 4 Focus (P22)
- 5 Picture size (P61)
- 6 Quality (P61)  
: Jitter alert (P24)
- 7 Battery indication (P21)
- 8 Number of recordable pictures (P99)
- 9 Built-in memory (P14)  
: Card (P14)
- 10 Recording state
- 11 Shutter speed (P22)
- 12 Aperture value (P22)
- 13 Optical image stabilizer (P41)

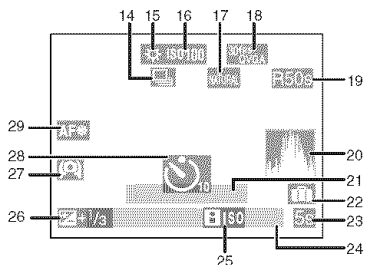

## In recording (after settings)

- 14 Burst (P63)  
: Audio recording (P52)
- 15 White balance (P59)
- 16 ISO sensitivity (P60)  
: ISO limit (P42)
- 17 Color mode (P64)
- 18 Picture mode (P52)  
 (4:3)  
 (16:9)
- 19 Available recording time (P52):
- 20 Histogram (P33)
- 21 Age (P48)
  - This is displayed for about 5 seconds when this unit is turned on in [BABY1]/[BABY2] or [PET] in scene mode.

Number of days that have passed since the travel date (P54)
- 22 Travel date (P54)
- 23 Elapsed recording time (P52)
- 24 Current date and time/  
Travel destination setting (P56):
  - This is displayed for about 5 seconds when the camera is turned on, after setting the clock and after switching from playback mode to recording mode.

Zoom (P26)/Extended optical zoom (P26)/Digital zoom (P28):
- 25 Intelligent ISO sensitivity mode (P42)
- 26 Exposure compensation (P40)
- 27 High angle mode (P34)/  
: Power LCD (P34)
- 28 Self-timer mode (P39)
- 29 AF assist lamp (P63)



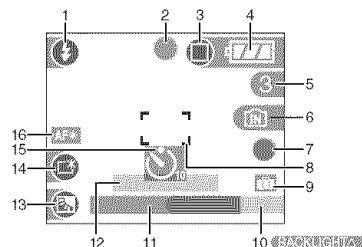

## B Recording in simple mode

- 1 Flash mode (P35)
- 2 Focus (P22)
- 3 Picture mode (P24)  
: Jitter alert (P24)
- 4 Battery indication (P21)
- 5 Number of recordable pictures (P99)
- 6 Built-in memory (P14)  
: Card (P14)
- 7 Recording state
- 8 AF area (P22)
- 9 Travel date (P54)
- 10 Operation for backlight compensation (P26)
- 11 Current date and time
  - This is displayed for about 5 seconds when the camera is turned on, after setting the clock and after switching from playback mode to simple mode.
- Zoom (P26)/Extended optical zoom (P26):
- 12 Number of days that have passed since the travel date (P54)
- 13 Backlight compensation (P26)
- 14 Power LCD (P34)
- 15 Self-timer mode (P39)
- 16 AF assist lamp (P63)

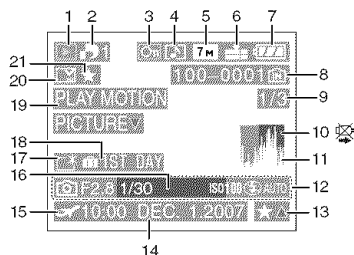

## C In playback

- 1 Playback mode (P30)
- 2 Number of DPOF prints (P74)
- 3 Protected picture (P76)
- 4 Motion pictures (P68)
- 5 Picture size (P61)
- 6 Quality (P61)  
 In Motion picture mode (P68):  
 (4:3)  
 (16:9)  
 In Simple mode (P24)  
: ENLARGE  
: 4"×6"/10×15cm  
: E-MAIL
- 7 Battery indication (P21)
- 8 Folder/File number (P82)  
 Built-in memory (P14)  
: Card (P14)
- 9 Picture number/Total pictures
- 10 Cable disconnection warning icon (P86)  
 Motion picture recording time (P68): 1h20m30s
- 11 Histogram (P33)
- 12 Recording information
- 13 Favorites settings (P70)/Elapsed playback time (P68): 1h20m30s
- 14 Recorded date and time

- 15 Travel destination setting (P56)
- 16 Age (P48)
- 17 Power LCD (P34)
- 18 Number of days that have passed since the travel date (P54)
- 19 Motion picture playback (P68)
- 20 Stamped with date stamp indication (P72)
- 21 Favorites indication (P70)

## Cautions for Use

### ■ Optimal use of the camera

**Take care not to drop or knock the unit or put a lot of pressure on it.**

- Take care not to knock or drop the bag/case that you inserted the camera in as the shock may cause damage to the camera, lens or LCD monitor.
- Do not attach any other items to the wrist strap that's included with your camera. While being stored, that item can rest against the LCD monitor and damage it.
- Do not use a paper bag as it can easily rip causing the camera to fall and be damaged.
- We strongly recommend you purchase a good camera bag/case from your local dealer to protect your camera.

**Keep the camera as far away as possible from electromagnetic equipment (such as microwave ovens, TVs, video games etc.).**

- If you use the camera on top of or near a TV, the pictures and sound on the camera may be disrupted by electromagnetic wave radiation.
- Do not use the camera near cell phones because doing so may result in noise adversely affecting the pictures and sound.
- Recorded data may be damaged, or pictures may be distorted, by strong magnetic fields created by speakers or large motors.

- Electromagnetic wave radiation generated by microprocessors may adversely affect the camera, disturbing the pictures and sound.
- If the camera is adversely affected by electromagnetic equipment and stops functioning properly, turn the camera off and remove the battery or disconnect AC adaptor (DMW-AC5PP; optional). Then reinsert the battery or reconnect AC adaptor and turn the camera on.

**Do not use the camera near radio transmitters or high-voltage lines.**

- If you record near radio transmitters or high-voltage lines, the recorded pictures and sound may be adversely affected.

**Always use the supplied cords and cables. If you use optional accessories, use the cords and the cables supplied with them.**

**Do not extend the cords or the cables.**

**Do not spray the camera with insecticides or volatile chemicals.**

- If the camera is sprayed with such chemicals, the body of the camera may be damaged and the surface finish may peel off.
- Do not keep rubber or plastic products in contact with the camera for a long period of time.

**Do not use benzine, thinner or alcohol for cleaning the camera.**

- Before cleaning the camera, remove the battery or disconnect the AC adaptor (DMW-AC5PP; optional) from the electrical outlet.
- The body of the camera may be damaged and the surface finish may peel off.
- Wipe the camera with a soft, dry cloth.
- Do not use kitchen detergent or a chemically treated cloth.

### ■ About the LCD monitor

- Do not press the LCD monitor with excessive force. Uneven colors may appear on the LCD monitor and it may malfunction.
- If the camera is cold when you turn it on, the picture on the LCD monitor will be slightly darker than usual at first. However, the picture will return to normal brightness when the internal temperature of the camera increases.

Extremely high precision technology is employed to produce the LCD monitor screen. However there may be some dark or bright spots (red, blue or green) on the screen. This is not a malfunction. The LCD monitor screen has more than 99.99% effective pixels with a mere 0.01% of the pixels inactive or always lit. The spots will not be recorded on pictures on the built-in memory or a card.

### ■ About the Lens

- Do not press the lens with excessive force.
- Do not leave the camera with the lens facing the sun as it may cause the camera to malfunction. Also, be careful when you leave the camera outside or near a window.

### ■ Battery

The battery is a rechargeable lithium ion battery. Its ability to generate power comes from the chemical reaction that takes place inside it. This reaction is susceptible to the surrounding temperature and humidity. If the temperature is too high or too low, the operating time of the battery will become shorter.

Always remove the battery after use.

Store the removed battery in the battery carrying case (supplied).

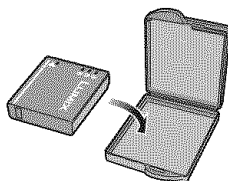

Bring charged spare batteries when going out.

- Be aware that the operating time of the battery becomes shorter in low temperature conditions such as at a ski resort.
- When you travel, do not forget to bring the battery charger (supplied) so that you can charge the battery in the country that you are travelling in.

If you drop the battery accidentally, check to see if the body of the battery and the terminals are damaged.

- Inserting a damaged battery in the camera will damage the camera.

Dispose of unusable battery.

- The battery has a limited life.
- Do not throw the battery into fire because it may cause an explosion.
- The unusable battery should be discarded in accordance with battery recycling laws. Call the RBRC hotline on 1-800-822-8837 for information.

Do not allow battery terminals to come into contact with metal objects (such as necklaces, hairpins etc.).

- This can cause short circuiting or heat generation and you may be badly burned if you touch a battery.

## ■ Charger

- If you use the battery charger near a radio, the radio reception may be disturbed. Keep the charger 1 m (3.28 feet) or more away from radios.
- The charger may generate whirring sounds when it is being used. This is not a malfunction.
- After using the charger, be sure to disconnect it from the electrical outlet. (A very small amount of current is consumed if it is left connected.)
- Keep the terminals of the charger and battery clean.

## ■ Card

**Do not leave the card where the temperature is high, where electromagnetic waves or static electricity are easily generated or exposed to direct sunlight. Do not bend or drop the card.**

- The card may be damaged or the recorded content may be damaged or deleted.
- Put the card in the card case or the storage bag after use and when storing or carrying the card.
- Do not allow dirt, dust or water to get into the terminals on the back of the card and do not touch the terminals with your fingers.

## ■ When not using the camera for a long period of time

- Store the battery in a cool and dry place with a relatively stable temperature.  
[Recommended temperature: 15 °C to 25 °C (59 °F to 77 °F), Recommended humidity: 40% to 60%]
- Always remove the battery and the card from the camera.
- If the battery is left inserted in the camera, it will discharge even if the camera is turned off. If the battery continues to be left in the camera, it will discharge excessively and may become unusable even if charged.
- When storing the battery for a long period of time, we recommend charging it once a

year. Remove the battery from the camera and store it again after it has completely discharged.

- We recommend storing the camera with a desiccant (silica gel) when you keep it in a closet or a cabinet.

## Message Display

Confirmation messages or error messages will be displayed on the screen in some cases.

The major messages are described below as examples.

### [THIS MEMORY CARD IS PROTECTED]

The Write-Protect switch on the SD Memory Card and the SDHC Memory Card are moved to [LOCK]. Move the switch back to unlock it. (P14, 76, 80)

### [NO VALID PICTURE TO PLAY]

Record a picture or insert a card with a recorded picture and then play it.

### [THIS PICTURE IS PROTECTED]

Delete or overwrite the picture after canceling the protect setting. (P76)

### [THIS PICTURE CANNOT BE DELETED]/ [SOME PICTURES CANNOT BE DELETED]

Pictures not based on the DCF standard cannot be deleted. If you want to delete some pictures, format the card after saving necessary data on a PC etc. (P80)

### [NO ADDITIONAL DELETE SELECTIONS CAN BE MADE]

You have exceeded the number of pictures that can be set at one time with [MULTI] in [DATE STAMP] or [MULTI DELETE]. Delete the set pictures or stamp the date information on them and then do the operation for any remaining pictures. More than 999 favorites have been set.

### [CANNOT BE SET ON THIS PICTURE]/ [CANNOT BE SET ON SOME PICTURES]

DPOF print cannot be set for pictures not based on the DCF standard.

**[NOT ENOUGH SPACE ON BUILT-IN MEMORY]/[NOT ENOUGH MEMORY IN THE CARD]**

There is no space left on the built-in memory or the card.

- When you copy pictures from the built-in memory to the card (batch copy), the pictures are copied until the capacity of the card becomes full.

**[SOME PICTURES CANNOT BE COPIED]/[COPY COULD NOT BE COMPLETED]**

The following pictures cannot be copied.

- When a picture with the same name as the picture to be copied exists in the copy destination.
  - Files not based on the DCF standard.
- Moreover, pictures recorded or edited by other equipment may not be copied.

**[BUILT-IN MEMORY ERROR FORMAT BUILT-IN MEMORY?]**

This message will be displayed when you formatted the built-in memory on a PC. Format the built-in memory on the camera again. (P80) The data on the built-in memory will be deleted.

**[MEMORY CARD ERROR FORMAT THIS CARD?]**

The card format cannot be recognized by the camera. Format the card again with the camera after saving necessary data on a PC etc. (P80)

**[PLEASE TURN CAMERA OFF AND THEN ON AGAIN]**

This message appears when the camera is not operating properly. Turn the camera off and on. If the message persists, contact the dealer or your nearest Service Center.

**[MEMORY CARD PARAMETER ERROR]**

- Use a card compatible with this unit. (P5, 14)
- You can only use an SDHC Memory Card if using cards with 4 GB or more capacity.

**[MEMORY CARD ERROR PLEASE CHECK THE CARD]**

- An error has occurred accessing the card. Insert the card again.

**[READ ERROR PLEASE CHECK THE CARD]**

An error has occurred reading the data. Insert the card again. Make sure the card is inserted properly and then play back again.

**[WRITE ERROR PLEASE CHECK THE CARD]**

An error has occurred writing the data. Turn the camera off and remove the card. Insert the card again and turn the camera on. Make sure the camera is turned off before removing or inserting the card to avoid damage.

**[MOTION RECORDING WAS CANCELLED DUE TO THE LIMITATION OF THE WRITING SPEED OF THE CARD]**

- When you set the picture quality to [30fpsVGA] or [30fps16:9], we recommend using a High Speed SD Memory Card with "10MB/s" or greater displayed on the package.
- Depending on the type of SD Memory Card or SDHC Memory Card, motion picture recording may stop in the middle.

**[A FOLDER CANNOT BE CREATED]**

A folder cannot be created because there are no remaining folder numbers that can be used. (P82)



Format the card after saving necessary data on a PC etc. (P80)

If you execute [NO.RESET] in the [SETUP] menu after formatting, the folder number is reset to 100. (P20)



**[PICTURE IS DISPLAYED FOR 4:3 TV]/  
[PICTURE IS DISPLAYED FOR 16:9 TV]**

- The AV cable is connected to the camera. Press [MENU/SET] if you want to delete this message at once.
- Select [TV ASPECT] in the [SETUP] menu if you want to change the TV aspect. (P20)
- This message also appears when the USB connection cable is connected to the camera only.  
In this case, connect the other end of the USB connection cable to a PC or a printer. (P81, 83)

**[PLEASE RE-CONNECT THE PRINTER.]**

This message will be displayed if you change the mode dial to print mode [] while this unit and the PC are connected. If a printer is connected, change the mode to a mode other than [] mode and then check that no data is being transferred. ([ACCESS] appears on the LCD monitor of this unit while data is being transferred.)

**[USB MODE CHANGED. PLEASE REMOVE THE USB CABLE.]**

This message will be displayed if you change the mode dial to a mode other than print mode [] while this unit and the printer are connected.  
Set the mode dial to [] again and then disconnect the USB cable. If printing, stop the printing and then disconnect the USB cable.

## Troubleshooting

If you return the menu settings to the initial settings at the time of purchase, the condition may improve.

**Select [RESET] in the [SETUP] menu. (P20)**

### ■ Battery and power source

**1: The camera cannot be operated even when it is turned on.**

- Is the battery inserted correctly?
  - Check the direction of the battery. (P13)
- Is the battery sufficiently charged?
  - Use a battery that has been sufficiently charged.

**2: The LCD monitor turns off while the camera is turned on.**

- Is power save mode (P18) or economy mode (P19) activated?
  - Press the shutter button halfway to cancel these modes.
- Is the battery exhausted?
  - Use a battery that has been sufficiently charged.

**3: The camera turns off immediately after it is turned on.**

- Is the battery charge insufficient to operate the camera?
  - Use a battery that has been sufficiently charged.
  - If you leave the camera on, the battery will be exhausted. Turn the camera off frequently by using power save mode (P18) etc.

### ■ Recording

**1: The picture cannot be recorded.**

- Is the mode dial correctly set?
- Is there any memory remaining on the built-in memory or the card?
  - Before recording, delete some pictures. (P30)

**2: The recorded picture is whitish.**

**The lens is dirty.**

- The picture can become whitish if there is dirt e.g. fingerprints on the lens. If the lens is dirty, turn on the camera, eject the lens barrel (P9) and gently wipe the lens surface with a soft dry cloth.

**3: The recorded picture is too bright or dark.**

- Check that the exposure is correctly compensated. (P40)

**4: 2 or 3 pictures are taken at one time.**

- Is [BURST] in the [REC] mode menu set to [ON]? (P63)

**5: The subject is not focused properly.**

- The focus range varies depending on the recording mode.  
Rotate the mode dial to set the proper mode for the distance to the subject.
- Is the subject beyond the focus range of the camera? (P22, 43)
- Have you taken a picture with jitter?

**6: The recorded picture is blurred. The optical image stabilizer is not effective.**

- The shutter speed will become slower and the optical image stabilizer function may not work properly when taking pictures especially in dark places. In this case, we recommend holding the camera firmly with both hands when taking pictures. (P22) We recommend using the self-timer (P39) when taking pictures with a slow shutter speed.

**7: The recorded picture looks rough. Noise appears on the picture.**

- Is the ISO sensitivity high or the shutter speed slow?  
(ISO sensitivity is set to [AUTO] when the camera is shipped. Therefore, when taking pictures indoors etc. the ISO sensitivity increases.)  
– Decrease the ISO sensitivity. (P60)  
– Set [COL.MODE] to [NATURAL]. (P64)  
– Take pictures in bright places.
- In [HIGH SENS.] (P49) in scene mode, the resolution of the recorded picture decreases slightly because of high sensitivity processing.  
This is not a malfunction.

**8: The brightness or the hue of the recorded picture is different from the actual scene.**

- If recording under fluorescent light, the brightness or the hue may change slightly when the shutter speed becomes fast. This occurs due to the characteristics of fluorescent light. It is not a malfunction.

**9: A reddish vertical line appears on the LCD monitor when the shutter button is pressed halfway or when recording motion pictures.**

- This is a phenomenon called smear. It is a characteristic of CCD and appears when the subject has a bright part. Black or green vertical lines may also appear or uneven colours may appear around the smear. This is not a malfunction. It is recorded in motion pictures but is not recorded on still pictures.

**10: Motion picture recording stops in the middle.**

- Are you using a MultiMediaCard?  
– This unit does not support MultiMediaCards.
- When you set the picture quality to [30fpsVGA] or [30fps16:9], we recommend using a High Speed SD Memory Card with "10MB/s" or greater displayed on the package.
- Depending on the type of the card, recording may stop in the middle.

**■ LCD monitor****1: The LCD monitor sometimes turns off although the camera is turned on.**

- Have you set economy mode? (P19)  
– In economy mode, the LCD monitor turns off while the flash is charged.

**2: The LCD monitor becomes darker or brighter for a moment.**

- This phenomenon appears when you press the shutter button halfway to set the aperture value and does not affect the recorded pictures.

**3: The LCD monitor flickers indoors.**

- The LCD monitor may flicker for a few seconds after turning the camera on indoors under fluorescent light. This is not a malfunction.

**4: The LCD monitor is too bright or dark.**

- Adjust the brightness of the screen. (P19)
- Is the power LCD function or high angle mode activated?



**5: Black, red, blue and green dots appear on the LCD monitor.**

- These pixels do not affect the recorded pictures. This is not a malfunction.

**6: Noise appears on the LCD monitor.**

- In dark places, noise may appear to maintain the brightness of the LCD monitor. This does not affect the pictures you are recording.

**■ Flash****1: The flash is not activated.**

- Is the flash setting set to Forced OFF ?
  - Change the flash setting. (P35)
- The flash is not activated when motion picture mode [,] [SCENERY] (P46), [NIGHT SCENERY] (P47), [SUNSET] (P49), [HIGH SENS.] (P49), [STARRY SKY] (P49), [FIREWORKS] (P50) or [AERIAL PHOTO] (P51) in scene mode is selected.

**2: The flash is activated 2 times.**

- When you select red-eye reduction (P36), the flash is activated once before the actual recording to reduce the red-eye phenomenon (eyes of the subject appearing red in the picture) and then activated again for the actual recording.

**■ Playback****1: The picture being played back is rotated and displayed in an unexpected direction.**

The camera has a function that automatically rotates the display of pictures recorded holding the camera vertically. (If you take pictures when aiming the camera up or down, the camera may recognize that it is being held vertically.)

- You can display the pictures without being rotated when [ROTATE DISP.] (P71) is set to [OFF].
- You can rotate pictures with the [ROTATE] function. (P71)

**2: The picture is not played back.**

- Is the mode dial set to playback []?
- Is there a picture on the built-in memory or the card?
  - The pictures on the built-in memory appears when a card is not inserted. The picture data on the card appears when a card is inserted. (P14)

**3: The folder number and the file number are displayed as [—] and the screen turns black.**

- Is the picture edited with a PC or recorded with a digital camera from another manufacturer?
  - This may also happen if the battery is removed immediately after recording or if recording with an exhausted battery.
    - Format the data to delete the pictures mentioned above. (P80) (Formatting irretrievably deletes all data including the other pictures. Check the data carefully before formatting.)

**4: The picture is displayed with a date different from the actual recording date in calendar playback.**

- Was the picture edited with a PC or recorded with a digital camera from another manufacturer?
  - This kind of picture may be displayed with a date different from the actual recording date in calendar playback. (P66)
- Did you record the pictures after setting the clock correctly on this unit? (P15)
  - For example, if the clock setting on the camera is different from the date and time set on the PC and you acquire pictures recorded with the camera to



the PC and then write them back to the card, the pictures may be displayed with dates different from the actual recording dates in calendar playback etc.

## ■ TV, PC and printer

### 1: The picture does not appear on the television.

- Is the camera connected to the TV correctly?
- Set the TV input to external input mode.

### 2: The display areas on the TV screen and the camera's LCD monitor are different.

Depending on the TV model, the area display may be smaller so the picture may be stretched horizontally or vertically and the top and bottom or left and right of the picture may be cut off when it is displayed. This is due to the TV specifications and is not a malfunction.

### 3: The motion pictures cannot be played back on a TV.

- Are you trying to play back the motion pictures by directly inserting the card in the card slot of the TV?
  - Connect the camera to the TV with the AV cable (supplied) and then play back the pictures on the camera. (P87)

### 4: The picture cannot be transferred when the camera is connected to a PC.

- Is the camera connected to the PC correctly?
- Is the camera recognized by the PC correctly?

### 5: The card is not recognized by the PC. (The built-in memory is recognize)

- Disconnect the USB connection cable. Connect it again while the card is inserted in the camera.

### 6: The picture cannot be printed when the camera is connected to a printer.

- Does the printer support PictBridge?

- You cannot print pictures with printers which do not support PictBridge. (P83)
- Reset the mode to [  ]. (P83)

### 7: The ends of the pictures are cut at printing.



- When using a printer with a trimming or borderless printing function, cancel this function before printing. (For details, refer to the operating instructions for the printer.)
- When you order photo studios to print pictures, ask the photo studio if the pictures can be printed with both ends.

### 8: The picture is not displayed fully on the TV.

- Set the aspect of the TV on the camera. (P20)

## ■ Others

### 1: An unreadable language was selected by mistake.

- Press [MENU/SET], select the [SETUP] menu icon [  ] and then select the [  ] icon to set the desired language. (P20)

### 2: The setting for the auto review function is disabled.

- Is the camera in burst mode (P63) or motion picture mode [  ] (P52) or [SELF PORTRAIT] (P46) in scene mode?
  - In these cases, you cannot set the auto review function in the [SETUP] menu.

### 3: A red lamp sometimes turns on when the shutter button is pressed halfway.

- In dark places, the AF assist lamp (P63) lights red to make it easier to focus on a subject.

**4: The AF assist lamp does not turn on.**

- Is [AF ASSIST LAMP] on the [REC] mode menu set to [ON]? (P63)
- Are you taking pictures in dark places?  
– The AF assist lamp does not turn on in bright places.
- The AF assist lamp does not turn on when [SELF PORTRAIT] (P46), [SCENERY] (P46), [NIGHT SCENERY] (P47), [SUNSET] (P49), [FIREWORKS] (P50) or [AERIAL PHOTO] (P51) in scene mode is selected.

**5: The camera becomes warm.**

- The surface of the camera may become warm during use. This does not affect the performance or quality of the camera.

**6: The lens clicks.**

- When the brightness changes due to zoom or camera movement etc., the lens may click and the picture on the screen may drastically change. However, the picture is not affected. The sound is caused by the automatic adjustment of the aperture. This is not a malfunction.

**7: The clock is reset.**

- If you do not use the camera for a long time, the clock may be reset. When the message [PLEASE SET THE CLOCK] appears, set the clock again. (P15)
- When you take a picture before setting the clock, [0:00 0. 0. 0] is recorded.

**8: The displayed picture is slightly distorted.**

- Depending on the zoom magnification, the recorded picture is slightly distorted. This is called distortion aberration. The closer you get to the subject to take pictures of in wide angle, the more distorted the picture you take is. However this is not a malfunction.

**9: Colors appear on the picture which were not found in the actual scene.**

- Depending on the zoom magnification, the picture may have some colored fringes around the subject. This is called chromatic aberration and may be more visible when recording distant subjects. However this is not a malfunction.

**10: The file numbers are not recorded consecutively.**

- When you perform an operation after taking a certain action, the pictures may be recorded in folders with different numbers from the ones used prior to the operation. (P82)

**11: The file numbers are recorded in ascending order.**

- If the battery is inserted or removed when the camera is not turned off, the recorded folder numbers are lost. However if you turn the camera on again and record pictures, the recorded folder numbers are different from the prior recorded folder numbers.

**12: The picture is displayed in black.**

- Pictures edited or rotated with a PC may be displayed in black in playback mode (P30), multi playback (P65) and calendar playback (P66).

# Number of Recordable Pictures and Available Recording Time

- The number of recordable pictures and the available recording time are an approximation. (These vary depending on the recording conditions and the type of card.)
- The number of recordable pictures and the available recording time varies depending on the subjects.
- The numbers inside the thick black lines are the number of recordable pictures in simple mode [♥]. (P24)



## ■ Number of recordable pictures

Aspect ratio		4:3					
Picture size		7M / (7M): (3072×2304 pixels) (DMC-FX12)		6M / (6M): (2816×2112 pixels) (DMC-FX10)		5M (5M EZ): (2560×1920 pixels) (DMC-FX12)	
Quality							
Built-in Memory (Approx. 27 MB)		7	14	8	17	10	21
Card	16 MB	3	7	4	8	5	10
	32 MB	7	16	9	19	11	23
	64 MB	16	34	20	40	24	48
	128 MB	35	69	41	82	50	99
	256 MB	68	135	81	160	98	190
	512 MB	135	270	160	320	195	380
	1 GB	270	540	320	640	390	770
2 GB	550	1090	660	1270	790	1530	
4 GB	1090	2150	1290	2510	1560	3010	

Aspect ratio		4:3					
Picture size		3M (3M EZ): (2048×1536 pixels)		2M (2M EZ): (1600×1200 pixels)		1M (1M EZ): (1280×960 pixels)	
Quality							
Built-in Memory (Approx. 27 MB)		16	33	27	53	41	78
Card	16 MB	8	16	13	27	21	40
	32 MB	18	36	29	58	45	85
	64 MB	38	75	61	120	93	175
	128 MB	78	150	125	240	190	350
	256 MB	150	290	240	470	370	690
	512 MB	300	590	480	940	730	1370
	1 GB	600	1180	970	1880	1470	2740
2 GB	1220	2360	1920	3610	2920	5120	
4 GB	2410	4640	3770	7090	5740	10050	

Aspect ratio		4:3		3:2			
Picture size		0.3M (0.3M EZ): (640×480 pixels)		6M (6M): (3072×2048 pixels) (DMC-FX12)		5M (5M): (2816×1880 pixels) (DMC-FX10)	
Quality							
Built-in Memory (Approx. 27 MB)		130	210	8	16	9	19
Card	16 MB	68	110	3	8	4	10
	32 MB	145	230	8	18	10	21
	64 MB	290	480	19	38	22	45
	128 MB	600	970	39	78	46	92
	256 MB	1170	1900	77	150	91	180
	512 MB	2320	3770	150	300	180	350
	1 GB	4640	7550	300	600	360	710
	2 GB	8780	12290	620	1220	730	1420
4 GB	17240	24130	1230	2410	1450	2800	

Aspect ratio		3:2		16:9			
Picture size		2.5M (2.5M EZ): (2048×1360 pixels)		5.5M (5.5M): (3072×1728 pixels) (DMC-FX12)		4.5M (4.5M): (2816×1584 pixels) (DMC-FX10)	
Quality							
Built-in Memory (Approx. 27 MB)		19	37	9	19	11	23
Card	16 MB	9	18	4	10	5	11
	32 MB	20	40	10	21	12	25
	64 MB	43	83	22	45	27	53
	128 MB	88	165	46	92	55	105
	256 MB	170	330	91	180	105	210
	512 MB	340	650	180	350	210	420
	1 GB	680	1310	360	710	430	850
	2 GB	1360	2560	730	1420	870	1700
4 GB	2680	5020	1450	2800	1720	3350	

<b>Aspect ratio</b>		<b>16:9</b>	
<b>Picture size</b>		<b>2M</b> (2M EZ): (1920×1080 pixels)	
<b>Quality</b>			
<b>Built-in Memory</b> (Approx. 27 MB)		25	48
<b>Card</b>	16 MB	12	25
	32 MB	27	53
	64 MB	57	105
	128 MB	115	220
	256 MB	230	430
	512 MB	450	860
	1 GB	910	1720
	2 GB	1800	3410
	4 GB	3540	6700

### ■ Available recording time (when recording motion pictures)

<b>Aspect ratio</b>		<b>4:3</b>				<b>16:9</b>	
<b>Picture quality setting</b>		<b>30fps VGA</b>	<b>10fps VGA</b>	<b>30fps QVGA</b>	<b>10fps QVGA</b>	<b>30fps 16:9</b>	<b>10fps 16:9</b>
<b>Built-in Memory</b> (Approx. 27 MB)		—	—	53 s	2 min 40 s	—	—
<b>Card</b>	16 MB	6 s	26 s	26 s	1 min 23 s	5 s	22 s
	32 MB	17 s	59 s	59 s	2 min 55 s	14 s	50 s
	64 MB	39 s	2 min	2 min	6 min	33 s	1 min 46 s
	128 MB	1 min 23 s	4 min 10 s	4 min 10 s	12 min 20 s	1 min 11 s	3 min 35 s
	256 MB	2 min 45 s	8 min 10 s	8 min 10 s	24 min	2 min 20 s	7 min
	512 MB	5 min 30 s	16 min 20 s	16 min 20 s	47 min 50 s	4 min 40 s	14 min
	1 GB	11 min	32 min 50 s	32 min 50 s	1 h 35 min	9 min 20 s	28 min 10 s
	2 GB	22 min 30 s	1 h 7 min	1 h 7 min	3 h 15 min	19 min 20 s	57 min 30 s
	4 GB*	44 min 20 s	2 h 11 min	2 h 11 min	6 h 22 min	38 min	1 h 53 min

\* Motion pictures can be recorded continuously up to 2 GB.

The maximum available recording time for up to 2 GB only is displayed on the screen.



- The number of recordable pictures and the available recording time displayed on the LCD monitor may not decrease in order.
- This unit does not support recording motion pictures on MultiMediaCards.
- The extended optical zoom does not work in [HIGH SENS.] (P49) in scene mode so the picture size for [EZ] is not displayed.

# Specifications

<b>Digital Camera:</b>	Information for your safety
<b>Power Source:</b>	DC 5.1 V
<b>Power Consumption:</b>	1.6 W (When recording) 0.8 W (When playing back)
<b>Camera effective pixels:</b>	7,200,000 pixels (DMC-FX12)/6,000,000 pixels (DMC-FX10)
<b>Image sensor:</b>	1/2.5" CCD, total pixel number 7,380,000 pixels (DMC-FX12)/ 6,370,000 pixels (DMC-FX10), Primary color filter
<b>Lens:</b>	Optical 3.0× zoom, f=5.8 mm to 17.4 mm (35 mm film camera equivalent: 35 mm to 105 mm)/F2.8 to F5.0
<b>Digital zoom:</b>	Max. 4×
<b>Extended optical zoom:</b>	Max. 4.5× (DMC-FX12)/4.1× (DMC-FX10)
<b>Focus:</b>	Normal/Macro, 5-area-focusing/1-area-focusing (High speed)/ 1-area-focusing
<b>Focus range:</b>	Normal: 50 cm (1.64 feet) to ∞ Macro/Simple/Intelligent ISO sensitivity mode/Motion picture: 5 cm (0.16 feet) (Wide)/30 cm (0.98 feet) (Tele) to ∞ Scene mode: There may be differences in the above settings.
<b>Shutter system:</b>	Electronic shutter+Mechanical shutter
<b>Motion picture recording:</b>	When the aspect ratio setting is [4:3] 640×480 pixels (Only when using a card)/320×240 pixels When the aspect ratio setting is [16:9] 848×480 pixels (Only when using a card) 30 or 10 frames/second with audio.
<b>Burst recording</b>	
<b>Burst speed:</b>	Changes depending on the type of card, picture size and quality
<b>Number of recordable pictures:</b>	Depends on the remaining capacity of the built-in memory or the card. (Performance in burst recording is only with SD Memory Card/ SDHC Memory Card. MultiMediaCard performance will be less.)
<b>ISO sensitivity:</b>	AUTO/ 100/200/400/800/1250 [HIGH SENS.] mode: 3200
<b>Shutter speed:</b>	8 seconds to 1/2000th of a second [STARRY SKY] mode: 15 seconds, 30 seconds, 60 seconds Motion picture mode: 1/30th of a second to 1/6400th of a second
<b>White balance:</b>	AUTO/Daylight/Cloudy/Shadow/Halogen/White set
<b>Exposure (AE):</b>	Program AE Exposure compensation (1/3 EV Step, -2 EV to +2 EV)
<b>Metering mode:</b>	Multiple
<b>LCD monitor:</b>	2.5" TFT LCD [Approx. 115,000 pixels] (field of view ratio about 100%)

<b>Flash:</b>	Flash range: [ISO AUTO] Approx. 30 cm (0.98 feet) to 5 m (16.4 feet) (Wide) AUTO, AUTO/Red-eye reduction, Forced ON (Forced ON/ Red-eye reduction), Forced OFF, (Slow sync./Red-eye reduction)
<b>Microphone:</b>	Monaural
<b>Speaker:</b>	Monaural
<b>Recording media:</b>	Built-in Memory (Approx. 27 MB)/ SD Memory Card/SDHC Memory Card/MultiMediaCard (Still pictures only)
<b>Picture size</b>	
<b>Still picture:</b>	When the aspect ratio setting is [4:3] 3072×2304 pixels (DMC-FX12), 2816×2112 pixels (DMC-FX10), 2560×1920 pixels (DMC-FX12), 2048×1536 pixels, 1600×1200 pixels, 1280×960 pixels, 640×480 pixels When the aspect ratio setting is [3:2] 3072×2048 pixels (DMC-FX12), 2816×1880 pixels (DMC-FX10), 2048×1360 pixels When the aspect ratio setting is [16:9] 3072×1728 pixels (DMC-FX12), 2816×1584 pixels (DMC-FX10), 1920×1080 pixels
<b>Motion pictures:</b>	When the aspect ratio setting is [4:3] 640×480 pixels (Only when using a card), 320×240 pixels When the aspect ratio setting is [16:9] 848×480 pixels (Only when using a card) Fine/Standard
<b>Quality:</b>	
<b>Recording file format</b>	
<b>Still Picture:</b>	JPEG (based on “Design rule for Camera File system”, based on “Exif 2.21” standard)/DPOF corresponding
<b>Motion pictures:</b>	“QuickTime Motion JPEG” (motion pictures with audio)
<b>Interface</b>	
<b>Digital:</b>	“USB 2.0” (Full Speed)
<b>Analog     video/audio:</b>	NTSC/PAL Composite (Switched by menu), Audio line output (monaural)
<b>Terminal</b>	
<b>[DIGITAL/AV OUT]:</b>	Dedicated jack (8 pin)
<b>[DC IN]:</b>	Dedicated jack

**Dimensions:** Approx. 94.1 mm (W)×51.4 mm (H)×24.2 mm (D)  
[3 11/16" (W)×2" (H)×15/16" (D)]  
(excluding the projecting part)

**Mass:** Approx. 125 g/4.41 oz (excluding card and battery),  
Approx. 153 g/5.40 oz (with card and battery)

**Operating temperature:** 0 °C to 40 °C (32 °F to 104 °F)  
**Operating humidity:** 10% to 80%

**Battery Charger**  
**(Panasonic DE-A41B):** Information for your safety

<b>Input:</b>	110 V to 240 V ~ 50/60 Hz, 0.2 A
<b>Output:</b>	CHARGE 4.2 V = 0.8 A





**Equipment mobility:** Movable

**Battery Pack (lithium-ion)**  
**(Panasonic CGA-S005A):** Information for your safety

<b>Voltage/capacity:</b>	3.7 V, 1150 mAh
--------------------------	-----------------

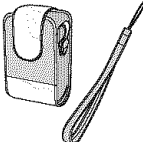

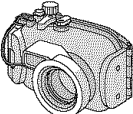
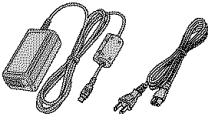
# Digital Camera Accessory System

Accessory#	Figure	Description
CGA-S005A		Battery Pack
DMW-CX12		Soft Case
DMW-CHFX30		Semi Hard Case
DMW-MCFX07		Marine Case
DMW-AC5PP		AC Adaptor
RP-SDR04GU1K RP-SDK02GU1A RP-SDR02GU1A RP-SDK01GU1A RP-SDH01GU1A RP-SDR01GU1A RP-SDK512U1A RP-SDR512U1A RP-SDH256U1A RP-SDR256U1A RP-SD128BU1A RP-SD064BPPA		4 GB SDHC Memory Card 2 GB SD Memory Card 2 GB SD Memory Card 1 GB SD Memory Card 1 GB SD Memory Card 1 GB SD Memory Card 512 MB SD Memory Card 512 MB SD Memory Card 256 MB SD Memory Card 256 MB SD Memory Card 128 MB SD Memory Card 64 MB SD Memory Card

- Refer to P12 for information about the battery charging time and the number of recordable pictures.
- NOTE: Accessories and/or model numbers may vary between countries. Consult your local dealer.

# Digital Camera Accessory Order Form

(For USA Customers)

Please photocopy this form when placing an order.

1. Digital Camera Model # \_\_\_\_\_

2. Items Ordered

Accessory #	Description	Price Each	Quantity	Total Price
Subtotal				
Your State & Local Sales Tax				
Shipping & Handling				6.95
Total Enclosed				

3. Method of payment (check one)

- Check of Money Order enclosed (NO C.O.D.SHIPMENTS)
- VISA                      Credit Card # \_\_\_\_\_
- MasterCard              Expiration Date \_\_\_\_\_
- Discover                    Customer Signature \_\_\_\_\_

Make Check or Money Order to: PANASONIC ACCESSORIES

(Please do not send cash)

4. Shipping information (UPS delivery requires complete street address)

Ship To:

Mr.

Mrs.

Ms.

First \_\_\_\_\_ Last \_\_\_\_\_

Phone#:

Day ( ) \_\_\_\_\_

Street Address \_\_\_\_\_

Night ( ) \_\_\_\_\_

City \_\_\_\_\_ State \_\_\_\_\_ Zip \_\_\_\_\_

TO OBTAIN ANY OF OUR DIGITAL CAMERA ACCESSORIES YOU CAN DO ANY OF  
THE FOLLOWING:

VISIT YOUR LOCAL PANASONIC DEALER

OR

CALL PANASONIC'S ACCESSORY ORDER LINE AT 1-800-332-5368

[6 AM-6 PM M-F, PACIFIC TIME]

OR

MAIL THIS ORDER TO: PANASONIC SERVICES COMPANY ACCESSORY ORDER OFFICE

20421 84th Avenue South Kent, WA. 98032

In CANADA, please contact your local Dealer for more information about accessories.

# Request for Service Notice (For USA Only)

---

---

Please photocopy this form when making a request for service notice.

In the unlikely event this product needs service.

## Request for Service Notice: (USA Only)

- Please include your **proof of purchase**.  
(Failure to do so will delay your repair.)
  - To further speed your repair, please provide an explanation of what wrong with the unit and any symptom it is exhibiting.
- 
- 
- 
- 

Mail this completed form and your Proof of Purchase along with your unit to:  
Panasonic Camera and Digital Service Center  
1590 Touhy Ave.  
Elk Grove Village, IL 60007

## Limited Warranty (For USA Only)

PANASONIC CONSUMER ELECTRONICS COMPANY, DIVISION OF  
PANASONIC CORPORATION OF NORTH AMERICA

One Panasonic Way, Secaucus, New Jersey 07094

PANASONIC PUERTO RICO, INC.

Ave. 65 de Infantería, Km. 9.5, San Gabriel Industrial Park, Carolina, Puerto Rico 00985

### Panasonic Digital Still Camera Limited Warranty

#### Limited Warranty Coverage

If your product does not work properly because of a defect in materials or workmanship, Panasonic Consumer Electronics Company or Panasonic Puerto Rico, Inc. (collectively referred to as “the warrantor”) will, for the length of the period indicated on the chart below, which starts with the date of original purchase (“warranty period”), at its option either (a) repair your product with new or refurbished parts, or (b) replace it with a new or refurbished product. The decision to repair or replace will be made by the warrantor.

PRODUCT OR PART NAME	PARTS	LABOR
<b>DIGITAL STILL CAMERA</b> (EXCEPT ITEMS LISTED BELOW)	<b>1 (ONE) YEAR</b>	<b>1 (ONE) YEAR</b>
<b>CCD</b>	<b>6 (SIX) MONTHS</b>	<b>90 (NINETY) DAYS</b>
<b>RECHARGEABLE BATTERY PACK</b> (IN EXCHANGE FOR DEFECTIVE BATTERY PACK)	<b>90 (NINETY) DAYS</b>	<b>NOT APPLICABLE</b>
<b>SD MEMORY CARD</b> (IN EXCHANGE FOR DEFECTIVE SD CARD)	<b>90 (NINETY) DAYS</b>	<b>NOT APPLICABLE</b>

During the “Labor” warranty period there will be no charge for labor. During the “Parts” warranty period, there will be no charge for parts. You must carry-in or mail-in your product during the warranty period. If non-rechargeable batteries are included, they are not warranted. This warranty only applies to products purchased and serviced in the United States or Puerto Rico. This warranty is extended only to the original purchaser of a new product which was not sold “as is”. A purchase receipt or other proof of the original purchase date is required for warranty service.

**Carry-In or Mail-In Service**

For Carry-In or Mail-In Service in the United States call  
1-800-272-7033.

For assistance in Puerto Rico call Panasonic Puerto Rico, Inc.  
(787)-750-4300 or fax (787)-768-2910.

This warranty ONLY COVERS failures due to defects in materials or workmanship, and DOES NOT COVER normal wear and tear or cosmetic damage. The warranty ALSO DOES NOT COVER damages which occurred in shipment, or failures which are caused by products not supplied by the warrantor, or failures which result from accidents, misuse, abuse, neglect, mishandling, misapplication, alteration, faulty installation, set-up adjustments, misadjustment of consumer controls, improper maintenance, power line surge, lightning damage, modification, or commercial use (such as in a hotel, office, restaurant, or other business), rental use of the product, service by anyone other than a Factory Service Center or other Authorized Servicer, or damage that is attributable to acts of God.

**THERE ARE NO EXPRESS WARRANTIES EXCEPT AS LISTED UNDER "LIMITED WARRANTY COVERAGE". THE WARRANTOR IS NOT LIABLE FOR INCIDENTAL OR CONSEQUENTIAL DAMAGES RESULTING FROM THE USE OF THIS PRODUCT, OR ARISING OUT OF ANY BREACH OF THIS WARRANTY.** (As examples, this excludes damages for lost time, travel to and from the servicer, loss of media or images, data or other memory content. The items listed are not exclusive, but are for illustration only.) **ALL EXPRESS AND IMPLIED WARRANTIES, INCLUDING THE WARRANTY OF MERCHANTABILITY, ARE LIMITED TO THE PERIOD OF THE LIMITED WARRANTY.**

Some states do not allow the exclusion or limitation of incidental or consequential damages, or limitations on how long an implied warranty lasts, so the exclusions may not apply to you.

This warranty gives you specific legal rights and you may also have other rights which vary from state to state. If a problem with this product develops during or after the warranty period, you may contact your dealer or Service Center. If the problem is not handled to your satisfaction, then write to the warrantor's Consumer Affairs Department at the addresses listed for the warrantor.

**PARTS AND SERVICE WHICH ARE NOT COVERED BY THIS LIMITED WARRANTY ARE YOUR RESPONSIBILITY.**

## Customer Services Directory (For USA Only)

For Product Information, Operating Assistance, Literature Request, Dealer Locations, and all Customer Service inquiries please contact:  
**1-800-272-7033, Monday-Friday 8:30am-8pm EST.**

Web Site: <http://www.panasonic.com/consumersupport>  
You can purchase parts, accessories or locate your nearest Service Center by visiting our Web Site.

### Accessory Purchases

Purchase Parts, Accessories and Instruction Books online for all Panasonic Products by visiting our Web Site at:

<http://www.pasc.panasonic.com>

or, send your request by E-mail to:

[npcparts@us.panasonic.com](mailto:npcparts@us.panasonic.com)

You may also contact us directly at:

1-800-332-5368 (Phone) 1-800-237-9080 (Fax Only)

(Monday - Friday 9 am to 9 pm, EST.)

Panasonic Services Company 20421 84th Avenue South, Kent, WA 98032

(We Accept Visa, MasterCard, Discover Card, American Express, and Personal Checks)

### Product Repairs

#### Centralized Factory Service Center

Panasonic Camera and Digital Service Center

MAIL TO :

1590 Touhy Ave.

Elk Grove Village, IL 60007

Please carefully pack and ship, prepaid and insured, to the Elk Grove Village Centralized Factory Service Center.

Customer's in Puerto Rico, please ship or carry in to location below ("Service in Puerto Rico").

#### Service in Puerto Rico

*Panasonic Puerto Rico, Inc.:*

*Ave. 65 de Infantería, Km. 9.5, San Gabriel Industrial Park,  
Carolina, Puerto Rico 00985*

*Phone (787) 750-4300 Fax (787) 768-2910*

As of November 2006

# Précautions à prendre

(pour le Canada)

## AVERTISSEMENT :

**POUR RÉDUIRE LES RISQUES D'INCENDIE, DE CHOC ÉLECTRIQUE OU DE DOMMAGES À L'APPAREIL,**

- **N'EXPOSEZ PAS CET APPAREIL À LA PLUIE, À L'HUMIDITÉ, À L'ÉGOUTTEMENT OU AUX ÉCLABOUSSEMENTS, ET NE PLACEZ SUR L'APPAREIL AUCUN OBJET REMPLI DE LIQUIDE, COMME PAR EXEMPLE DES VASES.**
- **UTILISEZ EXCLUSIVEMENT LES ACCESSOIRES RECOMMANDÉS.**
- **NE RETIREZ PAS LE COUVERCLE (OU LE PANNEAU ARRIÈRE) ; IL N'Y A AUCUNE PIÈCE RÉPARABLE PAR L'UTILISATEUR À L'INTÉRIEUR. CONFIEZ TOUTE RÉPARATION À UN TECHNICIEN DE SERVICE QUALIFIÉ.**

LA PRISE DE COURANT DOIT SE TROUVER À PROXIMITÉ DE L'APPAREIL ET ÊTRE FACILEMENT ACCESSIBLE.

## ATTENTION

Danger d'explosion si la batterie/pile n'est pas remplacée correctement. Remplacez-la uniquement par une batterie/pile identique ou du même type recommandée par le fabricant. Suivez les instructions du fabricant pour jeter les batteries usées.

## Avertissement

Risque d'incendie, d'explosion et de brûlures. Ne pas démonter, chauffer à plus de 60 °C (140 °F) ou incinérer.

La plaque signalétique se trouve sur le dessous de l'appareil.

- Assurez-vous d'utiliser un adaptateur secteur de marque Panasonic (DMW-AC5PP; en option).
- Assurez-vous d'utiliser une batterie de marque Panasonic (CGA-S005A).
- Si vous utilisez d'autres batteries, nous ne pouvons pas garantir la qualité de ce produit.
- N'utilisez pas d'autres câbles de connexion USB à l'exception de celui fourni.
- N'utilisez pas d'autres câbles AV à l'exception de celui fourni.
- Conservez la carte mémoire hors de portée des enfants afin qu'ils ne puissent pas l'avaler.

**Évitez d'approcher l'appareil photo de tout équipement magnétisé (four à micro-ondes, téléviseur, équipement de jeux vidéo, etc.).**

- Si vous utilisez l'appareil photo à proximité d'un téléviseur, les radiations électromagnétiques pourraient nuire au son et à l'image.
- N'utilisez pas l'appareil photo à proximité d'un téléphone cellulaire; cela pourrait entraîner un bruit nuisible à l'image et au son.
- Le puissant champ magnétique de haut-parleurs ou de moteurs peut endommager les données enregistrées sur support magnétique et distordre les images.
- Les ondes électromagnétiques émises par un microprocesseur peuvent nuire à l'appareil photo numérique et perturber l'image et le son.
- Advenant le cas où le fonctionnement de l'appareil serait dérangé par un champ magnétique, coupez le contact, retirez la batterie ou débranchez l'adaptateur secteur (modèle DMW-AC5PP; en option) pour ensuite soit remettre la batterie en place, soit rebrancher l'adaptateur. Remettez l'appareil en marche.

**N'utilisez pas l'appareil photo à proximité d'un émetteur radio ou de lignes à haute tension.**

- L'utilisation de l'appareil photo à proximité d'un émetteur radio ou de lignes à haute tension pourrait nuire à l'image ou au son.

■ **À propos du bloc-batterie**

**ATTENTION**

Batterie (batterie au lithium-ion)

- Utilisez l'unité spécifiée pour recharger la batterie.
  - N'utilisez la batterie avec aucun autre appareil que l'appareil spécifiée.
  - Évitez le contact des saletés, du sable, du liquide ou autres corps étrangers avec les bornes.
  - Ne touchez pas les bornes des fiches (+ et -) avec des objets métalliques.
  - Évitez de démonter, remodeler, chauffer ou jeter au feu.
- Si de l'électrolyte entre en contact avec vos mains ou vos vêtements, lavez-les avec beaucoup d'eau.
- Si de l'électrolyte pénètre dans vos yeux, ne les frottez pas.
- Rincez-vous les yeux avec beaucoup d'eau, puis consultez un médecin.

■ **À propos du chargeur de batterie**

**ATTENTION!**

**NE PAS INSTALLER CET APPAREIL DANS UNE BIBLIOTHÈQUE, UNE ARMOIRE OU TOUT AUTRE ESPACE CONFINÉ. S'ASSURER QUE LA VENTILATION DE L'APPAREIL EST ADÉQUATE. AFIN D'ÉVITER TOUT RISQUE DE CHOC ÉLECTRIQUE OU D'INCENDIE DÛ À UN SURCHAUFFEMENT, S'ASSURER QUE RIDEAUX OU TOUT OBJET QUELCONQUE NE BOUCHENT LES ÉVÉNEMENTS D'AÉRATION DE L'APPAREIL.**



# Index

## A

AC Adaptor .....	81, 83, 105
Access indication .....	21
Aerial Photo Mode .....	51
AF Assist Lamp .....	63
AF Lock .....	51
AF Mode .....	62
AF/AE Lock .....	23
Aspect Ratio .....	52, 60
Auto Review .....	18
Auto White Balance .....	59
AV Cable .....	87
Available Recording Time .....	101

## B

Baby Mode .....	48
Backlight Compensation .....	26
Battery .....	11, 12, 13
Battery Carrying Case .....	91
Beach Mode .....	50
Brightness of the LCD Monitor .....	19
Built-in Flash .....	35
Built-in Memory .....	14
Burst .....	63

## C

Calendar Playback .....	66
Candle Light Mode .....	48
Card .....	5, 13, 14
Charger .....	92
Charging .....	11
Clock Set .....	15, 18, 64
Color Mode .....	64
Condensation .....	5
Copy .....	79

## D

Date Printing .....	75, 85, 86
Date Stamp .....	72
Deleting Pictures .....	30
Dial Display .....	20
Digital Zoom .....	28
DPOF Print Setting .....	74

## E

Economy Mode .....	19
Exposure .....	23

Exposure Compensation .....	40
Extended Optical Zoom .....	26
EZ .....	26, 61

## F

File Number .....	20, 82
Fine .....	62
Fireworks Mode .....	50
Focus .....	23
Folder Composition .....	82
Folder Number .....	20, 82
Food Mode .....	47
Formatting .....	80

## G

Guide Line .....	32, 33
------------------	--------

## H

High Angle Mode .....	34
High Sensitivity Mode .....	49
Histogram .....	33

## I

Intelligent ISO Sensitivity Mode .....	42
ISO Sensitivity .....	60

## J

Jitter .....	24
Jitter/Movement Detection Demonstration .....	41

## L

Language Setting .....	20
Layout .....	86
LCD Monitor .....	21, 32, 88

## M

Macro Mode .....	43
MANUAL .....	70
Motion Picture Mode .....	52
Multi Playback .....	65

## N

Night Portrait Mode .....	46
Night Scenery Mode .....	47
Normal Picture Mode .....	22
NO.RESET .....	20, 82
NTSC .....	20
Number of Prints .....	75, 86
Number of Recordable Pictures .....	12, 99

<hr/>		
<b>O</b>		
<hr/>		
Operational Sound .....	19	
Optical Image Stabilizer .....	41	
Optical Zoom .....	26	
<hr/>		
<b>P</b>		
<hr/>		
PAL .....	20	
Paper Size .....	86	
Party Mode .....	47	
PC .....	81	
Pet Mode .....	49	
PictBridge .....	83	
Picture Quality Setting (Motion Picture Mode) .....	52	
Picture Quality Setting (Simple Mode) ...	25	
Picture Size .....	61	
Playback Pictures on TV .....	87	
Playback Zoom .....	67	
Playing Back Motion Pictures .....	68	
Portrait Mode .....	45	
Power LCD .....	34	
Power Save .....	18	
Print Mode .....	83	
Protect .....	76	
<hr/>		
<b>Q</b>		
<hr/>		
Quality .....	61	
Quick Setting .....	58	
<hr/>		
<b>R</b>		
<hr/>		
Reset of Setting .....	20	
Resizing .....	77	
Review .....	29	
Rotate .....	71	
Rotate Display .....	71	
<hr/>		
<b>S</b>		
<hr/>		
Scene Mode .....	44	
Scenery Mode .....	46	
Self Portrait Mode .....	46	
Self-timer .....	39	
Setting Favorites .....	70	
Setup Menu .....	18	
Shutter sound .....	19	
Simple Mode .....	24	
Slide Show .....	70	
Snow Mode .....	51	
Soft Skin Mode .....	45	
Speaker .....	20	
Sports Mode .....	46	
Standard .....	62	
<hr/>		
Starry Sky Mode .....		49
Status Indicator .....		19, 83, 86
Sunset Mode .....		49
<hr/>		
<b>T</b>		
<hr/>		
Thumbnail .....	30	
Travel Date .....	19, 54	
Trimming .....	78	
TV Aspect .....	20	
<hr/>		
<b>U</b>		
<hr/>		
Underwater Mode .....	51	
USB Connection Cable .....	81, 83	
<hr/>		
<b>V</b>		
<hr/>		
Video Output .....	20, 87	
Volume of Speakers .....	20	
<hr/>		
<b>W</b>		
<hr/>		
WB Adjust .....	51	
White Balance .....	59	
White Set .....	59	
World Time .....	19, 56	
<hr/>		
<b>Z</b>		
<hr/>		
Zoom .....	26	



QuickTime and the QuickTime logo are trademarks or registered trademarks of Apple Computer, Inc., used under license therefrom.

**Panasonic Consumer Electronics Company,  
Division of Panasonic Corporation of North America**

One Panasonic Way, Secaucus, NJ 07094

**Panasonic Puerto Rico, Inc.**

Ave. 65 de Infantería, Km. 9.5, San Gabriel Industrial Park, Carolina, Puerto Rico 00985

**Panasonic Canada Inc.**

5770 Ambler Drive, Mississauga, Ontario, L4W 2T3

© 2006 Matsushita Electric Industrial Co., Ltd.



VQT1C14

F1206Hy0 ( 30000 (A)

