



# Air Conditioners

*Safety Instructions* ..... 2, 3

***Operating Instructions***

Controls—Control Knobs ..... 6, 7

Controls—Touch Pads ..... 4, 5

***Care and Cleaning***

Air Filter ..... 8

Batteries ..... 8

Front Grille ..... 9

Grille and Case ..... 8

Outdoor Coils ..... 8

***Installation Instructions*** ... 10–13

***Troubleshooting Tips*** ..... 14

Normal Operating Sounds ..... 14

***Consumer Support***

Consumer Support ..... 18

Product Registration ..... 15, 16

Warranty ..... 17

***Owner's Manual and  
Installation Instructions***

ASF05

ASL05

ASM05

ASN05

ASQ05

ASV05

ASL06

ASN06

***Write the model and serial  
numbers here:***

***Model #*** \_\_\_\_\_

***Serial #*** \_\_\_\_\_

Find these numbers on a label on  
the side of the air conditioner.



# IMPORTANT SAFETY INFORMATION. READ ALL INSTRUCTIONS BEFORE USING.

## **⚠ WARNING!**

For your safety, the information in this manual must be followed to minimize the risk of fire, electric shock or personal injury.

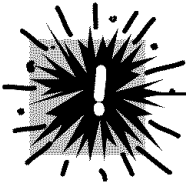

## SAFETY PRECAUTIONS

- Use this appliance only for its intended purpose as described in this Owner's Manual.
- This air conditioner must be properly installed in accordance with the Installation Instructions before it is used.
- Never unplug your air conditioner by pulling on the power cord. Always grip plug firmly and pull straight out from the receptacle.
- Replace immediately all electric service cords that have become frayed or otherwise damaged. Do not use a cord that shows cracks or abrasion damage along its length or at either the plug or connector end.
- Turn the mode control **OFF** and unplug your air conditioner before cleaning.
- GE does not support any servicing of the air conditioner. We strongly recommend that you do not attempt to service the air conditioner yourself.
- For your safety...do not store or use combustible materials, gasoline or other flammable vapors or liquids in the vicinity of this or any other appliance.
- All air conditioners contain refrigerants, which under federal law must be removed prior to product disposal. If you are getting rid of an old product with refrigerants, check with the company handling disposal about what to do.

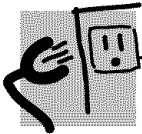

## HOW TO CONNECT ELECTRICITY

*Do not, under any circumstances, cut or remove the third (ground) prong from the power cord. For personal safety, this appliance must be properly grounded.*

The power cord of this appliance is equipped with a 3-prong (grounding) plug which mates with a standard 3-prong (grounding) wall outlet to minimize the possibility of electric shock hazard from this appliance.

Have the wall outlet and circuit checked by a qualified electrician to make sure the outlet is properly grounded.

Where a 2-prong wall outlet is encountered, it is your personal responsibility and obligation to have it replaced with a properly grounded 3-prong wall outlet.

The air conditioner should always be plugged into its own individual electrical outlet which has a voltage rating that matches the rating plate.

This provides the best performance and also prevents overloading house wiring circuits which could cause a fire hazard from overheated wires.

See the Installation Instructions, *Electrical Requirements* section for specific electrical connection requirements.

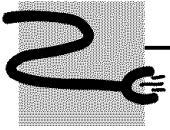
**⚠ WARNING!****USE OF EXTENSION CORDS—115-Volt models only**

*Because of potential safety hazards under certain conditions, we strongly recommend against the use of an extension cord.*

However, if you must use an extension cord, it is absolutely necessary that it be a UL-listed, 14 gauge, 3-wire grounding type appliance extension cord having a grounding type plug and outlet and that the electrical rating of the cord be 15 amperes (minimum) and 125 volts.

**⚠ CAUTION:**

**DO NOT use an extension cord with any of the 230/208 volt models.**

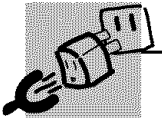
**USE OF ADAPTER PLUGS—115-Volt models only**

*Because of potential safety hazards under certain conditions, we strongly recommend against the use of an adapter plug.*

However, if you must use an adapter, where local codes permit, a **temporary connection** may be made to a properly grounded 2-prong wall outlet by use of a UL-listed adapter available at most local hardware stores.

The larger slot in the adapter must be aligned with the larger slot in the wall outlet to provide proper polarity in the connection of the power cord.

When disconnecting the power cord from the adapter, always hold the adapter in place with one hand while pulling the power cord plug with the other hand. If this is not done, the adapter ground terminal is very likely to break with repeated use.

If the adapter ground terminal breaks, **DO NOT USE** the air conditioner until a proper ground has been established.

*Attaching the adapter ground terminal to a wall outlet cover screw does not ground the appliance unless the cover screw is metal, and not insulated, and the wall outlet is grounded through the house wiring. You should have the circuit checked by a qualified electrician to make sure the outlet is properly grounded.*

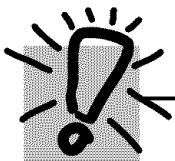

**READ AND FOLLOW THIS SAFETY INFORMATION CAREFULLY.**

**SAVE THESE INSTRUCTIONS**

# About the controls on the air conditioner—models with touch pads.

Features and appearance will vary.

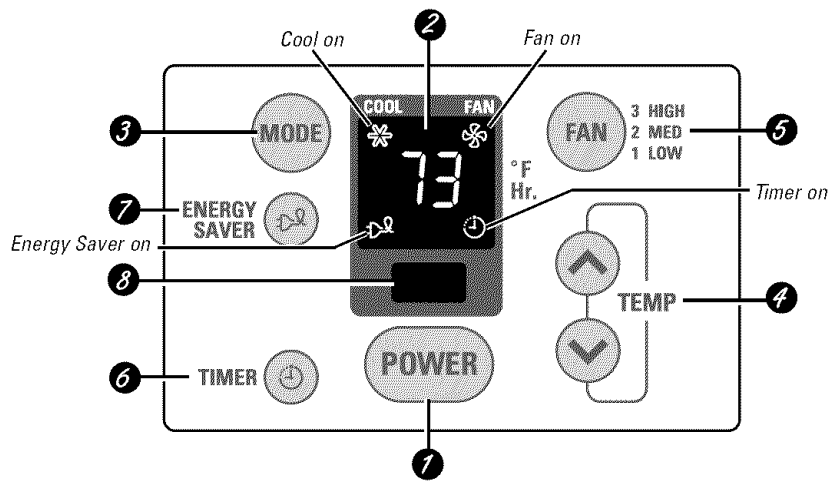

### Air Conditioner Controls

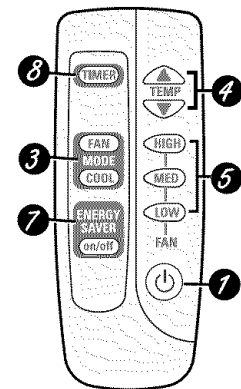

### Remote Control

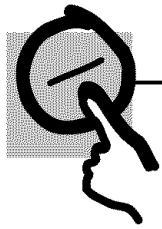

- 1 ON/OFF**  
Turns air conditioner on and off.
- 2 Display**  
Shows the set temperature, time remaining on timer or fan speed (1–LOW, 2–MED or 3–HIGH).
- 3 MODE**  
Use to set the air conditioner to **COOL** or **FAN** mode.
- 4 Increase ▲ /Decrease ▼ Pads**  
Use to set temperature when in **COOL** mode.
- 5 FAN**  
Use to set the fan speed to **LOW (1)**, **MED (2)** or **HIGH (3)**.
- 6 TIMER**  
**ON**—When the air conditioner is off, it can be set to automatically turn on in 1 to 12 hours at its previous setting. Each touch will set the time in hours.

**OFF**—When the air conditioner is on, it can be set to automatically turn off in 1 to 12 hours. Each touch will set the time in hours.

To cancel the timer, press the **TIMER** pad until the display time disappears.

- 7 ENERGY SAVER**—Controls the fan.  
**ON**—The fan and compressor cycle on and off. This results in wider variations of room temperature and humidity. Normally used when the room is unoccupied. **NOTE:** The fan will continue to run for a short time after the compressor cycles off.

**OFF**—The fan runs all the time, while the compressor cycles on and off.

This switch must be set at **OFF** in order to use the fan settings (on the mode control).

- 8 Remote Control Signal Receiver**

### Power Outage Recovery Feature

In the case of a power outage or interruption, the unit will automatically re-start in the settings last used after the power is restored. The **TIMER** feature

will reset to the original setting. You may need to set a new time if desired.

### Remote Control

- To ensure proper operation, aim the remote control at the signal receiver on the air conditioner.
- The remote control signal has a range of up to 21 feet.
- Make sure nothing is between the air conditioner and the remote control that could block the signal.
- Make sure batteries are fresh and installed correctly—see the *Care and Cleaning* section.

When the air conditioner is turned on, it will automatically start in the setting last used.

### COOL Mode

Use the **COOL** mode with **HIGH (3)**, **MED (2)** or **LOW (1)** fan for cooling. Use the **INCREASE ▲ / DECREASE ▼** pads to set the desired temperature between 64°F and 86°F in 1°F increments.

A thermostat is used to maintain the room temperature. The compressor will cycle on and off to keep the room at the set level of comfort. Set the thermostat at a lower number and the indoor air will become cooler. Set the thermostat at a higher number and the indoor air will become warmer.

**NOTE:** If the air conditioner is off and is then turned on while set to **COOL**, it will take approximately 3 minutes for the compressor to start and cooling to begin.

### Cooling Descriptions

**For Normal Cooling**—Select the **COOL** mode and **HIGH (3)** or **MED (2)** fan with a middle set temperature.

**For Maximum Cooling**—Select the **COOL** mode and **HIGH (3)** fan with a lower set temperature.

**For Quieter & Nighttime Cooling**—Select the **COOL** mode and **LOW (1)** fan with a middle set temperature.

**NOTE:** If you switch from a **COOL** setting to **OFF** or to a fan setting, wait at least 3 minutes before switching back to a **COOL** setting.

### FAN Mode

Use the **FAN** at **HIGH (3)**, **MED (2)** or **LOW (1)** to provide air circulation and filtering without cooling. Since fan only settings do not provide cooling, a temperature setting will not be displayed.

### Vent Control (on some models)

The vent control is located on the inside of the air louvers in the lower right corner.

When set at **CLOSE**, only the air inside the room will be circulated and conditioned. When set at **OPEN**, some inside air is exhausted outside.

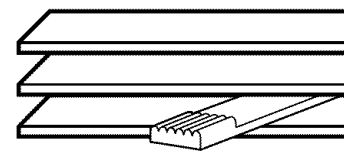

To open the vent, push the lever to the right.  
To close it, push it to the left.

### Air Direction—Up and Down (on some models)

Fingertip pressure on the horizontal louvers adjusts the air direction up or down.

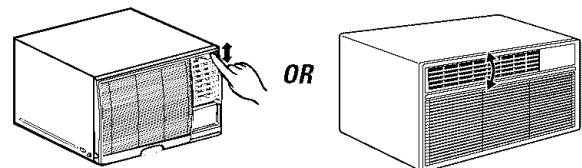

### Air Direction—Side-to-Side (on some models)

On some models, the side-to-side air direction is adjusted by the louver levers or by grasping and moving the inner vertical louvers.

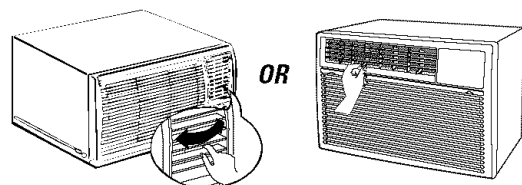

# About the controls on the air conditioner—models with control knobs.

Features and appearance will vary.

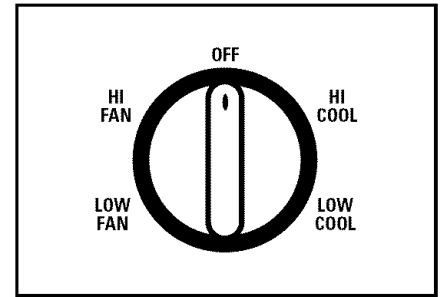
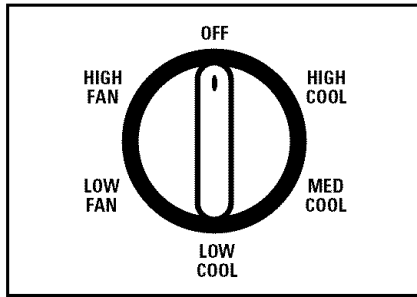
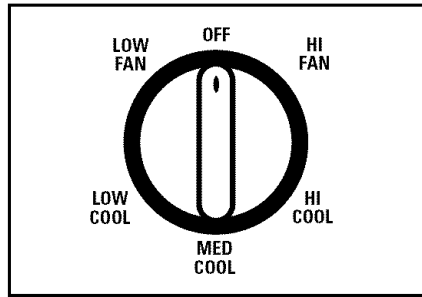

## 1 MODE CONTROLS

Your model will have one of the above type controls.

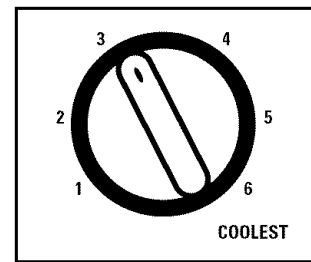
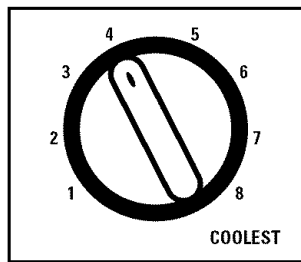
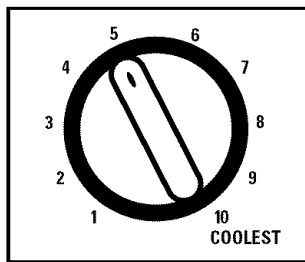

## 2 TEMP CONTROLS

Your model will have one of the above type controls.

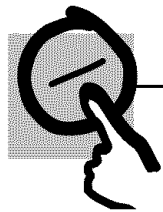

### Controls

- 1 **Mode Controls**  
**HIGH COOL**, **MED COOL** and **LOW COOL** provide cooling with different fan speeds.  
**LOW FAN** or **HIGH FAN** provides air circulation and filtering without cooling.

**NOTE:** If you move the switch from a cool setting to **OFF** or to a fan setting, wait at least 3 minutes before switching back to a cool setting.

#### Cooling Descriptions

**For Normal Cooling**—Select **HIGH COOL** or **MED COOL** with the temp control at midpoint.

**For Maximum Cooling**—Select **HIGH COOL** with the temp control at the highest number available on your knob.

**For Quieter & Nighttime Cooling**—Select **LOW COOL** with the temp control at midpoint.

- 2 **Temp Controls**  
 The temp control is used to maintain the room temperature. The compressor will cycle on and off to keep the room at the same level of comfort. When you turn the knob to a higher number, the indoor air will become cooler. Turn the knob to a lower number and the indoor air will become warmer.

Additional controls and important information.

**Vent Control** (on some models)

The vent control is located on the inside of the air louvers in the lower right corner.

When set at **CLOSE**, only the air inside the room will be circulated and conditioned. When set at **OPEN**, some inside air is exhausted outside.

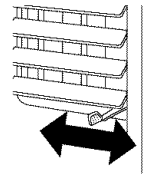

To open the vent, push the lever to the right.  
To close it, push it to the left.

**Air Direction—Side-to-Side**

On some models, the side-to-side air direction is adjusted by the louver levers or by grasping and moving the inner vertical louvers.

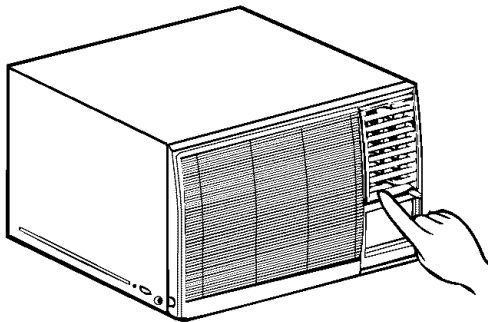

OR

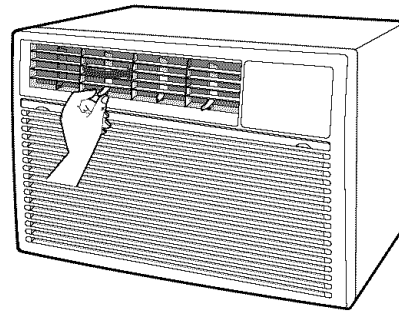

**Air Direction—Up and Down** (on some models)

Fingertip pressure on the horizontal louvers adjusts the air direction up or down.

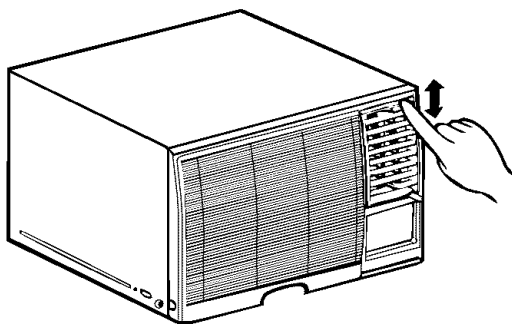

OR

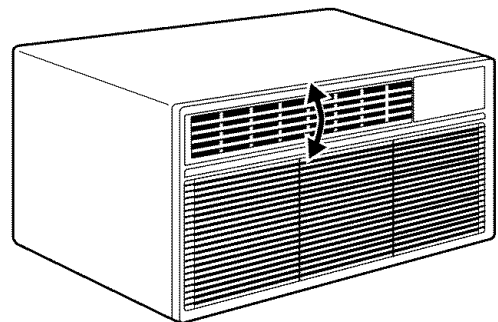

## Care and cleaning of the air conditioner.

### How to Insert the Batteries

- 1 Remove the battery cover by sliding it according to the arrow direction.
- 2 Insert new batteries making sure that the (+) and (-) of battery are installed correctly.
- 3 Reattach the cover by sliding it back into position.

### NOTES:

- Use 2 “AAA” (1.5 volt) batteries. Do not use rechargeable batteries.
- Remove the batteries from the remote control if the system is not going to be used for a long time.

### Grille and Case

Turn the air conditioner off and remove the plug from the wall outlet before cleaning.

To clean, use water and a mild detergent. Do not use bleach or abrasives.

### Outdoor Coils

The coils on the outdoor side of the air conditioner should be checked regularly. If they are clogged with dirt or soot, they may be professionally steam cleaned, a service available through your GE service outlet.

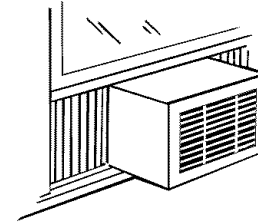

### Air Filter

The air filter behind the front grille should be checked and cleaned at least every 30 days or more often if necessary.

Clean the filter with warm, soapy water. Rinse and let the filter dry before replacing it.

**▲ CAUTION:** DO NOT operate the air conditioner without a filter because dirt and lint will clog it and reduce performance.

#### To remove (on some models):

- 1 Open the inlet grille upward by pulling out the bottom of the inlet grille.
- 2 Using the tab, pull up slightly on the filter to release it and pull it down.

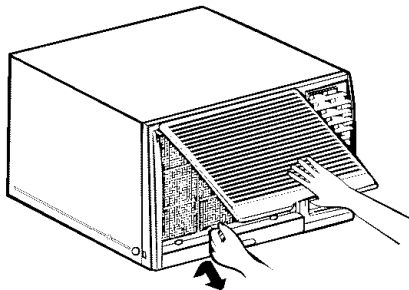

#### To remove (on some models):

- 1 Open the inlet grille downward by pulling out the upper corners of the inlet grille. Lift it up and off.
- 2 Grasp the filter at the top center and slide it out.

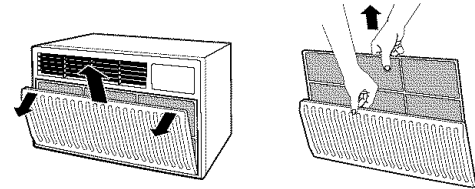

#### To remove (on some models):

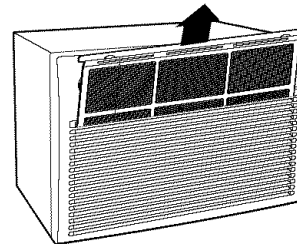

Grab the tabs on the filter and pull it up and out.

#### To remove (on some models):

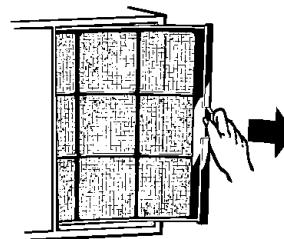

Grab the tab on the filter and pull it to the right.



### Front Grille and Case

Turn the air conditioner off and remove the plug from the wall outlet before cleaning.

To clean, use water and a mild detergent. Do not use bleach or abrasives.

#### To remove the front grille:

- A** On some models, remove the knobs and the screw behind the left knob.

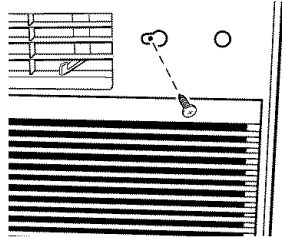

On some models, remove the knobs, filter and screw behind the filter bottom.

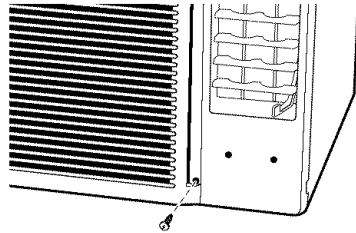

On some models, remove the bottom right grille screw.

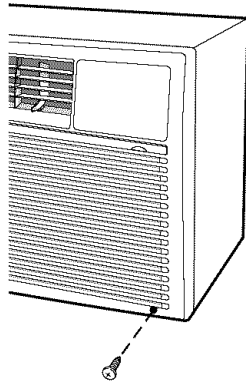

On some models, open the inlet grille from the sides and remove it. Remove the screw from the lower right corner if present.

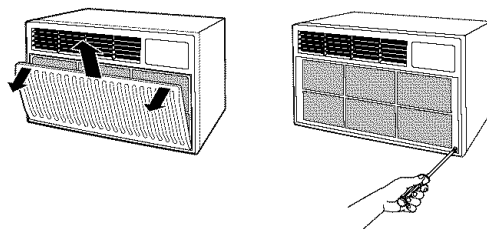

- B** Gently but firmly grasp the lower grille corners and pull forward to release.

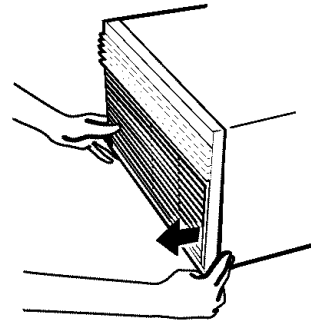

- C** Lift the top of the grille up and off to release from the tabs.

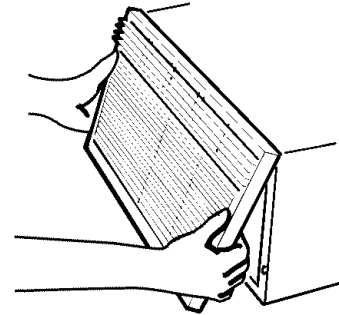

#### To replace the grille:

- A** Hook the front of the grille onto the tabs on the top of the case.
- B** Snap the bottom sides of the grille into the case slots.
- C** Replace the screw and attach the knobs.

# Installation Instructions

# Air Conditioner

? Questions? Call 800.GE.CARES (800.432.2737) or Visit our Website at: [www.GEAppliances.com](http://www.GEAppliances.com)



## BEFORE YOU BEGIN

Read these instructions completely and carefully.

- **IMPORTANT** — Save these instructions for local inspector's use.
- **IMPORTANT** — Observe all governing codes and ordinances.
- **Note to Installer** – Be sure to leave these instructions with the Consumer.
- **Note to Consumer** – Keep these instructions for future reference.
- **Skill level** – Installation of this appliance requires basic mechanical skills.
- **Completion time** – Approximately 1 hour
- We recommend that two people install this product.
- Proper installation is the responsibility of the installer.
- Product failure due to improper installation is not covered under the Warranty.

## ⚠ CAUTION:

Do not, under any circumstances, cut or remove the third (ground) prong from the power cord.

Do not change the plug on the power cord of this air conditioner.

Aluminum house wiring may present special problems—consult a qualified electrician.

## TOOLS YOU WILL NEED

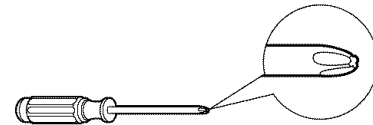

Phillips head screwdriver



Adjustable wrench

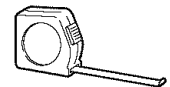

Ruler or tape measure



Pencil



Scissors or knife



Level



## ELECTRICAL REQUIREMENTS



Some models require a 115/120-volt a.c., 60 Hz grounded outlet protected with a 15-amp time delay fuse or circuit breaker.

The 3-prong grounding plug minimizes the possibility of electric shock hazard. If the wall outlet you plan to use is only a 2-prong outlet, it is your responsibility to have it replaced with a properly grounded 3-prong wall outlet.



Some models require 230/208-volt a.c., protected with a time delay fuse or circuit breaker. These models should be installed



on their own single branch circuit for best performance and to prevent overloading house or apartment wiring circuits, which could cause a possible fire hazard from overheating wires.

# Installation Instructions

## PARTS INCLUDED

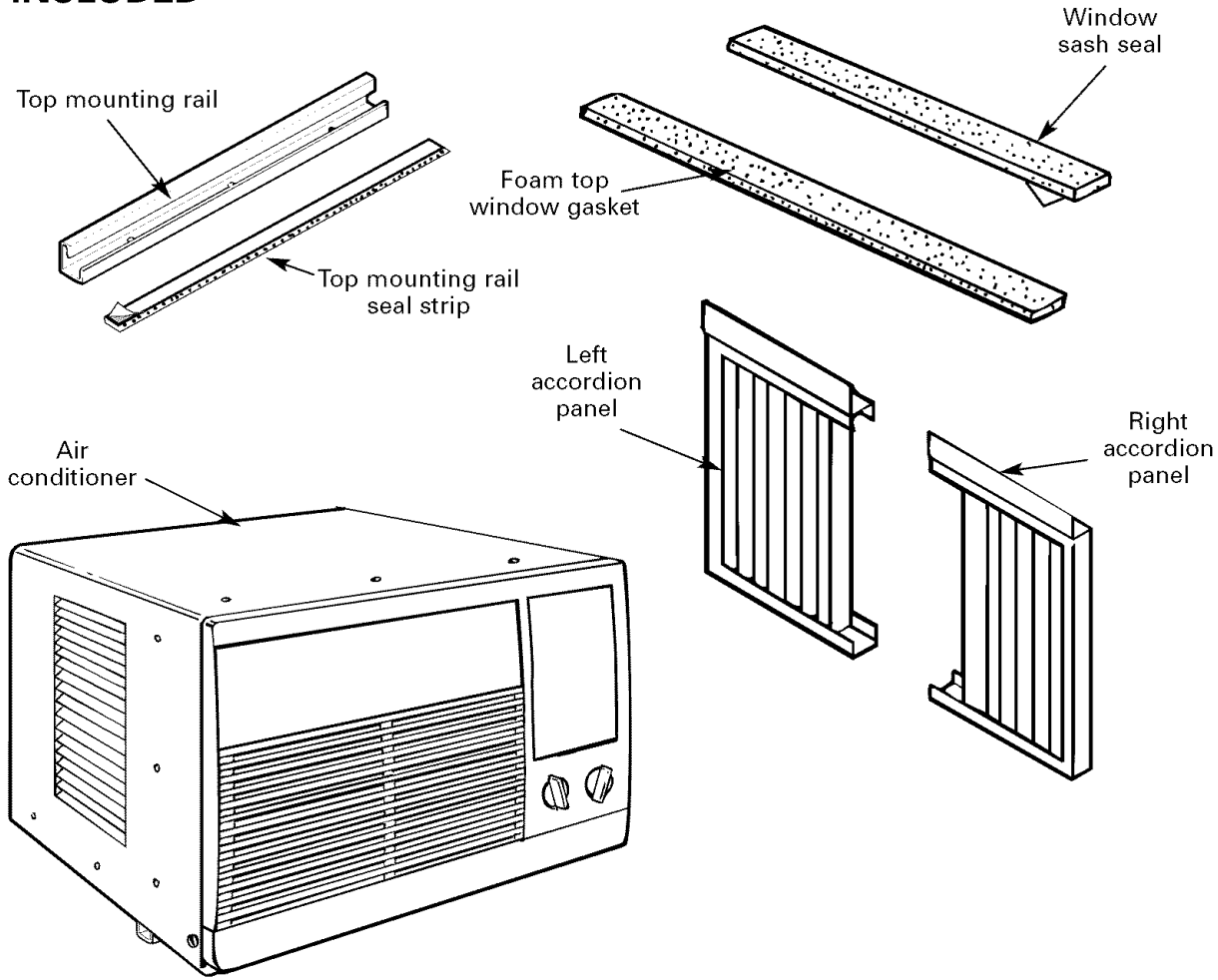

Type A (9)



Type B (8)

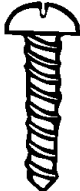

Security bracket (3)

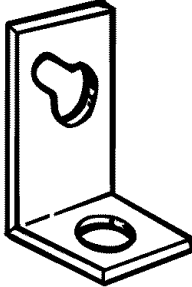

# Installation Instructions

## 1 WINDOW REQUIREMENTS

- These instructions are for a standard double-hung window. You will need to modify them for other types of windows.
- The air conditioner can be installed without the accordion panels if needed to fit in a narrow window. See the window opening dimensions.
- All supporting parts must be secured to firm wood, masonry or metal.
- The electrical outlet must be within reach of the power cord.

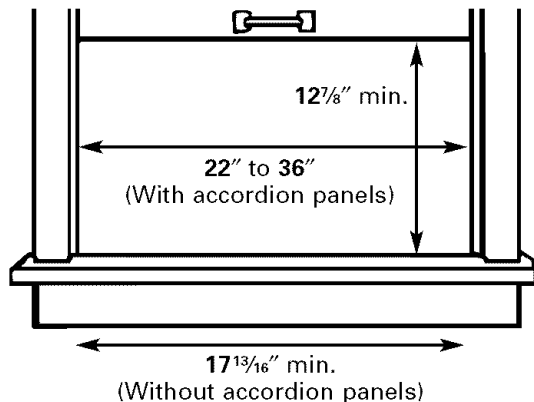

## 2 STORM WINDOW REQUIREMENTS

A storm window frame will not allow the air conditioner to tilt toward the outside, and will keep it from draining properly. To adjust for this, attach a piece of wood to the stool.

### WOOD PIECES—

**WIDTH:** 2"

**LENGTH:** Long enough to fit inside the window frame.

**THICKNESS:** To determine the thickness, place a piece of wood on the stool to make it  $\frac{1}{2}''$  higher than the top of the storm window frame.

Attach securely with nails or screws provided by the installer.

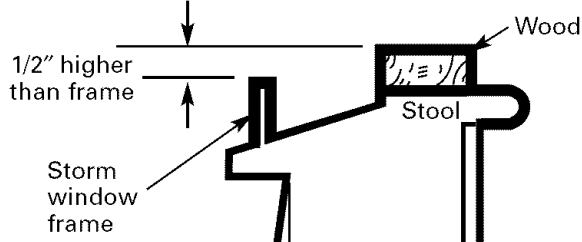

## 3 PREPARE AIR CONDITIONER

- A** Remove the backing from the top mounting rail seal strip and attach it to the bottom of the top mounting rail.

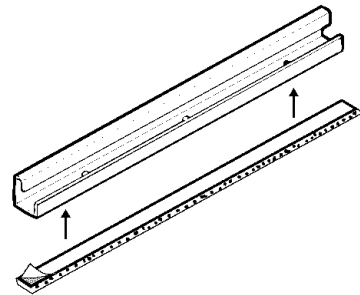

- B** Install the top mounting rail with 3 type A screws from the outside of the case.

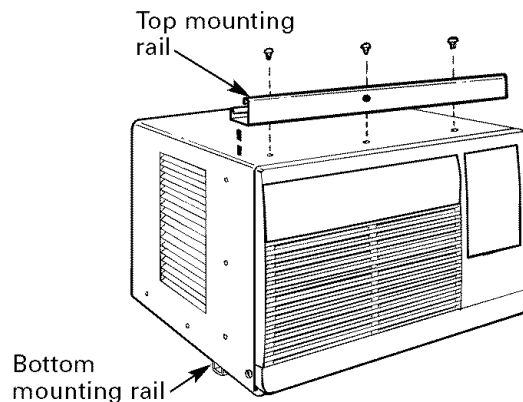

- C** Loosen the lower screw on each side of the case and hook a security bracket on each side. Tighten the screws to secure the brackets in place.

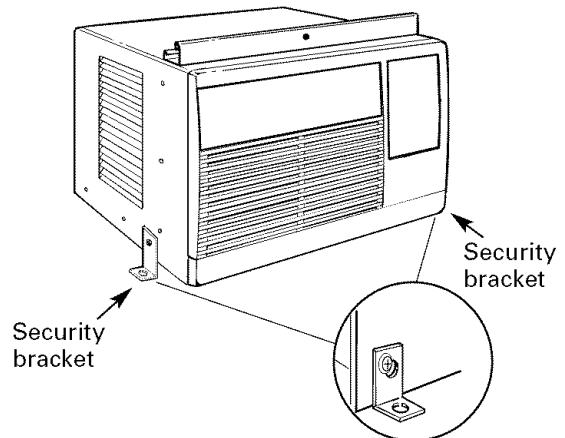

# Installation Instructions

## 3 PREPARE AIR CONDITIONER (CONT.)

- D** Insert the frames of the accordion panels into the top and bottom mounting rails. Attach the accordion panels to the side of the case using 6 type A screws.

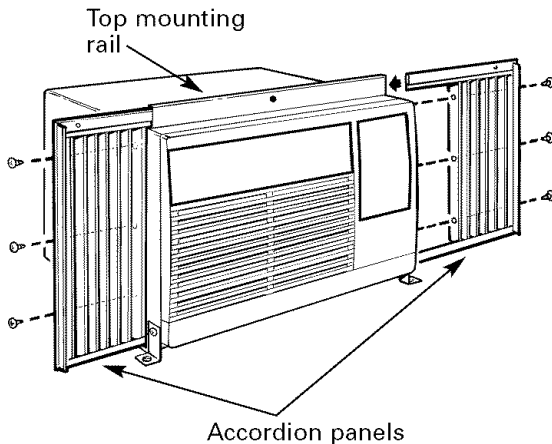

## 4 INSTALL AIR CONDITIONER IN WINDOW (CONT.)

- C** Extend the left and right accordion panels to the vertical window sashes and attach with 4 type B screws. Attach the top mounting rail to the sash with a type B screw.

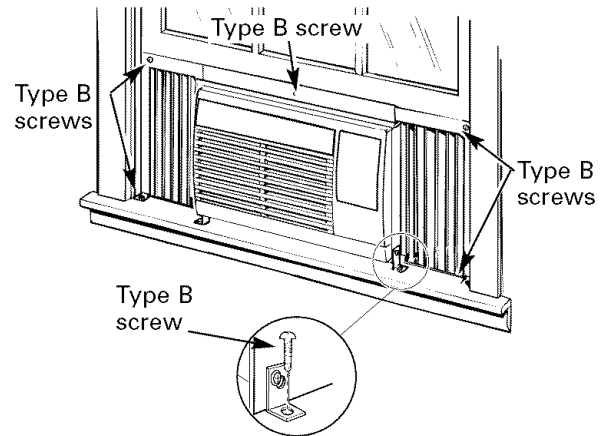

Attach the brackets to the stool on both sides using two type B screws.

## 4 INSTALL AIR CONDITIONER IN WINDOW

- A** Cut the window sash seal to the window width and stick the adhesive side to the bottom of the sash.

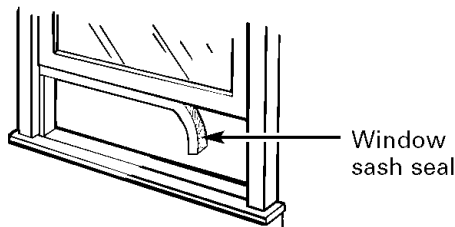

- B** Place the air conditioner on the stool with the bottom mounting rail against its back edge. Center it and close the window securely behind the top mounting rail. It should be level or slightly tilted to the outside. Use a level; about a 1/3 bubble will be the correct case slant to the outside.

## 5 INSTALL SECURITY BRACKET AND FOAM TOP WINDOW GASKET

- A** Attach a security bracket with a type B screw.

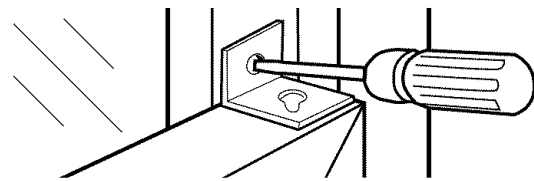

- B** Cut the foam top window gasket to the window width.
- C** Stuff the foam between the glass and the window to prevent air and insects from getting into the room.

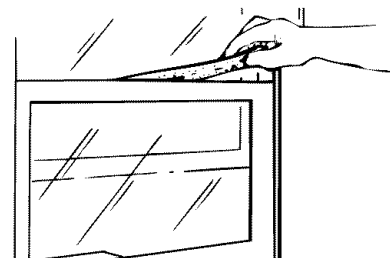

The installation is now complete.

## Troubleshooting Tips...

Troubleshooting Tips: Save time and money!

Problem	Possible Causes	What To Do
<b>Air conditioner does not start</b>	The air conditioner is unplugged.	• Make sure the air conditioner plug is pushed completely into the outlet.
	The fuse is blown/circuit breaker is tripped.	• Check the house fuse/circuit breaker box and replace the fuse or reset the breaker.
	Power failure.	• If power failure occurs, turn the air conditioner <b>OFF</b> . When power is restored, wait 3 minutes to restart the air conditioner to prevent tripping of the compressor overload.
<b>Air conditioner does not cool as it should</b>	Airflow is restricted.	• Make sure there are no curtains, blinds or furniture blocking the front of the air conditioner.
	The temp control may not be set correctly.	• On models with touch pads: In <b>COOL</b> mode, press the <b>DECREASE ▼</b> pad. • On models with control knobs, turn the temperature knob to a higher number.
	The air filter is dirty.	• Clean the filter at least every 30 days. See the <i>Operating Instructions</i> section.
	The room may have been hot.	• When the air conditioner is first turned on, you need to allow time for the room to cool down.
	Cold air is escaping.	• Check for open furnace registers and cold air returns. • Set the air conditioner's vent to the closed position.
<b>Air conditioner freezing up</b>	Cooling coils have iced up.	• See " <b>Air conditioner freezing up</b> " below.
<b>The remote control is not working</b>	Ice blocks the air flow and stops the air conditioner from cooling the room.	• On models with control knobs, set the mode control at <b>HIGH FAN</b> or <b>HIGH COOL</b> with the temp at <b>1</b> or <b>2</b> . • On models with touch pads, set the controls at <b>HIGH FAN</b> or <b>HIGH COOL</b> and set the thermostat to a higher temperature.
	The batteries are inserted incorrectly.	• Check the position of the batteries. They should be inserted in the opposite (+) and (-) direction.
<b>Water drips outside</b>	The batteries may be dead.	• Replace the batteries.
	Hot, humid weather.	• This is normal.
<b>Water drips indoors</b>	The air conditioner is not tilted to the outside.	• For proper water disposal, make sure the air conditioner slants slightly from the case front to the rear.
<b>Water collects in base pan</b>	Moisture removed from air and drains into base pan.	• This is normal for a short period in areas with little humidity; normal for a longer period in very humid areas.
<b>"E1" appears in the display</b>	Function error code.	• Unplug the air conditioner. Wait 3 minutes and plug it back in.
<b>TIMER feature not working properly</b>	A power outage or interruption occurred.	• In the case of a power outage or interruption, the unit <b>TIMER</b> feature will reset to the original setting. You may need to set a new time if desired.

### Normal Operating Sounds

- You may hear a pinging noise caused by water being picked up and thrown against the condenser on rainy days or when the humidity is high. This design feature helps remove moisture and improve efficiency.
- You may hear the thermostat click when the compressor cycles on and off.
- Water will collect in the base pan during high humidity or on rainy days. The water may overflow and drip from the outdoor side of the unit.
- The fan may run even when the compressor does not.

## GE Service Protection Plus™

GE, a name recognized worldwide for quality and dependability, offers you Service Protection Plus™—comprehensive protection on all your appliances—**No Matter What Brand!**

**Benefits Include:**

- Backed by GE
- All brands covered
- Unlimited service calls
- All parts and labor costs included
- No out-of-pocket expenses
- No hidden deductibles
- One 800 number to call

***We'll Cover Any Appliance.  
Anywhere. Anytime.\****

You will be completely satisfied with our service protection or you may request your money back on the remaining value of your contract. No questions asked. It's that simple.

Protect your refrigerator, dishwasher, washer and dryer, range, TV, VCR and much more—**any brand!** Plus there's no extra charge for emergency service and low monthly financing is available. Even icemaker coverage and food spoilage protection is offered. You can rest easy, knowing that all your valuable household products are protected against expensive repairs.

Place your confidence in GE and call us in the U.S. toll-free at **800.626.2224** for more information.

\*All brands covered, up to 20 years old, in the continental U.S.

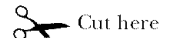

Please place in envelope and mail to:

***General Electric Company***  
**Warranty Registration Department**  
**P.O. Box 32150**  
**Louisville, KY 40232-2150**

# Consumer Product Ownership Registration

Dear Customer:

Thank you for purchasing our product and thank you for placing your confidence in us. We are proud to have you as a customer!

Follow these three steps to protect your new appliance investment:

# 1

Complete and mail your Consumer Product Ownership Registration today. Have the peace of mind of knowing we can contact you in the unlikely event of a safety modification.

# 2

After mailing the registration below, store this document in a safe place. It contains information you will need should you require service. Our service number is 800.GE.CARES (800.432.2737).

# 3

Read your Owner's Manual carefully. It will help you operate your new appliance properly.

Model Number

Serial Number

**Important: If you did not get a registration card with your product, detach and return the form below to ensure that your product is registered, or register online at [www.GEAppliances.com](http://www.GEAppliances.com).**

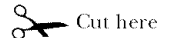

# Consumer Product Ownership Registration



Model Number

Serial Number

Mr.  Ms.  Mrs.  Miss

First Name

Last Name

Street Address

Apt. #

E-mail Address\*

City

State

Zip Code

Date Placed In Use  
Month

Day

Year

Phone Number --

\* Please provide your e-mail address to receive, via e-mail, discounts, special offers and other important communications from GE Appliances (GEA).

Check here if you do not want to receive communications from GEA's carefully selected partners.

**FAILURE TO COMPLETE AND RETURN THIS CARD DOES NOT DIMINISH YOUR WARRANTY RIGHTS.**

For information about GEA's privacy and data usage policy, go to [www.GEAppliances.com](http://www.GEAppliances.com) and click on "Privacy Policy" or call 800.626.2224.



**GE Appliances**

GE Consumer Products  
General Electric Company  
Louisville, Kentucky  
[www.GEAppliances.com](http://www.GEAppliances.com)



# Air Conditioner Warranty.



All warranty service provided by our Factory Service Centers, or an authorized Customer Care® technician. To schedule service, on-line, 24 hours a day, visit us at [www.GEAppliances.com](http://www.GEAppliances.com), or call 800.GE.CARES (800.432.2737).

Staple your receipt here.  
Proof of the original purchase date is needed to obtain service under the warranty.

## For The Period Of: We Will Replace:

### One Year

From the date of the original purchase

**Any part** of the air conditioner which fails due to a defect in materials or workmanship. During this **full one-year warranty**, we will also provide, **free of charge**, all labor and in-home service to replace the defective part.

### Five Years

From the date of the original purchase

**Any part of the sealed refrigerating system** (the compressor, condenser, evaporator and all connecting tubing) which fails due to a defect in materials or workmanship. During this **four-year additional warranty**, we will also provide, **free of charge**, all labor and in-home service to replace the defective part.

## What Is Not Covered:

- Service trips to your home to teach you how to use the product.
- Improper installation, delivery or maintenance. If you have an installation problem, or if the air conditioner is of improper cooling capacity for the intended use, contact your dealer or installer. You are responsible for providing adequate electrical connecting facilities.
- Failure of the product resulting from modifications to the product or due to unreasonable use including failure to provide reasonable and necessary maintenance.
- In commercial locations labor necessary to move the unit to a location where it is accessible for service by an individual technician.
- Replacement of house fuses or resetting of circuit breakers.
- Failure due to corrosion on models not corrosion-protected.
- Damage to the product caused by improper power supply voltage, accident, fire, floods or acts of God.
- Incidental or consequential damage caused by possible defects with this air conditioner.
- Damage caused after delivery.

*This warranty is extended to the original purchaser and any succeeding owner for products purchased for home use within the USA. In Alaska, the warranty excludes the cost of shipping or service calls to your home.*

*Some states do not allow the exclusion or limitation of incidental or consequential damages. This warranty gives you specific legal rights, and you may also have other rights which vary from state to state. To know what your legal rights are, consult your local or state consumer affairs office or your state's Attorney General.*

**Warrantor: General Electric Company, Louisville, KY 40225**

Safety Instructions

Operating Instructions

Installation Instructions

Troubleshooting Tips

Consumer Support

## Consumer Support

---



### *GE Appliances Website*

[www.GEAppliances.com](http://www.GEAppliances.com)

Have a question or need assistance with your appliance? Try the GE Appliances Website 24 hours a day, any day of the year! For greater convenience and faster service, you can now download Owner's Manuals, order parts, catalogs, or even schedule service on-line. You can also "Ask Our Team of Experts™" your questions, and so much more...

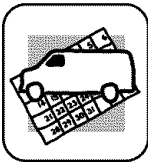

### *Schedule Service*

[www.GEAppliances.com](http://www.GEAppliances.com)

Expert GE repair service is only one step away from your door. Get on-line and schedule your service at your convenience 24 hours any day of the year! Or call 800.GE.CARES (800.432.2737) during normal business hours.

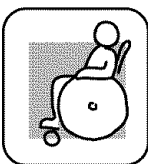

### *Real Life Design Studio*

[www.GEAppliances.com](http://www.GEAppliances.com)

GE supports the Universal Design concept—products, services and environments that can be used by people of all ages, sizes and capabilities. We recognize the need to design for a wide range of physical and mental abilities and impairments. For details of GE's Universal Design applications, including kitchen design ideas for people with disabilities, check out our Website today. For the hearing impaired, please call 800.TDD.GEAC (800.833.4322).



### *Extended Warranties*

[www.GEAppliances.com](http://www.GEAppliances.com)

Purchase a GE extended warranty and learn about special discounts that are available while your warranty is still in effect. You can purchase it on-line anytime, or call 800.626.2224 during normal business hours. GE Consumer Home Services will still be there after your warranty expires.

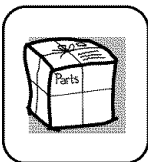

### *Parts and Accessories*

[www.GEAppliances.com](http://www.GEAppliances.com)

Individuals qualified to service their own appliances can have parts or accessories sent directly to their homes (VISA, MasterCard and Discover cards are accepted). Order on-line today, 24 hours every day or by phone at 800.626.2002 during normal business hours.

***Instructions contained in this manual cover procedures to be performed by any user. Other servicing generally should be referred to qualified service personnel. Caution must be exercised, since improper servicing may cause unsafe operation.***



### *Contact Us*

[www.GEAppliances.com](http://www.GEAppliances.com)

If you are not satisfied with the service you receive from GE, contact us on our Website with all the details including your phone number, or write to: General Manager, Customer Relations  
GE Appliances, Appliance Park  
Louisville, KY 40225



### *Register Your Appliance*

[www.GEAppliances.com](http://www.GEAppliances.com)

Register your new appliance on-line—at your convenience! Timely product registration will allow for enhanced communication and prompt service under the terms of your warranty, should the need arise. You may also mail in the pre-printed registration card included in the packing material.