

SHARP

C431 WJ

COLOR TELEVISION

MODEL
32SC26B

OPERATION MANUAL

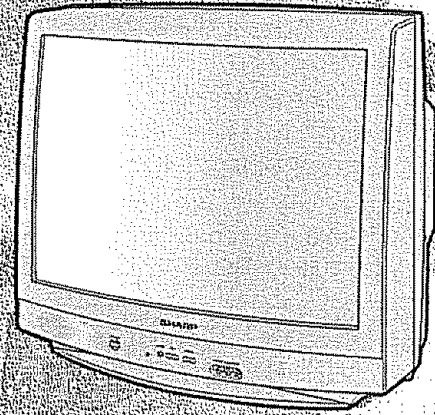

Products that have earned the ENERGY STAR® are designed to protect the environment through superior energy efficiency.

CONTENTS

| | PAGE | | PAGE |
|---------------------------------------------------------------|-------|---------------------------------------------------|-------|
| • IMPORTANT INFORMATION/IMPORTANT SAFEGUARDS | 2-4 | • Closed Caption | 18-19 |
| • Trademarks | 5 | • Parent Control | 20-30 |
| • Supplied Accessories | 5 | • V-CHIP Operation | 20-27 |
| • Before Operating Your Television | 5 | • VIEW TIMER | 28-30 |
| • Antenna Connections | 6-7 | • Energy Save | 31 |
| • Quick Reference Control Operation | 8 | • Set Up | 32-36 |
| • EZ SETUP during First Use | 9-10 | • EZ Setup | 32-33 |
| • Antenna Setup DIGITAL | 10-11 | • Channel Setting | 33-35 |
| • Accessing the MAIN MENU screen without Remote Control | 11 | • Blue Screen | 36 |
| • Channel Call | 11 | • Auto Input | 37 |
| • Changing Viewing Channel | 12 | • Screen Format | 38-39 |
| • Language | 13 | • Using the Video and Audio Input Terminals | 40-41 |
| • Sleep Timer | 13 | • Using the Audio Output Terminals | 42 |
| • Video Adjust | 14 | • Before Calling for Service | 43 |
| • Audio Select | 15-16 | • Calling for Service | 43 |
| • MTS (Multichannel TV Sound) | 15 | • Warning message for Digital broadcasting | 44 |
| • SPEAKER (Internal Speaker Switch) | 15 | • Specifications | 44 |
| • FAO (Fixed Audio Output) | 15 | • Limited Warranty | 54 |
| • AUDIO ADJUST | 16 | | |
| • Digital Audio | 17 | | |

This operation manual includes basic operating instructions in Spanish and French.
SPANISH is on page 45-49
FRENCH is on page 50-54.

DOLBY
DIGITAL

SDTV
STANDARD DEFINITION TELEVISION

Welcome to the SHARP Family. We are pleased that you are now the owner of a SHARP Color Television – built for outstanding quality, reliability and performance.

Every SHARP Color Television set is tuned and adjusted for proper color and sound, and has passed through the most stringent quality control tests at the factory. We have prepared this OPERATION MANUAL so that you may adjust the picture and color to your personal viewing preference.

We sincerely hope that you receive the greatest satisfaction and enjoyment from your new SHARP Color Television set for years to come.

Please read these instructions carefully, and keep them handy for your future reference.

IMPORTANT

To aid reporting in case of loss or theft, please record the TV's model and serial numbers in the space provided. The numbers are located at the rear of the TV.

Model No.:

Serial No.:

IMPORTANT INFORMATION

There are two important reasons for prompt warranty registration of your new SHARP television set. Use the REGISTRATION CARD packed in with the set.



FIRST – WARRANTY

This is to assure that you will immediately receive the full consumer benefit of the parts, service and labor warranty applicable to your purchase.

SECOND – CONSUMER PRODUCT SAFETY ACT

To assure that you will promptly receive any safety notification on inspection, modification or recall that SHARP may be required to give under the 1972 Consumer Product Safety Act. PLEASE READ CAREFULLY THE IMPORTANT "LIMITED WARRANTY" CLAUSE ON THE LAST PAGE.

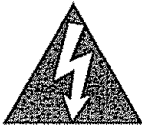
WARNING: TO REDUCE THE RISK OF FIRE OR ELECTRIC SHOCK, DO NOT EXPOSE THIS APPLIANCE TO WET LOCATIONS.

| | | |
|------------------------------------------------------------------------------------------------------------------------------------------------------------------------|---------------------------------------------------------|--------------------------------------------------------------------------------------|
|  | CAUTION RISK OF ELECTRIC SHOCK DO NOT OPEN |  |
| CAUTION: TO REDUCE THE RISK OF ELECTRIC SHOCK, DO NOT REMOVE COVER (OR BACK). NO USER-SERVICEABLE PARTS INSIDE. REFER SERVICING TO QUALIFIED SERVICE PERSONNEL. | | |



The lightning flash with arrowhead within a triangle is intended to tell the user that parts inside the product are a risk of electric shock to persons.



The exclamation point within a triangle is intended to tell the user that important operating and servicing instructions are in the papers with the appliance.

"Note to CATV system installer: This reminder is provided to call the CATV system installer's attention to Article 820-40 of the National Electrical Code that provides guidelines for proper grounding and, in particular, specifies that the cable ground shall be connected to the grounding system of the building, as close to the point of cable entry as practical."

WARNING – FCC Regulations state that any unauthorized changes or modifications to this equipment not expressly approved by the manufacturer could void the user's authority to operate this

PRODUCT DISPOSAL

This product utilizes a Cathode Ray Tube (CRT) containing lead and tin-lead solder.

Disposal of these materials may be regulated due to environment considerations. For disposal or recycling information, please contact your local authorities or the Electronics Industries Alliance: www.eiae.org

IMPORTANT INFORMATION (Continued)

CAUTION:

- Do not place the AC power cord under the TV set or other heavy items.
- To prevent fire, never place any type of candle or naked flames on the top or near the TV set.
- To prevent fire or shock hazard, do not expose this products to dripping or splashing. No objects filled with liquids, such as vases, should be placed on the product.

IMPORTANT SAFEGUARDS

CAUTION: Please read all of these instructions before you operate your television and save these instructions for later use.

Electrical energy can perform many useful functions. This unit has been engineered and manufactured to assure your personal safety BUT IMPROPER USE CAN RESULT IN POTENTIAL ELECTRICAL SHOCK OR FIRE HAZARDS. In order not to defeat the safeguards incorporated in this equipment, observe the following basic rules for its installation, use and servicing.

1. Unplug this television equipment from the wall outlet before cleaning.
2. Do not use liquid cleaners or aerosol cleaners. Use a damp cloth for cleaning.
3. Do not use attachments not recommended by the television equipment manufacturer as they may cause hazards.
4. Do not use this television equipment near water — for example, near a bath tub, washbowl, kitchen sink or laundry tub, in a wet basement, or near a swimming pool, etc.
5. Do not place this equipment on an unstable cart, stand, or table. The television equipment may fall, causing serious injury to a child or an adult, and serious damage to the equipment. Use only with a cart or stand recommended by the manufacturer or sold with the television equipment.
6. Television equipment and cart combination should be moved with care. Quick stops, excessive force, and uneven surfaces may cause the equipment and cart combination to overturn.
7. Wall or shelf mounting should follow the manufacturer's instructions, and should use a mounting kit approved by the manufacturer.
8. Slots and openings in the cabinet and the back or bottom are provided for ventilation. To insure reliable operation of the television equipment and to protect it from overheating, these openings must not be blocked or covered. This television equipment should not be placed in a built-in insulation such as a bookcase unless proper ventilation is provided.
9. The openings should never be covered with a cloth or other material, and the bottom openings should not be blocked by placing the television equipment on a bed, sofa, rug, or other similar surface. This television equipment should never be placed near or over a radiator or heat register.
10. This television equipment should be operated only from the type of power source indicated on the marking label. If you are not sure of the type of power supplied to your home, consult your television dealer or local power company.



For television equipment designed to operate from battery power, refer to the operating instructions.

11. As a safety feature, television equipment is equipped with a 2-wire polarized plug (one plug blade bigger than the other). The 2-wire polarized plug will fit only one way into the power outlet.
If the plug does not fit, ask your electrician to replace your obsolete outlet. Do not modify the plug and defeat this safety feature.
12. Do not allow anything to rest on the power cord. Do not locate this television equipment where the cord will be abused by persons walking on it.

IMPORTANT SAFEGUARDS (Continued)

13. Follow all warnings and instructions marked on the television equipment.
14. If an outside antenna is connected to the television equipment, be sure the antenna system is grounded so as to provide some protection against voltage surges and built-up static charges. Section 810 of the National Electrical Code provides information with respect to proper grounding of the mast and supporting structure, grounding of the lead-in wire to an antenna discharge unit, size of grounding conductors, location of antenna-discharge unit, connection to grounding electrodes, and requirements for the grounding electrode.

EXAMPLE OF ANTENNA GROUNDING AS PER
NATIONAL ELECTRICAL CODE

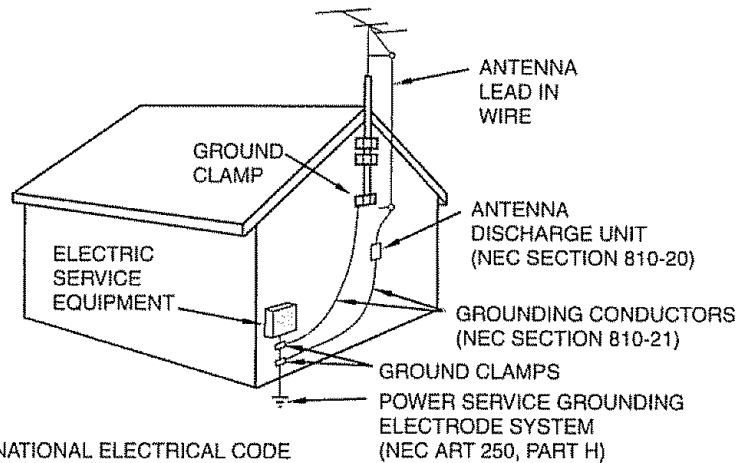

15. For added protection for this television equipment during a lightning storm, or when it is left unattended and unused for long periods of time, unplug it from the wall outlet and disconnect the antenna. This will prevent damage to the equipment due to lightning and power-line surges.
16. An outside antenna system should not be located in the vicinity of overhead power lines or other electric light or power circuits, or where it can fall into such power lines or circuits. When installing an outside antenna system, extreme care should be taken to keep from touching such power lines or circuits as contact with them might be fatal.
17. Do not overload wall outlets and extension cords as this can result in fire or electric shock.
18. Never push objects of any kind into this television equipment through cabinet slots as they may touch dangerous voltage points or short out parts that could result in a fire or electric shock. Never spill liquid of any kind on the television equipment.
19. Do not attempt to service this television equipment yourself as opening or removing covers may expose you to dangerous voltage or other hazards. Refer all servicing to qualified service personnel.
20. Unplug this television equipment from the wall outlet and refer servicing to qualified service personnel under the following conditions:
 - A. When the power cord or plug is damaged or frayed.
 - B. If liquid has been spilled into the television equipment.
 - C. If the television equipment has been exposed to rain or water.
 - D. If the television equipment does not operate normally by following the operating instructions. Adjust only those controls that are covered by the operating instructions as improper adjustment of other controls may result in damage and will often require extensive work by a qualified technician to restore the television equipment to normal operation.
 - E. If the television equipment has been dropped or the cabinet has been damaged.
 - F. When the television equipment exhibits a distinct change in performance — this indicates a need for service.
21. Upon completion of any service or repairs to this television equipment, ask the service technician to perform routine safety checks to determine that the television is in safe operating condition.
22. When replacement parts are required, be sure the service technician has used replacement parts specified by the manufacturer that have the same characteristics as the original part. Unauthorized substitutions may result in fire, electric shock, or other hazards.

Trademarks



Dolby and the double-D symbol are registered trademarks of Dolby Laboratories

Supplied Accessories

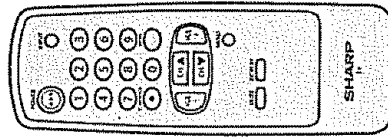

Infrared Remote Control

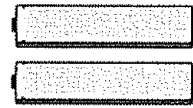

Size AA
Dry Batteries

Before Operating Your Television

Location

- For normal operation, your TV should be located in an area of the room where cool adequate ventilation is provided. Do not place the back of the television set in a place where free airflow will be restricted.
- Any magnetic force may disturb the color picture. Make sure that magnets, electric clocks, toys using magnets or any other magnetic substance, such as iron are kept well away from the TV set.

Power

Your TV operates on 120 Volts, 60 Hz (normal household current) and has a polarized plug. If you are unable to insert the plug fully into the outlet, try reversing the plug. Should it fail to fit, contact an electrician. Do not defeat the safety feature of the polarized plug.

Note:

- If the set is not going to be used for a long period, such as during a vacation, unplug the set from the wall outlet to economize power. (If the TV set is plugged in, a slight current still flows, even with the POWER BUTTON in the OFF position.)
- Lines and other noise may appear in TV broadcast images when an FM tuner or radio is located near the TV and both radio and TV broadcasts are being received. Should such noise appear, turn off the radio.
- If you are listening to an AM broadcast, turn the TV off. AM broadcast signals may not be received due to interference from the TV.
- **Before using the television, prepare the Remote Control**
To use the remote control, insert batteries first.

Inserting the batteries

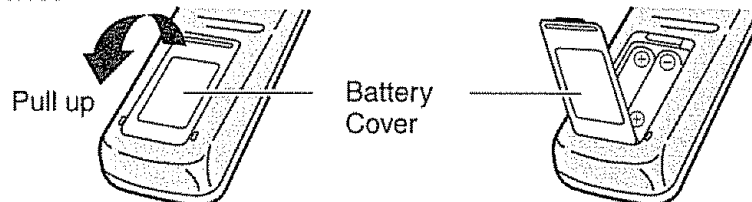

- With your thumbnail, pull up the slit as indicated by the arrow to remove the battery cover. Insert two batteries (size "AA"). Be sure to match the battery \oplus/\ominus terminals with the \oplus/\ominus marks inside the compartment.

Antenna Connections

Antennas

- The antenna requirements for good color television reception are more important than those for black & white television reception. For this reason, a good quality outdoor antenna is strongly recommended. The following is a brief explanation of the type of connections that are provided with the various antenna systems:

- A 75-ohm system is generally a round cable with F-type connector that can easily be attached to a terminal without tools (not supplied)
- A 300-ohm system is a flat "twin-lead" cable that can be attached to a 75-ohm terminal through a 300/75-ohm ADAPTOR (not supplied).

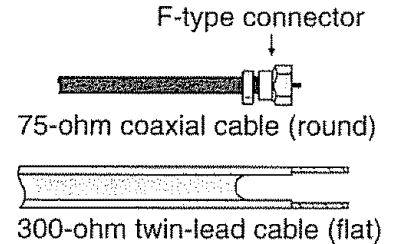

OUTDOOR ANTENNA CONNECTION

- Refer to one of the following two diagrams when connecting to an outdoor antenna.
A: Using a VHF/UHF combination outdoor antenna.
B: Using separate VHF and/or UHF outdoor antenna.
- Connect an outdoor antenna cable lead-in to the ANT/CABLE terminal on the rear of the TV set.

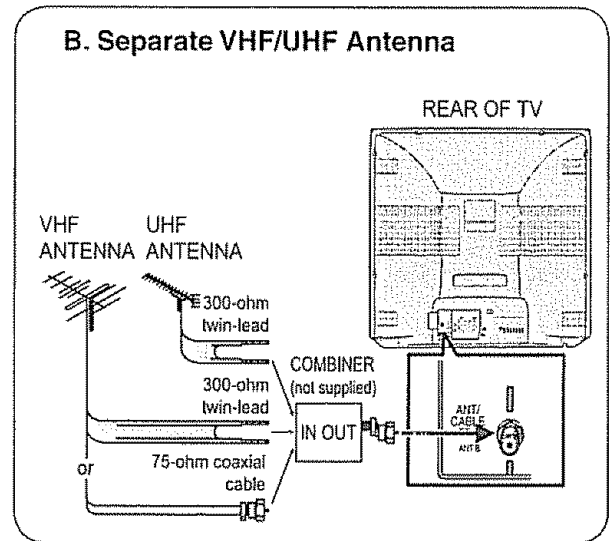
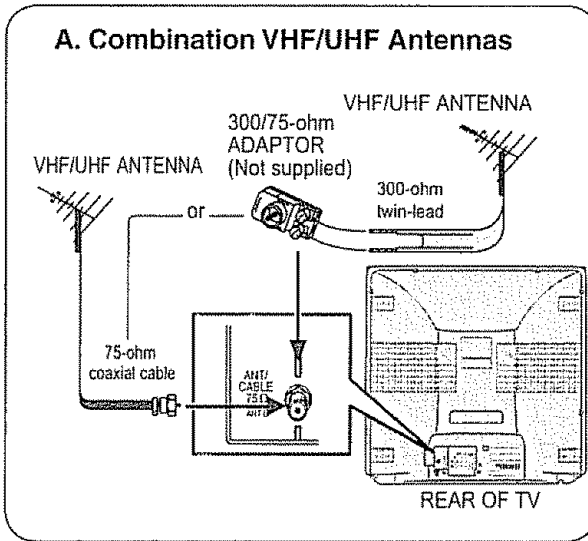

Antenna Connections (Continued)

NOTICE

F-type connector should be finger-tightened only.

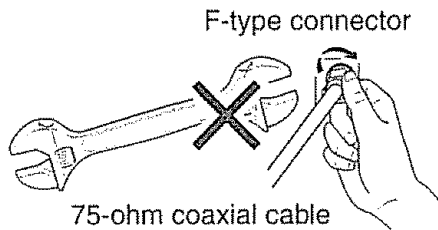

When connecting the RF cable to the TV set, do not tighten F-type connector with tools. If tools are used, it may cause damage to your TV set. (The breaking of internal circuit, etc.)

CABLE TV (CATV) CONNECTION

- A 75 ohm coaxial cable connector is built into the set for easy hookup. When connecting the 75 ohm coaxial cable to the set, screw the 75 ohm cable to the COAXIAL CABLE CONNECTOR.
- Some cable TV companies offer "premium pay channels". Since the signals of these premium pay channels are scrambled, a cable TV converter/descrambler is generally provided to the subscriber by the cable TV company. This converter/descrambler is necessary for normal viewing of the scrambled channels. (Set your TV on channel 3 or 4. Typically one of these channels is used. If this is unknown, consult your cable TV company.) For more specific instructions on installing cable TV, consult your cable TV company. One possible method of utilizing the converter/descrambler provided by your cable TV company is explained below.

Please note: RF switch equipped with position A/B (not provided) is required.

"A" position on the RF switch (not supplied) : You can view all unscrambled channels using the TV's channel keys.

"B" position on the RF switch (not supplied) : You can view the scrambled channels via the converter/descrambler using the converter's channel keys.

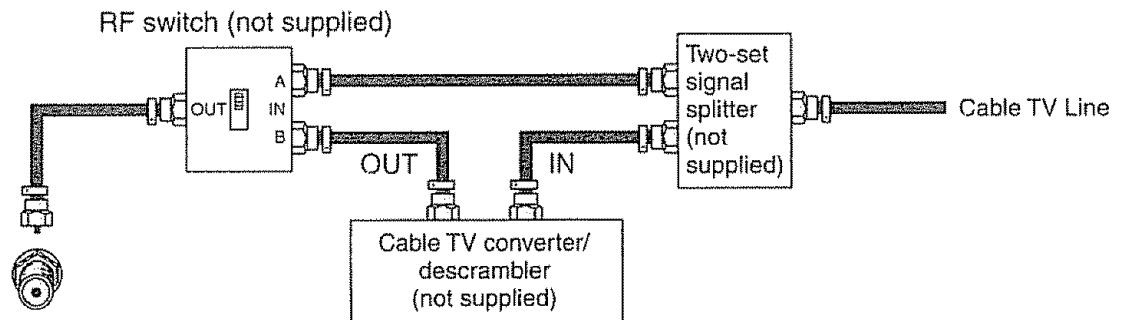

Note:

- Consult your SHARP Dealer or Service Center for the type of splitter, RF switch or combiner that might be required.

Quick Reference Control Operation

● Part Names

Front Panel

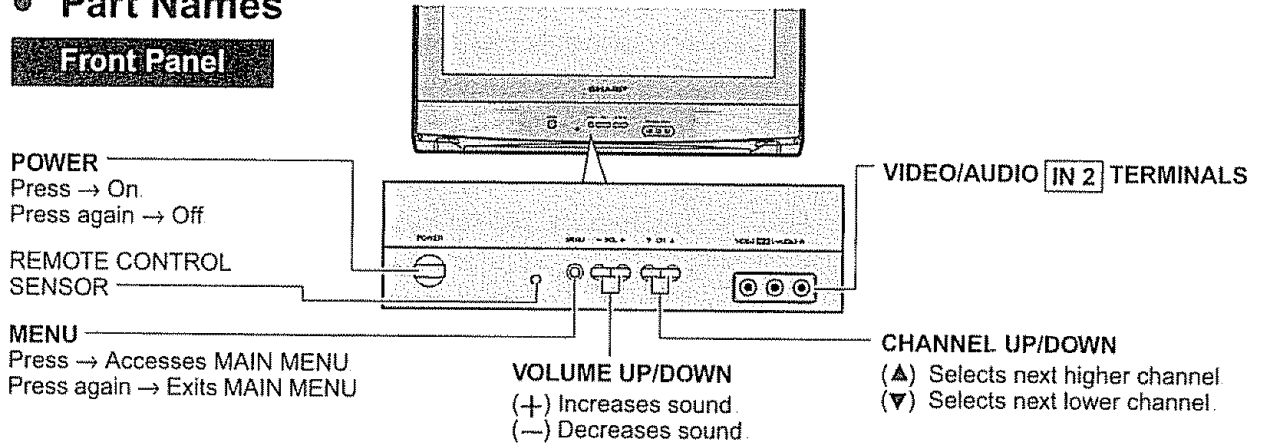

Basic Remote Control Functions

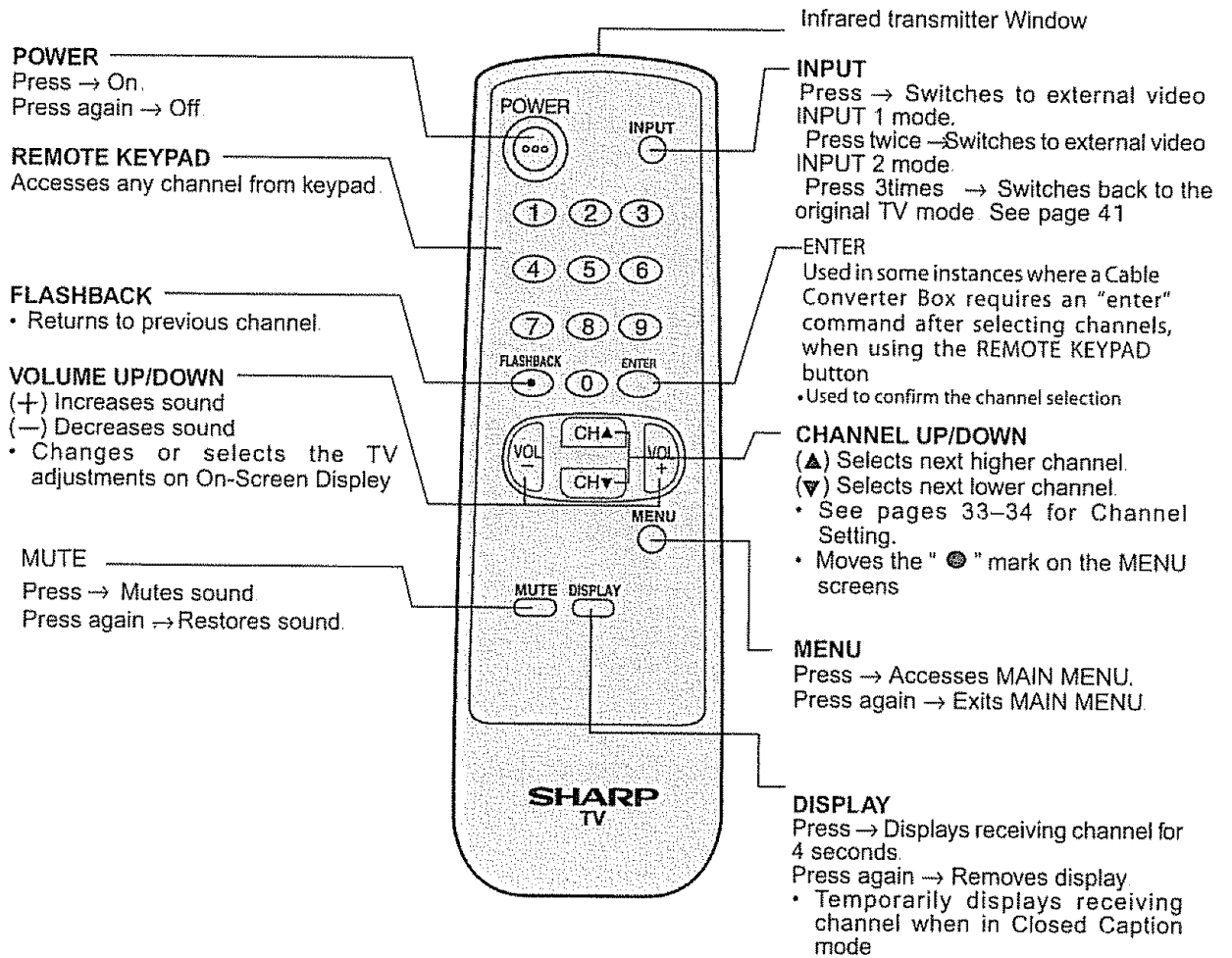

Note:

- The TV set and remote control illustrations and the on-screen displays in this manual may differ from their actual appearance

EZ SETUP during First Use

- When you turn on the TV for the first time, it will automatically memorize the broadcasting channels.
Please perform the following instructions before pressing the **POWER** button.

- Insert the batteries into the remote control. (See page 5)
- Connect the antenna cable to the TV set. (See pages 6, 7)
- Plug in the AC POWER cord to the wall outlet.

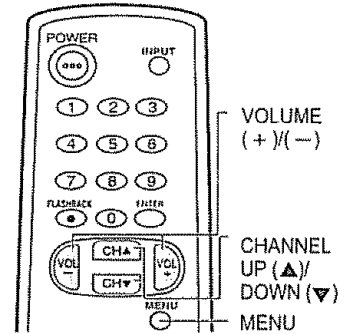

- Press the **POWER** button on the TV set or on the Remote Control to turn on the TV. The **SELECT LANGUAGE** screen will be displayed.

(On the Set)

(On the Remote Control)

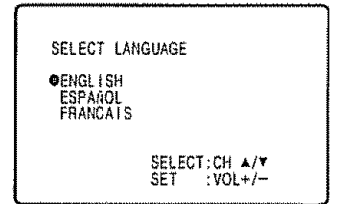

(SELECT LANGUAGE screen)

- Press **CH ▲/▼** to select "ENGLISH", "ESPAÑOL (SPANISH)" or "FRANCAIS (FRENCH)".

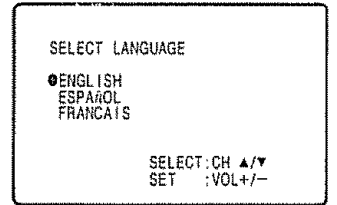

- Press **VOL +/-** to access the **EZ SETUP** screen.

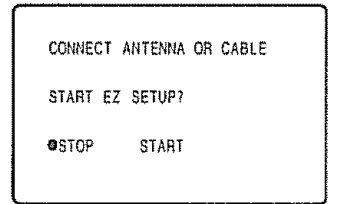
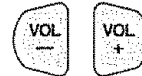

(EZ SETUP screen)

- Press **VOL +**.
The tuner will automatically search for the broadcasting or cable TV channels for **ANALOG**. (The CH No. will automatically increase when it appears.)

(START)



(Analog channel tuning)

Once tuning for analog broadcasting channel is finished, tuning for digital channel will start. If cable TV channels is detected, it will not proceed to digital channel tuning.

(STOP)

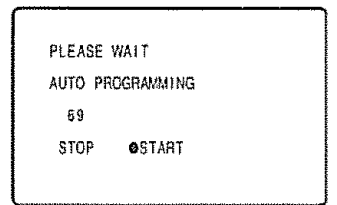

If you want to stop the **EZ SETUP** process once it has started, press **VOL -** and it will be canceled.

If you want to **SET UP** again, please refer to page 33, 34 on **SET UP**.

To cancel EZ SETUP

Press **VOL -**.

(Digital channel tuning)

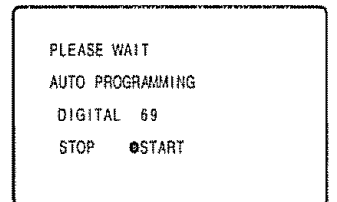

EZ SETUP during First Use (Continued)

- 5 Once EZ SETUP is complete, the lowest channel number memorized will be displayed. (e.g. Channel 2)

2

Note:

- If EZ SETUP does not memorize all the channels in your region, please refer to pages 33–35 for more information on manually memorizing the channels using CHANNEL SETTING.
- It may be difficult to PRESET when the broadcast signals are weak, the channel cycle frequency is incorrect or frequency jamming is occurring around the area. Please refer to pages 33–35 for more information on manually memorizing the channels using CHANNEL SETTING.

Antenna Setup - DIGITAL

- In order to receive digital air broadcasts, you need a digital broadcast antenna. You can set the antenna configuration through the Antenna Setup Digital screen.

- 1 Press **MENU** to access the MAIN MENU screen.

- 2 Press **CH ▲/▼** to move the "●" mark to "SET UP".

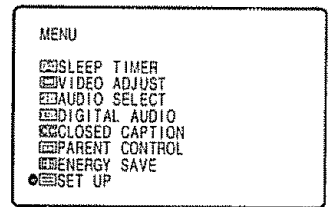
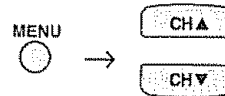

(MAIN MENU screen)

- 3 Press **VOL +/-** to access the SET UP screen, then press **CH ▲/▼** to move the "●" mark to "CH SETTING".

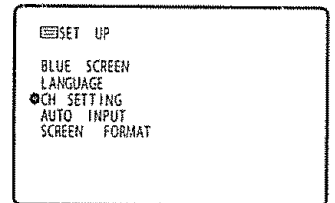
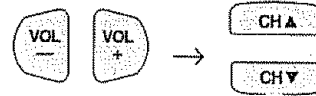

(SET UP screen)

- 4 Press **VOL +/-** to access the CH SETTING screen, then press **CH ▲/▼** to move the "●" mark to select "ANTENNA SETUP DIGITAL".

Note:

- Antenna Setup Digital can only be select during Digital Channel

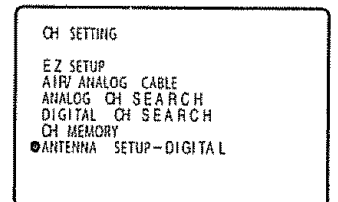
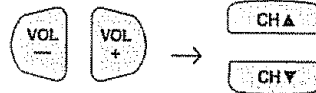

(CH SETTING screen)

- 5 Press **VOL +/-** to access ANTENNA SETUP - DIGITAL screen.

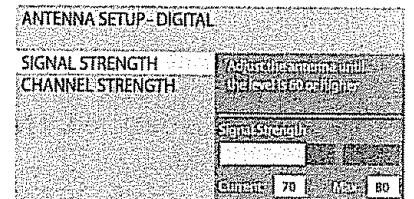

(ANTENNA SETUP- DIGITAL screen)

■ SIGNAL STRENGTH

- Press **CH ▲/▼** to select "SIGNAL STRENGTH".
- Adjust the direction of the antenna to obtain the signal strength level 60 or higher.

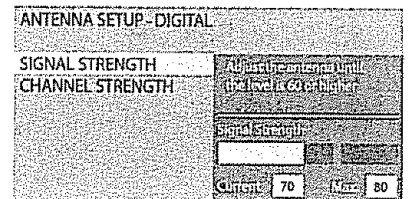

Antenna Setup - DIGITAL (Continued)

CHANNEL STRENGTH

Make sure the signal strength of each channel received is finely adjusted.

- (i) Press **CH ▲/▼** to select "CHANNEL STRENGTH".
- (ii) Input channel number (2–69) using **REMOTE KEYPAD** (0–9) button.
- (iii) Adjust the direction of the antenna to obtain the signal strength level 60 or higher.

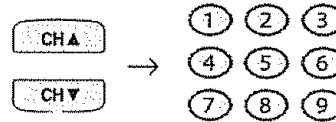
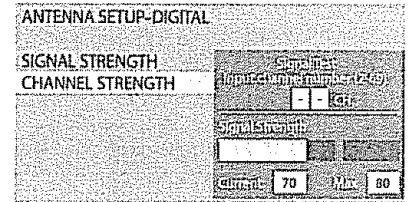

Note:

- This function is available for DIGITAL channel only.

6 Press **MENU** to exit.



Accessing the MAIN MENU screen without Remote Control

- If you misplaced your Remote Control you can still access most settings via the MAIN MENU screen by pressing **MENU** on the TV set.
- Some features of your TV set are not accessible without the Remote Control. If you lost your Remote Control, contact a Sharp Service Center for a replacement.

(On the Set)
MENU



MENU

Channel Call

- To display receiving channel information.

1 Press **DISPLAY** once. The display appears as shown on right.

- If the viewing channel is a digital channel, the information of channel number, audio service type, broadcast station, program information and V-Chip rating will appear.

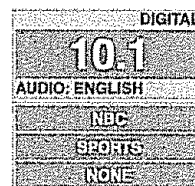

(while viewing digital channel)

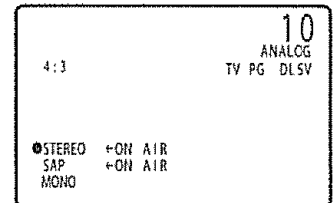

(while viewing analog channel)

2 Press **DISPLAY** twice. The timer information screen will appear.

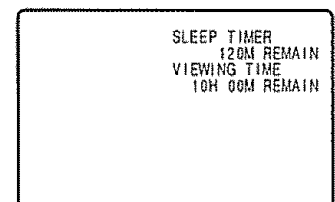

3 Press **DISPLAY** again to return to normal screen.



Changing Viewing Channel

- Please note: your new Television is capable of receiving the full range of AIR-TV channels available today, from the most advanced digital channels, to the more traditional analog channels. As the transition toward full digital TV continues, some AIR-TV systems in the USA will have a mixture of analog and digital channels in their lineups.

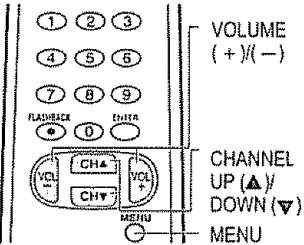

You can change channels in several ways.

Method 1

Using **CH ▲/▼** on the remote control unit or on the TV set.



(On the Set)
MENU



MENU
button



(while viewing digital channel)

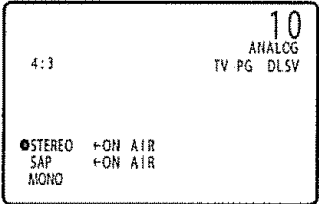

(while viewing analog channel)

Method 2

- (i) Press **FLASHBACK** to switch to the previously tuned channel.
- (ii) Press **FLASHBACK** again to switch back to the currently tuned channel.



Note:

- **FLASHBACK** will not work if no channel has been changed after TV is turned on.

Method 3

Using **REMOTE KEYPAD** buttons (**0-9** and **ENTER**) to select up to 125 channels for VHF/UHF/CATV.

To select a 1 or 2-digit analog channel number (e. g., Channel 5):

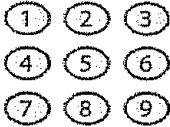

Press 5 → **ENTER**

Note:

- When selecting a 1-digit channel number, it is not necessary to press 0 before the number.
- When you enter 0-9 only, channel selection will be made if there is no operation for a few seconds.

To select a 3-digit analog channel number (e. g., Channel 115):



Press 1 → 1 → 5 → **ENTER**

Note:

- When you enter 0-9 only, channel selection will be made if there is no operation for a few seconds.
- If you push "0" by itself, nothing will happen.

To select a digital channel number (e. g. Channel 10.1):

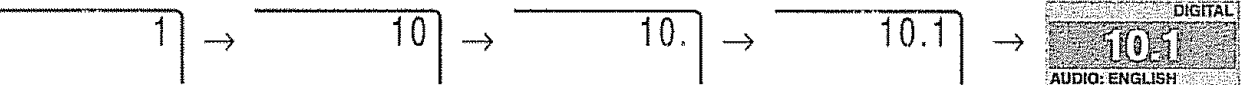

Press 1 → 0 → • (DOT) → 1 → **ENTER**

Note:

- Complete the above steps within a few seconds.
- When you enter 0-9 and • (DOT), channel selection will be made if there is no operation for a few seconds.

Language

- The language for the ON SCREEN DISPLAY can be set to ENGLISH, SPANISH or FRENCH.

1 Press **MENU** to access the MAIN MENU screen.

MENU

MENU
 ● SLEEP TIMER
 VIDEO ADJUST
 AUDIO SELECT
 DIGITAL AUDIO
 CLOSED CAPTION
 PARENT CONTROL
 ENERGY SAVE
 SET UP

(MAIN MENU screen)

2 Press **CH ▲/▼** to move the "●" mark to "SET UP".

CH▲

CH▼

MENU
 SLEEP TIMER
 VIDEO ADJUST
 AUDIO SELECT
 DIGITAL AUDIO
 CLOSED CAPTION
 PARENT CONTROL
 ENERGY SAVE
 ● SET UP

3 Press **VOL +/-** to access the SET UP screen, then press **CH ▲/▼** to move the "●" mark to "LANGUAGE".

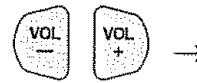

CH▲
 CH▼

SET UP
 BLUE SCREEN
 ● LANGUAGE
 CH SETTING
 AUTO INPUT
 SCREEN FORMAT

(SET UP screen)

4 Press **VOL +/-** to access the LANGUAGE select screen.



LANGUAGE
 ● ENGLISH
 ESPAÑOL
 FRANCAIS

(LANGUAGE select screen)

5 Press **CH ▲/▼** to select "ENGLISH", "ESPAÑOL (SPANISH)" or "FRANCAIS (FRENCH)".

CH▲

CH▼

IDIOMA
 ENGLISH
 ● ESPAÑOL
 FRANCAIS

6 Press **MENU** to exit.

MENU

Sleep Timer

- You can preset your television to turn off automatically in increments of 30, 60, 90 or 120 minutes.

1 Press **MENU** to access the MAIN MENU screen.

2 Press **VOL +/-** to access the SLEEP TIMER screen.

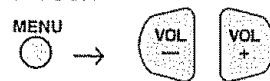

MENU
 ● SLEEP TIMER
 VIDEO ADJUST
 AUDIO SELECT
 DIGITAL AUDIO
 CLOSED CAPTION
 PARENT CONTROL
 ENERGY SAVE
 SET UP

3 Press **VOL +/-** to set a sleep time of 30, 60, 90 or 120 minutes.

4 Press **MENU** to exit.

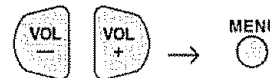

SLEEP TIMER
 120M REMAIN

(SLEEP TIMER screen)

- To turn off the SLEEP TIMER, repeat the above SLEEP TIMER steps and select "--- M REMAIN" during step 3.
- While SLEEP TIMER is active, the time remaining will be briefly displayed on-screen at regular intervals or when the Remote's DISPLAY key is pressed twice. 5 minutes before the SLEEP TIMER turns off the TV, the screen prompts the time remaining for 4 seconds. The SLEEP TIMER shows a similar display for each remaining minute and a 10-second display right before shutting off the TV.
- If you turn the POWER OFF, the SLEEP TIMER will automatically reset.

Video Adjust

| Selected item | VOL + button | VOL - button |
|---------------|-----------------------------------------------------|-----------------------------|
| PICTURE | To increase contrast | To decrease contrast |
| TINT | To make skin tones greenish | To make skin tones purplish |
| COLOR | To increase color intensity | To decrease color intensity |
| BRIGHT | To increase brightness | To decrease brightness |
| SHARP | To increase sharpness | To decrease sharpness |
| COLOR TEMP. | To choose a LOW, ML, MH or HIGH color tone. | |
| RESET | To return all adjustments to factory preset levels. | |

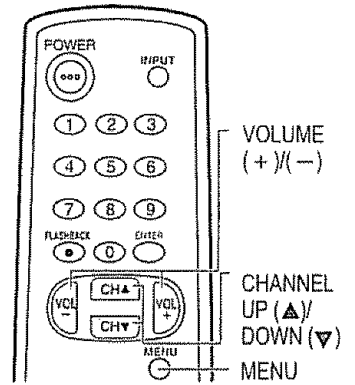

- 1 Press **MENU** to access the MAIN MENU screen.
- 2 Press **CH ▲/▼** to move the "●" mark to "VIDEO ADJUST".

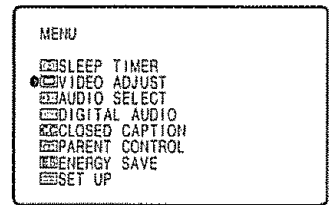
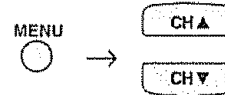

(MAIN MENU screen)

- 3 Press **VOL +/-** to access the PICTURE adjust screen.
 - The word "DIGITAL" will appear to show viewing channel is a digital channel.

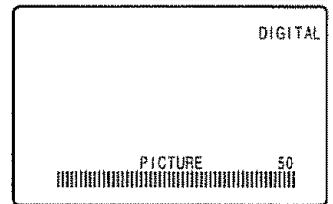
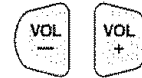

(PICTURE adjust screen)

- 4 Press **CH ▲/▼** to select the desired adjustment item. (Refer to the diagram below.)

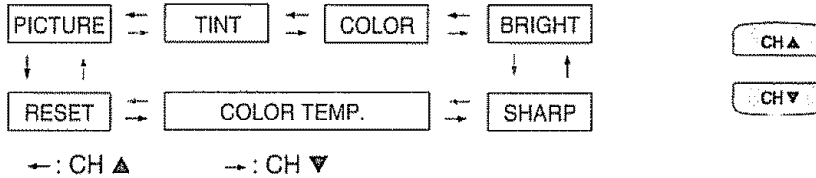

- 5 Press **VOL +/-** to adjust the setting.

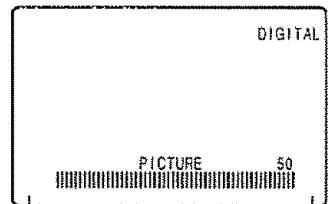
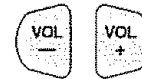

VOL +
increases contrast

VOL -
decreases contrast

- 6 Repeat steps 4 to 5 to adjust other settings.

- 7 Press **MENU** to exit.



Note:

- VIDEO ADJUST setting, once set, is shared among AIR/CABLE, INPUT 1, INPUT 2, and INPUT 3 modes.
- VIDEO ADJUST setting for INPUT 3 when used as COMPONENT can be set independently.
- VIDEO ADJUST setting for Digital Channel can be set independently.

Audio Select

- **MTS (Multichannel TV Sound) (For Analog Channel only)**
 This function allows reception of stereo or bilingual TV sound.
 - You can enjoy Hi-Fi stereo sound or SAP broadcasts where available.
 - Stereo broadcasts
 Live television broadcasts of sports, shows, concerts, etc. can be received in dynamic stereo sound.
 - SAP broadcasts
 Television broadcast can be received with either MAIN or SAP sound.
 MAIN sound: The normal program soundtrack. (Monaural or stereo where available.)
 SAP sound: Second language, supplementary commentaries, etc. (SAP sound is monaural.)
 - If stereo sound is difficult to hear;
 You can obtain clearer sound by manually switching to fixed monaural mode.
- **SPEAKER (Internal Speaker Switch)**
 This function turns the TV's internal speakers "ON" or "OFF" when listening to sound from external speakers by using the AUDIO OUTPUT Terminals. (See page 42).
- **FAO (Fixed Audio Output)**
 This function turns the TV's internal speakers "OFF" and allows fixed audio output from the AUDIO OUTPUT Terminals. (See page 42). With FAO, the TV's volume control is disabled.

- 1 Press **MENU** to access the MAIN MENU screen.
- 2 Press **CH ▲/▼** to move the "●" mark to "AUDIO SELECT".

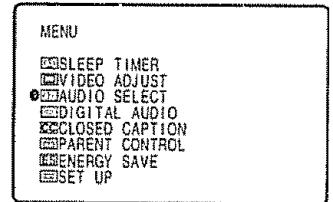
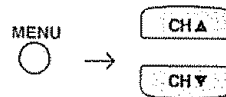

(MAIN MENU screen)

- 3 Press **VOL +/-** to access the AUDIO SELECT screen.
- 4 Press **CH ▲/▼** to move the "●" mark to "MTS", "SPEAKER", "FAO" or "AUDIO ADJUST".

Note:

- If the viewing channel is a digital channel, MTS cannot be selected.

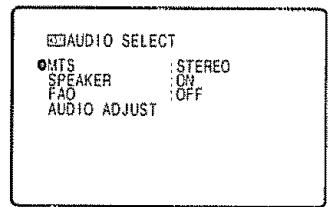
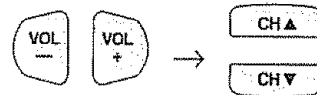

(AUDIO SELECT screen)

- 5 Press **VOL +/-** to select "STEREO", "SAP" or "MONO" when the "●" mark is at "MTS" position.

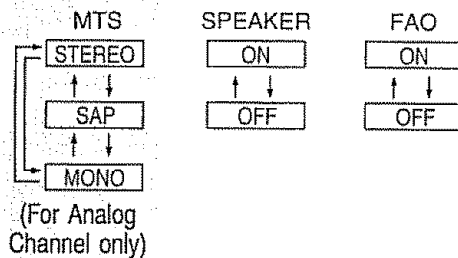

(For Analog Channel only)

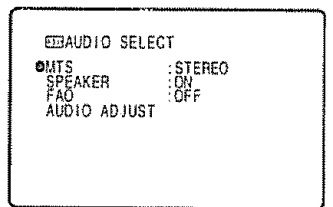
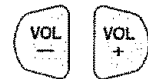

(AUDIO SELECT screen)

Audio Select (Continued)

AUDIO ADJUST

When the "●" mark is at "AUDIO ADJUST", press **VOL +/-** to access the AUDIO ADJUST screen. To access the desired item, press **CH ▲/▼**. To adjust the audio setting, press **VOL +/-**.

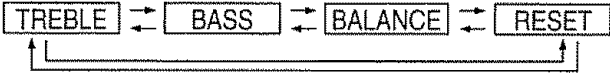

| Selected item | VOL + button | VOL - button |
|---------------|----------------------------------------------------|----------------------------------------|
| TREBLE | To increase treble response. | To decrease treble response. |
| BASS | To increase bass response. | To decrease bass response. |
| BALANCE | To emphasize the right speaker's volume | To emphasize the left speaker's volume |
| RESET | To return all adjustments to factory preset levels | |

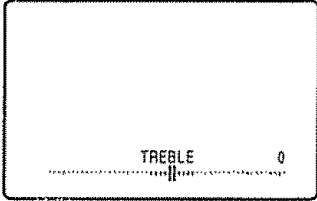

6 Press **MENU** to exit. MENU

An example screen displaying ON AIR Analog Channel when receiving stereo broadcasts

Current channel number _____

"← ON AIR" will appear next to STEREO or SAP when receiving STEREO or SAP broadcasts.

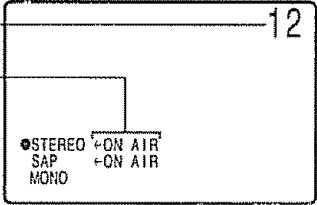

Note:

(Analog CHANNEL call on screen)

- Once MONO mode is selected, the TV sound remains monaural even if the TV set receives a stereo broadcast. You must switch the mode back to STEREO if you want to hear stereo sound again.
- Selecting MTS while receiving video signals from INPUT terminals does not change the type of sound; in this case, sound is determined by the video source.
- If "FAO" mode is on, "SPEAKER" mode will automatically turn off. Changing "SPEAKER" setting will not affect "FAO" mode.

Digital Audio

- This feature allows you to select the Primary and Secondary language and as well the type of audio transmitted in a digital broadcast. If the viewing channel is an analog channel, Digital Audio cannot be selected.

- 1 Press **MENU** to access MAIN MENU screen.
- 2 Press **CH ▲/▼** to move the "●" mark to "DIGITAL AUDIO".

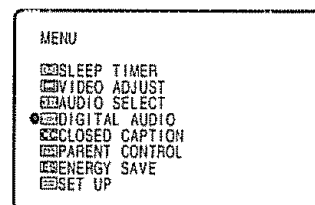

(MAIN MENU screen)

- 3 Press **VOL +/-** to access the DIGITAL AUDIO screen.
- 4 Press **CH ▲/▼** to select "Audio Service" or "Audio Preference", then press **VOL +/-** to access to the selected mode.

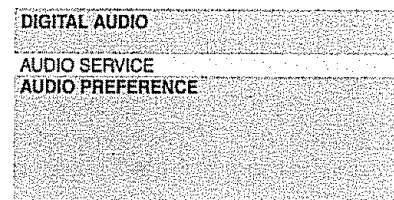
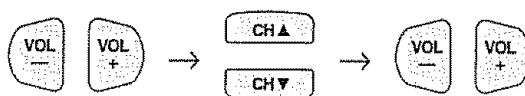

(DIGITAL AUDIO screen)

AUDIO SERVICE

- (i) Press **CH ▲/▼** to select the AUDIO SERVICE. Six kinds of audio service are available to be selected. However, selectable service depends on the programs contains. The services are toggles as shown on below:

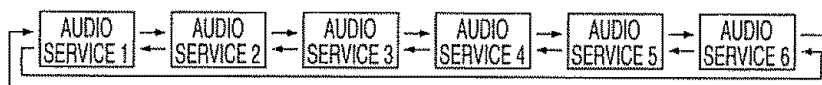

If a program has three services, audio service toggles like below:

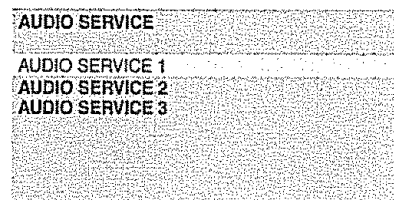

- AUDIO SERVICE: The type of audio transmitted in a digital broadcast signal.
- In addition, it is possible for multiple audio tracks to accompany a signal video track.

AUDIO PREFERENCE

- (i) Press **CH ▲/▼** to select "PRIMARY LANGUAGE" or "SECONDARY LANGUAGE".
- (ii) Press **VOL +/-** to change the setting.

PRIMARY LANGUAGE



SECONDARY LANGUAGE

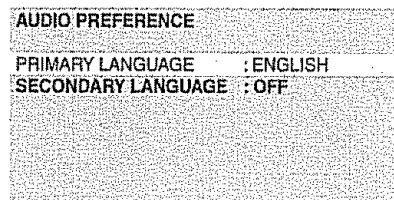
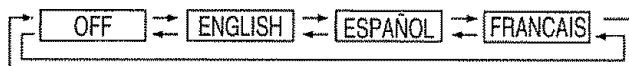

Note:

- The language which is selected in Primary Language will not appear in Secondary Language selection mode

- 5 Press **MENU** to exit.



Closed Caption

How to set CLOSED CAPTION

- Your TV is equipped with an internal Closed Caption decoder. "Closed Caption" is a system which allows conversations, narration, and sound effects in TV programs and home videos to appear as captions on the TV screen (see the illustration).
- Not all the programs and videos will offer closed captioning. Please look for the "CC" symbol to ensure that captions will be shown.
- Closed Caption broadcast for Analog Channel can be viewed in two modes: CAPTION and TEXT. For each mode, two channels are available, CH1 and CH2.
- Closed Caption broadcast for Digital Channel can be viewed in 10 modes (maximum).
The CAPTION mode shows subtitles of dialogs and commentaries of TV dramas and news programs while allowing clear view of the picture.
The TEXT mode displays over the picture other various information (such as TV program schedule, weather forecast, etc.) that is independent of the TV programs

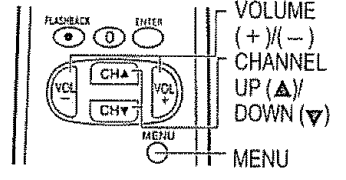

During viewing analog channel

- Press **MENU** to access the MAIN MENU screen.
- Press **CH ▲/▼** to move the "●" mark to "CLOSED CAPTION".

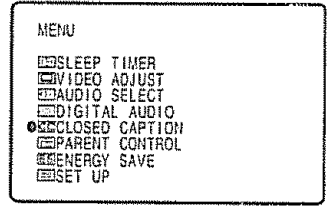
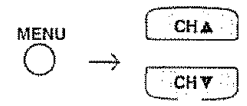

(MAIN MENU screen)

- Press **VOL +/-** to access the CLOSED CAPTION setting screen.

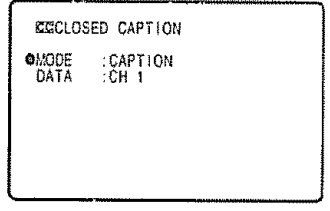
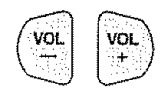

(CLOSED CAPTION setting screen)

- Press **CH ▲/▼** to move the "●" mark to either "MODE" or "DATA".

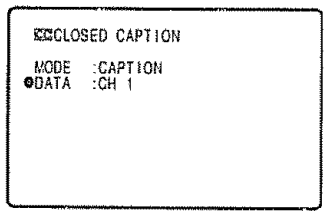
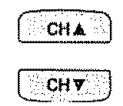

- Press **VOL +/-** to change the CLOSED CAPTION setting.

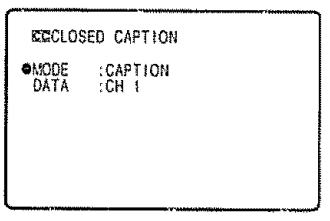
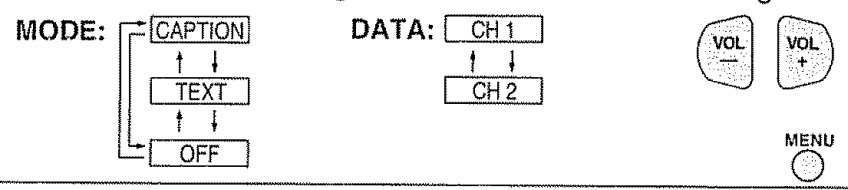

- Press **MENU** to exit.

Closed Caption (Continued)

■ During viewing digital channel

- 1 Repeat steps 1 to 2 of **During viewing analog channel**
- 2 Press **VOL +/-** to access the CLOSED CAPTION screen.
- 3 Press **CH ▲/▼** to select "CLOSED CAPTION SERVICE" or "CLOSED CAPTION PREFERENCE" and then press **VOL +/-** to enter to the selected mode screen.

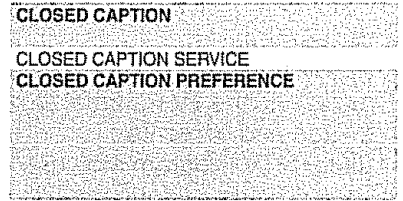

(CLOSED CAPTION screen)

■ CLOSED CAPTION SERVICE

- (i) Press **CH ▲/▼** to select "CLOSED CAPTION SERVICE".

Closed caption services toggles like below:

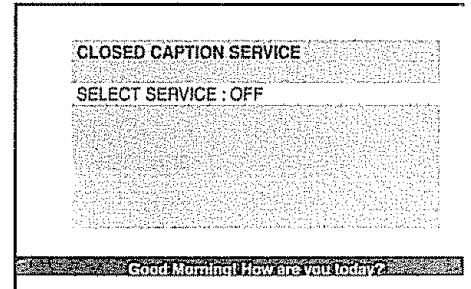

(CLOSED CAPTION SERVICE screen)

■ CLOSED CAPTION PREFERENCE

- (i) Press **CH ▲/▼** to select "FONT SIZE", "FONT COLOR", "BACKGROUND COLOR" or "RESET".
- (ii) Press **VOL +/-** to select desired setting.

The setting toggles as shown below:

FONT SIZE

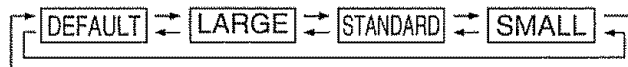

FONT COLOR/BACKGROUND COLOR

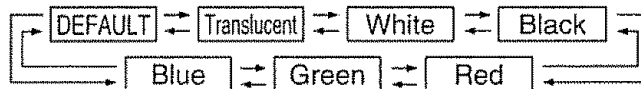

RESET

- For resetting all adjustment items to the factory preset values.

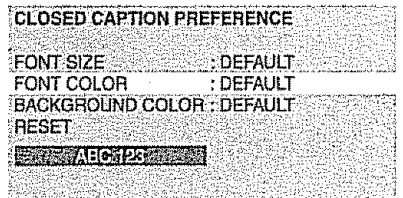
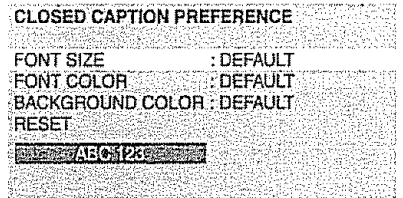
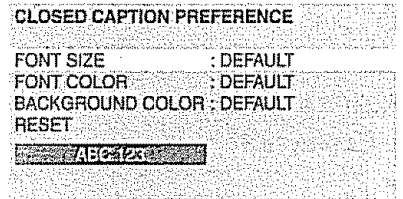

Note:

- Closed Caption may malfunction (white blocks, strange characters, etc.) if signal conditions are poor or if there are problems at the broadcast source. This does not necessarily indicate a problem with your TV.
- If any button is pressed to call up the ON SCREEN DISPLAY while viewing a CLOSED CAPTION broadcast, the closed captions will disappear momentarily.
- If no TEXT broadcast is being received while viewing in the TEXT mode, the screen may become dark and blank for some programs. Should this occur, switch the Closed Caption mode to "OFF".

Parent Control (V-CHIP Operation)

■ V-CHIP

- This function allows you to restrict TV programs and also allows you to control TV usage based on FCC data. This function is to prevent your children from watching violence or sexual scenes that may be harmful.
- Restriction of TV programs includes two characters that contain information about the program's MPAA rating and the TV Parental Guidelines. MPAA is restricted by age. TV Parental Guidelines are restricted by age and contents.
- Since a TV program may use either the MPAA rating, TV guidelines or canadian Rating System, you should adjust all for complete control.

[1] MPAA RATING

| RATING | | |
|-----------|-------|--------------------------------------------------------------------------------------------------|
| age based | G | GENERAL AUDIENCES. All ages admitted. |
| | PG | PARENTAL GUIDANCE SUGGESTED. Some material may not be suitable for children. |
| | PG-13 | PARENTS STRONGLY CAUTIONED. Some material may be inappropriate for children under 13. |
| | R | RESTRICTED. Under 17 requires accompanying parent or adult guardian. |
| | NC-17 | NO ONE 17 AND UNDER ADMITTED. |
| | X | X Rating is an older rating that is unified with NC-17 but may be encoded on older movie's data. |

• MPAA RATING

Example 1:

"PG-13" in the age-based rating is blocked, this will automatically block the higher ratings "R", "NC-17", "X" also.

1. User setting

| | |
|-------|-------|
| G | ---- |
| PG | ---- |
| PG-13 | BLOCK |
| R | BLOCK |
| NC-17 | BLOCK |
| X | BLOCK |

2. Block table

| | |
|-------|--------------|
| G | not to block |
| PG | not to block |
| PG-13 | Select block |
| R | auto-block |
| NC-17 | auto-block |
| X | auto-block |

Example 2:

"R" in the age-based rating is blocked, this will automatically block the higher rating "NC-17", "X" also.

1. User setting

| | |
|-------|-------|
| G | ---- |
| PG | ---- |
| PG-13 | ---- |
| R | BLOCK |
| NC-17 | BLOCK |
| X | BLOCK |

2. Block table

| | |
|-------|--------------|
| G | not to block |
| PG | not to block |
| PG-13 | not to block |
| R | Select block |
| NC-17 | auto-block |
| X | auto-block |

Note:

- MPAA RATING is only age-based.

[2] TV PARENTAL GUIDELINES

| RATING | ← content based → | | | | | | |
|---------------------|-------------------------------------|-------------------------------------|-------------------------------------|-------------------------------------|-------------------------------------|-------------------------------------|---|
| | AGE | D (Sexually Suggestive Dialog) | L (Adult Language) | S (Sexual Situation) | V (Violence) | FV (Fantasy Violence) | |
| age based ↑ ↓ | TV-Y (All children) | <input checked="" type="checkbox"/> | - | - | - | - | |
| | TV-Y7 (Direct to Older Children) | <input checked="" type="checkbox"/> | - | - | - | <input checked="" type="checkbox"/> | |
| | TV-G (General Audience) | <input checked="" type="checkbox"/> | - | - | - | - | |
| | TV-PG (Parental Guidance Suggested) | <input checked="" type="checkbox"/> | <input checked="" type="checkbox"/> | <input checked="" type="checkbox"/> | <input checked="" type="checkbox"/> | <input checked="" type="checkbox"/> | - |
| | TV-14 (Parents Strongly Cautioned) | <input checked="" type="checkbox"/> | <input checked="" type="checkbox"/> | <input checked="" type="checkbox"/> | <input checked="" type="checkbox"/> | <input checked="" type="checkbox"/> | - |
| | TV-MA (Mature Audience Only) | <input checked="" type="checkbox"/> | - | <input checked="" type="checkbox"/> | <input checked="" type="checkbox"/> | <input checked="" type="checkbox"/> | - |

: Content Rating can be set.

- : Content Rating cannot be set (not normally broadcast by TV station).

Parent Control (V-CHIP Operation) (Continued)

• TV PARENTAL GUIDELINES (Example)

Example 1.1 : Age Based setting

Clear s (block) from each "AGE" box for all ratings
This will automatically unblock everything.

| | AGE | D | L | S | V | FV | |
|--------------|--------------------------|---|---|---|---|----|-------------------------------------------|
| TV-Y | <input type="checkbox"/> | - | - | - | - | - | <input type="checkbox"/> VIEW |
| TV-Y7 | <input type="checkbox"/> | - | - | - | - | - | <input checked="" type="checkbox"/> BLOCK |
| TV-G | <input type="checkbox"/> | - | - | - | - | - | |
| TV-PG | <input type="checkbox"/> | - | - | - | - | - | |
| TV-14 | <input type="checkbox"/> | - | - | - | - | - | |
| • TV-MA | <input type="checkbox"/> | - | - | - | - | - | |
| MENU: RETURN | | | | | | | |

Example 1.2 : Age Based setting

For "TV-G" put a in the "AGE" box. This will automatically block the higher age ratings "TV-PG", "TV-14" and "TV-MA" as well as "TV-G". Please note the content ratings "D", "L", "S", "V" are automatically blocked as well.

| | AGE | D | L | S | V | FV | |
|--------------|-------------------------------------|-------------------------------------|-------------------------------------|-------------------------------------|-------------------------------------|-------------------------------------|-------------------------------------------|
| TV-Y | <input type="checkbox"/> | - | - | - | - | - | <input type="checkbox"/> VIEW |
| TV-Y7 | <input type="checkbox"/> | - | - | - | - | - | <input checked="" type="checkbox"/> BLOCK |
| • TV-G | <input checked="" type="checkbox"/> | - | - | - | - | - | |
| TV-PG | <input checked="" type="checkbox"/> | <input checked="" type="checkbox"/> | <input checked="" type="checkbox"/> | <input checked="" type="checkbox"/> | <input checked="" type="checkbox"/> | <input checked="" type="checkbox"/> | |
| TV-14 | <input checked="" type="checkbox"/> | <input checked="" type="checkbox"/> | <input checked="" type="checkbox"/> | <input checked="" type="checkbox"/> | <input checked="" type="checkbox"/> | <input checked="" type="checkbox"/> | |
| TV-MA | <input checked="" type="checkbox"/> | <input checked="" type="checkbox"/> | <input checked="" type="checkbox"/> | <input checked="" type="checkbox"/> | <input checked="" type="checkbox"/> | <input checked="" type="checkbox"/> | |
| MENU: RETURN | | | | | | | |

Example 2.1 : Content Based setting

If you choose to unblock every content-based items ("D", "L", "S", "V"), clear the (block) from each "AGE" box of "TV-PG", "TV-14" and "TV-MA".

| | AGE | D | L | S | V | FV | |
|--------------|--------------------------|---|---|---|---|----|-------------------------------------------|
| TV-Y | <input type="checkbox"/> | - | - | - | - | - | <input type="checkbox"/> VIEW |
| TV-Y7 | <input type="checkbox"/> | - | - | - | - | - | <input checked="" type="checkbox"/> BLOCK |
| TV-G | <input type="checkbox"/> | - | - | - | - | - | |
| TV-PG | <input type="checkbox"/> | - | - | - | - | - | |
| TV-14 | <input type="checkbox"/> | - | - | - | - | - | |
| • TV-MA | <input type="checkbox"/> | - | - | - | - | - | |
| MENU: RETURN | | | | | | | |

Example 2.2 : Content Based setting

Put a in the box corresponding to "TV-PG" (row) and "V (Violence)" (column). This will automatically block the "V" boxes for "TV-14" and "TV-MA". Setting only "TV-PG-V", "TV-14-V" or "TV-MA-V" will not block all programs rated "TV-PG", "TV-14" or "TV-MA".

| | AGE | D | L | S | V | FV | |
|--------------|--------------------------|---|---|---|-------------------------------------|----|-------------------------------------------|
| TV-Y | <input type="checkbox"/> | - | - | - | - | - | <input type="checkbox"/> VIEW |
| TV-Y7 | <input type="checkbox"/> | - | - | - | - | - | <input checked="" type="checkbox"/> BLOCK |
| TV-G | <input type="checkbox"/> | - | - | - | - | - | |
| • TV-PG | <input type="checkbox"/> | - | - | - | <input checked="" type="checkbox"/> | - | |
| TV-14 | <input type="checkbox"/> | - | - | - | <input checked="" type="checkbox"/> | - | |
| TV-MA | <input type="checkbox"/> | - | - | - | <input checked="" type="checkbox"/> | - | |
| MENU: RETURN | | | | | | | |

Example 3 : Resetting an Age Based setting

For "TV-14", put a (block) in the "AGE" box.

This will again automatically block the content ratings "D", "L", "S", "V" for "TV-MA" as well as "TV-14" ("D" is not available for "TV-MA"). Please note that the lower age rating "TV-PG" does not change from its previous settings after this.

| | AGE | D | L | S | V | FV | |
|--------------|-------------------------------------|-------------------------------------|-------------------------------------|-------------------------------------|-------------------------------------|-------------------------------------|-------------------------------------------|
| TV-Y | <input type="checkbox"/> | - | - | - | - | - | <input type="checkbox"/> VIEW |
| TV-Y7 | <input type="checkbox"/> | - | - | - | - | - | <input checked="" type="checkbox"/> BLOCK |
| TV-G | <input type="checkbox"/> | - | - | - | - | - | |
| TV-PG | <input type="checkbox"/> | - | - | - | - | - | |
| • TV-14 | <input checked="" type="checkbox"/> | <input checked="" type="checkbox"/> | <input checked="" type="checkbox"/> | <input checked="" type="checkbox"/> | <input checked="" type="checkbox"/> | <input checked="" type="checkbox"/> | |
| TV-MA | <input checked="" type="checkbox"/> | <input checked="" type="checkbox"/> | <input checked="" type="checkbox"/> | <input checked="" type="checkbox"/> | <input checked="" type="checkbox"/> | <input checked="" type="checkbox"/> | |
| MENU: RETURN | | | | | | | |

Note:

- Content ratings can be modified but only in the combinations indicated by in the table on page 21.
- Changing a lower age rating's content setting to "BLOCK" automatically changes the same higher age rating's content setting to "BLOCK" regardless of their previous settings.
- Changing a lower rating's "AGE" setting to "BLOCK" automatically changes all higher ratings to "BLOCK" regardless of their previous settings.
- For "TV-Y7", "TV-PG", "TV-14" and "TV-MA", if you clear the in the "AGE" box (unblock) you can still change settings based on content.
Clearing a higher rating's age or content setting will not clear lower settings. Make sure that all undesired boxes are blocked.

Parent Control (V-CHIP Operation) (Continued)

[3] Canadian Rating Systems

- The TV rating systems in Canada are based on the Canadian Radio-Television and Telecommunications Commission (CRTC) policy on violence in television programming.
- While violence is the most important content element to be rated, the structure developed takes into consideration other program content like language, nudity, sexuality and mature themes.
- When setting the V-CHIP on the Canadian system you can choose either the Canadian English ratings or the Canadian French ratings.

[i] Canadian English ratings

| Rating | | Description |
|--------|-----|-----------------------------------------------------------------------------------------------------------------------------------------------------------------------------------------------------------------------------------------------------------------|
| Age | C | Children: Intended for younger children under the age of 8 years. Pays careful attention to themes that could threaten their sense of security and well-being. |
| | C8+ | Children over 8 years old: Contains no portrayal of violence as the preferred, acceptable, or only way to resolve conflict; nor encourage children to imitate dangerous acts which they may see on the screen. |
| | G | General: Considered acceptable for all age groups. Appropriate viewing for the entire family, contains very little violence, physical, verbal or emotional. |
| | PG | Parental Guidance: Intended for a general audience, but may not be suitable for younger children (under the age of 8) because it could contain controversial themes or issues. |
| | 14+ | Over 14 Years: Could contain themes where violence is one of the dominant elements of the storyline, but it must be integral to the development of plot or character. Language usage could be profane and nudity present within the context of the theme. |
| | 18+ | Adults: Intended for viewers 18 years and older and might contain depictions of violence, which while related to the development of plot, character or themes, are intended for adult viewing. Could contain graphic language and portrayals of sex and nudity. |

[ii] Canadian French ratings

| Rating | | Description |
|--------|-----|-------------------------------------------------------------------------------------------------------------------------------------------------------------------------------------------------------------------------------------------------|
| Age | G | General: All ages and children, contains minimal direct violence, but may be integrated into the plot in a humorous or unrealistic manner. |
| | 8+ | General but inadvisable for young children: May be viewed by a wide public audience, but could contain scenes disturbing to children under 8 who cannot distinguish between imaginary and real situations. Recommended for viewing with parent. |
| | 13+ | Over 13 years: Could contain frequent violent scenes and therefore recommended for viewing with parent. |
| | 16+ | Over 16 years: Could contain frequent violent scenes and intense violence. |
| | 18+ | Over 18 years: Only for adult viewing. Could contain frequent violent scenes and extreme violence |

Parent Control (V-CHIP Operation) (Continued)

• How to set V-CHIP

[1] MPAA RATING

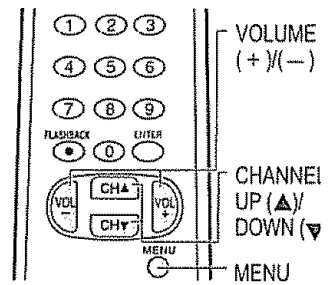

1 Press **MENU** to access the MAIN MENU screen.



```

MENU
● SLEEP TIMER
VIDEO ADJUST
AUDIO SELECT
DIGITAL AUDIO
CLOSED CAPTION
PARENT CONTROL
ENERGY SAVE
SET UP
    
```

(MAIN MENU screen)

2 Press **CH ▲/▼** to move the "●" mark to "PARENT CONTROL".



```

MENU
SLEEP TIMER
VIDEO ADJUST
AUDIO SELECT
DIGITAL AUDIO
CLOSED CAPTION
● PARENT CONTROL
ENERGY SAVE
SET UP
    
```

3 Press **VOL +/-** to access the PARENT CONTROL screen.

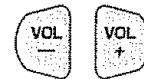

```

PARENT CONTROL
● V-CHIP BLOCK
VIEW TIMER
    
```

(PARENT CONTROL screen)

4 Press **VOL +/-** to access the V-CHIP select screen.

Note:

- If SECRET No. is already set, enter the SECRET No. (See **To change the V-CHIP BLOCK after registering a secret No.** on page 27.).



```

MPAA
TV GUIDELINES
Cdn English Ratings
Cdn French Ratings

STATUS :OFF
    
```

(V-CHIP select screen)

5 Press **VOL +/-** to select "MPAA". Press **CH ▲/▼** to move the "●" mark to "PG", then press **VOL +/-** to select BLOCK. If you set "PG" to BLOCK, "PG-13", "R", "NC-17" and "X" are automatically blocked.

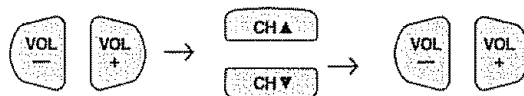

```

G :-----
● PG :BLOCK
PG-13 :BLOCK
R :BLOCK
NC-17 :BLOCK
X :BLOCK

MENU:RETURN
    
```

6 Press **MENU** to return to the V-CHIP select screen.



Parent Control (V-CHIP Operation) (Continued)

7 Press **MENU**, then "INPUT SECRET No." will be displayed.

Note:

- If SECRET No. is already set, skip to step 9.

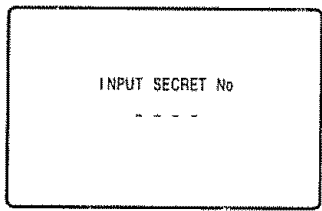

8 Enter a 4-digit SECRET No. using the **REMOTE KEYPAD**.

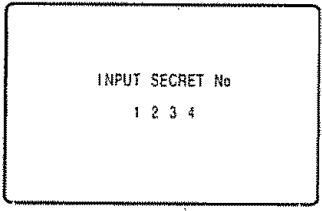
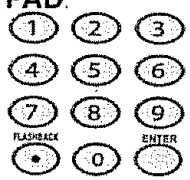

9 When done, press **MENU** to exit.

Note:

- If you set "G" to BLOCK, all ratings are automatically blocked.
- If you set "X" to BLOCK, "G", "PG", "PG-13", "R" and "NC-17" are not blocked.

[2] TV GUIDELINES

- Repeat steps 1 to 4 of [1] **MPAA RATING**.
- Press **CH ▲/▼** to move the "●" mark to "TV GUIDELINES".

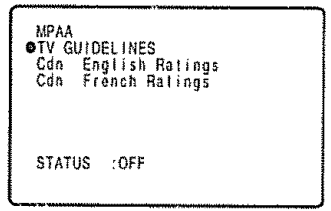
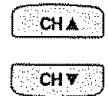

(V-CHIP select screen)

3 Press **VOL +/-** to access the TV GUIDELINES screen.



- To change AGE and CONTENT SETTING, press **CH ▲/▼** to move the "●" mark to the desired rating and then press **VOL +/-** to select.

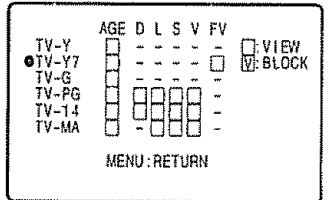
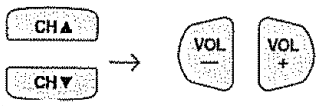

(TV GUIDELINES screen)

- Press **CH ▲/▼** to move the "●" mark to the desired content item and then press **VOL +/-** to select either "BLOCK" or "-----" (unblock).

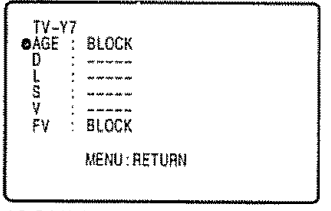
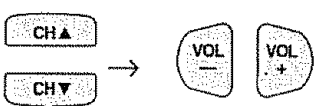

(CONTENT RATING screen)

- Press **MENU** to return to the TV GUIDELINES screen
- Repeat steps 4 to 6 until all ratings and their contents are set.
- When done, press **MENU** to return to V-CHIP select screen.
- Press **MENU** to exit.

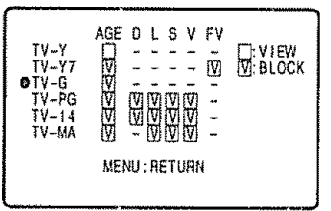

Note:

- If SECRET No. is not set, enter a SECRET No. as show in steps 7 and 8 of [1] **MPAA RATING**.

Parent Control (V-CHIP Operation) (Continued)

- How to set Canadian Rating System
Setting for Canadian English ratings and Canadian French ratings.

- 1 Repeat steps 1 to 4 of [1] MPAA RATING.
- 2 Press **CH ▲/▼** to move the "●" mark to "Cdn. English Ratings", then press **VOL +/-**.

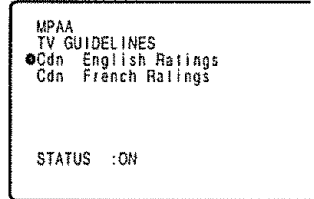
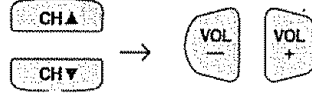

- 3 Press **CH ▲/▼** to move the "●" mark to "PG" then press **VOL +/-** to select Block. If you set "PG" to block, "14 +" and "18 +" are automatically blocked.

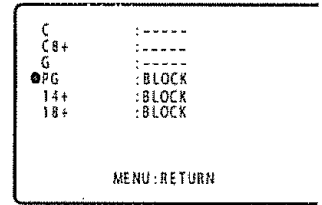
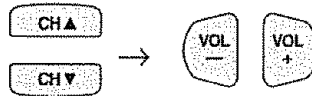

- 4 You can select "BLOCK" or "-----" (unblock) rating items by pressing **CH ▲/▼** and **VOL +/-** if you select "Cdn. French Ratings" in step 2. If you select "8 +" to BLOCK, "13 +", "16 +" and "18 +" are automatically blocked.

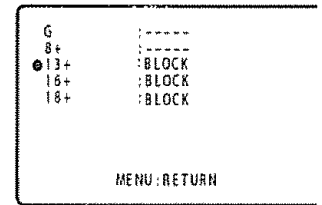
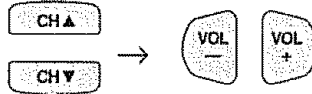

Parent Control (V-CHIP Operation) (Continued)

• Activating the V-CHIP BLOCK

1 Repeat steps 1 to 4 of [1] MPAA RATING.

2 Press **CH ▲/▼** to move the "●" mark to "STATUS". Press **VOL +/-** to activate the V-CHIP BLOCK. (If STATUS is OFF, V-CHIP BLOCK will not operate.)

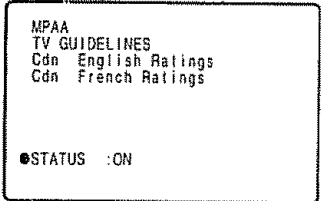
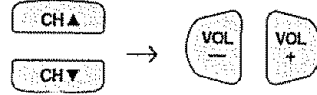

(V-CHIP select screen)

3 Press **MENU**, then "INPUT SECRET No." will be displayed.

Note:

- If SECRET No. is already set, skip to step 5.

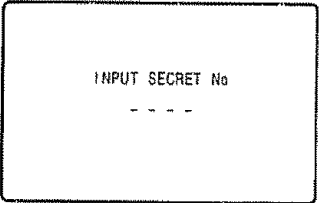

4 Enter a 4-digit secret No. using the **REMOTE KEYPAD**.

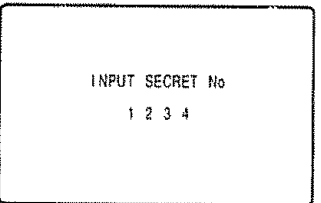
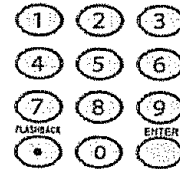

5 Press **MENU** and the secret No. will be registered.



• To temporarily cancel the V-CHIP BLOCK

1 "V-CHIP HAS BEEN ACTIVATED" appears if you view a program with the same program rating data you configured.

Note:

- "V-CHIP HAS BEEN ACTIVATED" will not be displayed if STATUS is not configured to "ON".

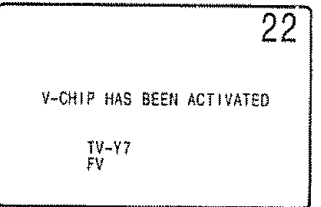

2 Press **MENU**, then "INPUT SECRET No." will be displayed.

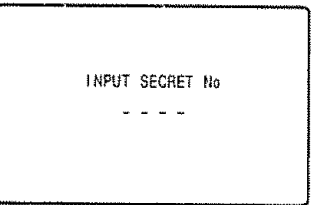

3 Enter the 4-digit secret No. using the **REMOTE KEYPAD**, then V-CHIP BLOCK will be canceled temporarily. If the wrong secret No. is chosen, "SECRET No. IS INCORRECT" will be displayed. Input the secret No. again in this case.

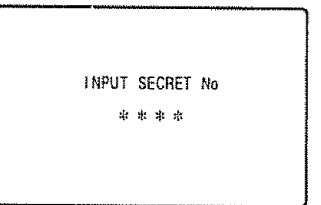
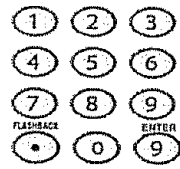

Note:

- If you turn the power ON from OFF, the V-CHIP BLOCK will be activated again.

Parent Control (V-CHIP Operation) (Continued)

• To change the V-CHIP BLOCK after registering a secret No.

1 Repeat steps 1 to 4 of [1] MPAA RATING, then "INPUT SECRET No." will be displayed.

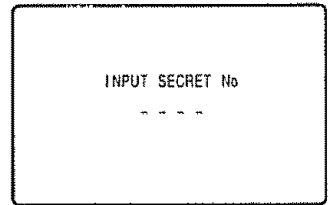

2 Enter the 4-digit secret No. using the **REMOTE KEYPAD** and the V-CHIP select screen will be displayed. Set V-CHIP BLOCK again.

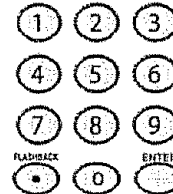

• If you forget or need to change your secret No., clear the original secret No. and set up a new one.

1 Repeat steps 1 to 4 of [1] MPAA RATING, or 1 to 2 of To temporarily cancel the V-CHIP BLOCK, then "INPUT SECRET No." will be displayed.

2 Press and hold both **VOL +** and **CH ▲** on the TV set simultaneously until the message "INPUT SECRET No." disappears.

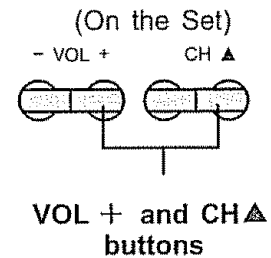

3 Press the **MENU** button twice to exit.



Parent Control (VIEW TIMER)

VIEW TIMER

This function allows you to restrict TV viewing time and also allows you to control TV usage. This function is to prevent your children from watching too much TV.

VIEWING TIME (an accumulative timer: counts only the time duration while the TV power is on.)

- VIEWING TIME can be set from 30M (30 minutes) to 10H00M (10 hours) in 30 minutes intervals.

OFF TIME (Restricts TV viewing after the VIEWING TIME reaches zero.)

- OFF TIME can be set from 30M (30 minutes) to 10H00M (10 hours) in 30 minutes intervals.

STATUS (Select ON to activate VIEW TIMER)

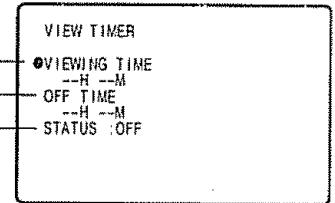

How to set VIEW TIMER

- Press **MENU** to access the MAIN MENU screen.
- Press **CH ▲/▼** to move the "●" mark to "PARENT CONTROL".

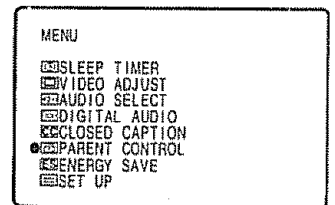
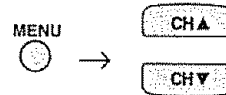

(MAIN MENU screen)

- Press **VOL +/-** to access the PARENT CONTROL screen.
- Press **CH ▲/▼** to move the "●" mark to "VIEW TIMER".

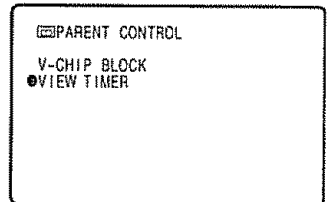
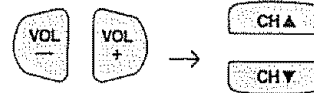

(PARENT CONTROL screen)

- Press **VOL +/-** to access "VIEW TIMER".

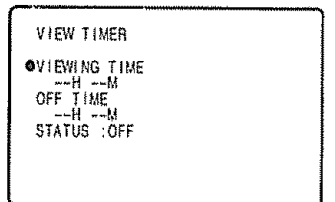

- Press **CH ▲/▼** to select "VIEWING TIME" and "OFF TIME". For each selection, press the **VOL +/-** to set the time duration.

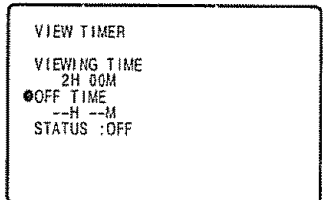
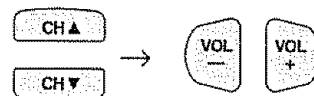

- Press **CH ▲/▼** to select "STATUS". Press the **VOL +/-** to turn ON the "VIEW TIMER". (If STATUS is OFF, VIEW TIMER will not operate.)

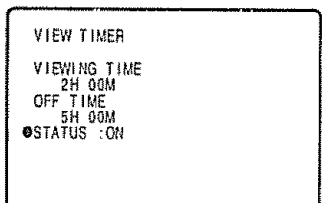
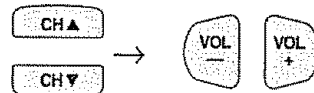

- Press **MENU**. "INPUT SECRET No." will be displayed.

Note:

- If SECRET No. is already set, skip to step 10.

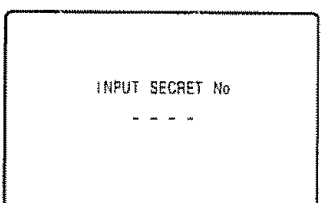

Parent Control (VIEW TIMER) (Continued)

9 Enter a 4-digit secret No. using the **REMOTE KEYPAD**.

10 Press **MENU** to exit.

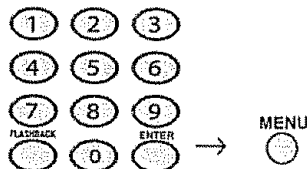

INPUT SECRET No
1 2 3 4

Example:

- To restrict anybody from watching TV for more than 5 hours, after watching the TV for 2 hours, your settings would look like the one on the right.
- You can choose to watch the 2 hours of TV as you wish. For example, you could watch 1 hour of TV, turn the TV off for 30 minutes, then turn the TV on and watch the remaining 1 hour of the VIEWING TIME.

VIEW TIMER
VIEWING TIME
2H 00M
OFF TIME
5H 00M
●STATUS :ON

- **To change the VIEW TIMER setting after registering a secret No.**

1 Repeat steps 1 to 4 of **How to set VIEW TIMER**. Press **VOL +/-**, and "INPUT SECRET No." will be displayed.



INPUT SECRET No
- - - -

2 Enter the 4-digit secret No. using the **REMOTE KEYPAD**, and the VIEW TIMER access screen will be displayed. Repeat steps 5, 6.

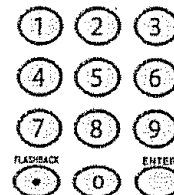

INPUT SECRET No
* * * *

Note:

- When you choose the correct secret No., the VIEW TIMER access screen is displayed. If the wrong secret No. is chosen, "SECRET No. IS INCORRECT" is displayed. Input the secret No. again in this case.

SECRET No IS INCORRECT

- **To cancel the VIEW TIMER (While the TV set is OFF but the VIEW TIMER is set.)**

1 Turn on the TV; a blue screen message "TIME OVER" will appear. If you do nothing, the TV will turn off in approximately 30 seconds.

TIME OVER

INPUT SECRET No
- - - -

2 Enter the 4-digit secret No. using the **REMOTE KEYPAD**. When you choose the correct secret No., the VIEW TIMER is canceled. If the wrong secret No. is chosen, "SECRET No. IS INCORRECT" is displayed. Input the secret No. again in this case.

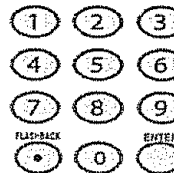

TIME OVER

INPUT SECRET No
* * * *

Parent Control (VIEW TIMER) (Continued)

- To cancel the VIEWTIMER setting or change the secret No. (If you forget the SECRET No.)

1 Repeat steps 1 to 4 of **How to set VIEW TIMER**. Press **VOL +/-**, and "INPUT SECRET No." will be displayed.

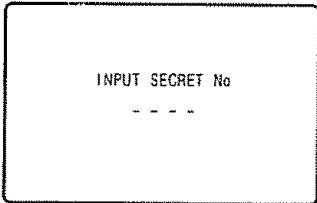
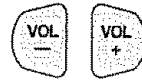

2 Press and hold both **VOL +** and **CH ▲** on the TV set simultaneously until the VIEW TIMER access screen is displayed. Now you can cancel the VIEW TIMER settings or change the secret No. while "INPUT SECRET No." is displayed.

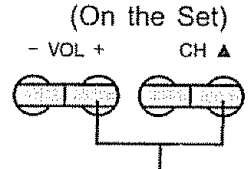

VOL + and CH▲

• **Notice of Remaining VIEWING TIME**

- For every 30 minute interval, the remaining time will be displayed for 4 seconds. For the last 5 minutes, the remaining time will be displayed every minute.
- "0 REMAIN" will be displayed for 10 seconds just before the VIEWING TIME expires.

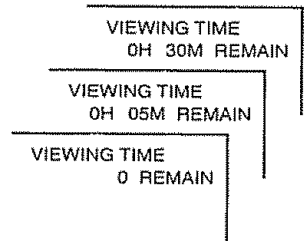

Energy Save

SCREEN

This feature lets you lower the power consumption of your TV set which in turn saves you money and minimizes the impact on the environment. When this feature is turned on, it reduces the brightness of the TV to a level that consumes approximately 20 percent less energy than when the feature is turned off. The reduction in brightness will be less noticeable under low room lighting conditions.

STANDBY

If set to OFF: No power save during standby mode.

ON: With power save during standby mode. When change your TV channel to a digital channel will take approximately 10 seconds to display.

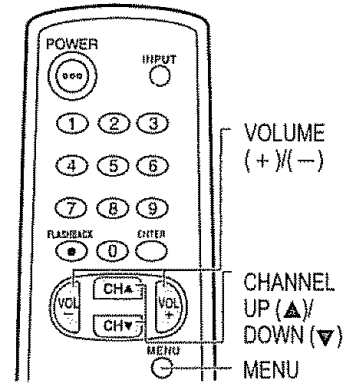

1 Press **MENU** to access the MAIN MENU screen.

2 Press **CH ▲/▼** to move the "●" mark to "ENERGY SAVE".

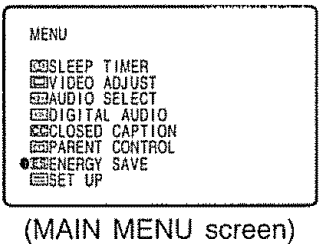

3 Press **VOL +/-** to access the ENERGY SAVE select screen.

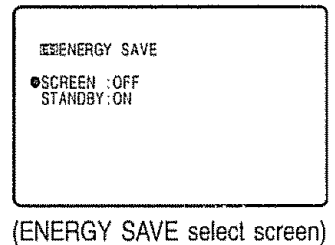

4 Press **CH ▲/▼** to move the "●" mark to either "SCREEN" or "STANDBY".

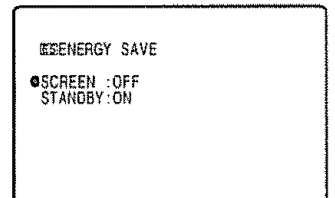
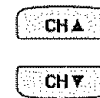

5 Press **VOL +/-** to select "ON" or "OFF".

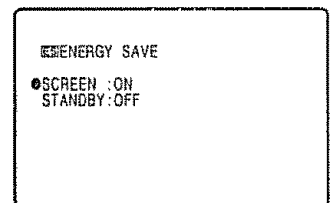
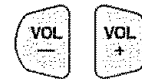
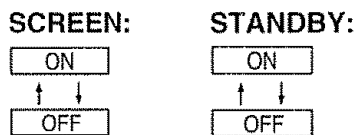

6 Press **MENU** to exit.



Set Up

EZ Setup

By operating the channel preset functions, you can preset your TV to the desired channels for viewing.

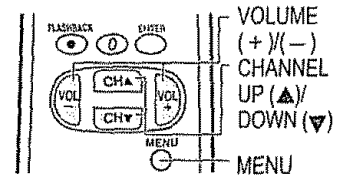

- 1 Press **MENU** to access the MAIN MENU screen.
- 2 Press **CH ▲/▼** to move the "●" mark to "SET UP".

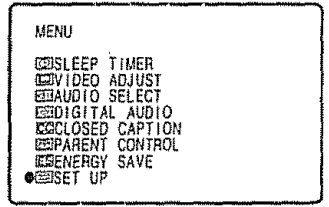
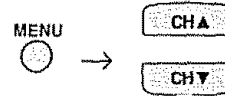

(MAIN MENU screen)

- 3 Press **VOL +/-** to access the SET UP screen, then press **CH ▲/▼** to move the "●" mark to "CH SETTING".

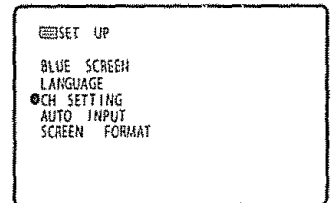
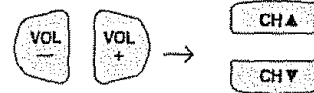

(SET UP screen)

- 4 Press **VOL +/-** to access the CH SETTING screen.

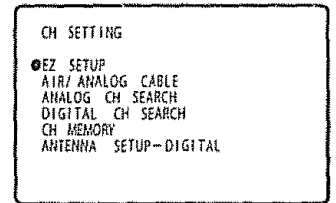
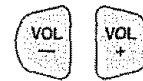

(CH SETTING screen)

- 5 Press **VOL +/-** to access the EZ SETUP screen.

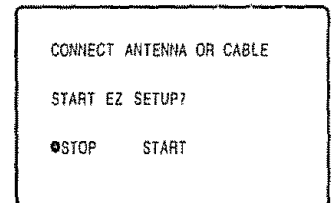
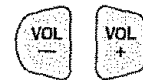

(EZ SETUP screen)

- 6 Press **VOL +**.

The tuner will automatically search for the broadcasting and cable TV channels for ANALOG. (The CH No. will automatically increase when it appears.)

Once tuning for analog AIR channel is finished, tuning for digital channel will start.

If you want to stop the EZ SETUP process once it has started, press **VOL -** and it will be canceled.

To cancel EZ SETUP

Press **VOL -**.

(START)



(Analog channel tuning)

(STOP)

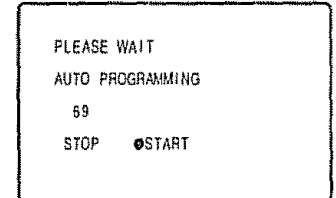

(Digital channel tuning)

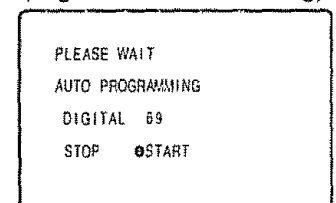

Set Up (Continued)

7 Once EZ SETUP is complete, the lowest channel number memorized will be displayed.

2

Channel Setting

If EZ SETUP does not memorize all the channels in your region, follow the instructions below to manually memorize the channel.

1 Press **MENU** to access the MAIN MENU screen.

2 Press **CH ▲/▼** to move the "●" mark to "SET UP".

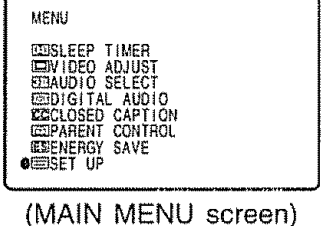
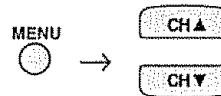

3 Press **VOL +/-** to access the SET UP screen.

4 Press **CH ▲/▼** to move the "●" mark to "CH SETTING".

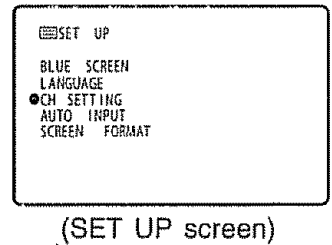
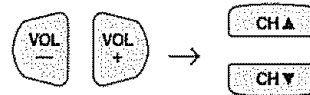

5 Press **VOL +/-** to access the CH SETTING screen.

Note:

- If the viewing channel is an analog channel, Antenna Setup Digital cannot be selected.
- During Cable mode, Digital Channel Search and Antenna Setup Digital cannot be selected.

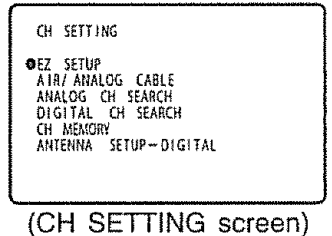
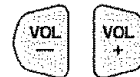

6 Press **CH ▲/▼** to move the "●" mark to "AIR/ANALOG CABLE", then press **VOL +/-** to access the AIR/CABLE screen.

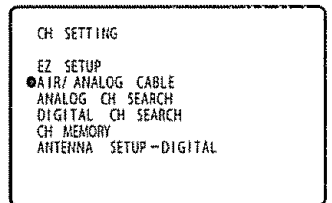
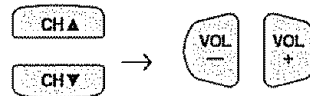

7 Press **CH ▲/▼** to move the "●" mark to the desired mode.

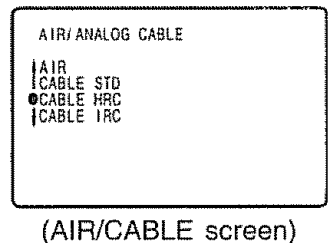
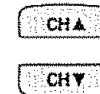

8 Press **MENU** to exit.

Note:

- Receivable channels of your TV set are:
AIR channels:
VHF: 2 through 13.
UHF: 14 through 69.

- CABLE channels:
1 (HRC and IRC mode only)
2 through 125 (STD, HRC and IRC)



Set Up (Continued)

ANALOG CH SEARCH

Saving ANALOG broadcast TV channels into memory

- 1** Repeat step 1 to step 5 of **Channel Setting**. (See page 33)
Press **CH ▲/▼** to move the "●" mark to "ANALOG CH SEARCH".

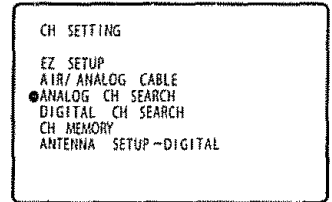

(CH SETTING screen)

- 2** Press **VOL +/-** to access the ANALOG CH SEARCH screen.

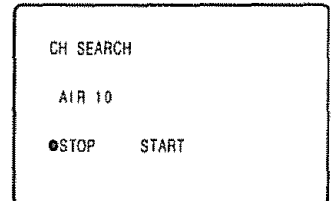
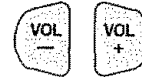

(CH SEARCH screen)

To start:

Press **VOL +**. The tuner will search through all available channels in your area and add them into the TV memory.

(START)



To stop:

Press **VOL -**. CH SEARCH will stop at the current channel and will not add any higher channels.

(STOP)



- 3** Press **MENU** to exit.



Note:

- If you press **VOL +** again while in the CH SEARCH mode, auto-program will start again, and the previously memorized channels will be lost.

DIGITAL CH SEARCH

Saving DIGITAL broadcast TV channels into memory

- 1** Repeat step 1 to step 5 of **Channel Setting**. (See page 33)
Press **CH ▲/▼** to move the "●" mark to "DIGITAL CH SEARCH".

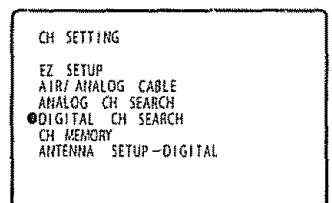

(CH SETTING screen)

- 2** Press **VOL +/-** to access the DIGITAL CH SEARCH screen.

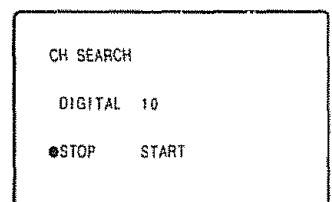

(CH SEARCH screen)

To start:

Press **VOL +**. The tuner will search through all available channels in your area and add them into the TV memory.

(START)



To stop:

Press **VOL -**. CH SEARCH will stop at the current channel and will not add any higher channels.

(STOP)



- 3** Press **MENU** to exit.



Set Up (Continued)

■ CH MEMORY

Adding weak or additional channels or erasing unwanted channels from TV memory

- 1** Repeat step 1 to step 5 of **Channel Setting**. (See page 33)
Press **CH ▲/▼** to move the "●" mark to "CH MEMORY".



```

CH SETTING
EZ SETUP
AIR/ ANALOG CABLE
ANALOG CH SEARCH
DIGITAL CH SEARCH
●CH MEMORY
ANTENNA SETUP-DIGITAL
    
```

(CH SETTING screen)

- 2** Press **VOL +/-** to access the CH MEMORY screen.
3 Use **CH ▲/▼** to select each desired channel to add or erase.

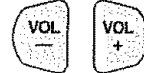

```

CH MEMORY

AIR 10

●ERASE  ADD
    
```

(CH MEMORY screen)

- 4** Press **VOL +** to add a channel to the TV memory or press **VOL -** to erase a channel from the TV memory.



```

CH MEMORY

AIR 10

●ERASE  ADD
    
```

(CH MEMORY unmemorized channel)

VOL +
To add channel 10 to the TV memory

VOL -
To erase channel 10 from the TV memory

```

CH MEMORY

AIR 10

ERASE ●ADD
    
```

(CH MEMORY memorized channel)

- 5** Press **MENU** to exit.



Set Up (Continued)

■ BLUE SCREEN

Automatically turns the screen blue if a broadcast signal is not received. After 15 minutes of non-reception, the TV will turn off automatically.

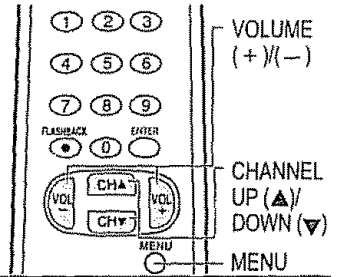

- 1 Press **MENU** to access the MAIN MENU screen.
- 2 Press **CH ▲/▼** to move the "●" mark to "SET UP".

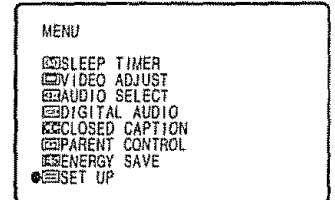

(MAIN MENU screen)

- 3 Press **VOL +/-** to access the SET UP screen.

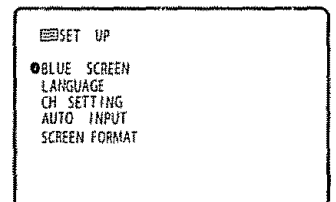
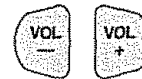

(SET UP screen)

- 4 Press **VOL +/-** to access the BLUE SCREEN select screen.

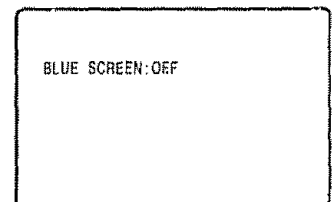

(BLUE SCREEN select screen)

- 5 Press **VOL +/-** to select "ON".

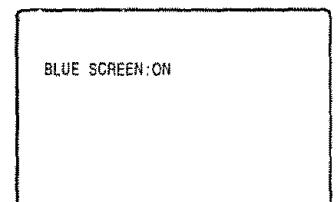
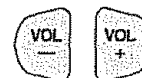

- 6 Press **MENU** to exit.



When the BLUE SCREEN is set to "ON"

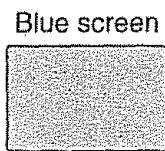
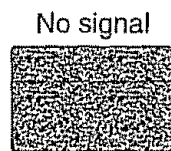

after 15 minutes

Power turns off automatically



Standby mode

Note:

- Poor reception due to weak signals, or too much noise might activate the BLUE SCREEN function despite the presence of a broadcast signal. To continue watching TV under these conditions, switch the BLUE SCREEN "OFF".
- While INPUT 1, 2, or 3 (COMPONENT) is selected, the BLUE SCREEN will not be shown even if BLUE SCREEN is turned on.

Auto Input

- The unit is preset to switch to the INPUT 2 screen automatically when VIDEO equipment is connected to the INPUT 2 terminal. Do the following to switch this feature off:

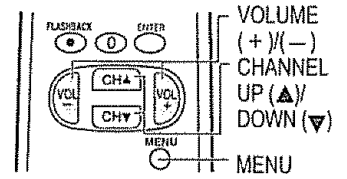

- Press **MENU** to access the MAIN MENU screen.
- Press **CH ▲/▼** to move the "●" mark to "SET UP".

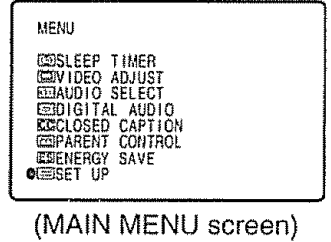
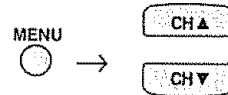

- Press **VOL +/-** to access the SET UP screen, then press **CH ▲/▼** to move the "●" mark to "AUTO INPUT".

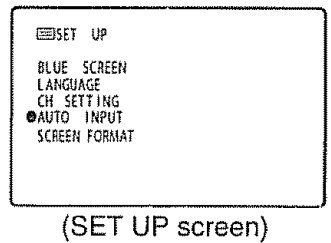
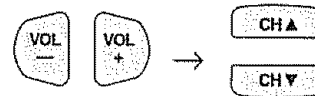

- Press **VOL +/-** to access the AUTO INPUT select screen. Press **VOL +/-** to select "AUTO".

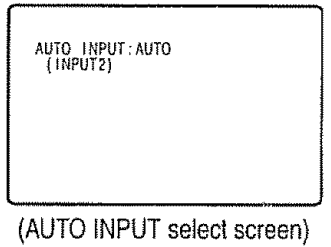
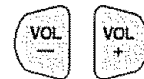

- You may turn off "AUTO INPUT" when it is not in use. Press **VOL +/-** to select "OFF".

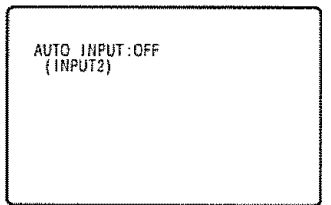
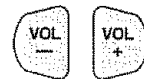

- Press **MENU** to exit.



Screen Format

- The format of the picture can be adjusted to either of the three screen formats.
(This function allows you to view 16:9 pictures recorded on DVD or by camcorders that are once saved using the 4:3 aspect ratio to be played back in the original high-density 16:9 format.)

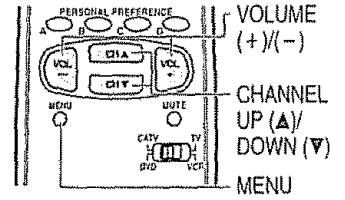

- Press **MENU** to access the MAIN MENU screen.
- Press **CH ▲/▼** to move the "●" mark to "SET UP".

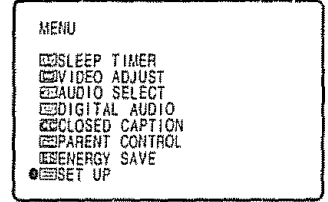
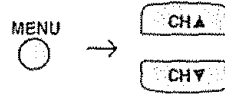

(MAIN MENU screen)

- Press **VOL +/-** to access the SET UP screen, then press **CH ▲/▼** to move the "●" mark to "SCREEN FORMAT".

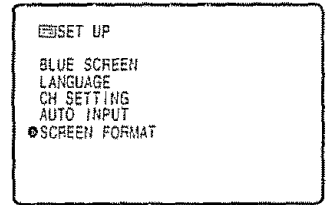
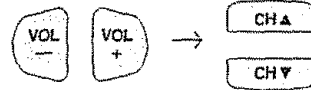

(SET UP screen)

- Press **VOL +/-** to access the SCREEN FORMAT select screen.

Note:

- If the viewing channel is an analog channel, INPUT 1, INPUT 2 and INPUT 3, STRETCH cannot be selected.

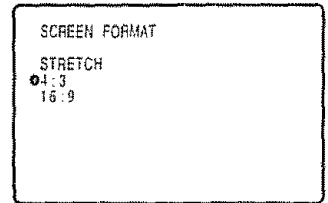
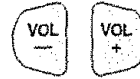

(SCREEN FORMAT select screen)

- Press **CH ▲/▼** to select "STRETCH", "4:3" or "16:9".

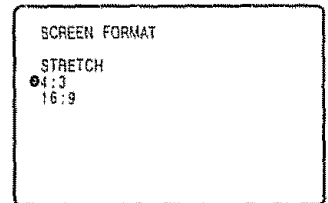

Screen Format

6 Press MENU o exit.

Note:

- The STRETCH and 16:9 screen format will be cancelled when the power is turned off.

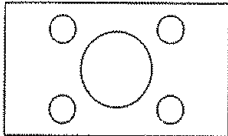
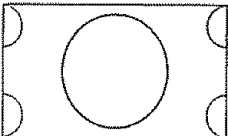
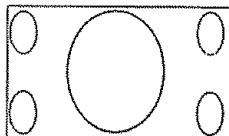
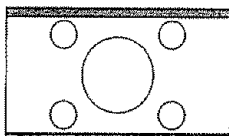
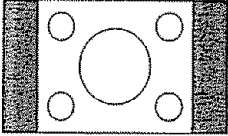
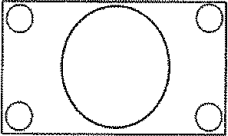
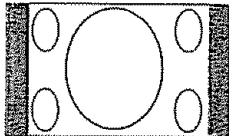
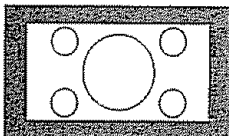
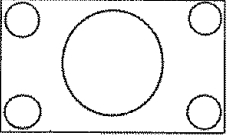
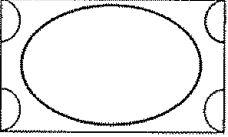
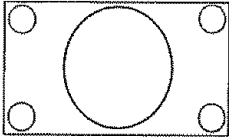
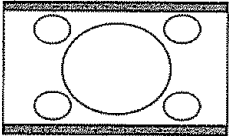
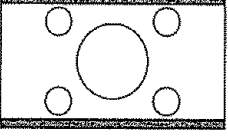
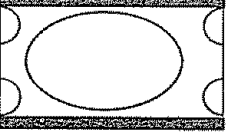
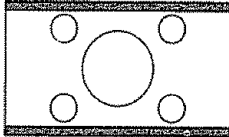
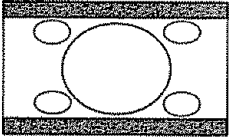
| While format of signal received | Mode set to STRETCH | Mode set to 4:3 | Mode set to 16:9 |
|--------------------------------------------------------------------------------------------------------|-------------------------------------------------------------------------------------|---------------------------------------------------------------------------------------|---------------------------------------------------------------------------------------|
|  |  |  |  |
| Full 16:9  |  |  |  |
| Side panel 16:9  |  |  |  |
| Letter Box 4:3  |  |  |  |

Note:

- The STRETCH and 16:9 screen format will be cancelled when the AC power cord is unplug.
- If STRETCH mode is selected, the quality of picture might be poor.
- This function can be selected independently among AIR/CABLE, INPUT 1, INPUT 2, INPUT 3 (COMPONENT) and Digital Channel.

Using the Video and Audio Input Terminals

- Connecting video equipment for playback of video material.
- To view video material from external video equipment, make sure to connect the equipment properly

Connecting video device equipped with video output terminals

CONNECTIONS

VIDEO EQUIPMENT

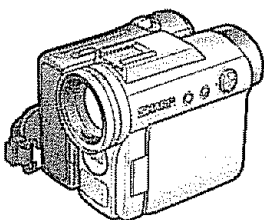

CAMCORDER

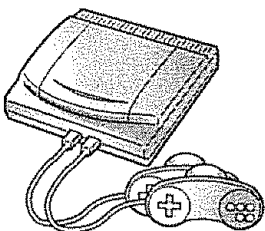

TV GAME



VCR

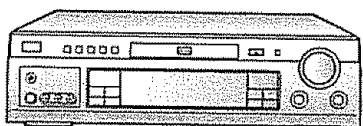

DVD

Yellow : To video input terminal
 White : To audio input (L) terminal
 Red : To audio input (R) terminal

(Front connection terminals of TV)
 Pull open the front door

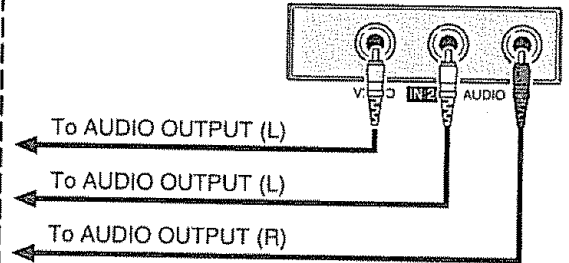

(Rear connection terminals of TV)

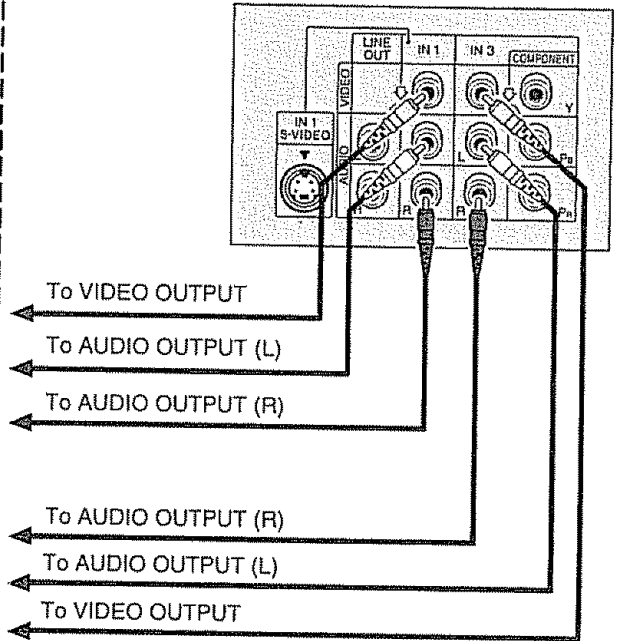

Using the Video and Audio Input Terminals (Continued)

Notes:

- COMPONENT terminals are DVD compatible, allows you to enjoy the highest quality playback image than the image from IN 1 S-VIDEO terminal.
- The IN 1 S-VIDEO terminal is used to obtain a higher quality image by importing image signals.
- The S-VIDEO terminal is for the video image only. To receive an audio signal, connect the audio cable to the IN 1 AUDIO terminals (left and right).

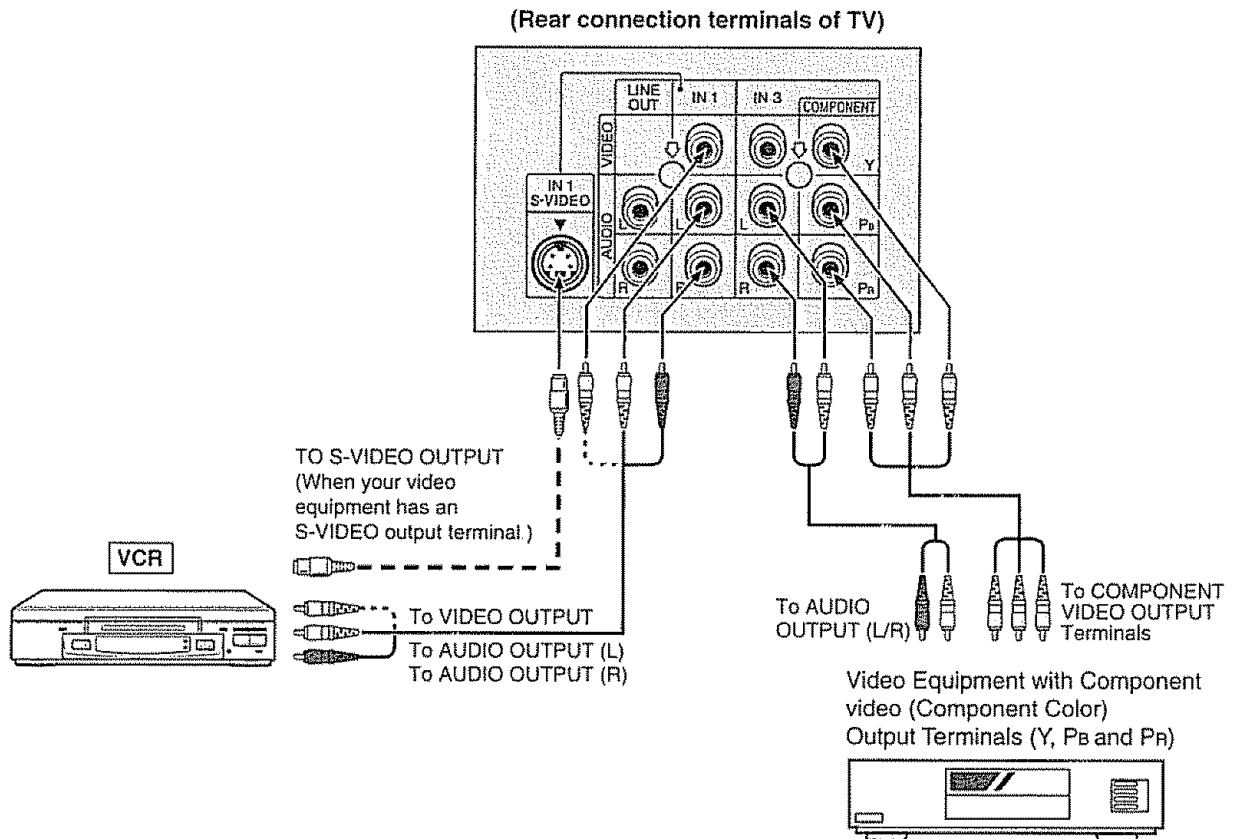

• To watch video material playback

- Press the Remote's **INPUT** button to select the VIDEO INPUT mode for the video equipment you wish to play.
- The external VIDEO INPUT mode will change as follows each time the **INPUT** button is pressed.

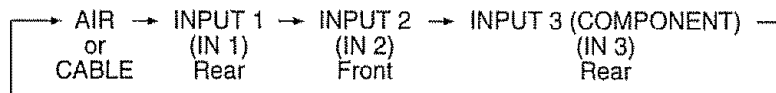

- When the AV cables are connected to the VIDEO INPUT 3 and COMPONENT Y, Pb and Pr terminals simultaneously, the COMPONENT terminal has priority over the VIDEO terminal.
- INPUT mode can be selected by pressing either the **CH ▲** on the TV remote control when the TV is set to the highest channel stored in memory, or by pressing the **CH ▼** when it is set to the lowest channel.

Note:

- When connecting video or audio equipment to the television, be sure that the power is turned off in order to prevent damage to either the television or the equipment being connected.
- The S-Video terminal has priority over the VIDEO terminal (IN 1). When you wish to use video equipment connected to the VIDEO terminal (IN 1), unplug equipment connected to the S-VIDEO terminal.
- For detailed information on the connection and use of auxiliary equipment, refer to the instruction manuals of the equipment being used.
- The connection cables/cords can be obtained from your local video store.

Using the Audio Output Terminals

- These terminals are used for connecting an external audio amplifier. The STEREO/MONO/SAP, VOLUME, MUTE and FAO functions can all be controlled via the television's remote control or directly on the TV itself. These terminals relay the audio signal of all programs being displayed on the TV screen.

(AUDIO OUTPUT terminals are located on the rear of the cabinet.)

CONNECTIONS

(Rear connection terminals of TV)

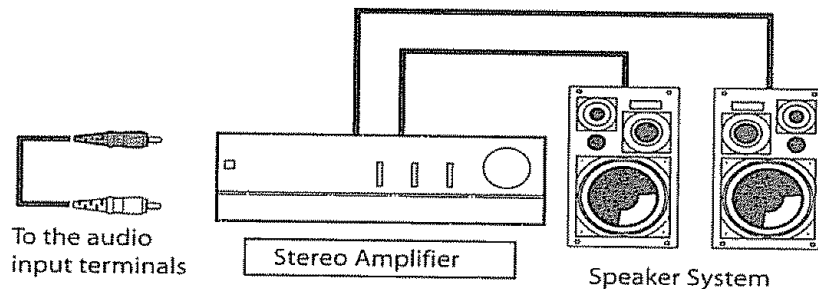
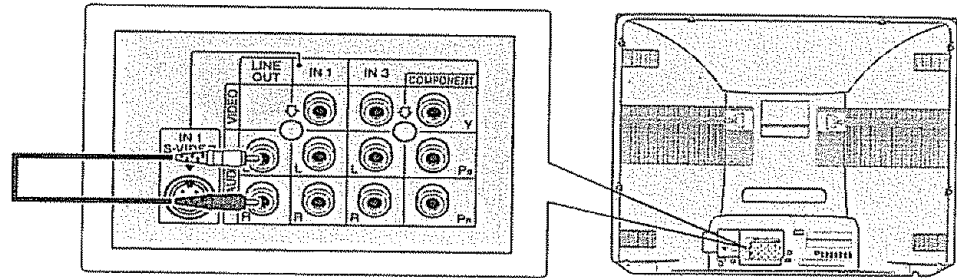

- (1) Before connecting the cables, turn on the TV and adjust the TV volume for a moderate listening level.
- (2) Turn off the TV and connect the audio cables to the AUDIO LINE OUTPUT terminals on the TV.
- (3) Turn the TV set and stereo amplifier on.
- (4) If you desire, you can turn off the sound of the TV's internal speakers by accessing the TV's AUDIO SELECT screen. See pages 15, 16.
- (5) Adjust the volume control on the stereo amplifier to a moderate listening level.
- (6) Control of the audio can be adjusted using the audio controls (STEREO/MONO/SAP, VOLUME, MUTE and FAO), from either the remote control, or directly from the TV set.

Note:

- For detailed information on the connection and use of auxiliary equipment, refer to the operation manuals of the equipment being used.
- When connecting monaural equipment to the AUDIO INPUT or OUTPUT of this set, use an audio connection cord and plug adaptor as shown below.
- When FAO is set to "OFF", we recommend you to keep the TV's audio output level high for optimal sound quality. (see page 15.)

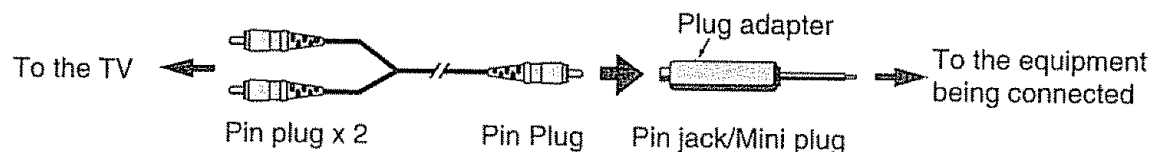

Before Calling for Service

Check these items and see if you can correct the trouble with a slight adjustment of the controls

| QUICK SERVICE CHECK LIST | PROBLEM | No Playback of VCR and Disc Player | No Picture or Sound from External Video/Audio Products | Remote Control Doesn't Work | Bars on Screen | Picture Distorted | Picture Rolls Vertically | No Color | Poor Reception on Some Channels | Weak Picture | Lines or Streaks in Picture | Ghosts in Picture | Picture Blurred | Sound OK, Picture Poor | Picture OK, Sound Poor | No Picture or Sound | Dark and Blank Picture | External Electrical Noise Interfering with TV's Operation | Color on Part of the Screen Appears Distorted |
|----------------------------------------------------------------------------------------------------|----------------|------------------------------------|--------------------------------------------------------|-----------------------------|----------------|-------------------|--------------------------|----------|---------------------------------|--------------|-----------------------------|-------------------|-----------------|------------------------|------------------------|---------------------|------------------------|-----------------------------------------------------------|-----------------------------------------------|
| POSSIBLE REMEDY | | | | | | | | | | | | | | | | | | | |
| Try a new channel, if OK, then there is a possible station trouble. | | | | | | X | X | X | X | X | X | X | X | X | X | X | | | |
| Is TV plugged in? Power at outlet? | | X | X | | | | | | | | | | | | | X | | | |
| Is TV's POWER button on? | | X | | | | | | | | | | | | | | X | | | |
| Is antenna connected to terminal on the back of the set? | | | | | | | | X | X | X | | X | | X | X | | | | |
| If outside antenna is being used, check for broken wire. | | | | | X | X | X | X | X | X | X | X | X | | | | | | |
| Check for local interference or external electrical noise | | | | | X | X | | X | | X | X | | X | X | | | X | | |
| Turn off the POWER and then turn it on after about a minute. | | X | | | | | | | | | | | | | | X | | | |
| Adjust COLOR control. | | | | | | | | X | | | | | | | | | | | |
| Adjust PICTURE control. | | | | | | | | | | X | | | | X | | | | | |
| Check external Video/Audio products: look for loose/broken connection leads (Refer to pages 40-42) | X | X | | | | | | | | | | | | X | X | X | | | |
| Check batteries of Remote Control. | | | | X | | | | | | | | | | | | | | | |
| Slide CATV/DVD-TV/VCR Select Switch to TV position. | | | | X | | | | | | | | | | | | | | | |
| Are audio cables connected firmly? Check the volume level. | | | | | | | | | | | | | | | | X | | | |
| Is SPEAKER ON? See pages 15,16 | | | | | | | | | | | | | | | | X | | | |
| Change Closed Caption mode to "OFF"/Energy Save mode to "OFF". | | | | | | | | | | | | | | | | | X | | |
| Unplug the TV and plug it in again after 2 minutes or longer | | | | X | | | X | X | X | X | | | | X | X | X | X | X | X |

Note:

- If no TEXT broadcast is being received while viewing in the TEXT mode, the screen may become dark and blank for some programs. Should this occur, switch the Closed Caption mode to "OFF".



(Dark and Blank Picture)

Calling for Service

For location of the nearest Sharp Authorized Servicer, or to obtain product literature accessories, supplies, or customer assistance, please call 1-800-BE-SHARP.

Warning message for Digital broadcasting

■ The warning message about reception of digital broadcast

| The example of an warning message displayed on a screen | Possible Solution |
|----------------------------------------------------------------------------------|---------------------------------------------------------------------------------------------------------------------------------|
| <ul style="list-style-type: none"> • Failed to receive broadcast. | <ul style="list-style-type: none"> • Check the antenna cable. Check that the antenna is correctly antenna setup. |
| <ul style="list-style-type: none"> • No broadcast now. | <ul style="list-style-type: none"> • Check the broadcast time in the program guide. |

Specifications

| | |
|---------------------------------------|----------------------------------------------------------------------------------------------------------------------------------------------------------------|
| MODEL | 32SC26B |
| Receiving System | American TV standard ATSC/NTSC system |
| Stereo Broadcast | MTS/SAP |
| Reception Channels | |
| AIR | VHF 2-13 ch |
| | UHF 14-69 ch |
| CATV | 1-125 ch |
| Digital Terrestrial Broadcast (8 VSB) | 2-69 ch |
| Channel Tuning | 181-channel Reception PLL tuning system |
| Antenna Input Impedance | VHF/UHF 75 ohm Unbalanced |
| Screen Size | 32" Diagonally Measured |
| Terminals | Audio/Video input x 3 (Front x 1, Rear x 2) S-Video input x 1 (Rear) COMPONENT x 1 (Rear) Audio output x 1 (Rear) Antenna x 1 (Rear) |
| Sound Output | 3 W (RMS) x 2 |
| Power Source | AC 120 V, 60 Hz |
| Power Consumption | 155 W |
| Dimensions [(W) x (H) x (D)] mm | 29 ⁷ / ₈ " (W) x 26 ⁴⁹ / ₆₄ " (H) x 21 ³ / ₈ " (D) [759 mm (W) x 680 mm (H) x 543 mm (D)] |
| Weight (approx.) | 112.4 lbs. (51 kg) |

- Design and specifications are subject to change without notice.

Lea estas instrucciones cuidadosamente y consérvelas a la mano para consultarlas en el futuro.

IMPORTANTE

Sírvase anotar el modelo del televisor y los números de serie en el espacio provisto, para ayudar a reportar en caso de pérdida o robo. Los números están ubicados en la parte posterior del televisor.

| |
|----------------|
| N° de modelo : |
| N° de serie : |

INFORMACIÓN IMPORTANTE

Existen dos razones importantes para registrar dentro del plazo límite la garantía de su nuevo televisor SHARP, mediante la TARJETA DE REGISTRO incluida con el aparato.



PRIMERA – GARANTÍA

Garantiza al cliente la recepción inmediata de todas las prestaciones de consumidor en cuanto a piezas, servicio técnico y mano de obra aplicable a su adquisición

SEGUNDA – ACTA DE SEGURIDAD DE PRODUCTOS DE CONSUMIDOR

Con el fin de garantizar al cliente la recepción puntual de cualquier notificación de seguridad sobre inspección, modificación o cancelación que se le pueda solicitar a SHARP bajo el Acta de seguridad de productos de consumidor de 1972. LEA CUIDADOSAMENTE LA CLÁUSULA “GARANTÍA LIMITADA” DE LA ÚLTIMA PÁGINA.

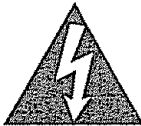
ADVERTENCIA : PARA REDUCIR EL RIESGO DE INCENDIO O DESCARGA ELÉCTRICA, NO EXPONGA ESTE APARATO A LA HUMEDAD.

| | | |
|---------------------------------------------------------------------------------------------------------------------------------------------------------------------------------------------------------------------------------------------------|-------------------------------------------------------------------------|-------------------------------------------------------------------------------------|
|  | <p>PRECAUCION</p> <p>RIESGO DE ELECTRO-CHOQUE NO ABRA</p> |  |
| <p>PRECAUCIÓN : PARA REDUCIR EL RIESGO DE DESCARGAS ELÉCTRICAS, NO RETIRE LA CUBIERTA (NI EL PANEL POSTERIOR). NO CONTIENE PIEZAS REPARABLES POR EL USUARIO. SOLICITE ASISTENCIA TÉCNICA A PERSONAL DE SERVICIO TÉCNICO ESPECIALIZADO.</p> | | |

 El relámpago con cabeza de flecha dentro de un triángulo trata de indicar al usuario que las partes dentro del producto representan riesgo de electrochoque para las personas.

 El signo de exclamación dentro de un triángulo trata de indicar al usuario que las instrucciones importantes de operación y servicio se encuentran en los documentos con el aparato.

“Nota para el instalador del sistema de TV por cable: Esta nota tiene el propósito de llamar la atención del instalador del sistema de cable acerca del Artículo 820-40 del Código Eléctrico Nacional, que contiene las directrices para la puesta a tierra y, en particular, especifica que el cable de puesta a tierra debe estar conectado al sistema de puesta a tierra del edificio lo más cerca a la entrada del cable.”

ADVERTENCIA - Las Normas de la FCC establecen que cualquier cambio o modificación no autorizada que se realice en este equipo y que no esté expresamente aprobado por el fabricante podría anular la autoridad del usuario para utilizar este equipo.

DESECHO DEL PRODUCTO
Este producto utiliza un Tubo de rayos catódicos (TRC) que contiene soldadura de estaño y plomo. El desecho de estos materiales deberá ser considerando regulaciones ambientales. Para obtener información sobre el desecho o el reciclado, póngase en contacto con las autoridades locales o con Electronics Industries Alliance: www.eiae.org

INFORMACIÓN IMPORTANTE (Continuación)

PRECAUCIÓN:

- No coloque el cable de alimentación de CA debajo del televisor u otro elemento pesado.
- Para impedir un incendio, no ponga nunca ningún tipo de vela o llama al descubierto encima o cerca del televisor.
- Para impedir un incendio o una descarga eléctrica, no exponga este aparato al goteo ni a las salpicaduras. Tampoco deberán ponerse encima de los productos objetos llenos de líquidos como, por ejemplo,

MEDIDAS DE SEGURIDAD IMPORTANTES

PRECAUCIÓN : Lea por favor todas estas instrucciones antes de poner en funcionamiento su televisor, y guárdelas para poder utilizarlas en el futuro.

La energía eléctrica permite realizar muchas funciones útiles. Este aparato ha sido diseñado y fabricado para garantizar su seguridad física. Sin embargo, UNA UTILIZACIÓN INAPROPIADA PODRÍA SER LA CAUSA DE DESCARGAS ELÉCTRICAS O INCENDIOS. Para mantener el buen funcionamiento de este equipo y evitar problemas, siga las normas básicas indicadas a continuación cuando lo instale, utilice o repare.

1. Desenchufe el televisor del tomacorriente antes de limpiarlo.
2. No utilice líquidos ni aerosoles de limpieza. Para limpiar el televisor utilice un paño húmedo.
3. No utilice accesorios que no los recomiende el fabricante del televisor porque podrían causar peligros.
4. No utilice el televisor cerca del agua – por ejemplo, cerca de una bañera, lavado, fregadero o lavadora, en un sótano húmedo, cerca de una piscina, etc.
5. No utilice este televisor sobre un carrito, un soporte o una mesa inestables. El televisor podría caerse causando serías heridas a niños o adultos, y, por supuesto, el aparato se estropearía. Ponga el televisor solamente sobre un carrito o soporte recomendado por el fabricante, o vendido junto con el televisor.
6. La combinación de carrito y televisor debe moverse con mucho cuidado. Las paradas rápidas, la fuerza excesiva y las superficies irregulares pueden ser la causa de que la combinación de televisor y carrito se volteen.
7. Cuando instale el televisor en una pared o en una estantería siga las instrucciones del fabricante, y utilice el kit de montaje aprobado por el fabricante.
8. Las ranuras y aberturas de la caja y del panel posterior o inferior sirven para la ventilación del aparato, para que éste funcione bien y para evitar que se caliente. Estas aberturas no deben taparse nunca. Este televisor no debe colocarse en un lugar cerrado (como un estante para libros) si éste no dispone de la ventilación apropiada.
9. Las aberturas no deben taparse nunca con un paño u otro material; y las aberturas del panel inferior no deben taparse tampoco colocando el televisor sobre una cama, sofá, alfombra u otra superficie similar. Este televisor no debe ponerse nunca cerca o encima de un radiador u otro aparato que produzca calor.
10. Este televisor sólo debe funcionar con la fuente de corriente indicada en la etiqueta del fabricante. Si no está seguro acerca del tipo de corriente de su hogar, póngase en contacto con el concesionario de quien adquirió el televisor o con la compañía eléctrica local.
En el caso de equipos de televisión diseñados para funcionar con baterías, consulte las instrucciones de uso.
11. Como medida de seguridad, el equipo de televisión está equipado con un enchufe polarizado de dos hilos. El enchufe polarizado de dos hilos solamente calza de una sola manera en el tomacorriente. Si el enchufe no entra en el tomacorriente, pídale a un electricista que le coloque un tomacorriente nuevo. No modifique el enchufe porque anulará esta característica de seguridad.
12. No permita que se apoye nada sobre el cable de alimentación. No ponga este televisor donde el cable pueda ser deformado por personas que caminen sobre él.



MEDIDAS DE SEGURIDAD IMPORTANTES (Continuación)

13. Cumpla con todos los avisos y las instrucciones marcados en el televisor.
14. Si se conecta una antena exterior al televisor, asegúrese de que el sistema de antena esté conectado a tierra para obtener cierta protección ante los aumentos de voltaje y la acumulación de cargas estáticas. La sección 810 del Código Eléctrico Nacional ofrece información relacionada con la conexión a tierra correcta del poste y la estructura de apoyo, la conexión a tierra del cable de entrada a una unidad de descarga, el tamaño de los conductores de conexión a tierra, la ubicación de la unidad de descarga de antena, la conexión a los electrodos de conexión a tierra, y los requisitos para el electrodo de conexión a tierra.

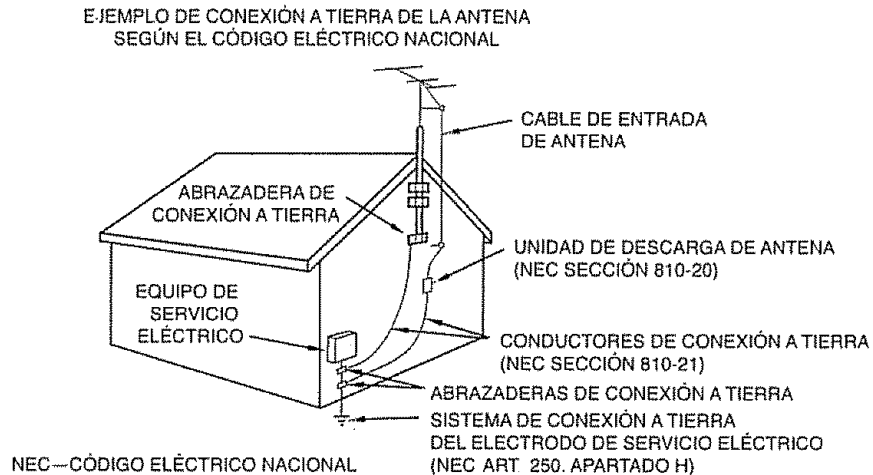

15. Para proteger aún más este televisor durante tormentas eléctricas o cuando se deje sin atender y sin utilizar durante largos periodos de tiempo, desenchufe el cable de alimentación del tomacorriente y desconecte la antena. Esto evitará que el aparato pueda estropearse debido a los relámpagos y la sobretensión en la línea de alimentación.
16. Un sistema de antena exterior no debe ubicarse cerca de líneas de alimentación elevadas, ni cerca de luces eléctricas o circuitos de alimentación. Tampoco debe ubicarse donde pueda caer sobre tales líneas o circuitos de alimentación. Cuando instale un sistema de antena exterior, tenga muchísimo cuidado para no tocar las líneas o circuitos de alimentación porque el contacto podría causar un accidente mortal.
17. No sobrecargue los tomacorrientes ni los cables de extensión porque esto podría causar un incendio o descarga eléctrica.
18. No meta nunca ningún objeto en el interior del televisor porque podría tocar piezas con alta tensión o causar un cortocircuito con otras piezas causando un incendio o descarga eléctrica. No derrame nunca ningún tipo de líquido sobre el televisor.
19. No trate de reparar el televisor usted mismo porque al abrir o quitar las tapas podría exponerse a una descarga de tensión u otros peligros. Las reparaciones debe realizarlas el personal de servicio CALIFICADO.
20. Desenchufe este televisor del tomacorriente y solicite el servicio de un técnico calificado cuando se produzcan las condiciones siguientes:
 - A. Cuando el cable de la alimentación o el enchufe estén estropeados
 - B. Cuando haya derramado un líquido sobre el televisor.
 - C. Si el televisor ha quedado expuesto a la lluvia o al agua.
 - D. Si el televisor no funciona normalmente siguiendo las instrucciones de utilización. Ajuste solamente los controles indicados en las instrucciones de utilización. Un ajuste inadecuado de otros controles podría estropear el aparato y, entonces, sería necesario acudir a un técnico CALIFICADO para que éste lo repare y lo devuelva a su condición normal.
 - E. Si el televisor se ha caído o la caja se ha estropeado.
 - F. Cuando las prestaciones del televisor cambien considerablemente será necesario llamar al servicio de reparaciones.
21. Al finalizar cualquier servicio o reparación de este televisor, pida al técnico de servicio que realice comprobaciones de seguridad rutinarias para determinar si el televisor puede funcionar sin causar ningún problema.
22. Cuando sea necesario cambiar piezas, cerciúrese de que el técnico de servicio utiliza las piezas de CAMBIO especificadas por el fabricante, aquellas que tengan las mismas características que las piezas originales. Las piezas de recambio no autorizadas pueden causar incendios, descargas eléctricas u otros peligros.

Referencia rápida de los controles de operación

Funciones Básicas Del Control Remoto

● Nombres de los componentes

(ESPAÑOL)

Panel Delantero

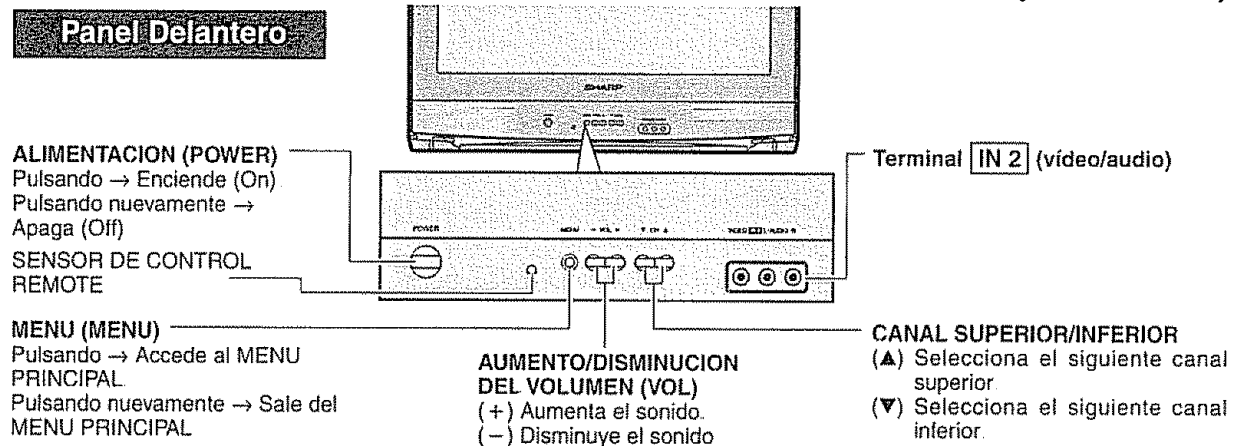

Funciones Básicas Del Control Remoto

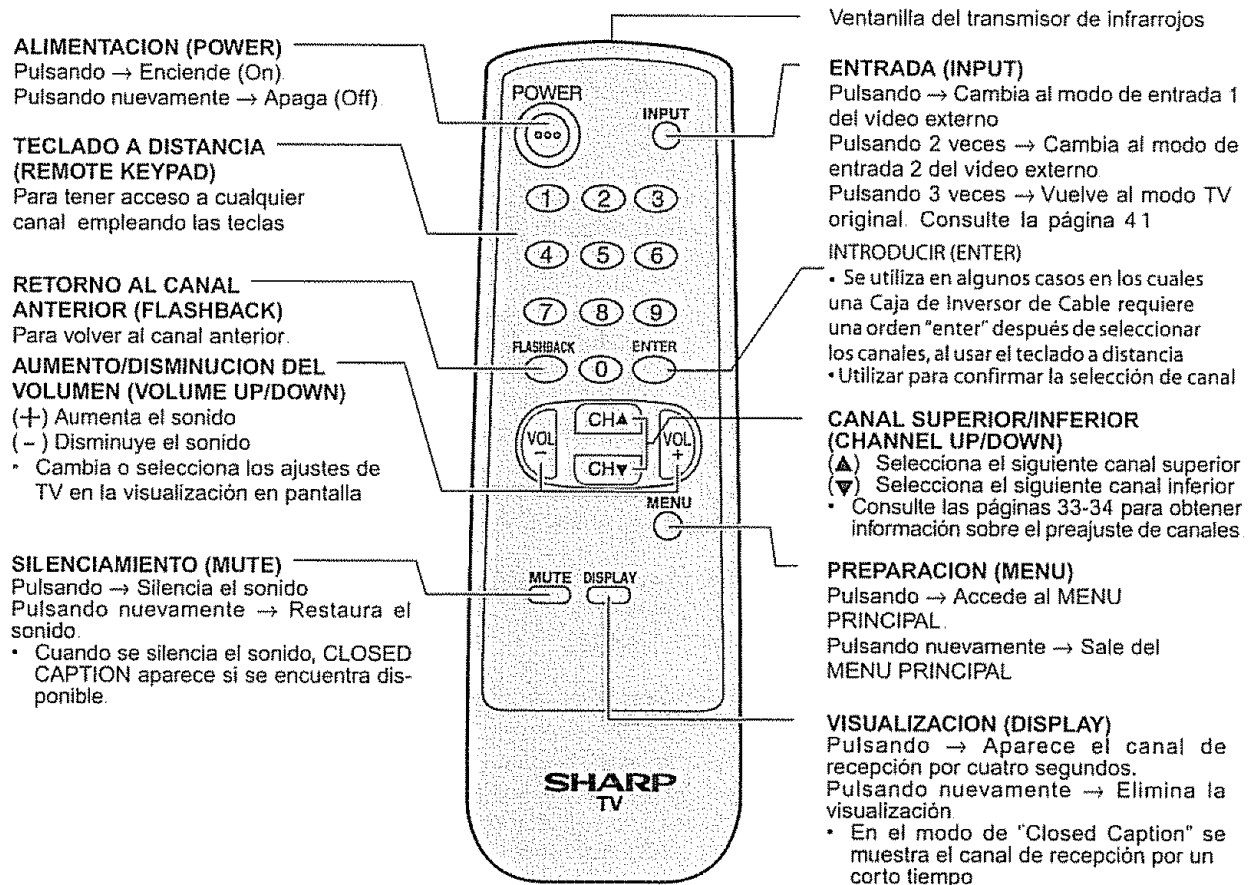

Antes de llamar al servicio de reparaciones

Verifique estos puntos para ver si usted mismo puede solucionar el problema.

| LISTA DE COMPROBACIONES DE SERVICIO RAPIDO | PROBLEMA | El video o el reproductor de discos de video no reproducen imágenes | El equipo de video/audio externo no produce imágenes ni sonido | El mando a distancia no funciona | Barras en la pantalla | Imagen distorsionada | La imagen se desplaza verticalmente | No hay color | Mala recepción de algunos canales | Imagen débil | Frayas en la imagen | Imagen fantasma | Imagen borrosa | Sonido adecuado, imagen mala | Imagen adecuada, sonido malo | No hay imagen ni sonido | Imagen oscura y en blanco | Interferencia de ruido eléctrico externo con el funcionamiento del televisor | El color se ve distorsionado en parte de la pantalla |
|-------------------------------------------------------------------------------------------------------|-----------------|---------------------------------------------------------------------|----------------------------------------------------------------|----------------------------------|-----------------------|----------------------|-------------------------------------|--------------|-----------------------------------|--------------|---------------------|-----------------|----------------|------------------------------|------------------------------|-------------------------|---------------------------|------------------------------------------------------------------------------|------------------------------------------------------|
| POSIBLE SOLUCIÓN | | | | | | | | | | | | | | | | | | | |
| Pruebe con otro canal y si todo está bien, el problema puede ser de la emisora. | | | | | | X | X | X | X | X | X | X | X | X | X | X | | | |
| Está conectado el televisor? Llega electricidad al tomacorrientes? | | X | X | | | | | | | | | | | | | X | | | |
| Está conectado el interruptor del televisor? | | X | | | | | | | | | | | | | | X | | | |
| Está conectado la antena al terminal del panel posterior del televisor? | | | | | | | | X | X | X | | X | | X | | X | | | |
| Si utiliza una antena exterior, cerciórese de que el cable no esté dañado. | | | | | X | X | X | X | X | X | X | X | X | X | | X | | | |
| Compruebe si hay interferencia local. | | | | | X | | X | | X | X | | | | X | X | | | X | |
| Desconecte el interruptor POWER y vuelva a conectarlo después de transcurrir un minuto. | | X | | | | | | | | | | | | | | X | | | |
| Ajuste el control de COLOR. | | | | | | | | X | | | | | | | | | | | |
| Ajuste el control de MATIZ. | | | | | | | | | | X | | | | X | | | | | |
| Verifique los productos externos de Video/Audio, revise si hay fugas de conexiones sueltas o rotas | | X | X | | | | | | | | | | | X | X | X | | | |
| Compruebe el estado de las pilas del mando a distancia. | | | | X | | | | | | | | | | | | | | | |
| Deslice CATV/DVD-TV/VCR selector para situarlo sobre la posición TV. | | | | X | | | | | | | | | | | | | | | |
| Están bien conectados los cables de sonido? Compruebe el nivel del volumen. | | | | | | | | | | | | | | | | X | | | |
| Está conectado el altavoz? | | | | | | | | | | | | | | | | X | | | |
| Desactive (OFF) el modo CLOSED CAPTION / Desactive (OFF) el modo Ahorro de Energía (Energy Save). | | | | | | | | | | | | | | | | | X | | |
| Desenchufe el televisor y vuelva a enchufarlo después de dos minutos o más | | | | X | | X | X | X | X | | | | | X | X | X | X | X | X |

Nota:

- Cuando se ve en modo TEXTO sin recibir emisiones de TEXTO, la pantalla puede ponerse en blanco y negro. Si ocurriera esto, ponga el modo CLOSED CAPTION en OFF.



(Imagen oscura y en blanco)

Solicitud de servicio técnico

Para la localización del Servicio Técnico Autorizado de Sharp más próximo o para conseguir material de información, repuestos o asistencia técnica, llame a 1-800-BE-SHARP.

Lisez attentivement ces instructions et gardez-les à proximité pour toute référence ultérieure.

IMPORTANT

Afin de vous aider en cas de perte ou de vol, inscrivez les numéros de série et de modèle du téléviseur dans les espaces fournis à cet effet. Ces numéros sont situés à l'arrière du téléviseur.

N° du modèle :

N° de série :

INFORMATIONS IMPORTANTES

Deux raisons importantes d'enregistrer rapidement la garantie de votre nouveau téléviseur SHARP à l'aide de la carte d'enregistrement (REGISTRATION CARD) incluse dans le colis :

LA PREMIERE – LA GARANTIE

Grâce à elle, vous obtiendrez immédiatement les avantages client concernant la garantie des pièces, du service et des travaux applicable à votre achat.

LA DEUXIEME – LA LOI SUR LA SECURITE DU PRODUIT DE CONSOMMATION (CONSUMER PRODUCT SAFETY ACT)

Grâce à elle, vous recevrez rapidement un avis de sécurité lors du contrôle, de la modification ou du rappel de votre produit que SHARP peut être amené à fournir conformément à la loi de 1972 sur la sécurité du produit de consommation. LISEZ ATTENTIVEMENT LE PARAGRAPHE «GARANTIE LIMITEE» DE LA DERNIERE PAGE

AVERTISSEMENT: POUR REDUIRE LE RISQUE D'INCENDIE OU D'ELECTROCUTION, N'EXPOSEZ PAS CET EQUIPEMENT A DES ENDROITS TRES HUMIDES.

| | | |
|------------------------------------------------------------------------------------------------------------------------------------------------------------------------------------------------------------------------------------|---------------------------------------------------------------------------|-------------------------------------------------------------------------------------|
|  | ATTENTION RISQUE D'ELECTROCUTION NE PAS OUVRIR |  |
| ATTENTION : POUR REDUIRE LE RISQUE D'ELECTROCUTION, NE RETIREZ PAS LE CAPOT (OU LE PANNEAU ARRIERE) L'APPAREIL NE CONTIENT AUCUNE PIECE A ENTREtenir PAR L'UTILISATEUR. CONSULTEZ UN PERSONNEL QUALIFIE POUR LA MAINTENANCE | | |



Le symbole de la foudre sous forme de flèche dans un triangle est supposé indiquer à l'utilisateur que les pièces internes au produit constituent un risque d'électrocution.



Le symbole du point d'exclamation dans un triangle est supposé indiquer à l'utilisateur que des instructions de fonctionnement et de maintenance importantes se trouvent dans la documentation fournie avec l'équipement.

"Note à l'intention de l'installateur du système CATV : Ce rappel est fourni afin d'attirer l'attention de l'installateur de système CATV sur l'article 820-40 du National Electrical Code qui indique les règles de mise à la terre appropriée et, en particulier, spécifie que la ligne de terre doit être connectée au réseau commun de mise à la terre du bâtiment, au point le plus proche possible de la source."

AVERTISSEMENT - Les réglementations FCC établissent que des changements ou des modifications non autorisés sur cet équipement et non approuvés expressément par le fabricant peuvent annuler tout pouvoir de l'utilisateur sur le fonctionnement de cet équipement.

MISE AU REBUT DU PRODUIT

Ce produit utilise un tube à rayons cathodiques (TRC) contenant du plomb à braser et du brasage tendre.

La mise au rebut de ces matières peut être réglementée pour des raisons environnementales. Pour toute information sur la mise au rebut ou le recyclage, contactez les autorités locales ou les précautions importantes préconisées par la société Electronics Industries Alliance sur : www.eiae.org.

INFORMATIONS IMPORTANTES (Suite)

ATTENTION:

- Ne placez pas le cordon d'alimentation sous le téléviseur ou sous tout autre objet lourd.
- Ne placez pas de bougies ni de flammes nues sur le téléviseur ou à sa proximité, afin d'éviter les incendies.
- Veillez à ne pas éclabousser ni faire tomber de l'eau sur ces appareils afin d'éviter les incendies ou les électrocutions. Ne placez jamais d'objets remplis de liquide, comme des vases, sur ces appareils.

PRÉCAUTIONS IMPORTANTES

ATTENTION : Veuillez lire toutes ces instructions avant d'utiliser votre télévision et conservez-les pour un usage ultérieur.

L'énergie électrique peut exécuter de nombreuses fonctions utiles. Cet appareil a été conçu et fabriqué de façon à garantir votre entière sécurité. CEPENDANT, TOUTE UTILISATION INADEQUATE PEUT ENTRAINER DES RISQUES D'ELECTROCUTION OU D'INCENDIE. Afin de ne pas détruire les protections intégrées à cet appareil, respectez les règles de base suivantes pour son installation, son utilisation et sa maintenance

1. Débranchez la télévision avant de la nettoyer.
2. N'utilisez pas de nettoyeurs liquides ou d'aérosols et utilisez un chiffon humide
3. N'utilisez pas d'accessoires déconseillés par le fabricant de matériel vidéo, car ils impliquent des risques.
4. N'utilisez pas cette télévision à proximité d'eau — par exemple, près d'une baignoire, d'un lavabo, d'un évier ou d'un bac à laver, dans une cave humide ou près d'une piscine, etc.
5. Ne placez pas cet équipement sur un chariot, un support ou une table instable. La télévision peut tomber et provoquer de graves lésions à toute personne et causer de sérieux dommages à l'équipement. Utilisez uniquement un support ou un chariot recommandé par le fabricant ou vendu avec la télévision.
6. L'ensemble télévision-chariot doit être déplacé délicatement. Les arrêts brusques, une force excessive et des surfaces inégales peuvent renverser l'ensemble.
7. L'installation au mur ou sur une tablette doit être réalisée conformément aux instructions du fabricant et à l'aide d'un kit de montage approuvé par ce dernier.
8. Les fentes et les ouvertures du châssis à l'arrière ou dans la partie inférieure sont prévus pour la ventilation. Pour garantir un fonctionnement fiable de la télévision et pour la protéger de toute surchauffe, ces ouvertures ne doivent être ni obturées, ni recouvertes. La télévision ne doit pas être placée dans un endroit encastré tel qu'une bibliothèque, sauf si une ventilation adéquate est prévue.
9. Les ouvertures ne doivent jamais être recouvertes par un chiffon ou autre et celles de la partie inférieure ne doivent jamais être obturées si vous placez la télévision sur un lit, un sofa, un tapis ou toute surface similaire. Cette télévision ne doit être placée ni à proximité d'un radiateur ou d'un registre de chaleur, ni dessus.
10. Cette télévision doit être alimentée uniquement par le type d'alimentation électrique indiqué sur l'étiquette. Si vous n'êtes pas sûr du type d'alimentation de votre domicile, consultez votre revendeur de télévision ou la compagnie d'électricité locale (EDF en France).
Pour la télévision conçue pour fonctionner sur batterie, reportez-vous au mode d'emploi.
11. Du point de vue de la sécurité, la télévision est équipée d'une fiche polarisée à 2 fils (une lame plus importante que l'autre). La fiche polarisée à 2 fils ne pénètre dans la prise électrique que dans un seul sens.
Si la fiche ne correspond pas à la prise, demandez à votre électricien de remplacer la prise, elle doit être obsolète. Ne modifiez pas la fiche et ne désactivez pas cette fonction de sécurité.
12. Ne posez rien sur le cordon d'alimentation. Ne placez pas la télévision dans un emplacement où le cordon d'alimentation est susceptible d'être endommagé par le passage répété de personnes.



Référence rapide sur les commandes

Fonctions de base de la télécommande

● Nomenclature

Panneau Avant

(FRANÇAIS)

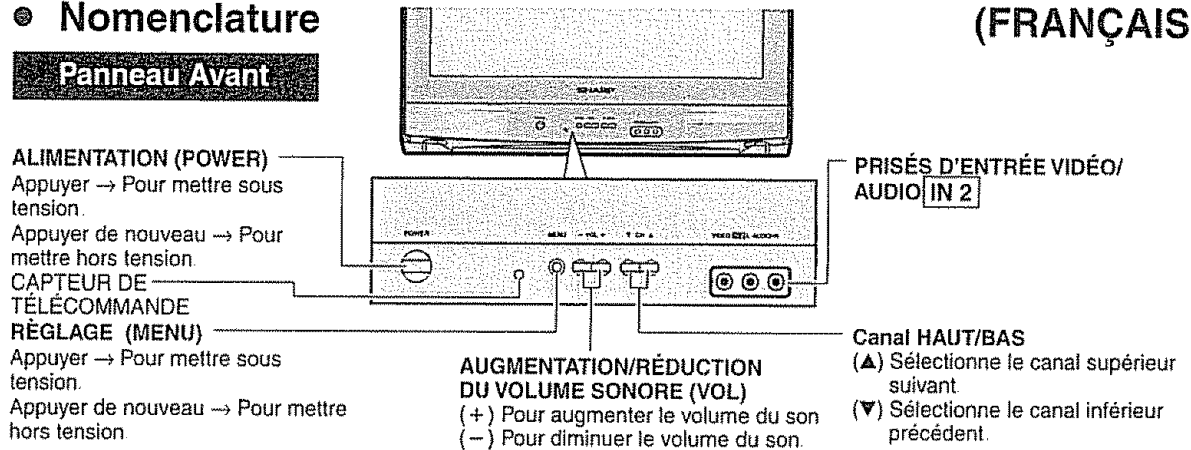

Fonctions de base de la télécommande

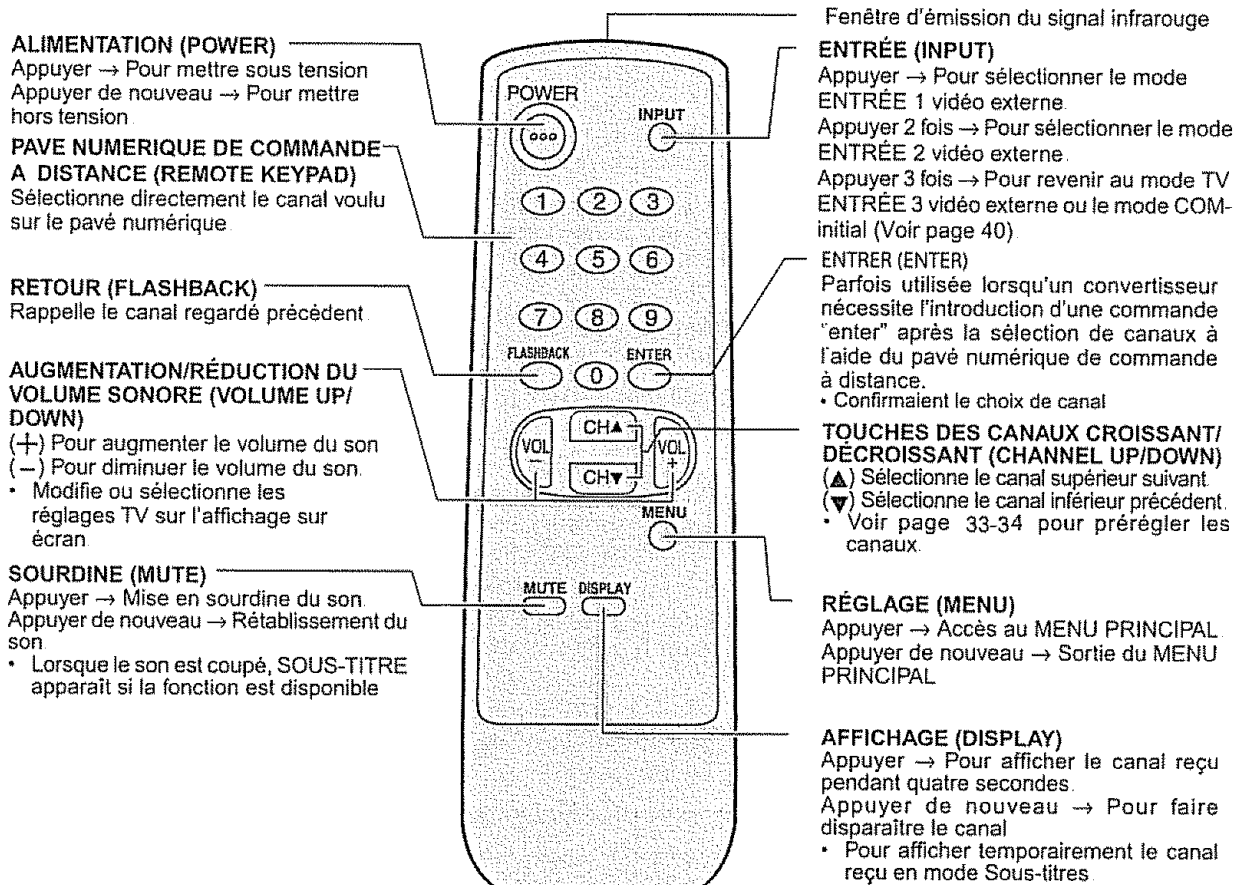

Avant d'appeler un réparateur

Vérifier les points suivants afin de déterminer s'il est possible de remédier au problème par un simple réglage des commandes

| LISTE DES VÉRIFICATIONS POUR UN DÉPANNAGE RAPIDE | PROBLÈME | Pas de reproduction d'un magnétoscope ou lecteur de disque | Pas d'image ou de son d'un appareil vidéo/audio externe | La télécommande ne fonctionne pas | Barres sur l'écran | Distorsion de l'image | Image défilé verticalement | Pas de couleur | Faible réception de certains canaux | Image affaiblie | Lignes ou rayures dans l'image | Images fantômes | Image trouillée | Son normal, image médiocre | Image normale, son médiocre | Ni son, ni image | Image sombre et vide | Bruit électrique extérieur interférant avec le fonctionnement du téléviseur | La couleur sur une partie de l'écran semble altérée |
|-----------------------------------------------------------------------------------------------------------------|-----------------|------------------------------------------------------------|---------------------------------------------------------|-----------------------------------|--------------------|-----------------------|----------------------------|----------------|-------------------------------------|-----------------|--------------------------------|-----------------|-----------------|----------------------------|-----------------------------|------------------|----------------------|-----------------------------------------------------------------------------|-----------------------------------------------------|
| SOLUTION POSSIBLE | | | | | | | | | | | | | | | | | | | |
| Essayer un nouveau canal. S'il fonctionne, il s'agit probablement d'une panne de la chaîne | | | | | | X | X | X | X | X | X | X | X | X | X | X | | | |
| Le téléviseur est-il branché? La prise secteur fonctionne-t-elle? | | X | X | | | | | | | | | | | | | X | | | |
| L'interrupteur POWER du téléviseur est-il sous tension? | | X | | | | | | | | | | | | | | X | | | |
| L'antenne est-elle raccordée aux bornes à l'arrière de l'appareil? | | | | | | | X | X | X | X | X | X | X | X | X | | | | |
| Si l'antenne extérieure est utilisée, s'assurer qu'il n'y a pas de fils sectionnés | | | | X | X | X | X | X | X | X | X | X | X | X | X | | | | |
| Vérifier s'il n'y a pas d'interférence locale ou de bruit électrique extérieur | | | | X | X | X | | X | X | X | X | X | X | X | | | | X | |
| Mettre l'interrupteur POWER hors tension puis de nouveau sous tension au bout d'une minute | | X | | | | | | | | | | | | | | X | | | |
| Régler la commande de COULEUR | | | | | | | X | | | | | | | | | | | | |
| Régler la commande de CONTRASTE | | | | | | | | | | X | | | | X | | | | | |
| Vérifier l'appareil vidéo/audio externe : s'assurer que les câbles de connexion ne sont pas desserrés ou cassés | | X | X | | | | | | | | | | | X | X | X | | | |
| Vérifier les piles de la télécommande | | | X | | | | | | | | | | | | | | | | |
| Faites glisser le sélecteur de mode CATV/DVD-TV/VCR sur la position TV | | | X | | | | | | | | | | | | | | | | |
| Les câbles audio sont-ils fermement connectés? Vérifier le niveau du volume | | | | | | | | | | | | | | | X | X | | | |
| Les haut-parleurs fonctionnent-ils? | | | | | | | | | | | | | | | | X | | | |
| Mettre le mode sous-titrage hors service "ARRÊT" Mode d'économie d'énergie sur "ARRÊT". | | | | | | | | | | | | | | | | | X | | |
| Débrancher le téléviseur et le rebrancher après deux minutes | | | X | | | X | X | X | X | X | | | | X | X | X | X | X | X |

Remarque:

- En mode TEXTE, s'il n'y a pas d'émission TEXTE à recevoir, l'écran du téléviseur pourrait être sombre et vide. Dans ce cas, placer le mode Sous-titrage hors service.



(Image sombre et vide)

Appel au service après-vente

Pour connaître l'emplacement du centre de service après-vente agréé Sharp le plus proche ou pour obtenir de la documentation sur les produits, des accessoires, des consommables ou une aide au consommateur, appelez le 1-800-BE-SHARP.

Limited Warranty

CONSUMER LIMITED WARRANTY

SHARP ELECTRONICS CORPORATION warrants to the first consumer purchaser that this Sharp brand product (the "Product"), when shipped in its original container, will be free from defective workmanship and materials, and agrees that it will, at its option, either repair the defect or replace the defective Product or part thereof with a new or remanufactured equivalent at no charge to the purchaser for parts or labor for the period(s) set forth below.

This warranty does not apply to any appearance items of the Product nor to the additional excluded item(s) set forth below nor to any Product the exterior of which has been damaged or defaced, which has been subjected to improper voltage or other misuse, abnormal service or handling, or which has been altered or modified in design or construction.

In order to enforce the rights under this limited warranty, the purchaser should follow the steps set forth below and provide proof of purchase to the servicer.

The limited warranty described herein is in addition to whatever implied warranties may be granted to purchasers by law. ALL IMPLIED WARRANTIES INCLUDING THE WARRANTIES OF MERCHANTABILITY AND FITNESS FOR USE ARE LIMITED TO THE PERIOD(S) FROM THE DATE OF PURCHASE SET FORTH BELOW. Some states do not allow limitations on how long an implied warranty lasts, so the above limitation may not apply to you.

Neither the sales personnel of the seller nor any other person is authorized to make any warranties other than those described herein, or to extend the duration of any warranties beyond the time period described herein on behalf of Sharp.

The warranties described herein shall be the sole and exclusive warranties granted by Sharp and shall be the sole and exclusive remedy available to the purchaser. Correction of defects, in the manner and for the period of time described herein, shall constitute complete fulfillment of all liabilities and responsibilities of Sharp to the purchaser with respect to the Product, and shall constitute full satisfaction of all claims, whether based on contract, negligence, strict liability or otherwise. In no event shall Sharp be liable or in any way responsible, for any damages or defects in the Product which were caused by repairs or attempted repairs performed by anyone other than an authorized servicer. Nor shall Sharp be liable or in any way responsible for any incidental or consequential economic or property damage. Some states do not allow the exclusion of incidental or consequential damages, so that above exclusion may not apply to you.

THIS WARRANTY GIVES YOU SPECIFIC LEGAL RIGHTS. YOU MAY ALSO HAVE OTHER RIGHTS WHICH VARY FROM STATE TO STATE.

Model Specific Section

Your Product Model Number & Description:

32SC26B, 32 inch Color Television
(Be sure to have this information available when you need service for your Product.)

Warranty Period for this Product:

One (1) year parts and labor. The warranty period continues for an additional one (1) year, for a total of two (2) years, with respect to the picture tube(s) in the Product for parts only. Labor and service are not provided free of charge for this additional period.

Additional Item(s) Excluded from Warranty Coverage (if any):

Non-rechargeable batteries.

Where to Obtain Service:

From a Sharp Authorized Servicer located in the United States. To find the location of the nearest Sharp Authorized Servicer, call Sharp toll free at 1-800-BE-SHARP.

What to Do to Obtain Service:

Contact your Sharp Authorized Servicer to obtain in-home service for this Product. The Servicer will come to your home and if it is necessary to remove the Product, the Servicer will reinstall it. Be sure to have **Proof of Purchase** available.

SHARP[®]
SHARP ELECTRONICS CORPORATION
Sharp Plaza, Mahwah, New Jersey 07430-2135